

TOSHIBA

Leading Innovation >>>

USER MANUAL

L73 Digital Series**

M83 Digital Series**

Contents

INSTALLING YOUR TV

Safety Precautions	4
Installation and important information	5
The remote control	7
Inserting batteries and effective range	7

CONNECTING YOUR TV

Connecting external equipment	8
Connecting an HDMI® device	9
To connect an HDMI device	9
HDMI's ARC (Audio Return Channel) feature	9
Connecting an HDMI CEC Control compatible device	10
Connecting a computer	11
To connect a PC to the HDMI terminal	11
To connect a PC to the RGB/PC terminal	11
Connecting a home network	12
To connect the TV to a home network - Wired	12
To connect the TV to a home network with an internet connection - Wireless	12
To connect the TV to the PC with Intel® Wireless Display	12
Controls and input connections	13
Switching on	13
Using the TV controls and connections	13
Using the menu system	14

SETTING UP YOUR TV

Startup Application	15
Quick Setup	15
Ant/Cable/Satellite (if available)	20
Satellite Settings	21
Auto Tuning	22
ATV Manual Tuning	23
Tuning	23
Skip	24
Sorting positions	25
DTV Manual Tuning	25
Manual Tuning	25
Manual Tuning for DVB-C	26
Manual Tuning for DVB-S	26
DTV Settings	26
Channels (Antenna/Cable)	26
Channels (Satellite)	27
Standby Channel Update	27
Location setting	27
Analogue switch-off	27

CONTROLS AND FEATURES

General controls	28
Quick Menu	28
Selecting channels	28
The Time Display – analogue only	28
Stereo and Bilingual transmissions	29
Using 3D functions	29
Viewing 3D images	29

Switching display mode or selecting 3D format ..	30
Setting the auto start mode	31
Adjusting 2D to 3D Depth	32
Setting the 3D PIN code	32
Setting 3D Start Message	32
Setting 3D Lock	33
Setting 3D Timer Lock	33
Setting Enable 3D Timer	33
Displaying 3D Important Info	33
Switching left and right images	33
Sound controls	34
Volume controls and sound mute	34
Dual	34
Balance	34
Bass, Treble	34
TV Mounting (Wall/Table)	34
Dynamic Volume®	34
Audysey ABX™	34
Dynamic Range Control	34
Audio Level Offset	35
TV Speakers On/Off	35
Headphone Settings	35
Audio Description	35
Widescreen viewing	36
Picture controls	38
Picture Mode	38
Picture preferences	38
Reset	38
ColourMaster	38
Base Colour Adjustment	39
Colour Temperature	39
Auto Brightness Sensor	39
Active Backlight Control	39
Black/White Level	39
MPEG NR – Noise Reduction	40
DNR – Digital Noise Reduction	40
Resolution +	40
ClearScan	40
Resetting the advanced picture settings	40
Expert Picture Settings	40
Automatic Format (Widescreen)	42
4:3 Stretch	42
Picture Position	42
Picture still	42
HDMI Information Display	42
Wireless LAN Information	43
Setting up the Network	44
Wireless Setup	44
Advanced Network Setup	47
DNS Setup	48
Network Connection Test	48
Using the software keyboard	49
Network Device Setup	49
Apps Control Profile	49
TV Power On Control (Active Standby)	50
Media Renderer Setup	50
Device Name Setup	50
USB HDD Record Function	51

Setting up the USB HDD for recording.....	51	Subtitles	79
To record DTV programmes (One Touch Recording).....	51	Audio languages	79
How to set recordings via the Programme Guide.....	52	Common Interface	80
To check, edit or delete scheduling information..	54	Software Upgrade and Licences	80
To view a recorded programme	54	Searching for New Software	80
Operations from the Library screen.....	55	Network Upgrade.....	80
Recording Setup	56	Software Licences.....	81
Scheduling priority.....	57	System Information and Reset TV	81
Using the Cloud TV Service	57	System Information.....	81
Using Web Browser	57	Reset TV	81
Using Skype	59	PC Settings	82
Using Hybrid TV Standard (if available)	64	Horizontal and Vertical Position	82
Using Intel® Wireless Display.....	64	Clock Phase	82
Intel® WiDi Device Name	65	Sampling Clock.....	82
Device List.....	65	Reset.....	82
Using the Media Player	65	Input selection and AV connections	83
Basic operation	66	Input selection	83
Viewing photo files (on a media server or USB device).....	67	Labelling video input sources.....	83
Viewing movie files (on a media server or USB device).....	69	Digital Audio Output	84
Playing music files (on a media server or USB device).....	72	Using HDMI CEC Control.....	85
Other features	73	Enable HDMI CEC Control	85
Panel Lock	73	TV Auto Power.....	85
Blue Screen.....	73	Auto Standby	85
Netflix®	73	Amplifier Control	85
The timers	74	Initial Speaker Setting	85
Programme Timers – digital only.....	74	HDMI CEC Control input source selection.....	85
On Timer	74	HDMI CEC Control one touch play	86
Sleep Timer.....	74	HDMI CEC Control system standby.....	86
Energy Saving Settings	75	Using MHL TV function	86
Automatic Power Down.....	75	Connecting an MHL-compatible device	86
No Signal Power Down	75	Operating an MHL-compatible device.....	86
Digital on-screen information.....	75	MHL Setup	86
Information	75		
Using EPG (Electronic Programme Guide)	76	TEXT SERVICES	
Using Broadcast Guide	76	Text services	87
Genre selection/searching	77	Selecting modes	87
Digital settings – parental control	77	Text information	87
Parental PIN Setup	77	Navigating pages using Auto	87
Parental Setup	78	Navigating pages using LIST	87
Digital settings – Channel Options	78	Control buttons.....	88
Selecting favourite channels	78		
Favourite Channel List	78	PROBLEM SOLVING	
Skip channels.....	79	Questions and Answers	89
Locking channels	79		
Digital settings – other settings	79	INFORMATION	
		Information	92
		Licence information	98
		Cautions and other information for 3D	100
		Specifications and accessories	102

During the life of your TV firmware updates will be made available to ensure that your TV maintains optimum performance:

If your TV is connected to the internet, firmware will be automatically made available.
If your TV is not connected to the internet, you can download the latest version of firmware from
www.toshiba-om.net/firmware.php

*Some features are limited due to local legislation and may not be available in all countries.

Safety Precautions

This equipment has been designed and manufactured to meet international safety standards but, like any electrical equipment, care must be taken to obtain the best results and for safety to be assured. Please read the points below for your own safety. They are of a general nature, intended to help with all electronic consumer products, and some points may not apply to the goods you have just purchased.

Air Circulation

Leave more than 10 cm clearance around the television to allow adequate ventilation. This will prevent overheating and possible damage to the television. Dusty places should also be avoided. For wall mounted positions at least 2.5 cm gap was retained from the wall and the 10 cm was kept clear around all edges of the TV.

Heat Damage

Damage may occur if the television is left in direct sunlight or near a heater. Avoid places subject to extremely high temperatures or humidity. Place in a location where the temperature remains between 5 °C min. and 35 °C max.

Mains Supply

The mains supply required for this equipment is 220-240 V AC 50 Hz. Never connect to a DC supply or any other power source. DO ensure that the television is not standing on the mains lead.

DO NOT cut off the mains plug from this equipment, this incorporates a special Radio Interference Filter, the removal of which will impair its performance.

IF IN DOUBT, PLEASE CONSULT A COMPETENT ELECTRICIAN.

Do

DO read the operating instructions before you attempt to use the equipment.

DO ensure that all electrical connections (including the mains plug, extension leads and inter-connections between pieces of equipment) are properly made and in accordance with the manufacturers' instructions. Switch off and withdraw the mains plug before making or changing connections.

DO consult your dealer if you are ever in doubt about the installation, operation or safety of your equipment.

WARNING: To prevent injury, this apparatus must be securely attached to the floor/wall in accordance with the installation instructions. See page 5.

DO be careful with glass panels or stands on equipment.

DO use a soft, dry cloth to clean the unit.

DO NOT REMOVE ANY FIXED COVERS AS THIS WILL EXPOSE DANGEROUS AND 'LIVE' PARTS.

THE MAINS PLUG IS USED AS THE DISCONNECTING DEVICE AND THEREFORE SHOULD BE READILY OPERABLE.

Do not

DO NOT obstruct the ventilation openings of the equipment with items such as newspapers, tablecloths, curtains, etc. Overheating will cause damage and shorten the life of the equipment.

DO NOT allow electrical equipment to be exposed to dripping or splashing or objects filled with liquids, such as vases, to be placed on the equipment.

DO NOT place hot objects or naked flame sources, such as lighted candles or nightlights on, or close to equipment. High temperatures can melt plastic and lead to fires.



WARNING: To prevent the spread of fire, keep candles or other open flames away from this product at all times.

DO NOT use makeshift stands and NEVER fix legs with wood screws.

DO NOT leave equipment switched on when it is unattended, unless it is specifically stated that it is designed for unattended operation or has a standby mode. Switch off by withdrawing the plug, and make sure your family knows how to do this. Special arrangements may need to be made for people with disabilities.

DO NOT continue to operate the equipment if you are in any doubt about it working normally, or it is damaged in any way – switch off, withdraw the mains plug and consult your dealer.

DO NOT push/pull CI CAM at a tilt to prevent breakdown of COMMON INTERFACE.

WARNING: Excessive sound pressure from earphones or headphones can cause hearing loss.

ABOVE ALL - NEVER let anyone, especially children, push or hit the screen and cabinet back, or push anything into holes, slots or any other openings in the case. These actions will damage screen or internal parts.

NEVER guess or take chances with electrical equipment of any kind - it is better to be safe than sorry.

Installation and important information

Where to install

Locate the television away from direct sunlight and strong lights. Soft, indirect lighting is recommended for comfortable viewing. Use curtains or blinds to prevent direct sunlight falling on the screen.

Place the TV on a stable, level surface that can support the weight of the TV. In order to prevent injury and maintain stability of this apparatus, secure the TV using the fixing in the stand.

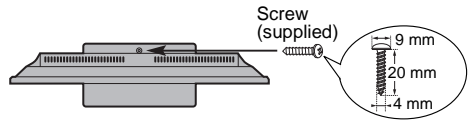

Stand style is dependent on model

The LCD display panels are manufactured using an extremely high level of precision technology; however, sometimes some parts of the screen may be missing picture elements or have luminous spots. This is not a sign of a malfunction.

Make sure the television is located in a position where it cannot be pushed or hit by objects, as pressure will break or damage the screen. Also, please be certain that small items cannot be inserted into slots or openings in the case.



Avoid using chemicals (such as air refreshers, cleaning agents, etc.) on or near the TV pedestal. Studies indicate that plastics may weaken and crack over time from the combination effects of chemical agents and mechanical stress (such as weight of TV). Failure to follow these instructions could result in serious injury and/or permanent damage to TV and TV pedestal.

When using a Wall Bracket

Use a wall bracket appropriate for the size and weight of the LCD TV.

- Two people are required for installation.
 - Install a wall-mount from another manufacturer.
- 1 Unplug and remove any cables and/or other component connectors from the rear of the TV.
 - 2 Carefully lay the front of the unit face down on a flat, cushioned surface such as a quilt or blanket.
 - 3 Follow the instructions provided with your wall bracket. Before proceeding, make sure the appropriate bracket(s) are attached to the wall and the back of the TV as described in the instructions provided with the wall bracket.
 - 4 Always use the screws supplied or recommended by the wall mount manufacturer.

Removing the Pedestal Stand:

- 1 Carefully lay the front of the unit face down on a flat, cushioned surface such as a quilt or blanket. Leave the stand protruding over the edge of the surface.

NOTE: Extreme care should always be used when removing the pedestal stand to avoid damage to the LCD panel.

- 2 Remove the cover and screws.

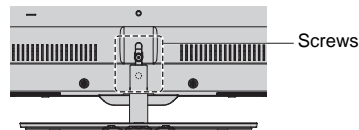

- 3 Once you have removed all screws holding the pedestal stand in place, remove the pedestal stand from the TV by sliding the pedestal stand away from the TV.

When using MHL (Mobile High-definition Link)

- Interoperability with MHL devices of other manufacturers is not guaranteed.
- Toshiba does not provide any guarantee, therefore, against operational failure such as that described below when an MHL source is connected to the TV.
 - No picture or sound
 - Some of the functions do not work by remote operation from the TV
- If the MHL does not work properly, also contact the manufacturer of the source device for advice on its use.

Please take note

The digital reception function of this television is only effective in the countries listed in the “Country” section of the “Installation” menu. Depending on country/area, some of this television’s functions may not be available. Reception of future additional or modified services can not be guaranteed with this television.

If stationary images generated by 4:3 broadcasts, text services, channel identification logos, computer displays, video games, on-screen menus, etc. are left on the television screen for any length of time, they could become conspicuous. It is always advisable to reduce both the brightness and contrast settings.

Very long, continuous use of the 4:3 picture on a 16:9 screen may result in some retention of the image at the 4:3 outlines. This is not a defect of the LCD TV and is not covered under the manufacturer’s warranty. Regular use of other size modes (e.g. Super Live) will prevent permanent retention.

EXCLUSION CLAUSE

Toshiba shall under no circumstances be liable for loss and/or damage to the product caused by:

- i) Fire;
- ii) Earthquake;
- iii) Accidental damage;
- iv) Intentional misuse of the product;
- v) Use of the product in improper conditions;
- vi) Loss and/or damage caused to the product whilst in the possession of a third party;
- vii) Any damage or loss caused as a result of the owner’s failure and/or neglect to follow the instructions set out in the owner’s manual;
- viii) Any loss or damage caused directly as a result of misuse or malfunction of the product when used simultaneously with associated equipment;

Furthermore, under no circumstances shall Toshiba be liable for any consequential loss and/or damage including but not limited to the following: loss of profit, interruption of business, the loss of recorded data whether caused during normal operation or misuse of the product.

When Using a USB Hard Drive (HDD)

- **The recording function has been designed for private use and entertainment in your home environment. Please note that any commercial use of the recording function could lead to copyright infringement of authors’ rights. Toshiba asks you to respect the intellectual property rights of third parties.**
- **Before recording to a device connected to the TV, make a test recording and check the recording performance.**
- **Programmes that are prohibited from copying due to copyright protection cannot be recorded.**
- **Toshiba shall not be liable for compensation or incidental damages of any kind whatsoever resulting from content that was not properly recorded on the recording device or that was modified or lost.**
- **Toshiba shall not be liable for damages of any kind whatsoever (breakdown of the recording device, modification or loss of the recorded content, etc.) resulting from malfunction, operating failure or incorrect operation due to combining with another connected device.**
- **If you connect a USB HDD that has been used with a PC or another TV, only programmes which are recorded using this TV can be playback.**
- **Switch the TV to standby before you disconnect the USB HDD.**
Not doing so may result in loss of the recorded data or malfunction of the USB HDD.
- **Please note that recording on the USB HDD is no longer playable after the TV’s main-board is exchanged during service.**

The remote control

Simple at-a-glance reference of your remote control.

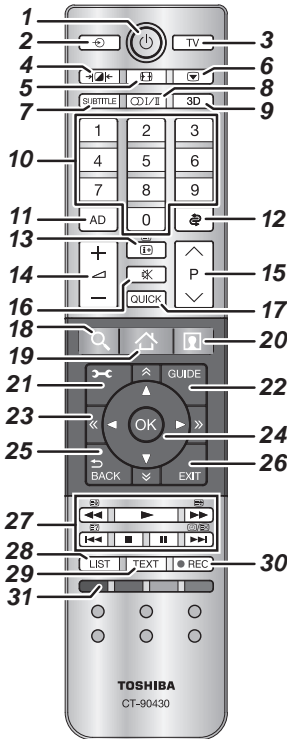

- 1 For On/Standby mode
- 2 To select external input sources
- 3 To select TV Mode
- 4 Selectable Picture
- 5 Widescreen viewing
- 6 Picture still
- 7 Digital Subtitles or Analogue TEXT Subtitle pages if available
- 8 Stereo/bilingual transmissions
- 9 To switch between 2D / 3D modes
- 10 Number buttons
- 11 Switch the Audio Description On/Off
- 12 To return to previous channel
- 13 To display on-screen information
To access the index page in Text mode
- 14 To alter the TV volume
- 15 To change programme positions
To change TEXT pages
- 16 To mute the TV sound
- 17 To access Quick Menu
- 18 - Accesses the Search Portal

- 19 - Accesses the CLOUD HOME
- 20 - Accesses to premium content available online
- 21 To access the on-screen Menu
- 22 To display the digital on-screen Programme Guide
- 23 To page up, down, left or right
- 24 When using menus, the arrows move the cursor on the screen up, down, left or right. Press **OK** to confirm your selection
- 25 To return to previous Menu
- 26 To exit menus and applications
- 27 **When in TV mode:**
 - Analogue time display
- When in Text mode:**
 - To reveal concealed text
 - To hold a wanted page
 - To enlarge text display size
 - To erase Text pages temporarily when you are viewing in teletext mode.
- During Playback:**
 - To PLAY
 - To STOP
 - To PAUSE
 - To SKIP-BACK
 - To REWIND
 - To FAST FORWARD
 - To SKIP FORWARD
- 28 To access the analogue or digital Channel List
- 29 To call up text services
- 30 To record DTV programmes
- 31 Colour buttons: Text and interactive service control buttons

Inserting batteries and effective range

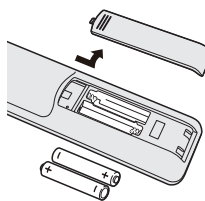

Remove the back cover to reveal the battery compartment and make sure the batteries are inserted the proper way. Suitable battery types for this remote control are AAA, IEC R03 1.5 V.

Do not combine a used, old battery with a new one or mix battery types. Remove

exhausted batteries immediately to prevent acid from leaking into the battery compartment. Dispose of them in accordance with instructions on page 99 of this manual.

Warning: Batteries must not be exposed to excessive heat such as sunshine, fire or the like.

The performance of the remote control will deteriorate beyond a distance of five metres or outside an angle of 30 degrees from the centre of the television. If the operating range becomes reduced, the batteries may need replacing.

Connecting external equipment

Before connecting any external equipment, turn off all main power switches. If there is no switch, remove the mains plug from the wall socket.

ILLUSTRATION SHOWS 40L.

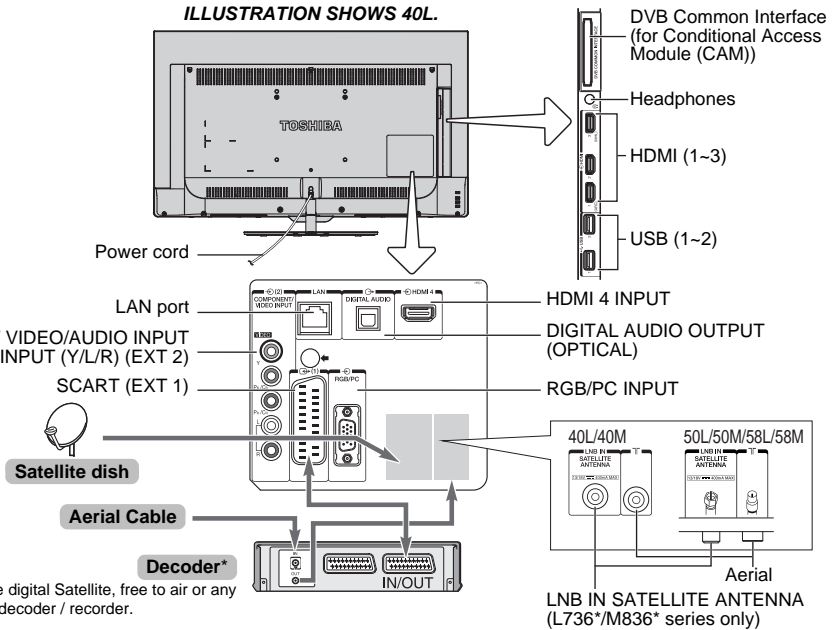

* A Decoder can be digital Satellite, free to air or any other compatible decoder / recorder.

Aerial cables:

Connect the aerial to the socket on the rear of the TV. If you use a decoder and/or a media recorder, it is essential that the aerial cable is connected through the decoder and/or through the media recorder to the TV.

Satellite cable:

Connect the LNB from the satellite dish to the **SATELLITE ANTENNA** socket on the TV. You can receive TV, radio, interactive TV, and HD TV with clear reception.

SCART leads:

Connect the media recorder **IN/OUT** socket to the television.

Connect the decoder **TV** socket to the television.

Before running **Auto Tuning**, put your decoder and media recorder to **Standby**.

The RCA sockets alongside the **COMPONENT VIDEO INPUT** sockets will accept L and R audio signals.

When connecting the VIDEO/AUDIO devices, connect those cables to **Y/L/R** sockets.

The Digital Audio Output socket enables the connection of a suitable surround sound system.

NOTE: This output is always active.

HDMI® (High-Definition Multimedia Interface) is for use with electrical equipment with digital audio and video output. It is designed for best performance with 1080i and 1080p high-definition video signals but will also accept and display VGA, 480i, 480p, 576i, 576p and 720p signals.

PC format signals will also be displayed.

NOTE: Although this television is able to connect to HDMI equipment, it is possible that some equipment may not operate correctly.

LAN port is used to connect the TV to your home network. **A wide variety of external equipment can be connected to the back of the television; therefore, the relevant owner's manuals for all additional equipment must be referred to for exact instructions.**

If the television automatically switches over to monitor external equipment, return to normal television by pressing the desired programme position button. To recall external equipment, press **TV**, **EXT 1**, **EXT 2**, **HDMI 1**, **HDMI 2**, **HDMI 3**, **HDMI 4** or **PC**.

When the external input mode is selected while viewing DTV mode, the SCART socket does not output video/ audio signals.

Connecting an HDMI® device

The HDMI input on your television receives digital audio and uncompressed digital video from an HDMI source device.

This input is designed to accept HDCP (High-Bandwidth Digital Content Protection) programme material in digital form from EIA/CEA-861-D-compliant consumer electronic devices (such as a set-top box or DVD player with HDMI output). For acceptable video signal formats, see page 93.

NOTE: Supported Audio format: Linear PCM, Dolby Digital (AC-3), sampling rate 32/44.1/48 kHz.

To connect an HDMI device

Connect an HDMI cable (type A connector) to the HDMI terminal.

For proper operation, it is recommended that you use an HDMI cable with the HDMI Logo (HDMI®).

- If your HDMI connection is capable of 1080p and/or your television is capable of refresh rates greater than 50 Hz, you will need a Category 2 cable. Conventional HDMI/DVI cable may not work properly with this model.
- HDMI cable transfers both video and audio. Separate analogue audio cables are not required (see illustration).

the back and side of your television

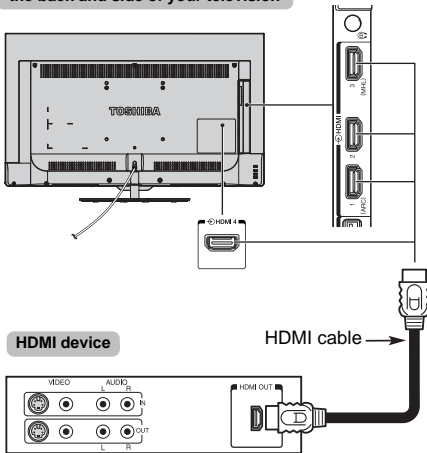

To view the HDMI device video, press  to select HDMI 1, HDMI 2, HDMI 3 or HDMI 4 mode.

HDMI's ARC (Audio Return Channel) feature

This feature enables the audio signal of the TV to be sent to the AV amplifier via the HDMI cable. It will not be necessary to connect a cable from the audio output of the TV to the audio input of the AV amplifier to reproduce the audio received from the tuner of the TV through the AV amplifier.

the side of your television

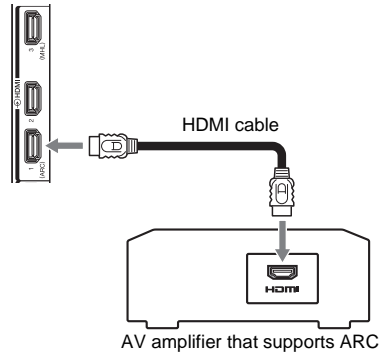

Connecting an HDMI CEC Control compatible device

You can control the basic functions of connected audio/video devices using the television's remote control if you connect an HDMI CEC compatible AV amplifier or playback device. For an explanation of setup and operations, see pages 85–86.

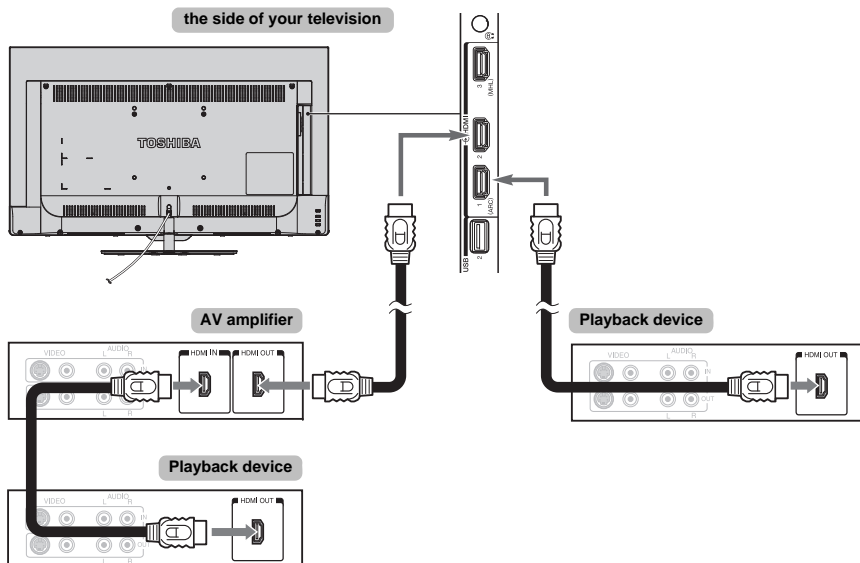

For the setup shown above, you will need three HDMI cables.

NOTE:

- If several devices are connected, the HDMI CEC Control feature may not operate properly.
- For proper operation, it is recommended that you use HDMI cables with the HDMI Logo (**HDMI**).
- This function is available when one PC and one AV amplifier are connected separately. However, it may not operate properly if the PC is connected via the AV amplifier.

Before controlling the device(s):

- After completing the above connections, set the HDMI CEC Control Setup menu as you desire (see page 85).
- The connected devices must also be set. For details, see the operation manual for each device.
- The HDMI CEC Control feature uses CEC technology as regulated by the HDMI standard.
- This feature is limited to models incorporating Toshiba's HDMI CEC Control. However, Toshiba is not liable for those operations. Refer to individual instruction manuals for compatibility information.

Connecting a computer

With either an HDMI or an RGB/PC connection, you can watch your computer's display on the television.

To connect a PC to the HDMI terminal

When connecting a PC to the HDMI terminal on the television, use an HDMI cable (type A connector).

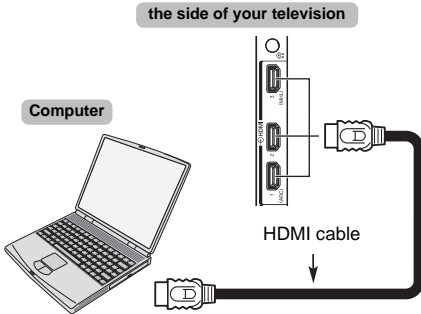

If connecting a PC with DVI terminal, use an HDMI-to-DVI adaptor cable.

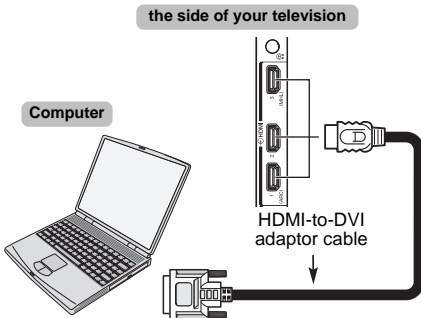

For acceptable PC and video signal formats, see page 93.

NOTE:

- The edges of the images may be hidden.
- If connecting a certain PC model with a unique PC signal, the PC signal may not be detected correctly.

To connect a PC to the RGB/PC terminal

When connecting a PC to the RGB/PC terminal on the television, use an analogue RGB (15-pin) computer cable.

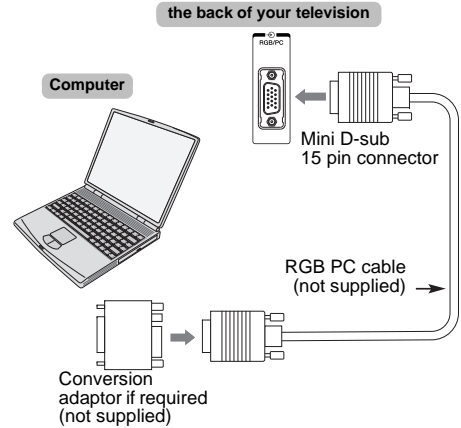

To use a PC, set the monitor output resolution on the PC before connecting it to the television. For acceptable PC signal formats, see page 92.

To display the optimum picture, use the PC setting feature (see page 82).

NOTE:

- Some PC models cannot be connected to this television.
- An adaptor is not needed for computers with a compatible mini D-sub15-pin terminal.
- Depending on the DVD's title and the specifications of the PC on which you are playing the DVD-Video, some scenes may be skipped or you may not be able to pause during multi-angle scenes.
- A band may appear at the edges of the screen or parts of the picture may be obscured. This is due to scaling of the picture by the set, it is not a malfunction.
- When PC input mode is selected, some of the television's features will be unavailable e.g. **Colour System** in the **Options** menu.
- Some PC models may output unique signals that the television may be unable to detect (see page 92).
- If connecting a certain PC model with a unique PC signal, the PC signal may not be detected correctly.

Connecting a home network

The LAN port allows your Toshiba TV to connect to your home network. You can use this revolutionary home entertainment networking system to access photo, video and audio files that are stored on a media server and play/display them on your TV.

NOTE:

- If you connect to a shared network outside your home, it is advisable to use a router. Always use network media products in private network environments. Connect this TV to the same router as other network media products (server).
- If you use a hub or switch to connect the TV to your home network, you may not be able to use the automatic setup and will have to manually set up the network address. See page 47.
- If you use a router with built-in DHCP functionality, use the automatic setup. Manual setup may not work.
- If you connect the TV and PC directly, use a crossover LAN cable.
- Please consult your PC manufacturer about details of PC settings.
- Wireless appliances may interfere with Intel® Wireless Display.

To connect the TV to a home network - Wired

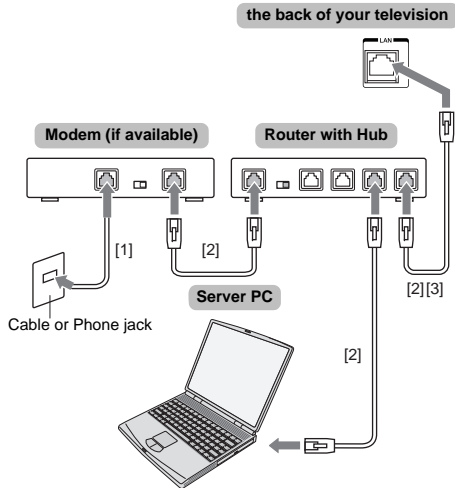

[1] Coaxial or telephone cable (depending on your modem type)

[2] Standard LAN cable

[3] Do not connect a phone jack directly to the TV's LAN port.

Warning: This TV complies with the EMC directive only when you use a shielded Cat5 ethernet cable.

To connect the TV to a home network with an internet connection - Wireless

Please refer to "Wireless Setup" section on page 44.

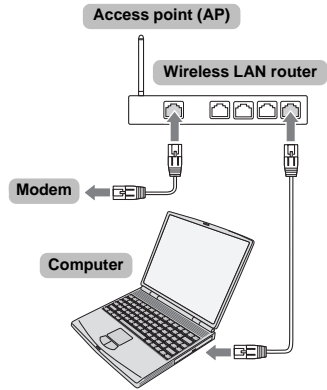

NOTE:

- If this device is going to be operated in the frequency range of 5.15 GHz to 5.35 GHz, it is restricted to indoor use.
 - If this device is going to be operated for 802.11 b/g/n function in the frequency range of 2.454 GHz to 2.4835 GHz in France, it is restricted to indoor use.
 - A general authorization is required for using this device outdoors or in public places in Italy.
 - This device is NOT ALLOWED to be used in the geographical area within a radius of 20 km from the centre of Ny-Alesund in Norway.
 - Make the wireless LAN appropriate security setting at the time of wireless LAN use to prevent the illegal use, spoofing and interception of communications.
 - Don't connect wireless LAN to an outside network directly.
- Apply the wireless LAN access point with router function or broadband router. Make the router appropriate security setting to prevent the illegal use. Refer to the manual of router for a security setting.

To connect the TV to the PC with Intel® Wireless Display

PC with Intel® Wireless Display

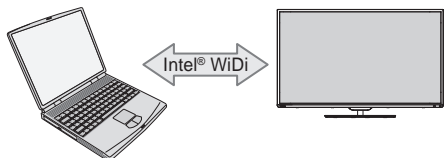

Controls and input connections

A wide variety of external equipment can be connected to the input sockets on the side of the television.

While all the necessary adjustments and controls for the television are made using the remote control, the buttons on the television may be used for some functions.

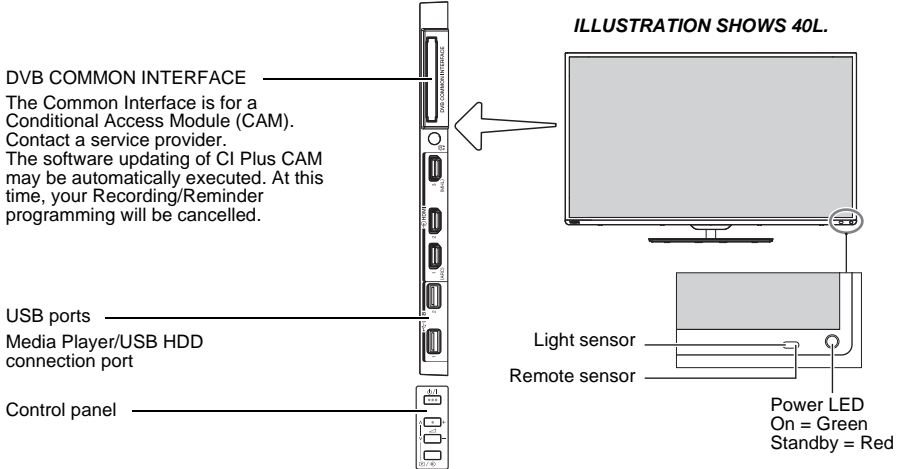

Switching on

If the RED LED is not lit, check that the mains plug is connected to the power supply and press on the remote control; it may take a few moments. The GREEN LED will be lit.

To put the television into Standby, press on the remote control. To view the television, press again. The picture may take a few seconds to appear.

For energy saving:

We recommend that you use the television with the factory settings. The factory settings are for energy saving.

Unplugging the mains plug will cut energy use to zero for all televisions. This is recommended when the television is not being used for a long time, e.g. when on holiday. Reducing the brightness of the screen will reduce energy use.

Energy efficiency cuts energy consumption and can save money.

NOTE: Putting the television into Standby will reduce energy consumption, but will still draw some power.

Using the TV controls and connections

- To turn on or off the TV, press .
- To alter the volume, press + or –. + and – buttons operate as volume up/down as default.
- Press repeatedly to switch the function of + / – button as below.

Channel → Input → Volume

The Media Player feature provides access to photo, movie and music files stored on a USB storage device that is connected via the USB 1 or USB 2 port or on a network device.



Please always refer to the owner's manual of the equipment to be connected for full details.

NOTE:









- The USB socket has limited functionality and Toshiba can take no responsibility for damage to other connected equipment.
- Interactive video games that involve shooting a "gun" at an on-screen target may not work with this TV.



































Using the menu system

Press  on the remote control to display the menu.

The menu appears as a list of eight topics. As each icon is selected by pressing  /  on the remote control, its respective options will appear on the right.

NOTE: The same menu is displayed in DTV (Digital TV) and ATV (Analogue TV) modes; however, where some items are not available in a mode, they will appear greyed out.

	Press  /  and OK or 
 Picture	Picture Mode
	Reset
	Backlight
	Contrast
	Brightness
	Colour
	Tint
	Sharpness
	Advanced Picture Settings
	Expert Picture Settings
Display Settings	
 Sound	Press  /  and OK or 
	Balance
	Bass
	Treble
	Audyssey Premium Television
	Dynamic Range Control
	Dual
	Audio Level Offset
	TV Speakers
	Headphone Level
	Audio Description
Digital Audio Output	

Press  / 	Press  /  and OK or 
 Options	Recording Setup
	Media Player Setup
	MHL Setup
	HDMI CEC Control Setup
	Hybrid TV Standard
	Teletext
	Panel Lock
	AV Connection
Power Management	
Blue Screen	
HDMI Information Display	
Press  / 	Press  /  and OK or 
 Installation	Menu Language
	Country
	Location
	Channel Tuning
	DTV Settings
	Quick Setup
	Reset TV
Press  / 	Press  /  and OK or 
 Network	Network Setup
	Network Device Setup
	Smart Apps Setup
Press  / 	Press  /  and OK or 
 3D	3D Auto Start
	2D to 3D Depth
	3D PIN
	3D Safety Settings
	3D Important Info
Press  / 	Press  /  and OK or 
 Timers	On Timer
	Sleep Timer
Press  / 	Press  /  and OK or 
 Get Help	Software Licences
	Software Upgrade
	System Information
	Store Demo

Startup Application

Before switching on the TV make sure that your aerial is connected and any decoder / media recorder, if applicable is connected and in **Standby**.

Quick Setup

- 1 Press the **⏻** button, Toshiba logo will appear. After that, The **Menu Language** screen will appear. This screen will appear the first time that the television is switched on and each time **Reset TV** is executed.
- 2 Press **▲▼◀▶** to select the menu language and press **OK**. The **Country/Language** screen will appear.



- 3 Press **▲ / ▼** to highlight **Country** and press **▶** and **▲ / ▼** to select your country.

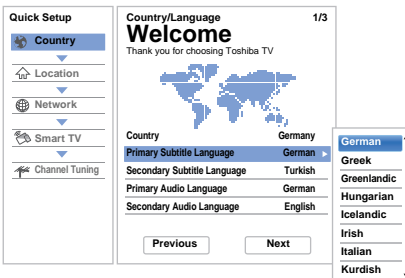

NOTE:

- The following display menus will differ slightly according to the country you selected.
- If there is not a country that you want to select in the list, select **Others**.

- 4 Press **▲▼◀▶** to highlight **Next** and press **OK**. The **Location** screen will appear.

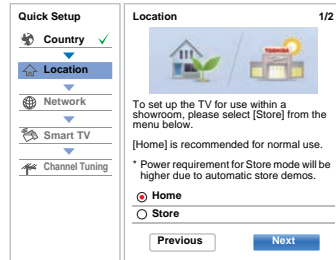

- 5 Press **▲ / ▼** to select **Home** or **Store** and press **OK**. For normal home use, select **Home**.

- 6 Press **▲▼◀▶** to highlight **Next** and press **OK**. The **Network Type** screen will appear.

- 7 Press **▲** to highlight **Network Type** and then press **▶** and **▲ / ▼** to select **Wireless**. Press **OK**.

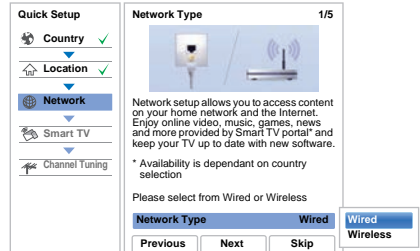

- When you select **Wired** (LAN cable connection), skip to step 14.

- 8 Press **▲▼◀▶** to highlight **Next** and press **OK**. The **Wireless Setup** screen will appear.

- 9 Press **▲** to highlight **Wireless Setup** and then press **▶** and **▲ / ▼** to select the Wireless Setup type. Press **OK**.

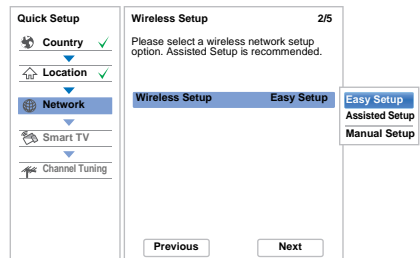

There are 3 methods for Wireless Setup:

- **Easy Setup (WPS)** - If the AP supports WPS, this method can be used. WPS is an industry standard designed to make connection of wireless LAN equipment and security setup easy. WPS will automatically configure all wireless settings.

NOTE: WEP encryption may not be able to be configured by easy setup.

- **Assisted Setup** - follow step 11. Input the Security Key only.
- **Manual Setup**, skip to step 12. Input the all settings.

NOTE: EXIT is available during settings.

10 In step 9, when you select **Easy Setup**;

Press **▲▼◀▶** to highlight **Next** and press **OK**. The **Easy Setup** screen will appear.

Press **▶** and **▲ / ▼** to select **PBC (Push Button Configuration)** or **PIN (Personal Identification Number)** and press **OK**.

Press **▼** to highlight **Start Scan** and press **OK**.

PBC - Following the on-screen instructions, push the appropriate button on your AP. When a window reporting that the setup is complete appears, press **OK**.

PIN - When the PIN code window appears, enter the displayed PIN into your AP, and then press **OK** to continue the PIN Setup. When a message displays to report that the setup is complete, press **OK**.

To cancel searching for the AP:

Press **BACK** while searching for the AP. A message will appear, and then press **◀ / ▶** to select **Yes** and press **OK**.

11 In step 9, when you select **Assisted Setup**;

Press **▲▼◀▶** to highlight **Next** and press **OK**. The **Assisted Setup** screen will appear.

Press **▲ / ▼** to select the desired AP and press **OK**.

NOTE: Check the MAC address on the label of the AP or in the manual, and select your AP.

Press **▲ / ▼** to select **Security Key** and press **OK**. The Software Keyboard window will appear (page 49).

Input the Security Key by using the Software Keyboard. To save your setting, press the **GREEN** button.

NOTE:

- The Security Key must adhere to these conditions:

- TKIP/AES: 8-63 ASCII or 64 Hex characters
- WEP: 5 or 13 ASCII or 10 or 26 Hex characters
- There is only one key ID to set for WEP encryption.

Press **▲ / ▼** to highlight **Done** and press **OK**.

NOTE:

- If Network Name is not displayed, see Manual Setup below to set Network Name before **Done** is selected.
- If **BACK** is pressed before **Done** is selected, settings are not saved.

When the message "Wireless configuration is complete." appears on screen, press **OK**.

The screen will skip to step 13.

12 In step 9, when you select **Manual Setup**;

Press **▲▼◀▶** to highlight **Next** and press **OK**.

The **Manual Setup** screen will appear. Press **▲ / ▼** to select **Network Name** and press **OK**.

The Software Keyboard window will appear (page 49).

Input the Network Name by using the Software Keyboard. To save your setting, press the **GREEN** button.

Press **▲ / ▼** to select **Authentication** and then press **▶** and **▲ / ▼** to select **Open System**, **Shared Key**, **WPA-PSK** or **WPA2-PSK**. Press **OK**.

Press **▲ / ▼** to select **Encryption**, and then press **▶** and **▲ / ▼** to select **None**, **WEP**, **TKIP** or **AES**. Press **OK**.

NOTE:

- Certain encryption types are only compatible with specific authentication types.
 - When Authentication is Open System, only **WEP** or **None** is compatible.
 - When Authentication is Shared Key, only **WEP** or **None** is compatible.
 - When Authentication is WPA-PSK or WPA2-PSK, only **TKIP** or **AES** is compatible.
- When incompatible Authentication/Encryption pairings are detected, a warning message will be displayed, and no connection attempt will be made until the incompatibility is resolved.
- There is only one key ID to set for WEP encryption.

Press **▲ / ▼** to select **Security Key** and press **OK**. Input the Security Key by using the Software Keyboard (page 49).

To save your setting, press the **GREEN** button. This item is greyed out when **Encryption** is **None**.

When **Encryption** is **WEP**, **Key ID** setting is available. Press ▲/▼ to select **Key ID** and press ► and ▲/▼ to select 1 (default), 2, 3 or 4.

Press ▲/▼ to highlight **Done** and press **OK**. When the message "Wireless configuration is complete." appears on screen, press **OK**.

NOTE: Settings are not saved if **BACK** is pressed before **Done** is selected.

- 13** The **Advanced Network Setup** screen will appear.

When the DHCP function of the router connected with this TV is On, you can set **Auto Setup** to On or **Off**. (This should usually be set to **On**.) When the DHCP function of the router is Off, set **Auto Setup** to **Off**, and set the IP Address DNS address(es) manually.

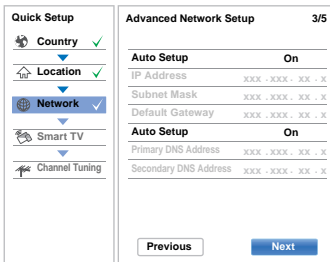

You can view the fixed MAC address for the TV, if one is installed.

Press ▲/▼ to highlight **Next**.

- 14** Press **OK**, and Network Connection Test will start.

A message will appear to indicate if the connection was successful or if could not be completed.

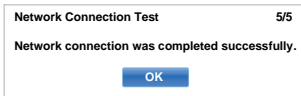

NOTE: The result of Network Connection Test does not always guarantee the connection.

To cancel the Network Connection Test:

Press **EXIT** while testing.

When the network can be accessed, **Software Upgrade** starts automatically. When **Software Upgrade** is completed, proceed to the next step.

- 15** Press **OK**, and **TV Power On Control** screen will appear. Select **Disabled** or **Enabled** and highlight **Next**.

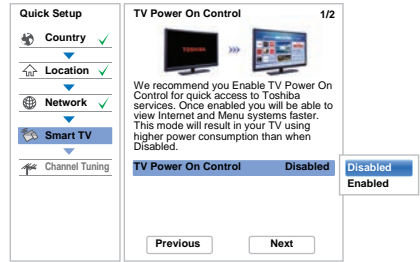

- 16** Press **OK**, and **Companion Device** screen will appear. Select **On** or **Off** from **Enable Control** and **Media Renderer** and highlight **Next**.

- 17** Press **OK**. If the **Ant/Cable/Satellite** screen appears, press ▲/▼ to select **Antenna**, **Cable** or **Satellite**, and then press **OK** to check (✓).

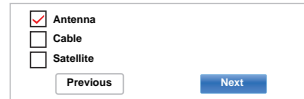

If DVB-C is not supported in your area, **Cable** will not be displayed.

- When you select **Antenna** or **Cable**, follow step 18 to 21.
- When you select **Satellite**, skip to step 22.
- When you select **Antenna** (or **Cable**) and **Satellite**, the Satellite Settings startup screen will appear automatically after completing the **Antenna** (or **Cable**) scan and pressing **OK**.

- 18** Press ▲▼◀▶ to highlight **Next** and press **OK**. The **Auto Tuning** start up screen will appear with the option to select between **DTV** and **ATV**, **DTV** or **ATV** if available. Press ► and ▲/▼ to select the appropriate mode and press **OK**.

19 Press **▼** to highlight **Start Scan**, and press **OK**.

The television will start to search for available **DTV** and/or **ATV** channels. The progress bar will indicate the scan status.

You must allow the television to complete the search.

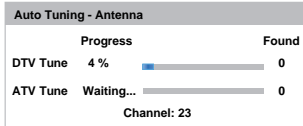

When the search is complete, the television will automatically select channel one.

The **Auto Tuning** screen will display the total number of services found.

20 Press **◀/▶** to view the **DTV** (digital channel) or **ATV** (analogue channel) lists.

21 Press **▲/▼** to move through the list to select a channel, and then press **OK** to view.

In **ATV** mode, some areas may receive duplicate stations. There may not be a clear picture or the signal may be weak, so the station order can be changed using **ATV Manual Tuning**.

REMEMBER: Press **TV** at any time to select between **ATV** and **DTV** modes.

NOTE: The time will be set automatically by transmission but can be advanced or decreased by using **Local Time Setting** in the **DTV Settings** screen.

22 Select **Next** and press **OK**. The **Satellite Settings** screen will appear. From this window, you can add the satellites that you wish to tune and configure detailed settings for each one individually.

Select **Switch Type** and choose the correct switch configuration for your satellite dish from the settings **None**, **ToneBurst**, **DiSEqC 2way**, **DiSEqC 4way** or **Single cable**.

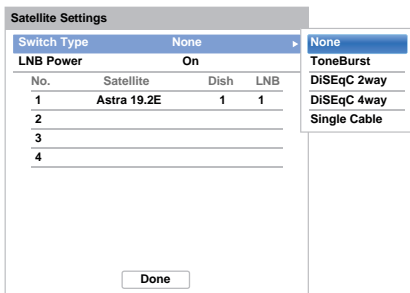

NOTE:

- **None** is being used when the satellite dish will control only one universal Low Noise Block (LNB) with a single satellite (e.g. Astra 19.2°). As a rule, most households use just one satellite.
- **ToneBurst** sends a 22 kHz signal. **ToneBurst** is only necessary for simple LNBs (not universal LNBs). The 22 kHz signal is needed for switching LNBs with multifeed signals as well as for changing between low- and high-band.
- **DiSEqC 2way** automatically switches between two LNBs, which receive different satellites at the same time (e.g. Astra 19.2° and Hotbird 13°).
- **DiSEqC 4way** automatically switches between up to four LNBs / satellites.
- **Single cable** is selection and control of plural Satellite antennas through the combined single antenna cable.

The setting **LNB Power** enables you to switch on or off the LNB's power supply by means of the TV. When your satellite dish consists of only one LNB, **LNB Power** should generally be activated (**On**). When using more than two LNBs, it is recommendable to use external power supply for these.

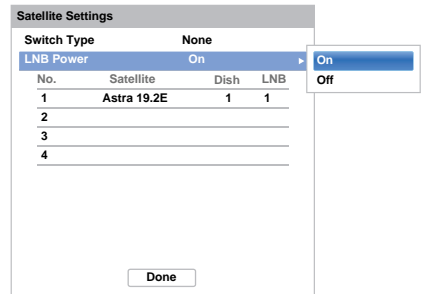

It is possible to select up to four satellites. Please note that the number of available LNBs and the adjustment of your satellite dish determines the number of satellites found. For example, it is not possible to receive more than one satellite if your dish is directed to a single satellite. For further information on satellite signal technology, please contact your local dealer.

Satellite Settings			
Switch Type	None		
LNB Power	On		
No.	Satellite	Dish	LNB
1	Astra 19.2E	1	1
2			
3			
4			

Transponder : 1/120 (10729) MHz
Dish Type : Fixed
Lower LOF : 9750
Upper LOF : 10600

Done

Once you have selected a satellite, you can change further settings under **Dish** and **LNB**. Press **OK** and **◀/▶** to select **Dish** or **LNB** and press **GREEN** button.

Under **Dish** you choose the dish type that will be used (fixed or moveable dish). The majority of households have a fixed satellite dish.

LNB allows you to determine the lower and higher Local Oscillator Frequency (LOF). Usually, the factory settings do not need to be changed. You can find the parameters of the lower and higher LOF on the specification sheet of your LNB.

Satellite Settings			
Switch Type	None		
LNB Power	On		
No.	Satellite	Dish	LNB
1	Astra 19.2E	1	1
2			
3			
4			

Transponder : 1/120 (10729) MHz
Dish Type : Fixed
Lower LOF : 9750
Upper LOF : 10600

Done

Press **▲/▼** to highlight **Done** and press **OK**.

23

If your satellite dish is moveable, the following **Positioning** screen will appear.

Positioning	
Transponder	1/120 (10729 MHz V (R)) ▶
Go to 0	
Go to Stored Position	
Step Size	1
Positioning	W E
Satellite : Astra 19.2E	
Signal Level	<div style="width: 30%;"></div> 30%
Store Position	

Press **▲/▼** to highlight **Positioning**, and then press **◀/▶** to find the dish position with the strongest signal level.

Press **▲/▼** to highlight **Store Position** and press **OK** to store the dish position. Repeat steps 22 and 23 for the next satellite as necessary.

Adjust the dish position manually for the maximum Signal Level strength. The signal level strength is displayed from 0 % to 100 %. A high signal level can be achieved by adjusting the satellite dish the best way possible.

Signal Level	<div style="width: 30%;"></div> 30%
--------------	-------------------------------------

Press **▲/▼** to highlight **Done** and press **OK**.

If you select **Single Cable** in step 22, the **Single Cable Settings** screen will appear. You can set the appropriate value for each item and highlight **Done**.

Single Cable Settings	
User Slot Number	0 ▶
User Slot Frequency	1284
Password PIN	None
Verify Slot Frequency	
Done	

- 24** If the reception testing completes successfully, the **Auto Tuning** startup screen will display.

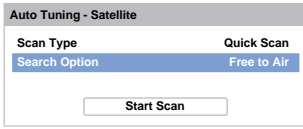

You can select **Search Option** from **Free to Air** or **All**.

When choosing the search option **All**, all channels (including encrypted ones) of the satellite will be searched for. If you wish to only search for unencrypted (free) channels, please select **Free to Air**. In this case, the channel scan will be completed faster.

- 25** Press **▼** to highlight **Start Scan**, and press **OK**.

The television will start to search for available **DVB-S** channels. The progress bar will indicate the scan status.

When the search is complete, the **Auto Tuning** results screen will display the total number of services found.

- 26** Use **▲ / ▼** to move through the list to select a channel, and then press **OK** to view.

PLEASE NOTE

The **Quick Setup** menu can also be accessed at any time from the **Installation** menu.

Ant/Cable/Satellite (if available)

From this menu, you can set the RF input configuration.

- 1** Press **⏻** and **▲ / ▼** to highlight **Installation** icon.
- 2** Press **▶** and **▲ / ▼** to select **Channel Tuning** and press **OK**.
- 3** Press **▲ / ▼** to select **Ant/Cable/Satellite** and press **OK**.
- 4** Press **▲ / ▼** to select **Antenna**, **Cable** or **Satellite**.
- 5** Press **▲ / ▼** to highlight **Next** and press **OK**.

NOTE: When you attempt to change the **Ant/Cable/Satellite** setting, a warning message will appear followed by PIN entry (if PIN has been set) and a prompt for **Auto Tuning**.

- 6** When **Ant/Cable/Satellite** is set to **Cable**, the following setting options will be provided in the **Auto Tuning** screen.

Press **▲ / ▼** to select an item and press **▶** and **▲ / ▼** to select your desired option.

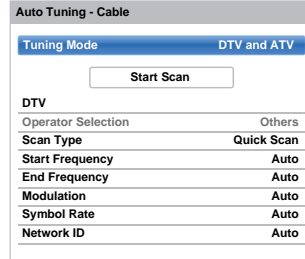

With the exception of **DTV Scan Type** and **DTV Modulation** items, all of the following items will have 2 operating modes. The first is **Auto** where the values for each item are preset by the system. The second is an **Input** mode where you will be able to enter a single value in place of the pre-set value. If no channel is currently tuned and the **Input** state is chosen, a system default value will be shown. However, if a channel is currently tuned when the item is accessed, the value of the current channel will be displayed.

Operator Selection:

You can choose the Cable operator depending on the **Country** you set.

DTV Scan Type:

This item determines whether a **Quick Scan** or a **Full Scan** will be executed. The **Quick Scan** is a simplified version of the **Full Scan** that is designed to complete in less time.

DTV Start Frequency:

This sets the frequency from which the scan will begin.

DTV End Frequency:

This sets the frequency at which the scan will end.

DTV Modulation:

You can choose from five QAM modulation settings.

DTV Symbol Rate:

This is the baud rate (KS/s) of the scan.

DTV Network ID:

This is the Network ID to be utilized for the scan. This item is greyed out when DTV Scan Type is set to "Full Scan".

Satellite Settings

From the System Setup menu, you can add the satellites that you wish to tune and configure detailed settings for each one individually.

To add a satellite:

- 1 Press and ▲/▼ to highlight **Installation** icon.
- 2 Press ▶ and ▲/▼ to select **Channel Tuning** and press **OK**.
- 3 Press ▼ to select **Satellite Settings** and press **OK**.

Satellite Settings			
Switch Type	None		
LNB Power	On		
No.	Satellite	Dish	LNB
1	Astra 19.2E	1	1
2			
3			
4			

Transponder : 1/120 (10729) MHz
Dish Type : Fixed
Lower LOF : 9750
Upper LOF : 10600

Done

- 4 Press ▼ to highlight a new line to add another satellite and press **OK**.
- 5 Press ▼ until the required satellite is displayed and press **OK**.

To delete a satellite:

- 1 In the **Satellite Settings** menu, press ▲/▼ to select the satellite you want to delete.
- 2 Press the **RED** button. A confirmation window will appear.
- 3 Press ◀/▶ to select **Yes** and press **OK**.

NOTE: It is not possible to delete position No.1.

To edit the satellite settings:

- 1 In the **Satellite Settings** menu, press ▲ to highlight **Switch Type**.
- 2 Press ◀/▶ to select **None**, **ToneBurst**, **DiSEqC 2way**, **DiSEqC 4way** or **Single Cable** as your satellite switch type.
- 3 Press ▼ to highlight **LNB Power** and press ◀/▶ to select **On** or **Off**.

To add a transponder:

- 1 In the **Satellite Settings** menu, press ▲/▼ to highlight the line you want to edit and press **OK**.

1	Astra 19.2E	1	1
---	-------------	---	---

- 2 Press the **GREEN** button. The **Transponder Settings** screen will appear.

Transponder Settings			
	Frequency	Polarisation	Symbol Rate S/S2
1	10743	H	22000 S
2	10773	H	22000 S
3	10788	V	22000 S
4	10817	V	22000 S
5	10832	H	22000 S
6	10847	V	22000 S
7	10861	H	22000 S
8	10876	V	22000 S

- 3 Press ▲ to highlight a new line.

Transponder Settings			
	Frequency	Polarisation	Symbol Rate S/S2
76	12640	H	22000 S
77	12662	H	22000 S
78	12669	V	22000 S
79	12692	H	22000 S
80	12699	V	22000 S
81	12721	H	22000 S
82	12728	V	22000 S
83			

- 4 Press **OK**.

83	0	H	0	S
----	---	---	---	---

- 5 Edit each parameter as required and press **OK**.

83	1231	H	0	S2
----	------	---	---	----

To delete a transponder:

- 1 In the **Transponder Settings** menu, press ▲ / ▼ to highlight the line you want to delete.
- 2 Press the **RED** button.

To edit the Transponder Settings:

- 1 In the **Transponder Settings** menu, press ▲ / ▼ to highlight the line you want to edit and press **OK**.
- 2 Press ◀ / ▶ to select **Frequency**, **Polarisation**, **Symbol Rate** or **S/S2**, and set the item using the **number buttons** and ▲ / ▼ if necessary.
- 3 Press **OK** to save your settings.
- 4 Repeat steps 1 through 3 for other lines.
- 5 Press the **BLUE** button to finish editing and return to Satellite Settings.

Press the **GREEN** button to cancel any edits that were made.

Press the **YELLOW** button to reset all transponder settings to their initial default settings.

To select the Dish Type:

- 1 In the **Satellite Settings** menu, press ▲ / ▼ to select the required satellite line and press **OK**.
- 2 Press ◀ / ▶ to highlight **Dish** and press the **GREEN** button.



- 3 Press ▶ and ▲ / ▼ to select **Dish Type**. You can select **Movable** or **Fixed** as the Dish Type.

To select the LNB Settings:

- 1 In the **Satellite Settings** menu, press ▲ / ▼ to select the required satellite line and press **OK**.
- 2 Press ◀ / ▶ to highlight **LNB** and press the **GREEN** button.



- 3 Press ▲ / ▼ to select **Lower LOF** or **Upper LOF** and use the **number buttons** (0-9) to input the appropriate frequencies.

Auto Tuning

NOTE: As new services are broadcast, it will be necessary to re-tune the television in order to view them.

Auto Tuning will completely re-tune the television and can be used to update the channel list. **It is recommended that Auto Tuning is run periodically to ensure that all new services are added.** All current channels and settings, i.e. locked channels, will be lost.

- 1 Press and ▲ / ▼ to highlight **Installation** icon.
- 2 Press ▶ and ▲ / ▼ to select **Channel Tuning** and press **OK**.
- 3 Press ▲ / ▼ to select **Auto Tuning** and press **OK**.

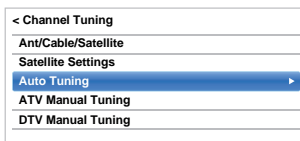

A message will appear, and then press ◀ / ▶ to select **Yes** and press **OK**.

- 4 Press ▶ and ▲ / ▼ to select **DTV**, **DTV and ATV**, or **ATV**, if available, then highlight **Start Scan** and press **OK** to continue with the **Auto Tuning**.

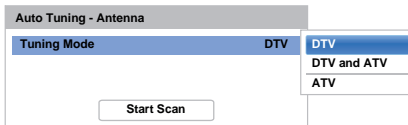

NOTE: If you have selected **Others** for the **Country** field in the **Installation** menu, and selected a tuning mode other than **DTV**, choose the optimum **ATV** broadcasting system (B/G, I, D, K or L).

The television will start to search for all available **DTV** and/or **ATV** services.

You must allow the television to complete the search.

When the search is complete, the **Auto Tuning** screen will display the services found.

- 5 Press ▲ / ▼ to move through the list to select a channel and press **OK** to view.

ATV Manual Tuning

Tuning

The television can be tuned-in manually using **ATV Manual Tuning**. For example, you might use the feature if the television cannot be connected to a media recorder/decoder with a SCART lead or when you want to tune-in a station on another **System**.

Use ◀/▶ to move across the screen and select any of the ATV Manual Tuning options. Then use ▲/▼ to adjust the settings.

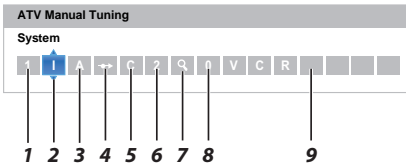

1 Position

The number to be pressed on the remote control to tune the channel.

2 System

Specific to certain areas.

3 Colour System

Factory set to Auto, should only be changed if problems are experienced, i.e. NTSC input from external source.

4 Skip

Set Skip to On (↻) or Off (↔) for the selected channel. See page 24.

5 Signal Class

The channel classification.

6 Channel

The channel number on which a station is being broadcast.

7 Search

Search up and down for a signal.

8 Manual Fine Tuning

Only used if interference/weak signal is experienced. See page 89.

9 Station

Station identification. Use the ▲▼ and ◀▶ buttons to enter up to seven characters.

To allocate a position on the television for a decoder and media recorder: turn the decoder on, insert a pre-recorded film in the media recorder, press PLAY and manually tune.

- 1 In the **Channel Tuning** menu, press ▼ to select **ATV Manual Tuning** and press **OK**.

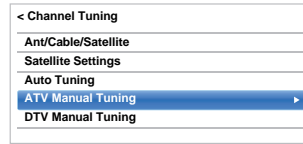

- 2 Press ▲/▼ to select the desired position. We suggest **Pos. 0** for a media recorder.

Pos.	Channel	Station
0	C2	
1	S10	
2	C7	
3	S40	
4	C22	
5	C25	
6	C28	
7	C30	

Different **Channel** numbers may be displayed.

- 3 Press **OK** to select. If the channel chosen for the media recorder is set to skip, Skip should be removed before storing.

- 4 Press ▶ to select **System** and press ▲/▼ to change if required.



- 5 Then press ▶ to select **Search**.

- 6 Press ▲/▼ to begin the search. The search symbol will flash.



7 Each signal will show on the television. If it is not your media recorder, press ▲ / ▼ again to restart the search.

8 When your media recorder signal is found, press ► to move along to **Station**. Use ▲▼◀▶ to put in the required characters, e.g. **VCR**.



9 Press **OK** to save.

10 Repeat for each **position** you want to tune.

11 Press **EXIT** when you have finished.

PLEASE NOTE

This television has direct channel entry if the channel numbers are known. Select the **ATV Manual Tuning** screen in **Step 3**. Enter the **Position number**, the **System**, then **C** for standard (terrestrial) channels or **S** for cable channels and the **Channel** number. Press **OK** to save.

Skip

To prevent certain channels from being viewed, positions can be skipped.

1 Select **ATV Manual Tuning** from the **Channel Tuning** menu.

2 Press ▲ / ▼ to highlight the position to be skipped and press **OK**.

Pos.	Channel	Station
0	C2	
1	S10	
2	C7	
3	S40	
4	C22	
5	C25	
6	C28	
7	C30	

3 Press ► to select **Skip**.

4 Press ▲ / ▼ to turn **Skip** on and press **OK**.

☞ on the screen indicates a skipped position.



5 Press **BACK** and repeat from **Step 2** or press **EXIT**.

Each position has to be *individually* selected. To turn **Skip** off, repeat the procedure for each position.

Skipped positions **cannot** be selected by **P^** and **Pv** or by the controls on the television but **can** still be accessed by the number buttons on the remote control.

Sorting positions

Channels may be moved and saved to the position of your choice.

- 1 Select **ATV Manual Tuning** from the **Channel Tuning** menu.
- 2 With the list of channels showing, press **▲** / **▼** to highlight the position to be moved and press **▶**.

Line No.	1/10	Antenna TV	
Pos.	Name		
<input type="checkbox"/> 1	ABC ONE		
<input type="checkbox"/> 2	ABC TWO		
<input type="checkbox"/> 7	ABC THREE		
<input type="checkbox"/> 30	CABC Channel		
<input checked="" type="checkbox"/> 40	ABC NEWS 24		
<input type="checkbox"/> 51	ABCi		
<input type="checkbox"/> 822	AA		
<input type="checkbox"/> 823	AC		

- 3 Press **▲** / **▼** to move through the list to your preferred position. As you do so, the other channels will move to make room.
- 4 Press **◀** to save your move.
Repeat as necessary and press **EXIT**.

DTV Manual Tuning

NOTE: This feature varies depending on the **Ant/Cable/Satellite** setting.

Manual Tuning

This feature is available for service engineers or can be used for direct channel entry if the multiplex channel is known.

- 1 Select **DTV Manual Tuning** from the **Channel Tuning** menu and press **OK**.

DTV Manual Tuning - Antenna			
	WEAK	AVERAGE	STRONG
Signal Strength			
Quality	GOOD		
Channel			67
Frequency			842.0 MHz
Bandwidth			8 MHz
Start Scan			

- 2 Enter the multiplex number using the number buttons or use **◀** / **▶** to adjust the number up or down.
- 3 Highlight **Start Scan** and press **OK**. The television will automatically search for that multiplex.

DTV Manual Tuning - Antenna			
0 New Channels - Total 6			
New	Pos.	Name	Type
	1	ABC ONE	
	2	ABC TWO	
	7	ABC THREE	
	40	ABC NEWS 24	
	51	ABCi	

When the multiplex is found, any channels that are not currently in the channel list will be added and the channel information at the top of the screen will be updated.

- 4 Repeat as necessary. Press **EXIT** to finish.

Manual Tuning for DVB-C

When **Ant/Cable/Satellite** is set to **Cable**, **DTV Manual Tuning** items are as follows:

Frequency: Input a specific frequency to be scanned

Modulation: Choose from one of five QAM modulation options

Symbol Rate: Input a specific baud rate (KS/s) to be used for the manual scan

Highlight **Start Scan** and press **OK**.

Manual Tuning for DVB-S

When **Ant/Cable/Satellite** is set to **Satellite**, **DTV Manual Tuning** items are as follows:

DTV Manual Tuning - Satellite	
	WEAK AVERAGE STRONG
Signal Strength	<div style="width: 100%; height: 10px; background: linear-gradient(to right, gray, gray, gray, gray, gray, gray, gray, gray, gray, gray, gray, gray, gray, gray, gray, gray, gray, gray, gray, gray);"></div>
Signal Quality	POOR
Satellite	ASTRA 28.2°E
Transponder	1/83
Frequency	10714 MHz
Symbol Rate	22000 KS/s
Polarisation	H
Search Option	Free to Air
Start Scan	

Press **▲/▼** to highlight an item (**Satellite**, **Transponder**, **Frequency**, **Symbol Rate**, **Polarisation** or **Search Option**) and press **◀/▶** to select the required option.

Highlight **Start Scan** and press **OK**.

DTV Settings

Channels (Antenna/Cable)

The channel order may be changed to suit your personal preference.

- 1 Select **DTV Settings** from the **Installation** menu and press **OK**.
- 2 Press **▼** to select **Channels** and press **OK**.

< DTV Settings	
Channels	▶
Subtitle and Audio	
Parental PIN Setup	
Parental Control	
Local Time Setting	
Standby Channel Update	
Common Interface	

- 3 For your convenience, you can jump to specific places in the list by one of two methods.

Channels		Antenna TV
Line No.	1/10	
Pos.	Name	👁
1	ABC ONE	
2	ABC TWO	
7	ABC THREE	
30	CABC Channel	
40	ABC NEWS 24	
51	ABCi	
822	AA	
823	AC	

Line Number Jump — Use the **number buttons** (0-9) to input the line number you want to select and press **OK**.

It is also possible to change the Position number of a particular channel.

Renumber — Press the **RED** button to renumber the highlighted channel. Edit the channel number using the **number buttons** and press **OK**. If the position number you input already exists, a confirmation window will appear.

Pos.	Name
1	ABC ONE

Move — Press the **GREEN** button to activate the **Move** feature. Press **▲** / **▼** to select the channel you wish to move and press **OK** to check.

If you wish to move multiple channels at once, select another channel and check in the same way. Repeat as necessary.

Once all desired channels have been checked, press **▲** / **▼** to place the focus at the position to which you wish to move the channels. The channels will be inserted above the highlighted channel. Press the **GREEN** button to execute the move.

Channels		Antenna TV
Line No.	1/10	
Pos.	Name	
<input checked="" type="checkbox"/> 1	ABC ONE	
<input type="checkbox"/> 2	ABC TWO	
<input type="checkbox"/> 7	ABC THREE	
<input type="checkbox"/> 30	CABC Channel	
<input type="checkbox"/> 40	ABC NEWS 24	
<input type="checkbox"/> 51	ABCI	
<input type="checkbox"/> 822	AA	
<input type="checkbox"/> 823	AC	

Position No. Sort — Press the **YELLOW** button. A confirmation window will appear. Press **◀** / **▶** to select **Yes** and press **OK**.

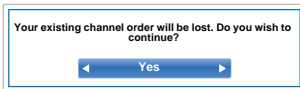

Channels (Satellite)

1 Select **DTV Settings** from the **Installation** menu and press **OK**.

2 Select **Channels** and press **OK**.

The satellite channel list will appear.

Channels		Satellite TV
Line No.	1/10	
Pos.	Name	Satellite
1	DDD	19.2°E
2	AB	19.2°E
3	E	19.2°E
801	BBC	22.5°E
802	BB	22.5°E
803	BA	22.5°E
822	AA	25.6°E
823	AC	25.6°E

3 For your convenience, you can edit and sort your channel list.

Line Number Jump — Press the **number buttons** (0-9) to input the line number you want to select and press **OK**.

Satellite Jump — Press **◀◀** / **▶▶** to jump to the next channel on a different Satellite.

Renumber — Same as Antenna/Cable channels. See page 26.

Move — Same as Antenna/Cable channels. See page 27.

Position No. Sort — Press the **YELLOW** button. A confirmation window will appear. Press **◀** / **▶** to select **Yes** and press **OK**.

Standby Channel Update

If the **Standby Channel Update** is set to **On**, when the **TV** is in **Standby**, **Digital Tuning** is automatically executed.

1 Select **DTV Settings** from the **Installation** menu and press **OK**.

2 Press **▼** to select **Standby Channel Update** and press **▶** and **▲** / **▼** to select **On**.

Location setting

You can select either **Home** or **Store** mode. **Home** is recommended for normal home use. Select **Store** when using the television for displaying in a shop, etc.

1 Select **Location** from the **Installation** menu.

2 Press **◀** / **▶** to select **Home** or **Store**.

Analogue switch-off

This is a **digital** television which is integrated to allow the use of both **digital** and **analogue** services. However, during the lifetime of this set it is very likely that **analogue** services will be switched off to allow for more new **digital** services.

This 'switch-off' will happen in a number of phases, which will be advertised in your area well in advance. It is recommended that at each phase the television is re-tuned to ensure that existing and new **digital** services can be viewed without disruption.

General controls

Quick Menu

Quick Menu helps you access some options quickly, such as **Picture Mode**, **Picture Size**, **More Information**, **Sleep Timer** etc.

Press **QUICK** to open the **Quick Menu** and use ▲ / ▼ to select the option.

Quick Menu	
Intel® WiDi	
Picture Mode	Standard
Picture Size	Wide
3D Settings	
More Information	
Channel Options	
Sleep Timer	
HDMI CEC Device Control	
Speakers	TV Speakers
Headphone Level	30
Wireless Information	
Recording Information	

NOTE: **Quick Menu** items are different depending on the current mode.

Quick menu item example

Mode	Quick menu item	Description
When viewing a TV programme or pictures from the external input Single Window	Intel® WiDi	See page 64.
	Picture Mode	See page 38.
	Picture Size	See page 36.
	3D Settings	See page 30.
	More Information	See page 76.
	Channel Options	See page 78.
	Sleep Timer	See page 74.
	HDMI CEC Device Control	See page 85.
	Speakers	See page 85.
	Headphone Level	See page 35.
When using EPG	Wireless Information	See page 46.
	Recording Information	See page 76.
	Genre Colour	See page 77.
Media Player	EPG Update / Cancel EPG Update	See page 76.
	Picture	See page 38.
	3D Settings	See page 30.
	Sound	See page 34.
	Interval Time	See page 68.
	Repeat	See page 68.
	Background Music	See page 68.
	Play List	See page 69.
	Sleep Timer	See page 74.
	Speakers	See page 85.
Headphone Level	See page 35.	

Selecting channels

To select a channel, use the numbered buttons on the remote control.

Channels can also be selected using **P▲** and **P▼**.

To display on-screen information such as channel, input mode or stereo/mono signal, press **(i+)**. Press again to cancel.

The Time Display – analogue only

The time display facility allows the current (text service) time to be seen on the television screen.

Press **(⏰)**/**(⏏)** whilst watching a normal television broadcast to see the time display from the broadcaster. It will remain on screen for about 5 seconds.

NOTE: This display may not be available in some cases.

Stereo and Bilingual transmissions

For DTV programmes

For stereo or dual mono broadcasts, press /II and use / to select settings.

Mode Display	Pressing
Stereo	Stereo → Left → Right
Dual mono	Dual 1 → Dual 2 → Dual
Mono	–
Multichannel	–

For multi-audio track broadcasts, press /II repeatedly to change the audio language (see “Audio languages” on page 79).

For ATV programmes

If stereo or dual language broadcasts are transmitted, the word **Stereo** or **Dual** will appear on the screen each time channels are changed, disappearing after a few seconds. If the broadcast is not in stereo, the word **Mono** will appear.

Stereo... Press /II to select **Stereo** or **Mono**.

Bilingual... Bilingual transmissions are rare. If they are transmitted, the word **Dual** will be displayed. Choose the required programme number, and if the word **Dual** appears, press /II to select **Dual 1**, **Dual 2** or **Mono**.

Using 3D functions

Before using 3D programming, see and follow “Important information for 3D viewing” section on page 100.

Viewing 3D programming requires the following:

- Toshiba FPT-AG03 (L73*5D/M83*5D : 2pcs supplied, L73**RK/L73**RB : 1pcs supplied, L73*3D/L73*1D : Not supplied)
- Compatible 3D playback device or 3D source
- 3D capable high quality HDMI cable

Viewing 3D images

Incoming video signals can either be in 2D or 3D format. A 2D signal can be viewed in either 2D or 3D, and 3D can be viewed in either 2D or 3D. If the TV can detect the fact that a signal is 3D, it can change to 3D mode automatically – see “Setting the auto start mode” (on page 31).

Otherwise you can change the viewing mode using the 3D button. Finally, the format of the 3D signal can be either Side by Side (SBS) or Top and Bottom (TB). You may have to choose the correct format if the TV can not detect it automatically – see “Switching display mode or selecting 3D format”.

Moreover, you can change 2D images to 3D images by pressing the 3D button when viewing in 2D.

NOTE:

- When 3D format signal is not received, display mode is not switched to 3D.
- If appropriate mode and format are not selected, 3D image is not correctly displayed.
- There will be restrictions on the Picture Size settings for 3D Mode and 2D Mode.
- There are individual differences in perception of 3D images.
- When viewing 3D images, wear the 3D Glasses.
- The 2D to 3D conversion function is activated and controlled by you according to your personal preferences.
- The 2D to 3D conversion function is meant for enjoyment of 2D home video, and other 2D content you create, in 3D according to your personal preferences.
- The 2D to 3D conversion function is not intended for use with pre-recorded 2D copyrighted content owned by a third-party unless the copyright owner has given direct or indirect permission, or unless applicable law permits such use.

Switching display mode or selecting 3D format

There are four modes for watching TV.



Mode	Description
3D*	Displays 3D images.
2D	Changes 3D images to 2D.
2D to 3D*	Changes 2D images to 3D.
Native	Displays a received signal format as it is.

* This mode does not support all content depending on its input source format.

3D format select

If a right and left images are same in Native mode, select SBS.

If a top and bottom images are same in Native mode, select TB. 3D formats are the following.

3D format	Description
Side by Side (SBS)	Images for the left and right eyes are positioned side-by-side. 
Top and Bottom (TB)	Images for the left and right eyes are positioned at the top and bottom of the screen. 
Frame Packing (FP) *	Image for the left and right eyes for two frames are positioned at the top and bottom of the screen. 

* This format cannot be selected manually.





















The 3D button's operation

The behaviour of 3D when viewing in Native mode is different depending on the input mode.

Depending on the input mode, the screen for selecting 2D or 3D is displayed or the display mode switches between 2D and 3D.

To switch to 3D mode:

















- Set **3D Auto Start** in the **3D** menu to **3D**.
- Press **3D** while viewing 2D mode or Native mode.

Trigger of Switching Display Mode				Press 3D button	
Input Signal				3D Format Select	
Type	Additional Information	Format	Source Signal	Select 3D	Select 2D to 3D
3D Format Signal	With 3D Auto Detect Information	FP		* 	
		SBS	 	* 	
		TB	 	* 	
	Without 3D Auto Detect Information	SBS	 	* 	 
		TB	 	 	* 
		2D Format Signal			

* Correct 3D image

To select 3D format from the Quick menu in 3D mode:

- 1 Press **QUICK** to open the **Quick Menu**.
- 2 Press **▲ / ▼** to select **3D Settings** and press **OK**.
- 3 Press **▲ / ▼** to select **3D Format Select** and press **OK**.
- 4 Press **◀ / ▶** to select **3D (SBS)** or **3D (TB)**.

Trigger of Switching Display Mode				Quick menu	
Input Signal				3D Format Select	
Type	Additional Info	Format	Source Signal	SBS	TB
3D Format Signal	With 3D Auto Detect Information	FP			
		SBS	 		
		TB	 		
	Without 3D Auto Detect Information	SBS	 	* 	 
		TB	 	 	* 
		2D Format Signal			

* Correct 3D image

To switch to 2D mode:

- Set **3D Auto Start** in the **3D** menu to **2D**.
- Press **3D** while viewing 3D mode.

Input Signal		Trigger of Switching Display Mode		Press 3D button
Type	Additional Info	Format	Source Signal	
3D Format Signal	With 3D Auto Detect Information	FP		*
				*
		SBS		*
		TB		*
	Without 3D Auto Detect Information	SBS		
		TB		
2D Format Signal				*

* Correct 2D image

To select 2D format from the Quick menu in 2D mode:

- 1 Press **QUICK** to open the **Quick Menu**.
- 2 Press **▲ / ▼** to select **3D Settings** and press **OK**.
- 3 Press **▲ / ▼** to select **2D Format Select** and press **OK**.
- 4 Press **◀ / ▶** to select **Native**, **2D (SBS)** or **2D (TB)**.

Input Signal		Trigger of Switching Display Mode		Quick menu		
Type	Additional Info	Format	Source Signal	SBS	TB	Native
3D Format Signal	With 3D Auto Detect Information	FP				
		SBS		*		
		TB			*	
	Without 3D Auto Detect Information	SBS		*		
		TB			*	
2D Format Signal						

* Correct 2D image

NOTE: Take off the 3D Glasses in 2D mode.

To switch to Native mode:

- Press **3D** while viewing 3D mode.
- Press **3D** while viewing 2D to 3D mode.

NOTE: When 3D format signal with 3D Auto Detect Information is received, it is not possible to switch to Native.

- From the **Quick Menu** in 2D mode.

- 1 In the **Quick Menu**, press **▲ / ▼** to select **3D Settings** and press **OK**.
- 2 Press **▲ / ▼** to select **2D Format Select** and press **OK**.
- 3 Press **◀ / ▶** to select **Native**.

NOTE: When Frame Packing is input, 2D Format Select will be greyed out.

To switch to 2D to 3D mode:

Press **3D** while viewing 2D or Native mode.

NOTE: Depending on the input mode, the display mode switches between 2D and 3D.

Setting the auto start mode

Controls what the TV does when it detects a 3D signal.

- 1 Press and **▲ / ▼** to highlight **3D** icon.
- 2 Press **▶** and **▲ / ▼** to select **3D Auto Start**.
- 3 Press **◀ / ▶** to select **3D**, **2D**, or **Off** and press **OK**.

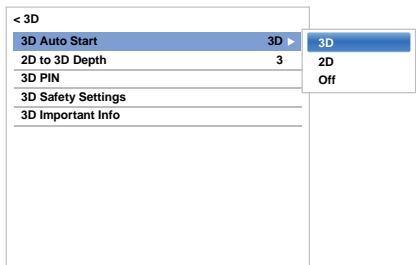

Option	Description
3D	Displays as 3D mode automatically when 3D format signal is received.
2D	Displays as 2D mode automatically when 3D format signal is received.
Off	Displays a screen that allows you to select 3D or 2D when 3D format signal is received.

Adjusting 2D to 3D Depth

You can adjust the level of 3D.

From the Menu:

- 1** In the **3D** menu, press ▲ / ▼ to select **2D to 3D Depth** and press **OK**.
- 2** Press ◀ / ▶ to select **1, 2, 3, 4, or 5** and press **OK**.
The higher the number, the stronger the 3D effect.

From the Quick Menu:

- 1** Press **QUICK** to open the **Quick Menu**.
- 2** Press ▲ / ▼ to select **3D Settings** and press **OK**.
- 3** Press ▲ / ▼ to select **2D to 3D Depth** and press **OK**.
- 4** Press ◀ / ▶ to select **1, 2, 3, 4, or 5** and press **OK**.
The higher the number, the stronger the 3D effect.

NOTE: Depending on the content, setting the 3D effect to a high level may result in blurring of the image contours and background.

If you experience any abnormal sensation or feel fatigue or nausea when viewing 3D images, stop watching and rest until the symptoms subside. Before viewing again, adjust the 3D effect to a lower number and view at a level at which the symptoms do not occur.

Setting the 3D PIN code

A 3D PIN code is necessary for using 3D Safety Settings.

To enter a new PIN code:

- 1** In the **3D** menu, press ▲ / ▼ to select **3D PIN** and press **OK**.
- 2** Press the number buttons to enter a 4-digit number. Confirm the code.
NOTE: PIN code cannot be set to "0000".

To change or delete your PIN code:

- 1** In the **3D** menu, press ▲ / ▼ to select **3D PIN** and press **OK**.
- 2** Press the number buttons to enter your 4-digit PIN code.
- 3** Select **Change PIN** or **Delete PIN** and press **OK**.

NOTE:

- PIN code cannot be set to "0000".
- If PIN is deleted, **3D Safety Settings** is greyed out, and the settings are reset to the factory default.

Setting 3D Start Message

When this feature is set to On, a message is displayed onscreen when a 3D signal is received.

- 1** In the **3D** menu, press ▲ / ▼ to select **3D Safety Settings** and press **OK**.
- 2** Enter your 4-digit 3D PIN code.
- 3** Press ▲ / ▼ to select **3D Start Message**.
- 4** Press ▶ and ▲ / ▼ to select **On** or **Off**.

Setting 3D Lock

When this feature is set to On, you must enter 3D PIN code for changing display mode.

- 1 In the **3D** menu, press ▲ / ▼ to select **3D Safety Settings** and press **OK**.
- 2 Enter your 4-digit 3D PIN code.
- 3 Press ▲ / ▼ to select **3D Lock**.
- 4 Press ◀ / ▶ to select **On**.

Setting 3D Timer Lock

When the 3D Timer Lock feature is set to On, neither the PIN input window nor the 3D start message will be shown while the 3D Enable timer is active, even if a switch to 3D Mode occurs. This helps to avoid asking for the 3D Lock PIN and displaying 3D start message every time when switching to 3D.

NOTE: This feature cannot be selected until the 3D PIN is set.

- 1 In the **3D** menu, press ▲ / ▼ to select **3D Safety Settings** and press **OK**.
- 2 Enter your 4-digit 3D PIN code.
- 3 Press ▲ / ▼ to select **3D Timer Lock**.
- 4 Press ▶ and ▲ / ▼ to select **On**.

Setting Enable 3D Timer

This feature helps to remind you not to watch 3D video for extended periods of time. Once a set period of time has passed, a dialogue will be shown asking you if you wish to continue viewing or not.

- 1 In the **3D** menu, press ▲ / ▼ to select **3D Safety Settings** and press **OK**.
- 2 Enter your 4-digit 3D PIN code.
- 3 Press ▲ / ▼ to select **Enable 3D Timer**.
- 4 Press ▶ and ▲ / ▼ to select **30, 60, 90, or 120** minutes.
- 5 To cancel the timer, select **Off**.

Displaying 3D Important Info

- 1 In the **3D** menu, press ▲ / ▼ to select **3D Important Info** and press **OK**.
A message will appear.

Switching left and right images

The left and right eye shutter timing of the glasses can be swapped. If 3D images look blurred, switch the left and right sides of the 3D image.

- 1 Press **QUICK** to open the **Quick Menu**.
- 2 Press ▲ / ▼ to select **3D Settings** and press **OK**.
- 3 Press ▲ / ▼ to select **Left and Right Image**.
- 4 Press ▶ and ▲ / ▼ to select **Swapped** and press **OK**.

Sound controls

Volume controls and sound mute

Volume

Press \triangle + or \triangle - to adjust the volume.

Sound Mute

Press \times once to turn the sound off and again to cancel.

Dual

If a programme or film is being broadcast with a soundtrack in more than one language, the **Dual** feature allows selection between them.

- 1 Press ⏮ and \triangle / \triangle to highlight **Sound** icon.
- 2 Press \blacktriangleright and \triangle / \triangle to select **Dual** and press \blacktriangleright and \triangle / \triangle to choose between **Dual 1** or **Dual 2**.

< Sound	
Balance	0
Bass	0
Treble	0
Audyssey Premium Television	
Dynamic Range Control	On
Dual	Dual 1
Audio Level Offset	
TV Speakers	On
Headphone Level	
Audio Description	
Digital Audio Output	

Balance

- 1 In the **Sound** menu, press \triangle / \triangle to select **Balance** and press \blacktriangleleft / \blacktriangleright to emphasize left and right speaker balance.

Bass, Treble

- 1 In the **Sound** menu, press \triangle / \triangle to select **Bass** or **Treble**.
- 2 Press \blacktriangleleft / \blacktriangleright to change the setting.

TV Mounting (Wall/Table)

Audyssey TV Mounting feature can provide an appropriate sound depending on the TV installation type, that TV is installed on a wall or a TV table.

- 1 In the **Sound** menu, press \triangle / \triangle to select **Audyssey Premium Television** and press **OK**.
- 2 Press \triangle / \triangle to select **TV Mounting**.
- 3 Press \blacktriangleright and \triangle / \triangle to select **Wall** or **Table**.

Dynamic Volume®

Audyssey Dynamic Volume® controls volume levels to eliminate loud spikes and raise soft dialog for more enjoyable television and movie viewing.

- 1 In the **Sound** menu, press \triangle / \triangle to select **Audyssey Premium Television** and press **OK**.
- 2 Press \triangle / \triangle to select **Dynamic Volume**.
- 3 Press \blacktriangleright and \triangle / \triangle to select **Day**, **Night** or **Off**.

Audyssey ABX™

Audyssey ABX™ technology uses sophisticated driver analysis and low frequency monitoring to extend the range and bass of small speakers. This enables the system to produce lower frequencies that would be possible with a traditional system of the same size.

- 1 In the **Sound** menu, press \triangle / \triangle to select **Audyssey Premium Television** and press **OK**.
- 2 Press \triangle / \triangle to select **Audyssey ABX**.
- 3 Press \blacktriangleright and \triangle / \triangle to select the desired **Audyssey ABX** level (**Low**, **High** or **Off**).

Dynamic Range Control

This feature allows control of audio compression for some digital TV programmes (MPEG-1 and MPEG-2 audio programmes are not supported).

- 1 In the **Sound** menu, press \triangle / \triangle to select **Dynamic Range Control**.
- 2 Press \blacktriangleright and \triangle / \triangle to select **On** or **Off**.

Audio Level Offset

Sometimes there can be large changes in volume when switching from a DTV 5.1ch to a DTV 2ch, an ATV channel, or an external input. Using the **Audio Level Offset** feature reduces these volume differences.

- 1 Set the volume level usually used when watching a DTV 5.1ch programme.
- 2 Tune to a channel which is DTV 2ch, ATV or an external input.
- 3 In the **Sound** menu, press **▲ / ▼** to select **Audio Level Offset** and press **OK**.
- 4 Press **▲ / ▼** to select an option, and then press **◀ / ▶** to adjust the volume level.



NOTE:

- The available item changes depending on the current input source. For example, while watching a DTV 2ch programme, only **DTV 2ch** is available and the other two items are greyed out in the menu. This allows you to easily adjust according to each condition.
- When watching a DTV 5.1ch programme, this feature is not available.

TV Speakers On/Off

This feature allows you to turn the TV speakers off when connecting the audio system.

- 1 In the **Sound** menu, press **▲ / ▼** to select **TV Speakers**.
- 2 Press **▶** and **▲ / ▼** to select **Off**.

To turn on the built-in speakers:

Select **On** in step 2.

Headphone Settings

This setting is used to set the sound output when headphones are connected.

Speaker Link	Headphone	Speakers
On	Sound is output (◀ ± is available.)	No sound
Off	Sound is output (Headphone level menu is available.)	Sound is output (◀ ± is available.)

- 1 In the **Sound** menu, press **▲ / ▼** to select **Headphone Level** and press **OK**.
- 2 Press **▲ / ▼** to select **Speaker Link** and press **▶** and **▲ / ▼** to select **On** or **Off**.



- 3 If you select **Off**, then highlight **Headphone Level** and use **◀ / ▶** to adjust the headphone sound.

Audio Description

Audio Description is an additional narrative sound track for visually impaired individuals to understand and enjoy the story line more fully. The letters **AD** will be displayed in the channel banner when programmes contain **AD** content.

- 1 In the **Sound** menu, press **▲ / ▼** to select **Audio Description** and press **OK**.
- 2 Press **▲ / ▼** to select **Audio Description** and press **▶** and **▲ / ▼** to select **On**.

The **AD** button on the remote control can also be used to toggle the **Audio Description** feature between **On** and **Off**.

- 3 To adjust the level of the audio description sound to the main sound, highlight **Mixing Level** and press **◀ / ▶**.



Widescreen viewing

Depending on the type of broadcast being transmitted, programmes can be viewed in a number of formats.

WIDE

Use this setting when watching a widescreen DVD, widescreen video tape or a 16:9 broadcast (when available). Due to the range of widescreen formats (16:9, 14:9, 20:9 etc.) black bars may be visible on the top and bottom of the screen.

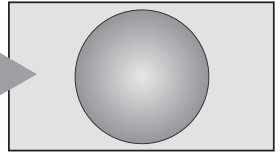

4:3

Use this setting to view a true 4:3 broadcast.

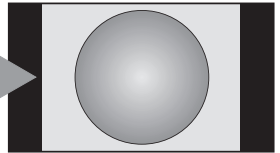

SUPER LIVE

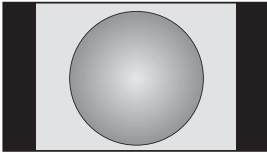

This setting will enlarge a 4:3 image to fit the screen by stretching the image horizontally and vertically, holding better proportions at the centre of the image. Some distortion may occur.

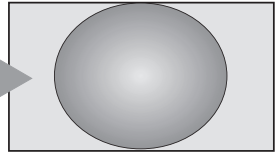

CINEMA

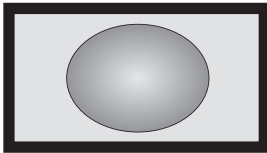

When watching 'all sides panel format' films/video tapes, this setting will eliminate or reduce the black bars at all sides of the screen by zooming in and selecting the image without distortion.

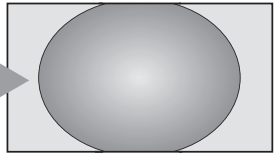

SUBTITLE

When subtitles are included on a letterbox format broadcast, this setting will raise the picture to ensure that all the text is displayed.

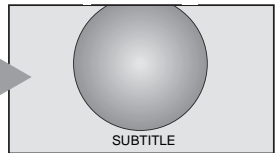

14:9

Use this setting when watching a 14:9 broadcast.

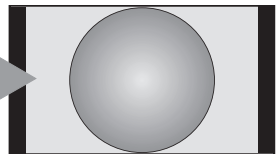

NATIVE

This setting will show the picture without overscan, i.e. WYSIWYG.

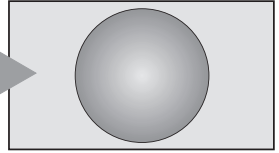
**PC NORMAL**

This setting will show the picture without overscan, i.e. WYSIWYG. This option is only available when watching a PC signal source via HDMI or PC terminal.

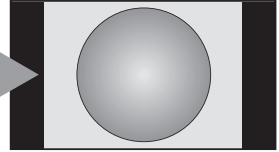
**PC WIDE**

This setting will show the picture without overscan or side panels. This option is only available when watching a PC signal source via HDMI or PC terminal.

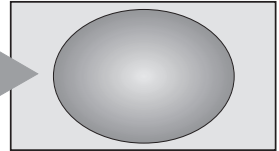
**Dot by Dot**

“Dot by Dot” is a non-scaling display. Depending on the input signal format, the picture is displayed with side panels and/or bars at the top and bottom (e.g. VGA input source).

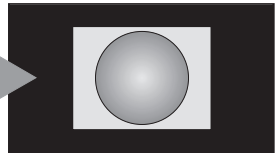

Press the  button on the remote control to display the list of available widescreen formats.

Press the button repeatedly to highlight the required format.

The **Quick Menu** feature can also be used to select **Picture Size**.

AV format

Picture Size
Wide
4:3
Super Live
Cinema
Subtitle
14:9
Native

PC format

Picture Size
PC Normal
PC Wide
Dot by Dot

Using the special functions to change the size of the displayed image (i.e. changing the height/width ratio) for the purposes of public display or commercial gain may infringe on copyright laws.

Picture controls

Most of the picture controls and functions are available in both **digital** and **analogue** modes. *PLEASE NOTE: Features not available will be greyed out.*

Picture Mode

This television offers the choice of personalising the picture style.

AutoView, Dynamic, Standard, Hollywood Night, Hollywood Day, Hollywood Pro, Store, Game and PC are preset options and affect many features/settings within the television.

NOTE:

- Because the **AutoView** mode automatically adjusts picture settings based on ambient light conditions and input signal content, the **Auto Brightness Sensor** and **Expert Picture Setting** is greyed out when it is selected.
- **Store** mode is only available when **Location** is set to **Store**.
- **Game** mode is available in external input mode (other than aerial input). When you select **Game** mode, suitable widescreen formats will be selected.
- **PC** mode is available in RGB/PC input mode or HDMI input mode.

- 1 Press  and $\blacktriangle / \blacktriangledown$ to highlight **Picture** icon and press **OK**.
- 2 Press \blacktriangleright and $\blacktriangle / \blacktriangledown$ to select **Picture Mode** and press **OK**.

< Picture	
Picture Mode	Standard \blacktriangleright
Reset	
Backlight	0
Contrast	100
Brightness	0
Colour	0
Tint	0
Sharpness	0
Advanced Picture Setting	
Expert Picture Setting	
Display Setting	

- 3 Press $\blacktriangle / \blacktriangledown$ to select the picture mode you prefer and press **OK**.

NOTE: The picture mode you select affects the current input only. You can select a different picture mode for each input.

Picture preferences

*You can customize current picture mode settings as desired. For example, while selecting "Dynamic", if you change the following items, such as **Backlight, Contrast, Brightness, Colour, Tint, Sharpness** and the **Advanced Picture Settings** items, your new settings are saved for "Dynamic" picture mode.*

- 1 In the **Picture** menu, press $\blacktriangle / \blacktriangledown$ to select either **Backlight, Contrast, Brightness, Colour, Tint or Sharpness** and press **OK**.
- 2 Press $\blacktriangleleft / \blacktriangleright$ to adjust the settings and press **OK**.

Reset

*This feature resets all picture settings to the factory settings except **Picture Mode**.*

- 1 In the **Picture** menu, press $\blacktriangle / \blacktriangledown$ to select **Reset** and press **OK**.
- 2 A confirmation message will appear. Press $\blacktriangleleft / \blacktriangleright$ to select **Yes** and press **OK**.

ColourMaster

*When **ColourMaster** is set to **On**, it allows the 'Base Colour Adjustment' feature to become available.*

- 1 In the **Picture** menu, press $\blacktriangle / \blacktriangledown$ to select **Advanced Picture Settings** and press **OK**.
- 2 Press \blacktriangledown to select **ColourMaster** and press \blacktriangleright and $\blacktriangle / \blacktriangledown$ to select **On** or **Off**.

< Advanced Picture Settings	
ColourMaster	Off \blacktriangleright
Base Colour Adjustment	On
Colour Temperature	Off
Auto Brightness Sensor	On
Active Backlight Control	High
Black/White Level	Middle
Noise Reduction	
Resolution+	On
ClearScan	High
Reset	

Base Colour Adjustment

The **Base Colour Adjustment** feature allows the adjustment of individual colours to suit personal preference. This can be useful when using an external source.

- 1 In the **Advanced Picture Settings** menu, press ▲ / ▼ to select **Base Colour Adjustment** and press **OK**.
- 2 Press ▲ / ▼ to select an option and press ► to move to the adjustment window.

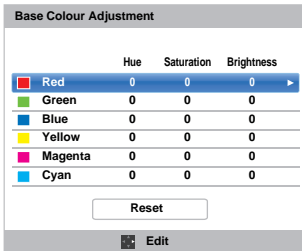

- 3 Press ◀ / ▶ to select **Hue**, **Saturation** or **Brightness** and press ▲ / ▼ to adjust the settings as required.

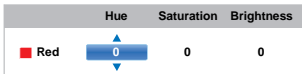

- 4 Press **BACK** to return to the previous menu.
To return to the factory settings, select **Reset** and press **OK**.

Colour Temperature

Colour Temperature increases the “warmth” or “coolness” of the picture by increasing the red or blue tint.

- 1 In the **Advanced Picture Settings** menu, press ▲ / ▼ to select **Colour Temperature** and press **OK**.
- 2 Press ▲ / ▼ to select **Colour Temperature** and press **OK**.
- 3 Press ▲ / ▼ to select **Cool**, **Natural** or **Warm** to suit your preference and press **OK**.
- 4 Press ▲ / ▼ to select **Red Level**, **Green Level** or **Blue Level** and press ◀ / ▶ to adjust the level.

NOTE: To return the adjustments to the factory defaults, select **Reset** and press **OK**.

Auto Brightness Sensor

When the **Auto Brightness Sensor** is activated, it will automatically optimise the backlighting levels to suit ambient light conditions.

- 1 In the **Advanced Picture Settings** menu, press ▲ / ▼ to select **Auto Brightness Sensor** and press **OK**.
- 2 Press ▲ / ▼ to select **On** or **Off** and press **OK**.

Active Backlight Control

When the **Active Backlight Control** feature is activated, it will control the backlighting levels depending on various scenes such as picture motion, bright scene or dark scene.

- 1 In the **Advanced Picture Settings** menu, press ▲ / ▼ to select **Active Backlight Control** and press **OK**.
- 2 Press ▲ / ▼ to select **High**, **Low** or **Off** and press **OK**.

High: To control the backlighting levels depending on various scenes such as picture motion, bright scene or dark scene

Low: To control the backlighting levels for dark scene

Black/White Level

Black/White Level increases the strength of dark areas of the picture to improve the definition.

- 1 In the **Advanced Picture Settings** menu, press ▲ / ▼ to select **Black/White Level** and press **OK**.
- 2 Press ▲ / ▼ to select **High**, **Middle**, **Low** or **Off** and press **OK**.

MPEG NR – Noise Reduction

When watching a DVD, the compression may cause some words or picture elements to become distorted or pixelated.

Using the **MPEG NR** feature reduces this effect by smoothing out the edges.

- 1 In the **Advanced Picture Settings** menu, press **▲ / ▼** to select **Noise Reduction** and press **OK**.
- 2 Press **▼** to select **MPEG NR** and press **OK**.



- 3 Press **▲ / ▼** to select **Off**, **Low**, **Middle** or **High** to suit your preference and press **OK**.

NOTE: If the picture mode is set to **Game** or **PC**, this feature is not available.

DNR – Digital Noise Reduction

DNR allows you to “soften” the screen representation of a weak signal to reduce the noise effect.

- 1 Select **DNR** from the **Noise Reduction** menu.
- 2 Press **▲ / ▼** to select **Off**, **Low**, **Middle**, **High** or **Auto** and press **OK**. The differences may not always be noticeable (for the best result use lower settings as picture quality can be lost if the setting is too high).

NOTE: If the picture mode is set to **Game** or **PC**, this feature is not available.

Resolution +

The **Resolution+** feature allows you to adjust the clarity levels for your desired picture settings.

- 1 In the **Advanced Picture Settings** menu, press **▲ / ▼** to select **Resolution+** and press **OK**.
- 2 Press **▲ / ▼** to select **On**.

NOTE:

- This feature may not work properly depending on the content.
- Noise may appear in the picture depending on the device connected to the TV (e.g. a device with a specific enhancer function).

ClearScan

This feature helps to eliminate video shaking.

- 1 In the **Advanced Picture Settings** menu, press **▲ / ▼** to select **ClearScan** and press **OK**.
- 2 Press **▲ / ▼** to select **High**, **Middle**, **Standard** or **Off**.

Resetting the advanced picture settings

This feature allows you to reset the current **Advanced Picture Settings** to the default values.

- 1 In the **Advanced Picture Settings** menu, press **▲ / ▼** to select **Reset**.
- 2 Press **OK**.

Expert Picture Settings

This feature is available when the **Picture Mode** option is **Standard**, **Hollywood Day**, **Hollywood Night**, and **Hollywood Pro**.

Test Pattern

When the test pattern is on screen, you can navigate in the **Picture** submenus and adjust picture settings without removing the image.

When you move to a non-Picture menu, or close the menus, regular video will be restored.

- 1 In the **Picture** menu, press **▲ / ▼** to select **Expert Picture Settings** and press **OK**.
- 2 Press **▲ / ▼** to select **Test Pattern** and press **OK**.
- 3 Press **▲ / ▼** to select **On** and press **OK**.

RGB Filter

This feature individually enables or disables the red, green, and blue components of the picture to allow for more accurate adjustment of each colour.

- 1 In the **Expert Picture Settings** menu, press **▲ / ▼** to select **RGB Filter** and press **OK**.
- 2 Press **▲ / ▼** to select **Red**, **Green** or **Blue** to adjust and press **OK**.
- 3 Press **▲ / ▼** to select **On** and press **OK**.
- 4 Press **▲ / ▼** to select **Colour** or **Tint** and press **◀ / ▶** to adjust.
- 5 Press **OK**.

NOTE: It is not possible to turn off all three colours simultaneously.

Colour Decoding

If you view DVDs with this TV, the Colour Decoding option may be set to ensure the colourimetry reproduction.

NOTE: The modes excluding **Auto (BT.709 and BT.601)** are to convert an irregular signal output from the DVD etc. with incorrect colour to the optimum state. If **BT.709** or **BT.601** is selected with a normal signal received, the colour may not be correctly displayed. This feature should normally be set to **Auto**.

- 1 In the **Expert Picture Settings** menu, press **▲ / ▼** to select **Colour Decoding** and press **OK**.
- 2 Press **▲ / ▼** to select **Auto, BT.709** or **BT.601** and press **OK**.

White Balance-Window Display

This feature displays a special Window Pattern to be used when adjusting white balance with a measuring device.

- 1 In the **Expert Picture Settings** menu, press **▲ / ▼** to select **White Balance** and press **OK**.
- 2 Press **▲ / ▼** to select **Window Display** and press **▶** and **▲ / ▼** to select **On** and press **OK**.

White Balance-Setting Type

You can choose from two types of White Balance adjustment.

- 1 In the **Expert Picture Settings** menu, press **▲ / ▼** to select **White Balance** and press **OK**.
- 2 Press **▲ / ▼** to select **Setting Type** and press **OK**.
- 3 Press **▲ / ▼** to select **2P** or **10P** and press **OK**.

White Balance-2P White Balance

- 1 Press **▼** to select **2P White Balance** and press **OK**.
- 2 Press **▲ / ▼** to select **Red-Offset, Green-Offset, Blue-Offset, Red-Gain, Green-Gain, or Blue-Gain**.
A white square will appear on the screen.
- 3 Press **◀ / ▶** to adjust and press **OK**.

White Balance-10P White Balance

- 1 Press **▼** to select **10P White Balance**.
- 2 Press **▲ / ▼** to select **IRE, Red, Green, or Blue**.
- 3 Press **◀ / ▶** to adjust and press **OK**.

NOTE: The adjustments made for Red / Green / Blue are stored separately for each IRE setting. (There are ten IRE settings from 10 to 100.)

Gamma Calibration

Toshiba has integrated picture calibration systems into its LCD televisions. Now you can enjoy the benefits of automatically calibrated gamma and white levels.

In order to take advantage of these features the Toshiba colour analyzer TPA-1 is required.

- 1 In the **Expert Picture Settings** menu, press **▲ / ▼** to select **Gamma Calibration** and press **OK**.
- 2 Press **▲ / ▼** to select **Apply Calibration** and press **▶** and **▲ / ▼** to select **Enabled** and press **OK**.
- 3 Press **▲ / ▼** to select **Auto Gamma Calibration** and press **OK**.
- 4 Connect the USB colour analyzer to the USB 1 or USB 2 port.
- 5 Input the target value and place the USB colour analyzer over the square on screen.

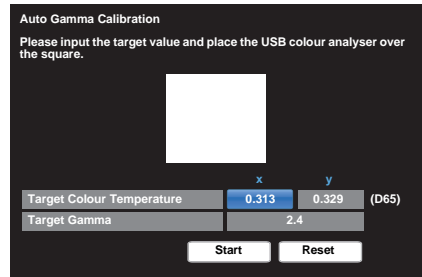

- 6 Highlight **Start** and press **OK**.
Auto Gamma Calibration will start.
Please wait until you see "Auto Gamma Calibration has been completed." on screen.

To return to factory setting

- 1 Highlight **Reset** and press **OK**.

Automatic Format (Widescreen)

When this television receives a true Widescreen picture and **Auto Format** is **On**, it will automatically be displayed in Widescreen format irrespective of the television's previous setting.

- 1 Press  and **▲ / ▼** to highlight **Picture** icon.
- 2 Press **▶** and **▲ / ▼** to select **Display Settings** and press **OK**.
- 3 Press **▲ / ▼** to select **Auto Format** and press **OK**.
- 4 Press **▲ / ▼** to select **On** or **Off** and press **OK**.

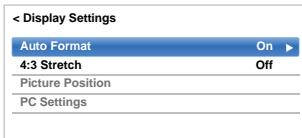

4:3 Stretch

When **4:3 Stretch** is activated, the size switching system changes 4:3 programmes into full screen picture.

- 1 In the **Display Settings** menu, press **▲ / ▼** to select **4:3 Stretch** and press **OK**.
- 2 Press **▲ / ▼** to select **On** or **Off** and press **OK**.

Picture Position

The picture position may be adjusted to suit personal preference and can be particularly useful for external inputs.

NOTE: The **Picture Position** feature cannot be selected on DTV or PC Inputs.

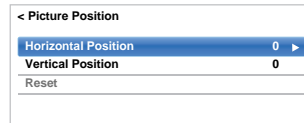

- 1 In the **Display Settings** menu, press **▲ / ▼** to select **Picture Position** and press **OK**.
- 2 Press **▲ / ▼** to select an option and press **◀ / ▶** to adjust the settings and press **OK**.
The options differ depending on the currently selected widescreen format and the input signal.



To return to the original factory settings, select **Reset** in the **Picture Position** menu and press **OK**.

Picture still

This feature is used to hold a still image on the screen.

- 1 Press  to hold an image on the screen, and press  again to cancel.

HDMI Information Display

When the **HDMI Information Display** feature is **On** and you are watching an HDMI input source, pressing  displays the HDMI signal information banner.

- 1 In the **Options** menu, press **▲ / ▼** to select **HDMI Information Display** and press **OK**.
- 2 Press **▲ / ▼** to select **On**.

HDMI signal information is as follows:
Resolution, Scan Type, Frame Rate, Aspect, Bit Depth, Colour Space, RGB/YUV, Chroma Format, and Content Type (if available).

Wireless LAN Information

Bluetooth™ and Wireless LAN devices operate within the same radio frequency range and may interfere with one another. If you use Bluetooth™ and Wireless LAN devices simultaneously, you may occasionally experience a less than optimal network performance or even lose your network connection.

If you should experience any such problem, immediately turn off either your Bluetooth™ or Wireless LAN device.

Actual performance can vary, including lower wireless network capacity, data throughput rate, range and coverage. Performance depends on many factors, conditions and variables, including distance from the access point, volume of network traffic, building materials and construction, operating system used, mix of wireless products used, interference and other adverse conditions.

Wireless LAN and your Health

Wireless LAN products, like other radio devices, emit radio frequency electromagnetic energy. The level of energy emitted by Wireless LAN devices, however, is far less than the electromagnetic energy emitted by wireless devices such as mobile phones.

Because Wireless LAN products operate within the guidelines found in radio frequency safety standards and recommendations, TOSHIBA believes Wireless LAN is safely used by consumers. These standards and recommendations reflect the consensus of the scientific community and result from deliberations of panels and committees of scientists who continually review and interpret the extensive research literature.

In some situations or environments, the use of Wireless LAN may be restricted by the proprietor of the building or responsible representatives of the organisation. Such restrictions may apply in environments where the risk of interference to other devices or services is perceived or identified as harmful.

If you are uncertain of the policy that applies to the use of wireless devices in a specific organisation or environment, you are encouraged to ask for authorization to use the Wireless LAN device prior to turning on the equipment.

When using the TV under wireless LAN environment:

NOTE:

- When Encryption is set to "None", data transmitted over a wireless LAN is not securely protected. Unauthorized users may access your data and network without appropriate security measures. Selecting an encryption setting from your Toshiba TV and using a secure network for wireless LAN transmissions may help avoid unauthorized access to your important data and/or TV. Toshiba disclaims any and all responsibility or liability resulting from any wireless transmissions over the Internet through your Toshiba TV.
- The function of all IEEE802.11 is not supported.
- The ad-hoc mode is not supported.
- It is recommended to use IEEE 802.11a or IEEE 802.11n on 5 GHz for audio and SD video streaming.

- It is recommended to use IEEE 802.11n on 5 GHz for HD video streaming.
- It is recommended that the encoding rate for streaming video content is 20 Mbps or less.
- It is not recommended to use 2.4 GHz for audio and video streaming.
- Content playback may be interrupted by various surrounding interference.

Europe Statement

This Built-in WLAN Module may be operated in below country:

AT	Austria	IS	Iceland
BE	Belgium	LI	Liechtenstein
CH	Switzerland	LT	Lithuania
CY	Cyprus	LU	Luxembourg
CZ	Czech Republic	LV	Latvia
DE	Germany	MT	Malta
DK	Denmark	NL	Netherlands
ES	Spain	NO	Norway
FI	Finland	PL	Poland
FR	France	PT	Portugal
GB	United Kingdom	SE	Sweden
GR	Greece	SI	Slovenia
EE	Estonia	SK	Slovakia
HU	Hungary	BG	Bulgaria
IT	Italy	RO	Romania
IE	Ireland	TR	Turkey



- If this device is going to be operated in the frequency range of 5.15 GHz to 5.35 GHz, it is restricted to indoor use.
- If this device is going to be operated for 802.11 b/g/n function in the frequency range of 2.454 GHz to 2.4835 GHz in France, it is restricted to indoor use.
- A general authorization is required for using this device outdoors or in public places in Italy.
- This device is NOT ALLOWED to be used in the geographical area within a radius of 20 km from the centre of Ny-Alesund in Norway.
- Make the wireless LAN appropriate security setting at the time of wireless LAN use to prevent the illegal use, spoofing and interception of communications.
- Don't connect wireless LAN to an outside network directly.
Apply the wireless LAN access point with router function or broadband router. Make the router appropriate security setting to prevent the illegal use.
Refer to the manual of router for a security setting.





Setting up the Network

You can select the Network Type.

1 Press  and  to highlight **Network** icon.

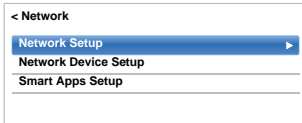
2 Press  and  to select **Network Setup** and press **OK**.



3 Press  to select **Connection Type** and press  and  to select **Wired** or **Wireless**.

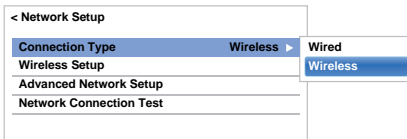

4 If you selected **Wired**, see "Advanced Network Setup" on page 47.

NOTE: After you change between **Wireless** and **Wired**, switch off and on AC power supply to reset your TV. Communication may be impossible after the change of **Wireless / Wired**.

Wireless Setup

NOTE: Continued connection of AP (Access Point) is not guaranteed. The connection may be disconnected while watching TV.

There are 3 methods for Wireless Setup Easy Setup (WPS)

If the AP supports WPS, this method can be used.

- WPS is an industry standard designed to make connection of wireless LAN equipment and security setup easy. WPS will automatically configure all wireless settings.



NOTE: WEP encryption may not be able to configured by easy setup.

Assisted Setup (setup by using the AP's notification information)



Network Name, Authentication, and Encryption are decided based on information from the AP. You will manually set the Security Key.

Manual Setup (manual input of all settings)



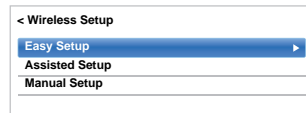



Easy Setup using PBC (Push Button Configuration)

- 1** In the **Network** menu, press  to select **Network Setup** and press **OK**.
- 2** Press  to select **Wireless Setup** and press **OK**.
- 3** Press  to select **Easy Setup** and press **OK**.



- 4** Press  and  to select **PBC**.
- 5** Press  to highlight **Start Scan** and press **OK**.
- 6** Following the on-screen instructions, push the appropriate button on your AP.
- 7** When a window reporting that the setup is complete appears, press **OK**.

Easy Setup using PIN (Personal Identification Number)

- 1** In the **Network** menu, press  to select **Network Setup** and press **OK**.
- 2** Press  to select **Wireless Setup** and press **OK**.
- 3** Press  to select **Easy Setup** and press **OK**.
- 4** Press  and  to select **PIN**.
- 5** Press  to select **Start Scan** and press **OK**.
- 6** Press  to select the desired AP and press **OK**.

NOTE: Check the Network Name and/or MAC address on the label of the AP or in the manual, and select your AP.

- 7** When the PIN code window appears, enter the displayed PIN into your AP, and then press **Next** to continue the PIN Setup. When a message displays to report that the setup is complete, press **OK**.

To cancel searching for the AP:

Press **BACK** while searching for the AP. A message will appear, and then press ◀/▶ to select **Yes** and press **OK**.

Assisted Setup

- 1 In the **Network** menu, press ▲ / ▼ to select **Network Setup** and press **OK**.
- 2 Press ▲ / ▼ to select **Wireless Setup** and press **OK**.
- 3 Press ▲ / ▼ to select **Assisted Setup** and press **OK**.

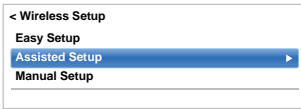

- 4 Press ▲ / ▼ to select the desired AP and press **OK**.

NOTE: Check the MAC address on the label of the AP or in the manual, and select your AP.

- 5 Highlight **Security Key** and press **OK**. The Software Keyboard window will appear.
- 6 Input the Security Key by using the Software Keyboard (see page 49). To save your setting, press the **GREEN** button.

NOTE:

- The Security Key must adhere to these conditions:
 - TKIP/AES: 8-63 ASCII or 64 Hex characters
 - WEP: 5 or 13 ASCII or 10 or 26 Hex characters
- There is only one key ID to set for WEP encryption.

- 7 Highlight **Done** and press **OK**.

NOTE: If **Network Name** is not displayed, see step 3 and 4 in **Manual Setup** to set **Network Name** before pressing **Done**.

NOTE: Settings are not saved if **BACK** is pressed before **Done** is selected.

Manual Setup

- 1 In the **Network** menu, press ▲ / ▼ to select **Network Setup** and press **OK**.
- 2 Press ▲ / ▼ to select **Wireless Setup** and press **OK**.
- 3 Press ▲ / ▼ to select **Manual Setup** and press **OK**.
- 4 Press ▲ / ▼ to select **Network Name** and press **OK**. The Software Keyboard window will appear.
- 5 Input the Network Name by using the Software Keyboard (see page 49). To save your setting, press the **GREEN** button.
- 6 Press ▲ / ▼ to select **Authentication** and press ▶ and ▲ / ▼ to select **Open System**, **Shared Key**, **WPA-PSK** or **WPA2-PSK**.
- 7 Press ▲ / ▼ to select **Encryption** and press ▶ and ▲ / ▼ to select **None**, **WEP**, **TKIP** or **AES**.

NOTE:

- Certain encryption types are only compatible with specific authentication types.
 - When Authentication is Open System, only WEP or None is compatible.
 - When Authentication is Shared Key, only WEP is compatible.
 - When Authentication is WPA-PSK or WPA2-PSK, only TKIP or AES is compatible.
- When incompatible Authentication/Encryption pairings are detected, a warning message will be displayed, and no connection attempt will be made until the incompatibility is resolved.
- There is only one key ID to set for WEP encryption.

- 8 Press ▲ / ▼ to select **Security Key** and press **OK**.
- 9 Input the Security Key by using the Software Keyboard (see page 49). To save your setting, press the **GREEN** button.

NOTE: This item is greyed out when **Encryption** is **None**.

- 10 Highlight **Done** and press **OK**.

NOTE: When **Encryption** is **None**, a message will appear. Press ◀/▶ to select **Yes** and press **OK**.

NOTE: Settings are not saved if **BACK** is pressed before **Done** is selected.

Wireless Information

The settings configured in Wireless Setup can be confirmed.

- 1 Press **QUICK** to open the **Quick Menu**.
- 2 Press **▲ / ▼** to select **Wireless Information** and press **OK**.

Quick Menu	
Intel® WiDi	
Picture Mode	Standard
Picture Size	Wide
3D Settings	
More Information	
Channel Options	
Sleep Timer	
HDMI CEC Device Control	
Speakers	TV Speakers
Headphone Level	30
Wireless Information	
Recording Information	

- 3 When the **Network Type** is **Wireless**, a Wireless Information window will appear.

NOTE: Press the **RED** button to scan for all APs.

Item	Description
Status	Connected is displayed when the TV is connected with the AP. Disconnected is displayed when the TV is not connected with the AP.
Signal	Connection signal strength with AP (STRONG/MEDIUM/WEAK)
Speed	Link with AP
Mode	Working mode (11a, 11b, 11g, 11n)
Network Name	SSID set
Authentication	Authentication set
Encryption	Encryption set
Security Key	Security Key set
AP MAC Address	The AP's MAC address is displayed when the TV is connected with the AP.
TV MAC Address	The MAC address of the TV(Wireless) is displayed.
DHCP	Enabled is displayed when using DHCP. Disabled is displayed when not using DHCP.
IP Address	The TV's IP address
Subnet Mask	Value of the Subnet Mask
Default Gateway	Address of the Default GATEWAY
DNS	Address of the DNS

NOTE: Even if an AP for IEEE 802.11n is used when **Encryption** is set to **WEP** or **TKIP**, the Speed value might be low. It is recommended that **Encryption** be changed to **AES** (see "Manual Setup" on page 45).

Notes on wireless LAN environment

- The function of all IEEE802.11 is not supported.
- The ad-hoc mode is not supported.
- It is recommended to use IEEE 802.11a or IEEE 802.11n on 5 GHz for audio and SD video streaming.
- It is recommended to use IEEE 802.11n on 5 GHz for HD video streaming.
- It is recommended that the encoding rate for streaming video content is 20 Mbps or less.
- It is not recommended to use 2.4 GHz for audio and video streaming.
- Content playback may be interrupted by various surrounding interference.

Advanced Network Setup

NOTE:

- When the DHCP function of the router connected with this TV is On, you can set **Auto Setup** to **On** or **Off**. (This should usually be set to **On**.)
- When the DHCP function of the router is Off, set **Auto Setup** to **Off**, and set the IP Address manually.

IP Address Setup

Auto Setup

- In the **Network** menu, press ▲ / ▼ to select **Network Setup** and press **OK**.
- Press ▲ / ▼ to select **Advanced Network Setup** and press **OK**.

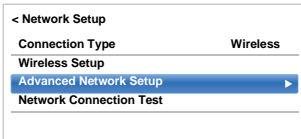

- Press ▲ / ▼ to select **IP Address Setup** and press **OK**.

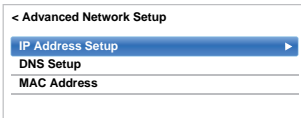

- Highlight **Auto Setup** and press ▶ and ▲ / ▼ to select **On**.

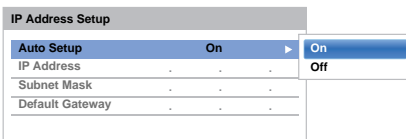

NOTE: Other items will be greyed out when **Auto Setup** is set to **On**.

Manual Setup

- In the **Network** menu, press ▲ / ▼ to select **Network Setup** and press **OK**.
- Press ▲ / ▼ to select **Advanced Network Setup** and press **OK**.
- Press ▲ / ▼ to select **IP Address Setup** and press **OK**.

- Highlight **Auto Setup** and press ▶ and ▲ / ▼ to select **Off**.

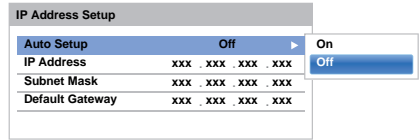

- Press ▲ / ▼ to select **IP Address**.
- Press ◀ / ▶ to highlight the field you want to change, and then use the number buttons to input the IP address. To save the setting, press **OK**.

NOTE: IP address field numbers must be between 0 and 255. After each field number has been set, press **OK** to store the entire address. If the entire IP Address is invalid, a warning message will appear after **OK** is pressed.

- Press ▲ / ▼ to select **Subnet Mask**, and edit in the same way as IP Address.

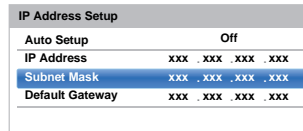

- Press ▲ / ▼ to select **Default Gateway**, and edit in the same way as IP Address.

NOTE: If you manually set the IP address, you must not use the same IP address for any other device. The IP address you use should be a private address.

DNS Setup

NOTE: When the DHCP function of the router connected to this TV is Off, set Auto Setup to Off, and manually set the DNS address(es). Your internet service provider should have provided these to you.

Auto setup

- 1 In the **Network** menu, press ▲ / ▼ to select **Network Setup** and press **OK**.
- 2 Press ▲ / ▼ to select **Advanced Network Setup** and press **OK**.
- 3 Press ▲ / ▼ to select **DNS Setup** and press **OK**.
- 4 Press ▲ / ▼ to highlight **Auto Setup** and press ► and ▲ / ▼ to select **On**.

NOTE: Other items will be greyed out when **Auto Setup** is set to **On**.

Manual setup

- 1 In the **Network** menu, press ▲ / ▼ to select **Network Setup** and press **OK**.
- 2 Press ▲ / ▼ to select **Advanced Network Setup** and press **OK**.
- 3 Press ▲ / ▼ to select **DNS Setup** and press **OK**.
- 4 Press ▲ / ▼ to select **Auto Setup** and press ► and ▲ / ▼ to select **Off**.

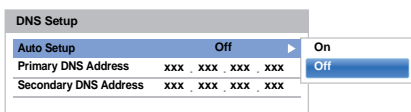

- 5 Press ▲ / ▼ to select **Primary DNS Address**.
- 6 Press ◀ / ▶ to highlight the field you want to change, and then use the number buttons to input the Primary DNS Address. To save the setting, press **OK**.

NOTE: DNS address field numbers must be between 0 and 255. If you input an incompatible number and press **OK**, the field number will reset to the maximum value(255).

- 7 Press ▲ / ▼ to select **Secondary DNS Address**, and edit in the same way as Primary DNS Address.

MAC Address

You can view the fixed MAC address for the TV (Wired and Wireless).

- 1 In the **Network** menu, press ▲ / ▼ to select **Network Setup** and press **OK**.
- 2 Press ▲ / ▼ to select **Advanced Network Setup** and press **OK**.
- 3 Press ▲ / ▼ to select **MAC Address** and press **OK**.

Network Connection Test

This function checks the Internet connectivity.

- 1 In the **Network** menu, press ▲ / ▼ to select **Network Setup** and press **OK**.
- 2 Press ▲ / ▼ to select **Network Connection Test** and press **OK**.

A message will appear to indicate if the connection was successful or if it could not be completed.

NOTE: The result of Network Connection Test does not always guarantee the connection.

To cancel the Network Connection Test:

- 1 Press **EXIT** while testing.

Using the software keyboard

You can enter text by using the Software Keyboard. The Software Keyboard window will appear when you press **OK** on a field that accepts character input.

To enter text using the software keyboard:

- 1 Highlight the desired character on the on-screen software keyboard.
- 2 Press **OK**.
- 3 Repeat steps 1 and 2 until you have entered all desired text.
- 4 Press the **GREEN** button to save your settings and return to the previous screen.

NOTE: If **BACK** is pressed, changes are not saved and the software keyboard window is closed. The text will remain as it was before starting the keyboard.

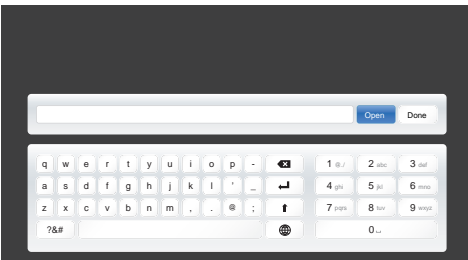

Input operation on the remote control:

Button	Description
OK	Inputs the selected character.
0-9	Selects a character for entry.
▲▼◀▶	Moves the character highlight.
RED	Deletes 1 character to the left of the cursor.
GREEN	Functions as "Done".
YELLOW	Functions as "Shift" key.
BLUE	Displays the help window.
BACK	Closes the Software Keyboard window without saving changes.

Network Device Setup

Apps Control Profile

Toshiba Apps allow you to control the TV from a network connected tablet or smartphone (availability is dependent on country).

In order to use this function, the **Setting up the Network** (see page 44) and **Device Name Setup** (see page 50) are required. The Device Name will display on the screen of Apps (tablet or smartphone) application.

New Device Detection

- 1 In the **Network** menu, press **▲ / ▼** to select **Network Device Setup** and press **OK**.
- 2 Press **▲ / ▼** to select **External Control Setup** and press **OK**.

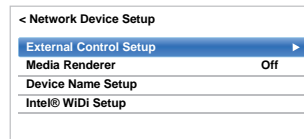

- 3 Press **▲ / ▼** to select **Apps Control Profile** and press **OK**.
- 4 Press **▲ / ▼** to select **New Device Detection** and press **▶** and **▲ / ▼** to select **Enabled**.



Pairing

To use Apps, it is necessary to connect a compatible tablet or smartphone and this TV to your home network, and carry out pairing (using a 4 or 8 digit password to authenticate the device).

Refer to the Apps manual for more details about pairing.

NOTE:

- Pairing with external devices cannot be carried out when the TV is connected to an unencrypted wireless LAN access point. Activate the encryption settings for the wireless LAN access point before carrying out Pairing.
- When the **Enable Control** is not set to **ON** in **External Control Setup**, Apps functions including Pairing cannot be used.

Device Registration Setup

Once a User Name has completed authentication, it is stored in the TV along with the password. The upper limit for the number of Use Names that can be remembered is 20. You can delete User Names that are stored in the TV.

- 1** In the **Network** menu, press ▲ / ▼ to select **Network Device Setup** and press **OK**.
- 2** Press ▲ / ▼ to select **External Control Setup** and press **OK**.
- 3** Press ▲ / ▼ to select **Apps Control Profile** and press **OK**.
- 4** Press ▲ / ▼ to select **Device Registration Setup** and press **OK**.
The **Device Registration Setup** screen will appear and the list of **Companion Device ID** managed by the TV will be displayed.
- 5** Press ▲ / ▼ to highlight the **Companion Device ID**.
- 6** Press ▲ / ▼ to select the **Cancel**, **All**, or **Delete** buttons and press **OK**.

NOTE: When re-registering a device which has been deleted from the list, registration must be carried out again.

TV Power On Control (Active Standby)

*When the TV is connected to the home network via Wireless LAN, with the **TV Power On Control** in **Enabled**, your TV can be turned on by control from Apps.*

- 1** In the **Options** menu, press ▲ / ▼ to select **Power Management** and press **OK**.
- 2** Press ▲ / ▼ to select **TV Power On Control** and press ► and ▲ / ▼ to select **Enabled** (Active Standby).

NOTE:

- Depending on the device connected to the home network, it may take a while for the TV to turn on.
- Depending on the device connected to the home network, this feature may not work.
- If the unencrypted Wireless Setup is done, this feature can not be used.
- The power consumption during Active Standby is more than it during Normal Standby.
- After the change from Power On state to Active Standby, there may be a period of several ten seconds which does not receive the operation from a remote control or external apparatus.

Media Renderer Setup

The TV can be configured as a media renderer. When operating as a media renderer, the TV displays content provided by a media server. The selection of the media is done by media controller. The TV can play photo, movie, or audio files when operating as a media renderer.

- 1** In the **Network** menu, press ▲ / ▼ to select **Network Device Setup** and press **OK**.
- 2** Press ▲ / ▼ to select **Media Renderer** and press ► and ▲ / ▼ to select **On**.

If request comes from media controller, prompt will appear and the Media Renderer function will start.

To exit the Media Renderer:

Press **EXIT**.

Terminology

DMS: Digital Media Server

DMR: Digital Media Renderer

DMC: Digital Media Controller

NOTE: You cannot use 3D function in operating as a media renderer.

Device Name Setup

The TV's device name can be changed.

- 1** In the **Network** menu, press ▲ / ▼ to select **Network Device Setup** and press **OK**.
- 2** Press ▲ / ▼ to select **Device Name Setup** and press **OK**.
The Device Name Setup screen will appear.
- 3** Press ▲ / ▼ to select **Device Name** and press **OK**. The Software Keyboard window will appear.
- 4** Input the Device Name by using the software keyboard (see page 49). To save your setting, press the **GREEN** button.

NOTE:

- The Device Name can be up to 15 characters long.
- Only the 0-9, - and A-Z (uppercase only) characters may be used for the device name.

- 5** Press ▼ to highlight **Done** and press **OK** to save your setting.

USB HDD Record Function

This function can be used to record and play digital broadcast programmes (function is dependant on country selection). Read the precautions below before recording or viewing programmes using the USB HDD record function.

NOTE:

- In order to use this function, a USB HDD needs to be connected to the TV. Do not use USB Hub.
- After recording operation, time may take to a recording start.
- Recorded programmes saved on the USB HDD can only be viewed on this TV. They cannot be viewed when connected to another TV (including the same model of TV), a PC, or other device.
- You cannot watch other channel while recording one channel.
- If the recording time to the USB HDD is too short, no data may be saved.
- You cannot record video input signals on the USB HDD.
- Not all types of broadcast may be recordable.
- After programming the TV to record digital broadcasting, do not disconnect the power plug before recording starts.
- Should video or audio recording fail due to malfunction of the TV or poor reception, no compensation would be paid.
- If there is a power failure or the power plug is disconnected during programmed recording, recording will stop and will not resume when the power returns or the plug is reconnected.
- Do not disconnect the power plug when the indicator LED is lit.
- Any changes implemented by the broadcasting station may affect programme scheduling.
- Scheduling of multiple consecutive programmes may result in the beginning of each programme not being recorded.
- Accurate start / finish time for recording is reliant on broadcasters maintaining correct time stamp if this not the case the recording will fail.
- Some broadcasters can control whether a program can be recorded or how long you may be able to view it for after recording. The on screen message "Retention limit expired" means that the time limit for viewing the program has lapsed.
- Programmed recording cannot take place if the power plug is not connected.
- Disconnecting the power plug during recording may result in failure to save the recorded programme.
- USB HDD recording feature is not available in all countries.
- When the USB HDD is formatted, all the data stored on the HDD will be erased.

Setting up the USB HDD for recording

To connect a USB HDD (not supplied):

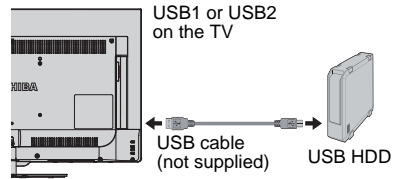

When you connect a USB HDD to the USB port on the TV, a prompt will appear.

- 1 Press ◀/▶ to select **No** and press **OK**.

NOTE: Not guaranteed to work with all USB HDD.

To record DTV programmes (One Touch Recording)

To record the programme currently being viewed.

- 1 Press the ●**REC** button on the remote control. The currently viewed programme will start to be recorded.

To stop recording:

- 1 Press the ■ (stop) button. A confirmation window "Do you want to stop Recording?" will appear.
- 2 Press ◀/▶ to select **Yes** and press **OK**. Recording will stop.

How to set recordings via the Programme Guide

Programmed recording can be scheduled easily using the Programme Guide or by specifying the date and time.

PLEASE NOTE

When a timed programme is about to start, an information screen will appear offering the option of watching or cancelling the programme. Other channels will not be available during the timed programme unless the programme timer is cancelled.

It will only be possible to create or edit programme timers for the currently tuned DTV input.

Using the Programme Guide to set future recordings

- 1 Press **GUIDE** on the remote control to display the Electronic Programme Guide (EPG).
- 2 Press **▲▼◀▶** to highlight the programme you want to record and press **OK**.
- 3 The **Edit Timer** screen will appear. Press **▲ / ▼** to select **Timer Type**.



- 4 Press **▶** and **▲ / ▼** to select **Recording** and press **OK**.
- 5 Press **▲ / ▼** to highlight **Set Timer** and press **OK**.

To search for and record a programme using Genre Search:

- 1 Press the **YELLOW** button on the remote control to access the **Genre Search** screen.

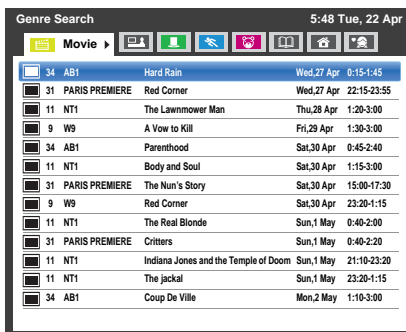

- 2 Press **◀ / ▶** to select the genre. Programmes listed will change for the new genre. Press **▲ / ▼** to select the programme for which you want to schedule recording.
- 3 Press **OK**. The **Edit Timer** screen will appear. Press **▲ / ▼** to select **Timer Type**.

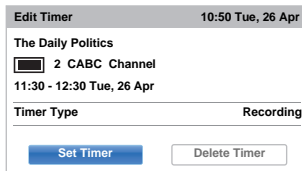

- 4 Press **▶** and **▲ / ▼** to select **Recording** and press **OK**.
- 5 Press **▲ / ▼** to highlight **Set Timer** and press **OK**.

To programme the timer:

- 1 Press the **BLUE** button on the remote control.
- 2 Select the unprogrammed column (blank column) and press **OK**.
The **Edit Timer** screen will appear.
Press **▲ / ▼** to select **Timer Type**.

- 3 Press **▶** and **▲ / ▼** to select **Recording** and press **OK**.
- 4 Press **▲ / ▼** to go through the list adding the details of the programme by using the number buttons and **◀ / ▶** to make selections.
 - **Channel**
Select the channel you wish to record.
 - **Date**
Select the date that you wish recording to start.
 - **Start Time**
Select the time to start recording.
 - **End Time**
Select the time to end recording.
 - **Repeat**
Select "**Once**", "**Daily**" or "**Weekly**".

Once	The selected content is recorded once.
Daily	The same time slot on the same channel is recorded every day on and after the selected day.
Weekly	The same time slot on the same channel on the same day of the week is recorded on and after the selected day.

- 5 Press **▲ / ▼** to highlight **Set Timer** and press **OK**.

To schedule a programme using the information screen:

- 1 Press **(i+)**, the information screen will appear giving details of the channel and programme currently being viewed.

- 2 Press **▲ / ▼** to select **Next** and press **OK**. The **Edit Timer** menu will appear.
Press **▲ / ▼** to select **Timer Type**.

- 3 Press **▶** and **▲ / ▼** to select **Recording** and press **OK**.
- 4 Press **▲ / ▼** to highlight **Set Timer** and press **OK**.

To check, edit or delete scheduling information

You can check, edit or delete scheduling information.

- 1 Press **GUIDE** and then press the **BLUE** button. **Programme Timers** screen will appear.

Recording List

- Depending on the transmitter information, the programme broadcast time or other information may not be correctly displayed in the recording list.
- The programme does not appear in the recording list immediately at the start of recording, but appears a few minutes after recording starts.
- Up to 64 programmes can be displayed in the recording list.
- If the channel settings are changed, the digital channel number, or other information may not appear correctly in the recording list.
- As the displayed programme time is calculated from the actual recording information, it may not match the recording time on the USB HDD.

To check a schedule:

- 1 Press **▲** / **▼** on the **Programme Timers** screen to check the schedule.

To edit a schedule:

- 1 Press **▲** / **▼** on the **Programme Timers** screen to select the title whose schedule you want to edit and press **OK**.

The **Edit Timer** screen will appear. Change the settings as required, following the same procedure as for setting the schedule.

- 2 Press **▲** / **▼** to highlight **Set Timer** and press **OK**.

To delete a schedule:

- 1 Press **▲** / **▼** on the **Programme Timers** screen to select the title whose schedule you want to delete.
- 2 Press the **RED** button. Press **◀** / **▶** in the displayed confirmation window to select **Yes** and press **OK**. The selected schedule will be deleted.

NOTE: You can also delete a schedule by selecting **Delete Timer** from the **Edit Timer** menu for each programming method.

To view a recorded programme

To view the recorded **Library** screen and select a title from the recorded programme list.

- 1 Press **⏏** and highlight **My Recordings** icon and press **OK**. The **Library** screen will appear.



- 2 Press **▲** / **▼** to select the title you want to view. A preview of the content selected can be seen on the preview screen.

To change the order in which the titles are listed, press the **BLUE** button.

- 3 Press **OK**. Viewing starts.
 - icon appears next to the title currently being recorded.
 When the title currently being recorded is selected and **OK** is pressed, playback will start from the beginning of the programme currently being recorded.

Operations during viewing

The following operations can be performed using the remote control buttons.

▶	To PLAY	▶▶	To FAST FORWARD
■	To STOP	▶▶	To SKIP-FORWARD
 	To PAUSE/STEP	◀▶	To shift playback position
◀◀	To SKIP-BACK		
◀◀	To REWIND		

Operations from the Library screen

As well as viewing the list of recorded titles on the **Library** screen, you can protect or delete titles and register titles to *Personal Mode*.

To display the Library screen:

- 1 Press **LIBRARY** and highlight **My Recordings** icon and press **OK**. The **Library** screen will appear.

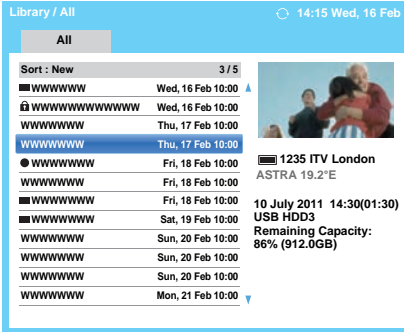

To protect or unprotect a recorded programme:

Protecting a programme prevents it from being accidentally deleted.

Select the title of the programme you want to protect and press the **GREEN** button. A **LOCK** icon appears next to the title and the programme is protected.

If Protect is set to **On** when the programme is recorded, a **LOCK** icon appears next to the title of the recorded programme.

When a title with a **LOCK** icon is selected and the **GREEN** button is pressed, the **LOCK** icon disappears and the programme is unprotected.

To group the recorded programmes

- 1 Press the **YELLOW** button. A grouping mode window will appear.

Week: Grouping the recorded programme by the day (Sunday - Saturday)

Genre: Grouping the recorded programme by the genre.

To change the title of recorded programme

- 1 Press **QUICK** when the Library screen is displayed.
- 2 Press **DOWN** to select **Title Edit** and press **OK**. The **Software Keyboard** window will appear.
- 3 Input your desired title by using the software keyboard (see page 49). Press the **GREEN** button to save your settings.

To delete a recorded programme:

- 1 Press the **RED** button. Check boxes will appear next to the titles.
- 2 Press **UP** / **DOWN** to select the title you want to delete and press **OK**. A check mark will be inserted in the check box.

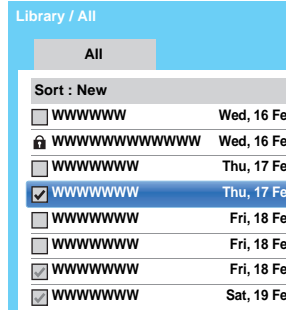

To insert a check mark against all the titles, press the **YELLOW** button.

To uncheck all the check boxes, press the **BLUE** button.

NOTE:

- A check mark will not be inserted against protected titles.
- Note that once deleted, a title cannot be restored.

- 3 Press the **RED** button. Select **Yes** in the confirmation window and press **OK**.

All the titles with check marks will be deleted.

USB HDD capacity

You can check the remaining capacity of the USB HDD using **Remaining Capacity**.

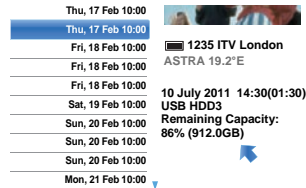

NOTE: The remaining capacity displayed is only a guide; it is not guaranteed.

Recording Setup

You can set your preferences for recording.

To select USB HDD and Partition for Recording:

- 1 Press  and ▲ / ▼ to highlight **Options** icon.
- 2 Press ► and ▲ / ▼ to select **Recording Setup** and press **OK**.
- 3 Press ▲ / ▼ to select **Select Device** and press **OK**. USB HDD and Partition list will be appear. If USB HDD is partitioned by PC, several partitions will be displayed.

< Recording Setup	
Select Device	►
One Touch Recording Time	120 Minutes
TimeShift Size	4GB
Start Padding Time	None
End Padding Time	None
Device Test	
Format Device	

- 4 Select USB HDD and Partition you want to recording.

To set the recording time for One Touch Recording:

- 1 Press  and ▲ / ▼ to highlight **Options** icon.
- 2 Press ► and ▲ / ▼ to select **Recording Setup** and press **OK**.
- 3 Press ▲ / ▼ to select **One Touch Recording Time** and press ► and ▲ / ▼ to select the recording time.

< Recording Setup	
Select Device	
One Touch Recording Time	120 Minutes ►
TimeShift Size	4GB
Start Padding Time	None
End Padding Time	None
Device Test	
Format Device	

Programme End Time	
30 Minutes	
60 Minutes	
90 Minutes	
120 Minutes	
150 Minutes	
180 Minutes	
210 Minutes	
240 Minutes	
270 Minutes	
300 Minutes	
330 Minutes	

You can set the **Programme End Time** in 30-minute increments in the range of 30 minutes to 330 minutes.

To select the TimeShift Size:

- 1 In the **Recording Setup** screen, press ▲ / ▼ to select **TimeShift Size**.
- 2 Press ► and ▲ / ▼ to select **512 MB, 1 GB, 2 GB or 4 GB** and press **OK**.

To use TimeShift recording:

Time Shift recording allows you to pause live TV for a fixed period of time.

For Example: If you move away from the TV for a short period, such as when the phone rings while you are watching TV, you can easily pause live TV and then continue to view from the same point in the programme when you return.

- 1 Press **II** on the remote control while viewing the DTV programme.
The screen will switch to a still image and recording will start automatically.
The recording time is decided by **TimeShift Size**. If the TimeShift file size reaches the limit set, then the TV will continue to be paused, but the recording buffer will be reset to the beginning.
- 2 Press ► (play).
Catch-up viewing will start from where the programme was paused.
- 3 Press **■** (stop) to stop the recording.

To set the padding time for programmed recording start time and end time:

- 1 In the **Recording Setup** screen, press ▲ / ▼ to select **Start Padding Time**.

- 2 Press ◀ / ▶ to select a time.

You can select from **None, 3 Minutes, 5 Minutes, 10 Minutes, 15 Minutes, 30 Minutes, and 45 Minutes**.

Recording will start at the selected number of minutes prior to the recording start time.

- 3 Press ▲ / ▼ to select **End Padding Time**.

- 4 Press ◀ / ▶ to select a time.

You can select from **None, 3 minutes, 5 minutes, 10 minutes, 15 minutes, 30 minutes, and 45 minutes**.

Recording will end at the recording end time plus the selected number of minutes.

To perform a USB HDD operation test:

- 1 In the **Recording Setup** screen, press ▲ / ▼ to select **Device Test** and press **OK**.

USB HDD operation test will start.
Wait until the test ends.

NOTE: The results of the device test are only a guide. The device may not function as shown in the results.

To format a USB HDD:

- 1 In the **Recording Setup** screen, press ▲ / ▼ to select **Format Device** and press **OK**.
- 2 Press ◀ / ▶ to select **Yes** in the confirmation window that will appear and press **OK**. Formatting will start.
Wait until formatting ends.

NOTE:

- If the USB HDD is separated several partitions by PC and multiple Partition appear on the **Device List** screen, press ▲ / ▼ to select the Partition you want to format.
- When the USB HDD (or Partition) is formatted, all the data stored on the USB HDD (or Partition) will be deleted.

Scheduling priority

If scheduled time slots are next to each other and there is more than one minute between the end time of the first schedule and the start time of the next schedule, programmed recording will be performed correctly.

- When **Start Padding Time** and **End Padding Time** are set (see page 56), the start time and end time will be the time plus the additional minutes.

If scheduling times overlap, priority will be given to the programmed recording which starts first. When the programmed recording that started first ends, recording will switch to the next scheduled programme. At this time, depending on how far the scheduling times overlap, the beginning section of the next scheduled programme may not be recorded.

Using the Cloud TV Service

Toshiba's universal portal for internet content and services (services are dependent on country).

NOTE: You need to configure a home network before using this feature (see page 12).

- 1 Press .
The menu screen of the Cloud TV service will appear.
- 2 Press ▲▼◀▶ to select a Cloud TV service, and press **OK**.
For the operations of the Cloud TV service, refer to Cloud Guide.

Using Web Browser

The web browser on this TV lets you explore everything the web has to offer. Along with access to popular places, you'll be able to search for and browse your favourite sites.

NOTE:

- Certain services may not be currently available in your area.
- Your registration or login may be required to use some services.
- Third party internet services are not provided by Toshiba, may change or be discontinued at any time and may be subject to Internet service provider restrictions. Toshiba makes no warranties, representations, or assurances about the content, availability or functionality of third-party content or services. Use of third party Internet services may require the creation of a separate account through a computer with Internet access and/or payment of one-time and/or recurring charges and membership.
Not all third party services may be available on or compatible with this product. In order to experience the full suggested capabilities of this product, fully-compatible devices may be required.
 - does not support platform-dependent technologies such as Active X.
 - only supports preinstalled plug-ins.
 - may not support media formats other than the following: JPEG/PNG/GIF.
 - uses a single built-in font. Some text may not be displayed as intended.
 - does not support downloading of files or fonts.
 - is a TV browser. It may work differently than PC browsers.
 - does not support parental control or locks in the content, and it is the responsibility of the you to monitor browser usage by minors.
- Some pages may not be displayed correctly or may display differently on different devices.
- Certain services may not be available in your area.

To use the web browser

NOTE: You can change the mouse mode (Mouse Emulation or Navigation) by pressing the **GREEN** button on the remote control when the web contents screen is open.

- 1** Press **[I]** on the remote control and select Internet icon to open the web browser.
- 2** Press **▲▼◀▶** to select the URL address bar and press **OK**.
- 3** Enter the desired URL address by using the Software Keyboard (page 49).
Press the **GREEN** button on the remote control.
- 4** You can now browse websites on your TV using **▲▼◀▶** buttons on the remote control.

To Add Favourites Websites

By adding frequently visited websites to Favourites, you can browse them easily. You can view the addresses of the websites you visited previously.

- 1** Press **[I]** on the remote control and select Internet icon to open the web browser.
- 2** Enter the desired URL address by using the Software Keyboard (page 49).
- 3** Press **▲▼◀▶** to scroll Favourites STAR on the Toolbar and press **OK**.
- 4** Press **OK** to save the desired website to your Favourites.
- 5** Press **BACK** on the remote to return to browsing your website.
You can press the **GREEN** button on the remote for thumbnail view of all your Favourites.

NOTE: The desired website is highlighted and displayed on the top row with the + icon. The + icon will change to a page icon after the website has been saved to Favourites.

To browse favourite websites

- 1** Press **[I]** on the remote control and select Internet icon to open the web browser.
- 2** Use **▲▼◀▶** to select Favourites STAR and press **OK**.
- 3** Select the item or folders to move to the desired URL address and press **OK**.
- 4** You can now browse websites on your TV using **▲▼◀▶** on the remote control.

PIP (Picture-in-picture) function

When viewing the web browser page, currently airing programmes or images from external inputs can be displayed in a PIP window (sub-screen).

- 1** Press the **RED** button while viewing the web browser page.
The currently airing program or images from external inputs are displayed in a PIP window.

NOTE:

- The position of the PIP window, and whether it is displayed or not can be set in the web browser settings.
- **P^** and **Pv** buttons cannot be used when the PIP window is displayed.
- Images in the PIP window cannot be displayed in 3D.
- Images from 3D signals will not be displayed in the PIP window.

To stop displaying the PIP window:

Press the **RED** button when the PIP window is displayed.

Using Skype

Skype-ready Toshiba TVs bring your family and friends closer to your home. Skype on your Toshiba TV allows you to share special moments no matter the distance.

Before using Skype - Preparation

- Connect the FREETALK HD Camera: TALK-7291 to the TV's USB terminal. Do not use a USB hub. For a Skype-ready Toshiba TV compatible camera, please visit the following website: <http://shop.skype.com>
- Arrange the HD camera on top of the TV, ensuring it's in the centre.
- Connect to the network.

NOTE:

- The HD camera is sold separately.
- Do not connect a camera other than the recommended HD camera.
- Using a wireless network may result in degraded call quality.
- Some of the features available on other versions of Skype are not available on the television.
- When using Skype, some functions of the TV will not be available.
- The sound settings are switched to Skype mode.
- If you cannot hear the person you're speaking with, check your TV volume.
- When Optical Digital output or Analogue output is used and you are signed in, the ring tone may not sound.
- The volume level on Skype may differ from other features on your TV.
- When the Reset TV feature is used from the TV Menu, Skype information is reset to factory default settings.
- Screenshots used in this manual may differ from the TV Menu, Skype will be reset to its factory default settings.



No emergency calls with Skype

Skype cannot be used for emergency calls.

Getting started

- 1 Press on the remote control.
- 2 Press to select **Skype** icon and press **OK**.
"Welcome to Skype" screen appears.

You can select a Skype name from the Skype Name drop down menu.

- 3 Select **Sign in** or **Create Account**.

To create a new account:

If you do not already have a Skype account, you can create a new one from your TV.

- 1 Select **Create Account** in the **Welcome to Skype** screen and press **OK**.

2 Enter your **Full Name, Skype Name, Password, Repeat password, and Email.**

- If you want to receive Skype news and special offers, check the selection box. Skype will inform users about new products, features and special offers by email.

3 Select **"I agree - create an account"** and press **OK.**

4 You'll now be signed into your new account.

NOTE:

- Please ensure that you have entered your email address correctly. It is required in case you lose or forget your password.
- If you forget your password, visit skype.com to retrieve it.
- If a message appears informing you that the entered Skype name is already registered, please choose a different name.

To Sign into Skype:

If you have a Skype account, sign into Skype in the **Welcome to Skype** screen.

1 Enter your **Skype Name** and **Password.**

2 Select **Sign in** and press **OK.**

- If **"Sign in when Skype starts"** is checked, your account will sign in automatically when you launch Skype from the menu.
 - If **"Start Skype when TV starts"** is checked, your account will sign in automatically when you turn on the TV.
- Both these options can be selected together.

Basic Operation

Press **▲ / ▼** to select a tab (Contacts/People, Recent, Settings). Press **▶** and **▲ / ▼** to select a contact from the list.

Your contact list will contain the following information: Contact name / Current online status / Profile picture / Mood message

Your profile picture, status, Skype Name, mood message and available Skype Credit.

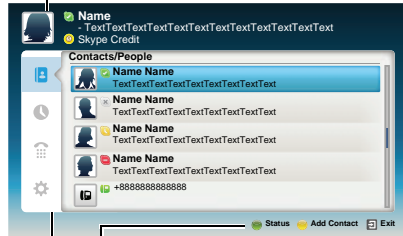

- Status:** Change your availability status
- Add Contact:** Add a Skype account or phone number
- EXIT:** Return to previous screen. When at contact list, the **EXIT** button will close Skype application without sign out.

The current status for each of your contacts are explained below:

- : Online
- : Offline
- : Do not disturb
- : Away
- : Phone number
- : Offline with voice messaging or call forwarding enabled

Contacts/People

Press **▲ / ▼** to select **Contacts/People** tab. Press **▶** and **▲ / ▼** to select a contact.

When pressing **OK** at each contact, the following functions will appear:



**Initiate Video Call
Initiate Voice Call**

- View Profile** - View contact profile (including Skype name, full name, birth date, gender, location, mobile number and email).
- Send Voice Message** - Send Voice Message to contact
- Block** - Block / unblock contact
- Remove** - Remove contact from list

Video or Voice call

Press **▲▼◀▶** to select **Video call** or **Voice call**, your screen will now display your call as shown below.

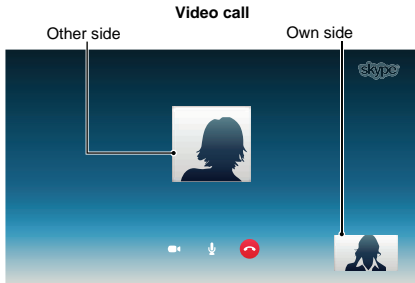

Voice call

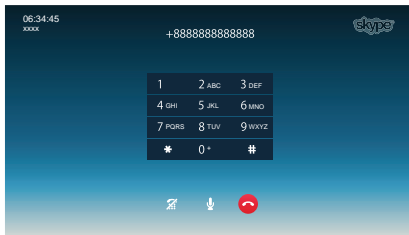

Below is all icon pictures in conversation window.

- Start video
- Stop video
- Resume the call
- Unmute the webcam mic
- Mute the webcam mic
- Normal size video
- Full screen video
- Open dial pad
- End call (Hang up the call)

Group calls

Using your Toshiba TV, you can join Skype group voice and video calls. However, you can only send and receive audio whilst on these calls.

NOTE: You must be invited on to a group call, you cannot initiate it from the TV.

Incoming call

Incoming calls on Skype will be displayed on the bottom right hand corner of your TV screen. You'll also hear a ring tone which can be adjusted using the **VOLUME** buttons on your remote control.

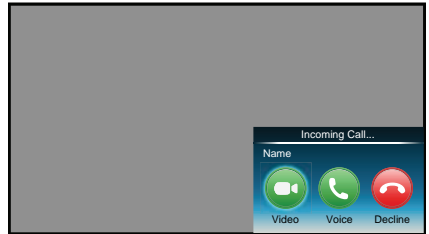

You are given three options when an incoming call arrives:

- **Video** : Answer by video call.
- **Voice** : Answer by voice call.
- **Decline**: Decline the incoming call.

NOTE: If other applications are active or recording, you'll only get an "Incoming call notification" until the application or recording has stopped.

Status

When you press the **GREEN** button, the change status window will appear as below. You can change your status by pressing **▲/▼** and **OK**. Press **BACK** to exit.

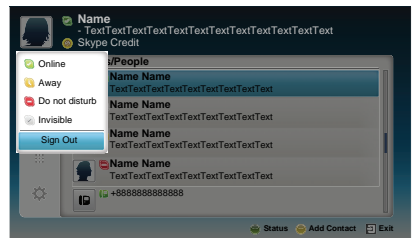

Add Contact

You can add contacts to your list of contacts.

When you press the **YELLOW** button, the **Add Contact Type** menu window will appear.

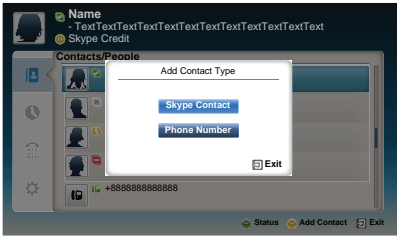

Two sub-functions are supported.

Press ▲ / ▼ to select **Skype Contact** or **Phone Number** and press **OK**.

- **Skype Contact**

Enter the Skype Name of the person you're looking for. The search result will show up after get response from Skype server.

- **Phone Number**

You can also enter a phone number in the search window.

Contact Search Results



You can send a contact request to a person displayed in the search results. Press ▲ / ▼ to select a person and press **OK**.

Notification of authorization request

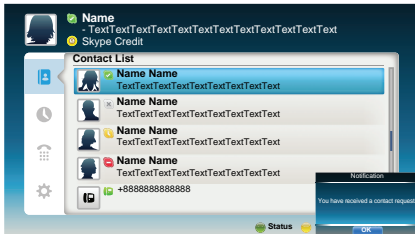

When you receive a contact request, a pop-up menu will appear where you can choose to **Accept**, **Block** or **Decline** the request.

Press ▲ / ▼ to select and press **OK**.

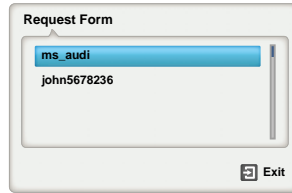

Press ◀ / ▶ button to select and press **OK**.

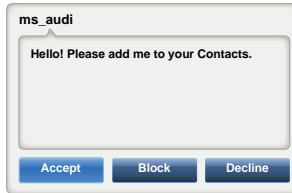

Recent

You can see a list of past events in "Recent".

Press ▲ / ▼ to select the **Recent** tab. Press ▶ and ▲ / ▼ to select an item and press **OK**.

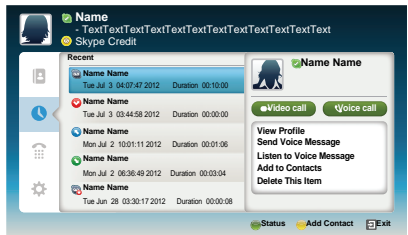

Press ◀ / ▶ to select **Video call** or **Voice call**.

Each call has an icon with it. The meaning of each icon is as follows:

Icons	Description
	Incoming call
	Outgoing call
	Missed call
	Unread Voice Message
	Voice message

Dialer

You can call mobiles and landlines from this screen.

Press ▲ / ▼ to select the **Dialer** tab. Press ► and ▲ / ▼ to navigate this screen.

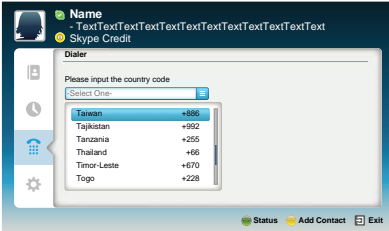

Select the country or region first, and then enter the phone number with area code. You'll need a little Skype Credit in your account to call mobiles or landlines using Skype. Emergency calls over Skype are not supported.

Settings

Press ▲ / ▼ to select the **Settings** tab and press **OK**.

The Settings window will appear.



You can change the following settings:

- **User Profile**

Add or change your personal information e.g. birth date, country/region or phone number.

- **Change Password**

You can change your password by entering your existing password and new password twice.

- **General Settings**

Select whether Skype should automatically start when turning on the TV.

- **Audio Settings**

Adjust the speaker / ringtone volume manually.

The volume of your speakers will be different on Skype compared to your normal TV volume level. The speaker volume range is 0 - 100 % by 1 steps, and ringtone volume is 0 - 100 % by 25 steps.

- **Privacy Settings**

Set who you allow calls from, whether it's Anyone or People in my Contact list only.

- **Blocked Contacts**

If you do not want someone to reach you, simply block them by entering their Skype Name or phone number from this menu. Successfully blocked contacts are displayed in this window.

- **Call Settings**

If you're not signed into Skype, you can forward incoming calls to another phone number or Skype name, or choose to accept voice messages. However you'll need to have Skype Credit to turn this feature on.

- **About Skype**

Displays information about Skype.

Using Hybrid TV Standard (if available)

Hybrid TV Standard enables the TV to receive HbbTV services. TV services which support this feature often show “press RED” on the screen.

NOTE: You need to configure a home network before using this feature (see page 12).

- 1** Press  and **▲ / ▼** to highlight **Options** icon.
- 2** Press **▶** and **▲ / ▼** to select **Hybrid TV Standard**.
- 3** Press **▶** and **▲ / ▼** to change from **Disabled** to **Enabled** and press **OK**.

When “**press RED**” is indicated on the screen, press the **RED** button to access HbbTV service site, and then press **▲▼◀▶** to select the desired contents.

NOTE:

- The HbbTV service indication or required key operations may not be possible depending on the service contents. In this case set the **Hybrid TV Standard** setting to **Disabled**.
- Toshiba makes no warranties, representations, or assurances about the content.

Using Intel® Wireless Display

Intel® Wireless Display (Intel® WiDi) is supported on this TV. You can use your TV as second display for PC with Intel® Wireless Display.

- 1** Press **QUICK** to open the **Quick Menu**.
- 2** Press **▲ / ▼** to select **Intel® WiDi** and press **OK**.
A prompt will appear on the screen. Select **Yes**.
- 3** Launch the Intel® WiDi software on your PC and select “scan for available adaptors”.
Intel® WiDi device name and ID list will then be displayed on the PC screen.
Select the TV which you wish to connect to.
“Connecting” will be shown on the TV.
- 4** **Connecting your PC to your TV the first time**

When selecting the Toshiba TV for the first time, a 4-digit or 8-digit code will appear on your TV screen. This code needs to be inputted into your computer to authenticate the connection.

If authentication has already taken place

“Connected to Intel® WiDi. Please Wait” will appear on screen.

- 5** After the Intel® WiDi connection is complete, the TV screen will mirror the content shown on the PC screen.

NOTE:

- When connecting Intel® WiDi, PC must have power turned on.
- When the Intel® WiDi software is active, and the Connection Type is set to Wireless, other applications may not be usable.
- Intel® WiDi device name of the TV can be changed from the Intel® WiDi software.

To exit Intel® WiDi:

Exit Intel® WiDi by pushing the disconnect button on Intel® WiDi software or by pressing **EXIT** on the TV remote control.

NOTE: If the PC has been inactive for some time, the Intel® WiDi connection will be disconnected automatically.

Intel® WiDi Device Name

The TV's Intel® WiDi device name can be changed.

- 1** In the **Network** menu, press **▲ / ▼** to select **Network Device Setup** and press **OK**.
- 2** Press **▲ / ▼** to select **Intel® WiDi Setup** and press **OK**.
- 3** Press **▲ / ▼** to select **Intel® WiDi Device Name** and press **OK**.
- 4** Select **Intel® WiDi Device Name** and press **OK**. The Software Keyboard window will appear.
- 5** Input the Intel® WiDi device name by using the software keyboard (see page 49). Press the **GREEN** button.
- 6** Highlight **Done** and press **OK** to save your setting.

Device List

Device List displays a list of MAC addresses for previously connected device that have been connected before. The maximum number that can be stored is 20.

If the list run out of space, the least-recently-used MAC address will be deleted and the new MAC address added automatically.

- 1** In the **Intel® WiDi Setup** screen, highlight the **Device List** and press **OK**. Device List will appear.

The registered MAC Address can be deleted one by one by pressing **RED** key in the List.

When doing so the following text can be seen "Do you want to unregister this device? Yes/No" (default cursor is "No").

Using the Media Player

This TV allows you to enjoy movie, music and photo files stored on a USB device connected to the USB port.

Moreover, you can also play photos, movies or music files from your PC by connecting the TV to your home network.

Terminology:

DMP: Digital Media Player

DMS: Digital Media Server

DMR: Digital Media Renderer

DMC: Digital Media Controller

- DMP: The TV can control and play content from a DMS.
 - A DMS is a device that can function as a server for DMP or DMR.
- DMR: The TV can play content from a DMS. Playback is controlled by a DMC.
 - A DMC is a device that can instruct the TV to play content.

NOTE:

- Do not insert/remove USB device while in use.
- MENU is not available during playback.
- When you want to use your TV as a media renderer, set **Media Renderer to On** (see "Media Renderer Setup" on page 50).

Media Player Specifications

Device

USB device

Interface version: USB2.0 HS

USB Mass Storage Class devices (MSC)

NOTE:

- Connectivity is not guaranteed for all devices.
- Incorrect behaviour may occur with a USB hub connection.

File system: FAT16 and FAT32

Maximum memory size: Depend on file system

You must obtain any required permission from copyright owners to download or use copyrighted content. TOSHIBA cannot and does not grant such permission.

Basic operation

Using Media Player with USB

When **Auto Start** is enabled, you will be asked if you want to start the Media Player whenever a USB device is inserted. If **Auto Start** is disabled (or if you want to connect to a media server on the network), you must manually start the Media Player from the menu.

To change the Auto Start setting:

- 1 Press  and **▲** / **▼** to highlight **Options** icon.
- 2 Press **▶** and **▲** / **▼** to select **Media Player Setup** and press **OK**.
- 3 Press **▲** / **▼** to select **USB Auto Start** and press **OK**.
- 4 Press **▲** / **▼** to select **On** or **Off**.

Auto Start

- 1 Insert a USB device into the USB port on the left side of the TV. A prompt will appear.
- 2 Press **◀** / **▶** to select **Yes** and press **OK**.
- 3 Press **▲** / **▼** to select **Videos**, **Music** or **Photos** and press **OK**.
- 4 Press **▲▼◀▶** to select **Devices** and press **OK**.
- 5 Press **▲** / **▼** to select a device and press **OK**.

NOTE: If **Auto Start** is set to **Off**, you can start the Media Player manually.

Manual Start

- 1 Insert a USB device into the USB port on the left side of the TV.
- 2 Press  and select **My Music**, **My Videos**, **My Photos** or **My Contents** icon and press **OK**.
- 3 Press **▲▼◀▶** to select **Devices** and press **OK**.
- 4 Press **▲** / **▼** to select a device and press **OK**.

Files are displayed in the List View according to the category (**Videos**, **Music** or **Photos**) and device you last selected.

To select a file in the list of contents:

- 1 Press **▲▼◀▶** to select a file or folder.
- 2 Press **OK** to move to the next layer, or press **BACK** to return to the previous layer. When you select a file, press **OK** to play or view.

To move to the tab selection:

- 1 Press the **BLUE** button.

To close the Media Player:

- 1 Press **EXIT**.

Using the Media Player with a media server

You need to configure a home network before using this feature (see page 12).

- 1 Press  and select **My Music**, **My Videos**, **My Photos** or **My Contents** icon and press **OK**.
- 2 Press **▲▼◀▶** to select **Device Name** icon and press **OK**.
- 3 Press **▲** / **▼** to select a device and press **OK**.

List of Contents

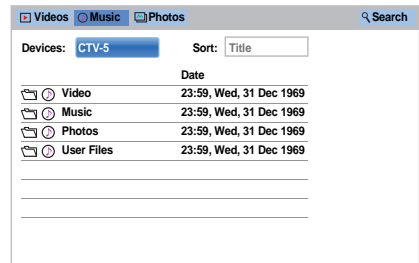

Videos, Music and Photos files and folders are displayed in the list of contents.

To select a file in the list of contents:

- 1 Press **▲▼◀▶** to select a file or folder.
- 2 Press **OK** to move to the next layer, or press **BACK** to return to the previous layer. When you select a file, press **OK** to play or view.

To sort files (if available):

You can sort files by file name (title) or date accordingly.

- 1 Press **▲▼◀▶** to highlight **Sort** and press **OK**.
- 2 Press **▲ / ▼** to select **File Name** (Title), **New** or **Old** and press **OK**.

To Search for content (if available):

- 1 Press **▲▼◀▶** to highlight **Search** and press **OK**.
- 2 Select the text box and press **OK**, the Software Keyboard window will appear (page 49). Input keyword by using the Software Keyboard and the search will search for:

Network

Videos: Title name

Music: Title name/Artist name/ Album name

Photos: Title name

USB

Videos/Music/Photos: File name.

- 3 Select Devices and Category and press **OK**. The list of search result will appear.

To display the Device Information or Wireless Information:

- 1 Press **QUICK** to open the **QUICK Menu**.
- 2 Press **▲ / ▼** to select any of the following item.

Using with DLNA: **Device Information**

Using with Wireless: **Wireless Information**

To close the Media Player:

- 1 Press **EXIT**.

Viewing photo files (on a media server or USB device)

There are two types of viewing modes.

Photos List (USB and Network Player Photo)

This view allows you to search for photos in a grid format. The pictures are displayed using thumbnail data in each image file.

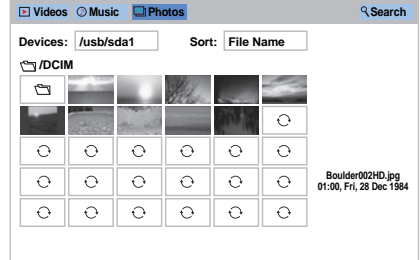

The initial highlighted position will be on the top left thumbnail in the Photos List.

- 1 Press **▲▼◀▶** to move the highlight in one window.

⤴ or ⤵ buttons can be used to page up/down the Photos List when there are more photos than will fit onto one screen. When the ⤴ or ⤵ buttons are pressed, the highlight shall be on the photo at the top left of Previous/Next Photos List.

NOTE: The page down function on the last page and page up function on the first page are not available.

- 2 When you select a folder, press **OK** to move to the next layer. Press **BACK** to move back to the previous layer.
- 3 Press **OK** to view the selected photo in Single View mode.

Single View (USB and Network Player Photo)

In this mode, only files located in the selected directory will be displayed. This view allows you to change the photo content manually. When moving from Photos List to Single View, the currently selected photo will be displayed.

- 1 Press **▶** to view the next photo. Press **◀** to view the previous photo.
- 2 Press **i+** to display file status information (file number, photo title, resolution etc.).

NOTE: The information may not be correctly displayed depending on the contents or the devices.

Slide Show (USB and Network Player Photo)

This view allows you to watch a slide show of your photos. In this mode, only files located in the selected directory will be played.

- 1 To start Slide Show, press **OK** in the Single View mode.
- 2 Press **◀/▶** to view the previous/next photo.
- 3 Press **i+** to display file status information. Press **OK** to return to Single View.

To set Interval Time and Repeat settings:

- 1 Press **QUICK** to open the **Quick Menu**.
- 2 Press **▲/▼** to select either **Interval Time** or **Repeat**.
- 3 Press **▶** and **▲/▼** to adjust the setting and press **OK**.

To rotate the image:

While viewing the image in Single View or Slide Show mode, the image can be rotated 90°.

▲ button: Clockwise rotation

▼ button: Counterclockwise rotation

NOTE: You can not rotate in 3D (2D to 3D) mode.

Selecting the Playback Mode:

You can view 3D photos in 3D and you can also view 2D photos in 3D.

- 1 Press **3D** on the remote control while in **Single View** mode or **Slide Show** mode.

The mode switches between 2D Mode and 3D Mode each time 3D button is pressed.

2D Mode: All photos are displayed in 2D.

3D Mode: The photos are displayed in the 3D mode selected in the Playback Mode. For the Playback Mode, refer to the following:

Setting the Playback Mode in Quick Menu:

- 1 Press **QUICK** to open the **Quick Menu**.
- 2 Press **▲/▼** to select **Playback Mode**.
- 3 Press **▶** and **▲/▼** to select **3D Mode 1** or **3D Mode 2**.

3D Mode 1: 3D photos in the USB memory are displayed in 3D. 2D photos are displayed in 2D. Some 3D photos cannot be displayed in 3D.

3D Mode 2: All photos are displayed in 3D. 2D photos are converted and displayed in 2D to 3D, and 3D photos are displayed in 3D.

To set Background Music (USB only):

- 1 Press **QUICK** to open the **Quick Menu**.
- 2 Press **▲/▼** to select **Background Music** and press **▶** and **▲/▼** to select **On**.

The music file in the same folder as the displayed photo will start playing.

NOTE:

- All the music files in the same folder as the photo will be played repeatedly.
- To stop music file playback, select **Off** in **Background Music**.

To zoom in/out photos (USB and Network Player Photo):

During the Single View mode or Slide Show mode, the zoom function can be used.

RED button (Zoom in)

x1 → x2 → x4 → x8 zoom in

GREEN button (Zoom out)

x8 → x4 → x2 → x1 zoom out

▲▼◀▶ buttons: Vertical or Horizontal scrolling

NOTE: Using the zoom function while in the **Slide Show** mode will stop the slideshow and zoom in/out the photo.

To select a photo from Play List (USB and Network Player Photo):

While in the **Single View** mode or **Slide Show** mode, you can select a different photo from the **Play List**.

- 1 Press **QUICK** to open the **Quick Menu** from **Single View** mode or **Slide Show** mode.
- 2 Press **▲ / ▼** to select **Play List** and press **OK**. The Photos List will appear.
- 3 Press **▲ / ▼** to select a file name.

To close the Photo Viewer:

- 1 Press **EXIT**. The television will return to the last viewed channel or external input.

File Compatibility

See page 94.

Viewing movie files (on a media server or USB device)

You can select movies from a **Videos List** of available files.

Videos List (USB and Network Player Movie)

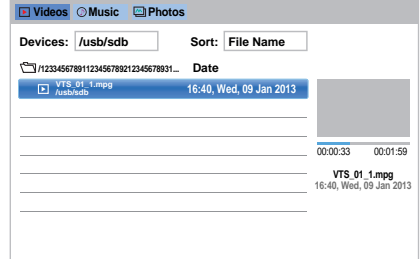

- 1 Press **▲▼◀▶** to select a file or folder. **⏪** or **⏩** buttons can be used to page up/down the **Videos List** when there are more files than will fit onto one screen.

NOTE: The page down function on the last page and page up function on the first page are not available.

- 2 When you select a folder, press **OK** to move to the next layer. Press **BACK** to move back to the previous layer.

- 3 With the desired file selected, press **OK** or **▶** (play) to start playback.

NOTE:

- On preview screen, if you highlight the file without pressing **OK**, the content is played on a preview screen. When **OK** is pressed, it is played in full screen mode.
- Depending on the file size, it may take some time to start playback.

- 4 Press **■** to stop playback.

NOTE:

- If playback finishes before **■** is pressed, the screen will return to the **Videos List**.
- Depending on the file size, it may take some time for playback to begin.

During playback:

- Press **II** to pause.
PAUSE may not be available depending on the contents or media server.
- To resume normal playback, press **▶** (play).
- To play in fast reverse or fast forward directions, press **◀◀/▶▶** during playback. Each time you press the **◀◀/▶▶**, the playback speed will change.
- Press **◀◀◀** to playback from the beginning of currently selected file. Press **▶▶▶** to locate subsequent files.
- Press **i+** to display the file status information (content number, movie title, progress time etc.).

NOTE:

- The information may not be correctly displayed depending on the contents or the devices.
- During playback, you can adjust the **Picture** and **Sound** menu functions from the **Quick Menu**.
- The playback speed (**◀◀/▶▶**) may not change depending on the stream.

To select subtitle and audio languages (USB only):

- Press **SUBTITLE** repeatedly to select your preferred subtitle language.
- Press **○/II** repeatedly to select your preferred audio language.

NOTE: This feature is not available depending on the contents.

To set the repeat mode:

- 1** Press **QUICK** to open the **Quick Menu**.
- 2** Press **▲/▼** to select **Repeat** and press **▶** and **▲/▼** to select **Off, All** or **1**.

Mode	Description
Off	The file is played back only once.
All	Files in the same folder are repeatedly played back.
1	The same file is repeatedly played back.

- 3** Press **BACK**.

NOTE:

- The setting is effective until the TV is turned off.
- This setting is ignored in the network media renderer.

Resume Play (USB only)

You can resume playback from where it was last stopped.

Press **■** while playing the movie to memorize the stopped position.

NOTE:

- The memorized stopped position will be deleted in any of the following cases.
 - Play different content
 - Exit Media Player
 - Press **■** in the Videos List
- This function may not be available depending on the content.

To select a movie from Play List (USB and Network Player Movie):

While playing a movie, you can select a different movie from the **Play List**.

- 1** Press **QUICK** to open the **Quick Menu**.
- 2** Press **▲/▼** to select **Play List** and press **OK**. The Movie List will appear.
- 3** Press **▲/▼** to select a file name.

To close the Movie Viewer:

- 1** Press **EXIT**.

File Compatibility

See page 94.

To register your TV to a DivX® account:

This TV allows you to play back files purchased or rented from DivX® Video-On Demand (VOD) services. When you purchase or rent DivX® VOD files on the internet, you will be asked to enter a registration code.

- 1 In the **Media Player Setup** menu, press **▲ / ▼** to select **DivX® VOD** and press **OK**.
- 2 Press **▲ / ▼** to select **DivX® VOD Registration** and press **OK**.



- 3 The **DivX® VOD** window will appear and you will see the registration code. For details on registration, please visit the DivX® website at

<http://vod.divx.com>

- 4 Copy the activation file to a memory device and play it on the TV.

To deregistration your device:

- 1 In step 2 above, select **DivX® VOD Deregistration**, and then press **OK**.
- 2 A confirmation message will appear. Select **Yes** and press **OK**.
- 3 The **DivX® VOD** window will appear and you will see the deregistration code. For details on registration, please visit the DivX® website at

<http://vod.divx.com>

ABOUT DIVX VIDEO: DivX® is a digital video format created by DivX, LLC, a subsidiary of Rovi Corporation. This is an official DivX Certified® device that plays DivX video. Visit divx.com for more information and software tools to convert your files into DivX videos.

ABOUT DIVX VIDEO-ON-DEMAND: This DivX Certified® device must be registered in order to play purchased DivX Video-on-Demand (VOD) movies. To obtain your registration code, locate the DivX VOD section in your device setup menu. Go to vod.divx.com for more information on how to complete your registration.

DivX Certified® to play DivX® and DivX Plus® HD (H.264/MKV) video up to HD 1080p, including premium content.

To playback DivX Plus HD content:

- To play in fast reverse or fast forward directions, press **◀◀ / ▶▶** during playback. Each time you press the **◀◀ / ▶▶**, the playback speed will change.
- This TV generates original chapter point in 10 % increments for 10 chapters in total, that are accessible by using the number buttons on the remote control.

During playback, press **▶▶** to skip to the beginning of the next chapter. When **▶▶** is pressed twice in succession, it will repeat two times of above. If **▶▶** is pressed at the last chapter, the confirmation message will appear. If you select **Yes**, playback will skip to the beginning of the next content.

Press **◀◀** to skip to the beginning of the current chapter. When **◀◀** is pressed twice in succession, it will skip to the beginning of the previous chapter. If **◀◀** is pressed twice in succession at the first chapter, stop playing the current content and the confirmation message will appear. If you select **Yes**, playback will skip to the beginning of the previous content.

Press **▲** to skip to the beginning of the previous file. Press **▼** to skip to the beginning of the next file.

The Number button is used for direct jump. If the 3 button and **OK** button is pressed, playback will jump to the beginning of 3rd chapter.

NOTE:

- Depending on the content data will not be operated.
- The playback speed (**◀◀ / ▶▶**) may not change depending on the stream.

Using Multi Title and Alternative Timelines

Multi Title

DivX Plus HD files may contain up to 100 titles.

You can change the title (It contains same video file) by pressing the **RED** button.

When the **RED** button is pressed, it will display the title change window at the bottom on the screen (same as Subtitle or Audio change window).

The title is changed cyclically each time the **RED** button is pressed. Playback will start from start time of selected title every **▲ / ▼**. Pressing **◀ / ▶** also changes the multi title.

NOTE: Depending on the content data will not be operated.

Playing music files (on a media server or USB device)

You can listen to music from a **Music List** of available files.

Music List (USB and Network Player Music)

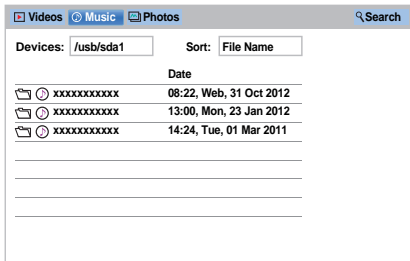

- 1 Press **▲▼◀▶** to select a file or folder. **⏪** or **⏩** buttons can be used to page up/down the **Music List** when there are more files than will fit onto one screen.

NOTE: The page down function on the last page and page up function on the first page are not available.

- 2 When you select a folder, press **OK** to move to the next layer. Press **BACK** to move back to the previous layer.
- 3 With the desired file selected, press **OK** or **▶** (play) to start playback.

NOTE: If you highlight the file without pressing **OK**, the content is played on a **Music List**. When **OK** is pressed, it is played in full screen mode.

- 4 Press **■** to stop playback.

NOTE:

- Depending on the file size, it may take some time for playback to begin.
- During playback, you can adjust the **Sound** menu functions from the **Quick Menu**.

During playback

- Press **II** to pause.
PAUSE may not be available depending on the contents or media server.
- To resume normal playback, press **▶** (play).
- To play in fast reverse or fast forward directions, press **◀◀/▶▶**. Each time you press **◀◀/▶▶**, the playback speed will change.
- Press **◀◀◀** to playback from the beginning of currently selected file. Press **▶▶▶** to locate subsequent files.

To set the repeat mode:

- 1 Press **QUICK** to open the **Quick Menu**.
- 2 Press **▲ / ▼** to select **Repeat**.
- 3 Press **▶** and **▲ / ▼** to select **Off**, **All** or **1**.

Mode	Description
Off	Files in the same folder are played back once.
All	Files in the same folder are repeatedly played back.
1	The same file is repeatedly played back.

- 4 Press **BACK**.

NOTE:

- The setting is effective until the TV is turned off.
- When the TV is used as a media renderer, this feature cannot be used.

To select a music file from Play List (USB and Network Player Music):

While playing a music file, you can select a different music file from the **Play List**.

- 1 Press **QUICK** to open the **Quick Menu**.
- 2 Press **▲ / ▼** to select **Play List** and press **OK**. The Music List will appear.
- 3 Press **▲ / ▼** to select a file name.

To display the file status information:

- 1 Press **i+** during playback. The information will be displayed on the bottom of the screen.
- 2 Press **i+** again to remove the information.

NOTE: The information may not be correctly displayed depending on the contents or the devices.

To close the Music Player:

- 1 Press **EXIT**.

File Compatibility

See page 94.

Other features

Panel Lock

Panel Lock disables the buttons on the television. All buttons on the remote control can still be used.

- 1 Press  and $\blacktriangle / \blacktriangledown$ to highlight **Options** icon.
- 2 Press \blacktriangleright and $\blacktriangle / \blacktriangledown$ to select **Panel Lock** and press **OK**.
- 3 Press $\blacktriangle / \blacktriangledown$ to select **On**.

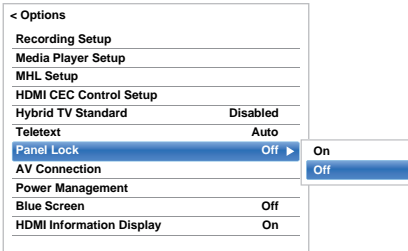

When **Panel Lock** is **On**, a reminder will appear when the buttons on the television are pressed. **If the standby button is pressed, the television will switch off and can only be brought out of standby by using the remote control.**

Blue Screen

*When **Blue Screen** is selected, the screen will turn blue and the sound will be muted on analogue channels and external input modes when no signal is received.*

NOTE: Some external input sounds may not be muted.

- 1 In the **Options** menu, press $\blacktriangle / \blacktriangledown$ to select **Blue Screen**.
- 2 Press \blacktriangleright and $\blacktriangle / \blacktriangledown$ to select **On** or **Off**.

Netflix®

To confirm the Netflix ESN (Electronic Serial Number)

- 1 In the Network menu, press $\blacktriangle / \blacktriangledown$ to select **Smart Apps Setup** and press **OK**.
- 2 In **Smart Apps Setup** menu, select **Netflix Setup** and press **OK**.
- 3 Press $\blacktriangle / \blacktriangledown$ to select **ESN** and press **OK**. Netflix ESN screen will appear.

To deactivate your TV

- 1 In the Network menu, press $\blacktriangle / \blacktriangledown$ to select **Smart Apps Setup** and press **OK**.
- 2 In **Smart Apps Setup** menu, select **Netflix Setup** and press **OK**.
- 3 Press $\blacktriangle / \blacktriangledown$ to select **Deactivation** and press **OK**.
- 4 Press $\blacktriangleleft / \blacktriangleright$ to select **Yes** and press **OK**.

The timers

Programme Timers – digital only

This feature will set the television to go to a specific channel at a certain time. It can be used to view a particular programme, or by setting the mode to daily or weekly, can be used to view a series of programmes.

- 1 Press **GUIDE** and then press the **BLUE** button on the remote control
- 2 Press **▼** if necessary to select an open timer position, then press **OK**. The **Edit Timer** menu will now appear on screen.
- 3 Press **▲ / ▼** to go through the list adding the details of the programme by using the number buttons and **◀ / ▶** to make selections.

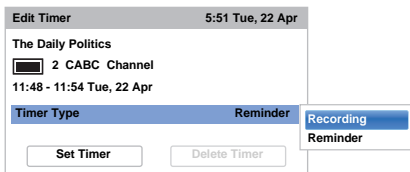

- 4 When all of the details have been entered, highlight **Set Timer** and press **OK** to save the timer.

On Timer

The feature allows you to set the television to turn on automatically to a preset channel at a certain time of day or after a certain length of time.

- 1 Press **⏻** and **▲ / ▼** to highlight **Timers** icon.
- 2 Press **▶** and **▲ / ▼** to select **On Timer** and press **OK**.
- 3 Press **▲ / ▼** to select **Enable On Timer** and press **◀ / ▶** to select **On**.

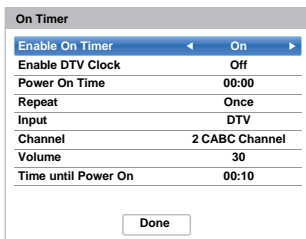

- 4 Press **▼** to select **Enable DTV Clock**, and then press **◀ / ▶** to select **On** or **Off**.

- 5 Press **▲ / ▼** to go through the list adding the details of the On Timer by using the number buttons and **◀ / ▶** to make selections.

Power On Time (only for DTV Clock On mode): Set the time you prefer with the number buttons.

Repeat (only for DTV Clock On mode): Select the desired On Timer operation (**Once, Every Day, Mon-Fri, Mon-Sat, Sat-Sun**).

Input: Select a video input source (ATV, DTV Ant, EXT 1, EXT 2, HDMI 1, HDMI 2, HDMI 3, HDMI 4 or PC).

Channel: Set the channel that will be tuned when the television turns on.

NOTE: When an external input is selected in the **Input** field, a channel cannot be selected.

Volume: Set the volume that will be applied when the television turns on.

Time until Power On (only for DTV Clock Off mode): Set the amount of time from now until the TV turns on using the number buttons (maximum of 12 hours).

- 6 Press **▲ / ▼** to highlight **Done** and press **OK**.

To cancel the On Timer:

- 1 In the **On Timer** menu, select **Enable On Timer**.
- 2 Press **◀ / ▶** to select **Off**.
- 3 Press **▲ / ▼** to highlight **Done** and press **OK**.

Sleep Timer







The television can be set to turn itself Off after a certain length of time.

- 1 Press **⏻** and **▲ / ▼** to highlight **Timers** icon.
- 2 Press **▶** and **▲ / ▼** to highlight **Sleep Timer** and press **OK**.
- 3 Use the number buttons to set the desired time. For example, to switch the television off in one and a half hours enter 01:30, or press **▶ / ◀** to increase/decrease in steps of 10 minutes. (Maximum time setting is 12 hours)
- 4 Press **EXIT** to finish.
- 5 To cancel the **Sleep Timer**, enter all zeros for the above setting.

Energy Saving Settings

Automatic Power Down

The TV will automatically turn itself off (Standby) after 4 hours, if you do not operate the TV either from the remote control or the TV control panel.

- 1 Press  and  to highlight **Options** icon.
- 2 Press  and  to select **Power Management** and press **OK**.
- 3 Press  to select **Automatic Power Down**.
- 4 Press  and  to select **On** or **Off** and press **OK**.





NOTE:

- This feature is set to **On** when **Location** is set to **Home**.
- 1 minute before switching to Standby, a Warning message will appear.
- When the following features are set, the feature that is set for the nearest time will function.
 - Automatic Power Down
 - Sleep Timer
 - Auto shutdown after 1 hour of inactivity (after power on by On Timer)
 - No signal auto power off (after 15 minute of no signal)

No Signal Power Down

The TV will automatically turn itself off after 15 minutes when no signal is detected. You can change the setting to Off for the following purposes:

- Low signal strength of analogue channel (no signal detection)
- Only Audio L/R is connected to external input to listen to music through the TV speakers.

- 1 In the **Power Management** menu, press  to select **No Signal Power Down**.
- 2 Press  and  to select the item you want to change and press  and  to select **On** or **Off**.

NOTE:

- Default setting is all **On**.
- A warning message will appear 1 minute before turning off.

Digital on-screen information

When viewing in **digital** mode, the on-screen information and programme guide provide access to programme details for all available channels.

Information

- 1 Press , the information screen will appear giving details of the channel and programme currently being viewed.

Display Example

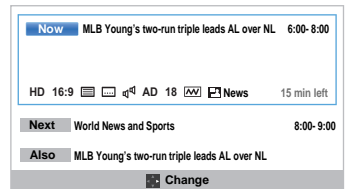
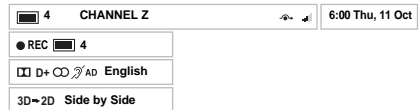

- 2 Press  to select the "Now", "Next" or "Also" information guide.

The selected information content will appear.

- 3 To record the next scheduled programme, select **Next** and press **OK**. The **Edit Timer** screen will appear.



- 4 The details of the programme will already have been added to the timer. Highlight **Set Timer** and press **OK** to save.

To indicate that a Recording Timer has been set, a clock icon will be displayed in the **Next** fields of the information screen. A check mark will appear if the timer is a Reminder Timer.

To display More Information:

- 1** Press **QUICK** to open the **Quick Menu**.
- 2** Press **▼** to highlight **More Information** and press **OK**.

On-screen Information icons

	Icon	Description
Service info		Service type (TV, Radio, Text)
		Skip
Audio info		Mono
		Stereo
		Dual mono
		Multichannel
		Dolby Digital
		Dolby Digital+
		When HE-AAC is decoded
Audio/Subtitle info		For Hard of Hearing
Recording info		Recording + Service info
3D info	3D	
	3D → 2D	
Event info	HD, SD	Video format (HD, SD)
	16:9, 4:3	Video Aspect
		Teletext
		Subtitle (Single, Multi)
		Audio track (Mono, Multi)
	0, 4 – 18	Parental rating
Timer info		Recording
		Reminder

Using EPG (Electronic Programme Guide)

Using Broadcast Guide

- 1** Select the on-screen Guide by pressing **GUIDE**, and the Guide screen will appear highlighting details of the channel and programme currently being viewed. This may take a few moments to appear.



You can switch the time scale to 1.5 or 3 hours by pressing the **GREEN** button.

- 2** Press **◀/▶** for information on other programmes scheduled for the channel selected. To highlight the first programme in the genre grid, press the **RED** button.
- 3** For details of other programmes currently available, press **▲/▼** to scroll up and down the channel list. As channels are selected, details of the programme currently being broadcast will appear. Press **◀/▶** to view information for future programmes.
- 4** For information on a highlighted programme, press **f+**.
- 5** To set the timer for that programme, press the **BLUE** button to bring up the **Programme Timers** menu.

- 6** Press **↕** to view another page.

Updating EPG:

- 1** In the Guide screen press **QUICK**.
- 2** Press **▲/▼** to select **EPG Update**.

Genre selection/searching

From the Guide screen, you can use the genre selection and search features.

- 1 In the Guide screen, press **QUICK**.
- 2 Press **▲** / **▼** to highlight **Genre Colour** in the **Quick Menu** and press **OK**.

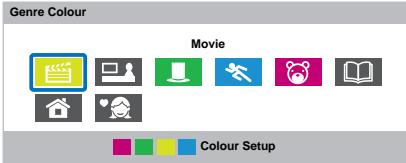

- 3 With the focus on a particular genre, press the desired coloured button to assign. Four colours will be available to set. Press **BACK** to go back to the Guide screen.

Digital settings – parental control

In order to prevent viewing of unsuitable films and programmes, channels and menus can be locked in digital mode. These can then only be accessed with a security code PIN.

Parental PIN Setup

- 1 Press **⏸** and **▲** / **▼** to highlight **Installation** icon.
- 2 Press **▶** and **▲** / **▼** to select **DTV Settings** and press **OK**.
- 3 Press **▲** / **▼** to select **Parental PIN Setup** and press **OK**.

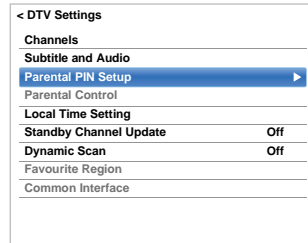

- 4 Using the number buttons enter a four digit number. Once entered you will be prompted to confirm by entering again.



The PIN number is now set.

If the PIN code has been set, when **Auto Tuning** and **Reset TV** are executed, entering the PIN will be necessary. "0000" is not acceptable.

Parental Setup

The **Parental Control** feature allows you to block programmes according to their rating levels. If a PIN has been set, you will need to enter it before adjusting the level.

- 1 In the **DTV Settings** menu, press ▲ / ▼ to select **Parental Control** and press **OK**.
- 2 Press ▲ / ▼ to select **Parental Setup** or **Playback Setup** and press **OK**.

Parental Setup: Select when you want to set viewing restrictions on broadcast programmes.

Playback Setup: Select when you want to set viewing restrictions on playback of programmes recorded to the USB HDD.

- 3 Press ▲ / ▼ to select an option.

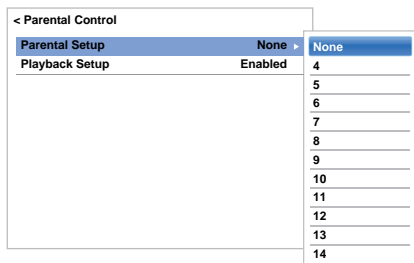

To view blocked programmes, enter the PIN. To reactivate the Parental Control, turn the TV off and then on again.

Digital settings – Channel Options

Selecting favourite channels

From the **Quick Menu / Channel Options** menu, it is possible to create a list of the digital channels that are watched most. Press **LIST** / ◀▶ to select the **Favourite Channel list**.

- 1 Select the channel you want to add to your favourite list.
- 2 Press **QUICK** to open the **Quick Menu**.
- 3 Press ▼ to select **Channel Options** and press **OK**.
- 4 Press ▶ to highlight the favourite (☆) box.
- 5 Press **OK** to select the ones required. A tick will appear in the box as they are selected.
- 6 Repeat steps 1 through 5 for other channels.
- 7 When all favourites have been selected, press **EXIT**.

Favourite Channel List

- 1 Press **LIST** to display **Channel List**.

Each time you press ◀/▶, **All Channels**, **TV Channels**, **Radio Channels**, **Text Channels** or **Favourites** is selected in order.

- 2 Press ◀/▶ to select **Favourites**. The number of favourites available depends on how many lists have been created.

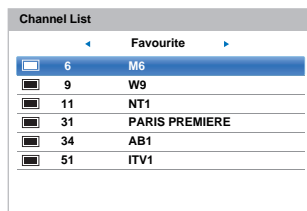

- 3 Press ▲ / ▼ to highlight a channel and press **OK** to watch.

Skip channels

This feature allows you to set channels that will be skipped when **P▼** or **P▲** are used to tune.

- 1 Select the channel you want to skip in your channel list.
- 2 In the **Quick Menu**, press **▼** to select **Channel Options** and press **OK**.
- 3 Press **▶** repeatedly to highlight the skip (↺) box.
- 4 Press **OK** to select. A tick will appear in the box.
- 5 Repeat steps 1 through 4 for other channels.
- 6 Press **EXIT**.

NOTE: Skipped channels cannot be selected by **P▼** or **P▲** but still be accessed by direct number entry (when tuned a ↺ icon will be displayed in the banner to indicate as a skipped channel).

Locking channels

Locking Channels stops the viewing of **digital** channels, and they can only be accessed by entering the PIN.

- 1 Select the channel you want to lock in your channel list.
- 2 In the **Quick Menu**, press **▼** to select **Channel Options** and press **OK**.
- 3 Press **▶** repeatedly to highlight the lock (🔒) box.
- 4 Press **OK** and PIN entry will be required to set the locked channels. Enter **PIN Code** and a tick will appear in the box.

NOTE: A Parental PIN should be set in advance. If not, a warning message will display to remind you to set a PIN first.

- 5 Repeat steps 1 through 4 for other channels.
- 6 Press **EXIT**.
- 7 From this point on, when any of the **Locked Channel** list is selected, the PIN must be entered before they can be accessed.

Digital settings – other settings

Subtitles

In **DTV** mode, this feature will show subtitles on the screen in the selected language provided they are being broadcast.

- 1 In the **DTV Settings** menu, press **▲** / **▼** to select **Subtitle and Audio** and press **OK**.
- 2 Press **▼** to select **Subtitle Display** and press **▶** and **▲** / **▼** to select **On** or **Off**.

< Subtitle and Audio	
Subtitle Display	Off ▶
Subtitle Type	Normal
Primary Subtitle Language	English
Secondary Subtitle Language	English
Audio Type	Normal
Primary Audio Language	English
Secondary Audio Language	English

- 3 Press **▲** / **▼** to select **Primary Subtitle Language** or **Secondary Subtitle Language** and press **▶** and **▲** / **▼** to select an option.

The **SUBTITLE** button can be used to select subtitle on or off for the current channel only and to select the subtitle language if more than one subtitle is available.

Audio languages

This feature allows a programme or film to be viewed with a choice of soundtrack language, provided multiple language tracks are being broadcast.

- 1 In the **Subtitle and Audio** menu, press **▲** / **▼** to select **Audio Type** and press **▶** and **▲** / **▼** to select **Normal**, **For Hard of Hearing** or **Audio Description** and press **OK**.
- 2 Press **▲** / **▼** to select **Primary Audio Language** or **Secondary Audio Language** and press **▶** and **▲** / **▼** to select an option.

If more than one soundtrack is available, use the **⏮/⏭** button to select between them.

Common Interface

The Common Interface Slot, situated on the side of the television, enables the insertion of a CAM (Conditional Access Module) and card. These are purchased from a service provider and allow additional subscription broadcasts to be viewed. For information, see a service provider.

- 1 Insert the CAM and card into the Common Interface Slot, following the instructions provided with the CAM. A box will appear on screen to confirm that the CAM has been inserted.
- 2 Press  and ▲ / ▼ to highlight **Installation** icon.
- 3 Press ▶ and ▲ / ▼ to select **DTV Settings** and press **OK**.
- 4 Press ▲ / ▼ to select **Common Interface** and press **OK**.
- 5 Details of the CAM should now be available.

NOTE:

- Software update of a CI Plus CAM may execute automatically if it is instigated by the broadcaster. This could cause the cancellation of any Reminders/ Recordings during this process.
- Some CI or CI+ CAM may not be supported.
- CI+ operation is not guaranteed except for Canal Ready DTT services on suffix FC models.

Software Upgrade and Licences

Searching for New Software

If preferred, software upgrades can be searched for manually using **Search for New Software**.

- 1 In the **Get Help** menu, press ▲ / ▼ to select **Software Upgrade** and press **OK**.
- 2 Press ▲ / ▼ to select **Over-the-air Upgrade** and press **OK**.
- 3 Press ▶ and ▲ / ▼ to select **Search for New Software** and press **OK**. The television will automatically start searching for a software upgrade, the progress bar will move along the line.

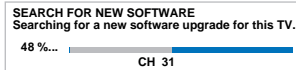

If an upgrade is found, the television will automatically start downloading. If not, a screen will appear stating that an upgrade is unavailable.

NOTE: When **Auto Upgrade** is set to **Off**, this feature is not available.

Network Upgrade

TOSHIBA may offer upgrades for the TV's software in the future. The TV's software is upgraded via the Network.

Before downloading software:

Configure your TV to connect to the Internet.

NOTE: While the upgrade is being performed, you will not be able to watch the TV.

- 1 In the **Get Help** menu, press ▲ / ▼ to select **Software Upgrade** and press **OK**.
- 2 Press ▲ / ▼ to select **Network Upgrade** and press **OK**.

NOTE: If the network is not available, a warning message will appear.
- 3 The TV software upgrade will start when download succeeds.

Software Licences

The licences for the software used in this television are available for viewing.

- In the **Get Help** menu, press ▲ / ▼ to select **Software Licences** and press **OK**.
A screen will appear displaying all the licensing information required for the televisions software.

System Information and Reset TV

System Information

This feature can be used to check the version of software currently installed. When in DTV mode, it includes additional diagnostic information such as signal strength, signal quality, centre frequency, modulation, etc.

- In the **Get Help** menu, press ▲ / ▼ to select **System Information**.
- Press **OK** to display the **System Information**.

System Information			
TOSHIBA 2013 Jan 19 2013 Software Version : xxxxxxxx MBOOT Version : xxxxxxxx			
CH 25	AVERAGE		GOOD
	WEAK	STRONG	
CH 33	AVERAGE		GOOD
	WEAK	STRONG	
CH 67	AVERAGE		GOOD
	WEAK	STRONG	

- For information about the signal quality of a particular multiplex, press ▲ / ▼ to select that multiplex.
- Press **OK** for a screen showing detailed technical information about the selected multiplex.

Reset TV

Selecting **Reset TV** will reset all TV settings, including saved channels, to their original factory values.

- In the **Installation** menu, press ▲ / ▼ to select **Reset TV**.
- Press **OK** to select. A screen will appear warning that all settings will be lost. Press **OK** to continue.

When the set powers back on, the **Quick Setup** screen will appear. Press **OK** to advance the setup and perform an auto tune. (See "Quick Setup" section on page 15.)

PC Settings

Horizontal and Vertical Position

Connect the PC (as shown in the "Connecting a computer" section) and ensure that a picture is showing on the television screen. The picture position may now be adjusted to suit personal preference.

- 1 Press  and ▲ / ▼ to highlight **Picture** icon.
- 2 Press ▶ and ▲ / ▼ to select **Display Settings** and press **OK**.
- 3 Press ▲ / ▼ to select **PC Setting** and press **OK**.

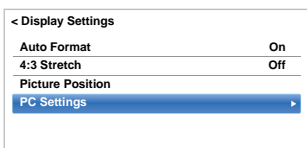

- 4 Press ▲ / ▼ to select an option and press ◀ / ▶ to adjust the settings.

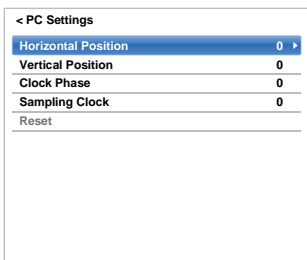

Clock Phase

The **Clock Phase** matches the PC signal with the LCD display. Adjusting this can clear horizontal stripes and picture blur.

- 1 In the **Display Settings** menu, press ▲ / ▼ to select **PC Settings** and press **OK**.
- 2 Press ▲ / ▼ to select **Clock Phase**.
- 3 Press ◀ / ▶ to adjust until the picture clears and press **OK**.

Sampling Clock

Adjusting the **Sampling Clock** alters the number of pulses per scan, this will clear vertical lines on the screen.

- 1 In the **Display Settings** menu, press ▲ / ▼ to select **PC Settings** and press **OK**.
- 2 Press ▲ / ▼ to select **Sampling Clock**.
- 3 Press ◀ / ▶ to adjust until the picture clears.

Reset

Use **Reset** to return all items to the original factory settings.

- 1 In the **Display Settings** menu, press ▲ / ▼ to select **PC Settings** and press **OK**.
- 2 Press ▲ / ▼ to select **Reset** and press **OK**.

NOTE: When a PC is connected using HDMI, none of these functions will be available.

The screen is disrupted momentarily when adjusting PC Settings. This is not a sign of malfunction.

The default settings and adjustment ranges may vary depending on the input signal format.

Input selection and AV connections

See page 8 for a detailed image showing recommended connections.

Most media recorders and decoders send a signal through the SCART lead to switch the television to the correct *Input* socket.

Alternatively, press the external source selection button  until the picture from connected equipment is shown.



Input selection

Use the *Input Selection* window if the television does not switch over automatically.

- 1 By pressing  on the remote control or TV, a list will appear on screen showing all inputs and external equipment.

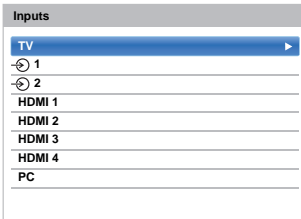
Press  on the remote control



Press and hold  /  on the TV

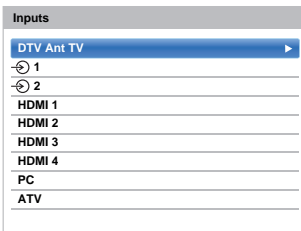



HDMI® displays equipment connected to *Input HDMI* on the back or side of the television.

PC displays a computer connected to *Input RGB/PC* on the back of the television.

Labelling video input sources

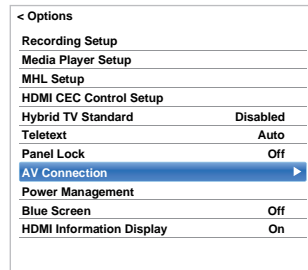

These *input labels* are shown in the *input selector*. You can label video inputs according to the devices you have connected to the TV.

- 1 Press  and  to highlight **Options** icon.
- 2 Press  to select **AV Connection** and press **OK**.

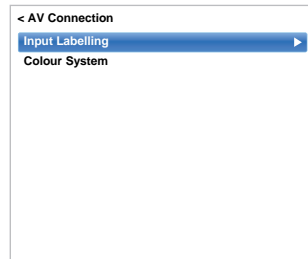

- 3 Press  to highlight **Input Labelling** and press **OK**.



- 4 Press  to select the item you want to label, and then press  to select --, **Amplifier**, **Cable**, **DVD**, **Game**, **PC**, **Recorder** Satellite, VCR or Bluray.

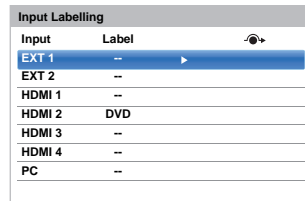

- 5 Repeat step 4 for other video inputs.

Digital Audio Output

When connecting a surround sound amplifier to the digital audio output (Sony/Philips Digital Interface Format [S/PDIF]), the following options can be selected or adjusted.

- 1** In the **Sound** menu, press ▲ / ▼ to select **Digital Audio Output** and press **OK**.

< Sound	
Balance	0
Bass	0
Treble	0
Audyssey Premium Television	
Dynamic Range Control	On
Dual	Dual 1
Audio Level Offset	
TV Speakers	On
Headphone Level	
Audio Description	
Digital Audio Output	

- 2** Press ▲ / ▼ to select an option.

Audio Format

Press ◀ / ▶ to select **PCM** or **Auto**.

PCM: This mode outputs PCM format to the digital audio output socket.

Auto: This mode outputs Dolby Digital (if available) or PCM to the digital audio output socket.

Dolby Digital → Dolby Digital

Dolby Digital Plus → Dolby Digital

MPEG → PCM

HE-AAC → Dolby Digital

Audio Delay

Press ◀ / ▶ to select **Auto** or **Manual**.

Auto: This mode automatically adjusts the audio timing to meet the video timing.

NOTE: The time lag might be large between the image and sound depending on the connected equipment (amplifier etc.). In that case, select **Manual**.

Manual: You can manually adjust the audio signal timing to meet the video signal timing.

Delay Adjustment

Press ◀ / ▶ to adjust the audio signal timing (0 – 250 ms) to meet the video signal timing.

NOTE:

- This feature is greyed out when **Audio Delay** is in **Auto**.
- A time lag will occur when the video signal or audio signal is changed. Adjust the timing accordingly.
- When adjusting the timing, turn down the volume of the AV equipment used as far as possible. Depending on the equipment, noise etc. may occur when the signal is changed.
- Depending on the connected equipment (amplifier, etc.), adjustment may not be possible.
- When the optical digital output setting (Auto ↔ PCM) is changed, it may be necessary to adjust the timing again.
- Do not use other than for audio output from the AV amplifier, etc. (Malfunction may occur)

Using HDMI CEC Control

This is a new feature that uses CEC technology and allows you to control Toshiba HDMI CEC Control compatible devices from the television remote control via HDMI connection (page 10).

When the **Enable HDMI CEC Control** item in the **HDMI CEC Control Setup** menu is set to **On**, individual functions also set to **On** will be activated.

Enable HDMI CEC Control

- 1 Press  and \blacktriangle / \blacktriangledown to highlight **Options** icon.
- 2 Press \blacktriangleright and \blacktriangle / \blacktriangledown to select **HDMI CEC Control Setup** and press **OK**.
- 3 Press \blacktriangledown to select **Enable HDMI CEC Control** and press \blacktriangleleft / \blacktriangleright to select **On**.

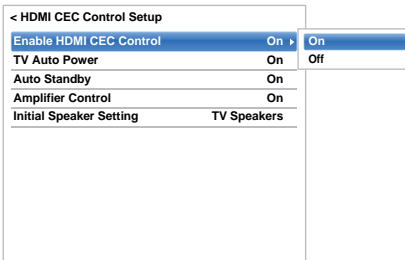

NOTE: If you set **Enable HDMI CEC Control** to **Off**, all other items will be greyed out.

TV Auto Power

The **TV Auto Power** setting allows the television to be automatically switched on if an HDMI CEC Control device is turned on.

- 1 In the **HDMI CEC Control Setup** menu, press \blacktriangledown to highlight **TV Auto Power**.
- 2 Press \blacktriangleright and \blacktriangle / \blacktriangledown to select **On** or **Off**.

Auto Standby

When **Auto Standby** is enabled, the television, when switched off, will automatically switch off (Standby) all connected HDMI CEC Control equipment.

- 1 In the **HDMI CEC Control Setup** menu, press \blacktriangledown to highlight **Auto Standby**.
- 2 Press \blacktriangleright and \blacktriangle / \blacktriangledown to select **On** or **Off**.

Amplifier Control

When **Amplifier Control** is set to on/off the connected HDMI CEC Control amplifier.

- 1 In the **HDMI CEC Control Setup** menu, press \blacktriangledown to select **Amplifier Control**.
- 2 Press \blacktriangleright and \blacktriangle / \blacktriangledown to select **On** or **Off**.

Initial Speaker Setting

The **Initial Speaker Setting** allows to select TV speakers or Amplifier speakers.

- 1 In the **HDMI CEC Control Setup** menu, press \blacktriangledown to select **Initial Speaker Setting**.
- 2 Press \blacktriangleright and \blacktriangle / \blacktriangledown to select **TV Speakers** or **Amplifier**.

HDMI CEC Control input source selection

If an HDMI CEC Control device with HDMI switching capability (e.g. AV amplifier) is connected to the HDMI input, you can select another HDMI CEC Control device that is connected to the master HDMI device on the input source list.

- 1 Press  and a list will appear on screen showing available input sources.
- 2 Press \blacktriangledown to select the input source that the HDMI CEC Control devices are connected.
- 3 Press \blacktriangleright and a second selection screen will appear showing all connected HDMI CEC Control equipment.

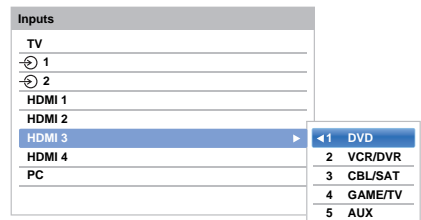

- 4 Press \blacktriangle / \blacktriangledown to select the desired input source, and then press **OK**.

NOTE:

- These functions depend on the device connected. If you select the HDMI CEC Control input source from the popup window, some HDMI CEC Control devices may automatically turn on.
- If the HDMI cable from connected equipment is changed, **Enable** in the HDMI CEC Control Setup menu may need to be reset to **On**.
- If you change the HDMI lead to a connected device or change an HDMI device setting, reset the **Enable HDMI CEC Control** item on the HDMI CEC Control Setup menu from **Off** to **On**.

HDMI CEC Control one touch play

When connected equipment is switched on, HDMI CEC Control will automatically detect the television through the input selection. If the television is in Standby, it will be switched on automatically.

These functions can be enabled or disabled from the **HDMI CEC Control Setup** (see page 85).

NOTE:

- Even if the equipment is showing a menu, the television may automatically show the input source.
- This feature depends on the connected equipment and television state.

HDMI CEC Control system standby

If the television is turned off (Standby), the television will send a message to turn off (Standby) all of the HDMI CEC Control devices connected to the television.

These functions can be enabled or disabled from the **HDMI CEC Control Setup** (see page 85).

NOTE: This feature depends on the connected equipment and television state.

Using MHL TV function

You can use the following functions by connecting between the TV HDMI 3 port and a USB port of mobile phones etc. with an MHL cable.

- Charge with mobile phone from TV
- Two-way remote operation between TV and mobile phone
- Video/Audio output from mobile phone

NOTE: These functions may not be available depending on the connected device.

Connecting an MHL-compatible device

Connect the device to the HDMI 3 port on the TV with an MHL cable (not supplied).

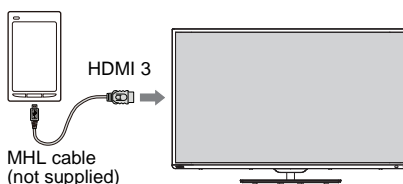

- When you connect an MHL-compatible device to the HDMI 3 port on the TV with the MHL cable, charging starts automatically.

NOTE: Do not connect an MHL-compatible device to any port other than the HDMI 3 port.

Operating an MHL-compatible device

When an MHL-compatible device is connected to the HDMI 3 port on the TV, input automatically switches to the HDMI 3 port.

Operate the device using the remote control for the TV. To display photos, select the photos using ▲▼◀▶ and press **OK**. To play a video, press ▶ (play). Depending on the connected MHL-compatible device, it may be possible to perform operations from the device.

MHL Setup

Select whether or not input automatically switches to the HDMI 3 port when an MHL-compatible device is connected.









- 1 In the **Options** menu, press ▲ / ▼ to select **MHL Setup**.
- 2 Press ▶ to select **TV Auto Input Switch**.
- 3 Press ◀ / ▶ to select **On** or **Off** and press **OK**.

Text services

This television has a multi-page text memory, which takes a few moments to load. It offers two **Modes** of viewing text – **Auto** will display **Fasttext**, if available. **List** will save your four favourite pages.

Selecting modes

The text character set will be automatically chosen by the language setting in the **Options** menu.

- 1 Press  and  /  to highlight **Options** icon.
- 2 Press  and  /  to select **Teletext**, and then press  /  to select **Auto** or **List**.

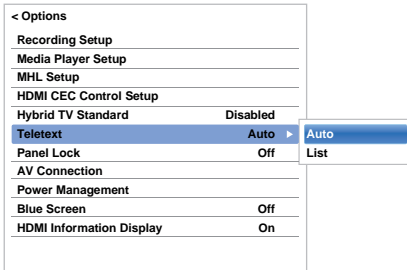

Text information

The TEXT button



To view text services press **TEXT**. Press again to superimpose the text over a normal broadcast picture and again to return to normal viewing. Channels cannot be changed until text is cancelled.

The first text page shown will be the *initial* page.

Any text page can be accessed by entering the 3-digit page number using the numbered buttons, pressing the coloured buttons or pressing **P^** to advance to the next page and **Pv** to go back to the previous page.

Sub-pages

The pages on the screen will dynamically update as sub-pages are received.

If you open a page containing sub-pages, the sub-pages are automatically displayed in sequence. To quit automatic sub-page change, press  / .

Once selected, the sub-page you are viewing will be highlighted and, as the television loads any additional sub-pages, the colour of the numbers will change, indicating that these pages have been loaded.

These sub-pages will remain available to view until another page is chosen or, in normal TV mode, the channel is changed.

Navigating pages using Auto

If **Fasttext** is available, four coloured titles will appear at the base of the screen.

To access one of the four given subjects, press the relevant coloured button on the remote control.

For further information on your particular text system(s), see the broadcast text index page or consult your local Toshiba dealer.

Navigating pages using LIST

The four coloured choices at the bottom of the screen are numbers – 100, 101, 102 and 103, which have been programmed into the television's memory. To view these pages, press the relevant coloured buttons.

To change these saved pages, press the relevant coloured button and enter the 3-digit number. This number will change in the top left of the screen and in the coloured highlight.

Press **OK** to save. **Whenever OK is pressed, all four page numbers showing at the bottom will be saved and the previous ones will be lost.**

NOTE: The video signal from the external inputs (EXT-1 and EXT-2) is not saved.

If **OK** is not pressed, the selection will be forgotten when the channel is changed.

Other pages may be viewed by entering the 3-digit page number – but **DO NOT** press **OK** or these pages will be saved.

Control buttons

Below is a guide to the functions of the remote control text buttons.

To display the index/initial page:

Press  to access the index/initial page. The one displayed is dependant on the broadcaster.



TEXT To display a page of text:

Press **TEXT** to display text. Press again to superimpose text over a normal picture. Press again to return to normal television viewing. Channels cannot be changed until this has been done.

To reveal concealed text:

To discover the solutions on quiz and joke pages press the  button.



To hold a wanted page:

At times it is convenient to hold a page of text. Press  and  will appear in the top left of the screen. The page will be held on screen until the button is pressed again.

To enlarge the text display size:

Press  once to enlarge the top half of the page, press again to enlarge the bottom half of the page. Press again to revert to normal size.

/ **To temporarily erase the text screen:**

Press /  once to erase the text screen temporarily. To recall the text screen, press the button again.

To display news flashes:

Select the news flash page for the chosen text service (see the index page of text service). The news flashes will be displayed as and when they are broadcast.

 **Remember to cancel text before changing channels - press the TEXT button twice.**

Questions and Answers

Below are the answers to some of the most common queries.

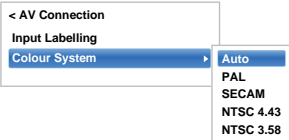
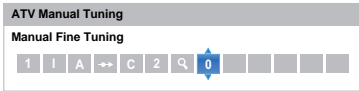
	Question	Answer
Sound	<i>Why is there no sound or picture?</i>	Check the television is not in Standby mode. Check the mains plug and all mains connections.
	<i>Why is there a picture but no sound?</i>	Check all lead connections. No sound or unacceptable format sound may be received. Check the volume has not been turned down or that sound mute has not been selected. Check shared audio settings.
	<i>Why is the soundtrack in English when a different audio language has been selected?</i>	The programme is currently being broadcast with an English soundtrack only.
	<i>Why is there incorrect or no sound when in DTV mode?</i>	Press /I to ensure the hard of hearing option has not been selected.
Picture	<i>There is a picture, but why is there little or no colour?</i>	When using an external source, for instance, a poor quality video tape, if there is little or no colour, improvements may sometimes be achieved. The colour is factory set to Auto to automatically display the best colour system. <i>To check that you have the best colour:</i> 1 With the external source playing, select Colour System from the Options menu.  2 With / choose between Auto , PAL , SECAM , NTSC 4.43 or NTSC 3.58 .
	<i>What else can cause a poor picture?</i>	Interference or a weak signal. Try a different television station. Manual Fine Tuning may help. 1 Select the ATV Manual Tuning menu. Highlight the station and press OK . Then press to select Manual Fine Tuning . 2 Using / adjust to get the best picture and sound. Press OK and then press EXIT . 
	<i>Why doesn't the video/DVD being played show on screen?</i>	Make sure the media recorder or DVD player is connected to the television as shown on page 8, and then select the correct input by pressing .
	<i>Why are there vertical stripes on the screen when in PC mode?</i>	The Sampling Clock may need adjustment. Select PC Settings from the Display Settings menu, highlight Sampling Clock and adjust until the lines clear.

	Question	Answer
Picture	<i>Why are there horizontal stripes and/or blurred images on the screen when in PC mode?</i>	The Clock Phase may need adjustment. Select PC Settings from the Display Settings menu, highlight Clock Phase and adjust until the picture clears.
	<i>Why are the colours wrong when an NTSC source is played?</i>	Connect the source via a SCART lead and play. Select Colour System from the Options menu. 1 Set the Colour to Auto and exit. 2 Go to the Picture menu and adjust the tint.
General	<i>Why don't the controls of the television work?</i>	Check that Panel Lock is not On .
	<i>Why doesn't the remote control work?</i>	Check that batteries aren't exhausted or inserted incorrectly.
	<i>Why is the digital channel locked?</i>	The channel has been locked in Channel Options (see 'Digital settings – Channel Options' section).
	<i>Why are some of the digital subscription channels unavailable?</i>	Your subscription needs upgrading. Contact your service provider.
	<i>What is DVB-T?</i>	Digital Video Broadcast via an aerial/antenna.
	<i>What is DVB-C?</i>	Digital Video Broadcast via a cable connection.
	<i>How are DTV radio channels selected?</i>	Select from All Channel List (LIST button).
	<i>What can be done if the PIN number has been forgotten?</i>	Use the Master PIN code of 1276, then change to a number of your choice. Select Parental PIN Setup from the DTV Settings menu to enter PIN. Ensure that no-one else can use the Master PIN by removing the Owner's Manual.
	<i>Why when digital subtitles have been selected are they not showing on screen?</i>	Subtitles are not currently being transmitted by the broadcaster.
	<i>Why are there problems with analogue text?</i>	Good performance of text depends on a good strong broadcast signal. This normally requires a roof or loft aerial. If the text is unreadable or garbled, check the aerial. Go to the <i>main index</i> page of the text service and look for the <i>User Guide</i> . This will explain the basic operation of text in some detail. If further information is needed on how to use text see <i>the text section</i> .
	<i>Why is a page number visible at the top of the screen but no text?</i>	Text has been selected but Teletext information is currently unavailable on the current source.
	<i>Why don't the devices connected via HDMI operate properly?</i>	Make sure to use cables with the HDMI logo HDMI ™ (see page 9). Some early HDMI equipment may not work properly with the latest HDMI TV products, due to new standard adoption.
<i>Why don't the devices connected via MHL operate properly?</i>	Turn off your TV and unplug the power cord, and then plug and turn on again. Turn the MHL Source Power Off and On again. Try to reconnect a MHL cable.	
<i>Why don't the HDMI CEC Control devices work?</i>	When the connected HDMI CEC Control device does not work correctly after you have changed the settings of the device, turn off your television and unplug the power cord, and then plug and turn on again. Unplug the HDMI cable of the HDMI CEC Control device and lead again.	
<i>Why is the HDMI CEC logo still showing when the equipment has been disconnected?</i>	If the HDMI CEC Control device is disconnected, the logo will disappear after approximately one minute.	

	Question	Answer					
General	Why don't the networked devices work?	The LAN cables are not connected properly or at all. Connect all cables (see page 12). Make sure your network address is set up correctly (see page 47).					
	Why doesn't the wireless network work?	Check that the AP is powered on.					
	Why doesn't the Media Player feature operate?	Make sure that devices are connected correctly. Incorrect behaviour may occur with a USB Hub connection. Check your network setup if using a network media server.					
	Why are not 3D images displayed?	Ensure that there is no object blocking the infrared signals in the infrared reception part of television and 3D glasses. If the infrared data communication between the television and 3D glasses is lost for 5 minutes, the power of 3D glasses is turned off.					
	Why doesn't the USB HDD work?	Your country/area may not support the USB HDD function.					
	Why isn't Skype launched?	Check that the recommended video camera (page 59) is connected to the TV. Ensure the network cable connection (page 12). Check the Network setting of TV. Turn off the TV and unplug the power cord. After 1 minute, plug the power cord in and turn on the TV.					
	Why can't the Skype account be signed in?	If you have no Skype Name, create a Skype Name in Create an account . If you forgot password, visit www.skype.com and confirm the password.					
What do the LEDs on the front of the television indicate?	Check the table below. <table border="1" style="margin-left: auto; margin-right: auto;"> <thead> <tr> <th>LED indication</th> <th>Condition</th> </tr> </thead> <tbody> <tr> <td>Green</td> <td>Power ON</td> </tr> <tr> <td>Red</td> <td>Power OFF (Standby or Active Standby)</td> </tr> </tbody> </table>	LED indication	Condition	Green	Power ON	Red	Power OFF (Standby or Active Standby)
LED indication	Condition						
Green	Power ON						
Red	Power OFF (Standby or Active Standby)						

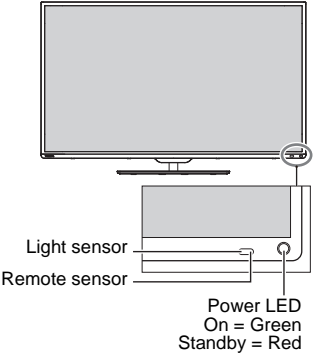

The diagram shows a front view of a television. A small circular LED is located on the bottom right corner of the TV's bezel. Below the TV, a light sensor and a remote sensor are shown with lines indicating their connection to the TV's front panel. A legend below the diagram states: Power LED, On = Green, Standby = Red.

Other problems

If your TV's problem is not addressed in this Questions and Answers section or the recommended solution has not worked, do one of the following:

- 1 Turn off your TV. After 30 seconds, turn it on.
- 2 Turn off the TV and unplug the power cord. After 1 minute, plug the power cord in and turn on the TV.
- 3 Perform the **Reset TV** function in the **Installation** menu.

Information

Before connecting any external equipment, turn off all main power switches. If there is no switch, remove the mains plug from the wall socket.

Signal information for Mini D-sub 15 pin connector

Pin No.	Signal name	Pin No.	Signal name	Pin No.	Signal name
1	R	6	Ground	11	NC
2	G	7	Ground	12	DDC Data
3	B	8	Ground	13	H-sync
4	NC*	9	+5V	14	V-sync
5	Ground	10	Ground	15	DDC Clock

* NC = not connected

Acceptable PC signals through the PC terminal

The PC input on this TV only accepts signal formats which are compliant with VESA-DMT as shown in the table below. Since some PCs input signals which are different from the resolution and frequency described in the table below, the following phenomenon may occur; incorrect display, false format detection, picture position failure, blur, or judder. In this case, set the monitor output format on your PC to conform to a signal in the table below.

Format	Resolution	V. Frequency	H. Frequency	Pixel Clock Frequency	VESA Standard (DMT)
VGA	640 × 480	59.940 Hz	31.469 kHz	25.175 MHz	●
		72.809 Hz	37.861 kHz	31.500 MHz	●
		75.000 Hz	37.500 kHz	31.500 MHz	●
SVGA	800 × 600	56.250 Hz	35.156 kHz	36.000 MHz	●
		60.317 Hz	37.879 kHz	40.000 MHz	●
		72.188 Hz	48.077 kHz	50.000 MHz	●
		75.000 Hz	46.875 kHz	49.500 MHz	●
XGA	1024 × 768	60.004 Hz	48.363 kHz	65.000 MHz	●
		70.069 Hz	56.476 kHz	75.000 MHz	●
		75.029 Hz	60.023 kHz	78.750 MHz	●
WXGA	1280 × 768	59.995 Hz	47.396 kHz	68.250 MHz	●
		59.870 Hz	47.776 kHz	79.500 MHz	●
		74.893 Hz	60.289 kHz	102.250 MHz	●
	1280 × 800	59.810 Hz	49.702 kHz	83.500 MHz	
	1360 × 768	60.015 Hz	47.712 kHz	85.500 MHz	●
WXGA+	1440 × 900	59.887 Hz	55.935 kHz	106.500 MHz	
SXGA	1280 × 1024	60.020 Hz	63.981 kHz	108.000 MHz	●
		75.025 Hz	79.976 kHz	135.000 MHz	●
1080p	1920 × 1080p	60.000 Hz	67.500 kHz	148.500 MHz	

Acceptable video or PC signals through the HDMI terminals

The HDMI inputs on this TV only accept VGA, SVGA, XGA, WXGA, and SXGA signal formats which are compliant with VESA as shown in the table below. Since some PCs and HDMI or DVI devices input signals which are different from the resolution and frequency described in the table below, the following phenomenon may occur: incorrect display, false format detection, picture position failure, blur, or judder.

In this case, set the monitor output format on your PC, HDMI or DVI device to conform to a signal in the table below.

Format	Resolution	V. Frequency	H. Frequency	Pixel Clock Frequency	VESA Standard
480i	720 × 480i	59.940/60.000 Hz	15.734/15.750 kHz	27.000/27.027 MHz	
576i	720 × 576i	50.000 Hz	15.625 kHz	27.000 MHz	
480p	720 × 480p	59.940/60.000 Hz	31.469/31.500 kHz	27.000/27.027 MHz	
576p	720 × 576p	50.000 Hz	31.250 kHz	27.000 MHz	
1080i	1920 × 1080i	59.940/60.000 Hz	33.716/33.750 kHz	74.176/74.250 MHz	
1080i	1920 × 1080i	50.000 Hz	28.125 kHz	74.250 MHz	
720p	1280 × 720p	59.940/60.000 Hz	44.955/45.000 kHz	74.176/74.250 MHz	
720p	1280 × 720p	50.000 Hz	37.500 kHz	74.250 MHz	
1080p	1920 × 1080p	59.940/60.000 Hz	67.433/67.500 kHz	148.352/148.500 MHz	
1080p	1920 × 1080p	50.000 Hz	56.250 kHz	148.500 MHz	
1080p	1920 × 1080p	24.000 Hz	27.000 kHz	74.250 MHz	
1080p	1920 × 1080p	29.970/30.000 Hz	33.720/33.750 kHz	74.176/74.250 MHz	
1080p	1920 × 1080p	25.000 Hz	28.130 kHz	74.250 MHz	
VGA	640 × 480	59.940/60.000 Hz	31.469/31.500 kHz	25.175/25.200 MHz	●
		72.809 Hz	37.861 kHz	31.500 MHz	●
		75.000 Hz	37.500 kHz	31.500 MHz	●
SVGA	800 × 600	56.250 Hz	35.156 kHz	36.000 MHz	●
		60.317 Hz	37.879 kHz	40.000 MHz	●
		72.188 Hz	48.077 kHz	50.000 MHz	●
		75.000 Hz	46.875 kHz	49.500 MHz	●
XGA	1024 × 768	60.004 Hz	48.363 kHz	65.000 MHz	●
		70.069 Hz	56.476 kHz	75.000 MHz	●
		75.029 Hz	60.023 kHz	78.750 MHz	●
WXGA	1280 × 768	59.995 Hz	47.396 kHz	68.250 MHz	●
		59.870 Hz	47.776 kHz	79.500 MHz	●
		74.893 Hz	60.289 kHz	102.250 MHz	●
	1360 × 768	60.015 Hz	47.712 kHz	85.500 MHz	●
SXGA	1280 × 1024	60.020 Hz	63.981 kHz	108.000 MHz	●
		75.025 Hz	79.976 kHz	135.000 MHz	●

Media Player Supported Format

Media Player	Media Format	File Extension	Video codec	Audio codec	USB	Network	Note
Photo	JPEG	.jpg .jpeg	JPEG	-	yes	yes	USB Data compatibility: JPEG Exif ver 2.2 Maximum viewable resolution: •JPEG 15360 × 8640 (Baseline) 1024 × 768 (Progressive) •BMP 9600 × 6400 Maximum number of files: 1000 / folder Network Data compatibility: JPEG Exif ver 2.2 Maximum viewable resolution: 4096 × 4096 Maximum number of files: 1000/folder NOTE: Some files may not be played.
	MPO	.mpo	MPO	-	yes	no	
	BMP	.bmp	BMP	-	yes	no	
Movie	AVI	.avi	MPEG-2 MPEG-4 part2 H.264 (MPEG-4 AVC) DivX Xvid	MPEG-1/2 Layer2 MPEG-1/2 Layer3 Dolby Digital (AC-3) L-PCM ADPCM MPEG-2/4 LC-AAC MPEG-4 HE-AAC	yes	no	USB Maximum number of files: 1000 / folder Maximum viewable resolution: • Motion-JPEG:640 × 480 • Other:1920 × 1080 Network Maximum video resolution: 1920 × 1080 Maximum number of file:1000 / folder Maximum video size: Unlimited NOTE: Some files may not be played.
	MPEG-2 PS	.mpg .mpeg	MPEG-1 Video MPEG-2 Video	MPEG-1/2 Layer3 MPEG-1/2 Layer2 Dolby Digital (AC-3) L-PCM	yes yes	no yes	
	MPEG-2 TS	.ts .trp .tp	MPEG-2 Video H.264(MPEG-4 AVC) VC-1(WMV9)	MPEG-1/2 Layer3 Dolby Digital (AC-3) L-PCM MPEG-4 LC-AAC MPEG-4 HE-AAC	yes yes	yes no	
	MPEG-2 VOB	.vob	MPEG-1 Video MPEG-2 Video	MPEG-1/2 Layer2 MPEG-1/2 Layer3 Dolby Digital (AC-3) L-PCM	yes	no	

Media Player	Media Format	File Extension	Video codec	Audio codec	USB	Network	Note
Movie	MOV	.mov	H.264 (MPEG-4 AVC) MPEG-4 part2	MPEG-1/2 Layer3 MPEG-2/4 LC-AAC MPEG-4 HE-AAC	yes	no	
	MP4	.mp4 .m4v	H.264 (MPEG-4 AVC) MPEG-4 part12,14	MPEG-1/2 Layer3 MPEG-4 HE-AAC	yes	no	
			H.264 (MPEG-4 AVC)	MPEG-2/4 LC-AAC	yes	yes	
	ASF	.asf .wmv	VC-1 (WMV9)	WMA7/8/9 Std WMA9 Pro	yes	no	
	DivX	.divx .div	DivX 3,4,5,6	MPEG-1/2 Layer2 MPEG-1/2 Layer3 Dolby Digital (AC-3) PCM ADPCM	yes	no	
	Xvid	.xvid	Xvid				
	MKV	.mkv	MPEG-1 Video MPEG-2 Video MPEG-4 part2 H.264 (MPEG-4 AVC)	MPEG-1/2 Layer2 MPEG-1/2 Layer3 Dolby Digital (AC-3) L-PCM MPEG-2/4 LC-AAC MPEG-4 HE-AAC	yes	no	
	Flash Video (FLV1)	.flv .swf	Sorenson H.263 (FLV1) H.264 (MPEG-4 AVC)	MPEG-1/2 Layer3 MPEG-2/4 LC-AAC L-PCM ADPCM	yes	no	
	3GPP	.3gp	MPEG-4 part2 H.264 (MPEG-4 AVC)	MPEG-2/4 LC-AAC	yes	no	
Motion JPEG	.avi .mp4 .mkv	JPEG	L-PCM ADPCM	yes	no		
Music	MP3	.mp3	–	MPEG-1/2 Layer-3	yes	yes	USB Maximum number of files: 1000 / folder Maximum music size: Unlimited Network Sampling rate: 32, 44.1 and 48 KHz Bit rate: 32 to 320 kbps Maximum number of files: 1000 / folder Maximum music size: Unlimited NOTE: Some files may not be played.
	MP4	.m4a	–	MPEG-2/4 LC-AAC	yes	yes	
	WMA	.wma	–	WMA7/8/ Std	yes	no	
				WMA9 Std	yes	yes	
				WMA9 Pro	yes	no	
WAV	.wav	–	LPCM ADPCM MPEG-1/2 Layer-3 WMA7/8/9/ Std WMA9 Pro	yes	no		
LPCM		–		no	yes		

3D Support Format (HDMI)

Resolution	Aspect ratio	V.Frequency	H.Frequency	Pixel Clock Frequency	3D Structure
720 x 480p	16:9	59.940/60.000 Hz	31.469/31.500 kHz	54.000/54.054 MHz	Side by Side (Full)
				27.000/27.027 MHz	Side by Side (Half)
					Top and Bottom
720 x 576p	16:9	50.000 Hz	31.250 kHz	27.000 MHz	Side by Side (Full)
					Side by Side (Half)
					Top and Bottom
1280 x 720p	16:9	59.940/60.000 Hz	90.0/89.91 kHz	148.352/148.500 MHz	Frame Packing
			44.955/45.000 kHz	74.176/74.250 MHz	Side by Side (Half)
					Top and Bottom
		50.000 Hz	75.000 kHz	148.500 MHz	Frame Packing
			37.500 kHz	74.250 MHz	Side by Side (Half)
					Top and Bottom
1920 x 1080i	16:9	59.940/60.000 Hz	33.716/33.750 kHz	74.176/74.250 MHz	Side by Side (Half)
					Top and Bottom
		50.000 Hz	28.130 kHz	74.250 MHz	Side by Side (Half)
			Top and Bottom		
1920 x 1080p	16:9	23.976/24.000 Hz	53.940/54.000 kHz	148.352/148.500 MHz	Frame Packing
			26.973 kHz	74.176/74.250 MHz	Side by Side (Half)
					Top and Bottom
		29.970/30.000 Hz	67.433/67.500 kHz	148.352/148.500 MHz	Frame Packing
			33.716/33.750 kHz	74.176/74.250 MHz	Side by Side (Half)
					Top and Bottom
		50.000 Hz	56.250 kHz	148.500 MHz	Side by Side (Half)
					Top and Bottom
Side by Side (Half)					
			Top and Bottom		
59.940/60.000 Hz	67.433/67.500 kHz	148.352/148.500 MHz	Side by Side (Half)		
			Top and Bottom		

3D Support Format (DTV)

Video Format	Aspect ratio	V.Frequency	3D Structure
480i, 480p	16:9	59.940/60.000 Hz	Side by Side (Half)
			Top and Bottom
576i, 576p	16:9	50.000 Hz	Side by Side (Half)
			Top and Bottom
720p	16:9	59.940/60.000 Hz	Side by Side (Half)
			Top and Bottom
		50.000 Hz	Side by Side (Half)
			Top and Bottom
1080i	16:9	59.940/60.000 Hz	Side by Side (Half)
			Top and Bottom
		50.000 Hz	Side by Side (Half)
			Top and Bottom
1080p	16:9	24.000 Hz	Side by Side (Half)
			Top and Bottom
		30.000 Hz	Side by Side (Half)
			Top and Bottom
		50.000 Hz	Side by Side (Half)
			Top and Bottom
		59.940/60.000 Hz	Side by Side (Half)
			Top and Bottom

- * Side by Side (Full) is composed of left and right stereoscopic pictures that each size is equal to 2D.
- * The 3D function and 2D to 3D conversion function does not support all content depending on its input source format.

Side by Side (Full)

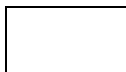

2D Video



3D Video

Side by Side (Half)

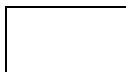

2D Video

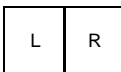

3D Video

Licence information



- Manufactured under license from Dolby Laboratories. Dolby and the double-D symbol are trademarks of Dolby Laboratories.



- HDMI, the HDMI logo, and High-Definition Multimedia Interface are trademarks or registered trademarks of HDMI Licensing LLC in the United States and other countries.
- This product contains Adobe® Flash® Player software under license from Adobe Systems Incorporated. Copyright© 1995-2009 Adobe Systems Incorporated. All rights reserved. Adobe and Flash are trademarks of Adobe Systems Incorporated.



- DivX®, DivX Certified®, DivX Plus® HD and associated logos are trademarks of Rovi Corporation or its subsidiaries and are used under license. Covered by one or more of the following U.S. patents: 7,295,673; 7,460,668; 7,515,710; 7,519,274
- DVB is a registered trademark of the DVB Project.
- Hybrid TV Standard is implemented according to ETSI TS 102 796 v1.1.1.
- Intel and the Intel logo are trademarks of Intel Corporation in the U.S. and/or other countries.



- MHL, Mobile High-Definition Link and the MHL Logo are trademarks or registered trademarks of the MHL, LLC.



- Manufactured under license from Audyssey Laboratories. U.S. and foreign patents pending. Audyssey Premium Television™ is a trademark of Audyssey Laboratories. Audyssey Premium Television™ is a suite of technologies that remove the acoustical problems caused by small speakers and drivers. Working together these technologies deliver a better translation of the audio content and make the television experience sound closer to the original.

- DLNA™, DLNA CERTIFIED™, DLNA CERTIFIED Logo are trademarks, service marks, or certification marks of the Digital Living Network Alliance.

- THIS PRODUCT IS LICENSED UNDER THE AVC PATENT PORTFOLIO LICENSE FOR THE PERSONAL AND NONCOMMERCIAL USE OF A CONSUMER TO (i) ENCODE VIDEO IN COMPLIANCE WITH THE AVC STANDARD (AVC VIDEO) AND/OR (ii) DECODE AVC VIDEO THAT WAS ENCODED BY A CONSUMER ENGAGED IN A PERSONAL AND NONCOMMERCIAL ACTIVITY AND/OR WAS OBTAINED FROM A VIDEO PROVIDER LICENSED TO PROVIDE AVC VIDEO. NO LICENSE IS GRANTED OR SHALL BE IMPLIED FOR ANY OTHER USE. ADDITIONAL INFORMATION MAY BE OBTAINED FROM MPEG LA, L.L.C. SEE [HTTP://WWW.MPEGLA.COM](http://www.mpegla.com)
- THIS PRODUCT IS LICENSED UNDER THE MPEG-4 VISUAL PATENT PORTFOLIO LICENSE FOR THE PERSONAL AND NONCOMMERCIAL USE OF A CONSUMER FOR (i) ENCODING VIDEO IN COMPLIANCE WITH THE MPEG-4 VISUAL STANDARD ("MPEG-4 VIDEO") AND/OR (ii) DECODING MPEG-4 VIDEO THAT WAS ENCODED BY A CONSUMER ENGAGED IN A PERSONAL AND NON-COMMERCIAL ACTIVITY AND/OR WAS OBTAINED FROM A VIDEO PROVIDER LICENSED BY MPEG LA TO PROVIDE MPEG-4 VIDEO. NO LICENSE IS GRANTED OR SHALL BE IMPLIED FOR ANY OTHER USE. ADDITIONAL INFORMATION INCLUDING THAT RELATING TO PROMOTIONAL, INTERNAL AND COMMERCIAL USES AND LICENSING MAY BE OBTAINED FROM MPEG LA, L.L.C. SEE [HTTP://WWW.MPEGLA.COM](http://www.mpegla.com)
- MPEG Layer-3 audio coding technology licensed from Fraunhofer IIS and Thomson.
- RealID and the RealID logo are trademarks of RealD Inc.
- You can check the software components and obtain a copy of the source codes including GPL and LGPL subject to such EULA requirements on the following Home Page: <http://tesc.toshiba.co.uk/Web/Website.nsf/ContentFrameSet?OpenFrameset> There will be a charge to cover the costs of providing the source code.

EU Conformity Statement

This product is carrying the CE-Mark in accordance with the related European Directives.

Responsible for CE-Marking is TOSHIBA TELEVISION CENTRAL EUROPE Sp. z o.o., ul. Pokoju 1 Biskupice
Podgórze 55-040 Kobierzyce, Poland

This product is labeled with the CE Mark in accordance with the related European Directives, notably Low Voltage Directive 2006/95/EC, Electromagnetic Compatibility Directive 2004/108/EC and RoHS Directive 2011/65/EU.

Furthermore the product complies with the Ecodesign Directive 2005/32/EC (EuP) and 2009/125/EC (ErP) and its related implementing measures.

If this product has an integrated Wireless LAN feature, the Radio Equipment and Telecommunications Terminal Equipment Directive 1999/5/EC is also applicable.

Cleaning the screen and cabinet...

Turn off the power, and clean the screen and cabinet with a soft, dry cloth. We recommend that you **do not** use any proprietary polishes or solvents on the screen or cabinet as this may cause damage.

Disposal...

The following information is only for EU-member states:

Disposal of products

The crossed out wheeled dust bin symbol indicates that products must be collected and disposed of separately from household waste. Integrated batteries and accumulators can be disposed of with the product. They will be separated at the recycling centres.

The black bar indicates that the product was placed on the market after August 13, 2005.

By participating in separate collection of products and batteries, you will help to assure the proper disposal of products and batteries and thus help to prevent potential negative consequences for the environment and human health.

For more detailed information about the collection and recycling programmes available in your country, please contact your local city office or the shop where you purchased the product.

**Disposal of batteries and/or accumulators**

The crossed out wheeled dust bin symbol indicates that batteries and/or accumulators must be collected and disposed of separately from household waste.

If the battery or accumulator contains more than the specified values of lead (Pb), mercury (Hg), and/or cadmium (Cd) defined in the Battery Directive (2006/66/EC), then the chemical symbols for lead (Pb), mercury (Hg) and/or cadmium (Cd) will appear below the crossed out wheeled dust bin symbol.

By participating in separate collection of batteries, you will help to assure the proper disposal of products and batteries and thus help to prevent potential negative consequences for the environment and human health.

For more detailed information about the collection and recycling programmes available in your country, please contact your local city office or the shop where you purchased the product.



Cautions and other information for 3D

Important information for 3D viewing

Available 3D glasses :

Toshiba FPT-AG03
(L73*5D/M83*5D: 2pcs supplied, L73**RK/L73**RB:
1pcs supplied, L73*3D/L73*1D: Not supplied)

CAUTION

- **This product contains a coin/button cell battery. Danger of explosion if battery is incorrectly replaced. Replace only with the same or equivalent type.**
- **The 3D function has been designed for private use and entertainment in your home environment. Please note that any commercial use of the 3D function could lead to copyright infringement of authors' rights. Toshiba asks you to respect the intellectual property rights of third parties.**

About handling the 3D glasses

- **Do not leave the 3D glasses or the accessories within the reach of small children.**
Inhaling or swallowing them may cause suffocation or lesions in the stomach wall.
If swallowed, consult a doctor immediately.
- **Do not repair, modify, or disassemble the 3D glasses by yourself.**
Doing so may cause a fire or cause you to become indisposed while viewing 3D images.
Contact the Toshiba Call Center for repair of your 3D glasses.
- **Do not expose the glasses to excessive heat such as sunshine, fire, or the like.**

About the 3D glasses

- **Do not use the 3D glasses if they are not working properly or broken.**
Continuing to use them in such a state may cause injury, eye strain, or indisposition.
Do not use the 3D glasses if they are broken or have any cracks.
- **Do not stand or walk while wearing 3D glasses.**
You may lose your balance which could result in falls or other accidents.
- **Do not wear the 3D glasses for any purpose other than viewing 3D programming.**
3D glasses do not function as sunglasses.
- **Do not drop, exert pressure on, or step on the 3D glasses.**
Doing so may damage the glass section, which may result in injury.
Exposing the 3D glasses to liquid or excessive heat may damage the liquid crystal shutter function.
- **If your nose or temple turns red, or you feel pain or discomfort, stop using the 3D glasses.**
Such symptoms as above may occur if you keep wearing them for a long time, which may also cause indisposition.
- **Be careful not to pinch your fingers in the hinge of the 3D glasses.**

Cautions on watching 3D images

- **Some viewers may experience a seizure or blackout when exposed to certain flashing images or lights contained in certain 3D television pictures or video games.**
Anyone who has had a seizure, loss of awareness, or other symptoms linked to an epileptic condition, or has a family history of epilepsy, should contact a health care provider before using the 3D function.
- **Avoid use of the 3D function when under the influence of alcohol.**
- **If you are ill or feel ill, you should refrain from viewing 3D images, and consult your health care provider as may be appropriate.**
- **If you experience any of the following symptoms when viewing 3D video images, stop viewing and contact your health care provider:**
Convulsions, eye or muscle twitching, loss of awareness, altered vision, involuntary movements, disorientation, eye strain, nausea/vomiting, dizziness, headaches.
- **If you feel eye fatigue or other discomfort from viewing 3D video images, remove the 3D glasses and discontinue use until the condition is eliminated.**
- **Viewing in 3D may cause dizziness and/or disorientation for some viewers.**
Therefore, to avoid injury do not place your TV near open stairwells, balconies, or wires.
Also do not sit near objects that could be broken if accidentally hit.
- **When viewing 3D images, always wear 3D glasses.**
Watching 3D images without 3D glasses may cause eye strain.
Use specified 3D glasses.
- **When watching 3D images, do not wear 3D glasses at an angle and do not lie down.**
If you watch while lying down or with the glasses tilted, the 3D effect is lost and it may cause eye strain.
- **If 3D images often appear in double or if you cannot see the images in 3D, stop viewing.**
Continuous viewing may cause eye strain.
- **Due to the possible impact on vision development, viewers of 3D video images should be age 6 or above.**
Children and teenagers may be more susceptible to health issues associated with viewing in 3D and should be closely supervised to avoid prolonged viewing without rest.
- **Watching TV while sitting too close to the screen for an extended period of time may cause eye strain.**
The ideal viewing distance should be at least three times the screen height.
- **Switching left and right images**
The left and right eye shutter timing of the glasses can be swapped. If 3D images look blurred, switch the left and right sides of the 3D image.

If the 3D PIN number has been forgotten:

Use the Master PIN code of 1276, and then change to a number of your choice. Select **3D PIN** from the **3D Setup** menu to enter PIN.

Notes on handling the 3D glasses' liquid crystal shutter lenses

- Do not put excessive force on the lenses.
- Do not scratch the surface of the lenses with sharp objects.
- Do not drop or bend the 3D glasses.

Notes on IR communication

- Do not block the IR sensor for 3D glasses on the TV by placing objects in front of it.
- Do not cover the IR sensor on the 3D glasses with stickers or labels.
- Keep the IR sensor on the 3D glasses clean.
- The use of 3D glasses could interfere with other IR communication devices. Other IR communication devices may cause the 3D glasses not to work correctly. Use the TV and 3D glasses in a place where they will not interfere with other devices or products.

Notes on watching the TV

- 3D effect and image quality may vary depending upon content quality and display device capability/functionality/settings.
- If you use any device, such as a mobile phone or mobile wireless device, near the 3D glasses, the 3D glasses may not work correctly.
- Use the product in the following temperature range; otherwise, the quality of the 3D image or the reliability of the product cannot be guaranteed.
 - 3D glasses: 0 °C - 40 °C (32 °F - 104 °F)
 - TV: 0 °C - 35 °C (32 °F - 95 °F)

- If you use a fluorescent light, it may flicker depending on the frequency of the light. In this case, reduce the brightness of the fluorescent light, or use another light. (It is not recommended to watch the TV in a dark room, especially for children.)
- Wear the 3D glasses properly, otherwise you may not see the correct 3D image.
- When not viewing 3D images on this unit, take off the 3D glasses; otherwise, it may be difficult to see the display on other products such as PC, digital clock or calculator, etc.
- The 2D to 3D conversion function is activated and controlled by you according to your personal preferences.
- The 2D to 3D conversion function is meant for enjoyment of 2D home video, and other 2D content you create, in 3D according to your personal preferences.
- The 2D to 3D conversion function is not intended for use with pre-recorded 2D copyrighted content owned by a third-party unless the copyright owner has given direct or indirect permission, or unless applicable law permits such use.

About the connecting cable

- Use a high-speed and high-quality HDMI cable when you connect a device such as 3D compatible BD player or PC to the TV. When you use a standard HDMI cable, 3D images may not be shown.

Specifications and accessories

Receiving systems

DVB-T Broadcast systems/ channels		Broadcast systems/channels	
UK	UHF 21-68	PAL-I	UHF UK21-UK69
France	VHF 05-10 (VHF 01-05) UHF 21-69	PAL-B/G	UHF E21-E69 VHF E2-E12, S1-S41
Germany	VHF 05-12 UHF 21-69	SECAM-L	UHF F21-F69 VHF F1-F10, B-Q
Austria	VHF 05-12 UHF 21-69	SECAM-D/K	UHF R21-R69 VHF R1-R12
Switzerland	VHF 05-12 UHF 21-69		
Italy	VHF 05-12 (D,E,F,G,H,H1,H2) UHF 21-69		
Spain	UHF 21-69		
Netherlands	VHF 05-12 UHF 21-69		
Greece	VHF 05-12 UHF 21-69		

DVB-C Broadcast systems

DVB-T2 Broadcast systems (L735*/L736*/M836* series only)

DVB-S/DVB-S2 Broadcast systems (L736*/M836* series only)

Video Input PAL, SECAM, NTSC 3.58/4.43

External connections

EXT 1	Input/Output	21-pin SCART	RGB, A/V input AV out, TV out
EXT 2	Input	RCA jacks RCA jack	Y, P _B /C _B , P _R /C _R Video (Y is shared)
		RCA jacks	Audio L + R (shared)
HDMI 1/2/3/4	Input	HDMI [®] compliant	HDCP compliant
		HDMI 3 is compatible with MHL	
PC	Input	Mini D-sub 15-pin	Analogue
Digital Audio Output (S/PDIF)		Optical	
LAN port		RJ-45	
USB 1/USB 2 port		Media Player Interface version: USB 2.0 USB class: Mass Storage File system: FAT16 and FAT32	
Headphone socket		3.5 mm stereo	
Stereo		A2, Nicam 2 carrier system	
Visible Screen Size (approx.)		40L/40M	102 cm
		50L/50M	126 cm
		58L/58M	146 cm
Screen resolution (H x V pixels)		40L/40M	1920 x 1080
		50L/50M	1920 x 1080
		58L/58M	1920 x 1080
Display		16:9	
Sound output (at 10 % distortion)		Main:	10 W + 10 W

Power consumption (approx.)	40L/40M	119 W
	50L/50M	154 W
	58L/58M	184 W

Standby power consumption
(approx.) 0.3 W

Energy Efficiency Class	40L/40M	A+
	50L/50M	A+
	58L/58M	A+

On-mode power consumption*
(approx.) 40L/40M 48.1 W

50L/50M 75.9 W

58L/58M 88.0 W

Average annual energy consumption**

40L/40M 66.7 kWh/y

50L/50M 105.3 kWh/y

58L/58M 122.1 kWh/y

* Tested in accordance with IEC 62087-BD in default settings.

** Operating 4 hours a day and 365 days a year.

Dimensions (approx.)	40L73*6	61.0 cm (H)	92.2 cm (W)
		18.0 cm (D)	
	40L/40M (except 40L73*6)	60.0 cm (H)	92.2 cm (W)
		18.2 cm (D)	
	50L/50M	73.3 cm (H)	113.1 cm (W)
		23.2 cm (D)	
	58L/58M	85.1 cm (H)	130.6 cm (W)
		33.4 cm (D)	

(Height dimension includes foot stand)

Weight (approx.)	40L73*6	11.5 kg
	40L/40M (except 40L73*6)	12.0 kg
	50L/50M	20.0 kg
	58L/58M	28.0 kg

Operating condition Temperature 5 °C - 35 °C (41 °F - 94 °F)

Humidity 20 - 80 % (non-condensing)

- Wireless connection**
- Standard: IEEE 802.11a/b/g/n
 - Frequency Range: 5.15-5.35 GHz, 5.47-5.725 GHz, 5.725-5.850 GHz, 2.400-2.4835 GHz
 - Security: WEP64/128, TKIP, AES, WPA/WPA2-PSK, WPS, None

- Supplied accessories**
- Toshiba 3D glasses : FPT-AG03 : L73*5D/ M83*5D (2pcs), L73**RK/L73**RB (1pcs)
 - Remote control CT-90430
 - 2 batteries (AAA, IEC R03 1.5 V)
 - Screw (for TV mounting) See page 5.

- Optional accessories**
- USB HDD : HDTCC610EK3B1, HDTCC610EL3B1, HDTCC610EW3B1
 - Skype camera : TALK-7291
 - Toshiba 3D glasses : FPT-AG03

Specification is subject to change without notice.

© TOSHIBA Television Central Europe Sp. z o.o.

All rights reserved.

Reproduction in whole or part without written permission is strictly prohibited.

TOSHIBA Television Central Europe Sp. z o.o.

ul. Pokoju 1, Biskupice Podgórne, 55-040 Kobierzyce, Poland