

TOSHIBA

Leading Innovation >>>

**SL86* Digital
Series**

**UL86* Digital
Series**

**UL87* Digital
Series**

EUROPEAN UNION ECOLABEL



Awarded to goods or services which meet the environmental requirements of the EU ecolabelling scheme

REGZA



Contents

INSTALLING YOUR TV

Safety Precautions	4
Installation and important information	5
The remote control	8
Inserting batteries and effective range	8
The remote control	9
Inserting batteries and effective range	9

CONNECTING YOUR TV

Connecting external equipment	10
Connecting an HDMI® or DVI device to the HDMI input	11
To connect an HDMI device	11
To connect a DVI device	11
HDMI's ARC (Audio Return Channel) feature	11
REGZA-LINK connection	12
Connecting a computer	13
To connect a PC to the RGB/PC terminal	13
To connect a PC to the HDMI terminal	13
Connecting a home network	14
To connect the TV to a home network - Wired	14
To connect the TV to a home network with an internet connection - Wireless	14
Setting up the USB HDD (for UL86/UL87 series)	15
Controls and input connections	16
Switching on	16
Using the remote control	16
Using the TV controls and connections	16
MENU structure	17

SETTING UP YOUR TV

Startup Application	18
Quick Setup	18
Ant/Cable/Satellite (if available)	19
Satellite Settings	20
Auto Tuning	22
ATV Manual Tuning	23
Tuning	23
Skip	24
Sorting positions	24
DTV Manual Tuning	25
Manual Tuning	25
Manual Tuning for DVB-C	25
Manual Tuning for DVB-S	25
DTV Settings	26
Channels (Antenna/Cable)	26
Channels (Satellite)	27
Standby Channel Update	27
DVB Character Set	27
Dynamic Scan	27
Location setting	28
Analogue switch-off	28

CONTROLS AND FEATURES

General controls	29
Quick Menu	29
Selecting channels	29
The Time Display – analogue only	29
Stereo and Bilingual transmissions	29
Sound controls	30
Volume controls and sound mute	30
Dual	30
Balance	30
Sound Navi	30
Surround Settings	30
Dolby Volume®	30
Dynamic Range Control	31
Audio Level Offset	31
Headphone Settings	31
Audio Description	31
Widescreen viewing	32
Picture controls	34
Picture Mode	34
Picture preferences	34
Reset	34
ColourMaster	34
Base Colour Adjustment	35
Colour Temperature	35
Auto Brightness Sensor Settings	35
Active Backlight Control	35
Black/White Level	36
Static Gamma	36
MPEG NR – Noise Reduction	36
DNR – Digital Noise Reduction	36
Resolution+	36
Active Vision M100	36
Motion Detection Range	36
Resetting the advanced picture settings	37
Expert Picture Settings	37
Control Visualization	39
Automatic Format (Widescreen)	39
4:3 Stretch	39
Blue Screen	39
Picture Position	39
Picture still	40
HDMI Information Display	40
Using your home network	41
Wireless LAN information (for UL86/UL87 series)	42
Setting up the Network	43
Wireless Setup	43
Advanced Network Setup	45
DNS Setup	46
Network Connection Test	47
Using the software keyboard	47
Network Device Setup	48
External Control Setup	48
Media Renderer Setup	48
Power Control Mode	49
Device Name Setup	49

Using the USB HDD Function (for UL863 and UL875 series)	49	Software Upgrade and Licences	79
To record DTV programmes (One Touch Recording)	50	Auto Upgrade	79
To schedule programmed recording	50	Searching for New Software	79
To check, edit or delete scheduling information	53	Network Upgrade	80
To view a recorded programme	53	Software Licences	80
Operations from the Library screen	54	System Information and Reset TV	80
Other useful functions (Time Shift Recording)	55	System Information	80
Recording Setup	55	Reset TV	80
To disconnect a USB HDD	56	PC Settings	81
To confirm/delete Recording Information	57	Horizontal and Vertical Position	81
Scheduling priority	57	Clock Phase	81
Camera Sensor Settings	58	Sampling Clock	81
Using Toshiba Places	59	Reset	81
Using YouTube™	59	Input selection and AV connections	82
Using the Function Menu	60	Input selection	82
Using Hybrid TV Standard (if available)	62	External input skip	82
Using the Media Player	62	Labeling video input sources	83
Basic operation	63	PC Audio	83
Viewing photo files (on a DLNA CERTIFIED™ Server or USB device)	64	HDMI 3 Audio	83
Viewing movie files (on a DLNA CERTIFIED™ Server or USB device)	66	HDMI Settings	84
Playing music files (on a DLNA CERTIFIED™ Server or USB device)	68	Digital Audio Output	84
Using the Photo Frame feature	70	Using Personal TV Mode	85
To open Photo Frame	70	Using REGZA-LINK	87
Setting the features	70	Enable REGZA-LINK	87
Other features	72	TV Auto Power	87
Panel Lock	72	Auto Standby	87
The timers	72	Amplifier Control	87
Programme Timers – digital only	72	Initial Speaker Setting	87
On Timer	73	Position Key Pass Through	87
Sleep Timer	73	REGZA-LINK input source selection	88
Energy Saving Settings	74	REGZA-LINK Device Control	88
Automatic Power Down	74	REGZA-LINK one touch play	88
No Signal Power Down	74	REGZA-LINK system standby	88
Digital on-screen information and Programme Guide	74	REGZA-LINK system audio control	89
Information	74	Toshiba PC compatible with REGZA-LINK	89
Guide	75	TEXT SERVICES	
Genre selection/searching	76	Text services	90
Digital settings – parental control	76	Selecting modes	90
Parental PIN Setup	76	Text information	90
Parental Setup	77	Navigating pages using Auto	90
Network Lock	77	Navigating pages using LIST	90
Digital settings – Channel Options	77	Control buttons	91
Selecting favourite channels	77	PROBLEM SOLVING	
Favourite Channel Lists	77	Questions and Answers	92
Skip channels	78	INFORMATION	
Locking channels	78	License Information	95
Digital settings – other settings	78	Information	97
Subtitles	78	Specifications and accessories	100
Audio languages	78		
Common Interface	79		

Safety Precautions

This equipment has been designed and manufactured to meet international safety standards but, like any electrical equipment, care must be taken to obtain the best results and for safety to be assured. Please read the points below for your own safety. They are of a general nature, intended to help with all electronic consumer products, and some points may not apply to the goods you have just purchased.

Air Circulation

Leave more than 10cm clearance around the television to allow adequate ventilation. This will prevent overheating and possible damage to the television. Dusty places should also be avoided.

Heat Damage

Damage may occur if the television is left in direct sunlight or near a heater. Avoid places subject to extremely high temperatures or humidity. Place in a location where the temperature remains between 5°C (41°F) min. and 35°C (94°F) max.

Mains Supply

The mains supply required for this equipment is 220-240v AC 50/60Hz. Never connect to a DC supply or any other power source. DO ensure that the television is not standing on the mains lead. Use only the supplied lead.

DO NOT cut off the mains plug from this equipment, this incorporates a special Radio Interference Filter, the removal of which will impair its performance. IF IN DOUBT, PLEASE CONSULT A COMPETENT ELECTRICIAN.

Do

DO read the operating instructions before you attempt to use the equipment.

DO ensure that all electrical connections (including the mains plug, extension leads and inter-connections between pieces of equipment) are properly made and in accordance with the manufacturers' instructions. Switch off and withdraw the mains plug before making or changing connections.

DO consult your dealer if you are ever in doubt about the installation, operation or safety of your equipment.

WARNING: To prevent injury, this apparatus must be securely attached to the floor/wall in accordance with the installation instructions. See page 5.

DO be careful with glass panels or doors on equipment.

DO NOT REMOVE ANY FIXED COVERS AS THIS WILL EXPOSE DANGEROUS AND 'LIVE' PARTS.

THE MAINS PLUG IS USED AS A DISCONNECTING DEVICE AND THEREFORE SHOULD BE READILY OPERABLE.

Do not

DO NOT obstruct the ventilation openings of the equipment with items such as newspapers, tablecloths, curtains, etc. Overheating will cause damage and shorten the life of the equipment.

DO NOT allow electrical equipment to be exposed to dripping or splashing or objects filled with liquids, such as vases, to be placed on the equipment.

DO NOT place hot objects or naked flame sources, such as lighted candles or nightlights on, or close to equipment. High temperatures can melt plastic and lead to fires.



WARNING: To prevent the spread of fire, keep candles or other open flames away from this product at all times.

DO NOT use makeshift stands and NEVER fix legs with wood screws. To ensure complete safety, always fit the manufacturer's approved stand, bracket or legs with the fixings provided according to the instructions.

DO NOT leave equipment switched on when it is unattended, unless it is specifically stated that it is designed for unattended operation or has a standby mode. Switch off by withdrawing the plug, and make sure your family knows how to do this. Special arrangements may need to be made for people with disabilities.

DO NOT continue to operate the equipment if you are in any doubt about it working normally, or it is damaged in any way – switch off, withdraw the mains plug and consult your dealer.

WARNING: Excessive sound pressure from earphones or headphones can cause hearing loss.

ABOVE ALL: NEVER let anyone, especially children, push or hit the screen, or push anything into holes, slots or any other openings in the case.

NEVER guess or take chances with electrical equipment of any kind – it is better to be safe than sorry.

Installation and important information

Where to install

Locate the television away from direct sunlight and strong lights. Soft, indirect lighting is recommended for comfortable viewing. Use curtains or blinds to prevent direct sunlight falling on the screen.

Place the TV on a stable, level surface that can support the weight of the TV. In order to prevent injury and maintain stability of this apparatus, secure the TV to the level surface using the strap if fitted, or to a wall using a sturdy tie to the P clips provided. Otherwise secure the TV on the level surface using the supplied mounting screw.

The LCD display panels are manufactured using an extremely high level of precision technology; however, sometimes some parts of the screen may be missing picture elements or have luminous spots. This is not a sign of a malfunction.

Make sure the television is located in a position where it cannot be pushed or hit by objects, as pressure will break or damage the screen. Also, please be certain that small items cannot be inserted into slots or openings in the case.

When using a Wall Bracket

Please use a wall bracket appropriate for the size and weight of the LCD TV.

- Two people are required for installation.
- **Never use the four screws attached to the TV.**

- 1** Unplug and remove any cables and/or other component connectors from the rear of the TV.
- 2** Carefully lay the front of the unit face down on a flat, cushioned surface such as a quilt or blanket.
- 3** Follow the instructions provided with your wall bracket.

Before proceeding, make sure the appropriate bracket(s) are attached to the wall and the back of the TV as described in the instructions provided with the wall bracket.

- 4** Always use the screws supplied or recommended by the wall mount manufacturer.

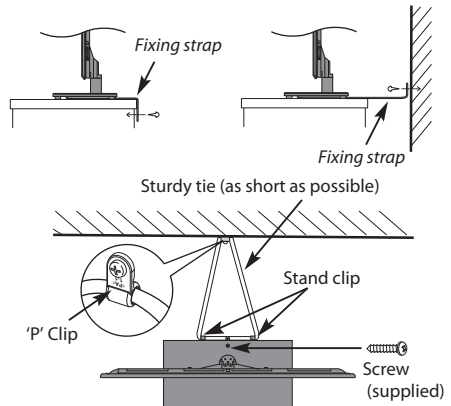

Stand style is dependent on model

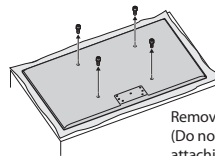

Remove four screws.
(Do not reuse these screws for attaching a wall bracket.)

Please take note

The digital reception function of this television is only effective in the countries listed in the "Country" section of the "Setup/System Setup" menu. Depending on country/area, some of this television's functions may not be available. Reception of future additional or modified services can not be guaranteed with this television.

If stationary images generated by 4:3 broadcasts, text services, channel identification logos, computer displays, video games, on-screen menus, etc. are left on the television screen for any length of time, they could become conspicuous. It is always advisable to reduce both the brightness and contrast settings.

Very long, continuous use of the 4:3 picture on a 16:9 screen may result in some retention of the image at the 4:3 outlines. This is not a defect of the LCD TV and is not covered under the manufacturer's warranty. Regular use of other size modes (e.g.: Super Live) will prevent permanent retention.

EXCLUSION CLAUSE

Toshiba shall under no circumstances be liable for loss and/or damage to the product caused by:

- i) Fire;
- ii) Earthquake;
- iii) Accidental damage;
- iv) Intentional misuse of the product;
- v) Use of the product in improper conditions;
- vi) Loss and/or damage caused to the product whilst in the possession of a third party;
- vii) Any damage or loss caused as a result of the owner's failure and/or neglect to follow the instructions set out in the owner's manual;
- viii) Any loss or damage caused directly as a result of misuse or malfunction of the product when used simultaneously with associated equipment;

Furthermore, under no circumstances shall Toshiba be liable for any consequential loss and/or damage including but not limited to the following: loss of profit, interruption of business, the loss of recorded data whether caused during normal operation or misuse of the product.

When Using a USB HDD (for UL86/UL87 series)

- **The recording function has been designed for private use and entertainment in your home environment. Please note that any commercial use of the recording function could lead to copyright infringement of authors' rights. Toshiba asks you to respect the intellectual property rights of third parties.**
- **Before recording to a device connected to the TV, make a test recording and check the recording performance.**
- **Programmes that are prohibited from copying due to copyright protection cannot be recorded.**
- **Toshiba shall not be liable for compensation or incidental damages of any kind whatsoever resulting from content that was not properly recorded on the recording device or that was modified or lost.**
- **Toshiba shall not be liable for damages of any kind whatsoever (breakdown of the recording device, modification or loss of the recorded content, etc.) resulting from malfunction, operating failure or incorrect operation due to combining with another connected device.**
- **If you connect and register a USB HDD that has been used with a PC or another TV, all the data and recorded programmes stored on the disk will be deleted.**
- **To use a USB HDD that has been used with this TV on a PC, the hard disk must first be formatted with the PC. At this time, all the data stored using the TV will be deleted.**
- **Do not turn off the power supply to the USB HDD or disconnect the connecting cable while the USB HDD is operating.**
Doing so may result in loss of the recorded data or malfunction of the USB HDD.
- **If you connect a USB bus-powered device to the USB 1 port, it may interfere with recording on the USB HDD.**
- **The recording function is not available in all countries.**
- **Please note that recording on the USB HDD is no longer playable after the TV's main-board is exchanged during service.**

About the Camera Sensor (for UL86/UL87 Series)

The camera sensor installed in this TV can detect a person's face or movement and identify individuals by their registered faces. Please note that certain factors can affect the performance of the sensor function as set out below.

General Sensor Function

- For the sensor to operate (for each function) you will need to be within the sensor detection range as set out below.
- The approximate effective detection range of the camera sensor is as shown below. (Note: The distance and angle of the detection range are based on a standard viewing environment and conditions).

– Horizontal angle: approx. 58° (approx. $29^\circ \times 2$)

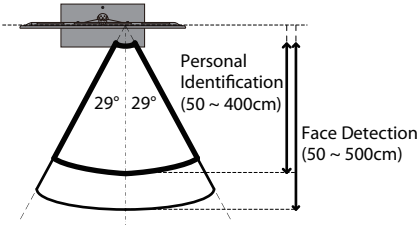

– Vertical angle: approx. 34° (upward approx. 27° , downward approx. 7°)

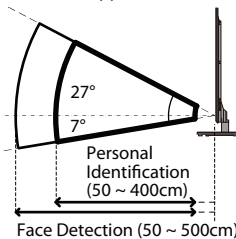

– Distance: approx. 50 cm to 500 cm (Personal Identification Function: approx. 50 cm to 400 cm)

- **Do not place anything in front of the TV that may obstruct detection or reduce the sensor detection range.**

Motion Detection Function

- Motion detection may be affected by the surrounding environment, such as the brightness of the room. In addition, very slight, small or momentary movement may be undetected.
- Sensor performance can be enhanced by making sure the room is brightly lit and using prolonged and obvious movements.
- Billowing curtains, a pet or variations in illumination in the detection range may be detected as motion, even if there is no person there.
- You can use the camera sensor confirmation menu to check that no movement made by other persons is being detected.

Face Detection Function

- The sensor can detect up to eight persons.
- Face Detection may be affected if:
 - Your face is obstructed or partially hidden, for example, by your hair, a mask or a hat,
 - Your head is tilted or turned to one side, or
 - You are wearing dark glasses or the light is reflected in your glasses.
- You can use the camera sensor confirmation menu to check whether your face is detected.
- The camera sensor may detect background images such as a picture portrait or the pattern on the wall as eyes or nose even if there is no person there. You can use the confirmation screen to check whether any such object in the detection range is being incorrectly detected as a face.
- Face Detection can be less effective on darker complexions and in darker environments.
- Face Detection can be enhanced by making sure your face is clearly visible and evenly lit. If the room is dark, Face Detection can be enhanced by making sure the room is brightly lit. If the lighting environment creates a shadow on your face, Face Detection can be enhanced by adjusting the lighting to prevent shadows.

Personal Identification Function

- The Personal Identification Function is part of the Face Detection Function. The factors affecting the Face Detection Function set out above also apply to the Personal Identification Function.
- Personal Identification may in addition be affected by:
 - A different shadow pattern from that when your face was registered. Personal Identification accuracy can be enhanced by registering additional facial images under different conditions.
 - A different lighting environment from when your face was registered, such as during the day and at night. Personal Identification accuracy can be enhanced by registering your face under various lighting environments.
 - Whether or not you are wearing glasses. If you wear glasses, we recommend that you register your face both with and without glasses.
 - A different facial expression. Personal Identification accuracy can be enhanced by registering different facial expressions.
- Personal Identification may be affected when faces have similar characteristics (e.g. brothers, sisters, twins).
- Personal Identification is less effective on the faces of young children.

Face Registration Function

- Up to four people can be registered under the Personal Identification Function. The same person cannot be registered twice.
- A maximum of 10 different facial images per person can be registered. Personal identification accuracy can be enhanced by registering different facial images as set out above.
- It is advisable to register your face in your usual viewing position and with your natural facial expression. Registering your face too near to or too far from the screen may hinder identification performance.

The remote control

CT-90369 (for SL86 series)

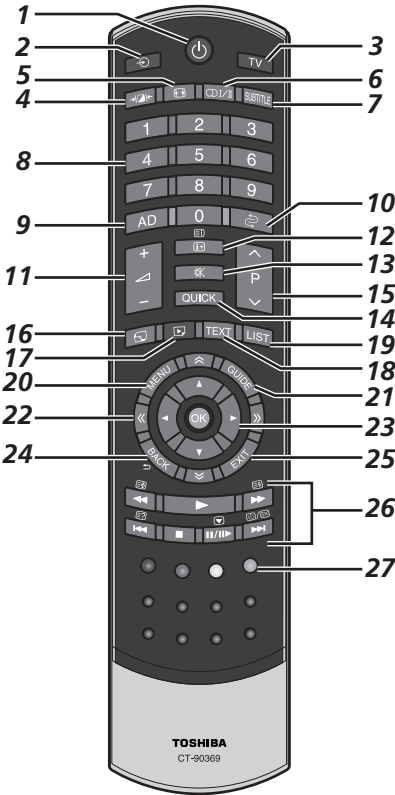

- 1 For On/Standby mode
- 2 To select external input sources
- 3 To select TV Mode
- 4 Selectable Picture preferences
- 5 Widescreen viewing
- 6 Stereo/bilingual transmissions
- 7 Digital Subtitles or Analogue TEXT Subtitle pages if available
- 8 Number buttons
- 9 Switch the Audio Description On/Off
- 10 To return to previous programme position
- 11 To alter the TV volume
- 12 To display on-screen information
To access the index page in Text mode
- 13 To mute the TV sound
- 14 To access Quick Menu
- 15 To change programme positions
To change TEXT pages

- 16 To access "TOSHIBA PLACES" Top Page
When network is not connected, an error message will be displayed.
- 17 To access Media Player Menu
- 18 To call up text services
- 19 To access the analogue or digital Channel List
- 20 On-screen Menus
- 21 To display the digital on-screen Programme Guide
- 22 To page up, down, left or right
- 23 When using menus, the arrows move the cursor on the screen up, down, left or right. Press **OK** to confirm your selection
- 24 To return to previous Menu
- 25 To exit menus
- 26 **When in TV mode:**
 - Picture still
 - Analogue time display
- 27 **Colour buttons:** Text and interactive service control buttons

- When in Text mode:**
- To reveal concealed text
 - To hold a wanted page
 - To enlarge text display size
 - To select a page while viewing a normal picture

When using Programme Guide:

- 24 hours
- +24 hours
- 1 page
- +1 page

During Playback:

- To PLAY
- To STOP
- To PAUSE/STEP
- To SKIP-BACK
- To REWIND
- To FAST FORWARD
- To SKIP-FORWARD

Inserting batteries and effective range

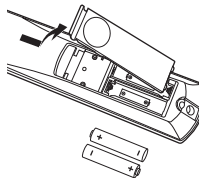

Remove the back cover to reveal the battery compartment and make sure the batteries are inserted the proper way. Suitable battery types for this remote are AA, IEC R6 1.5V.

Do not combine a used, old battery with a new one or mix battery types. Remove dead batteries immediately to prevent acid from leaking into the battery compartment. Dispose of them in accordance with instructions on page 96 of this manual.

Warning: Batteries must not be exposed to excessive heat such as sunshine, fire or the like.

The performance of the remote control will deteriorate beyond a distance of five metres or outside an angle of 30 degrees from the centre of the television. If the operating range becomes reduced, the batteries may need replacing.

The remote control

CT-90382 (for UL86/UL87 series)

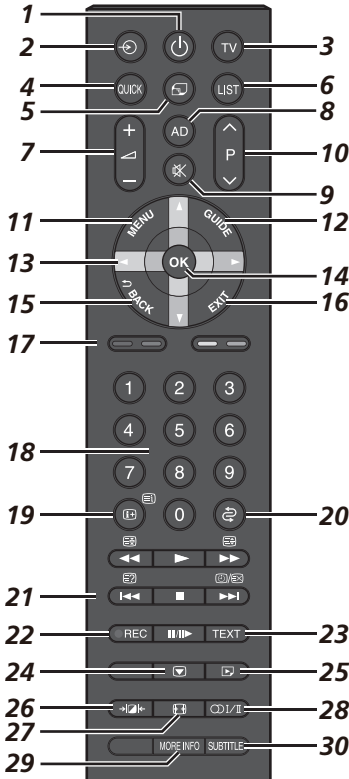

- 1 For On/Standby mode
- 2 To select external input sources
- 3 To select TV Mode
- 4 To access Quick Menu
- 5 To access the "TOSHIBA PLACES" Top Page
When network is not connected, an error message will be displayed.
- 6 To access the analogue or digital Channel List
- 7 To alter the TV volume
- 8 Switch the Audio Description On/Off
- 9 To mute the TV sound
- 10 To change programme positions
To change TEXT pages
- 11 On-screen Menus
- 12 To display the digital on-screen Programme Guide
- 13 When using menus, the arrows move the cursor on the screen up, down, left or right
- 14 Press **OK** to confirm your selection
- 15 To return to previous Menu

- 16 To exit menus
- 17 **Colour buttons:** Text and interactive service control buttons
- 18 Number buttons
- 19 To display on-screen information
To access the index page in Text mode
- 20 To return to previous programme position
- 21 **When in TV mode:**
 - Analogue time display
- When in Text mode:**
 - To reveal concealed text
 - To hold a wanted page
 - To enlarge text display size
 - To select a page while viewing a normal picture
- When using Programme Guide:**
 - 24 hours
 - +24 hours
 - 1 page
 - +1 page
- During Playback:**
 - To PLAY
 - To STOP
 - To PAUSE/STEP
 - To SKIP-BACK
 - To REWIND
 - To FAST FORWARD
 - To SKIP-FORWARD
- 22 To record DTV programmes
- 23 To call up text services
- 24 Picture still
- 25 To access Media Player Menu
- 26 Selectable Picture preferences
- 27 Widescreen viewing
- 28 Stereo/bilingual transmissions
- 29 To access More Information Menu
- 30 Digital Subtitles or Analogue TEXT Subtitle pages if available

Inserting batteries and effective range

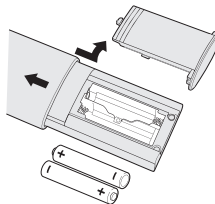

Remove the back cover to reveal the battery compartment and make sure the batteries are inserted the proper way. Suitable battery types for this remote are AAA, IEC R03 1.5V.

Do not combine a used, old battery with a new one or mix battery types. Remove dead batteries immediately to

prevent acid from leaking into the battery compartment. Dispose of them in accordance with instructions on page 96 of this manual.

Warning: Batteries must not be exposed to excessive heat such as sunshine, fire or the like.

The performance of the remote control will deteriorate beyond a distance of five metres or outside an angle of 30 degrees from the centre of the television. If the operating range becomes reduced, the batteries may need replacing.

Connecting external equipment

Before connecting any external equipment, turn off all main power switches. If there is no switch, remove the mains plug from the wall socket.

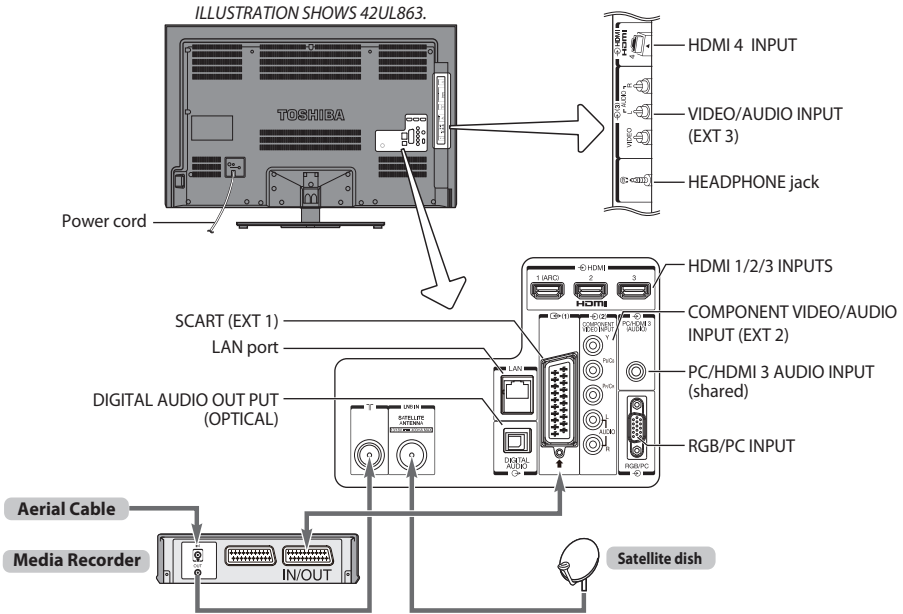

Aerial cables:

Connect the aerial to the socket on the rear of the television. If you use a decoder and/or a media recorder, it is essential that the aerial cable is connected through the decoder and/or through the media recorder to the television.

Satellite cable:

Connect the LNB from the satellite dish to the **SATELLITE ANTENNA** socket on the TV. You can receive TV, radio, interactive TV, and HD TV with clear reception.

SCART leads:

Connect the media recorder **IN/OUT** socket to the television. Connect the decoder **TV** socket to the television.

Before running **Auto Tuning**, put your decoder and media recorder to **Standby**.

The phono sockets alongside the **COMPONENT VIDEO INPUT** sockets will accept L and R audio signals.

The Digital Audio Output socket enables the connection of a suitable surround sound system.

NOTE: This output is always active.

HDMI® (High-Definition Multimedia Interface) is for use with a DVD decoder or electrical equipment with digital audio and video output. For acceptable video or PC signal formats through the HDMI terminals, see page 98.

NOTE: Although this television is able to connect to HDMI equipment, it is possible that some equipment may not operate correctly.

LAN port is used to connect the TV to your home network. This TV can play digital content stored on a DLNA CERTIFIED™ product with server function.

A wide variety of external equipment can be connected to the back of the television; therefore, the relevant owner's manuals for all additional equipment must be referred to for exact instructions.

If the television automatically switches over to monitor external equipment, return to normal television by pressing the desired programme position button. To recall external equipment, press  to select between **DTV, EXT 1, EXT 2, EXT 3, HDMI 1, HDMI 2, HDMI 3, HDMI 4, PC** or **ATV**.

When the external input mode is selected while viewing DTV mode, the SCART socket does not output video/audio signals.

Connecting an HDMI® or DVI device to the HDMI input

The HDMI input on your television receives digital audio and uncompressed digital video from an HDMI source device or uncompressed digital video from a DVI (Digital Visual Interface) source device.

This input is designed to accept HDCP (High-Bandwidth Digital-Content Protection) programme material in digital form from EIA/CEA-861-D-compliant consumer electronic devices (such as a set-top box or DVD player with HDMI or DVI output). For acceptable video signal formats, see page 98.

NOTE:

- Some early HDMI equipment may not work properly with your latest HDMI TV, due to the adoption of a new standard. Please unplug your HDMI cable first and then try setting the **INSTAPORT™** and **Enable Content Type** options to “Off”. Your early HDMI source should operate properly with your television. See page 84.
- Supported Audio format: Linear PCM, Dolby Digital (AC-3), sampling rate 32/44.1/48kHz.

To connect an HDMI device

Connect an HDMI cable (type A connector) to the HDMI terminal.

For proper operation, it is recommended that you use an HDMI cable with the HDMI Logo (**HDMI**™).

- If your HDMI connection is capable of 1080p and/or your television is capable of refresh rates greater than 50Hz, you will need a Category 2 cable. Conventional HDMI/DVI cable may not work properly with this model.
- HDMI cable transfers both video and audio. Separate analogue audio cables are not required (see illustration).
- See “HDMI 3 Audio” section on page 83.

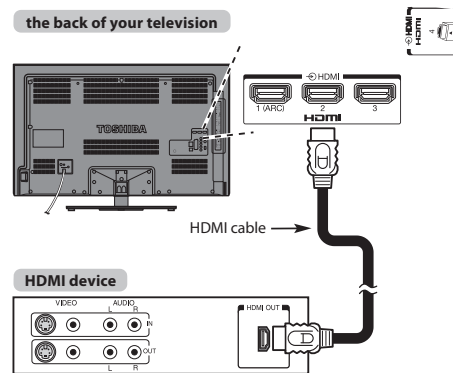

To view the HDMI device video, press the  button to select HDMI 1, HDMI 2, HDMI 3 or HDMI 4 mode.

To connect a DVI device

Connect an HDMI-to-DVI adaptor cable (HDMI type A connector) to the HDMI 3 terminal and audio cables to the PC/HDMI 3 (AUDIO) socket (see illustration).

- The recommended HDMI-to-DVI adaptor cable length is 6.6 ft (2m).
- An HDMI-to-DVI adaptor cable transfers video only. Separate analogue audio cables are required.
- See “HDMI 3 Audio” section on page 83.

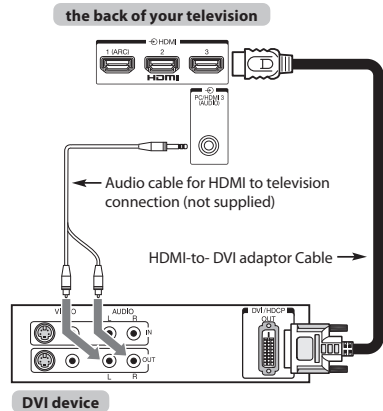

NOTE:

To ensure that the HDMI or DVI device is reset properly, it is recommended that you follow these procedures:

- When turning on your electronic components, turn on the television first, and then the HDMI or DVI device.
- When turning off your electronic components, turn off the HDMI or DVI device first, and then the television.

HDMI's ARC (Audio Return Channel) feature

This feature enables the audio signal of the TV to be sent to the AV amplifier via the HDMI cable. It will not be necessary to connect a cable from the audio output of the TV to the audio input of the AV amplifier to reproduce the audio received from the tuner of the TV through the AV amplifier.

the back of your television

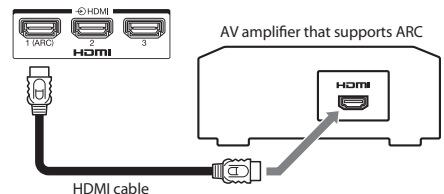

REGZA-LINK connection

You can control the basic functions of connected audio/video devices using the television's remote control if you connect a REGZA-LINK compatible AV amplifier or playback device. For an explanation of setup and operations, see pages 87–89.

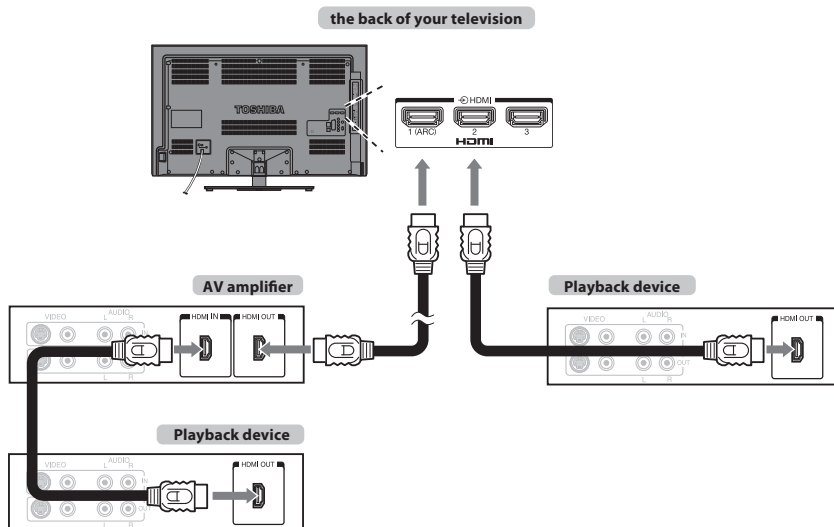

For the setup shown above, you will need three HDMI cables.

NOTE:

- If several devices are connected, the REGZA-LINK feature may not operate properly.
- For proper operation, it is recommended that you use HDMI cables with the HDMI Logo ().
- This function is available when one PC and one AV amplifier are connected separately. However, it may not operate properly if the PC is connected via the AV amplifier.

Before controlling the device(s):

- After completing the above connections, set the REGZA-LINK Setup menu as you desire (see page 87).
- The connected devices must also be set. For details, see the operation manual for each device.
- The REGZA-LINK feature uses CEC technology as regulated by the HDMI standard.
- This feature is limited to models incorporating Toshiba's REGZA-LINK. However, Toshiba is not liable for those operations. Refer to individual instruction manuals for compatibility information.

Connecting a computer

With either an RGB/PC or an HDMI connection, you can watch your computer's display on the television and hear the sound from the television's speakers.

To connect a PC to the RGB/PC terminal

When connecting a PC to the RGB/PC terminal on the television, use an analogue RGB (15-pin) computer cable and a PC audio cable for the PC/HDMI 3 (AUDIO) socket. Select **PC** from the **PC/HDMI 3 Audio** options in the **AV Connection** menu located in the **Preferences** menu.

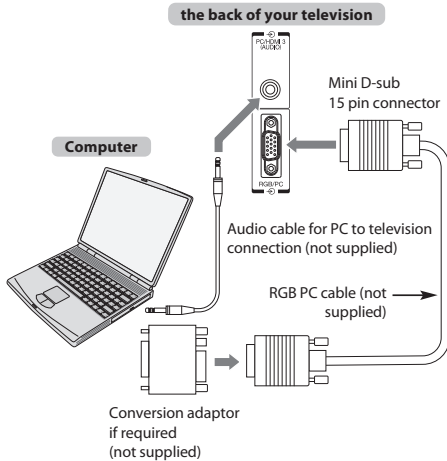

To use a PC, set the monitor output resolution on the PC before connecting it to the television. For acceptable PC signal formats, see page 97.

To display the optimum picture, use the PC setting feature (see page 81).

NOTE:

- The PC audio input terminal on the television is shared with the HDMI 3 analogue audio input terminal (see page 83).
- Some PC models cannot be connected to this television.
- An adaptor is not needed for computers with a compatible mini D-sub15-pin terminal.
- Depending on the DVD's title and the specifications of the PC on which you are playing the DVD-Video, some scenes may be skipped or you may not be able to pause during multi-angle scenes.
- A band may appear at the edges of the screen or parts of the picture may be obscured. This is due to scaling of the picture by the set, it is not a malfunction.
- When PC input mode is selected, some of the television's features will be unavailable e.g. **Colour System** in the **Setup/System Setup** menu.
- Some PC models may output unique signals that the television may be unable to detect (see page 97).

To connect a PC to the HDMI terminal

When connecting a PC to the HDMI terminal on the television, use an HDMI-to-DVI adaptor cable and an analogue audio cable.

If connecting a PC with an HDMI terminal, use an HDMI cable (type A connector). A separate analogue cable is not necessary.

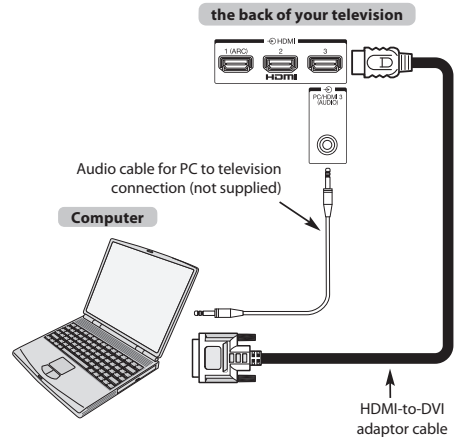

For acceptable PC and video signal formats, see page 98.

NOTE:

- The edges of the images may be hidden.
- If connecting a certain PC model with a unique PC signal, the PC signal may not be detected correctly.

Connecting a home network

The LAN port allows your Toshiba TV to connect to your home network. You can use this revolutionary home entertainment networking system to access photo, video and audio files that are stored on a DLNA CERTIFIED™ server and play/display them on your TV.

NOTE:

- If you connect to a shared network outside your home, it is advisable to use a router. Always use DLNA CERTIFIED™ products in private network environments.
- If you use a hub or switch to connect the TV to your home network, you may not be able to use the automatic setup and will have to manually set up the network address. See page 46.
- If you use a router with built-in DHCP functionality, use the automatic setup. Manual setup may not work.
- If you connect the TV and PC directly, use a crossover LAN cable.

To connect the TV to a home network - Wired

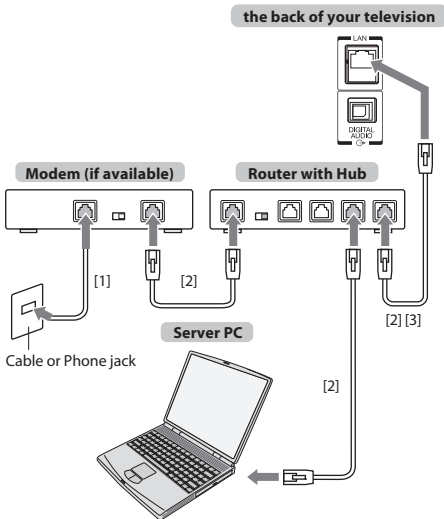

[1] Coaxial or telephone cable (depending on your modem type)

[2] Standard LAN cable

[3] Do NOT connect a phone jack directly to the TV's LAN port.

To connect the TV to a home network with an internet connection - Wireless

Please refer to "Wireless Setup" section on page 43.

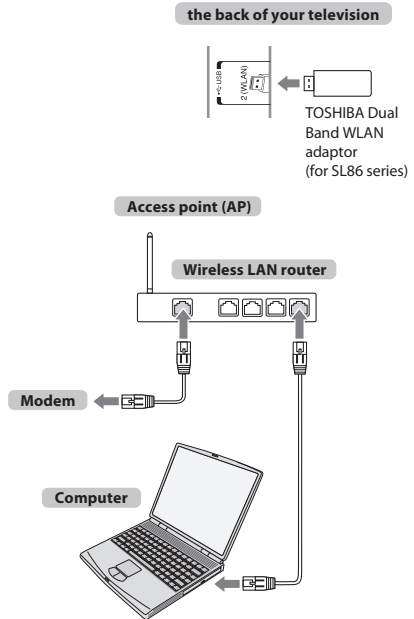

NOTE: UL86 and UL87 have a built in WLAN Module.

Setting up the USB HDD (for UL86/UL87 series)

To connect an USB HDD (not supplied)

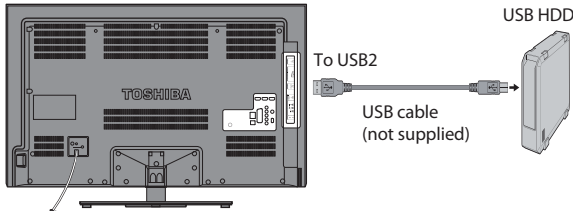

NOTE: For available USB HDD information, see "Product Information" on the website.

To register an USB HDD

When you connect a new USB HDD to the USB 2 port on the TV, the following screen will appear.

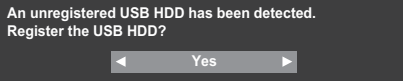

- 1** Press ◀ or ▶ to select **Yes** and press **OK**.
The formatting confirmation window will appear.
- 2** Press ◀ or ▶ to select **Yes** and press **OK**.
Registration will start.
- 3** If you want to name the USB HDD, press ◀ or ▶ to select **Yes** and press **OK**.
See page 47 to input characters.
The maximum number of characters is 10.
If you prefer the default name "USB HDD X," select **No** and press **OK**.
- 4** The Device List will appear.

Device Name	Registered	Connected
USB HDD 1	<input checked="" type="checkbox"/>	<input type="checkbox"/>
USB HDD 2	<input checked="" type="checkbox"/>	<input type="checkbox"/>
USB HDD 3	<input checked="" type="checkbox"/>	<input checked="" type="checkbox"/>

You can now use registered USB HDDs.

While in the list mode, the following key operations are available:

- OK** button To register/remove
- RED** button To disconnect
- GREEN** button To change Device Name
- YELLOW** button To test
- BLUE** button To format

NOTE:

- To disconnect a USB HDD from the TV, follow the procedures for "To disconnect a USB HDD" section (page 56).
- When using a USB HDD, if necessary, perform the settings and operations shown in "Using the USB HDD Function" section (page 49).
- Connect the USB HDD to the USB 2 port.
Recording and playback cannot be performed if connected to the USB 1 port.
- Up to 8 USB HDDs can be registered to this TV.
- Recorded programmes saved on the USB HDD can only be viewed on this TV. They cannot be viewed when connected to another TV (including the same model of TV), a PC, or other device.
- If a USB HDD is re-registered, it will not be formatted.
- When the USB HDD is formatted, all the data stored on the HDD will be deleted.

Controls and input connections

A wide variety of external equipment can be connected to the input sockets on the side of the television. While all the necessary adjustments and controls for the television are made using the remote control, the buttons on the television may be used for some functions.

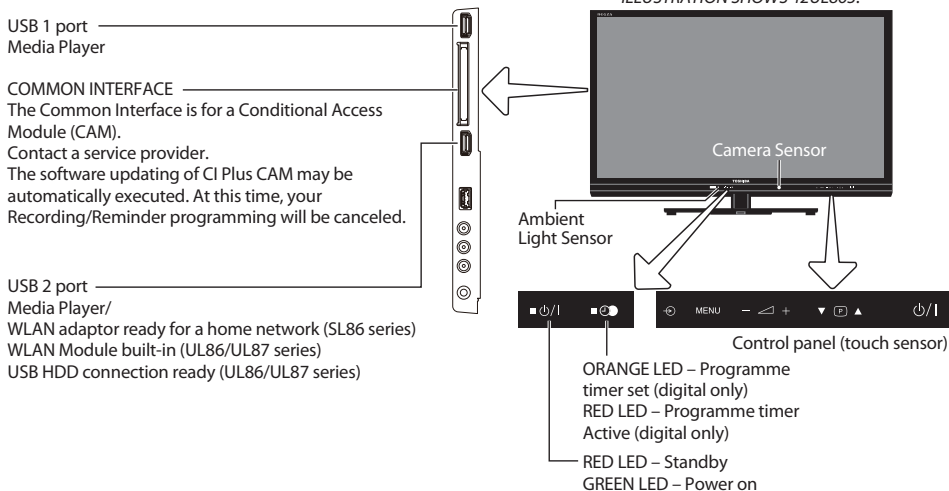

Switching on

If the RED LED is not lit, check that the mains plug is connected to the power supply and press on the remote control; it may take a few moments. The GREEN LED will be lit.

To put the television into Standby, press on the remote control. To view the television, press again. The picture may take a few seconds to appear.

For energy saving:

We recommend that you use the television with the factory settings. The factory settings are for energy saving. Unplugging the mains plug will cut energy use to zero for all televisions. This is recommended when the television is not being used for a long time, e.g. when on holiday. Reducing the brightness of the screen will reduce energy use. Energy efficiency cuts energy consumption and thus saves money by reducing electricity bills.

NOTE: Putting the television into standby mode will reduce energy consumption, but will still draw some power.

Using the remote control

Press **MENU** on the remote control to display the menu.

The five initial topics icons will appear. As each symbol is selected by pressing or on the remote control. Press to enter a sub menu and then enter a further sub menu to see any options.

NOTE: The same menu is displayed in DTV (Digital TV) and ATV (Analogue TV) modes; however, where some items are not available in a mode, they will appear grayed out.

To use the option, press and on the remote control to move up and down and press or to select your desired setting. Follow the on-screen instructions. The functions of each menu are described in detail throughout the manual.

Using the TV controls and connections

To alter the volume gently touch - +.

To alter the programme position touch .

Touch **MENU** and , - + to control the sound and picture options.

Touch **MENU** to finish.

To select an external input, touch until the appropriate input source is selected.

The Media Player feature provides access to photo, movie and music files stored on a USB storage device that is connected via the USB 1 or USB 2 port or on a network device.

NOTE: The USB socket has limited functionality and Toshiba can take no responsibility for damage to other connected equipment.

For SL86 series, the USB 2 socket has to be used with the "TOSHIBA Dual Band WLAN Adaptor WLM-10U2" in order to access a wireless network.

This feature is available only when the "TOSHIBA Dual Band WLAN Adaptor" is used.

Please always refer to the owner's manual of the equipment to be connected for full details.

NOTE: Interactive video games that involve shooting a "gun" at an on-screen target may not work with this TV.

MENU structure

To open the main menu (illustration below), press **MENU** on the remote control or on the TV control panel.

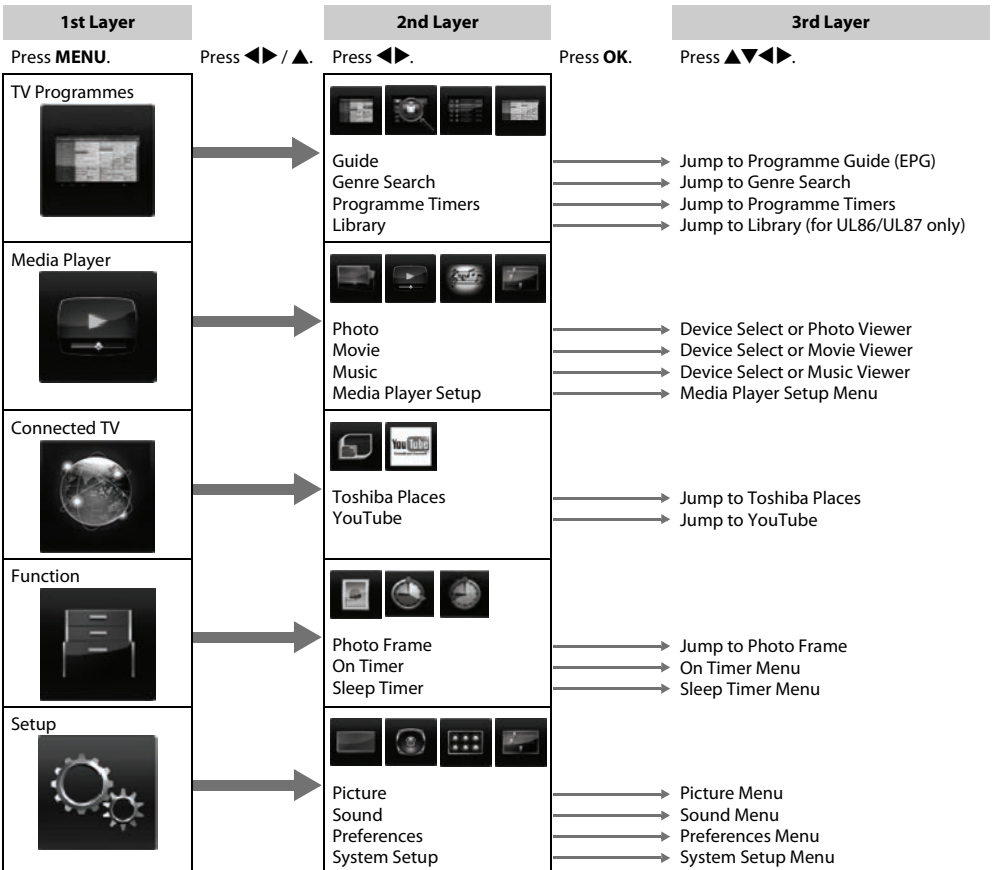
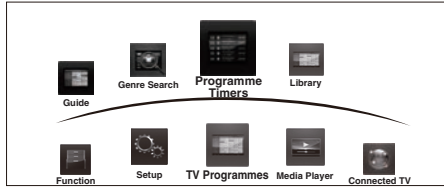

Startup Application

Before switching on the television, set your decoder and media recorder, if applicable, to **Standby**. To set up the television, use the buttons on the remote control as detailed on page 8, 9.

Quick Setup

- 1 Press the **OK** button. The **Menu Language** screen will appear. This screen will appear the first time that the television is switched on and each time **Reset TV** is selected.
- 2 Press **▲▼◀▶** to select the menu language and press **OK**.
- 3 Highlight **Country** and press **◀▶** to select. The television is now set to tune the stations for your country.

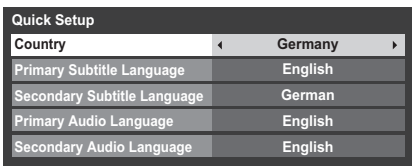

NOTE:

- The following display menus will differ slightly according to the country you selected.
- If there is not a country that you want to select in the list, select **Others**.

- 4 Press **OK**, and the **Location** screen will appear.

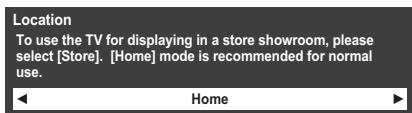

- 5 Press **◀▶** to select **Home** or **Store**. For normal home use, select **Home**.

- 6 Press **OK**.

USB Port Setup screen will appear depending on country/area.

- 7 Press **OK**, and the **TV Mounting** screen will appear, press **◀▶** to select **Stand** or **Wall**.

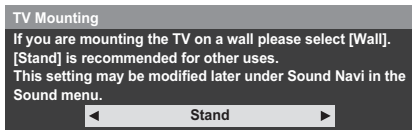

- 8 Press **OK**, and the **AutoView** screen will appear, press **◀▶** to select **Yes** or **No**.

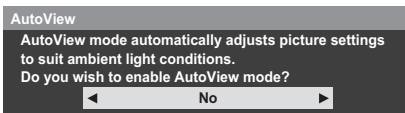

- 9 Press **OK**. If the **Ant/Cable/Satellite** screen appears, press **▲▼** to select **Antenna**, **Cable** or **Satellite** and press **OK** to check (✓).

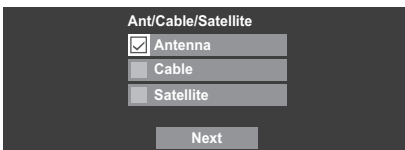

If DVB-C is not supported in your area, **Cable** will not be displayed.

- When you select **Antenna** or **Cable**, follow steps 10 to 13.
- When you select **Satellite**, skip to step 14.
- When you select **Antenna** (or **Cable**) and **Satellite**, the Satellite Settings startup screen will appear automatically after completing the **Antenna** (or **Cable**) scan and pressing **OK**.

- 10 Select **Next** and press **OK**. The **Auto Tuning** start up screen will appear with the option to select between **DTV and ATV**, **DTV** or **ATV** if available. Use **◀▶** to select the appropriate mode.

- 11 Press **▲▼** to highlight **Start Scan** and press **OK**.

The television will start to search for available **DTV** and/or **ATV** channels. The progress bar will indicate the scan status.

You must allow the television to complete the search.

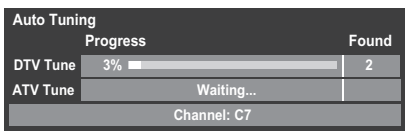

When the search is complete, the television will automatically select position one.

The **Auto Tuning** screen will display the total number of services found.

NOTE: If there are multiple channels with the same channel number, a confirmation window will appear. Press **◀▶** to select the one you prefer.

- 12** Press ◀ or ▶ to view the **DTV** (digital channel) or **ATV** (analogue channel) lists.
- 13** Press ▲ or ▼ to move through the list to select a channel and press **OK** to view.

In **ATV** mode, some areas may receive duplicate stations. There may not be a clear picture or the signal may be weak, so the station order can be changed using **ATV Manual Tuning**.

REMEMBER: Press **TV** at any time to select between **ATV** and **DTV** (DTV Ant TV/Radio/Text, DTV Cable TV/Radio/Text, DTV Sat TV/Radio/Text if available) modes.

NOTE: The time will be set automatically by transmission but can be advanced or decreased by using **Local Time Setting** in the **DTV Settings** screen.

- 14** Select **Next** and press **OK**. The **Satellite Settings** screen will appear. From this window, you can add the satellites that you wish to tune and configure detailed settings for each one individually. See "Satellite Settings" on page 20.

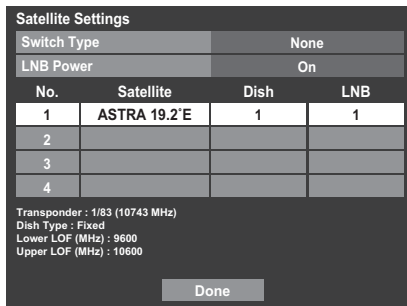

Highlight **Done** and press **OK**.

- 15** If your satellite dish is movable, the following **Positioning** screen will appear.

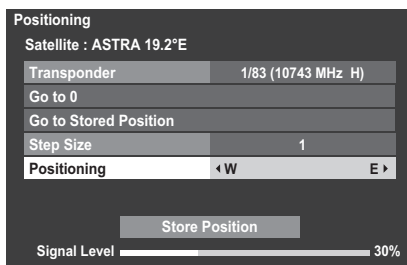

Press ▲ or ▼ to highlight **Positioning** and press ◀ or ▶ to find the dish position with the strongest signal level.

Press ▲ or ▼ to highlight **Store Position** and press **OK** to store the dish position. Repeat steps 14 and 15 for the next satellite as necessary.

If your satellite dish is not movable, the **Positioning** screen will not appear.

Adjust the dish position manually for the maximum Signal Level strength.

Highlight **Done** and press **OK**.

- 16** If the reception testing completes successfully, the **Auto Tuning** startup screen will display.

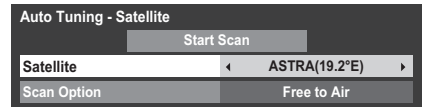

You can select **Scan Option** from **Free to Air** and **All**.

- 17** Press ▲ or ▼ to highlight **Start Scan** and press **OK**.

The television will start to search for available **DVB-S** channels. The progress bar will indicate the scan status.

When the search is complete, the **Auto Tuning** results screen will display the total number of services found.

- 18** Press ▲ or ▼ to move through the list to select a channel and press **OK** to view.

PLEASE NOTE

The **Quick Setup** menu can also be accessed at any time from the **Setup/System Setup** menu.

Ant/Cable/Satellite (if available)

From this menu, you can set the RF input configuration.

- Press **MENU** / ◀▶ to highlight **Setup** icon.
- Press ▲ / ◀▶ to highlight **System Setup** icon.
- Press **OK** to display **System Setup** menu.
- Press ▲ or ▼ to select **Ant/Cable/Satellite** and press ◀ or ▶ to select **Antenna**, **Cable** or **Satellite**.

NOTE: When you attempt to change the **Ant/Cable/Satellite** setting, a warning message will appear followed by PIN entry (if PIN has been set) and a prompt for **Auto Tuning**.

- 5** When **Ant/Cable/Satellite** is set to **Cable**, the following setting options will be provided in the **Auto Tuning** screen.

Press **▲** or **▼** to select an item and press **◀** or **▶** to select your desired option.

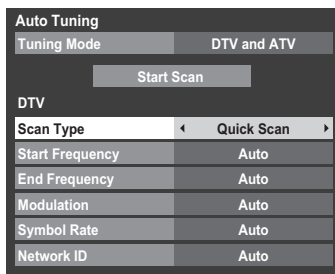

With the exception of **DTV Scan Type** and **DTV Modulation** items, all of the following items will have 2 operating modes. The first is **Auto** where the values for each item are preset by the system. The second is an **Input** mode where you will be able to enter a single value in place of the pre-set value. If no channel is currently tuned and the **Input** state is chosen, a system default value will be shown. However, if a channel is currently tuned when the item is accessed, the value of the current channel will be displayed.

DTV Scan Type:

This item determines whether a **Quick Scan** or a **Full Scan** will be executed.

The **Quick Scan** is a simplified version of the **Full Scan** that is designed to complete in less time.

DTV Start Frequency:

This sets the frequency from which the scan will begin.

DTV End Frequency:

This sets the frequency at which the scan will end.

DTV Modulation:

You can choose from five QAM modulation settings.

DTV Symbol Rate:

This is the baud rate (KS/s) of the scan.

DTV Network ID:

This is the Network ID to be utilized for the scan. This item is grayed out when DTV Scan Type is set to "Full Scan".

Satellite Settings

From the **System Setup** menu, you can add the satellites that you wish to tune and configure detailed settings for each one individually.

To add a satellite:

- 1 Press **MENU** / **◀▶** to highlight **Setup** icon.
- 2 Press **▲** / **◀▶** to highlight **System Setup** icon.
- 3 Press **OK** to display **System Setup** menu.
- 4 Press **▲** or **▼** to select **Satellite Settings** and press **OK**.

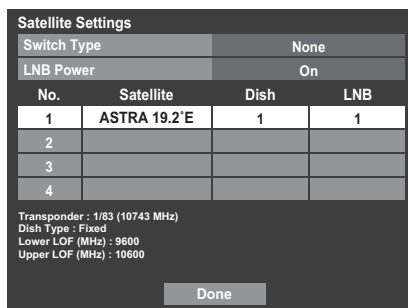

- 5 Press **▼** to highlight a new line to add another satellite and press **OK**.
- 6 Press **▼** until the required satellite is displayed and press **OK**.

To delete a satellite:

- 1 In the **Satellite Settings** menu, press **▲** or **▼** to select the satellite you want to delete.
- 2 Press the **RED** button. A confirmation window will appear.
- 3 Press **◀** or **▶** to select **Yes** and press **OK**.

NOTE: It is not possible to delete position No.1.

To edit the satellite settings:

- 1 In the **Satellite Settings** menu, press **▲** to highlight **Switch Type**.
- 2 Press **◀** or **▶** to select **None**, **ToneBurst**, **DiSeqC 2way** or **DiSeqC 4way** as your satellite switch type.
- 3 Press **▼** to highlight **LNB Power** and press **◀** or **▶** to select **On** or **Off**.

To add a transponder:

- 1 In the **Satellite Settings** menu, press **▲** or **▼** to highlight the line you want to edit and press **OK**.

1	ASTRA 19.2°E	1	1
---	--------------	---	---

- 2 Press the **GREEN** button. The **Transponder Settings** screen will appear.

Transponder Settings				
	Frequency	Polarisation	Symbol Rate	S/S2
1	10743	H	22000	S
2	10773	H	22000	S
3	10788	V	22000	S
4	10817	V	22000	S
5	10832	H	22000	S
6	10847	V	22000	S
7	10861	H	22000	S
8	10876	V	22000	S

- 3 Press **▲** to highlight a new line.

Transponder Settings				
	Frequency	Polarisation	Symbol Rate	S/S2
76	12640	V	22000	S
77	12662	H	22000	S
78	12669	V	22000	S
79	12692	H	22000	S
80	12699	V	22000	S
81	12721	H	22000	S
82	12728	V	22000	S
83				

- 4 Press **OK**.

83	0	H	0	S
----	---	---	---	---

- 5 Edit each parameter as required and press **OK**.

83	12731	H	22000	S2
----	-------	---	-------	----

To delete a transponder:

- 1 In the **Transponder Settings** menu, press **▲** or **▼** to highlight the line you want to delete.
- 2 Press the **RED** button.

To edit the Transponder Settings:

- 1 In the **Transponder Settings** menu, press **▲** or **▼** to highlight the line you want to edit and press **OK**.
- 2 Press **◀** or **▶** to select **Frequency**, **Polarisation**, **Symbol Rate** or **S/S2**, and set the item using the number buttons if necessary.
- 3 Press **OK** to save your settings.
- 4 Repeat steps 1 through 3 for other lines.
- 5 Press the **BLUE** button to finish editing and return to Satellite Settings.

Press the **GREEN** button to cancel any edits that were made.

Press the **YELLOW** button to reset all transponder settings to their initial default settings.

To select the Dish Type:

- 1 In the **Satellite Settings** menu, press **▲** or **▼** to select the required satellite line and press **OK**.
- 2 Press **◀** or **▶** to highlight **Dish** and press the **GREEN** button.

Dish Settings	
Dish : 1	
Dish Type	Fixed

- 3 Press **◀** or **▶** to select **Dish Type**. You can select **Movable** or **Fixed** as the Dish Type.

To select the LNB Settings:

1 In the **Satellite Settings** menu, press **▲** or **▼** to select the required satellite line and press **OK**.

2 Press **◀** or **▶** to highlight **LNB** and press the **GREEN** button.



3 Press **▲** or **▼** to select **Lower LOF** or **Upper LOF** and input the appropriate frequencies.

Auto Tuning

NOTE: As new services are broadcast, it will be necessary to re-tune the television in order to view them.

Auto Tuning will completely re-tune the television and can be used to update the channel list. **It is recommended that Auto Tuning is run periodically to ensure that all new services are added.** All current channels and settings, i.e. locked channels, will be lost.

1 Press **MENU** / **◀▶** to highlight **Setup** icon.

2 Press **▲** / **◀▶** to highlight **System Setup** icon.

3 Press **OK** to display **System Setup** menu.

4 Press **▲** or **▼** to select **Auto Tuning** and press **OK**.

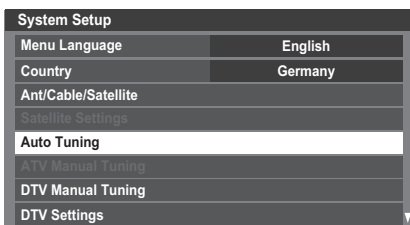

5 For DTV/ATV Tuning:

A screen will appear warning that previous programmes and settings will be deleted.

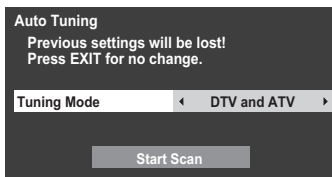

Press **◀** or **▶** to select **DTV and ATV**, **DTV** or **ATV**, if available, then highlight **Start Scan** and press **OK** to continue with the **Auto Tuning**.

NOTE: If you have selected "Others" for the **Country** field in the **System Setup** menu, and selected a tuning mode other than "DTV", choose the optimum ATV broadcasting system (B/G, I, D/K or L).

The television will start to search for all available DTV and/or ATV services.

You must allow the television to complete the search.

When the search is complete, the **Auto Tuning** screen will display the services found.

For Satellite Tuning:

A screen will appear warning that previous programmes and settings will be deleted.

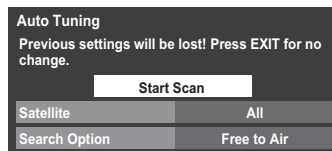

Press **▲** or **▼** to highlight **Satellite** and press **◀** or **▶** to select the desired satellite (**No.1 Sat** ~ **No.4 Sat** or **All**).

You can select **Free to Air** or **All** as the Search Option. Highlight **Start Scan** and press **OK** to continue with the **Auto Tuning**.

When the search is complete, the **Auto Tuning** screen will display the services found.

6 Use **▲** or **▼** to move through the list to select a channel and press **OK** to view.

ATV Manual Tuning

Tuning

The television can be tuned-in manually using **ATV Manual Tuning**. For example, you might use the feature if the television cannot be connected to a media recorder/decoder with a SCART lead or when you want to tune-in a station on another **System**.

Use ◀ and ▶ to move across the screen and select any of the ATV Manual Tuning options. Then use ▲ or ▼ to adjust the settings.

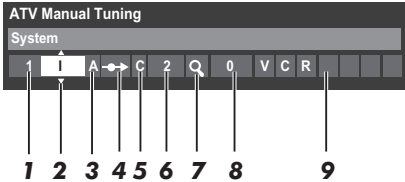

1 Position

The number to be pressed on the remote control to tune the channel.

2 System

Specific to certain areas.

3 Colour System

Factory set to Auto, should only be changed if problems are experienced, i.e. NTSC input from external source.

4 Skip

Set Skip to On (↺) or Off (↻) for the selected channel. See page 24.

5 Signal Class

The channel classification.

6 Channel

The channel number on which a station is being broadcast.

7 Search

Search up and down for a signal.

8 Manual Fine Tuning

Only used if interference/weak signal is experienced. See page 92.

9 Station

Station identification. Use the ▲ ▼ and ◀ ▶ buttons to enter up to seven characters.

To allocate a position on the television for a decoder and media recorder: turn the decoder on, insert a pre-recorded film in the media recorder, press PLAY and manually tune.

- 1 In the **System Setup** menu, press ▼ to select **ATV Manual Tuning** and press **OK**.

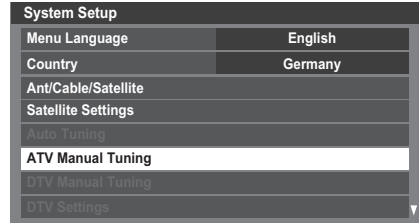

- 2 Use ▲ or ▼ to select the desired position. We suggest **Pos. 0** for a media recorder.

Pos.	Channel	Station
1	C2	
2	S10	
3	C7	
4	S40	
5	C22	
6	C25	
7	C28	
8	C30	

Different **Channel** numbers may be displayed.

- 3 Press **OK** to select. If the channel chosen for the media recorder is set to skip, Skip should be removed before storing.
- 4 Press ▶ to select **System** and press ▲ or ▼ to change if required.



- 5 Then press ▶ to select **Search**.
- 6 Press ▲ or ▼ to begin the search. The search symbol will flash.



- 7 Each signal will show on the television. If it is not your media recorder, press ▲ or ▼ again to restart the search.
- 8 When your media recorder signal is found, press ► to move along to **Station**. Use ▲, ▼, ◀ and ▶ to put in the required characters, e.g. **VCR**.



- 9 Press **OK** to save.
- 10 Repeat for each **position** you want to tune, or press **BACK** to return to the list of channels and select the next number to tune.
- 11 Press **EXIT** when you have finished.

PLEASE NOTE

This television has direct channel entry if the channel numbers are known. Select the **ATV Manual Tuning** screen in **Step 3**. Enter the **Position number**, the **System**, then **C** for standard (terrestrial) channels or **S** for cable channels and the **Channel number**. Press **OK** to save.

Skip

To prevent certain channels from being viewed, positions can be skipped.

- 1 Select **ATV Manual Tuning** from the **System Setup** menu.
- 2 Use ▲ or ▼ to highlight the position to be skipped and press **OK** to select.

Pos.	Channel	Station
1	C2	
2	S10	
3	C7	
4	S40	ABC1
5	C22	ABC1
6	C25	
7	C28	
8	C30	

- 3 Press ► to select **Skip**.

- 4 Use ▲ or ▼ to turn **Skip** on. Press **OK**.

◀ on the screen indicates a skipped position.

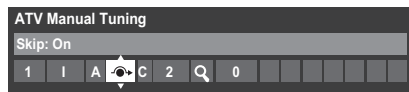

- 5 Press **BACK** and repeat from **Step 2** or press **EXIT**.

Each position has to be *individually* selected. To turn **Skip** off, repeat the procedure for each position.

Skipped positions **cannot** be selected by P[^] and P^v or by the controls on the television but **can** still be accessed by the number buttons on the remote control.

Sorting positions

Channels may be moved and saved to the position of your choice.

- 1 Select **ATV Manual Tuning** from the **System Setup** menu.
- 2 With the list of channels showing, use ▲ or ▼ to highlight the channel you want to move and press ►.

Pos.	Channel	Station
2	S10	
3	C7	
4	C40	ABC1
5	C22	ABC1
1	C2	
6	C25	
7	C28	
8	C30	

- 3 Use ▲ or ▼ to move through the list to your preferred position. As you do so, the other channels will move to make room.
- 4 Press ◀ to save your move. Repeat as necessary and press **EXIT**.

DTV Manual Tuning

NOTE: The content of this menu varies depending on the DTV input (Antenna, Cable, or Satellite) that is currently selected.

Manual Tuning

This feature is available for service engineers or can be used for direct channel entry if the multiplex channel is known.

- 1 Select **DTV Manual Tuning** from the **System Setup** menu and press **OK**.

DTV Manual Tuning

Signal Strength WEAK AVERAGE STRONG
Quality GOOD

Channel ◀ 13 ▶

Start Scan

- 2 Enter the multiplex number using the number buttons or use ◀ or ▶ to adjust the number up or down.
- 3 Highlight **Start Scan** and press **OK**. The television will automatically search for that multiplex.

DTV Manual Tuning

0 New Channels - Total 6

New	Pos.	Name	Type
	1	ABC ONE	<input type="checkbox"/>
	2	ABC TWO	<input type="checkbox"/>
	7	ABC THREE	<input type="checkbox"/>
	40	ABC NEWS 24	<input type="checkbox"/>
	51	ABCi	<input type="checkbox"/>

When the multiplex is found, any channels that are not currently in the channel list will be added and the channel information at the top of the screen will be updated.

- 4 Repeat as necessary. Press **EXIT** to finish.

Manual Tuning for DVB-C

When **Ant/Cable/Satellite** is set to **Cable**, **DTV Manual Tuning** items are as follows:

Frequency – input a specific frequency to be scanned

Modulation – choose from one of five QAM modulation options

Symbol Rate – input a specific baud rate (KS/s) to be used for the manual scan

Highlight **Start Scan** and press **OK**.

Manual Tuning for DVB-S

When **Ant/Cable/Satellite** is set to **Satellite**, **DTV Manual Tuning** items are as follows:

DTV Manual Tuning - Satellite

Signal Strength WEAK AVERAGE STRONG
Quality POOR

Satellite	ASTRA 28.2°E
Transponder	1/83
Frequency	10714 MHz
Symbol Rate	22000 KS/s
Polarisation	H
Search Option	Free to Air

Start Scan

Press ▲ or ▼ to highlight an item (**Satellite**, **Transponder**, **Frequency**, **Symbol Rate**, **Polarisation** or **Search Option**) and press ◀ or ▶ to select the required option.

Highlight **Start Scan** and press **OK**.

DTV Settings

Channels (Antenna/Cable)

The channel order may be changed to suit your personal preference.

- 1 Select **DTV Settings** from the **System Setup** menu and press **OK**.
- 2 Select **Channels** and press **OK**.

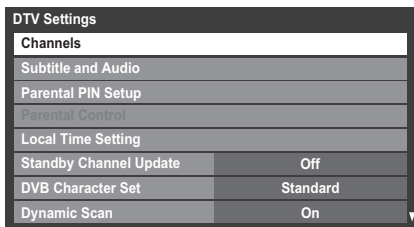

- 3 For your convenience, you can jump to specific places in the list by one of two methods.

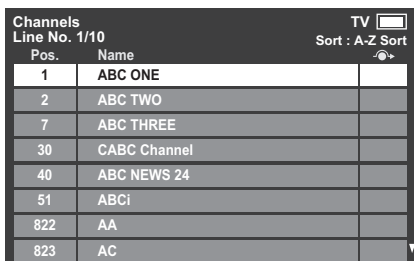

Line Number Jump — Use the **number buttons** (0-9) to input the line number you want to select and press **OK**.

Name Jump — Press **◀◀** or **▶▶** to jump to the next station name with a different initial letter.

It is also possible to change the Position number of a particular channel.

Renumber — Press the **RED** button to renumber the highlighted channel. Edit the channel number using the **number buttons** and press **OK**. If the position number you input already exists, a confirmation window will appear.



Move — Press the **GREEN** button to activate the **Move** feature. Press the **▲** or **▼** buttons to select the channel you wish to move and press **OK** to check. If you wish to move multiple channels at once, select another channel and check in the same way. Repeat as necessary.

Once all desired channels have been checked, press the **▲** or **▼** buttons to place the focus at the position to which you wish to move the channels. The channels will be inserted above the highlighted channel. Press the **GREEN** button to execute the move.



Sort — Press the **YELLOW** button. A confirmation window will appear. Press **◀** or **▶** to select **Yes** and press **OK**.

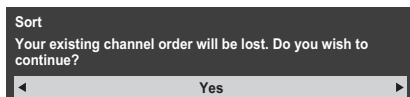

The **Sorting Type** selection window will appear.



Press **◀** or **▶** to set the sorting type.

A-Z Sort Station name order (A to Z)

Number Position No. order (numerical sequence)

Press **▼** to highlight **Sort** and press **OK**.

Channels (Satellite)

- 1 Select **DTV Settings** from the **System Setup** menu and press **OK**.
- 2 Select **Channels** and press **OK**.

The satellite channel list will appear.

Channels			Satellite TV
Line No. 3/1200			<input type="checkbox"/>
Pos.	Station	Satellite	
1	DDD	19.2°E	
2	AB	19.2°E	
3	E	19.2°E	<input checked="" type="checkbox"/>
801	BBC	22.5°E	<input checked="" type="checkbox"/>
802	BB	22.5°E	
803	BA	22.5°E	
822	AA	25.6°E	
823	AC	25.6°E	

- 3 For your convenience, you can edit and sort your channel list.

Line Number Jump — Press the **number buttons** (0-9) to input the line number you want to select and press **OK**.

Station Letter Jump — Press **◀◀** or **▶▶** to jump to the next station name with a different initial letter.

Satellite Jump — Press **◀◀** or **▶▶** to jump to the next channel on a different Satellite.

Renumber — Same as Antenna/Cable channels. See page 26.

Move — Same as Antenna/Cable channels. See page 26.

Sort — Press the **YELLOW** button. A confirmation window will appear. Press **◀** or **▶** to select **Yes** and press **OK**.

The **Sort** menu will appear.

Sort	
Group	◀ By Satellite ▶
Sorting Type	Number
Preset Order	Yes
Sort	

Group — Press **◀** or **▶** to select **All** or **By Satellite**.

Sorting Type — Press **◀** or **▶** to set the sorting type.

A - Z Sort Station name order (A to Z)

Number Position No. order (numerical sequence)

Preset Order — Press **◀** or **▶** to set **Yes** or **No**.

This item is displayed when Country is set to Germany, and only applies to the Astra 19.2°E satellite.

Press **▼** to highlight **Sort** and press **OK**.

Standby Channel Update

If the **Standby Channel Update** is set to **On**, when the TV is in standby mode, Digital Tuning is automatically executed and any new channels are saved.

- 1 Select **DTV Settings** from the **System Setup** menu and press **OK**.
- 2 Press **▼** to select **Standby Channel Update** and press **◀** or **▶** to select **On**.

DVB Character Set

This feature allows you to manually select the character set (**Standard** = Table 0, **West** = Table 5 or **Latin alphabet 9**) to be used for DVB-C or DVB-T channels.

- 1 Select **DTV Settings** from the **System Setup** menu and press **OK**.
- 2 Press **▼** to select **DVB Character Set** and press **◀** or **▶** to select **Standard**, **West** or **Latin alphabet 9**.

Dynamic Scan

If the broadcast information has changed in your DVB-T receiving area, the TV screen will display the message **"Broadcast information has changed. Would you like to rescan now?"**. Select **Yes** or **No**. If you do not wish for the TV to detect changes and prompt you to rescan, you should set this feature to **"Off"**.

- 1 Select **DTV Settings** from the **System Setup** menu and press **OK**.
- 2 Press **▼** to select **Dynamic Scan** and press **◀** or **▶** to select **On**.

Location setting

You can select either **Home** or **Store** mode. **Home** is recommended for normal home use. Select **Store** when using the television for displaying in a shop, etc.

- 1** Select **Location** from the **System Setup** menu.
- 2** Press ◀ or ▶ to select **Home** or **Store**.

Analogue switch-off

This is a **digital** television which is integrated to allow the use of both **digital** and **analogue** services. However, during the lifetime of this set it is very likely that **analogue** services will be switched off to allow for more new **digital** services.

This 'switch-off' will happen in a number of phases, which will be advertised in your area well in advance. It is recommended that at each phase the television is re-tuned to ensure that existing and new **digital** services can be viewed without disruption.

General controls

Quick Menu

Quick Menu helps you access some options quickly, such as **Picture Mode**, **Picture Size**, **Personal Mode**, **More Information**, **Sleep Timer** etc.

Press **QUICK** to display the **Quick Menu** and use ▲ or ▼ to select the option.

Menu Example (UL series)

Quick Menu	
Picture Mode	◀ AutoView ▶
Picture Size	Super Live
Personal Mode	
More Information	
Channel Options	
Sleep Timer	00:00
REGZA-LINK Device Control	
Speakers	TV Speakers
Headphone Level	50
Wireless Information	
Recording Information	

NOTE: **Quick Menu** items are different depending on the current mode.

Quick menu item example

Mode	Quick menu item	Description
When viewing a TV programme or pictures from the external input	Picture Mode	See page 34.
	Picture Size	See page 32.
	Personal Mode	See page 85.
	More Information	See page 75.
	Channel Options	See page 77.
	Sleep Timer	See page 73.
	REGZA-LINK Device Control	See page 88.
	Speakers	See page 87.
	Headphone Level	See page 31.
	Wireless Information	See page 45.
When using EPG	Genre Colour	See page 76.
	EPG Update/Cancel EPG Update	See page 75.
Media Player (Photo Multi View, List View)	Sort	See page 65.
	Interval Time	See page 65.
	Repeat	See page 65.
	Shuffle	See page 69.
	Device Information	See page 65.
	Wireless Information	See page 45.

Mode	Quick menu item	Description
Photo Frame (Full Screen)	Picture	See page 34.
	Picture Size	See page 32.
	Personal Mode	See page 85.

Selecting channels

To select a channel, use the numbered buttons on the remote control.

Channels can also be selected using **P▲** and **P▼**.

To display on-screen information such as channel, input mode or stereo/mono signal, press **i+**. Press again to cancel.

The Time Display – analogue only

The time display facility allows the current (text service) time to be seen on the television screen.

Press **⏻/ⓧ** whilst watching a normal television broadcast to see the time display from the broadcaster. It will remain on screen for about 5 seconds.

NOTE: This display may not be available in some cases.

Stereo and Bilingual transmissions

For DTV programmes

For stereo or dual mono broadcasts, press **⓪/Ⓦ** and use ◀ or ▶ to select settings.

Mode Display	Pressing ▶
⓪ Stereo	Stereo → Left → Right
●○ Dual mono	Dual 1 → Dual 2 → Dual
○ Mono	–
⓪⓪ Multichannel	–

For multi-audio track broadcasts, press **⓪/Ⓦ** repeatedly to change the audio language (see "Audio languages" on page 78).

For ATV programmes

If stereo or dual language broadcasts are transmitted, the word **Stereo** or **Dual** will appear on the screen each time positions are changed, disappearing after a few seconds. If the broadcast is not in stereo, the word **Mono** will appear.

Stereo... Press **⓪/Ⓦ** to select **Stereo** or **Mono**.

Bilingual... Bilingual transmissions are rare. If they are transmitted, the word **Dual** will be displayed. Choose the required programme number, and if the word **Dual** appears, press **⓪/Ⓦ** to select **Dual 1**, **Dual 2** or **Mono**.

Sound controls

Volume controls and sound mute

Volume

Press \uparrow or \downarrow to adjust the volume.

Sound Mute

Press \times once to turn the sound off and again to cancel.

Dual

If a programme or film is being broadcast with a soundtrack in more than one language, the **Dual** feature allows selection between them.

- 1 Press **MENU** / \leftarrow to highlight **Setup** icon.
- 2 Press \uparrow / \leftarrow to highlight **Sound** icon and press **OK**.
- 3 Press \uparrow or \downarrow to select **Dual** and press \leftarrow or \rightarrow to choose between **Dual 1** or **Dual 2**.

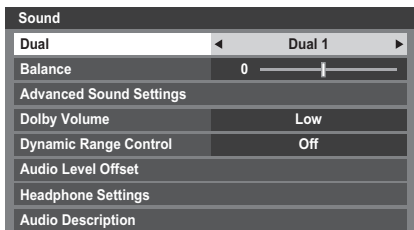

Balance

- 1 In the **Sound** menu, press \uparrow or \downarrow to select **Balance** and press \leftarrow or \rightarrow to emphasize left or right speaker balance.

Sound Navi

You can customize current sound mode settings. Select the appropriate mode in accordance with the installation location of the TV (**Stand** or **Wall**) and adjust the equalizer on-screen as desired.

- 1 In the **Sound** menu, press \uparrow or \downarrow to select **Advanced Sound Settings** and press **OK**.
- 2 Press \uparrow or \downarrow to select **Sound Navi** and press **OK**.

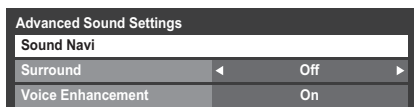

- 3 Press \leftarrow or \rightarrow to select either **Stand** or **Wall** depending on how your TV is installed and press the **RED** button.

- 4 Press \leftarrow or \rightarrow to select the frequency range you want to adjust from the equalizer window and press \uparrow or \downarrow to adjust the level.

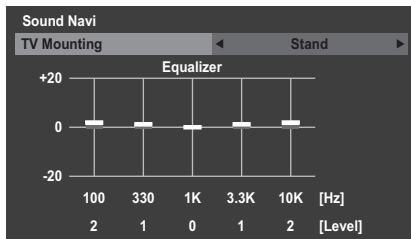

- 5 Repeat step 4 for other frequencies.

Surround Settings

Surround and **Voice Enhancement** help to create an enhanced surround sound experience with deep, rich bass from stereo sound sources. Your TV's audio will sound fuller, richer, and wider.

- 1 In the **Sound** menu, press \uparrow or \downarrow to select **Advanced Sound Settings** and press **OK**.
- 2 Press \uparrow or \downarrow to select **Surround** and press \leftarrow or \rightarrow to select **Off**, **Spatial** or **Cinema**.

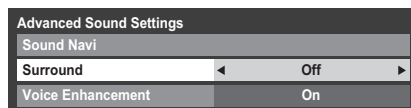

Dolby Volume®

This feature provides a consistent sound volume regardless of programmes, channels or input sources.

- 1 In the **Sound** menu, press \uparrow or \downarrow to select **Dolby Volume**.
- 2 Press \leftarrow or \rightarrow to select **Low**, **High** or **Off**.

NOTE:

- The **Dolby Volume** setting influences the **Dynamic Range Control** and **Digital Audio Output** settings.
- This feature will automatically switch **Off** when **Dynamic Range Control** is set to **On** or **Digital Audio Output** is set to **Auto**.

Dynamic Range Control

This feature allows control of audio compression for some digital TV programmes (MPEG-1 and MPEG-2 audio programmes are not supported).

- 1 In the **Sound** menu, press ▲ or ▼ to select **Dynamic Range Control**.
- 2 Press ◀ or ▶ to select **On** or **Off**.

NOTE: This feature will automatically switch **Off** when **Dolby Volume** is set to **Low** or **High**.

Audio Level Offset

Sometimes there can be large changes in volume when switching from a DTV 5.1ch to a DTV 2ch, an ATV channel, or an external input. Using the **Audio Level Offset** feature reduces these volume differences.

- 1 Set the volume level usually used when watching a DTV 5.1ch programme.
- 2 Tune to a channel which is DTV 2ch, ATV or an external input.
- 3 In the **Sound** menu, press ▲ or ▼ to select **Audio Level Offset** and press **OK**.
- 4 Press ▲ or ▼ to select an option, and then press ◀ or ▶ to adjust the volume level.

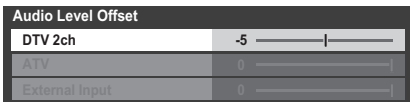

NOTE:

- The available item changes depending on the current input source. For example, while watching a DTV 2ch programme, only **DTV 2ch** is available and the other two items are grayed out in the menu. This allows you to easily adjust according to each condition.
- When watching a DTV 5.1ch programme, this feature is not available.

Headphone Settings

This setting is used to set the sound output when headphones are connected.

Speaker Link	Headphone	Speakers
On	Sound is output (◀ – + is available.)	No sound
Off	Sound is output (Headphone level menu is available.)	Sound is output (◀ – + is available.)

- 1 In the **Sound** menu, press ▲ or ▼ to select **Headphone Settings** and press **OK**.
- 2 Press ▲ or ▼ to select **Speaker Link** and press ◀ or ▶ to select **On** or **Off**.
- 3 If you select **Off**, then highlight **Headphone Level** and use ◀ or ▶ to adjust the headphone sound.

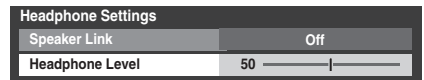

Audio Description

Audio Description is an additional narrative sound track for visually impaired individuals to understand and enjoy the story line more fully. The letters **AD** will be displayed in the channel banner when programmes contain **AD** content.

- 1 In the **Sound** menu, select **Audio Description** and press **OK**.
- 2 Press ▲ or ▼ to select **Audio Description** and press ◀ or ▶ to select **On**.

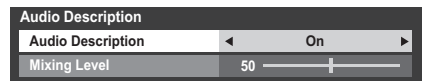

The **AD** button on the Remote can also be used to toggle the **Audio Description** feature between **On** and **Off**.

- 3 To adjust the level of the audio description sound to the main sound, highlight **Mixing Level** and press ◀ or ▶.

Widescreen viewing

Depending on the type of broadcast being transmitted, programmes can be viewed in a number of formats.

WIDE

Use this setting when watching a widescreen DVD, widescreen video tape or a 16:9 broadcast (when available). Due to the range of widescreen formats (16:9, 14:9, 20:9 etc.) black bars may be visible on the top and bottom of the screen.

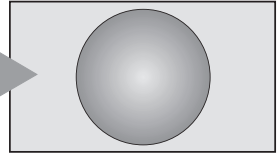

4:3

Use this setting to view a true 4:3 broadcast.

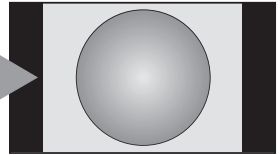

SUPER LIVE

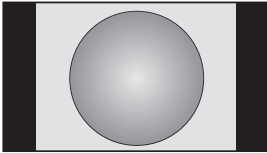

This setting will enlarge a 4:3 image to fit the screen by stretching the image horizontally and vertically, holding better proportions at the centre of the image. Some distortion may occur.

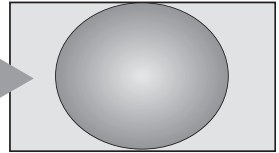

CINEMA

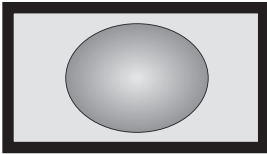

When watching 'all sides panel format' films/video tapes, this setting will eliminate or reduce the black bars at all sides of the screen by zooming in and selecting the image without distortion.

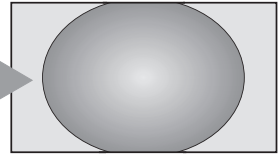

SUBTITLE

When subtitles are included on a letterbox format broadcast, this setting will raise the picture to ensure that all the text is displayed.

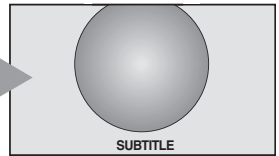

14:9

Use this setting when watching a 14:9 broadcast.

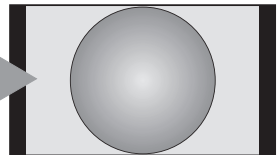

NATIVE

This setting will show the picture without overscan, i.e. WYSIWYG.

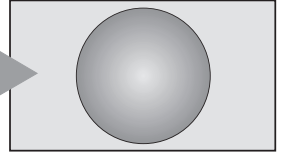
**PC NORMAL**

This setting will show the picture without overscan, i.e. WYSIWYG. This option is only available when watching a PC signal source via HDMI or PC terminal.

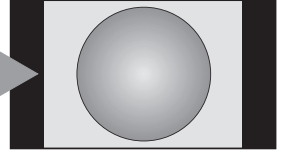
**PC WIDE**

This setting will show the picture without overscan or side panels. This option is only available when watching a PC signal source via HDMI or PC terminal.

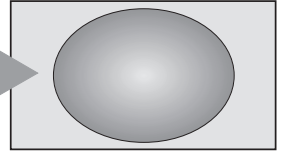
**Dot by Dot**

"Dot by Dot" is a non-scaling display. Depending on the input signal format, the picture is displayed with side panels and/or bars at the top and bottom (e.g. VGA input source).

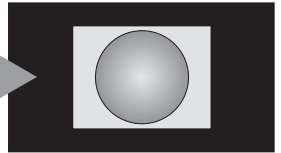

Press the  button on the Remote to display the list of available widescreen formats.

Press the button repeatedly to highlight the required format.

The **Quick Menu** feature can also be used to select **Picture Size**.

AV format

Picture Size
Native
Wide
4:3
Super Live
Cinema
Subtitle
14:9

PC format

Picture Size
Dot by Dot
PC Normal
PC Wide

Using the special functions to change the size of the displayed image (i.e. changing the height/width ratio) for the purposes of public display or commercial gain may infringe on copyright laws.

Picture controls

Most of the picture controls and functions are available in both **digital** and **analogue** modes.
PLEASE NOTE: Features not available will be grayed out.

Picture Mode

This television offers the choice of personalising the picture style.

AutoView, Dynamic, Standard, Hollywood Night, Hollywood Day, Hollywood Pro, Store, Game and PC are preset options and affect many features/settings within the television.

NOTE:

- Because the **AutoView** mode automatically adjusts picture settings based on ambient light conditions and input signal content, the **Auto Brightness Sensor** and **Expert Mode** menus are grayed out when it is selected.
- Store** mode is only available when **Location** is set to **Store**.
- Game** mode is available in external input mode (other than aerial input). When you select **Game** mode, suitable widescreen formats will be selected.
- PC** mode is available in RGB/PC input mode or HDMI input mode.

- 1 Press **MENU** / ◀▶ to highlight **Setup** icon.
- 2 Press ▲/◀▶ to highlight **Picture** icon and press **OK** to display **Picture** menu.
- 3 Press ▲ or ▼ to select **Picture Mode**.

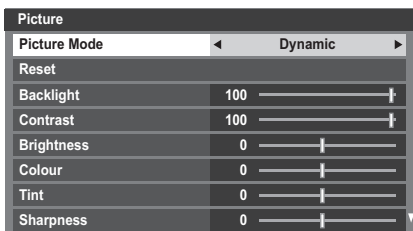

- 4 Press ◀ or ▶ to select the picture mode you prefer and press **OK**.

NOTE: The picture mode you select affects the current input only. You can select a different picture mode for each input.

Picture preferences

You can customize current picture mode settings as desired. For example, while selecting "**Dynamic**", if you change the following items, such as **Backlight, Contrast, Brightness, Colour, Tint, Sharpness** and the **Advanced Picture Settings** items, your new settings are saved for "**Dynamic**" picture mode.

- 1 In the **Picture** menu press ▲ or ▼ to select either **Backlight, Contrast, Brightness, Colour, Tint or Sharpness** and press **OK**.
- 2 Press ◀ or ▶ to adjust the settings.

Reset

This feature resets all picture settings to the factory settings except **Picture Mode**.

- 1 In the **Picture** menu, press ▲ or ▼ to select **Reset** and press **OK**.
- 2 A confirmation message will appear. Press ◀ or ▶ to select **Yes** and press **OK**.

ColourMaster

When **ColourMaster** is set to **On**, it allows the "Base Colour Adjustment" feature to become available.

- 1 In the **Picture** menu, press ▲ or ▼ to select **Advanced Picture Settings** and press **OK**.
- 2 Press ▲ or ▼ to select **ColourMaster**.

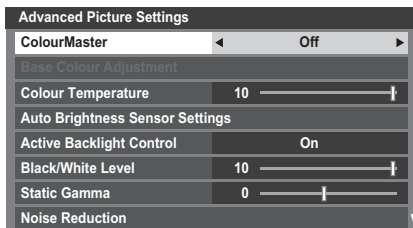

- 3 Press ◀ or ▶ to select **On** or **Off** and press **OK**.

Base Colour Adjustment

The **Base Colour Adjustment** feature allows the adjustment of individual colours to suit personal preference. This can be useful when using an external source.

- 1 In the **Advanced Picture Settings** menu, press ▲ or ▼ to select **Base Colour Adjustment** and press **OK**.
- 2 Press ▲ or ▼ to select an option, and then press ► to move to the adjustment window.

Base Colour Adjustment			
	Hue	Saturation	Brightness
■ Red	0	0	0
■ Green	0	0	0
■ Blue	0	0	0
■ Yellow	0	0	0
■ Magenta	0	0	0
■ Cyan	0	0	0
Reset			

- 3 Press ◀ or ▶ to select **Hue**, **Saturation** or **Brightness** and press ▲ or ▼ to adjust the settings as required.

	Hue	Saturation	Brightness
■ Red	0	0	-1

- 4 Press **BACK** to return to the previous menu.

To return to the factory settings, select **Reset** and press **OK**.

Colour Temperature

Colour Temperature increases the “warmth” or “coolness” of the picture by increasing the red or blue tint.

- 1 In the **Advanced Picture Settings** menu, press ▲ or ▼ to select **Colour Temperature** and press **OK**.
- 2 Press ◀ or ▶ to adjust the level.

The adjustment range is 0 (warm) to 10 (cool).

NOTE: If **Picture Mode** is set to **AutoView**, the adjustment range is -5 to +5.

Auto Brightness Sensor Settings

When the **Auto Brightness Sensor** is activated, it will automatically optimise the backlighting levels to suit ambient light conditions.

- 1 In the **Advanced Picture Settings** menu, press ▲ or ▼ to select **Auto Brightness Sensor Settings** and press **OK**.
- 2 Press ◀ or ▶ to select **On** and press **OK**.

Auto Brightness Sensor Settings	
Auto Brightness Sensor	On
Backlight Adjustment Pro	

- 3 Press ▲ or ▼ to select **Backlight Adjustment Pro** and press **OK**.
- 4 The **Backlight Adjustment Pro** window will appear. Press **OK** again to display the adjustment window.
- 5 Press ◀ or ▶ to select a point and press ▲ or ▼ to adjust the level.

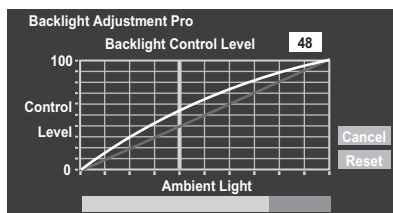

- 6 Press **OK** to fix the adjustment.

To cancel the adjustment when selecting a point, select **Cancel** and press **OK**.

To return the adjustments of all points to the factory defaults, select **Reset** and press **OK**.

Active Backlight Control

When **Active Backlight Control** is activated, it will automatically optimize the backlighting levels for dark scenes.

- 1 In the **Advanced Picture Settings** menu, press ▲ or ▼ to select **Active Backlight Control**.
- 2 Press ◀ or ▶ to select **On** or **Off**.

Black/White Level

Black/White Level increases the strength of dark areas of the picture to improve the definition.

- 1 In the **Advanced Picture Settings** menu, press ▲ or ▼ to select **Black/White Level**.
- 2 Press ◀ or ▶ to adjust the level. The effect depends on the broadcast and is most noticeable on dark colours.

Static Gamma

The **static gamma** feature allows you to adjust the levels of black in the picture.

- 1 In the **Advanced Picture Settings** menu, press ▲ or ▼ to select **Static Gamma**.
- 2 Press ◀ or ▶ to adjust the level.

MPEG NR – Noise Reduction

When watching a DVD, the compression may cause some words or picture elements to become distorted or pixelated. Using the **MPEG NR** feature reduces this effect by smoothing out the edges.

- 1 In the **Advanced Picture Settings** menu, press ▲ or ▼ to select **Noise Reduction** and press **OK**.
- 2 Press ▼ to select **MPEG NR**.



- 3 Press ◀ or ▶ to select **Low**, **Middle**, **High** or **Off** to suit your preference.

DNR – Digital Noise Reduction

DNR allows you to "soften" the screen representation of a weak signal to reduce the noise effect.

- 1 Select **DNR** from the **Noise Reduction** menu.
- 2 Press ◀ or ▶ to select **Low**, **Middle**, **High**, **Auto** or **Off**. The differences may not always be noticeable (for the best result use lower settings as picture quality can be lost if the setting is too high).

Resolution+

The **Resolution+** feature allows you to adjust the clarity levels for your desired picture settings.

- 1 In the **Advanced Picture Settings** menu, press ▲ or ▼ to select **Resolution+** and press **OK**.
- 2 In the **Resolution+** field, select **Auto**.



- 3 Press ▲ or ▼ to highlight **Level** and press ◀ or ▶ to adjust the level.

NOTE:

- This feature may not work properly depending on the content.
- Adjustable range varies according to the Picture Mode you set.
- Noise may appear in the picture depending on the device connected to the TV (e.g. a device with a specific enhancer function).

Active Vision M100

This feature will reduce picture blur without decreasing image brightness or adding flicker.

- 1 In the **Advanced Picture Settings** menu, press ▲ or ▼ to select **Active Vision M100**.
- 2 Press ◀ or ▶ to select **Smooth**, **Standard** or **Off**.

NOTE: When **Picture Mode** is set to **Game**, this feature will be grayed out and automatically set to **Off**.

Motion Detection Range

This feature is to set the range of the adjustment of movement in the double-scan processing. If you feel uncomfortable in motion picture, select **Standard**.

- 1 In the **Advanced Picture Settings** menu, press ▲ or ▼ to select **Motion Detection Range**.
- 2 Press ◀ or ▶ to select **Wide** or **Standard**.

Wide — Double-scan effect for higher-speed motion picture

Standard — Stabilized double-scan effect

NOTE: When **Active Vision M100** is set to **Off**, this feature will be grayed out.

Resetting the advanced picture settings

This feature allows you to reset the current **Advanced Picture Settings** to the default values.

- 1 In the **Advanced Picture Settings** menu, press ▲ or ▼ to select **Reset**.
- 2 Press **OK**.

Expert Picture Settings

This feature is available when the *Picture Mode* option is **Standard**, **Hollywood Day**, **Hollywood Night**, and **Hollywood Pro**.

Test Pattern

When the test pattern is on screen, you can navigate in the *Picture* submenus and adjust picture settings without removing the image.

When you move to a non-Picture menu, or close the menus, regular video will be restored.

- 1 In the **Picture** menu, press ▲ or ▼ to select **Expert Picture Settings** and press **OK** to display **Expert Picture Settings** menu.
- 2 Press ▲ or ▼ to select **Test Pattern**.
- 3 Press ◀ or ▶ to select **On**.
- 4 Press **EXIT** to close.

RGB Filter

This feature individually enables or disables the red, green, and blue components of the picture to allow for more accurate adjustment of each colour.

- 1 In the **Expert Picture Settings** menu, press ▲ or ▼ to select **RGB Filter** and press **OK**.
- 2 Press ▲ or ▼ to select **Red**, **Green** or **Blue** to adjust.
- 3 Press ◀ or ▶ to select **On**.
- 4 Press ▲ or ▼ to select **Colour** or **Tint** and press ◀ or ▶ to adjust.
- 5 Press **EXIT**.

NOTE: It is not possible to turn off all three colours simultaneously.

Colour Decoding

If you view DVDs with this TV, the **Colour Decoding** option may be set to ensure the colourimetry reproduction.

NOTE: The modes excluding **Auto (BT601 and BT709)** are to convert an irregular signal output from the DVD etc. with incorrect colour to the optimum state. If **BT601** or **BT709** is selected with a normal signal received, the colour may not be correctly displayed. This feature should normally be set to **Auto**.

- 1 In the **Expert Picture Settings** menu, press ▲ or ▼ to select **Colour Decoding**.
- 2 Press ◀ or ▶ to select **Auto**, **BT601** or **BT709**.

White Balance-Window Display

This feature displays a special *Window Pattern* to be used when adjusting white balance with a measuring device.

- 1 In the **Expert Picture Settings** menu, press ▲ or ▼ to select **White Balance** and press **OK**.
- 2 Press ▲ or ▼ to select **Window Display** and press ◀ or ▶ to select **On**.
- 3 Press **EXIT** to close.

White Balance-Setting Type

You can choose from two types of White Balance adjustment.

- 1 In the **Expert Picture Settings** menu, press ▲ or ▼ to select **White Balance** and press **OK**.
- 2 Press ▲ or ▼ to select **Setting Type** and press ◀ or ▶ to select **2P** or **10P**.

White Balance-2P White Balance

- 1 Press ▼ to select **2P White Balance**.
- 2 Press ▲ or ▼ to select **Red-Offset**, **Green-Offset**, **Blue-Offset**, **Red-Gain**, **Green-Gain**, or **Blue-Gain**.
- 3 Press ◀ or ▶ to adjust.

White Balance-10P White Balance

- 1 Press ▼ to select **10P White Balance**.
- 2 Press ▲ or ▼ to select **IRE**, **Red**, **Green**, or **Blue**.
- 3 Press ◀ or ▶ to adjust.

NOTE: The adjustments made for Red / Green / Blue are stored separately for each IRE setting. (There are ten IRE settings from 10 to 100.)

Colour Calibration

The aim of Colour Calibration is to measure and/or adjust the colour response (White Balance) of your LCD panel. Colour Calibration is used by various fields, such as gaming, photography, engineering, medical and more. In order to calibrate a display correctly, you need a colour analyzer **TPA-1** (not supplied).

NOTE: This feature is available when the Picture Mode option is **Hollywood Pro**.

Apply Calibration

- 1 In the **Expert Picture Settings** menu, press ▲ or ▼ to select **Colour Calibration** and press **OK**.
- 2 Press ▲ or ▼ to select **Apply Calibration** and press ◀ or ▶ to select **Enabled**.

Manual Colour Calibration

- 1 In the **Colour Calibration** menu, press ▲ or ▼ to select **Manual Colour Calibration** and press **OK**.

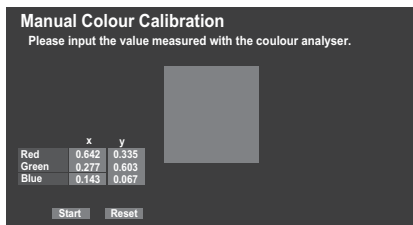

- 2 Place the probe of the colour analyzer over the square on screen to measure.
- 3 Input the value measured with the colour analyzer using the number buttons (0-9).

	x	y
Red	0.642	0.335
Green	0.277	0.603
Blue	0.143	0.067

- 4 Press ▲▼◀▶ and input the values to fill all RGBxy matrix table.
- 5 Highlight **Start** and press **OK**.
Please wait until you see "Manual Colour Calibration has been completed." on screen.

To return to factory setting

- 1 Highlight **Reset** and press **OK**.

Auto Colour Calibration

- 1 In the **Colour Calibration** menu, press ▲ or ▼ to select **Auto Colour Calibration** and press **OK**.

- 2 Connect the USB colour analyzer to the USB 1 or USB 2 port.

- 3 Place the probe of the USB colour analyzer over the square on screen and press **OK**.

Auto Colour Calibration will start.

Please wait until you see "Auto Colour Calibration has been completed.".

Gamma Calibration

- 1 In the **Expert Picture Settings** menu, press ▲ or ▼ to select **Gamma Calibration** and press **OK**.
- 2 Press ▲ or ▼ to select **Apply Calibration** and press ◀ or ▶ to select **Enabled**.
- 3 Press ▲ or ▼ to select **Auto Gamma Calibration** and press **OK**.
- 4 Connect the USB colour analyzer to the USB 1 or USB 2 port.
- 5 Input the target value and place the USB colour analyzer over the square on screen.

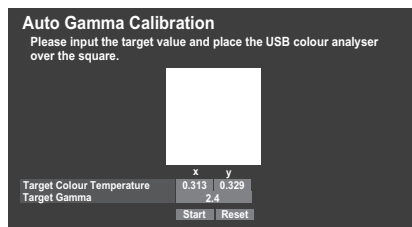

- 6 Highlight **Start** and press **OK**.
Auto Gamma Calibration will start.

Please wait until you see "Auto Gamma Calibration has been completed." on screen.

To return to factory setting

- 1 Highlight **Reset** and press **OK**.

Resetting to the factory defaults

- 1 In the **Expert Picture Settings** menu, press ▲ or ▼ to select **Reset** and press **OK**.

A confirmation screen appears.

- 2 Select **Yes** and press **OK**.

Control Visualization

This feature displays the brightness histogram and control curve of the current video signal.

- 1 In the **Picture** menu, press ▲ or ▼ to select **Control Visualization** and press **OK**. The histogram window will appear.

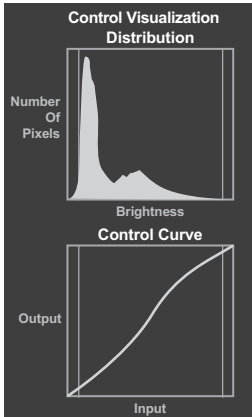

- 2 Press **BACK** to return to the previous menu.

Automatic Format (Widescreen)

When this television receives a true Widescreen picture and **Auto format** is **On**, it will automatically be displayed in Widescreen format irrespective of the television's previous setting.

- 1 Press **MENU** / ◀▶ to highlight **Setup** icon.
- 2 Press ▲ / ◀▶ to highlight **Preferences** icon and press **OK**.
- 3 Press ▲ or ▼ to select **Display Settings** and press **OK**.
- 4 Press ▲ or ▼ to select **Auto Format** and press ◀ or ▶ to select **On** or **Off**.

Display Settings	
Auto Format	On
4:3 Stretch	Off
Picture Position	
PC Settings	

4:3 Stretch

When **4:3 Stretch** is activated, the size switching system changes 4:3 programmes into full screen picture.

- 1 In the **Preferences** menu, press ▲ or ▼ to select **Display Settings** and press **OK**.
- 2 Press ▲ or ▼ to select **4:3 Stretch** and press ◀ or ▶ to select **On** or **Off**.

Blue Screen

When **Blue Screen** is selected, the screen will turn blue and the sound will be muted on analogue channels and external input modes when no signal is received.

NOTE: Some external input sounds may not be muted.

- 1 In the **Preferences** menu, press ▲ or ▼ to select **Blue Screen**.
- 2 Press ◀ or ▶ to select **On** or **Off**.

Picture Position

The picture position may be adjusted to suit personal preference and can be particularly useful for external inputs.

- 1 In the **Preferences** menu, press ▲ or ▼ to select **Display Settings** and press **OK**.
- 2 In the **Display Settings** menu, press ▲ or ▼ to select **Picture Position**.

Display Settings	
Auto Format	On
4:3 Stretch	Off
Picture Position	
PC Settings	

- 3 Press **OK** to view the options available for the picture format that has been selected.
- 4 Press ▲ or ▼ to select an option and press ◀ or ▶ to adjust the settings.



The options differ depending on the currently selected widescreen format and the input signal.

Picture Position	
Horizontal Position	0
Vertical Position	0
Reset	

To return to the original factory settings, select **Reset** in the **Picture Position** menu and press **OK**.





Picture still

This feature is used to hold a still image on the screen.

- 1 Press  to hold an image on the screen, and press  again to cancel.

HDMI Information Display

When the HDMI Information Display feature is On and you are watching an HDMI input source, pressing the  button displays the HDMI signal information banner.

- 1 In the **Preferences** menu, press  or  to select **HDMI Information Display**.
- 2 Press  or  to select **On**.

HDMI signal information is as follows:

Resolution, Scan Type, Frame Rate*, Aspect, Bit Depth, Colour Space, RGB/YUV, Chroma Format, and Content Type (if available).

* If the HDMI input source is interlaced, "**Field Rate**" will be displayed instead of "**Frame Rate**".

Using your home network

This TV is a DLNA CERTIFIED™ Player and Renderer. This TV can play digital content stored on a DLNA CERTIFIED™ product with server function.

If you want to use this TV as a DLNA CERTIFIED™ Player or Renderer, you will have to configure the network on your TV (see page 14).

If you want to use your home network, you will have to configure the network on your TV. (see page 14)

Change the network settings if necessary (see “Setting up the Network” on page 43).

When using a wireless home network:

Wireless Interoperability

The TOSHIBA Dual Band WLAN Adaptor is designed to be interoperable with any wireless LAN product that is based on Direct Sequence Spread Spectrum (DSSS)/Orthogonal Frequency Division Multiplexing (OFDM) radio technology, and is compliant to:

- The IEEE 802.11 Standard on Wireless LANs (Revision a/b/g/n), as defined and approved by the Institute of Electrical and Electronics Engineers.
- The TOSHIBA Dual Band WLAN Adaptor is intended for use with the SL86 series LCD TV's and should not be used with any other devices.

Use of the WLAN Adaptor in other USB products may result in damage to the WLAN Adaptor and or the equipment. Such use will void any warranty that may otherwise apply, and TOSHIBA will have no liability for any damage that may result from such use.

CAUTION

Bluetooth™ and Wireless LAN devices operate within the same radio frequency range and may interfere with one another. If you use Bluetooth™ and Wireless LAN devices simultaneously, you may occasionally experience a less than optimal network performance or even lose your network connection.

If you should experience any such problem, immediately turn off either your Bluetooth™ or Wireless LAN device.

Actual performance can vary, including lower wireless network capacity, data throughput rate, range and coverage.

Performance depends on many factors, conditions and variables, including distance from the access point, volume of network traffic, building materials and construction, operating system used, mix of wireless products used, interference and other adverse conditions.

Wireless LAN and your Health

Wireless LAN products, like other radio devices, emit radio frequency electromagnetic energy. The level of energy emitted by Wireless LAN devices, however, is far less than the electromagnetic energy emitted by wireless devices such as mobile phones.

Because Wireless LAN products operate within the guidelines found in radio frequency safety standards and recommendations, TOSHIBA believes Wireless LAN is safe for use by consumers. These standards and recommendations reflect the consensus of the scientific community and result from deliberations of panels and committees of scientists who continually review and interpret the extensive research literature.

In some situations or environments, the use of Wireless LAN may be restricted by the proprietor of the building or responsible representatives of the organization. Such restrictions may apply in environments where the risk of interference to other devices or services is perceived or identified as harmful.

If you are uncertain of the policy that applies to the use of wireless devices in a specific organization or environment, you are encouraged to ask for authorization to use the Wireless LAN device prior to turning on the equipment.

This Dual Band Wireless LAN Adaptor may be operated in the following countries:

AT	Austria	IS	Iceland
BE	Belgium	LI	Liechtenstein
CH	Switzerland	LT	Lithuania
CY	Cyprus	LU	Luxembourg
CZ	Czech Republic	LV	Latvia
DE	Germany	MT	Malta
DK	Denmark	NL	Netherlands
ES	Spain	NO	Norway
FI	Finland	PL	Poland
FR	France	PT	Portugal
GB	United Kingdom	SE	Sweden
GR	Greece	SI	Slovenia
EE	Estonia	SK	Slovakia
HU	Hungary	BG	Bulgaria
IT	Italy	RO	Romania
IE	Ireland	TR	Turkey

How to use this Dual Band Wireless LAN Adaptor

- If this device is going to be operated in the frequency range of 5.15 GHz to 5.35 GHz, it is restricted to indoor use.
- If this device is going to be operated for 802.11 b/g/n function in the frequency range of 2.454 GHz to 2.4835 GHz in France, it is restricted to indoor use.
- A general authorization is required for using this device outdoors or in public places in Italy.
- This device is NOT ALLOWED to be used in the geographical area within a radius of 20km from the centre of Ny-Alesund in Norway.

Wireless LAN Information (for UL86/UL87 series)

Bluetooth™ and Wireless LAN devices operate within the same radio frequency range and may interfere with one another. If you use Bluetooth™ and Wireless LAN devices simultaneously, you may occasionally experience a less than optimal network performance or even lose your network connection.

If you should experience any such problem, immediately turn off either your Bluetooth™ or Wireless LAN device.

Actual performance can vary, including lower wireless network capacity, data throughput rate, range and coverage. Performance depends on many factors, conditions and variables, including distance from the access point, volume of network traffic, building materials and construction, operating system used, mix of wireless products used, interference and other adverse conditions.

Wireless LAN and your Health

Wireless LAN products, like other radio devices, emit radio frequency electromagnetic energy. The level of energy emitted by Wireless LAN devices, however, is far less than the electromagnetic energy emitted by wireless devices such as mobile phones.

Because Wireless LAN products operate within the guidelines found in radio frequency safety standards and recommendations, TOSHIBA believes Wireless LAN is safe for use by consumers. These standards and recommendations reflect the consensus of the scientific community and result from deliberations of panels and committees of scientists who continually review and interpret the extensive research literature.

In some situations or environments, the use of Wireless LAN may be restricted by the proprietor of the building or responsible representatives of the organization. Such restrictions may apply in environments where the risk of interference to other devices or services is perceived or identified as harmful.

If you are uncertain of the policy that applies to the use of wireless devices in a specific organization or environment, you are encouraged to ask for authorization to use the Wireless LAN device prior to turning on the equipment.

When using the TV under wireless LAN environment:

- The function of all IEEE802.11 is not supported.
- The ad-hoc mode is not supported.
- It is recommended to use IEEE 802.11a or IEEE 802.11n on 5 GHz for audio and SD video streaming.
- It is recommended to use IEEE 802.11n on 5 GHz for HD video streaming.
- It is recommended that the encoding rate for streaming video content is 20 Mbps or less.
- It is not recommended to use 2.4 GHz for audio and video streaming.
- Content playback may be interrupted by various surrounding interference.

Europe Statement

This Built-in WLAN Module may be operated in below country:

AT	Austria	IS	Iceland
BE	Belgium	LI	Liechtenstein
CH	Switzerland	LT	Lithuania
CY	Cyprus	LU	Luxembourg
CZ	Czech Republic	LV	Latvia
DE	Germany	MT	Malta
DK	Denmark	NL	Netherlands
ES	Spain	NO	Norway
FI	Finland	PL	Poland
FR	France	PT	Portugal
GB	United Kingdom	SE	Sweden
GR	Greece	SI	Slovenia
EE	Estonia	SK	Slovakia
HU	Hungary	BG	Bulgaria
IT	Italy	RO	Romania
IE	Ireland	TR	Turkey

- If this device is going to be operated in the frequency range of 5.15 GHz to 5.35 GHz, it is restricted to indoor use.
- If this device is going to be operated for 802.11 b/g/n function in the frequency range of 2.454 GHz to 2.4835 GHz in France, it is restricted to indoor use.
- A general authorization is required for using this device outdoors or in public places in Italy.
- This device is NOT ALLOWED to be used in the geographical area within a radius of 20km from the centre of Ny-Alesund in Norway.



Ukraine Statement

Contains approved Built-in WLAN Module, model name: WLU5060-D4(ROHS), approved by CB "UkrCERTADIO".



0 2 5

Setting up the Network

You can select the Network Type.

- 1 Press **MENU** / ◀▶ to highlight **Setup** icon.
- 2 Press ▲/◀▶ to highlight **Preferences** icon and press **OK**.
- 3 Press ▲ or ▼ to select **Network Setup** and press **OK**.

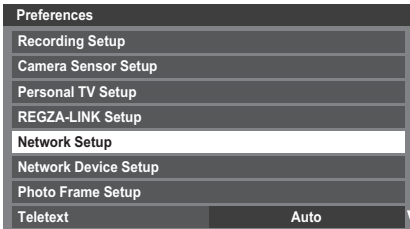

- 4 Press ▲ or ▼ to select **Network Type** and press ◀▶ to select **Wired** or **Wireless**.

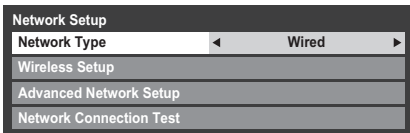

NOTE: For SL863 series, if the Dual Band WLAN Adaptor is not connected, Wireless cannot be selected.

- 5 If you selected **Wired**, see "Advanced Network Setup" on page 45.

Wireless Setup

NOTE (for SL86 series):

- This feature is grayed out when the Dual Band WLAN Adaptor is not connected or Network Type is set to Wired.
- When you insert or remove the wireless LAN adaptor, you must turn off your TV and unplug the power cord, and then plug and turn on again.
- Continued connection of AP (Access Point) is not guaranteed. The connection may be disconnected while watching TV.
- Do not remove the Dual Band WLAN Adaptor when **Network Type** is set to **Wireless** or wireless communication is active.

There are 3 methods for Wireless Setup:

Easy Setup (WPS)

If the AP supports WPS, this method can be used.

- WPS is an industry standard designed to make connection of wireless LAN equipment and security setup easy. WPS will automatically configure all wireless settings.

NOTE: WEP encryption may not be able to be configured by easy setup.

Assisted Setup (setup by using the AP's notification information)

Network Name, Authentication, and Encryption are decided based on information from the AP. You will manually set the Security Key.

Manual Setup (manual input of all settings)

Easy Setup using PBC (Push Button Configuration)

- 1 In the **Preferences** menu, press ▲ or ▼ to select **Network Setup** and press **OK**.
- 2 Press ▲ or ▼ to select **Wireless Setup** and press **OK**.
- 3 Press ▲ or ▼ to select **Easy Setup** and press **OK**.



- 4 Press ◀▶ to select **PBC**.
- 5 Press ▼ to highlight **Start Scan** and press **OK**.
- 6 Following the on-screen instructions, push the appropriate button on your AP.
- 7 When a window reporting that the setup is complete appears, press **OK**.

To cancel searching for the AP:

Press **BACK** while searching for the AP. A message will appear and press ◀▶ to select **Yes** and press **OK**.

Easy Setup using PIN (Personal Identification Number)

- 1 In the **Preferences** menu, press ▲ or ▼ to select **Network Setup** and press **OK**.
- 2 Press ▲ or ▼ to select **Wireless Setup** and press **OK**.
- 3 Press ▲ or ▼ to select **Easy Setup** and press **OK**.
- 4 Press ◀▶ to select **PIN**.
- 5 Press ▼ to select **Start Scan** and press **OK**.
- 6 Press ▲ or ▼ to select the desired AP and press **OK**.

NOTE: Check the Network Name and/or MAC address on the label of the AP or in the manual, and select your AP.

- 7 When the PIN code window appears, enter the displayed PIN into your AP and press **Next** to continue the PIN Setup. When a message displays to report that the setup is complete, press **OK**.

To cancel searching for the AP:

Press **BACK** while searching for the AP. A message will appear; then, press ◀ or ▶ to select **Yes** and press **OK**.

Assisted Setup

- 1** In the **Preferences** menu, press ▲ or ▼ to select **Network Setup** and press **OK**.
- 2** Press ▲ or ▼ to select **Wireless Setup** and press **OK**.
- 3** Press ▲ or ▼ to select **Assisted Setup** and press **OK**.
- 4** Press ▲ or ▼ to select the desired AP and press **OK**.

NOTE: Check the MAC address on the label of the AP or in the manual, and select your AP.

- 5** Highlight **Security Key** and press **OK**. The Software Keyboard window will appear.
- 6** Input the Security Key by using the Software Keyboard (see page 47). To save your setting, press the **BLUE** button.

NOTE:

- The Security Key must adhere to these conditions:
 - TKIP/AES: 8-63 ASCII or 64 Hex characters
 - WEP: 5 or 13 ASCII or 10 or 26 Hex characters
- There is only one key ID to set for WEP encryption.

- 7** Highlight **Done** and press **OK**.

NOTE: If **Network Name** is not displayed, see step 4 and 5 in **Manual Setup** below to set **Network Name** before pressing **Done**.

NOTE: Settings are not saved if **BACK** is pressed before **Done** is selected.

Manual Setup

- 1** In the **Preferences** menu, press ▲ or ▼ to select **Network Setup** and press **OK**.
- 2** Press ▲ or ▼ to select **Wireless Setup** and press **OK**.
- 3** Press ▲ or ▼ to select **Manual Setup** and press **OK**.
- 4** Press ▲ or ▼ to select **Network Name** and press **OK**. The Software Keyboard window will appear.
- 5** Input the Network Name by using the Software Keyboard (see page 47). To save your setting, press the **BLUE** button.

- 6** Press ▲ or ▼ to select **Authentication** and press ◀ or ▶ to select **Open System, Shared Key, WPA-PSK** or **WPA2-PSK**.

- 7** Press ▲ or ▼ to select **Encryption** and press ◀ or ▶ to select **None, WEP, TKIP** or **AES**.

NOTE:

- Certain encryption types are only compatible with specific authentication types.
 - When Authentication is Open System, only WEP or None is compatible.
 - When Authentication is Shared Key, only WEP is compatible.
 - When Authentication is WPA-PSK or WPA2-PSK, only TKIP or AES is compatible.
- When incompatible Authentication/Encryption pairings are detected, a warning message will be displayed, and no connection attempt will be made until the incompatibility is resolved.
- There is only one key ID to set for WEP encryption.

- 8** Press ▲ or ▼ to select **Security Key** and press **OK**.

- 9** Input the Security Key by using the Software Keyboard (see page 47). To save your setting, press the **BLUE** button.

NOTE: This item is grayed out when **Encryption** is **None**.

- 10** Highlight **Done** and press **OK**.

NOTE: When **Encryption** is **None**, a message will appear. Press ◀ or ▶ to select **Yes** and press **OK**.

NOTE: Settings are not saved if **BACK** is pressed before **Done** is selected.

Enhanced 11n

When **Enhanced 11n** is set to **On**, the Dual Channel (40MHz) feature is available.

NOTE: In addition, some other optional 11n features will be enabled.

- 1** In the **Preferences** menu, press ▲ or ▼ to select **Network Setup** and press **OK**. Highlight **Wireless Setup** and press **OK**.
- 2** Press ▲ or ▼ to select **Enhanced 11n** and press ◀ or ▶ to select **On**.

Wireless Information

The settings configured in Wireless Setup can be confirmed.

- 1 Press **QUICK** to open the **Quick Menu**.
- 2 Press **▲** or **▼** to select **Wireless Information** and press **OK**.

Menu Example (UL series)

Quick Menu	
Picture Mode	AutoView
Picture Size	Super Live
Personal Mode	
More Information	
Channel Options	
Sleep Timer	00:00
REGZA-LINK Device Control	
Speakers	TV Speakers
Headphone Level	50
Wireless Information	
Recording Information	

- 3 When the **Network Type** is **Wireless**, a Wireless Information window will appear.

NOTE: Press the **RED** button to scan for all APs.

Item	Description
Status	Connected is displayed when the TV is connected with the AP. Disconnected is displayed when the TV is not connected with the AP.
Signal	Connection signal strength with AP (STRONG/MEDIUM/WEAK)
Speed	Link with AP
Mode	Working mode (11a, 11b, 11g, 11n)
Channel	Channel in use (1-165)
Network Name	SSID set
Authentication	Authentication set
Encryption	Encryption set
Security Key	Security Key set
AP MAC Address	The AP's MAC address is displayed when the TV is connected with the AP.
TV MAC Address	The MAC address of the TV or USB (Dual Band WLAN Adaptor) is displayed.
DHCP	Enabled is displayed when using DHCP. Disabled is displayed when not using DHCP.
IP Address	The TV's IP address
Subnet Mask	Value of the Subnet Mask
Default Gateway	Address of the Default GATEWAY
DNS	Address of the DNS

NOTE: Even if an AP for IEEE 802.11n is used when **Encryption** is set to **WEP** or **TKIP**, the Speed value might be low. It is recommended that **Encryption** be changed to **AES** (see "Manual Setup" on page 44).

Notes on wireless LAN environment:

- The function of all IEEE802.11 is not supported.
- The ad-hoc mode is not supported.
- It is recommended to use IEEE 802.11a or IEEE 802.11n on 5 GHz for audio and SD video streaming.
- It is recommended to use IEEE 802.11n on 5 GHz for HD video streaming.
- It is recommended that the encoding rate for streaming video content is 20 Mbps or less.
- It is not recommended to use 2.4 GHz for audio and video streaming.
- Content playback may be interrupted by various surrounding interference.

Advanced Network Setup

NOTE:

- When the DHCP function of the router connected with this TV is On, you can set **Auto Setup** to **On** or **Off**. (This should usually be set to **On**.)
- When the DHCP function of the router is Off, set **Auto Setup** to **Off**, and set the IP Address manually.

IP Address Setup

Auto Setup:

- 1 In the **Preferences** menu, press **▲** or **▼** to select **Network Setup** and press **OK**.
- 2 Press **▲** or **▼** to select **Advanced Network Setup** and press **OK**.

Network Setup	
Network Type	Wired
Wireless Setup	
Advanced Network Setup	
Network Connection Test	

- 3 Press **▲** or **▼** to select **IP Address Setup** and press **OK**.

Advanced Network Setup	
IP Address Setup	
DNS Setup	
MAC Address	

- 4 Highlight **Auto Setup** and press ◀ or ▶ to select **On**.

IP Address Setup	
Auto Setup	◀ On ▶
IP Address	XXX . XXX . XXX . XXX
Subnet Mask	255 . 255 . 255 . 0
Default Gateway	

NOTE: Other items will be grayed out when **Auto Setup** is set to **On**.

Manual Setup:

- 1 In the **Preferences** menu, press ▲ or ▼ to select **Network Setup** and press **OK**.
- 2 Press ▲ or ▼ to select **Advanced Network Setup** and press **OK**.
- 3 Press ▲ or ▼ to select **IP Address Setup** and press **OK**.
- 4 Highlight **Auto Setup** and press ◀ or ▶ to select **Off**.

IP Address Setup	
Auto Setup	◀ Off ▶
IP Address	XXX . XXX . XXX . XXX
Subnet Mask	255 . 255 . 255 . 0
Default Gateway	

- 5 Press ▲ or ▼ to select **IP Address**.
- 6 Press ◀ or ▶ to highlight the field you want to change, and then use the number buttons to input the IP address. To save the setting, press **OK**.

NOTE: IP address field numbers must be between 0 and 255. After each field number has been set, press **OK** to store the entire address. If the entire IP Address is invalid, a warning message will appear after **OK** is pressed.

- 7 Press ▲ or ▼ to select **Subnet Mask**, and edit in the same way as IP Address.

IP Address Setup	
Auto Setup	Off
IP Address	XXX . XXX . XXX . XXX
Subnet Mask	255 . 255 . 255 . 0
Default Gateway	

- 8 Press ▲ or ▼ to select **Default Gateway**, and edit in the same way as IP Address.

NOTE: If you manually set the IP address, you must not use the same IP address for any other device. The IP address you use should be a private address.

DNS Setup

NOTE: When the DHCP function of the router connected to this TV is Off, set Auto Setup to Off, and manually set the DNS address(es). Your internet service provider should have provided these to you.

Auto setup:

- 1 In the **Preferences** menu, press ▲ or ▼ to select **Network Setup** and press **OK**.
- 2 Press ▲ or ▼ to select **Advanced Network Setup** and press **OK**.
- 3 Press ▲ or ▼ to select **DNS Setup** and press **OK**.
- 4 Press ▲ or ▼ to highlight **Auto Setup** and press ◀ or ▶ to select **On**.

NOTE: Other items will be grayed out when **Auto Setup** is set to **On**.

Manual setup:

- 1 In the **Preferences** menu, press ▲ or ▼ to select **Network Setup** and press **OK**.
- 2 Press ▲ or ▼ to select **Advanced Network Setup** and press **OK**.
- 3 Press ▲ or ▼ to select **DNS Setup** and press **OK**.
- 4 Press ▲ or ▼ to select **Auto Setup** and press ◀ or ▶ to select **Off**.

DNS Setup	
Auto Setup	◀ Off ▶
Primary DNS Address	XXX . XXX . XXX . XXX
Secondary DNS Address	255 . 255 . 255 . 0

- 5 Press ▲ or ▼ to select **Primary DNS Address**.
- 6 Press ◀ or ▶ to highlight the field you want to change, and then use the number buttons to input the Primary DNS Address. To save the setting, press **OK**.

NOTE: DNS address field numbers must be between 0 and 255. If you input an incompatible number and press **OK**, the field number will reset to the previous value.

- 7 Press ▲ or ▼ to select **Secondary DNS Address**, and edit in the same way as Primary DNS Address.

MAC Address

You can view the fixed MAC address for the TV and for the Dual Band WLAN Adaptor, if one is installed.

- 1 In the **Preferences** menu, press **▲** or **▼** to select **Network Setup** and press **OK**.
- 2 Press **▲** or **▼** to select **Advanced Network Setup** and press **OK**.
- 3 Press **▲** or **▼** to select **MAC Address** and press **OK**.

Network Connection Test

This function checks the Internet connectivity.

- 1 In the **Preferences** menu, press **▲** or **▼** to select **Network Setup** and press **OK**.
- 2 Press **▲** or **▼** to select **Network Connection Test** and press **OK**.

A message will appear to indicate if the connection was successful or if it could not be completed.

NOTE: The result of Network Connection Test does not always guarantee the connection. Depending on the situation, YouTube may not be able to be used.

To cancel the Network Connection Test:

- 1 Press **BACK** while searching for the Internet connection.

Using the software keyboard

You can enter text by using the Software Keyboard. The Software Keyboard window will appear when you press **OK** on a field that accepts character input.

To enter text using the software keyboard:

- 1 Highlight the desired character on the on-screen software keyboard.
- 2 Press **OK**.
- 3 Repeat steps 1 and 2 until you have entered all desired text.
- 4 Press the **BLUE** button to close the software keyboard and return to the previous screen.

NOTE: If **BACK** is pressed, changes are not saved and the software keyboard window is closed. The text will remain as it was before starting the keyboard.

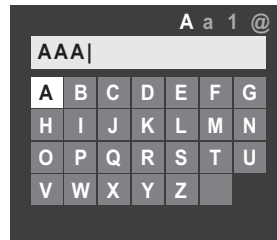

Input operation on the remote control:

Button	Description
OK	Inputs the selected character.
0-9	Inputs the number directly.
▲▼◀▶	Moves the character highlight.
◀▶▶▶	Moves the cursor.
◀◀	Moves the cursor to the head of a character string.
▶▶	Moves the cursor to the end of a character string.
RED	Deletes 1 character to the left of the cursor.
GREEN	Cycles through upper case, lower case, numbers, and symbols, if available.
YELLOW	Chooses an accented version of the current letter, if applicable.
BLUE	Saves changes and closes the Software Keyboard window.
BACK	Closes the Software Keyboard window without saving changes.

Network Device Setup

External Control Setup

This setup allows you to operate a home network-connected your TV from an external device.

Media Controller Setup

- 1 In the **Preferences** menu, press ▲ or ▼ to select **Network Device Setup** and press **OK**.

Menu Example (UL series)

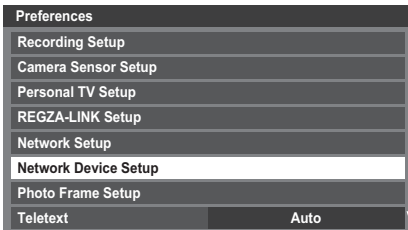

- 2 Press ▲ or ▼ to select **External Control Setup** and press **OK**.
- 3 Press ▲ or ▼ to select an option and press **OK**.

The Software Keyboard window will appear.

User Name — Input the User Name (to control the TV from the iPhone etc.) by using the on-screen software keyboard (see page 47). The maximum number of characters is 16.

Password — Input the Password (to control the TV from the iPhone etc.) by using the on-screen software keyboard (see page 47). The maximum number of characters is 16.

NOTE: Toshiba does not guarantee normal operation with all connected devices.

Media Renderer Setup

Terminology:

DMS: DLNA CERTIFIED™ Server

DMR: DLNA CERTIFIED™ Renderer

DMC: DLNA CERTIFIED™ Controller

The TV can be configured as a DMR. When operating as a DMR, the TV displays content provided by a DMS. The selection of the media is done by the DMC - the TV does not select the input. The TV can play photo, movie, or audio files when operating as a DMR.

Media Renderer

- 1 In the **Preferences** menu, press ▲ or ▼ to select **Network Device Setup** and press **OK**.
- 2 Press ▲ or ▼ to select **Media Renderer Setup** and press **OK**.
- 3 Press ▲ or ▼ to select **Media Renderer**, and then press ◀ or ▶ to select **On** or **Off**.

Media Controller Setup

You can limit which DMC can control this TV. If Access Control is enabled, only those DMCs with a check will be allowed to control the TV.

- 1 In the **Media Renderer Setup** menu, press ▲ or ▼ to select **Media Controller Setup** and press **OK**.
- 2 Press ▲ or ▼ to select **Access Control** and press ◀ or ▶ to select **On**.
- 3 Press ▲ or ▼ to select **Select Media Controller** and press **OK**.
- 4 Press ▲ or ▼ to highlight the item you want to select and press **OK**. A check will appear in the box.
To remove the check, press **OK** again.
- 5 Press ▶ to highlight **Done** and press **OK**.

NOTE:

- You can select up to 8 DMC devices.
- If you would not like to limit the DMCs for this TV, set **Access Control** to **Off**.
- Devices other than DMCs may be displayed in the list. Confirm the MAC address of the DMC and set it.

Maximum Volume Setup

This feature allows you to set the maximum volume of the TV when it receives volume operation commands from a DMC.

- 1 In the **Media Renderer Setup** menu, press ▲ or ▼ to select **Maximum Volume Setup**, and press ◀ or ▶ to adjust to the desired volume.

NOTE:

- The TV's remote control can set volume regardless of the value of **Maximum Volume Setup**.
- When DMR playback ends, the TV volume will return to the value in effect when DMR playback was started.

Power Control Mode

When the TV is connected to the home network via Wireless LAN, Wake-on-LAN can be received from an external device connected to the home network to turn on the TV.

- 1 In the **Preferences** menu, press ▲ or ▼ to select **Network Device Setup** and press **OK**.
- 2 Press ▲ or ▼ to select **Power Control Mode** and press ◀ or ▶ to select **On** or **Off**.

NOTE:

- When **Wired** is selected for the **Network type** in **Network Setup**, this feature will be grayed out.
- Depending on the device connected to the home network, it may take a while for the TV to turn on.
- Depending on the device connected to the home network, this feature may not work.
- If the unencrypted Wireless Setup is done, this feature can not be used.

Device Name Setup

The TV's DMR device name can be changed. The device name can be confirmed from the DMC.

- 1 In the **Network Device Setup** menu, press ▲ or ▼ to select **Device Name Setup** and press **OK**.
 - 2 Highlight the **Device Name** field and press **OK**. The Software Keyboard window will appear.
 - 3 Input the Device Name by using the Software Keyboard (see page 47). Press the **BLUE** button.
- NOTE:** The Device Name can be up to 15 characters long.
- 4 Highlight **Done** and press **OK** to save your setting.

Using the USB HDD Function (for UL863 and UL875 series)

The USB HDD function can be used to record and view digital broadcast programmes. Read the precautions below before recording or viewing programmes using the USB HDD function.

NOTE:

- Recorded programmes saved on the USB HDD can only be viewed on this TV. They cannot be viewed when connected to another TV (including the same model of TV), a PC, or other device.
- You cannot watch one channel while recording another.
- If the recording time to the USB HDD is too short, no data may be saved.
- You cannot record video input signals on the USB HDD.
- Not all types of broadcast may be recordable.
- After programming the TV to record digital broadcasting, do not disconnect the power plug before recording starts. Also, leaving the power switch "ON" until recording is scheduled to start, may cause the recording to fail.
- Should video or audio recording fail due to malfunction of the TV or poor reception, no compensation shall be paid.
- You can reserve up to a total of 64 programmes for recording and viewing.
- If there is a power failure or the power plug is disconnected during programmed recording, recording will stop and will not resume when the power returns or the plug is reconnected.
- Do not disconnect the power plug when the indicator lamp is lit.
- Any changes implemented by the broadcasting station may affect programme scheduling.
- Scheduling of multiple consecutive programmes may result in the beginning of each programme not being recorded.
- When the "Programme Tracking" for programmed recording is set to "On" and the broadcast time of the scheduled programme overlaps with the start time of timer viewing due to delay, extension, or other causes, timer viewing will be cancelled.
- Depending on the situation at the time, not all items can be set or changed. ("X" indicates no setting.)
- Programmed recording cannot take place if the power plug is not connected.
- Disconnecting the power plug during recording may result in failure to save the recorded programme.
- Changing the **USB 2 Port Setup** to **Media Player** will invalidate all previously made programmed recordings. (see page 64)

To record DTV programmes (One Touch Recording)

You can easily record the programme currently being viewed.

- 1 Press the **REC** button on the remote control.

Recording for the currently viewing programmes will start.

The programme indicator (red) will be lit.

To stop recording

- 1 Press the **■** (stop) button.

A confirmation window "Do you want to stop Recording?" will appear.

- 2 Press **◀** or **▶** to select **Yes** and press **OK**.

Recording will stop.

To schedule programmed recording

Programmed recording can be scheduled easily using the Programme Guide or by specifying the date and time.

PLEASE NOTE:

When a timed programme is about to start, an information screen will appear offering the option of watching or cancelling the programme. The menus and other channels will not be available during the timed programme unless the programme timer is cancelled.

It will only be possible to create or edit programme timers for the currently tuned DTV input.

To schedule programmed recording using the Programme Guide

- 1 Press the **GUIDE** button on the remote control (or select **TV Programmes/Guide** menu from the menu system) to display the EPG screen.
- 2 Press **▲▼◀▶** to highlight the programme you want to record.

- 3 Press **OK**. The **Set Timer** menu will appear.

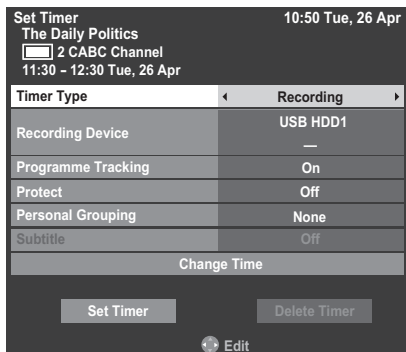

- 4 Press **▲** or **▼** to highlight **Timer Type** and press **◀** or **▶** to select **Recording**.

- 5 Press **▲** or **▼** to highlight **Recording Device** and press **◀** or **▶** to select the connected USB HDD.

- 6 Press **▲** and **▼** to go through the list adding the details of the programme by using the number buttons and **◀** and **▶** to make selections.

Programme Tracking:

If information concerning programme delay is sent from the broadcasting station, Programme Tracking will link recording with a delay of up to three hours. Programme Tracking is enabled when **On** is selected. (It does not support advancing of the broadcast time.)

Protect:

Select this function when you want to protect a recorded programme. When **On** is selected, the programme will be protected. You can protect and unprotect recorded programmes afterwards.

Personal Grouping:

Setting Personal Mode for a programme when it is recorded makes it easier to find later for viewing. Select your preferred **Personal Mode**. If you select **None**, the programme will be grouped by **All in Library**.

NOTE: To change the set **Start Time** or **End Time**, select **Change Time** and press **OK**. Change the **Start Time** or **End Time** from the displayed **Set Timer** screen.

- 7 Press **▲** or **▼** to highlight **Set Timer** and press **OK**.

The **ORANGE LED** will be lit.

To search for and schedule a programme you want to record using Genre Search

- 1 In the Guide screen, press **QUICK**.
- 2 Press **▲** or **▼** to highlight **Genre Colour** in the **Quick Menu** and press **OK**.

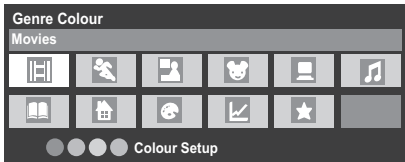

- 3 With the focus on a particular genre, press the desired coloured button to assign. Four colours will be available to set. Press **BACK** to go back to the Guide screen.
- 4 Press the **YELLOW** button to access the **Genre Search** screen.

Channel	Programme	Time
34 AB1	Hard Rain	Wed,27 Apr 0:15-1:45
31 PARIS PREMIERE	Red Corner	Wed,27 Apr 22:15-23:55
11 NT1	The Lawnmower Man	Thu,28 Apr 1:20-3:00
9 W9	A Vow to Kill	Fri,29 Apr 1:30-3:00
34 AB1	Parenthood	Sat,30 Apr 0:45-2:40
11 NT1	Body and Soul	Sat,30 Apr 1:15-3:00
31 PARIS PREMIERE	The Nun's Story	Sat,30 Apr 15:00-17:30
9 W9	Red Corner	Sat,30 Apr 23:20-1:15
11 NT1	The Real Blonde	Sun,1 May 0:40-2:00
31 PARIS PREMIERE	Critters	Sun,1 May 0:40-2:20
11 NT1	Indiana Jones and the Temple of Doom	Sun,1 May 21:10-23:20
11 NT1	The jackal	Sun,1 May 23:20-1:15
34 AB	Coup De Ville	Mon,1 May 1:10-3:00

- 5 Press **◀** or **▶** to select the genre. Programmes listed will change for the new genre. Press **▲** or **▼** to select the programme for which you want to schedule recording.

- 6 Press **OK**. The **Set Timer** menu will appear.

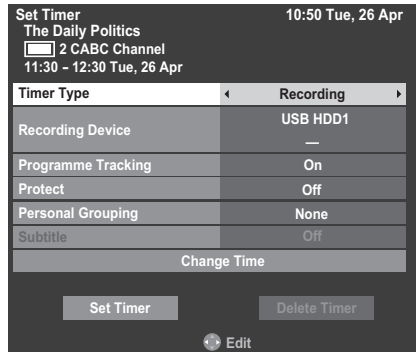

- 7 Press **▲** or **▼** to highlight **Timer Type** and press **◀** or **▶** to select **Recording**.
- 8 Press **▲** or **▼** to highlight **Recording Device** and press **◀** or **▶** to select the connected USB HDD.
- 9 Press **▲** and **▼** to go through the list adding the details of the programme by using the number buttons and **◀** and **▶** to make selections.
- 10 Press **▲** or **▼** to highlight **Set Timer** and press **OK**.

The **ORANGE LED** will be lit.

To programme the timer

- 1 Press **MENU** / ◀▶ / ▲ / ▶ to highlight **TV Programmed / Programme Timers** icons and press **OK**.
- 2 Select the unprogrammed column (blank column) and press **OK**.
The **Set Timer** menu will appear.

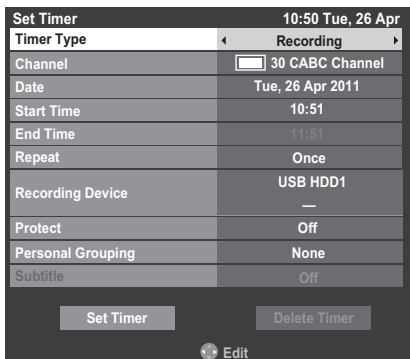

- 3 Press ▲ or ▼ to highlight **Timer Type** and press ◀▶ to select **Recording**.
- 4 Press ▲ and ▼ to go through the list adding the details of the programme by using the number buttons and ◀ and ▶ to make selections.

Channel:

Select the channel for programmed recording.

Date:

Select the date for programmed recording.

Start Time:

Select the time to start recording.

End Time:

Select the time to end recording.

Repeat:

Select **"Once"**, **"Daily"** or **"Weekly"**.

Once	The selected content is recorded once.
Daily	The same time slot on the same channel is recorded every day on and after the selected day.
Weekly	The same time slot on the same channel on the same day of the week is recorded on and after the selected day.

Recording Device:

Select the connected USB HDD.

Protect:

Select this function when you want to protect a recorded programme. When **On** is selected, the programme will be protected. You can protect and unprotect recorded programmes afterwards.

Personal Grouping:

Select a Personal Mode for the programme to be recorded to make it easier to find later for viewing. Select your preferred **Personal Mode**. If you select **None**, the programme will be grouped by **All in Library**.

Subtitle:

Select **On** when you want subtitles to be included in the recording.

- 5 Press ▲ or ▼ to highlight **Set Timer** and press **OK**.
The **ORANGE LED** will be lit.

To schedule a programme using the information screen

- 1 Press **i+**, the information screen will appear giving details of the channel and programme currently being viewed.

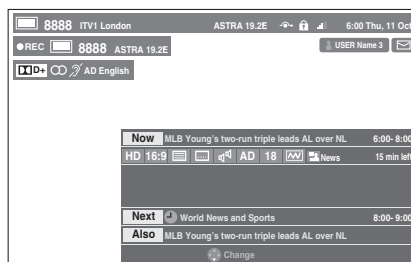

- 2 Press ▲ or ▼ to select the **Next** and press **OK**. The **Set Timer** menu will appear.

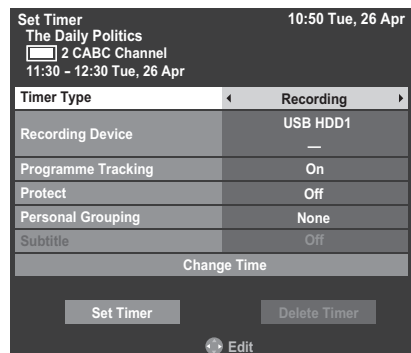

3 Press ▲ or ▼ to highlight **Timer Type** and press ◀ or ▶ to select **Recording**.

4 Press ▲ or ▼ to highlight Recording Device and press ◀ or ▶ to select the connected USB HDD.

5 Press ▲ and ▼ to go through the list adding the details of the programme by using the number buttons and ◀ and ▶ to make selections.

Refer to step 6 on page 50 for details.

6 Press ▲ or ▼ to highlight **Set Timer** and press **OK**.

The **ORANGE LED** will be lit.

To check, edit or delete scheduling information

You can check, edit or delete scheduling information.

1 Press **MENU** / ◀ / ▲ / ▶ to highlight **TV Programmes / Programme Timer** icons and press **OK**. **Programme Timer** screen will appear.

Recording List:

- Depending on the transmitter information, the programme broadcast time or other information may not be correctly displayed in the recording list.
- The programme does not appear in the recording list immediately at the start of recording, but appears a few minutes after recording starts.
- Up to 500 programmes can be displayed in the recording list.
- If the channel settings are changed, the digital channel number, or other information may not appear correctly in the recording list.
- As the displayed programme time is calculated from the actual recording information, it may not match the recording time on the USB HDD.

To check a schedule

1 Press ▲ or ▼ on the **Programme Timer** screen to check the schedule.

To edit a schedule

1 Press ▲ or ▼ on the **Programme Timer** screen to select the title whose schedule you want to edit and press **OK**.

The **Set Timer** screen will appear. Change the settings as required, following the same procedure as for setting the schedule.

2 Press ▲ or ▼ to highlight **Set Timer** and press **OK**.

To delete a schedule

1 Press ▲ or ▼ on the **Programme Timer** screen to select the title whose schedule you want to delete.

2 Press the **RED** button.

Press ◀ or ▶ in the displayed confirmation window to select **Yes** and press **OK**. The selected schedule will be deleted.

NOTE: You can also delete a schedule by selecting **Delete Timer** from the **Set Timer** menu for each programming method.

To view a recorded programme

Display the **Library** screen and select the title of the recorded programme from the list.

1 Press **MENU** / ◀ / ▲ / ▶ to highlight **TV Programmes / Library** icons and press **OK**. **Library** screen will appear.

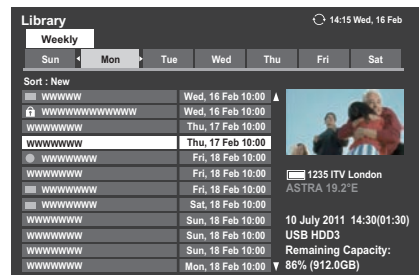

2 Press ▲ or ▼ to select the title you want to view.

The content of the title selected on the thumbnail screen is played.

To change the order in which the titles are listed, press the **BLUE** button to select **New** or **Old**.

To display the titles by week or by **Personal Mode**, press the **YELLOW** button to select **All**, **Weekly** or **Personal Grouping**.

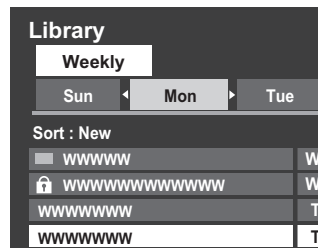

Press ◀ or ▶ to select a day tab or **Personal Mode** tab.

NOTE: If no titles have been registered to **Personal Mode**, **Personal Grouping** will be grayed out.

3 Press **OK**.

Viewing starts.

● icon appears next to the title currently being recorded.

When the title currently being recorded is selected and **OK** is pressed, playback will start from the beginning of the programme currently being recorded.

Operations during viewing

The following operations can be performed using the remote control buttons.

- | | | | |
|---|---|---|-----------------|
| ▶ | To PLAY | ⏮ | To SKIP-BACK |
| ■ | To STOP | ⏪ | To REWIND |
| ⏸ | To PAUSE/STEP
To start Time Shift
Recording | ⏩ | To FAST FORWARD |
| | | ⏭ | To SKIP-FORWARD |

Operations from the Library screen

As well as viewing the list of recorded titles on the **Library** screen, you can protect or delete titles and register titles to **Personal Mode**.

To display the Library screen

1 Press **MENU** / ◀▶ / ▲ / ▼ to highlight **TV Programmed / Programme Timers** icons and press **OK**.

2 Press ▲ or ▼ to select **Library** and press **OK**. The **Library** screen will appear.

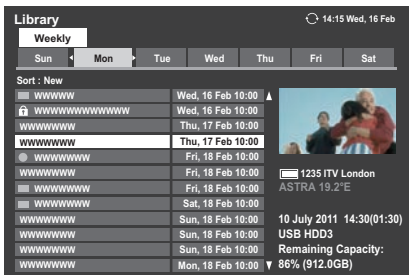

To protect or unprotect a recorded programme

Protecting a programme prevents it from being accidentally deleted.

Select the title of the programme you want to protect and press the **GREEN** button. A lock icon appears next to the title and the programme is protected.

If Protect is set to **On** when the programme is recorded, a lock icon appears next to the title of the recorded programme.

When a title with a lock icon is selected and the **GREEN** button is pressed, the lock icon disappears and the programme is unprotected.

To delete a recorded programme

1 Press the **RED** button. Check boxes will appear next to the titles.

2 Press ▲ or ▼ to select the title you want to delete and press **OK**. A check mark will be inserted in the check box.

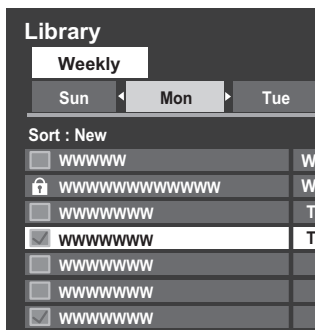

To insert a check mark against all the titles, press the **GREEN** button.

To uncheck all the check boxes, press the **BLUE** button.

NOTE:

- A check mark will not be inserted against protected titles.
- Note that once deleted, a title cannot be restored.

3 Press the **RED** button.

Select **Yes** in the confirmation window and press **OK**.

All the titles with check marks will be deleted.

To register a recorded title to Personal Mode

- 1 Select the title you want to register to **Personal Mode**.
- 2 Press the **QUICK** button to display the **Personal Mode** registration menu.



- 3 Press ◀ or ▶ to select the **Personal Mode** to which you want to register the title and press **OK**.

The title will be registered to the selected **Personal Mode**.

You can remove a title from the registered **Personal Mode** by selecting **None**.

To check the remaining USB HDD capacity

You can check the remaining capacity of the USB HDD using **Remaining Capacity**.



NOTE: The remaining capacity displayed is only a guide; it is not guaranteed.

Other useful functions (Time Shift Recording)

If you move away from the TV for a while, such as when the phone rings while you are watching TV, you can easily start recording and then catch up with the programme later.

- 1 Press **III** on the remote control while viewing DTV.
The screen will switch to the Pause image and recording will start automatically.
The recording time is the time set in **One Touch Recording** (see page 50).
- 2 Press **▶** (play).
Catch-up viewing will start from where the programme was paused.

Recording Setup

You can set your preferences for One Touch Recording or for scheduling recording.

To set the recording time for One Touch Recording

- 1 Press **MENU** / ◀▶ to highlight **Setup** icon.
- 2 Press ▲ / ◀▶ to highlight **Preferences** icon and press **OK**.
- 3 Press ▲ or ▼ to select **Recording Setup** and press **OK**.

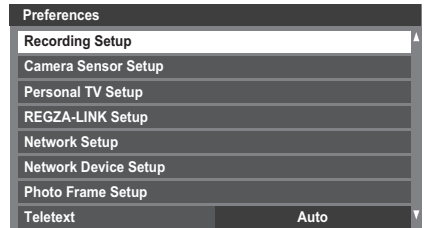

- 4 Press ▲ or ▼ to select **One Touch Recording Time**.

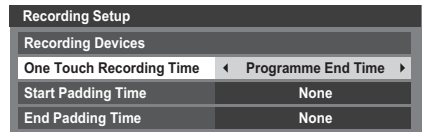

- 5 Press ◀ or ▶ to select the recording time.

You can set the **Programme End Time** in 30-minute increments in the range of 30 minutes to 360 minutes.

To set the padding time for programmed recording start time and end time.

- 1 In the **Recording Setup** screen, press ▲ or ▼ to select **Start Padding Time**.
- 2 Press ◀ or ▶ to select a time.
You can select from **None**, 1 minute, 3 minutes, 5 minutes and 10 minutes. Recording will start at the selected number of minutes prior to the recording start time.
- 3 Press ▲ or ▼ to select **End Padding Time**.
- 4 Press ◀ or ▶ to select a time.
You can select from **None**, 1 minute, 3 minutes, 5 minutes and 10 minutes. Recording will end at the recording end time plus the selected number of minutes.

Setting USB HDD Energy-Saving Mode

- 1 In the **Recording Setup** screen, press ▲ or ▼ to select **Recording Devices** and press **OK**.
- 2 Press ▲ or ▼ to select **Device Energy Saving Mode**.



- 3 Press ◀ or ▶ to select **Normal** or **Energy Saving**.

NOTE:

- When set to **Energy Saving**, it may take a while for the USB HDD to function.
- When set to **Energy Saving**, depending on the type of USB HDD, the USB HDD indicator lamp may not indicate standby status even when in standby status.

To change the name of the USB HDD

- 1 In the **Recording Setup** screen, press ▲ or ▼ to select **Recording Devices** and press **OK**.
- 2 Press ▲ or ▼ to select **Device List** and press **OK**. The **Device List** screen will appear.

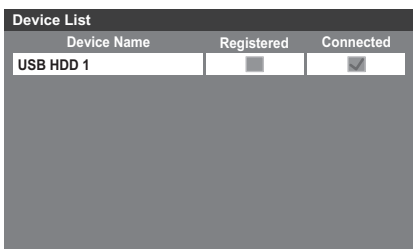

- 3 Press the **GREEN** button.

Edit the desired name by using the software keyboard (page 47). The maximum number of characters is 10.

NOTE: If multiple USB HDD appear on the **Device List** screen in Step 2, press ▲ or ▼ to select the USB HDD whose name you want to change.

To perform a USB HDD operation test

- 1 Press the **YELLOW** button on the **Device List** screen.
USB HDD operation test will start.
Wait until the test ends.

NOTE: The results of the device test are only a guide. The device may not function as shown in the results.

To register a USB HDD

- 1 Press **OK** on the **Device List** screen.
Press ◀ or ▶ to select **Yes** in the confirmation window that will appear and press **OK**. USB HDD registration will start. Wait until registration ends.

NOTE:

- If multiple USB HDD appear on the **Device List** screen, press ▲ or ▼ to select the USB HDD you want to register.
- If a USB HDD is re-registered, it will not be formatted.

To format a USB HDD

- 1 Press the **BLUE** button on the **Device List** screen.
Press ◀ or ▶ to select **Yes** in the confirmation window that will appear and press **OK**. Formatting will start. Wait until formatting ends.

NOTE:

- If multiple USB HDD appear on the **Device List** screen, press ▲ or ▼ to select the USB HDD you want to format.
- When the USB HDD is formatted, all the data stored on the USB HDD will be deleted.

To disconnect a USB HDD

- 1 Press **MENU** / ◀▶ to highlight **Setup** icon.
- 2 Press ▲ / ◀▶ to highlight **Preferences** icon and press **OK**.
- 3 Press ▲ or ▼ to select **Recording Setup** and press **OK**.
- 4 Press ▲ or ▼ to select **Recording Devices** and press **OK**. The **Device List** screen will appear.

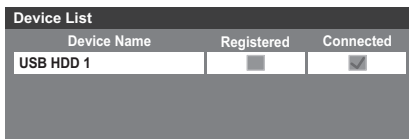

- 5 Press the **RED** button.
Press ◀ or ▶ to select **Yes** in the confirmation window that will appear and press **OK**. The **Connected** check mark will be removed. Disconnect the USB HDD.

NOTE: If multiple USB HDD appear on the **Device List** screen, press ▲ or ▼ to select the USB HDD you want to disconnect.

To confirm/delete Recording Information

If programmed recording is not performed correctly or some other error occurs, you can check the error content using **Recording Information**. Up to 64 **Recording Information** entries will be recorded and when the maximum is exceeded, entries will be deleted starting from the oldest. You can delete **Recording Information** after you have checked it.

- 1 Press **QUICK** to open the **Quick Menu**.
- 2 Press **▲** or **▼** to select **Recording Information** and press **OK**. The **Recording Information** screen will appear.



The recorded Recording Information list will appear.
 (Yellow) icon will appear next to unread Recording Information.

To check the content of Recording Information

- 1 In the **Recording Information** screen, press **▲** or **▼** to select the title you want to display.
- 2 Press **OK**. The content of **Recording Information** will appear.

Display Example

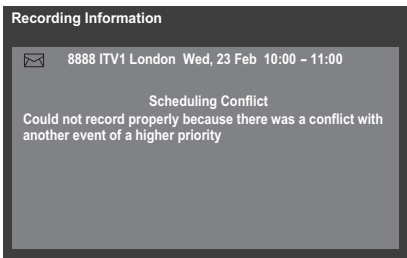

When you have checked the content, press **BACK**. The screen will return to the previous screen.

To delete Recording Information

- 1 In the **Recording Information** screen, press **▲** or **▼** to select the **Recording Information** you want to delete and press **OK**.
- 2 Press the **RED** button.
 Select **Yes** in the confirmation window that will appear and press **OK**.
 The selected **Recording Information** will be deleted.

Scheduling priority

If scheduled time slots are next to each other and there is more than one minute between the end time of the first schedule and the start time of the next schedule, programmed recording will be performed correctly.

- When **Start Padding Time** and **End Padding Time** are set (see page 55), the start time and end time will be the time plus the additional minutes.

If scheduling times overlap, priority will be given to the programmed recording which starts first. When the programmed recording that started first ends, recording will switch to the next scheduled programme. At this time, depending on how far the scheduling times overlap, the beginning section of the next scheduled programme may not be recorded.

- When **End Padding Time** is set for the first programmed recording (see page 55), depending on how far the scheduling times overlap, the **End Padding Time** may be ignored and recording of the next scheduled programme may start. As priority is given to the time set in the **Set Timer** menu over the Padding Time, recording will automatically be triggered when the next scheduled programme start time is reached during **End Padding Time**.

Camera Sensor Settings

The Camera Sensor can detect a person's face or movement and identify individuals by their registered faces. The screen mute and the standby mode functions by the face detection and motion detection functions of the Camera Sensor operate, and power consumption is saved as a result.

- 1 In the **Preference** menu, press ▲ or ▼ to select **Camera Sensor Setup** and press **OK**.
- 2 Press ▲ or ▼ to select **Camera Sensor** and press ◀ or ▶ to select **On** (to activate the following settings).
- 3 Press ▲ or ▼ to select **Camera Sensor Mode** and press ◀ or ▶ to select **Normal** or **Energy Saving**.
 - **Normal**
If the Camera doesn't detect the person for 60 seconds, the screen brightness decreases. In addition, after the time set with **Time until Picture Off**, the picture disappears. In addition, after the time set with **Time until Standby**, the TV turns off (standby mode).
 - **Energy Saving**
If the Camera doesn't detect the person for 60 seconds, after the time set with **Time until Picture Off**, the picture disappears. In addition, after the time set with **Time until Standby**, the TV turns off (standby mode).
- 4 Press ▲ or ▼ to select **Time until Picture Off** and press ◀ or ▶ to select **10min, Test (5sec.)...60min.** (5min.intervals).

NOTE: If the **Camera Sensor Mode** is in **Energy Saving** mode, this feature will be grayed out.

- 5 Press ▲ or ▼ to select **Time until Standby** and press ◀ or ▶ to select **5min...60min.** (5min.intervals).
- 6 Press ▲ or ▼ to select **Test Sensor** and press **OK** to display **Test Sensor** screen.

The Camera will detect Face or Motion.
The detected icon will be highlighted.

- 7 If the Camera doesn't detect the person easily, press ◀ or ▶ to select the **Gamma Adjustment** options **Auto, 1, 2, 3, 4** or **5** watching the camera image on screen until the camera detect the person.

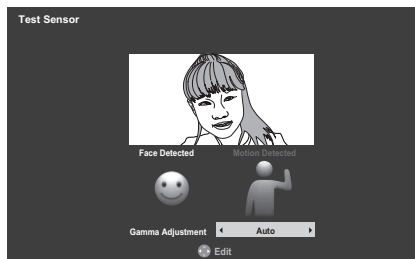

Using Toshiba Places

A new cloud based service, where content (movies, photos, etc.) can be viewed and shared across the web through a simple user interface called "Toshiba Places".

NOTE: You need to configure a home network before using this feature (see page 14).

- 1** Press  on the remote control, or press **MENU / ▲ / ◀▶** to highlight **Connected TV / Toshiba Places** icons and press **OK**.
- 2** Press **▲▼◀▶** to select the desired place and press **OK**.

NOTE:

- Some features require an always-on broadband internet connection, firmware update and/or additional bandwidth dedicated to this product. Third party internet services may change or be discontinued or restricted at any time. Toshiba makes no warranties, representations, or assurances about the content, availability or functionality of third-party content or services. Use of third party internet services may require registration by a computer and/or payment of charges and membership. Not all services or content may be available on this product, in your country or with your language. In order to experience the full capabilities of this product, fully compatible devices may be required. For more information, visit <http://www.toshibaplaces.com/about>.
- This service may be forcibly blocked according to the situation of CSP service.

Using YouTube™

YouTube is a video-sharing service managed by YouTube, LLC. This TV allows you to view YouTube content.

NOTE:

- You need to configure a home network before using this feature (see page 14).
- If **Network Lock** is set to **On**, it will be necessary to enter your four-digit PIN code in order to access network features (see page 76).

- 1** Press **MENU / ▲ / ◀▶** to highlight **Connected TV / YouTube** icons and press **OK**.

The YouTube top page will appear.

- 2** Press **▲▼◀▶** to select the file you want to view, and press **OK**.

To close YouTube:

- 1** Press **EXIT**.

NOTE:

- This TV may not be able to perform all of the same operations as a computer.
- Depending on the network environment and use case, you may experience difficulty viewing content.
- Though the same volume value, actual volume might be greatly different depending on contents.
- It may take time for the TV to load and begin playing back content.
- Service content and the look and feel of the interface may be changed at any time without prior notice.

Using the Function Menu

The Function Menu provides easy access to functions that are commonly used.

- 1 Press the **BLUE** button while displaying YouTube. The Function menu window will appear.





- 2 Press ◀ or ▶ to select the desired icon and press **OK**.



Item	Description
Back	Returns to the previous page.
Forward	Moves to the forward page.
Reload/ Abort	Updates the displayed page. Aborts update (X is displayed while reading, and ↻ is displayed in other case.)
Home	Returns to the top page of YouTube.
Pointer	Switches the pointer On/Off or drag mode.
Menu	Switches the frame or sets various settings.

Switching the pointer

The tool that operates the screen can be changed to pointer or drag mode.



- 1 From the Function menu, press ◀ or ▶ to select **Pointer**, and then press **OK**.
- 2 If you select , see "To use the Pointer: ON:" on this page. If you select , see "To use the Drag Mode:" on this page.

To use the Pointer: ON:

- 1 Press ▲ or ▼ to select **Pointer: ON** and press **OK**.
 -  will appear.
- 2 Press ▲▼◀▶ to the place where  changes to , and then press **OK**.

NOTE: When **Pointer: OFF** is selected and ▲▼◀▶ is pressed, the highlight moves to linked areas.

To use the Drag Mode:

- 1 Press ▲ or ▼ to select **Pointer: ON** and press **OK**.
- 2 Press the **BLUE** button.
- 3 From the Function menu, press ◀ or ▶ to select **Pointer**, and then press **OK**.
- 4 Press ▲ or ▼ to select **Drag Mode** and press **OK**.
 -  will appear.
- 5 Press **OK**, and then  changes to .
- 6 Press ▲▼◀▶ to move the selected item in the desired place.

Switching the frame

- 1 From the Function menu, press ◀ or ▶ to select **Menu**, and then press **OK**.
- 2 Press ◀ or ▶ to select **Page Tasks**.
- 3 Highlight **Switch Frames** and press **OK**.

Setting the view feature

- 1 From the Function menu, press ◀ or ▶ to select **Menu**, and then press **OK**.
- 2 Press ◀ or ▶ to select **View**.
- 3 Press ▲ or ▼ to select the desired item, and press **OK**.
- 4 Press ▲ or ▼ to select the desired setting, and press **OK**.

Item	Settings
Display Mode	Normal: Displays YouTube page with the size as it is. Just-Fit Rendering: Displays YouTube page at a size that has been adjusted to precisely fit the width of your TV.
Text Size	Changes the font size of the screen. Select from Largest, Large, Medium, Small or Smallest . NOTE: This font size is effective only for the page.
Advanced Settings	See the next column.
Page Information	Displays the information of the page you are viewing.
Server Certificates	Displays the server certification.

If you select Advanced Settings:

- 1 Press ▲▼◀▶ to select the setting items, and press **OK**. A check will appear in the box. To remove the check, press **OK** again.
- 2 Press ▲▼◀▶ to select OK field and press **OK**.

Item	Description
Image	Sets display/non-display of images.
Table	Sets effect/non-effect of tables.
CSS	Sets effect/non-effect of CSS.
Pop-up window	Sets effect/non-effect of pop-up windows.
Animation	Sets display/non-display of animations.
JavaScript	Sets effect/non-effect of JavaScript.
Word wrap	Sets effect/non-effect of Word Wrap. If Word Wrap is enabled, a word not finished at the end of a line is shifted to the next line.
Rapid-Render	Sets effect/non-effect of Rapid-Render. If Rapid-Render is enabled, texts and links are displayed first, and the images and the tables, etc. are displayed afterward. The highlight can be moved with the text and the link displayed.

Setting other features

- 1 From the Function menu, press ◀ or ▶ to select **Menu**, and then press **OK**.
- 2 Press ◀ or ▶ to select **Settings**.
- 3 Press ▲ or ▼ to select the desired item, and press **OK**.
- 4 Press ▲ or ▼ to select the desired setting, and press **OK**.

Item	Settings
Security	When jumping from a protected page to an unprotected page, the message is displayed when the check is applied to Notify of secure/non-secure page changes . Apply the check to select SSL version from SSL Version to use (SSL2.0, SSL3.0, TLS1.0) . A content confirmation of the certification and a setting effect/non-effect can be done in Root Certificates and CA Certificates shown below.
Cookies	Accept all: Cookie is received, and it records in this TV. Reject all: Cookie is not received. Prompt before accepting: When Cookie is received, a message window will be displayed.
Delete Cookies	Deletes all recorded Cookies.
Cache	Use cache: When the check is applied to this, cache is used. Delete All Cache Data: Deletes all the cache data preserved in the television.
Browser Information	Displays the information on a browser.

NOTE:

- Cookie is the technical information that a website leaves in this TV so that the website will recognize you when you use it again.
- Cache is a system used to shorten the display time by checking the past data preserved in this television when a page that you viewed before is seen again.

To confirm Root Certificates or CA Certificates:

- 1 Press ▲ or ▼ to select **Security** in step 3 in **Setting other features**.
- 2 Press ▲▼◀▶ to select **Root Certificates** or **CA Certificates**, and press **OK**.
- 3 Press ▲ or ▼ to select the desired certificate.
 - When **OK** is pressed, a detailed information window will appear.
 - When the **BLUE** button is pressed, **Disable** or **Enable** bar will appear. It changes whenever **BLUE** button is pressed.
- 4 Press **BACK**.

Using Hybrid TV Standard (if available)

Hybrid TV Standard enables the TV to receive HbbTV services. TV services which support this feature often show “press RED” on the screen.

NOTE: You need to configure a home network before using this feature (see page 14).

- 1** Press **MENU** / ◀▶ / ▲ / ◀▶ to highlight **Setup / Preferences** icons and press **OK**.
- 2** Press ▼ to select **Hybrid TV Standard**.
- 3** Press ◀▶ to change from **Disabled** to **Enabled**. When changing from **Disabled** to **Enabled**, a **Network Connection Test** is performed. If the result is OK, then the setting changes to **Enabled**. If not, the setting remains **Disabled**.

When “press RED” is indicated on the screen, press the **RED** button to access HbbTV service site, and then press ▲▼◀▶ to select the desired contents.

NOTE:

- This service is not available outside Germany.
- The HbbTV service indication or required key operations may not be possible depending on the service contents. In this case, set the **Hybrid TV Standard** setting to **Disabled**.
- Toshiba makes no warranties, representations, or assurances about the content.

Using the Media Player

This TV allows you to enjoy movie, music and photo files stored on a USB device connected to the USB port.

Moreover, you can also play photos, movies or music files from your PC by connecting the TV to your home network.

Terminology:

DMP: DLNA CERTIFIED™ Player

DMS: DLNA CERTIFIED™ Server

DMR: DLNA CERTIFIED™ Renderer

DMC: DLNA CERTIFIED™ Controller

- DMP: The TV can control and play content from a DMS.
 - A DMS is a device that can function as a server for DMP or DMR.
- DMR: The TV can play content from a DMS. Playback is controlled by a DMC.
 - A DMC is a device that can instruct the TV to display content.

NOTE:

- Do not insert/remove USB device while in use.
- MENU is not available during playback.
- When you want to use your TV as a DMR, set Media Renderer to On (see “Media Renderer” on page 48).

Media Player Specifications

Device

USB device

Interface version: USB2.0 HS

USB Mass Storage Class devices (MSC)

NOTE:

- Connectivity is not guaranteed for all devices.
- A USB hub can not be used.

File system: FAT16 and FAT32

Maximum memory size: Unlimited

DLNA CERTIFIED™ Server: Your PC (for example)

You must obtain any required permission from copyright owners to download or use copyrighted content. TOSHIBA cannot and does not grant such permission.

Basic operation

Using Media Player with USB

When Auto Start is enabled, you will be asked if you want to start the Media Player whenever a USB device is inserted. If Auto Start is disabled (or if you want to connect to a DMS on the network), you must manually start the Media Player from the menu.

To change the Auto Start setting:

- 1 Press **MENU** / ◀▶ / ▲ / ▼ to highlight **Media Player** / **Media Player Setup** icons and press **OK**.
- 2 Press ▲ or ▼ to select **USB Auto Start**, and then press ◀ or ▶ to select **On** or **Off**.

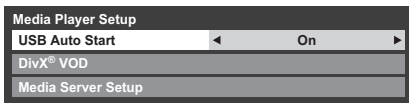

Auto Start:

- 1 Insert USB device into the USB socket on the left side of the TV. A prompt will appear.
- 2 Press ◀ or ▶ to select **Yes**, and then press **OK**.
- 3 Press ▲ or ▼ to select **Photo**, **Movie**, or **Music** and press **OK**.

NOTE: If **Auto Start** is set to **Off**, you can start the Media Player manually.

Manual Start:

- 1 Insert USB device into the USB socket on the left side of the TV.
- 2 Press **MENU** / ◀▶ to highlight **Media Player** icon.
- 3 Press ▲ / ◀▶ to highlight **Photo**, **Movie** or **Music** icon and press **OK**. The contents list will appear.

To select a file in the list of contents:

- 1 Press ▲▼ (◀▶) to select a file or folder.
- 2 Press **OK** to move to the next layer, or press **BACK** to return to the previous layer.

To close the Media Player:

- 1 Press **EXIT**.

Using the Media Player with a DLNA CERTIFIED™ Server

You need to configure a home network before using this feature (see page 14).

- 1 Press **MENU** / ◀▶ to highlight **Media Player** icon.
- 2 Press ▲ / ◀▶ to highlight **Photo**, **Movie**, or **Music** icon and press **OK**. The thumbnail (for Photo) or list of files (for Movie and Music) will appear.

NOTE: If there is more than one media server on the network, a list of all media servers will be displayed. Highlight the server you want to use, and press **OK**.

- 3 Press ▲ or ▼ to select a DMS if the selection window is displayed.

To select a file in the list of contents:

- 1 Press ▲ or ▼ to select a file or folder.
- 2 Press **OK** to move to the next layer, or press **BACK** to return to the previous layer.

To close the Media Player:

- 1 Press **EXIT**.

To display the device information:

- 1 Press **QUICK** to open the **Quick Menu** in list mode or Multi View mode.
- 2 Press **▲** or **▼** to select **Device Information**.

Setting DLNA CERTIFIED™ Server waking up:

You only need to complete the Media Server Setup if you wish to use the "Wake-on-LAN" feature.

- 1 Press **MENU** / **◀▶** / **▲** / **◀▶** to highlight **Media Player** / **Media Player Setup** icons and press **OK**.
- 2 Press **▲** or **▼** to select **Media Server Setup** and press **OK**. A list of currently available DMSs will appear.
- 3 Press **▲** or **▼** to select the desired device, and press **OK**. A check will appear in the box. To remove the check, press **OK** again.
- 4 Press **▶** to highlight **Done**, and then press **OK** to save.

NOTE:

- Up to 8 DMSs can be selected.
- Even if the device checked is powered off, it will be displayed but grayed out in the **Select Device** window. When **OK** is pressed on a highlighted grayed out item, a confirmation of Wake-on-LAN is displayed. The TV tries to wake up the DMS if **Yes** is pressed. The Server will start if it supports Wake-on-LAN feature.
- When some DMSs are connected, it may take time until the list is displayed. The list may be refreshed by the following operation.
 - The device selection window is closed once and it is displayed again.
 - The **RED** button is pressed.

USB 2 Port Setup (if available)

- 1 Press **MENU** / **◀▶** to highlight **Setup** icon.
- 2 Press **▲** / **◀▶** to highlight **System Setup** icon and press **OK**.
- 3 Press **▲** or **▼** to select **USB 2 Port Setup**.
- 4 Press **◀▶** to select **Recorder** or **Media Player**.

Viewing photo files (on a DLNA CERTIFIED™ Server or USB device)

There are three types of viewing modes.

Multi View

This view allows you to search for photos in a grid format. The pictures are displayed using thumbnail data in each image file.

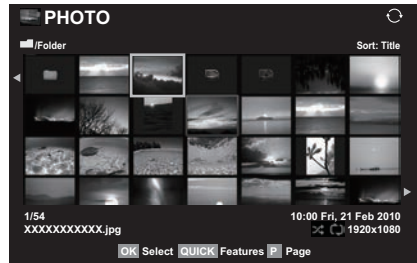
Photo list example

The initial highlighted position will be on the top left thumbnail in the Multi View.

- 1 Press **▲▼◀▶** to move the highlight in one window. If all of the photos will not fit in one screen, when pressing **◀** at the top left thumbnail, the screen will move to the previous page. Conversely, when pressing **▶** at the bottom right thumbnail, the screen will move to the next page.

P▲P▼ buttons can be used to page up/down the photo list when there are more photos than will fit onto one screen. When the **P▲P▼** buttons are pressed, the highlight shall be on the photo at the top left of Previous/Next list.
- 2 When you select a folder, press **OK** to move to the next layer. Press **BACK** to move back to the previous layer.
- 3 Press **OK** to view the selected photo in Single View mode.

NOTE: When the TV is used as a DMR, this feature is not available.

Single View

In this mode, only files located in the selected directory will be displayed. This view allows you to change the photo content manually. When moving from Multi View to Single View, the currently selected photo will be displayed.

- 1 Press **▶** to view the next photo. Press **◀** to view the previous photo.
- 2 Press **▲** to rotate the image 90° clockwise. Press **▼** to rotate the image 90° counterclockwise.
- 3 Press **i+** to display file status information (file number, photo title, date and time taken, resolution etc.).

NOTE: The information may not be correctly displayed depending on the content, DMC or DMS.

Slide Show

This view allows you to watch a slide show of your photos. In this mode, only files located in the selected directory will be played.

- 1 To start slideshow, press **OK** in the Single View mode.
- 2 Press **◀** or **▶** to view the previous/next photo.
- 3 Press **▲** or **▼** to rotate the photo.
- 4 Press **i+** to display file status information.

To set Interval Time and Repeat settings:

- 1 Press **QUICK** to open the **Quick Menu** while in the Single View mode or Slide Show mode.
- 2 Press **▲** or **▼** to select either **Interval Time** or **Repeat**.
- 3 Press **◀** or **▶** to adjust the setting and press **OK**.

To set Background Music

- 1 Press **QUICK** to open the **Quick Menu** while in the Slide Show mode.
- 2 Press **▼** to select **Select Music** and press **OK**.
- 3 Press **▲** or **▼** to select **Background Music** and press **OK**.
- 4 Press **▲** or **▼** to select **Background Music** and press **◀** or **▶** to select **On**.
- 5 Select a music file.

NOTE:

- The music must be selected from the same media (USB) device or DMS from which the picture files will be played.
- This feature is not available when there is no music that can be selected.

To zoom in/out photos

During the Single View mode or Slide Show mode, the zoom function can be used.

RED button: x1 → x2 → x4 → x8 → x16 zoom

GREEN button: x16 → x8 → x4 → x2 → x1 zoom

BACK button: Normal playback

▲ ▼ ◀ ▶ buttons: Vertical or Horizontal scrolling

To set the shuffle mode (USB only):

- 1 Press **QUICK** to open the **Quick Menu** in list mode.
- 2 Press **▲** or **▼** to select **Shuffle**.
- 3 Press **◀** or **▶** to select **On** or **Off**.

To sort the folders and files

- 1 Press **QUICK** to open the **Quick Menu** from Multi View mode.
- 2 Press **▲** or **▼** to select **Sort**.
- 3 Press **◀** or **▶** to select **Title/File Name**, **New** or **Old** to set the sorting rule.

Item	Description
Title (DMS)	File sorting rules: 1. Unicode priority 2. (0, 1, ..., 9), capital alphabet (A, B, ..., Z), small alphabet (a, b, ..., z) 3. Increasing order
File Name (USB)	File sorting rules: 1. Unicode priority 2. (0, 1, ..., 9), capital alphabet (A, B, ..., Z), small alphabet (a, b, ..., z) 3. Increasing order
New	From new to old according to the date and time when the picture was taken.
Old	From old to new according to the date and time when the picture was taken.

NOTE: Sorting may not be supported by some DMSs.

To display the device information

- 1 Press **QUICK** to open the **Quick Menu** from Multi View mode.
- 2 Press **▲** or **▼** to select **Device Information** and press **OK**.

NOTE: When the photos on the USB device are used, or the TV is used as a DMR, this feature is not available.

To close the Photo Viewer

- 1 Press **EXIT**. The television will return to the last viewed channel or external input.

File Compatibility

See page 99.

Viewing movie files (on a DLNA CERTIFIED™ Server or USB device)

You can select movies from a list of available files.

Movie list example



- 1 Press **▲ ▼** to select a file or folder. **P▲ P▼** buttons can be used to page up/down the movie list when there are more files than will fit onto one screen.
- 2 When you select a folder, press **OK** to move to the next layer. Press **BACK** to move back to the previous layer.
- 3 With the desired file selected, press **OK** or **▶** (play) to start playback.

NOTE:

- On preview screen, if you highlight the file without pressing **OK**, the content is played on a preview screen. When **OK** is pressed, it is played in full screen mode.
- Depending on the file size, it may take some time to start playback.

- 4 Press **■** to stop playback.

NOTE:

- If playback finishes before **■** is pressed, the screen will return to the list.
- Depending on the file size, it may take some time for playback to begin.

During playback:

- Press **|||▶** to pause.
You can move to the desired replay position by pressing **◀** or **▶** during PAUSE.
PAUSE and operations during PAUSE may not be available depending on the contents, DMC or DMS.
- To resume normal playback, press **▶** (play).
- To play in fast reverse or fast forward directions, press **◀◀** or **▶▶** during playback. Each time you press the **◀◀** or **▶▶**, the playback speed will change.
PAUSE and operations during PAUSE may not be available depending on the contents, DMC or DMS.
- To locate a specific file, press **◀◀** or **▶▶** repeatedly.
- Press **[+]** to display the file status information (content number, movie title, progress time etc.).

NOTE:

- The information may not be correctly displayed depending on the contents, DMC or DMS.
- During playback, you can adjust the Picture, Picture Size and Sound menu functions from the **Quick Menu**.

To select subtitle and audio languages

- Press **SUBTITLE** repeatedly to select your preferred subtitle language.
- Press **○/I/II** repeatedly to select your preferred audio language.

NOTE: This feature may not be available depending on the contents.

To set the repeat mode

- 1 Press **QUICK** to open the **Quick Menu**.
- 2 Press **◀** or **▶** to select **Off**, **All** or **1**.

Mode	Description
Off	The file is played back only once.
All	Files in the same folder are repeatedly played back.
1	The same file is repeatedly played back.

- 3 Press **BACK**.

NOTE: When the TV is used as a DMR, this feature is not available.

To sort the folders and files

- 1 Press **QUICK** to open the **Quick Menu** in list mode.
- 2 Press **▲** or **▼** to select **Sort**.
- 3 Press **◀** or **▶** to select **Title/File Name**, **New** or **Old** to set the sorting rule.

Item	Description
Title (DMS)	File sorting rules: 1. Unicode priority 2. (0, 1, ..., 9), capital alphabet (A, B, ..., Z), small alphabet (a, b, ..., z) 3. Increasing order
File Name (USB)	File sorting rules: 1. Unicode priority 2. (0, 1, ..., 9), alphabet (A, B, ..., Z) 3. Increasing order
New	From new to old according to the date and time when the contents were updated.
Old	From old to new according to the date and time when the contents were updated.

NOTE: Sorting may not be supported by some DMSs.

To display the device information

- 1 Press **QUICK** to open the **Quick Menu** in list mode.
- 2 Press **▲** or **▼** to select **Device Information** and press **OK**.

NOTE: When movies on USB device are used, or the TV is used as a DMR, this feature is not available.

To close the Movie Viewer

- 1 Press **EXIT**.

File Compatibility

See page 99.

To register your TV to a DivX® account

This TV allows you to play back files purchased or rented from DivX® Video-On Demand (VOD) services. When you purchase or rent DivX® VOD files on the internet, you will be asked to enter a registration code.

- 1 In the **Media Player Setup** menu, press **▲** or **▼** to select **DivX® VOD** and press **OK**.
- 2 Press **▲** or **▼** to select **DivX® VOD Registration** and press **OK**.



- 3 The **DivX® VOD** window will appear and you will see the registration code. For details on registration, please visit the DivX® website at

<http://vod.divx.com>

- 4 Copy the activation file to a memory device and play it on the TV.

To deactivate your device

- 1 In step 2 above, highlight **DivX® VOD Deactivation**, and then press **OK**.
- 2 A confirmation message will appear. Select **Yes** and press **OK**.
- 3 The **DivX® VOD** window will appear and you will see the deactivation code. For details on registration, please visit the DivX® website at

<http://vod.divx.com>

ABOUT DIVX VIDEO: DivX® is a digital video format created by DivX, Inc. This is an official DivX Certified® device that plays DivX video. Visit divx.com for more information and software tools to convert your files into DivX video.

ABOUT DIVX VIDEO-ON-DEMAND: This DivX Certified® device must be registered in order to play purchased DivX Video-on-Demand (VOD) movies. To obtain your registration code, locate the DivX VOD section in your device setup menu. Go to vod.divx.com for more information on how to complete your registration.

DivX Certified® to play DivX® and DivX Plus™ HD (H.264/MKV) video up to 1080p HD including premium content.

To playback DivX Plus HD content:

- To play in fast reverse or fast forward directions, press ◀◀ or ▶▶ during playback. Each time you press the ◀◀ or ▶▶, the playback speed will change.
- This TV generates original chapter point in 10% increments for 10 chapters in total, that are accessible by using the **Number** buttons on the remote control.

During playback, press ▶▶ to skip to the beginning of the next chapter. When ▶▶ is pressed twice in succession, it will repeat two times of above. If ▶▶ is pressed at the last chapter, playback will skip to the beginning of the next content.

Press ◀◀ to skip to the beginning of the current chapter. When ◀◀ is pressed twice in succession, it will skip to the beginning of the previous chapter. If ◀◀ is pressed twice in succession at the first chapter, stop playing the current content and skip to the beginning of the previous content.

The Number button is used for direct jump. If the 3 button is pressed, playback will jump to the beginning of 3rd chapter. Even if the playback content have authored chapters, the Number button is used to jump directly to Auto Generated Chapter.

If the content has Authored Chapters, ◀◀ / ▶▶ are using for Authored Chapters.

NOTE: Depending on the content data will not be operated.

Using Multi Title and Alternative Timelines Multi Title

DivX Plus HD files may contain up to 100 titles.

You can change the title (It contains same video file) by pressing the **RED** button.

When the **RED** button is pressed, it will display the title change window at the bottom on the screen (same as Subtitle or Audio change window).

The title is changed cyclically each time the **RED** button is pressed. Playback will start from start time of selected title each time you press ▲ or ▼.

NOTE: Depending on the content data will not be operated.

Playing music files (on a DLNA CERTIFIED™ Server or USB device)

You can listen to music from a list of available files.

Music list example

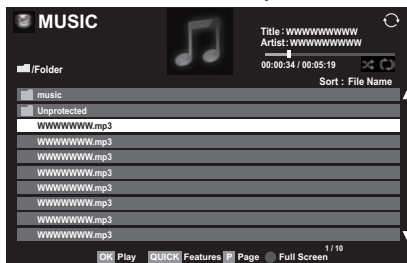

- Press ▲ ▼ to select a file or folder. P▲ P▼ buttons can be used to page up/down the music list when there are more files than will fit onto one screen.
- When you select a folder, press **OK** to move to the next layer. Press **BACK** to move back to the previous layer.
- With the desired file selected, press **OK** or ▶ (play) to start playback.

NOTE: **OK** takes to you full screen playback. Playback in preview start without pressing **OK**. Moving cursor up/down plays music.
- Press ■ to stop playback.

NOTE:

- Depending on the file size, it may take some time for playback to begin.
- During playback, you can adjust the **Sound** menu functions from the **Quick Menu**.

During playback in full screen:

- Press |||▶ to pause.
- To resume normal playback, press ▶ (play).
- You can move to the desired replay position by pressing ◀ or ▶ during PAUSE.

PAUSE and operations during PAUSE may not be available depending on the contents, DMC or DMS.
- To play in fast reverse or fast forward directions, press ◀◀ or ▶▶. Each time you press ◀◀ or ▶▶, the playback speed will change.

PAUSE and operations during PAUSE may not be available depending on the contents, DMC or DMS.

To set the repeat mode:

- 1** Press **QUICK** to open the **Quick Menu** in list mode.
- 2** Press **▲** or **▼** to select **Repeat**.
- 3** Press **◀** or **▶** to select **Off**, **All** or **1**.

Mode	Description
Off	Files in the same folder are played back once.
All	Files in the same folder are repeatedly played back.
1	The same file is repeatedly played back.

- 4** Press **BACK**.

NOTE: When the TV is used as a DMR, this feature is not available.

To set the shuffle mode (USB only):

- 1** Press **QUICK** to open the **Quick Menu** in list mode.
- 2** Press **▲** or **▼** to select **Shuffle**.
- 3** Press **◀** or **▶** to select **On** or **Off**.

To sort the folders and files

- 1** Press **QUICK** to open the **Quick Menu** in list mode.
- 2** Press **▲** or **▼** to select **Sort**.
- 3** Press **◀** or **▶** to select **Title/File Name**, **New** or **Old** to set the sorting rule.

Item	Description
Title (DMS)	File sorting rules: 1. Unicode priority 2. (0, 1, ..., 9), alphabet (A, B, ..., Z) 3. Increasing order
File Name (USB)	File sorting rules: 1. Unicode priority 2. (0, 1, ..., 9), alphabet (A, B, ..., Z) 3. Increasing order
New	From new to old according to the date and time when the contents were updated.
Old	From old to new according to the date and time when the contents were updated.

NOTE: Sorting may not be supported by some DMSs.

To display the device information

- 1** Press **QUICK** to open the **Quick Menu** in list mode.
- 2** Press **▲** or **▼** to select **Device Information** and press **OK**.

NOTE: When music files on USB device are used, or the TV is used as a DMR, this feature is not available.

To display the file status information

- 1** Press **i+** during playback. The information will be displayed on the bottom of the screen.
- 2** Press **i+** again to remove the information.

NOTE: The information may not be correctly displayed depending on the content, DMC or DMS.

To close the Music Player:

- 1** Press **EXIT**.

File Compatibility

See page 99.

Using the Photo Frame feature

You can use the TV screen as a digital photo frame. One image (pre-installed or user-installed) can be displayed. Date info can also be superimposed, if desired.

You can overwrite the photo file with a file from a USB storage device or DLNA CERTIFIED™ Server.

To open Photo Frame

- 1 Press **MENU** / ◀▶ / ▲ / ▶ to highlight **Setup** / **Preferences** icons and press **OK**.
- 2 Press ▲ or ▼ to select **Photo Frame Setup** and press **OK**.

Display Example

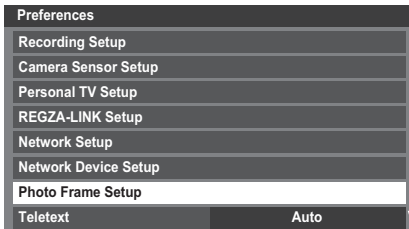

The preview screen will appear.

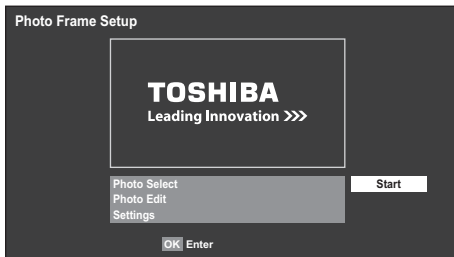

- 3 Press ▶ to select **Start** and press **OK** to open **Photo Frame**.



To open from the Quick Menu

- 1 Press **QUICK** to open the **Quick Menu**.
- 2 Press ▲ or ▼ to select **Photo Frame** and press **OK** to open **Photo Frame**.

To close Photo Frame:

- 1 Press **EXIT**.

Setting the features

In the preview screen, you can set various settings for Photo Frame.

Photo Select

- 1 In the **Photo Frame Setup** menu, press ▲ or ▼ to select **Photo Select** and press **OK**.

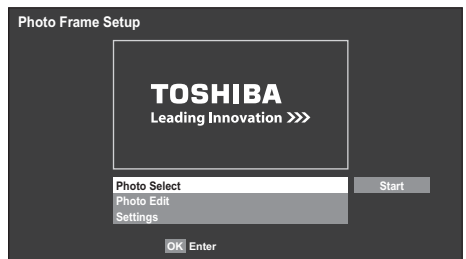

- 2 If the device selection screen appears, press ▲ or ▼ to select the appropriate device and press **OK**.

- 3 Press ▲▼◀▶ to select the photo you want to copy from the USB storage device or DLNA CERTIFIED™ server to the TV's flash memory, and then press **OK**.

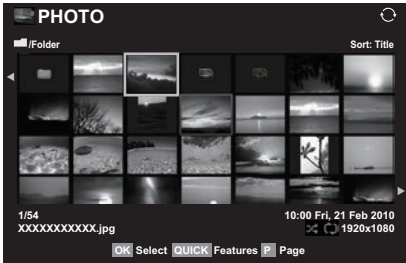
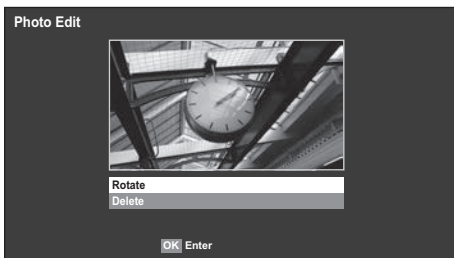

Photo Edit

- 1 Press ▲ or ▼ to select **Photo Edit** and press **OK**.
- 2 Press ▲ or ▼ to select **Rotate** or **Delete**.



- 3 Set the following items as required.
- **Rotate** — Press **OK** to rotate the image 90° clockwise.
 - **Delete** — Press **OK**. A confirmation window will appear. Press ◀ or ▶ to select **Yes**, and then press **OK**.
- 4 Press **BACK**.

Settings

- 1 Press ▲ or ▼ to select **Settings** and press **OK**.
- 2 Press ▲ or ▼ to select **Clock**, **Position** or **Auto Power Off**.

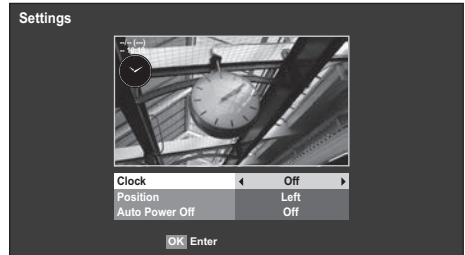

- 3 Set the following items as required.
- **Clock** — Press ◀ or ▶ to select **Off**, **Digital Clock**, **Analogue Clock** or **Analogue + Digital**.
 - **Position** — Press ◀ or ▶ to select **Left** or **Right**.
 - **Auto Power Off** — Press ◀ or ▶ to select **Off**, **00:30**, **01:00**, **02:00**, **04:00**, **06:00** or **12:00**.
If the Photo Frame window is left open, the TV will automatically turn off after the set length of time (maximum 12 hours).
- 4 Press **BACK**.
- 5 Select **Start** and press **OK**.



NOTE:

- The clock display will only appear when time from a digital broadcast is available.
- The photo and clock displays are moved by 4 dots every 5 minutes to minimize the risk of screen burn-in.
- The pre-installed photo file is stored in the TV's flash memory before shipment.
- Picture Size selection (Normal/ Dot by Dot) is available by pressing the **QUICK** button. However when the resolution is 1920 x 1080 or above, the Picture Size selection menu will be grayed out.

Other features

Panel Lock

Panel Lock disables the buttons on the television. All buttons on the remote control can still be used.

- 1 Press **MENU** / ◀▶ / ▲ / ▶ to highlight **Setup** / **Preferences** icons and press **OK**.

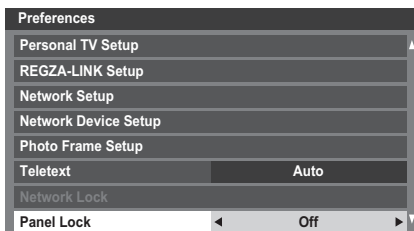

When **Panel Lock** is **On**, a reminder will appear when the buttons on the television are pressed. **If the standby button is pressed, the television will switch off and can only be brought out of standby by using the remote control.**

The timers

Programme Timers – digital only

This feature will set the television to go to a specific channel at a certain time. It can be used to view a particular programme, or by setting the mode to daily or weekly, can be used to view a series of programmes.

- 1 Press **MENU** / ◀▶ / ▲ / ▶ to highlight **TV Programmes** / **Programme Timers** icons and press **OK**.
- 2 Press ▼ to select **Programme Timers** and press **OK**.
- 3 Press ▼ if necessary to select an open timer position, then press **OK**. The **Set Timer** menu will now appear on screen.
- 4 Press ▲ and ▼ to go through the list adding the details of the programme by using the number buttons and ◀ and ▶ to make selections.

Menu Example (UL series)

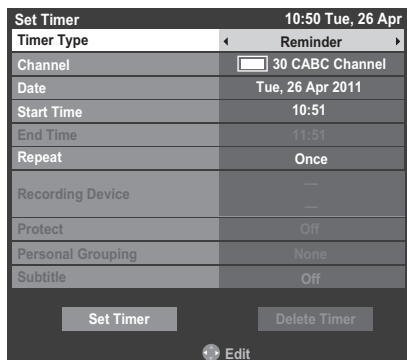

- 5 When all of the details have been entered, highlight **Set Timer** and press **OK** to save the timer.

The **ORANGE/RED** programme timer indicator on the front of the television will be lit (see page 94 for details).

PLEASE NOTE: When a timed programme is about to start, an information screen will appear offering the option of watching or cancelling the programme. The menus and other channels will not be available during the timed programme unless the programme timer is cancelled. It will only be possible to create or edit programme timers for the currently tuned DTV input.

On Timer

The feature allows you to set the television to turn on automatically to a preset channel at a certain time of day or after a certain length of time.

- 1 Press **MENU** / ◀▶ / ▲ / ▶ to highlight **Function / On Timer** icons and press **OK**.
- 2 Press ▲ or ▼ to select **Enable On Timer** and press ◀ or ▶ to select **On**.

On Timer	
Enable On Timer	◀ On ▶
Enable DTV Clock	On
Power On Time	00:00
Repeat	Once
Input	DTV
Channel	12 ABC
Volume	20
Time Until Power On	00:00
Done	

- 3 Press ▼ to select **Enable DTV Clock**, and then press ◀ or ▶ to select **On** or **Off**.
- 4 Press ▲ or ▼ to go through the list adding the details of the On Timer by using the number buttons and ◀ and ▶ to make selections.

Power On Time (only for DTV Clock On mode): Set the time you prefer with the number buttons.

Repeat (only for DTV Clock On mode): Select the desired On Timer operation (**Once, Every Day, Mon-Fri, Mon-Sat, Sat-Sun**).

Input: Select a video input source (ATV, DTV, EXT 1, EXT 2, EXT 3, HDMI 1, HDMI 2, HDMI 3, HDMI 4 or PC).

Channel: Set the channel that will be tuned when the television turns on.

NOTE: When an external input is selected in the **Input** field, a channel cannot be selected.

Volume: Set the volume that will be applied when the television turns on.

Time until Power On (only for DTV Clock Off mode): Set the amount of time from now until the TV turns on using the number buttons (maximum of 12 hours).

- 5 Press ▲ or ▼ to highlight **Done** and press **OK**.

To cancel the On Timer

- 1 In the **On Timer** menu, select **Enable On Timer**
- 2 Press ◀ or ▶ to select **Off**.

Sleep Timer

The television can be set to turn itself **Off** after a certain length of time.

- 1 Press **MENU** / ◀▶ / ▲ / ▶ to highlight **Function / Sleep Timer** icons and press **OK**.
- 2 Use the number buttons to set the desired time. For example, to switch the television off in one and a half hours enter 01:30, or press ▶ / ◀ to increase/decrease in steps of 10 minutes. (Maximum time setting is 12 hours)
- 3 Press **EXIT** to finish.
- 4 To cancel the **Sleep Timer**, enter all zeros for the above setting.

Energy Saving Settings

Automatic Power Down

The TV will automatically turn itself off (standby) after 4 hours, if you do not operate the TV either from the remote control or the TV control panel.

- 1 Press **MENU** / ◀▶ / ▲ / ▶ to highlight **Setup / Preferences** icons and press **OK**.
- 2 Press ▲ or ▼ to select **Energy Saving Settings** and press **OK**.
- 3 Press ▲ or ▼ to select **Automatic Power Down**.
- 4 Press ◀ or ▶ to select **On** or **Off**, and press **OK**.

NOTE:

- This feature is set to **On** when **Location** is set to **Home**.
- 1 minute before switching to standby, a Warning message will appear.
- When the following features are set, the feature that is set for the nearest time will function.
 - Automatic Power Down
 - Sleep Timer
 - Photo Frame/Auto Power Off
 - Auto shutdown after 1 hour of inactivity (after power on by On Timer)
 - No signal auto power off (after 15 minute of no signal)

No Signal Power Down

The TV will automatically turn itself off after 15 minutes when no signal is detected. You can change the setting to Off for the following purposes:

- Low signal strength of analog channel (no signal detection)
- Only Audio L/R is connected to external input to listen to music through the TV speakers.

- 1 In the **Energy Saving Settings** menu, press ▲ or ▼ to select **No Signal Power Down** and press **OK**.
- 2 Press ▲ or ▼ to select the item you want to change and press ◀ or ▶ to select **On** or **Off**.

NOTE:

- Default setting is all On.
- A warning message will appear 1 minute before turning off.

Digital on-screen information and Programme Guide

When viewing in **digital** mode, the on-screen information and programme guide provide access to programme details for all available channels.

Information

- 1 Press **i+**, the information screen will appear giving details of the channel and programme currently being viewed.

Display Example (UL series)

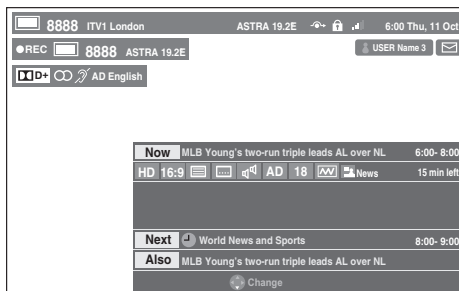

- 2 Press ▲ or ▼ to select the **"Now"**, **"Next"** or **"Also"** information guide.
- 3 To record the next scheduled programme, select **"Next"** and press **OK**. The **Set Timer** screen will appear.

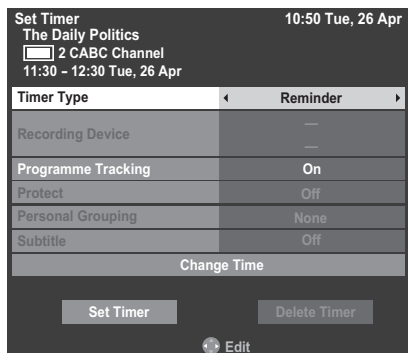

- 4 The details of the programme will already have been added to the timer. Highlight **Set Timer** and press **OK** to save.

To indicate that a Recording Timer has been set, a clock icon will be displayed in the **Next** and **Also** fields of the information screen. A check mark will appear if the timer is a Reminder Timer.

- 5** Press **▼** to select **Also**. Details of programmes that have started on other channels will be provided. Use **◀** or **▶** to change the display contents.

To display More Information

- 1** Press **QUICK** to open the **Quick Menu**.
- 2** Press **▼** to highlight **More Information** and press **OK**.

On-screen Information icons

	Icon	Description
Service info		Service type (TV, Radio, Text)
		Skip
Audio info		Mono
		Stereo
		Dual mono
		Multichannel
		Dolby Digital
		Dolby Digital+
		Audio Coding
		Audio Description
Audio/Subtitle info		For Hard of Hearing
Recording info		Recording + Service info
Personal Mode info		Personal Mode (Personal Name)
Event info		Video format (HD, SD)
		Video Aspect
		Teletext
		Subtitle (Single, Multi)
		Multi-audio track
		Parental rating
		Encrypted
Timer info		Recording
		Reminder

Guide

- 1** Select the on-screen guide by pressing **GUIDE**, and the Guide screen will appear highlighting details of the channel and programme currently being viewed. This may take a few moments to appear.

Thu6	10:50 Tue, 6 Apr				
TV	18:00	18:30	19:00	19:30	20:00
6 M6	LES SIMPSON	LES SIMPSON	TOP MODEL		
9 W9	SUMMERLAND	SUMMERLAND	LES SIMPSON		
11 NT1	Nicky La...	Street fight...	Dragon B...	Dragon B...	K 2000
31 PARIS PREMIERE	MA SORCIE...	HAPPY DAYS	HAPPY DAYS		
34 AB1	Evamag	21 jump street	Jerry Springer Show	City guys	L...
800 FlowerGd	6Mbs				
801 FlowerGd	4Mbs				
802 FlowerGd	2Mbs				
804	Codec 4:3				
806	ITV1				
807	ITV3				
808	ITV2				
809	ITV4				

You can switch the time scale to 1.25 or 2.5 hours by pressing the **GREEN** button.

NOTE: Channels are displayed in groups by service type (TV, Radio, Text). Pressing the **TV** button will switch the service type.

- 2** Press **◀** or **▶** for information on other programmes scheduled for the channel selected. To highlight the first programme in the genre grid, press the **RED** button.
- 3** For details of other programmes currently available, press **▲** and **▼** to scroll up and down the channel list. As channels are selected, details of the programme currently being broadcast will appear. Press **◀** or **▶** to view information for future programmes.
- 4** For information on a highlighted programme, press **i+**.
- 5** To set the timer for that programme, press the **BLUE** button to bring up the **Programme Timers** menu.
- NOTE:** In order for the recording operation to work properly, the media recorder must be set to the same time as the TV. Regarding the process for recording, please refer to the owner's manual of the recording equipment.
- 6** Press **P▶** to advance to the next page, or press **P▲** to go back to the previous page.

Genre selection/searching

From the Guide screen, you can use the genre selection and search features.

- 1 In the Guide screen, press **QUICK**.
- 2 Press **▲** or **▼** to highlight **Genre Colour** in the **Quick Menu** and press **OK**.

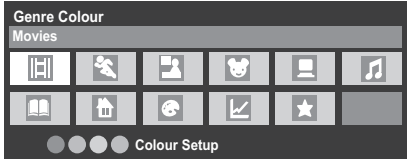

- 3 With the focus on a particular genre, press the desired coloured button to assign. Four colours will be available to set. Press **BACK** to go back to the Guide screen.
- 4 Press the **YELLOW** button to access the **Genre Search** screen.

Genre Search		10:50 Tue, 6 Apr	
Movies			
34 AB1	Hard Rain	Wed,27 Apr	0:15- 1:45
31 PARIS PREMIERE	Red Corner	Wed,27 Apr	22:15- 23:55
11 NT1	The Lawnmower Man	Thu,28 Apr	1:20- 3:00
9 W9	A Vow to Kill	Fri,29 Apr	1:30- 3:00
34 AB1	Parenthood	Sat,30 Apr	0:45- 2:40
11 NT1	Body and Soul	Sat,30 Apr	1:15- 3:00
31 PARIS PREMIERE	The Nun's Story	Sat,30 Apr	15:00- 17:30
9 W9	Red Corner	Sat,30 Apr	23:20- 1:15
11 NT1	The Real Blonde	Sun,1 May	0:40- 2:00
31 PARIS PREMIERE	Critters	Sun,1 May	0:40- 2:20
11 NT1	Indiana Jones and the Temple of Doom	Sun,1 May	21:10- 23:20
11 NT1	The Jackal	Sun,1 May	23:20- 1:15
34 AB	Coup De Ville	Mon,1 May	1:10- 3:00

- 5 Press **◀** or **▶** to select the genre. Programmes listed will change for the new genre. Press **▲** or **▼** to highlight a particular programme.
- 6 When a current programme is selected, pressing **OK** will tune to that programme. When a future programme is selected, pressing **OK** will open the **Set Timer** menu.
- 7 For information on a highlighted programme, press **i+**.
- 8 To exit the **Genre Search** and go back to the Guide screen, press the **YELLOW** button.

Digital settings – parental control

In order to prevent viewing of unsuitable films and programmes, channels and menus can be locked in digital mode. These can then only be accessed with a security code PIN.

Parental PIN Setup

- 1 Press **MENU** / **◀▶** / **▲** / **◀▶** to highlight **Setup** / **System Setup** icons and press **OK**.
- 2 Press **▲** or **▼** to select **DTV Settings** and press **OK**.

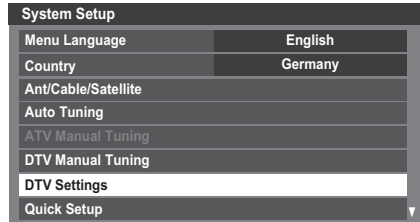

- 3 Press **▲** or **▼** to highlight **Parental PIN Setup** and press **OK**.

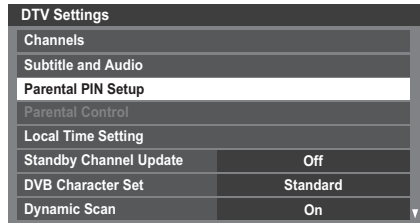

- 4 Using the number buttons enter a four digit number. Once entered you will be prompted to confirm by entering again.

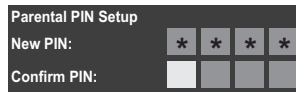

The PIN number is now set.

If the PIN code has been set, when **Auto Tuning** and **Reset TV** are executed, entering the PIN will be necessary. "0000" is not acceptable.

Parental Setup

The **Parental Control** feature allows you to block programmes according to their rating levels. If a PIN has been set, you will need to enter it before adjusting the level.

- 1 In the **DTV Settings** menu, press **▲** or **▼** to select **Parental Control** and press **OK**.
- 2 Press **▲** or **▼** to select **Parental Setup** or **Playback Setup** (if available).
Parental Setup: Select when you want to set viewing restrictions on broadcast programmes.
Playback Setup: Select when you want to set viewing restrictions on playback of programmes recorded to the USB HDD.
- 3 Use **◀** or **▶** to choose an option (**None** or an age setting (4-17 or 4-18 depending on the **Country** setting)).



To view blocked programmes, enter the PIN. To reactivate the Parental Control, turn the TV off and then on again.

Network Lock

You can **use** the **Network Lock** feature to prevent the Web browser from launching. When this feature is set to **On**, PIN input will be necessary to use YouTube.

This feature will be grayed out until a PIN is set.

- 1 Press **MENU** / **◀▶** / **▲** / **▶** to highlight **Setup** / **Preferences** icons and press **OK**.
- 2 Press **▲** or **▼** to select **Network Lock**.

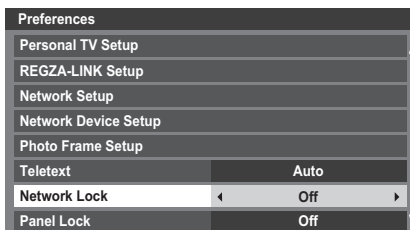

- 3 Press **◀** or **▶** to select **On**.

To unlock the Network:

- 1 Select **Off** in step 3 above.

Digital settings – Channel Options

Selecting favourite channels

Favourite Channels creates a list of the **digital** channels that are watched most. Four lists can be created, they can be a mixture of television, radio and text channels.

- 1 Select a channel you want to add to your favourite list.
- 2 Press **QUICK** to open the **Quick Menu**.
- 3 Press **▼** to select **Channel Options** and press **OK**.
- 4 Press **▶** repeatedly to select the favourite list (Fav.1-4).

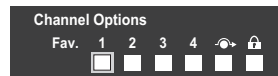

- 5 Press **OK** to select the ones required. A tick will appear in the box as they are selected.
- 6 Repeat steps 1 through 5 for other channels.
- 7 When all favourites have been selected, press **EXIT**.

Favourite Channel Lists

- 1 Press **LIST** to display **Channel List**.
- 2 Press **◀** or **▶** to select Favourites 1-4. The number of favourites available depends on how many lists have been created.

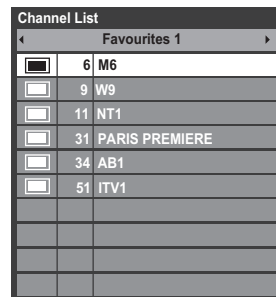

- 3 Press **▲** or **▼** to highlight a channel and press **OK** to watch.

Skip channels

This feature allows you to set channels that will be skipped when **P▼** or **P▲** are used to tune.

- 1 Select the channel you want to skip in your channel list.
- 2 From the **Quick Menu**, press **▼** to select **Channel Options** and press **OK**.
- 3 Press **▶** repeatedly to highlight the skip (**↻**) box.
- 4 Press **OK** to select. A tick will appear in the box.
- 5 Repeat steps 1 through 4 for other channels.
- 6 Press **EXIT**.

NOTE: Skipped channels cannot be selected by **P▼** or **P▲** but still be accessed by direct number entry (when tuned a **↻** icon will be displayed in the banner to indicate as a skipped channel).

Locking channels

Locking Channels stops the viewing of **digital** channels, and they can only be accessed by entering the **PIN**.

- 1 Select the channel you want to lock in your channel list.
- 2 From the **Quick Menu**, press **▼** to select **Channel Options** and press **OK**.
- 3 Press **▶** repeatedly to highlight the lock (**🔒**) box.
- 4 Press **OK** to select. A tick will appear in the box.
If a PIN has already been set, PIN entry will be required to set the locked channels.
- 5 Repeat steps 1 through 4 for other channels.
- 6 Press **EXIT**.
- 7 From this point on, when any of the channels in the **Locked Channel** list are selected, the PIN must be entered before they can be accessed.

Digital settings – other settings

Subtitles

In digital mode, this feature will show subtitles on the screen in the selected language provided they are being broadcast.

- 1 In the **DTV Settings** menu, press **▲** or **▼** to select **Subtitle and Audio** and press **OK**.
- 2 Press **▼** to select **Subtitle Display** and use **◀** or **▶** to select **On** or **Off**.

Subtitle and Audio	
Subtitle Display	◀ Off ▶
Subtitle Type	Normal
Primary Subtitle Language	English
Secondary Subtitle Language	English
Audio Type	Normal
Primary Audio Language	English
Secondary Audio Language	English

- 3 Press **▲** or **▼** to select **Primary Subtitle Language** or **Secondary Subtitle Language** and press **◀** or **▶** to select an option.

The **SUBTITLE** button can be used to select subtitle on or off for the current channel only and to select the subtitle language if more than one subtitle is available.

Audio languages

This feature allows a programme or film to be viewed with a choice of soundtrack language, provided multiple language tracks are being broadcast.

- 1 In the **Subtitle and Audio** menu, press **▲** or **▼** to select **Audio Type** and press **◀** or **▶** to select **Normal** or **For Hard of Hearing**.
- 2 Press **▲** or **▼** to select **Primary Audio Language** or **Secondary Audio Language** and press **◀** or **▶** to select an option.

If more than one soundtrack is available, use the **◻/◻** button to select between them.

Common Interface

The *Common Interface Slot*, situated on the side of the television, enables the insertion of a CAM (Conditional Access Module) and card. These are purchased from a service provider and allow additional subscription broadcasts to be viewed. For information, see a service provider.

- 1 Insert the CAM and card into the Common Interface Slot, following the instructions provided with the CAM. A box will appear on screen to confirm that the CAM has been inserted.
- 2 Press **MENU** / ◀▶ / ▲ / ▶ to highlight **Setup / System Setup** icons and press **OK**.
- 3 Press ▲ or ▼ to select **DTV Settings** and press **OK**.
- 4 Press ▲ or ▼ to select **Common Interface** and press **OK**.
- 5 Details of the CAM should now be available.

NOTE:

- Software update of a CI Plus CAM may occur automatically if instigated by the broadcaster. This could cause the cancellation of any Reminders/Recordings during this process.
- Some CI or CI+ CAM may not be supported.
- CI+ operation is not guaranteed except for Canal Ready DTT services on suffix FC models.

Software Upgrade and Licences

Auto Upgrade

When **Auto Upgrade** is set to **On**, the television will automatically upgrade while in standby if new software is available.

- 1 In the **System Setup** menu, press ▲ or ▼ to select **Software Upgrade** and press **OK**.
- 2 Press ▲ or ▼ to select **Over-the-air Upgrade** and press **OK**.
- 3 Press ▲ or ▼ to select **Auto Upgrade**.
- 4 Use ◀ or ▶ to select **On** or **Off**.

Searching for New Software

If preferred, software upgrades can be searched for manually using **Search for New Software**.

- 1 In the **System Setup** menu, press ▲ or ▼ to select **Software Upgrade** and press **OK**.
- 2 Press ▲ or ▼ to select **Over-the-air Upgrade** and press **OK**.
- 3 Press ▲ or ▼ to select **Search for New Software**.
- 4 Press **OK**. The television will automatically start searching for a software upgrade, the progress bar will move along the line.

SEARCHING FOR NEW SOFTWARE

Searching for a new software upgrade for this TV.

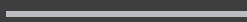
Searching 

If an upgrade is found, the television will automatically start downloading. If not, a screen will appear stating that an upgrade is unavailable.

Network Upgrade

TOSHIBA may offer upgrades for the TV's software in the future.
The TV's software is upgraded via the Network.

Before downloading software:

Configure your TV to connect to the Internet.

NOTE: While the upgrade is being performed, you will not be able to watch the TV.

- 1 In the **System Setup** menu, press ▲ or ▼ to select **Software Upgrade** and press **OK**.
- 2 Press ▲ or ▼ to select **Network Upgrade** and press **OK**.

NOTE: If the network is not available, a warning message will appear.

- 3 The TV software upgrade will start when download succeeds.

Software Licences

The licences for the software used in this television are available for viewing.

- 1 In the **System Setup** menu, press ▲ or ▼ to select **Software Licences** and press **OK**.

A screen will appear displaying all the licensing information required for the televisions software.

System Information and Reset TV

System Information

This feature can be used to check the version of software currently installed. When in DTV mode, it includes additional diagnostic information such as signal strength, signal quality, centre frequency, modulation, etc.

- 1 In the **System Setup** menu, press ▲ or ▼ to select **System Information**.
- 2 Press **OK** to display the **System Information**.

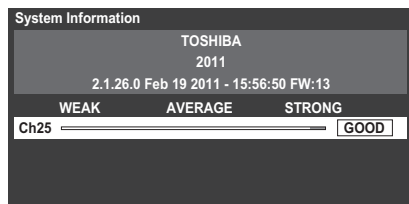

- 3 For information about the signal quality of a particular multiplex, press ▲ or ▼ to select that multiplex.
- 4 Press **OK** for a screen showing detailed technical information about the selected multiplex.

Reset TV

Selecting **Reset TV** will reset all TV settings, including saved channels, to their original factory values.

- 1 In the **System Setup** menu, press ▲ or ▼ to select **Reset TV**.
- 2 Press **OK** to select. A screen will appear warning that all settings will be lost. Press **OK** to continue.

When the set powers back on, the **Quick Setup** screen will appear. Press **OK** to advance the setup and perform an auto tune. (See "Quick Setup" section on page 18.)

PC Settings



Horizontal and Vertical Position

Connect the PC (as shown in the "Connecting a computer" section) and ensure that a picture is showing on the television screen. The picture position may now be adjusted to suit personal preference.

- 1 Press **MENU** / ◀▶ / ▲ / ▼ to highlight **Setup / Preferences** icons and press **OK**.
- 2 Press ▲ or ▼ to select **Display Settings** and press **OK**.
- 3 Press ▲ or ▼ to select **PC Settings** and press **OK**.

Display Settings	
Auto Format	On
4:3 Stretch	Off
Picture Position	
PC Settings	

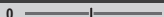
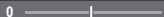
- 4 Press ▲ or ▼ to select an option and press ◀ or ▶ to adjust the settings.

PC Settings	
Horizontal Position	0 
Vertical Position	0 
Clock Phase	0 
Sampling Clock	0 
Reset	

Clock Phase

The **Clock Phase** matches the PC signal with the LCD display. Adjusting this can clear horizontal stripes and picture blur.

- 1 In the **Display Settings** menu, press ▲ or ▼ to select **PC Settings** and press **OK**.
- 2 Press ▲ or ▼ to select **Clock Phase**.
- 3 Press ◀ or ▶ to adjust until the picture clears.

Sampling Clock

Adjusting the **Sampling Clock** alters the number of pulses per scan, this will clear vertical lines on the screen.

- 1 In the **Display Settings** menu, press ▲ or ▼ to select **PC Settings** and press **OK**.
- 2 Press ▲ or ▼ to select **Sampling Clock**.
- 3 Press ◀ or ▶ to adjust until the picture clears.

Reset

Use **Reset** to return all items to the original factory settings.

- 1 In the **Display Settings** menu, press ▲ or ▼ to select **PC Settings** and press **OK**.
- 2 Press ▲ or ▼ to select **Reset** and press **OK**.

NOTE: When a PC is connected using HDMI, none of these functions will be available.

The screen is disrupted momentarily when adjusting PC Settings. This is not a sign of malfunction.

The default settings and adjustment ranges may vary depending on the input signal format.

Input selection and AV connections

See page 10 for a detailed image showing recommended connections.

Most media recorders and decoders send a signal through the SCART lead to switch the television to the correct *Input* socket.



Alternatively, press the external source selection button  until the picture from connected equipment is shown.

Input selection

Use the *Input Selection* window if the television does not switch over automatically.

- 1 By pressing  on the remote control or TV, a list will appear on screen showing all inputs and external equipment.

Pressing on the remote control

Inputs
TV
 1
 2
 3
HDMI 1
HDMI 2
HDMI 3
HDMI 4
PC

Pressing on the TV

Inputs
DTV Ant (or Cable) TV *
DTV Ant (or Cable) Radio *
DTV Ant (or Cable) Text *
DTV Sat TV *
DTV Sat Radio *
DTV Sat Text *
 1
 2
 3
HDMI 1
HDMI 2
HDMI 3
HDMI 4
PC
ATV





* If radio or text channels are currently available for DTV.

HDMI* displays equipment connected to *Input HDMI* on the back or side of the television.



PC displays a computer connected to *Input RGB/PC* on the back of the television.

External input skip



This feature is designed to make input selection more convenient by allowing you to skip unused inputs.



- 1 Press **MENU** /  /  /  to highlight **Setup** / **Preferences** icons and press **OK**.
- 2 Press  or  to select **AV Connection**.

Preferences	
Network Setup	
Network Device Setup	
Photo Frame Setup	
Teletext	Auto
Network Lock	
Panel Lock	Off
Display Settings	
AV Connection	

- 3 Press **OK** to display the **AV Connection** menu.
- 4 Press  or  to highlight **Input Labeling** and press **OK**.

AV Connection	
Input Labeling	
PC/HDMI 3 Audio	PC
HDMI 3 Audio	Digital
HDMI Settings	
Digital Audio Output	

- 5 Press  or  to select the input you want to skip, and then press the **RED** button to turn on the skip.

Input Labeling		
Input	Label	
EXT 1	← -- →	
EXT 2	--	
EXT 3	--	
HDMI 1	--	
HDMI 2	--	
HDMI 3	--	
HDMI 4	--	
PC	--	

- 6 To turn off the skip, press the **RED** button again.

The input set to Skip is grayed out in the *Input Selection* window and is skipped over when you press  on the remote control.

Labeling video input sources

These input labels are shown in the input selector. You can label video inputs according to the devices you have connected to the TV.

- 1 Press **MENU** / ◀▶ / ▲ / ▼ to highlight **Setup/Preferences** icons and press **OK**.
- 2 Press ▲ or ▼ to select **AV Connection** and press **OK**.
- 3 Press ▲ or ▼ to select **Input Labeling** and press **OK**.

Input Labeling		
Input	Label	
EXT 1	◀ -- ▶	
EXT 2	--	
EXT 3	--	
HDMI 1	--	
HDMI 2	--	
HDMI 3	--	
HDMI 4	--	
PC	--	

- 4 Press ▲ or ▼ to highlight the item you want to label, and then press ◀ or ▶ to select --, **Amplifier, Cable, DVD, Game, PC, Recorder, Satellite** or **VCR**, or press the **GREEN** button to select **User Input**.

NOTE: When **User Input** is selected by pressing the **GREEN** button, the **Software Keyboard** window will appear. Input the desired characters (10 characters or less) by using the **Software Keyboard** (see page 47) or using the number buttons for a number input. To save your settings, press the **BLUE** button.

- 5 Repeat step 4 for other video inputs.

PC Audio

In order to receive sound from a connected PC, plug the audio cable into the back of the television (as shown in the "Connecting a computer" section), and then use the **PC/HDMI 3 Audio** setting.

- 1 In the **Preferences** menu, press ▲ or ▼ to select **AV Connection** and press **OK**.
- 2 Press ▲ or ▼ to select **PC/HDMI 3 Audio** and press ◀ or ▶ to select the **PC** option.

NOTE: Selecting the **PC** option will force HDMI 3 Audio to Digital mode.

HDMI 3 Audio

If the connected HDMI source does not support digital audio, plug the audio cable into **PC/HDMI 3 (AUDIO)** on the back of the television (as shown in the "Connecting an HDMI® or DVI device to the HDMI input" section on page 11), then use the **HDMI 3 Audio** setting.

- 1 In the **Preferences** menu, press ▲ or ▼ to select **AV Connection** and press **OK**.
- 2 Press ▲ or ▼ to select **HDMI 3 Audio** and press ◀ or ▶ to select **Auto** or **Analogue**.

AV Connection	
Input Labeling	
PC/HDMI 3 Audio	PC
HDMI 3 Audio	◀ Auto ▶
HDMI Settings	
Digital Audio Output	

If the sound is absent, try selecting a different setting.

NOTE: HDMI 3 supports digital and analogue sound, HDMI 1, HDMI 2 and HDMI 4 are digital sound only.

Certain DVD disk formats may not output from this TV (32/44.1/48kHz and 16/20/24 bits are acceptable).

HDMI Settings

Some early HDMI equipment may not work properly with your HDMI TV. Please try setting the **Enable Content Type** and **INSTAPORT™** options to **Off**. Adjusting these settings should allow your early HDMI source to operate properly with your television.

1 In the **Preferences** menu, press **▲** or **▼** to select **AV Connection** and press **OK**.

2 Press **▲** or **▼** to select **HDMI Settings** and press **OK**.

NOTE: **HDMI Settings** is grayed out on non-HDMI inputs.

3 Press **▲** or **▼** to select an item and press **◀** or **▶** to select a setting.

HDMI Settings	
Enable Content Type	◀ On ▶
INSTAPORT™	On
RGB Range	Auto

• Enable Content Type: On

This feature is part of the HDMI standard.

When set to **On**, the TV will automatically adjust settings according to the content type data sent from the connected HDMI device.

• INSTAPORT™: On

This feature reduces the lag time when switching HDMI sources.

• RGB Range: Auto

This feature adjusts RGB full range signal automatically. When **Limited** is selected, RGB signal is output in the range from 16 to 235. When **Full** is selected, RGB signal is output in the range from 0 to 255.

NOTE:

- If your HDMI connection is capable of 1080p and/or your television is capable of refresh rates greater than 50Hz or supports Deep Colour, you will need a Category 2 cable. Conventional HDMI/DVI cables may not work properly with this mode.
- All of the above HDMI settings need proper HDMI source devices. If the HDMI source products do not support these features, the television may not work properly by activating these features.

Digital Audio Output

When connecting a surround sound amplifier to the digital audio output (Sony/Philips Digital Interface Format [S/PDIF]), the following options can be selected or adjusted.

1 In the **Preferences** menu, press **▲** or **▼** to select **AV Connection** and press **OK**.

2 Press **▲** or **▼** to select **Digital Audio Output**.

AV Connection	
Input Labeling	
PC/HDMI 3 Audio	PC
HDMI 3 Audio	Auto
HDMI Settings	
Digital Audio Output	

3 Press **OK** to display **Digital Audio Output** menu and press **▲** or **▼** to select an option.

Audio Format:

Press **◀** or **▶** to select **PCM** or **Auto**.

PCM: This mode outputs PCM format to the digital audio output socket.

Auto: This mode outputs Dolby Digital (if available) or PCM to the digital audio output socket.
 Dolby Digital → Dolby Digital
 Dolby Digital Plus → Dolby Digital
 MPEG → PCM
 HE-AAC → Dolby Digital

Audio Delay:

Press **◀** or **▶** to select **Auto** or **Manual**.

Auto: This mode automatically adjusts the audio timing to meet the video timing.

NOTE: The time lag might be large between the image and sound depending on the connected equipment (amplifier etc.). In that case, select **Manual**.

Manual: You can manually adjust the audio signal timing to meet the video signal timing.

Delay Adjustment:

Press **◀** or **▶** to adjust the audio signal timing (0 – 250ms) to meet the video signal timing.

NOTE:

- This feature is grayed out when **Audio Delay** is in **Auto**.
- A time lag will occur when the video signal or audio signal is changed. Adjust the timing accordingly.
- When adjusting the timing, turn down the volume of the AV equipment used as far as possible. Depending on the equipment, noise etc. may occur when the signal is changed.
- Depending on the connected equipment (amplifier, etc.), adjustment may not be possible.
- When the optical digital output setting (Auto ↔ PCM) is changed, it may be necessary to adjust the timing again.
- Do not use other than for audio output from the AV amplifier, etc. (Malfunction may occur)

Using Personal TV Mode

You can customize some TV functions as desired and those settings can be saved in one of 4 Personal Modes (A to D). The Personal Mode can be selected from the **Quick Menu** (manual switching), or when individual Facial Recognition is performed with the camera, at the Welcome Window, press the coloured button corresponding to each Personal Mode.

Manual Switching

- 1 Press **QUICK** to open the **Quick Menu**.
- 2 Press **▲** or **▼** to select **Personal Mode** and press **OK**.

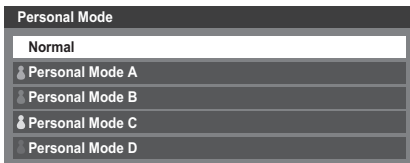

- 3 Press **▲▼** or corresponding coloured button to select individual Personal Mode from **Normal**, **Personal Mode A**, **Personal Mode B**, **Personal Mode C** and **Personal Mode D**. The mode will default to **Normal** every the TV is turned off and on.

NOTE: If the Personal PIN has been set, the Lock icon will be displayed. If the Personal PIN entry screen is displayed, enter the correct Personal PIN.

Facial Recognition

After registering faces beforehand for each Personal Mode, the Welcome Window will be displayed when the camera detects a corresponding face. The Personal Name corresponding to the detected face will be displayed in the Welcome Window.

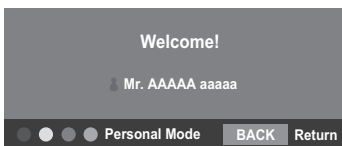

Change Personal Modes by pressing the corresponding Coloured button while the Welcome Window is being displayed. Switch at this time to the Personal Mode corresponding to the Coloured button that was pressed, even if it is the Coloured button for a Personal Mode that corresponds to a face other than the one recognized.

NOTE: If the Personal PIN has been set, the Personal PIN entry screen will be displayed. Enter the correct Personal PIN.

Personal TV Setup

- 1 Press **MENU** / **◀▶** / **▲** / **◀▶** to highlight **Setup** / **Preferences** icons and press **OK**.
- 2 Press **▲** or **▼** to select **Personal TV Setup** and press **OK**.

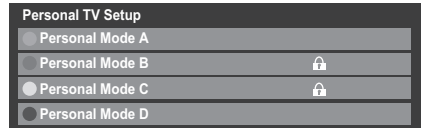

- 3 Press **▲** or **▼** (or corresponding coloured button) to select the individual Personal Mode and press **OK**.

Display Example (UL series)

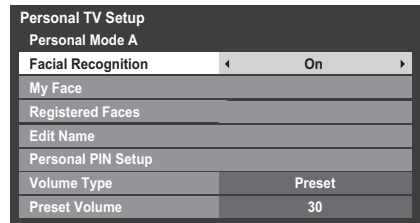

Facial Recognition, **My Face** and **Registered Faces** features are for UL86 and UL87 series only.

Facial Recognition

Press **▲** or **▼** to select **Facial Recognition** and press **◀▶** to select **On** or **Off** to activate or deactivate this function.

My Face

My face is the facial registration necessary for performing Facial Recognition.

- 1 Press **▲** or **▼** to select **My Face** and press **OK**.

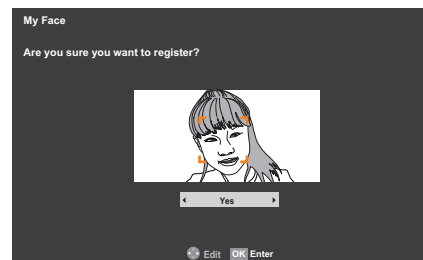

The My Face screen will appear.

- 2** Display the video image currently being taken by the camera. If a face is detected, the camera sensor will place a focus around that face. When a face is detected within the "OK to register" frame on the My Face screen, press **OK** to register.

NOTE:

- It will be impossible to register a face if there are multiple faces detected inside of the video image.
- It will be impossible to register a face if there is no face detected inside of the video image.
- It will be impossible to register a face if the face was already registered for another personal mode.
- It will be impossible to register a face if the TV is recording status. At this time, the video from camera cannot be displayed.
- If the above **Facial Recognition** is **Off**, **My Face** will be grayed out.
- If you have already registered 10 faces, a new face cannot be registered.

Registered Faces

This feature is to confirm a face that has already been registered.

- 1** Press **▲** or **▼** to select **Registered Faces** and press **OK**.

The Registered Faces screen will appear.

- 2** Press **▲▼◀▶** to select each registered face.

- 3** Press the **RED** button if you want to delete the face.

- 4** Press **◀** or **▶** to select **Yes** in the confirmation window and press **OK**.

NOTE: When the **Reset TV** is executed, all registered faces will be reset.

Edit Name

You can edit the name of your Personal Mode. Press **▲** or **▼** to select **Edit Name** and press **OK**. Edit the desired name by using the software keyboard (see page 47). The maximum number of characters is 25.

Personal PIN Setup

Press **▲** or **▼** to select **Personal PIN Setup** and press **OK**. Enter your personal PIN in same manner as "Parental PIN Setup" on page 76.

Volume Type

Press **▲** or **▼** to select **Volume Type** and press **◀** or **▶** to select **Preset** or **Last**.

Last — The last volume level in your Personal Mode.

Preset — The Preset volume level is selected whenever the Personal Mode is switched.

Preset Volume

Press **▲** or **▼** to select **Preset Volume** and press **▲** or **▼** to adjust your desired volume level. When the **Volume Type** is set to **Last**, this feature will be grayed out.

Behaviour in Personal Mode• **Personal Favourite Channel List (Fav5 -Fav8):**

Normal Mode: Fav1 / Fav2 / Fav3 / Fav4

Personal Mode A: Fav5

Personal Mode B: Fav6

Personal Mode C: Fav7

Personal Mode D: Fav8

Press the **LIST** button to display Channel List and press **◀** or **▶** to select **All** or your Personal Mode (**Fav5 – Fav8**)

• **Personal Picture Mode:**

The Picture Mode you selected is stored in your Personal Mode.

• **Personal Volume:**

The sound volume you set is stored in your Personal Mode.

Personal Grouping of Recorded Programmes

When switching between Personal Modes, recordings (OTR, TimeShift, Timer Recording) will be displayed categorically in the Library by Personal Mode.

Programmes recorded in Personal Mode A/B/C/D with OTR or TimeShift will be saved remembering the Personal Grouping corresponding to each respective mode.

When user performs a Timer Recording while in Personal Mode A/B/C/D, after the transition to Set Timer, make the Default for Personal Grouping (a Set Timer setting item) be a selection item corresponding to whatever mode you are in.

When you perform OTR, TimeShift, or Timer Recording while in Normal Mode, the Personal Grouping for recorded programmes will be remembered as "None."

Using REGZA-LINK

This is a new feature that uses CEC technology and allows you to control Toshiba REGZA-LINK compatible devices from the television remote control via HDMI connection (page 12).

When the **Enable REGZA-LINK** item in the **REGZA-LINK Setup** menu is set to **On**, individual functions also set to **On** will be activated.

Enable REGZA-LINK

- 1 Press **MENU** / ◀▶ / ▲ / ▶ to highlight **Setup** / **Preferences** icons and press **OK**.
- 2 Press ▲ or ▼ to select **REGZA-LINK Setup** and press **OK**.
- 3 Press ▼ to select **Enable REGZA-LINK** and press ◀ or ▶ to select **On**.

REGZA-LINK Setup	
Enable REGZA-LINK	◀ On ▶
TV Auto Power	On
Auto Standby	On
Amplifier Control	On
Initial Speaker Setting	TV Speakers
Position Key Pass Through	

NOTE: If you set **Enable REGZA-LINK** to **Off**, all other items will be grayed out.

TV Auto Power

The **TV Auto Power** setting allows the television to be automatically switched on if a REGZA-LINK device is turned on.

- 1 In the **REGZA-LINK Setup** menu, press ▼ to highlight **TV Auto Power**.
- 2 Press ◀ or ▶ to select **On** or **Off**.

Auto Standby

When **Auto Standby** is enabled, the television, when switched off, will automatically switch off (standby mode) all connected REGZA-LINK equipment.

- 1 In the **REGZA-LINK Setup** menu, press ▼ to highlight **Auto Standby**.
- 2 Press ◀ or ▶ to select **On** or **Off**.

Amplifier Control

When **Amplifier Control** is set to **On**, it allows the "Initial Speaker Setting" feature to become available.

- 1 In the **REGZA-LINK Setup** menu, press ▼ to highlight **Amplifier Control**.
- 2 Press ◀ or ▶ to select **On** or **Off**.

Initial Speaker Setting

This feature allows the audio output preference to be set to the TV speakers or AV amplifier speakers. The AV Amplifier option lets the television's remote control adjust or mute the volume of the audio.

- 1 In the **REGZA-LINK Setup** menu, press ▼ to highlight **Initial Speaker Setting**.
- 2 Press ◀ or ▶ to select **TV Speakers** or **Amplifier**.

Position Key Pass Through

When **Position Key Pass Through** for the selected HDMI input mode is set to **On**, the **P**^**P** and number (0-9) keys on the remote control will pass through. When in **Off**, those operate as TV programme selection keys.

- 1 In the **REGZA-LINK Setup** menu, press ▼ to highlight **Position Key Pass Through** and press **OK**.
- 2 Press ▲ or ▼ to select the appropriate HDMI mode.
- 3 Press ◀ or ▶ to select **On**.

REGZA-LINK input source selection

If a REGZA-LINK device with HDMI switching capability (e.g. AV amplifier) is connected to the HDMI input, you can select another REGZA-LINK device that is connected to the master HDMI device on the input source list.

- 1 Press and a list will appear on screen showing available input sources.
- 2 Press to select the desired input source with REGZA-LINK icon.
- 3 Press and a second selection screen will appear showing all connected REGZA-LINK equipment.

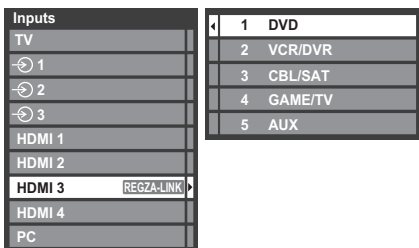

- 4 Press or to select the desired input source, and then press **OK**.

NOTE:

- These functions depend on the device connected.
- If you select the REGZA-LINK input source from the pop up window, some REGZA-LINK devices may automatically turn on.
- When the television is switched on it will take a few minutes for the REGZA-LINK icon to appear in the list. When an HDMI cable is removed, it will take a few minutes for the icon to disappear.
- If the HDMI cable from connected equipment is changed, **Enable REGZA-LINK** in the REGZA-LINK Setup menu may need to be reset to **On**.
- If you change the HDMI lead to a connected device or change an HDMI device setting, reset the **Enable REGZA-LINK** item on the REGZA-LINK Setup menu from **Off** to **On**.

REGZA-LINK Device Control

With the REGZA-LINK mode on your television's remote control, you can control the connected REGZA-LINK device you are watching.

To control the REGZA-LINK input source first select the equipment by REGZA-LINK input source selection.

- 1 Press **QUICK** to open the **Quick Menu**.
- 2 Press or to select **REGZA-LINK Device Control** and press **OK**.

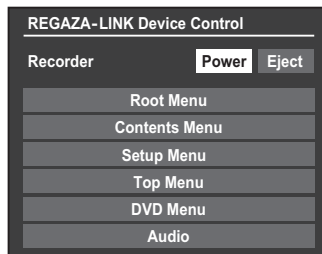

- 3 Press or to select a control option and press **OK**.

NOTE: The available functions depend on the equipment connected. Please refer to the operation manual for each piece of equipment connected.

REGZA-LINK one touch play

When connected equipment is switched on, REGZA-LINK will automatically detect the television through the input selection. If the television is in standby, it will be switched on automatically.

These functions can be enabled or disabled from the REGZA-LINK Setup (see page 87).

NOTE:

- Even if the equipment is showing a menu, the television may automatically show the input source.
- This feature depends on the connected equipment and television state.

REGZA-LINK system standby

If the television is turned off (standby mode), the television will send a message to turn off (standby mode) all of the REGZA-LINK devices connected to the television.

These functions can be enabled or disabled from the REGZA-LINK Setup (see page 87).

NOTE: This feature depends on the connected equipment and television state.

REGZA-LINK system audio control

With your television's remote control, you can adjust or mute the sound volume of the speakers connected to the television via an AV amplifier.

- 1** Set the **Initial Speaker Setting** to **Amplifier** in the **REGZA-LINK Setup** menu.
- 2** Confirm that a connected REGZA-LINK device (such as a DVD player, etc) is selected for the AV amplifier input source.

NOTE:

- These functions depend on the device connected.
- When you turn on the AV amplifier, change its input source, or adjust the sound volume, the sound will be output from the AV amplifier's speakers even if **TV Speakers** has been selected. Turn the television off and on again to output the sound from the TV Speakers.
- This feature may not work if the AV amplifier is operated.

Toshiba PC compatible with REGZA-LINK

This feature automatically adjusts the suitable widescreen formats and picture preferences when connected to a Toshiba PC compatible with REGZA-LINK.

NOTE: This feature depends on the connected equipment state.

Text services

This television has a multi-page text memory, which takes a few moments to load. It offers two **Modes** of viewing text – **Auto** will display **Fasttext**, if available. **List** will save your four favourite pages.

Selecting modes

The text character set will be automatically chosen by the language setting in the **Setup** menu.

- 1 Press **MENU** / ◀▶ / ▲ / ▼▶ to highlight **Setup** / **Preferences** icons and press **OK**.
- 2 Press ▲ or ▼ to select **Teletext**, and then press ◀ or ▶ to select **Auto** or **List**.

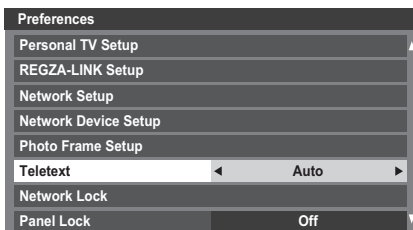

Text information

The TEXT button:

To view text services press **TEXT**. Press again to superimpose the text over a normal broadcast picture and again to return to normal viewing. Channels cannot be changed until text is cancelled.

The first text page shown will be the *initial* page.

Any text page can be accessed by entering the 3 digit page number using the numbered buttons, pressing the coloured buttons or pressing **P**▲ to advance to the next page and **P**▼ to go back to the previous page.

Sub-pages

The pages on the screen will dynamically update as sub-pages are received.

If you open a page containing sub-pages, the sub-pages are automatically displayed in sequence. To quit automatic sub-page change, press ◀ or ▶.

Once selected, the sub-page you are viewing will be highlighted and, as the television loads any additional sub-pages, the colour of the numbers will change, indicating that these pages have been loaded.

These sub-pages will remain available to view until another page is chosen or, in normal TV mode, the channel is changed.

Navigating pages using Auto

If **Fasttext** is available, four coloured titles will appear at the base of the screen.

To access one of the four given subjects, press the relevant coloured button on the remote control.

For further information on your particular text system(s), see the broadcast text index page or consult your local Toshiba dealer.

Navigating pages using LIST

The four coloured choices at the bottom of the screen are numbers – 100, 200, 300 and 400, which have been programmed into the television's memory. To view these pages, press the relevant coloured buttons.

To change these saved pages, press the relevant coloured button and enter the 3 digit number. This number will change in the top left of the screen and in the coloured highlight.

Press **OK** to save. **Whenever OK is pressed, all four page numbers showing at the bottom will be saved and the previous ones will be lost.**

If **OK** is not pressed, the selection will be forgotten when the channel is changed.

Other pages may be viewed by entering the 3 digit page number – but DO NOT press **OK** or these pages will be saved.

Control buttons

Below is a guide to the functions of the remote control text buttons.

To display the index/initial page:

Press  to access the index/initial page. The one displayed is dependant on the broadcaster.



TEXT To display a page of text:

Press **TEXT** to display text. Press again to superimpose text over a normal picture. Press again to return to normal television viewing. Channels cannot be changed until this has been done.

To reveal concealed text:

To discover the solutions on quiz and joke pages press the  button.



To hold a wanted page:

At times it is convenient to hold a page of text. Press  and  will appear in the top left of the screen. The page will be held on screen until the button is pressed again.

To enlarge the text display size:

Press  once to enlarge the top half of the page, press again to enlarge the bottom half of the page. Press again to revert to normal size.

To select a page whilst viewing normal picture:

Enter the page number then press   normal picture will be displayed. The television will indicate when the page is ready by changing the colour of the page number at the top of the screen. Press **TEXT** to view the page.

To display news flashes:

Select the news flash page for the chosen text service (see the index page of text service). The news flashes will be displayed as and when they are broadcast.



Remember to cancel text before changing channels - press the TEXT button twice.

Questions and Answers

Below are the answers to some of the most common queries.

Q *Why is there no sound or picture?*

A Check the television is not in standby mode. Check the mains plug and all mains connections.

Q *There is a picture, but why is there little or no colour?*

A When using an **external** source, for instance, a poor quality video tape, if there is little or no colour, improvements may sometimes be achieved. The colour is factory set to **Auto** to automatically display the best colour system.

To check that you have the best colour:

- 1 With the external source playing, select **Colour System** from the **System Setup** menu.

System Setup	
Menu Language	English
Country	Germany
Colour System	Auto

- 2 With ◀ or ▶ choose between **Auto**, **PAL**, **SECAM**, **NTSC 4.43** or **NTSC 3.58**.

Q *Why doesn't the video/DVD being played show on screen?*

A Make sure the media recorder or DVD player is connected to the television as shown on page 10, and then select the correct input by pressing .

Q *Why is there a picture but no sound?*

A Check all lead connections.
No sound or unacceptable format sound may be received.
Check the volume has not been turned down or that sound mute has not been selected.
Check shared audio settings.

Q *What else can cause a poor picture?*

A Interference or a weak signal. Try a different television station. **Manual Fine Tuning** may help.

- 1 Select the **ATV Manual Tuning** menu. Highlight the station and press **OK**. Then press ▶ to select **Manual Fine Tuning**.
- 2 Using ▲ or ▼ adjust to get the best picture and sound. Press **OK** and then **EXIT**.



Q *Why don't the controls of the television work?*

A Check that **Panel Lock** is not **On**.

Q *Why doesn't the remote control work?*

A Check that the batteries aren't dead or inserted incorrectly.

Q *Why is the digital channel locked?*

A The channel has been locked in **Channel Options** (see "Digital settings – Channel Options" section).

Q *Why are some of the digital subscription channels unavailable?*

A Your subscription needs upgrading. Contact your service provider.

Q *Why is the soundtrack in English when a different audio language has been selected?*

A The programme is currently being broadcast with an English soundtrack only.

Q *Why is there incorrect or no sound when in DTV mode?*

A Press /I to ensure the hard of hearing option has not been selected.

Q *What is DVB-T?*

A Digital Video Broadcast via an aerial/antenna.

Q *What is DVB-C?*

A Digital Video Broadcast via a cable connection.

Q *How are radio channels selected?*

A Press **TV** on the remote control and select **DTV Radio**. Alternatively select from the **GUIDE**.

Q *What can be done if the PIN number has been forgotten?*

A Use the Master PIN code of 1276, then change to a number of your choice. Select **Parental PIN Setup** from the **DTV Settings** menu to enter PIN. Ensure that no-one else can use the Master PIN by removing the Owner's Manual.

Q *Why are there vertical stripes on the screen when in PC mode?*

A The **Sampling Clock** may need adjustment. Select **PC Settings** from the **Display Settings** menu, highlight **Sampling Clock** and adjust until the lines clear.

Q *Why are there horizontal stripes and/or blurred images on the screen when in PC mode?*

A The **Clock Phase** may need adjustment. Select **PC Settings** from the **Display Settings** menu, highlight **Clock Phase** and adjust until the picture clears.

Q *Why when digital subtitles have been selected are they not showing on screen?*

A Subtitles are not currently being transmitted by the broadcaster.

Q *Why are there problems with analogue text?*

A Good performance of text depends on a good strong broadcast signal. This normally requires a roof or loft aerial. If the text is unreadable or garbled, check the aerial. Go to the *main index* page of the text service and look for the *User Guide*. This will explain the basic operation of text in some detail. If further information is needed on how to use text see the *text section*.

Q *Why is a page number visible at the top of the screen but no text?*

A Text has been selected but Teletext information is currently unavailable on the current source.

Q *Why are the colours wrong when an NTSC source is played?*

A Connect the source via a SCART lead and play. Select **Colour System** from the **System Setup** menu.

1 Set the Colour to **Auto** and exit.

2 Go to the **Picture** menu and adjust the tint.

Q *Why don't the devices connected via HDMI operate properly?*

A Make sure to use cables with the HDMI logo  (see page 11).

Some early HDMI equipment may not work properly with the latest HDMI TV products, due to new standard adoption. Try switching the HDMI settings (**Enable Content Type** and **INSTAPORT™**) to **Off**.

Q *Why don't the REGZA-LINK devices work?*

A When the connected REGZA-LINK device does not work correctly after you have changed the settings of the device, turn off your television and unplug the power cord, and then plug and turn on again. Unplug the HDMI cable of the REGZA-LINK device and lead again.

Q *Why is the REGZA-LINK logo still showing when the equipment has been disconnected?*

A If the REGZA-LINK device is disconnected, the logo will disappear after approximately one minute.

Q *Why don't the networked devices work?*

A The LAN cables are not connected properly or at all. Connect all cables (see page 14). Make sure your network address is set up correctly (see page 45).

Q *Why doesn't the wireless network work?*

A Make sure the TOSHIBA Dual Band WLAN Adaptor is used (see page 14). Check that the AP is powered on.

Q Why doesn't the Media Player feature operate?

A Make sure that devices are connected correctly. Incorrect behaviour may occur with a USB Hub connection.
Check your network setup if using DLNA CERTIFIED™ Server.

Q What do the LEDs on the front of the television indicate?

A Check the table below.

Q Why doesn't the USB HDD work?

A Register your USB HDD.
Use the USB 2 port to connect the USB HDD.
Your country/area may not support the USB HDD function.

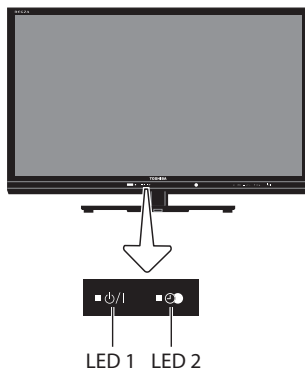



LED indication		Condition	Solution
LED-1	LED-2		
Green	Orange	Power ON Programme Timer is set Both Programme Timer (Recording) and Recording are NOT working	-
Green	Red	Power ON Programme Timer (Recording) or Recording is working	-
Green	OFF	Power ON Programme Timer is NOT set Both Programme Timer (Recording) and Recording are NOT working	-
Red	Orange	Power OFF (Standby) Programme Timer is set Both Programme Timer (Recording) and Recording are NOT working	-
Red	Red	Power OFF (Standby) Programme Timer (Recording) or Recording is working	-
Red	OFF	Power OFF (Standby) Programme Timer is NOT set Both Programme Timer (Recording) and Recording are NOT working	-

LED indication		Condition	Solution
LED-1	LED-2		
OFF	Green (Blinks)	Abnormal operation of BUS line.	Turn OFF the TV and unplug the power cord. Plug the power cord in again and turn ON the TV.
Red (Blinks)	OFF	Abnormal operation of WDT.	
Green (Blinks)	OFF	Fan stopped. (if applicable)	-
Orange	Green	For Service SW Upgrade in Progress	
Red	OFF	For Service SW Upgrade Failed	-
Green	OFF	For Service SW Upgrade Successful	-

License Information

- 

This product achieved the European Eco label award issued by the European Commission. You can get more information in following link: <http://ec.europa.eu/environment/ecolabel/>
- 

Manufactured under license from Dolby Laboratories.
- 

Dolby and the double-D symbol are trademarks of Dolby Laboratories.
- 

HDMI, the HDMI logo, and High-Definition Multimedia Interface are trademarks or registered trademarks of HDMI Licensing, LLC.
- INSTAPORT™ and INSTAPORT logo are trademarks of Silicon Image, Inc. in the United States and other countries.
- YouTube and the YouTube Logo are trademarks of Google Inc.
- This product contains NetFront Browser of ACCESS CO., LTD.
- 

ACCESS, the ACCESS logo and NetFront are trademarks or registered trademarks of ACCESS CO., LTD. in the United States, Japan and other countries.
- 

© 2010 ACCESS CO., LTD. All rights reserved. This software is based in part on the work of the Independent JPEG Group.
- 

Opera® Browser from Opera Software ASA. Copyright 1995-2010 Opera Software ASA. All rights reserved. For further information, please see <http://www.opera.com>
- This product contains Adobe® Flash® Player software under license from Adobe Systems Incorporated. Copyright © 1995-2009 Adobe Systems Incorporated. All rights reserved. Adobe and Flash are trademarks of Adobe Systems Incorporated.
- DVB is a registered trademark of the DVB Project.
- 

DivX®, DivX Certified®, DivX Plus™ HD and associated logos are trademarks of DivX, Inc. and are used under license. Covered by one or more of the following U.S. patents: 7,295,673; 7,460,668; 7,515,710; 7,519,274
- DLNA®, DLNA® Certification Logo and DLNA CERTIFIED™ are registered trademarks, service marks, or certification marks of the Digital Living Network Alliance.
- THIS PRODUCT IS LICENSED UNDER THE AVC PATENT PORTFOLIO LICENSE FOR THE PERSONAL AND NONCOMMERCIAL USE OF A CONSUMER TO (i) ENCODE VIDEO IN COMPLIANCE WITH THE AVC STANDARD (AVC VIDEO) AND/OR (ii) DECODE AVC VIDEO THAT WAS ENCODED BY A CONSUMER ENGAGED IN A PERSONAL AND NONCOMMERCIAL ACTIVITY AND/OR WAS OBTAINED FROM A VIDEO PROVIDER LICENSED TO PROVIDE AVC VIDEO. NO LICENSE IS GRANTED OR SHALL BE IMPLIED FOR ANY OTHER USE. ADDITIONAL INFORMATION MAY BE OBTAINED FROM MPEG LA, L.L.C.

SEE [HTTP://WWW.MPEGLA.COM](http://www.mpegla.com)
- THIS PRODUCT IS LICENSED UNDER THE MPEG-4 VISUAL PATENT PORTFOLIO LICENSE FOR THE PERSONAL AND NON-COMMERCIAL USE OF A CONSUMER FOR (i) ENCODING VIDEO IN COMPLIANCE WITH THE MPEG-4 VISUAL STANDARD ("MPEG-4 VIDEO") AND/OR (ii) DECODING MPEG-4 VIDEO THAT WAS ENCODED BY A CONSUMER ENGAGED IN A PERSONAL AND NON-COMMERCIAL ACTIVITY AND/OR WAS OBTAINED FROM A VIDEO PROVIDER LICENSED BY MPEG LA TO PROVIDE MPEG-4 VIDEO. NO LICENSE IS GRANTED OR SHALL BE IMPLIED FOR ANY OTHER USE. ADDITIONAL INFORMATION INCLUDING THAT RELATING TO PROMOTIONAL, INTERNAL AND COMMERCIAL USES AND LICENSING MAY BE OBTAINED FROM MPEG LA, L.L.C.

SEE [HTTP://WWW.MPEGLA.COM](http://www.mpegla.com)
- MPEG Layer-3 audio coding technology licensed from Fraunhofer IIS and Thomson.
- 

Audysses EQ technology
- Manufactured under license from Audyssey Laboratories. U.S. and foreign patents pending. Audyssey EQ is a registered trademark of Audyssey Laboratories. Audyssey EQ is based on the same core technology as Audyssey MultEQ that is used for automatic correction of room acoustics. Audyssey EQ uses time-domain filters to correct problems that arise from speaker drivers and enclosures and is calibrated to account for the acoustical problems in a typical listening environment.
- Hybrid TV Standard is implemented according to ETSI TS 102 796 v1.1.1.

Cleaning the screen and cabinet...

Turn off the power, and clean the screen and cabinet with a soft, dry cloth. We recommend that you **do not** use any proprietary polishes or solvents on the screen or cabinet as this may cause damage.

Disposal...

The following information is only for EU-member states:

Disposal of products

The crossed out wheeled dust bin symbol indicates that products must be collected and disposed of separately from household waste. Integrated batteries and accumulators can be disposed of with the product. They will be separated at the recycling centres.

The black bar indicates that the product was placed on the market after August 13, 2005.

By participating in separate collection of products and batteries, you will help to assure the proper disposal of products and batteries and thus help to prevent potential negative consequences for the environment and human health.

For more detailed information about the collection and recycling programmes available in your country, please contact your local city office or the shop where you purchased the product.

**Disposal of batteries and/or accumulators**

The crossed out wheeled dust bin symbol indicates that batteries and/or accumulators must be collected and disposed of separately from household waste.

If the battery or accumulator contains more than the specified values of lead (Pb), mercury (Hg), and/or cadmium (Cd) defined in the Battery Directive (2006/66/EC), then the chemical symbols for lead (Pb), mercury (Hg) and/or cadmium (Cd) will appear below the crossed out wheeled dust bin symbol.

By participating in separate collection of batteries, you will help to assure the proper disposal of products and batteries and thus help to prevent potential negative consequences for the environment and human health.

For more detailed information about the collection and recycling programmes available in your country, please contact your local city office or the shop where you purchased the product.



Information

Before connecting any external equipment, turn off all main power switches. If there is no switch, remove the mains plug from the wall socket.

Signal information for Mini D-sub 15 pin connector

Pin No.	Signal name	Pin No.	Signal name	Pin No.	Signal name
1	R	6	Ground	11	NC
2	G	7	Ground	12	NC
3	B	8	Ground	13	H-sync
4	NC*	9	NC	14	V-sync
5	Ground	10	Ground	15	NC

* NC = not connected

Acceptable PC signals through the PC terminal

The PC input on this TV only accepts signal formats which are compliant with VESA-DMT as shown in the table below. Since some PCs input signals which are different from the resolution and frequency described in the table below, the following phenomenon may occur; incorrect display, false format detection, picture position failure, blur, or judder. In this case, set the monitor output format on your PC to conform to a signal in the table below.

Format	Resolution	V. Frequency	H. Frequency	Pixel Clock Frequency	VESA Standard (DMT)
VGA	640 × 480	59.940Hz	31.469kHz	25.175MHz	●
		72.809Hz	37.861kHz	31.500MHz	●
		75.000Hz	37.500kHz	31.500MHz	●
SVGA	800 × 600	56.250Hz	35.156kHz	36.000MHz	●
		60.317Hz	37.879kHz	40.000MHz	●
		72.188Hz	48.077kHz	50.000MHz	●
		75.000Hz	46.875kHz	49.500MHz	●
XGA	1024 × 768	60.004Hz	48.363kHz	65.000MHz	●
		70.069Hz	56.476kHz	75.000MHz	●
		75.029Hz	60.023kHz	78.750MHz	●
WXGA	1280 × 768	59.995Hz	47.396kHz	68.250MHz	●
		59.870Hz	47.776kHz	79.500MHz	●
		74.893Hz	60.289kHz	102.250MHz	●
	1360 × 768	60.015Hz	47.712kHz	85.500MHz	●
SXGA	1280 × 1024	60.020Hz	63.981kHz	108.000MHz	●
		75.025Hz	79.976kHz	135.000MHz	●

Acceptable video or PC signals through the HDMI terminals

The HDMI inputs on this TV only accept VGA, SVGA, XGA, WXGA, and SXGA signal formats which are compliant with VESA as shown in the table below. Since some PCs and HDMI or DVI devices input signals which are different from the resolution and frequency described in the table below, the following phenomenon may occur; incorrect display, false format detection, picture position failure, blur, or judder. In this case, set the monitor output format on your PC, HDMI or DVI device to conform to a signal in the table below.

Format	Resolution	V. Frequency	H. Frequency	Pixel Clock Frequency	VESA Standard
480i	720 × 480i	59.940/60.000Hz	15.734/15.750kHz	27.000/27.027MHz	
576i	720 × 576i	50.000Hz	15.625kHz	27.000MHz	
480p	720 × 480p	59.940/60.000Hz	31.469/31.500kHz	27.000/27.027MHz	
576p	720 × 576p	50.000Hz	31.250kHz	27.000MHz	
1080i	1920 × 1080i	59.940/60.000Hz	33.716/33.750kHz	74.176/74.250MHz	
1080i	1920 × 1080i	50.000Hz	28.125kHz	74.250MHz	
720p	1280 × 720p	59.940/60.000Hz	44.955/45.000kHz	74.176/74.250MHz	
720p	1280 × 720p	50.000Hz	37.500kHz	74.250MHz	
1080p	1920 × 1080p	59.940/60.000Hz	67.433/67.500kHz	148.352/148.500MHz	
1080p	1920 × 1080p	50.000Hz	56.250kHz	148.500MHz	
1080p	1920 × 1080p	24.000Hz	27.000kHz	74.250MHz	
VGA	640 × 480	59.940/60.000Hz	31.469/31.500kHz	25.175/25.200MHz	●
		72.809Hz	37.861kHz	31.500MHz	●
		75.000Hz	37.500kHz	31.500MHz	●
SVGA	800 × 600	56.250Hz	35.156kHz	36.000MHz	●
		60.317Hz	37.879kHz	40.000MHz	●
		72.188Hz	48.077kHz	50.000MHz	●
		75.000Hz	46.875kHz	49.500MHz	●
XGA	1024 × 768	60.004Hz	48.363kHz	65.000MHz	●
		70.069Hz	56.476kHz	75.000MHz	●
		75.029Hz	60.023kHz	78.750MHz	●
WXGA	1280 × 768	59.995Hz	47.396kHz	68.250MHz	●
		59.870Hz	47.776kHz	79.500MHz	●
		74.893Hz	60.289kHz	102.250MHz	●
	1360 × 768	60.015Hz	47.712kHz	85.500MHz	●
SXGA	1280 × 1024	60.020Hz	63.981kHz	108.000MHz	●
		75.025Hz	79.976kHz	135.000MHz	●

Media Player Supported Format

Media Player	Media Format	File Extension	Video/Audio codec	USB	DMS	Note
Photo	JPEG	.jpg .jpeg	JPEG	Yes	Yes	<p><USB> Data compatibility: JPEG Exif ver 2.2 Maximum viewable resolution: 4096 x 4096 (HW decode) 16384 x 16384 (SW decode) Maximum photo size: 9MB Maximum number of files: 2000 / folder <DMS> Data compatibility: JPEG EXIF Ver.1.x or later, JFIF 1.02a Maximum photo resolution: 4096 x 4096 Maximum photo size: 6 MB Maximum number of files: 2000 / folder</p>
Movie	MPEG-2 PS MPEG-2 TS	.mpg .mpeg .ts	Video) MPEG-1 Video	Yes	No	<p><USB> Maximum number of files: 2000 / folder <DMS> Maximum number of files: 2000 / folder</p> <p>*) Some files may not be played. *) Normal playing and trick playing may not be available depending on the contents. *) DivX external subtitles are not supported.</p>
			Video) MPEG-2 Video H.264(MPEG-4 AVC)	Yes	Yes	
			Audio) MPEG-1 Layer1 MPEG-1 Layer2 MPEG-2 Layer2 Dolby Digital (AC-3) L-PCM (MPEG-2 PS only)	Yes	Yes	
			Audio) Dolby Digital Plus AAC HE AAC	Yes	No	
	MP4	.mp4 .m4v	Video) H.264(MPEG-4 AVC)	Yes	Yes	
			Audio) AAC	Yes	Yes	
			Audio) HE AAC Dolby Digital (AC-3) Dolby Digital Plus	Yes	No	
	AVI DivX DivX Plus HD	.avi .divx .div	Video) DivX (3,4,5,6)	Yes	No	
			Audio) Dolby Digital (AC-3) MPEG-1 Layer2 MPEG-1 Layer3	Yes	No	
	MKV DivX Plus HD	.mkv	Video) H.264	Yes	No	
Audio) AAC HE AAC Dolby Digital (AC-3) MPEG-1 Layer 3			Yes	No		
AVCHD	.mts .m2ts	Video) H.264(MPEG-4 AVC)	Yes	Yes		
		Audio) Dolby Digital (AC-3)	Yes	Yes		
Music	MP3	.mp3	Audio) MPEG-1 Audio Layer-3 MPEG-2 Audio Layer-3 MPEG-2.5 Audio Layer-3	Yes	Yes	<p><USB> Maximum number of files: 2000 / folder <DMS></p>
	MP4	.mp4 .m4a	Audio) AAC	Yes	No	<p>Maximum number of files: 2000 / folder</p> <p>*) Some files may not be played.</p>
			Audio) HE AAC	Yes	No	
L-PCM			Audio) L-PCM	No	Yes	

Specifications and accessories

Receiving systems

DVB-T Broadcast systems/channels		Broadcast systems/channels	
UK	UHF 21-68	PAL-I	UHF UK21-UK69
France	VHF 05-10 (VHF 01-05) UHF 21-69	PAL-B/G	UHF E21-E69 VHF E2-E12, S1-S41
Germany	VHF 05-12 UHF 21-69	SECAM-L	UHF F21-F69 VHF F1-F10, B-Q
Austria	VHF 05-12 UHF 21-69	SECAM-D/K	UHF R21-R69 VHF R1-R12
Switzerland	VHF 05-12 UHF 21-69		
Italy	VHF 05-12 (D,E,F,G,H,H1,H2) UHF 21-69		
Spain	UHF 21-69		
Nederlands	VHF 05-12 UHF 21-69		
Greece	VHF 05-12 UHF 21-69		

DVB-C Broadcast systems

DVB-S/DVB-S2 Broadcast systems

Video Input PAL, SECAM, NTSC 3.58/4.43

External connections

EXT 1	Input/Output	21-pin SCART	RGB, A/V input AV out, TV out
EXT 2	Input	Phono jacks Phono jacks	Y, P _B /C _B , P _R /C _R Audio L + R
EXT 3	Input	Phono jacks	Video/Audio L + R
HDMI 1/2/3/4	Input	HDMI® compliant HDCP compliant (Enable Content Type, INSTAPORT™, RGB Range, supported)	
PC	Input	Mini D-sub 15-pin	Analog RGB signal
PC/HDMI 3	Audio input	3.5mm mini jack	Audio
Digital Audio Output (S/PDIF)		Optical	
LAN port		RJ-45	
USB 1/USB 2 port		Media Player Interface version: USB 2.0 USB class: Mass Storage File system: FAT16 and FAT32	
USB 2 port		Wireless LAN adaptor ready for a home network, IEEE802.11a/b/g/n compatible (for SL86 series) USB HDD connection ready (for UL86/ UL87 series)	
Headphone socket		3.5mm stereo	
Stereo		Nicam 2 carrier system	
Visible Screen Size (approx.)	Model	32 37 42 46	80cm 94cm 107cm 117cm

Display

Sound output
(at 10% distortion) 10W + 10W

Power consumption

(approx.)	32SL 37SL 42SL 46SL	103W 107W 135W 147W
	32UL 37UL 42UL 46UL	107W 111W 139W 151W
Annual power consumption* (approx.)	32SL 37SL 42SL 46SL	94.8kWh 100.9kWh 131.4kWh 142.4kWh
	32UL 37UL 42UL 46UL	97.1kWh 103.2kWh 133.7kWh 144.7kWh
On mode power consumption** (approx.)	32SL 37SL 42SL 46SL	64.9W 69.1W 90.0W 97.5W
	32UL 37UL 42UL 46UL	66.5W 70.7W 91.6W 99.1W

Standby power consumption

(approx.)	32SL/37SL 42SL/46SL 32UL/37UL 42UL/46UL	0.3W 0.2W 0.3W 0.2W
-----------	--	------------------------------

* Operating 4 hours a day and 365 days a year.

** Tested in accordance with IEC 62087-BD Ed. 2.0:2008.

Dimensions

(approx.)	32SL/32UL 37SL/37UL 42SL/42UL 46SL/46UL	53cm (H) 59cm (H) 68cm (H) 73cm (H)	75cm (W) 87cm (W) 99cm (W) 108cm (W)	26cm (D) 26cm (D) 29cm (D) 29cm (D)
-----------	--	--	---	--

(Height dimension includes foot stand)

Weight (approx.)

	32SL/32UL 37SL/37UL 42SL/42UL 46SL/46UL	13.0kg 15.0kg 20.5kg 22.5kg
--	--	--------------------------------------

Operating condition

Temperature 5°C - 35°C (41°F - 94°F)

Humidity 20 - 80% (non-condensing)

Wireless connection

- Standard: IEEE 802.11a/b/g/n
- Frequency Range: 5.15-5.35 GHz, 5.47-5.725 GHz, 5.725-5.850 GHz, 2.400-2.4835 GHz
- Security: WEP64/128, TKIP, AES, WPA/WPA2-PSK, WPS, None

Supplied accessories

- Remote control CT-90369 (SL86 series)
2 batteries (AA, IEC R6 1.5V)
- Remote control CT-90382 (UL86/UL87 series)
2 batteries (AAA, IEC R03 1.5V)
- 'P' Clip/Screw (for TV mounting)
See page 5.

Optional accessories

- TOSHIBA Dual Band WLAN Adaptor WLM-10U2 (for SL86 series)
- USB HDD (for UL86/UL87 series)
For available USB HDD, see "Product Information" on the website.

Specification is subject to change without notice.



EU Ecolabel : PL/22/002

For those products that have been awarded the European Eco Label, TOSHIBA gives a minimum of 2 years guarantee for this LCD TV and 7 years availability for replacement of electronic parts. For warranty repairs, please contact the retailer where you purchased the product. Please see the Toshiba website or European Eco Label website (www.ecolabel.eu) for details of those products.

© TOSHIBA Television Central Europe Sp. z o.o.

All rights reserved.

Reproduction in whole or part without written permission is strictly prohibited.

TOSHIBA Television Central Europe Sp. z o.o.

ul. Pokoju 1, Biskupice Podgórne, 55-040 Kobierzyce, Poland