

# TOSHIBA

Leading Innovation >>>

**RL93\* Digital Series**  
**RL95\* Digital Series**

## > SUPPORT



PLEASE VISIT:  
[WWW.TOSHIBA.CO.UK/TV-DVD-SUPPORT](http://WWW.TOSHIBA.CO.UK/TV-DVD-SUPPORT)



OR CONTACT THE TOSHIBA CUSTOMER  
HELPLINE ON **0844 856 0730**

Register your TV online at  
[www.toshiba.co.uk/registration](http://www.toshiba.co.uk/registration)



# Contents

## INSTALLING YOUR TV

Safety Precautions .....	4
Installation and important information .....	5
The remote control (CT-90404) .....	7
Inserting batteries and effective range .....	7
The remote control (CT-90420) .....	8
Inserting batteries and effective range .....	8

## CONNECTING YOUR TV

Connecting external equipment .....	9
Connecting an HDMI® device .....	10
To connect an HDMI device .....	10
HDMI's ARC (Audio Return Channel) feature .....	10
REGZA-LINK connection .....	11
Connecting a computer .....	12
To connect a PC to the RGB/PC terminal .....	12
To connect a PC to the HDMI terminal .....	12
Connecting a home network .....	13
To connect the TV to a home network - Wired .....	13
To connect the TV to a home network with an internet connection - Wireless .....	13
To connect the TV to the Intel® Wireless Display ready PC .....	13
Controls and input connections .....	14
Switching on .....	14
Using the menu system .....	14
Using the TV controls and connections .....	14
MENU structure .....	15

## SETTING UP YOUR TV

Startup Application .....	16
Quick Setup .....	16
Ant/Cable In (if available) .....	18
Auto Tuning .....	19
ATV Manual Tuning .....	20
Tuning .....	20
Skip .....	21
Sorting positions .....	22
DTV Manual Tuning .....	22
Manual Tuning .....	22
Manual Tuning for DVB-C .....	23
DTV Settings .....	23
Channels .....	23
Standby Channel Update .....	24
Location setting .....	24
<b>Analogue</b> switch-off .....	24

## CONTROLS AND FEATURES

General controls .....	25
Quick Menu .....	25
Selecting channels .....	25
The Time Display – <b>analogue</b> only .....	25
Stereo and Bilingual transmissions .....	25
Sound controls .....	26
Volume controls and sound mute .....	26

Dual .....	26
Balance .....	26
Bass, Treble .....	26
Voice Enhancement .....	26
Dynamic Bass Boost .....	26
Stable Sound® .....	26
Dynamic Range Control .....	26
Audio Level Offset .....	27
TV Speakers On/Off .....	27
Headphone Settings .....	27
Audio Description .....	27
Widescreen viewing .....	28
Picture controls .....	30
Picture Mode .....	30
Picture preferences .....	30
Reset .....	30
ColourMaster .....	30
Base Colour Adjustment .....	31
Colour Temperature .....	31
Auto Brightness Sensor .....	31
Active Backlight Control .....	31
Black/White Level .....	31
MPEG NR – Noise Reduction .....	31
Cinema Mode .....	32
Resetting the advanced picture settings .....	32
Automatic Format (Widescreen) .....	32
4:3 Stretch .....	32
DNR – Digital Noise Reduction .....	32
Blue Screen .....	32
Picture Position .....	32
Picture still .....	32
Using your home network .....	33
Setting up the Network .....	34
Wireless Setup .....	34
Advanced Network Setup .....	36
DNS Setup .....	37
Network Connection Test .....	37
Using the software keyboard .....	38
Network Device Setup .....	38
External Control Setup .....	38
Device Name Setup .....	39
USB HDD Record Function .....	40
Setting up the USB HDD for recording .....	40
To record DTV programmes (One Touch Recording) .....	40
How to set recordings via the Programme Guide .....	41
To check, edit or delete scheduling information .....	42
To view a recorded programme .....	43
Operations from the Library screen .....	43
Recording Setup .....	44
Scheduling priority .....	46
Using Toshiba Places .....	47
Using Hybrid TV Standard (if available) .....	47
Using Intel® Wireless Display .....	48
Intel® Wireless Display Device Name .....	48
PC List .....	48
Using the Media Player .....	49
Basic operation .....	49

Viewing photo files (on a DLNA CERTIFIED™ Server or USB device) .....	50	Software Licences .....	64
Viewing movie files (on a DLNA CERTIFIED™ Server or USB device) .....	52	System Information and Reset TV .....	65
Playing music files (on a DLNA CERTIFIED™ Server or USB device) .....	55	System Information .....	65
Other features .....	56	Reset TV .....	65
Panel Lock .....	56	PC Settings .....	65
The timers .....	56	Horizontal and Vertical Position .....	65
Programme Timers – <b>digital</b> only .....	56	Clock Phase .....	65
On Timer .....	57	Reset .....	66
Sleep Timer .....	57	Sampling Clock .....	66
Energy Saving Settings .....	58	Input selection and AV connections .....	66
Automatic Power Down .....	58	Input selection .....	66
No Signal Power Down .....	58	Digital Audio Output .....	67
Digital on-screen information .....	58	Labeling video input sources .....	67
Information .....	58	Using REGZA-LINK .....	68
Using EPG (Electronic Programme Guide) .....	59	Enable REGZA-LINK .....	68
Using Broadcast Guide .....	59	TV Auto Power .....	68
Genre selection/searching .....	60	Auto Standby .....	68
Using MediaGuide .....	60	Amplifier Control .....	68
MediaGuide screen .....	60	Initial Speaker Setting .....	68
Primary Navigation menu .....	60	REGZA-LINK input source selection .....	68
<b>Digital</b> settings – parental control .....	61	REGZA-LINK one touch play .....	69
Parental PIN Setup .....	61	REGZA-LINK system standby .....	69
Parental Setup .....	62		
Network Lock .....	62	<b>TEXT SERVICES</b>	
<b>Digital</b> settings – Channel Options .....	62	Text services .....	70
Selecting favourite channels .....	62	Selecting modes .....	70
Favourite Channel Lists .....	62	Text information .....	70
Skip channels .....	63	Navigating pages using Auto .....	70
Locking channels .....	63	Navigating pages using LIST .....	70
<b>Digital</b> settings – other settings .....	63	Control buttons .....	71
Subtitles .....	63		
Audio languages .....	63	<b>PROBLEM SOLVING</b>	
Common Interface .....	64	Questions and Answers .....	72
Software Upgrade and Licences .....	64		
Searching for New Software .....	64	<b>INFORMATION</b>	
Network Upgrade .....	64	License Information .....	75
		Information .....	77
		Specifications and accessories .....	81

During the life of your TV firmware updates will be made available to ensure that your TV maintains optimum performance:

**USB HDD Recording** is supported on this TV, if this functionality is not implemented at time of purchase it will be made available via firmware update in mid 2012.

*\*Please note the USB HDD recording feature will not be available in all countries.*

**Intel® Wireless Display (Intel® WiDi)** is supported on this TV, if this functionality is not implemented at time of purchase it will be made available via firmware update in mid 2012.

If your TV is connected to the internet, firmware will be automatically made available.

If your TV is not connected to the internet, you can download the latest version of firmware from [www.toshiba-om.net/firmware.php](http://www.toshiba-om.net/firmware.php)

*\*Some features are limited due to local legislation and may not be available in all countries*

## Safety Precautions

This equipment has been designed and manufactured to meet international safety standards but, like any electrical equipment, care must be taken to obtain the best results and for safety to be assured. Please read the points below for your own safety. They are of a general nature, intended to help with all electronic consumer products, and some points may not apply to the goods you have just purchased.

### Air Circulation

Leave more than 10cm clearance around the television to allow adequate ventilation. This will prevent overheating and possible damage to the television. Dusty places should also be avoided.

### Heat Damage

Damage may occur if the television is left in direct sunlight or near a heater. Avoid places subject to extremely high temperatures or humidity. Place in a location where the temperature remains between 5°C min. and 35°C max.

### Mains Supply

The mains supply required for this equipment is 220-240v AC 50/60Hz. Never connect to a DC supply or any other power source. DO ensure that the television is not standing on the mains lead. Use only the supplied lead.

DO NOT cut off the mains plug from this equipment, this incorporates a special Radio Interference Filter, the removal of which will impair its performance. In the UK, the fuse fitted in the plug is approved by ASTA or BSI to BS1362. It should only be replaced by a correctly rated and approved type and the fuse cover must be refitted.  
IF IN DOUBT, PLEASE CONSULT A COMPETENT ELECTRICIAN.

### Do

**DO** read the operating instructions before you attempt to use the equipment.

**DO** ensure that all electrical connections (including the mains plug, extension leads and inter-connections between pieces of equipment) are properly made and in accordance with the manufacturers' instructions. Switch off and withdraw the mains plug before making or changing connections.

**DO** consult your dealer if you are ever in doubt about the installation, operation or safety of your equipment.

**WARNING:** To prevent injury, this apparatus must be securely attached to the floor/wall in accordance with the installation instructions. See page 5.

**DO** be careful with glass panels or doors on equipment.

**DO NOT REMOVE ANY FIXED COVERS AS THIS WILL EXPOSE DANGEROUS AND 'LIVE' PARTS.**

**THE MAINS PLUG IS USED AS A DISCONNECTING DEVICE AND THEREFORE SHOULD BE READILY OPERABLE.**

### Do not

**DO NOT** obstruct the ventilation openings of the equipment with items such as newspapers, tablecloths, curtains, etc. Overheating will cause damage and shorten the life of the equipment.

**DO NOT** allow electrical equipment to be exposed to dripping or splashing or objects filled with liquids, such as vases, to be placed on the equipment.

**DO NOT** place hot objects or naked flame sources, such as lighted candles or nightlights on, or close to equipment. High temperatures can melt plastic and lead to fires.



**WARNING:** To prevent the spread of fire, keep candles or other open flames away from this product at all times.

**DO NOT** use makeshift stands and NEVER fix legs with wood screws. To ensure complete safety, always fit the manufacturer's approved stand, bracket or legs with the fixings provided according to the instructions.

**DO NOT** leave equipment switched on when it is unattended, unless it is specifically stated that it is designed for unattended operation or has a standby mode. Switch off by withdrawing the plug, and make sure your family knows how to do this. Special arrangements may need to be made for people with disabilities.

**DO NOT** continue to operate the equipment if you are in any doubt about it working normally, or it is damaged in any way – switch off, withdraw the mains plug and consult your dealer.

**WARNING:** Excessive sound pressure from earphones or headphones can cause hearing loss.

**ABOVE ALL - NEVER let anyone, especially children, push or hit the screen and cabinet back, or push anything into holes, slots or any other openings in the case. These actions will damage screen or internal parts.**

**NEVER guess or take chances with electrical equipment of any kind - it is better to be safe than sorry.**

# Installation and important information

## Where to install

Locate the television away from direct sunlight and strong lights. Soft, indirect lighting is recommended for comfortable viewing. Use curtains or blinds to prevent direct sunlight falling on the screen.

**Place the TV on a stable, level surface that can support the weight of the TV. In order to prevent injury and maintain stability of this apparatus, secure the TV to the level surface using the strap if fitted, or to a wall using a sturdy tie to the P clips provided. Otherwise secure the TV on the level surface using the supplied mounting screw.**

The LCD display panels are manufactured using an extremely high level of precision technology; however, sometimes some parts of the screen may be missing picture elements or have luminous spots. This is not a sign of a malfunction.

Make sure the television is located in a position where it cannot be pushed or hit by objects, as pressure will break or damage the screen. Also, please be certain that small items cannot be inserted into slots or openings in the case.

 Avoid using chemicals (such as air refreshers, cleaning agents, etc.) on or near the TV pedestal. Studies indicate that plastics may weaken and crack over time from the combination effects of chemical agents and mechanical stress (such as weight of TV). Failure to follow these instructions could result in serious injury and/or permanent damage to TV and TV pedestal.

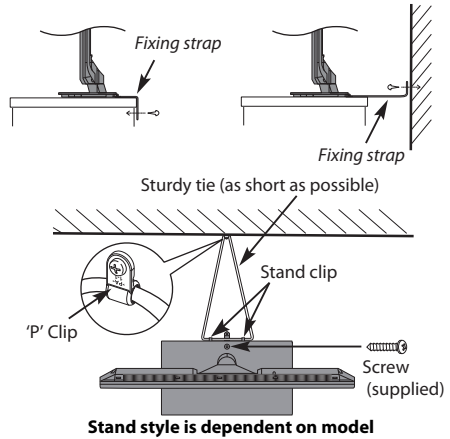

## When using a Wall Bracket

Please use a wall bracket appropriate for the size and weight of the LCD TV.

- Two people are required for installation.
- To install a wall-mount from another manufacturer, use the **SPACERS** (supplied).

- 1 Unplug and remove any cables and/or other component connectors from the rear of the TV.
- 2 Carefully lay the front of the unit face down on a flat, cushioned surface such as a quilt or blanket.
- 3 Follow the instructions provided with your wall bracket. Before proceeding, make sure the appropriate bracket(s) are attached to the wall and the back of the TV as described in the instructions provided with the wall bracket.
- 4 Make sure to place the spacers supplied between the bracket and the back of the TV.
- 5 Always use the screws supplied or recommended by the wall mount manufacturer.

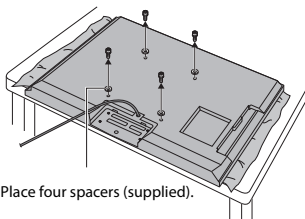

## Removing the Pedestal Stand:

- 1 Carefully lay the front of the unit face down on a flat, cushioned surface such as a quilt or blanket. Leave the stand protruding over the edge of the surface.  
**NOTE:** Extreme care should always be used when removing the pedestal stand to avoid damage to the LCD panel.

- 2 Remove the four screws.

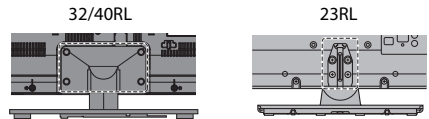

- 3 Once you have removed all four screws holding the pedestal stand in place, remove the pedestal stand from the TV by sliding the pedestal stand away from the TV.

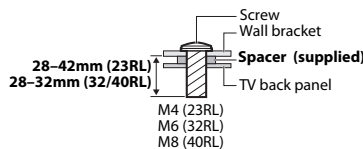

**CAUTION:** The diameter and length of the screws differ depending on wall bracket model. Use of screws other than the screws specified may result in internal damage to the TV set or cause it to fall, etc.

### Please take note

The digital reception function of this television is only effective in the countries listed in the "Country" section of the "System Setup" menu. Depending on country/area, some of this television's functions may not be available. Reception of future additional or modified services can not be guaranteed with this television.

If stationary images generated by 4:3 broadcasts, text services, channel identification logos, computer displays, video games, on-screen menus, etc. are left on the television screen for any length of time, they could become conspicuous. It is always advisable to reduce both the brightness and contrast settings.

Very long, continuous use of the 4:3 picture on a 16:9 screen may result in some retention of the image at the 4:3 outlines. This is not a defect of the LCD TV and is not covered under the manufacturer's warranty. Regular use of other size modes (e.g.: Super Live) will prevent permanent retention.

### EXCLUSION CLAUSE

Toshiba shall under no circumstances be liable for loss and/or damage to the product caused by:

- i) Fire;
- ii) Earthquake;
- iii) Accidental damage;
- iv) Intentional misuse of the product;
- v) Use of the product in improper conditions;
- vi) Loss and/or damage caused to the product whilst in the possession of a third party;
- vii) Any damage or loss caused as a result of the owner's failure and/or neglect to follow the instructions set out in the owner's manual;
- viii) Any loss or damage caused directly as a result of misuse or malfunction of the product when used simultaneously with associated equipment;

Furthermore, under no circumstances shall Toshiba be liable for any consequential loss and/or damage including but not limited to the following: loss of profit, interruption of business, the loss of recorded data whether caused during normal operation or misuse of the product.

### When Using a USB HDD

- **The recording function has been designed for private use and entertainment in your home environment. Please note that any commercial use of the recording function could lead to copyright infringement of authors' rights. Toshiba asks you to respect the intellectual property rights of third parties.**
- **Before recording to a device connected to the TV, make a test recording and check the recording performance.**
- **Programmes that are prohibited from copying due to copyright protection cannot be recorded.**
- **Toshiba shall not be liable for compensation or incidental damages of any kind whatsoever resulting from content that was not properly recorded on the recording device or that was modified or lost.**
- **Toshiba shall not be liable for damages of any kind whatsoever (breakdown of the recording device, modification or loss of the recorded content, etc.) resulting from malfunction, operating failure or incorrect operation due to combining with another connected device.**
- **If you connect a USB HDD that has been used with a PC or another TV, only programmes which are recorded using this TV can be playback.**
- **Turn off the TV power supply before if you disconnect USB HDD.**  
Not doing so may result in loss of the recorded data or malfunction of the USB HDD.
- **Please note that recording on the USB HDD is no longer playable after the TV's main-board is exchanged during service.**

# The remote control (CT-90404)

Simple at-a-glance reference of your remote control.

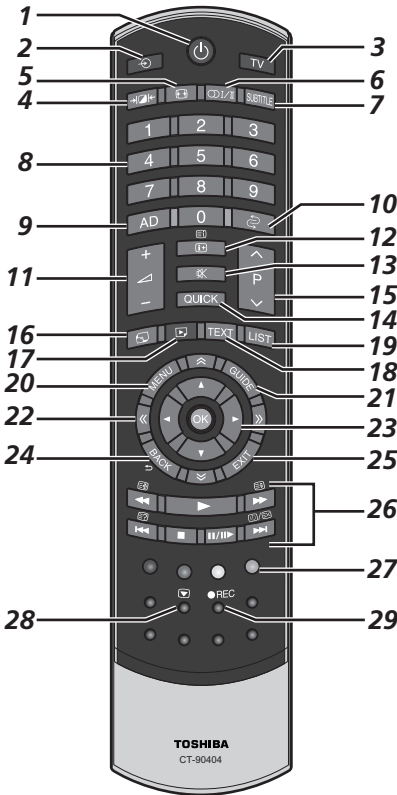

- 1 For On/Standby mode
- 2 To select external input sources
- 3 To select TV Mode (DTV Ant/DTV Cable/ATV)
- 4 Selectable Picture
- 5 Widescreen viewing
- 6 /II Stereo/bilingual transmissions
- 7 Digital Subtitles or Analogue TEXT Subtitle pages if available
- 8 Number buttons
- 9 Switch the Audio Description On/Off
- 10 To return to previous channel
- 11 To alter the TV volume
- 12 To display on-screen information  
To access the index page in Text mode
- 13 To mute the TV sound
- 14 To access Quick Menu
- 15 To change programme positions  
To change TEXT pages

- 16 To access the "TOSHIBA PLACES" Top Page  
When network is not connected, an error message will be displayed.
  - 17 To access Media Player Menu
  - 18 To call up text services
  - 19 To access the analogue or digital Channel List
  - 20 On-screen Menus
  - 21 To display the digital on-screen Programme Guide
  - 22 To page up, down, left or right
  - 23 When using menus, the arrows move the cursor on the screen up, down, left or right. Press **OK** to confirm your selection
  - 24 To return to previous Menu
  - 25 To exit menus and applications
  - 26 **When in TV mode:**  
/EX Analogue time display
  - 27 **Colour buttons:** Text and interactive service control buttons
  - 28 Picture still
  - 29 To record DTV programmes
- |  |   |
|--|---|
| <p><b>When using Programme Guide:</b></p> <ul style="list-style-type: none"> <li> -24 hours</li> <li> +24 hours</li> <li> -1 page</li> <li> +1 page</li> </ul> | <p><b>When in Text mode:</b></p> <ul style="list-style-type: none"> <li> To reveal concealed text</li> <li> To hold a wanted page</li> <li> To enlarge text display size</li> <li>/EX To select a page while viewing a normal picture</li> </ul> <p><b>During Playback:</b></p> <ul style="list-style-type: none"> <li> To PLAY</li> <li> To STOP</li> <li> To PAUSE/STEP</li> <li> To SKIP-BACK</li> <li> To REWIND</li> <li> To FAST FORWARD</li> <li> To SKIP-FORWARD</li> </ul> |
|--|---|

## Inserting batteries and effective range

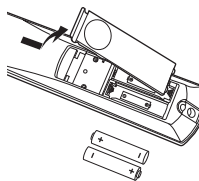

Remove the back cover to reveal the battery compartment and make sure the batteries are inserted the proper way. Suitable battery types for this remote are AA, IEC R6 1.5V.

Do not combine a used, old battery with a new one or mix battery types. Remove dead batteries immediately to prevent acid from leaking into the battery compartment. Dispose of them in accordance with instructions on page 76 of this manual.

**Warning:** Batteries must not be exposed to excessive heat such as sunshine, fire or the like.

The performance of the remote control will deteriorate beyond a distance of five metres or outside an angle of 30 degrees from the centre of the television. If the operating range becomes reduced, the batteries may need replacing.

# The remote control (CT-90420)

Simple at-a-glance reference of your remote control.

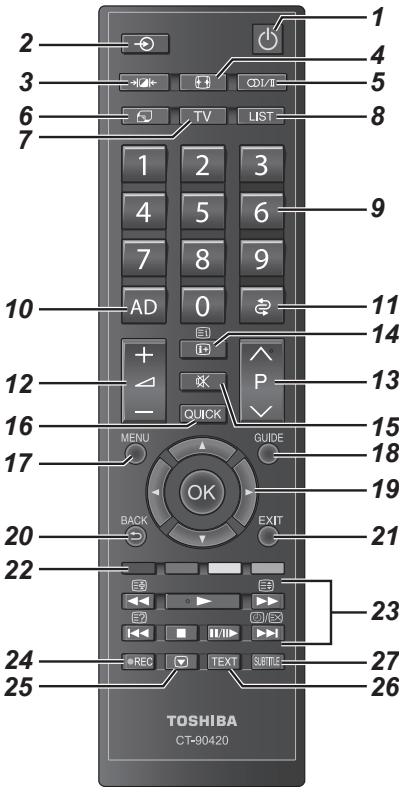

- 1 For On/Standby mode
- 2 To select external input sources
- 3 Selectable Picture
- 4 Widescreen viewing
- 5  $\text{O} \text{I} / \text{II}$  Stereo/bilingual transmissions
- 6 To access the "TOSHIBA PLACES" Top Page  
When network is not connected, an error message will be displayed.
- 7 To select TV Mode (DTV Ant/DTV Cable/ATV)
- 8 To access the analogue or digital Channel List
- 9 Number buttons
- 10 Switch the Audio Description On/Off
- 11 To return to previous channel
- 12 To alter the TV volume
- 13 To change programme positions  
To change TEXT pages
- 14 To display on-screen information  
To access the index page in Text mode

- 15 To mute the TV sound
- 16 To access Quick Menu
- 17 On-screen Menus
- 18 To display the digital on-screen Programme Guide
- 19 When using menus, the arrows move the cursor on the screen up, down, left or right. Press **OK** to confirm your selection
- 20 To return to previous Menu
- 21 To exit menus and applications
- 22 **Colour buttons:** Text and interactive service control buttons
- 23 **When in TV mode:**
  - $\text{O} / \text{EX}$  Analogue time display
- When in Text mode:**
  - $\text{E} ?$  To reveal concealed text
  - $\text{E} \times$  To hold a wanted page
  - $\text{E} \text{A}$  To enlarge text display size
  - $\text{O} / \text{EX}$  To select a page while viewing a normal picture
- When using Programme Guide:**
  - $\text{II} \text{II}$  -24 hours
  - $\text{II} \text{II} \text{II}$  +24 hours
  - $\text{II} \text{II} \text{II} \text{II}$  -1 page
  - $\text{II} \text{II} \text{II} \text{II} \text{II}$  +1 page
- During Playback:**
  - $\blacktriangleright$  To PLAY
  - $\blacksquare$  To STOP
  - $\text{II} \text{II} \text{II} \text{II} \text{II}$  To PAUSE/STEP
  - $\text{II} \text{II} \text{II} \text{II}$  To SKIP-BACK
  - $\text{II} \text{II} \text{II} \text{II}$  To REWIND
  - $\text{II} \text{II} \text{II} \text{II} \text{II}$  To FAST FORWARD
  - $\text{II} \text{II} \text{II} \text{II}$  To SKIP-FORWARD
- 24 To record DTV programmes
- 25 Picture still
- 26 To call up text services
- 27 Digital Subtitles or Analogue TEXT Subtitle pages if available

## Inserting batteries and effective range

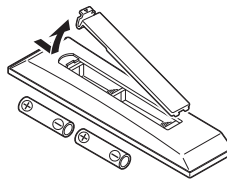

Remove the back cover to reveal the battery compartment and make sure the batteries are inserted the proper way. Suitable battery types for this remote are AAA, IEC R03 1.5V.

Do not combine a used, old battery with a new one or mix

battery types. Remove dead batteries immediately to prevent acid from leaking into the battery compartment. Dispose of them in accordance with instructions on page 76 of this manual.

**Warning:** Batteries must not be exposed to excessive heat such as sunshine, fire or the like.

The performance of the remote control will deteriorate beyond a distance of five metres or outside an angle of 30 degrees from the centre of the television. If the operating range becomes reduced, the batteries may need replacing.



## Connecting external equipment

**Before connecting any external equipment, turn off all main power switches. If there is no switch, remove the mains plug from the wall socket.**

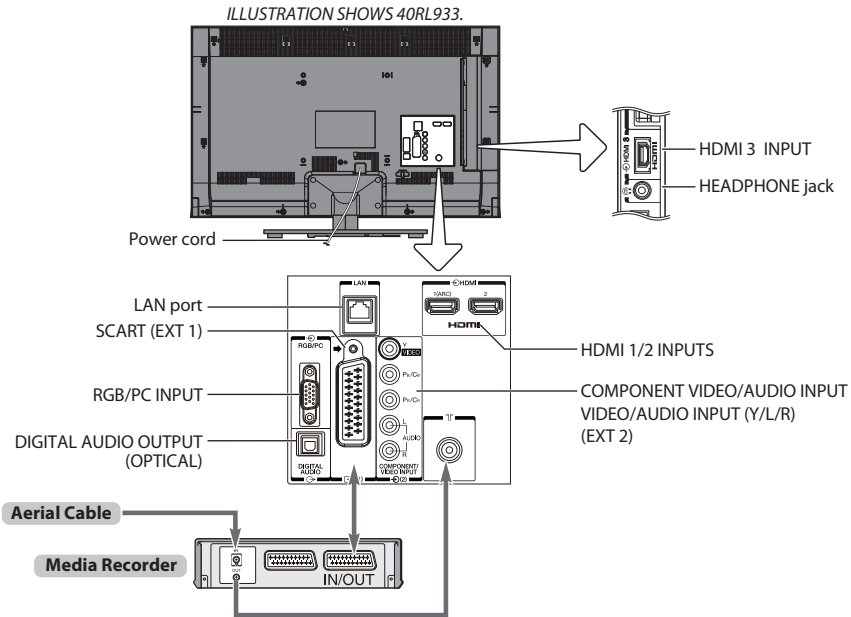

### Aerial cables:.....

Connect the aerial to the socket on the rear of the television. If you use a decoder and/or a media recorder, it is essential that the aerial cable is connected through the decoder and/or through the media recorder to the television.

### SCART leads:.....

Connect the media recorder **IN/OUT** socket to the television. Connect the decoder **TV** socket to the television.

Before running **Auto Tuning**, put your decoder and media recorder to **Standby**.

The RCA sockets alongside the **COMPONENT VIDEO INPUT** sockets will accept L and R audio signals.

When connecting the VIDEO/AUDIO devices, connect those cables to **Y/L/R** sockets.

The Digital Audio Output socket enables the connection of a suitable surround sound system.

**NOTE: This output is always active.**

HDMI® (High-Definition Multimedia Interface) is for use with a DVD decoder or electrical equipment with digital audio and video output. For acceptable video or PC signal formats through the HDMI terminals, see page 78.

**NOTE:** Although this television is able to connect to HDMI equipment, it is possible that some equipment may not operate correctly.

**LAN** port is used to connect the TV to your home network. This TV can play digital content stored on a DLNA CERTIFIED™ product with server function.

**A wide variety of external equipment can be connected to the back of the television; therefore, the relevant owner's manuals for all additional equipment must be referred to for exact instructions.**

If the television automatically switches over to monitor external equipment, return to normal television by pressing the desired programme position button. To recall external equipment, press **TV** to select between **TV**, **EXT 1**, **EXT 2**, **HDMI 1**, **HDMI 2**, **HDMI 3** or **PC**.

When the external input mode is selected while viewing DTV mode, the SCART socket does not output video/audio signals.

## Connecting an HDMI® device

The HDMI input on your television receives digital audio and uncompressed digital video from an HDMI source device.

This input is designed to accept HDCP (High-Bandwidth Digital-Content Protection) programme material in digital form from EIA/CEA-861-D-compliant consumer electronic devices (such as a set-top box or DVD player with HDMI output). For acceptable video signal formats, see page 78.

**NOTE:** Supported Audio format: Linear PCM, Dolby Digital (AC-3), sampling rate 32/44.1/48kHz.

### To connect an HDMI device

Connect an HDMI cable (type A connector) to the HDMI terminal.

For proper operation, it is recommended that you use an HDMI cable with the HDMI Logo (HDMI™).

- If your HDMI connection is capable of 1080p and/or your television is capable of refresh rates greater than 50Hz, you will need a Category 2 cable. Conventional HDMI/DVI cable may not work properly with this model.
- HDMI cable transfers both video and audio. Separate analogue audio cables are not required (see illustration).

#### the back of your television

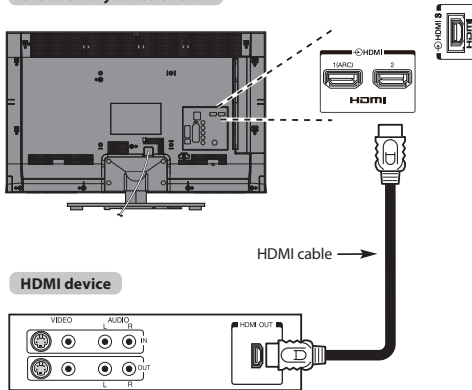

To view the HDMI device video, press the  button to select HDMI 1, HDMI 2 or HDMI 3 mode.

### HDMI's ARC (Audio Return Channel) feature

This feature enables the audio signal of the TV to be sent to the AV amplifier via the HDMI cable. It will not be necessary to connect a cable from the audio output of the TV to the audio input of the AV amplifier to reproduce the audio received from the tuner of the TV through the AV amplifier.

#### the back of your television

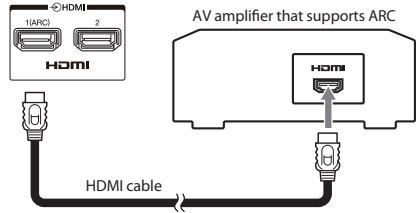

## REGZA-LINK connection

You can control the basic functions of connected audio/video devices using the television's remote control if you connect a REGZA-LINK compatible AV amplifier or playback device. For an explanation of setup and operations, see pages 68–69.

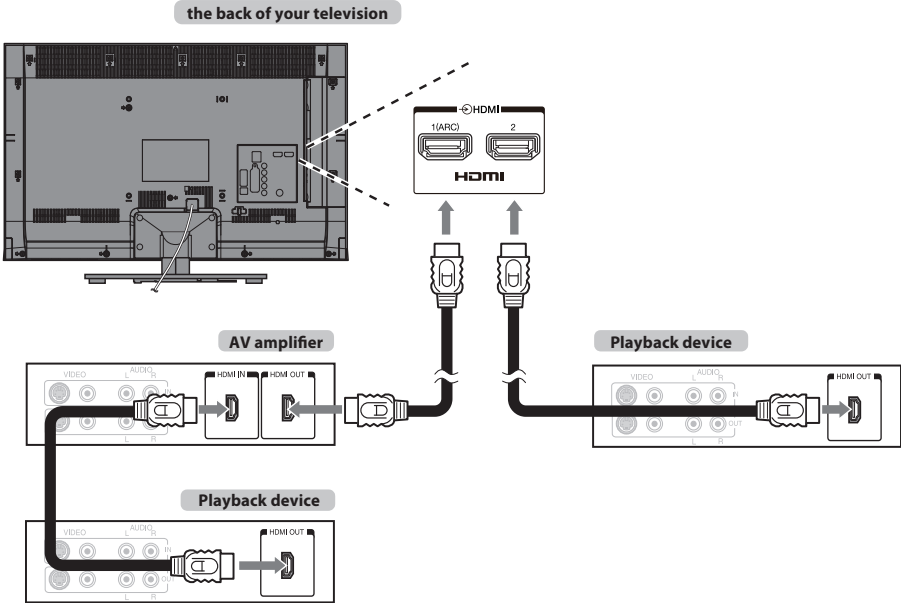

For the setup shown above, you will need three HDMI cables.

### NOTE:

- If several devices are connected, the REGZA-LINK feature may not operate properly.
- For proper operation, it is recommended that you use HDMI cables with the HDMI Logo (  ).
- This function is available when one PC and one AV amplifier are connected separately. However, it may not operate properly if the PC is connected via the AV amplifier.

### Before controlling the device(s):

- After completing the above connections, set the REGZA-LINK Setup menu as you desire (see page 68).
- The connected devices must also be set. For details, see the operation manual for each device.
- The REGZA-LINK feature uses CEC technology as regulated by the HDMI standard.
- This feature is limited to models incorporating Toshiba's REGZA-LINK. However, Toshiba is not liable for those operations. Refer to individual instruction manuals for compatibility information.

## Connecting a computer

With either an RGB/PC or an HDMI connection, you can watch your computer's display on the television.

### To connect a PC to the RGB/PC terminal

When connecting a PC to the RGB/PC terminal on the television, use an analogue RGB (15-pin) computer cable.

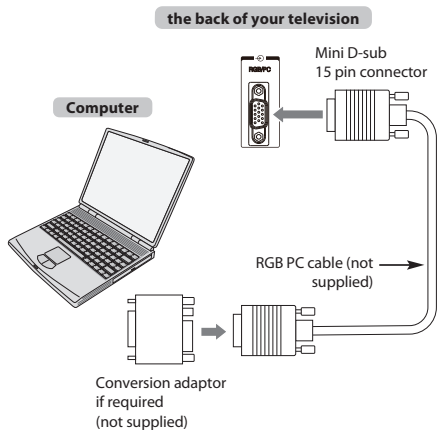

To use a PC, set the monitor output resolution on the PC before connecting it to the television. For acceptable PC signal formats, see page 77.

To display the optimum picture, use the PC setting feature (see page 65).

#### NOTE:

- Some PC models cannot be connected to this television.
- An adaptor is not needed for computers with a compatible mini D-sub15-pin terminal.
- Depending on the DVD's title and the specifications of the PC on which you are playing the DVD-Video, some scenes may be skipped or you may not be able to pause during multi-angle scenes.
- A band may appear at the edges of the screen or parts of the picture may be obscured. This is due to scaling of the picture by the set, it is not a malfunction.
- When PC input mode is selected, some of the television's features will be unavailable e.g. **Colour System** in the **System Setup** menu.
- Some PC models may output unique signals that the television may be unable to detect (see page 77).
- If connecting a certain PC model with a unique PC signal, the PC signal may not be detected correctly.

### To connect a PC to the HDMI terminal

When connecting a PC to the HDMI terminal on the television, use an HDMI-to-DVI adaptor cable.

If connecting a PC with an HDMI terminal, use an HDMI cable (type A connector).

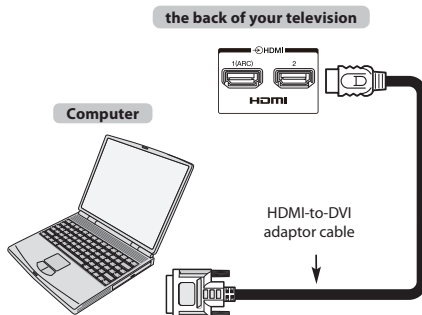

For acceptable PC and video signal formats, see page 78.

#### NOTE:

- The edges of the images may be hidden.
- If connecting a certain PC model with a unique PC signal, the PC signal may not be detected correctly.

## Connecting a home network

The LAN port allows your Toshiba TV to connect to your home network. You can use this revolutionary home entertainment networking system to access photo, video and audio files that are stored on a DLNA CERTIFIED™ server and play/display them on your TV.

### NOTE:

- If you connect to a shared network outside your home, it is advisable to use a router. Always use DLNA CERTIFIED™ products in private network environments. Connect this TV to the same router as other DLNA CERTIFIED™ products (server).
- If you use a hub or switch to connect the TV to your home network, you may not be able to use the automatic setup and will have to manually set up the network address. See page 36.
- If you use a router with built-in DHCP functionality, use the automatic setup. Manual setup may not work.
- If you connect the TV and PC directly, use a crossover LAN cable.
- Please ask PC manufacturer about details of PC settings.
- Wireless appliances may interfere with WiDi function and DTV display.

## To connect the TV to a home network - Wired

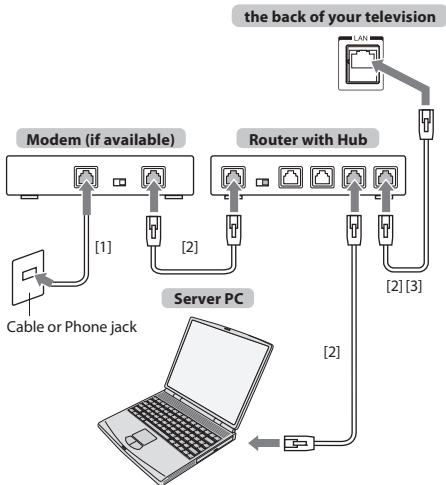

[1] Coaxial or telephone cable (depending on your modem type)

[2] Standard LAN cable

[3] Do NOT connect a phone jack directly to the TV's LAN port.

## To connect the TV to a home network with an internet connection - Wireless

Please refer to "Wireless Setup" section on page 34.

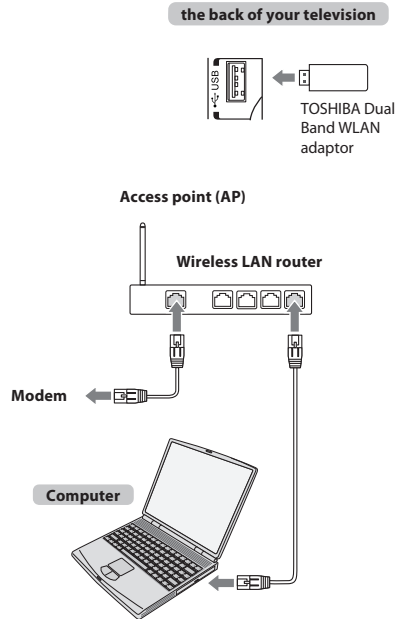

### How to use this Dual Band Wireless LAN Adaptor

- If this device is going to be operated in the frequency range of 5.15 GHz to 5.35 GHz, it is restricted to indoor use.
- If this device is going to be operated for 802.11 b/g/n function in the frequency range of 2.454 GHz to 2.4835 GHz in France, it is restricted to indoor use.
- A general authorization is required for using this device outdoors or in public places in Italy.
- This device is NOT ALLOWED to be used in the geographical area within a radius of 20km from the centre of Ny-Alesund in Norway.

## To connect the TV to the Intel® Wireless Display ready PC

### Intel® Wireless Display ready PC

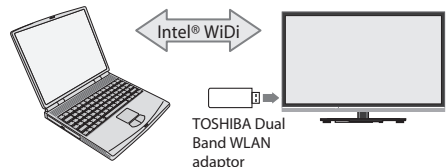

## Controls and input connections

A wide variety of external equipment can be connected to the input sockets on the side of the television. While all the necessary adjustments and controls for the television are made using the remote control, the buttons on the television may be used for some functions.

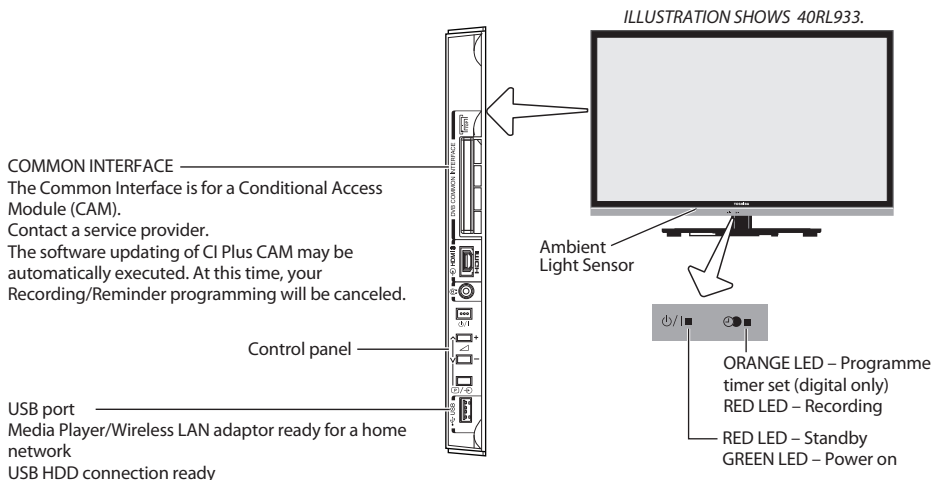

### Switching on

If the RED LED is not lit, check that the mains plug is connected to the power supply and press **⏻** on the remote control; it may take a few moments. The GREEN LED will be lit.

To put the television into Standby, press **⏻** on the remote control. To view the television, press **⏻** again. The picture may take a few seconds to appear.

#### For energy saving:

We recommend that you use the television with the factory settings. The factory settings are for energy saving. Unplugging the mains plug will cut energy use to zero for all televisions. This is recommended when the television is not being used for a long time, e.g. when on holiday. Reducing the brightness of the screen will reduce energy use. Energy efficiency cuts energy consumption and thus saves money by reducing electricity bills.

**NOTE:** Putting the television into standby mode will reduce energy consumption, but will still draw some power.

### Using the menu system

Press **MENU** on the remote control to display the menu.

The menu appears as a list of five topics. As each symbol is selected by pressing **◀** or **▶** on the remote control, its respective options will appear above.

**NOTE:** The same menu is displayed in DTV (Digital TV) and ATV (Analogue TV) modes; however, where some items are not available in a mode, they will appear grayed out.

To use the option, press **▲** and **▼** on the remote control to move up and down and press **◀** or **▶** to select your desired setting.

### Using the TV controls and connections

- To turn on or off the TV, press **⏻/⏻**.
- To alter the volume, press **+** or **-**.  
**+** and **-** buttons operate as volume up/down as default.
- To alter the programme position, press **[P]** / **[⏻]** once and press **▼** or **▲**.
- To select an external input, press and hold **[P]** / **[⏻]** until the **Inputs** window appears, and then press **▼** or **▲** to select the appropriate input source.

The Media Player feature provides access to photo, movie and music files stored on a USB storage device that is connected via the USB port or on a network device.

The USB port also has to be used with the "TOSHIBA Dual Band WLAN Adaptor WLM-20U2" in order to access a wireless network.

You must use the TOSHIBA Wireless LAN device to ensure correct operation of this feature. This feature is available only when the "TOSHIBA Dual Band WLAN Adaptor" is used.

Please always refer to the owner's manual of the equipment to be connected for full details.

#### NOTE:

- The USB socket has limited functionality and Toshiba can take no responsibility for damage to other connected equipment.
- Interactive video games that involve shooting a "gun" at an on-screen target may not work with this TV.

## MENU structure

To open the main menu (illustration below), press **MENU** on the remote control.

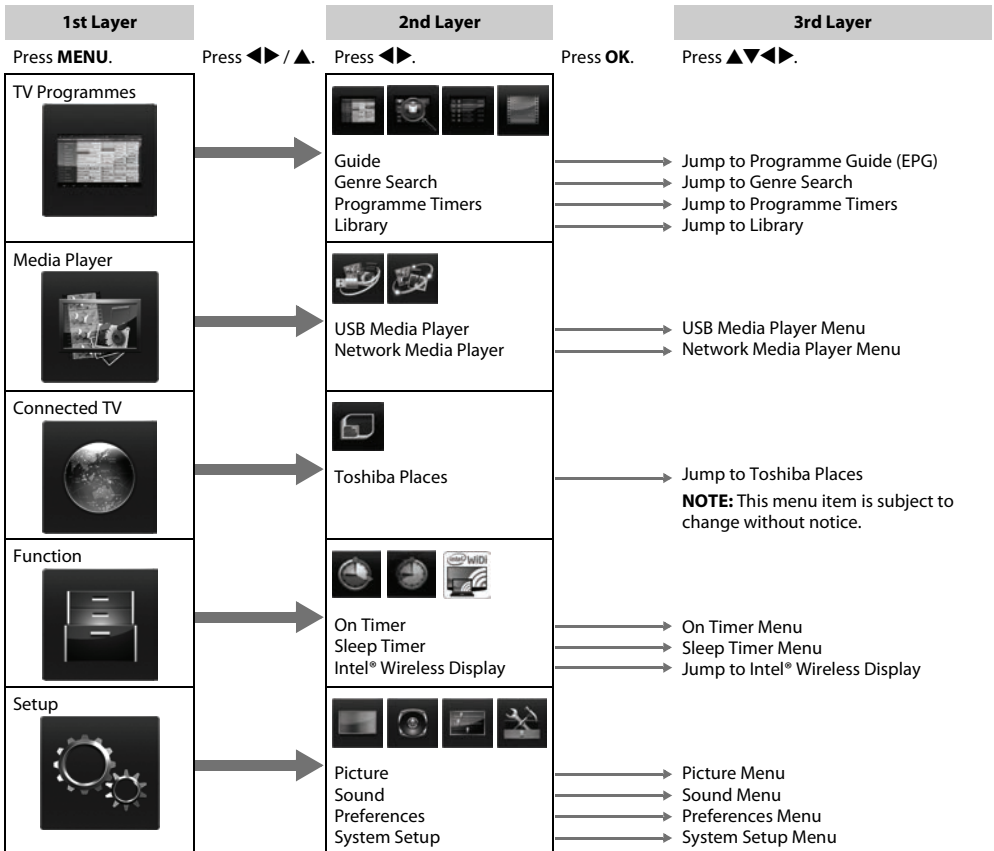
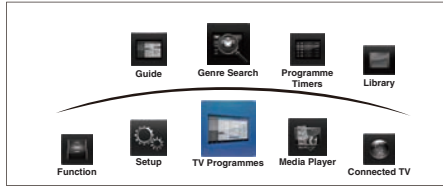

## Startup Application

Before switching on the TV, make sure your decoder/media recorder, if applicable, is in **standby**. To set up the television, use the buttons on the remote control as detailed on page 7.

### Quick Setup

- 1 Press the **OK** button. The **Menu Language** screen will appear. This screen will appear the first time that the television is switched on and each time **Reset TV** is selected.
- 2 Press **▲▼◀▶** to select the menu language and press **OK**.
- 3 Highlight **Country** and press **◀▶** to select. The television is now set to tune the stations for your country.

Quick Setup	
Country	UK
Primary Subtitle Language	English
Secondary Subtitle Language	German
Primary Audio Language	English
Secondary Audio Language	English

#### NOTE:

- The following display menus will differ slightly according to the country you selected.
- If there is not a country that you want to select in the list, select **Others**.

- 4 Press **OK**, and the **Location** screen will appear.

Location	
To use the TV for displaying in a store showroom, please select [Store]. [Home] mode is recommended for normal use.	
	Home

- 5 Press **◀▶** to select **Home** or **Store**. For normal home use, select **Home**.

- 6 Press **OK**, and the **AutoView** screen will appear, press **◀▶** to select **Yes** or **No**.

AutoView	
AutoView mode automatically adjusts picture settings to suit ambient light conditions. Do you wish to enable AutoView mode?	
	No

- 7 Press **OK**, and the **Network Setup** screen will appear. Press **◀▶** to select **Yes** or **No**.

Network Setup	
Do you want to configure network setup?	
	Yes

- When you select **No**, skip to step 15.

- 8 Press **OK**, and the **Network Type** screen will appear. Press **◀▶** to select **Wired** or **Wireless**.

Network Type	
Please select a network type.	
	Wired

- When you select **Wired** (LAN cable connection), skip to step 12.
- When you select **Wireless** (USB WLAN adaptor connection), follow step 9.

**NOTE:** If the USB WLAN adaptor is not connected, **Network Type** screen does not display and skip to step 12.

- 9 Press **OK**, and the **Wireless Setup** screen will appear. Press **◀▶** to select the Wireless Setup type.

- **Assisted Setup** - follow step 10. Input the Security Key only.
- **Manual Setup**, skip to step 11. Input the all settings.

Wireless Setup	
Please select a kind of wireless network.	
	Assisted Setup

**NOTE:** **EXIT** is available during settings.

- 10 In step 9, when you select **Assisted Setup**;

Press **OK**, and the **Assisted Setup** screen will appear. Press **▲▼** to select the desired AP and press **OK**.

**NOTE:** Check the MAC address on the label of the AP or in the manual, and select your AP.

Press **▲▼** to select **Security Key** and press **OK**. The Software Keyboard window will appear (page 38). Input the Security Key by using the Software Keyboard. To save your setting, press the **BLUE** button.

#### NOTE:

- The Security Key must adhere to these conditions:
  - TKIP/AES: 8-63 ASCII or 64 Hex characters
  - WEP: 5 or 13 ASCII or 10 or 26 Hex characters
- There is only one key ID to set for WEP encryption.

Press **▲▼** to highlight **Done** and press **OK**.

#### NOTE:

- If Network Name is not displayed, see Manual Setup below to set Network Name before pressing **Done**.
- If **BACK** is pressed before **Done** is selected, settings are not saved.

When the message "Wireless configuration is complete." appears on screen, press **OK**. The screen will skip to step 12.



**11** In step 9, when you select **Manual Setup**;

Press **OK**, and the **Manual Setup** screen will appear. Press **▲** or **▼** to select **Network Name** and press **OK**. The Software Keyboard window will appear (page 38). Input the Network Name by using the Software Keyboard. To save your setting, press the **BLUE** button.

Press **▲** or **▼** to select **Authentication** and then press **◀** or **▶** to select **Open System, Shared Key, WPA-PSK** or **WPA2-PSK**.

Press **▲** or **▼** to select **Encryption**, and then press **◀** or **▶** to select **None, WEP, TKIP** or **AES**.

**NOTE:**

- Certain encryption types are only compatible with specific authentication types.
  - When Authentication is Open System, only **WEP** or **None** is compatible.
  - When Authentication is Shared Key, only **WEP** is compatible.
  - When Authentication is WPA-PSK or WPA2-PSK, only **TKIP** or **AES** is compatible.
- When incompatible Authentication/Encryption pairings are detected, a warning message will be displayed, and no connection attempt will be made until the incompatibility is resolved.
- There is only one key ID to set for WEP encryption.

Press **▲** or **▼** to select **Security Key** and press **OK**. Input the Security Key by using the Software Keyboard (page 38). To save your setting, press the **BLUE** button. This item is grayed out when **Encryption** is **None**.

When **Encryption** is **WEP**, **Key ID** setting is available. Press **▲** or **▼** to select **Key ID** and press **◀** or **▶** to select **1** (default), **2**, **3** or **4**.

Press **▲** or **▼** to select **Done** and press **OK**. When the message "Wireless configuration is complete." appears on screen, press **OK**.

**NOTE:** Settings are not saved if **BACK** is pressed before **Done** is selected.

**12** The **Advanced Network Setup** screen will appear.

When the DHCP function of the router connected with this TV is On, you can set **Auto Setup** to **On** or **Off**. (This should usually be set to **On**.) When the DHCP function of the router is Off, set **Auto Setup** to **Off**, and set the IP Address DNS address(es) manually.

Advanced Network Setup	
<b>IP Address Setup</b>	
Auto Setup	On
IP Address	XXX . XXX . XXX . XXX
Subnet Mask	XXX . XXX . XXX . XXX
Default Gateway	XXX . XXX . XXX . XXX
<b>DNS Setup</b>	
Auto Setup	On
Primary DNS Address	XXX . XXX . XXX . XXX
Secondary DNS Address	XXX . XXX . XXX . XXX
MAC Address	00:11:22:33:44:55
<b>Next</b>	

You can view the fixed MAC address for the TV and for the Dual Band WLAN Adaptor, if one is installed.

Press **▲** or **▼** to select **Next**.

**13** Press **OK**, and Network Connection Test will start.

A message will appear to indicate if the connection was successful or it could not be completed.

Network connection was completed successfully.

**OK**

**NOTE:** The result of Network Connection Test does not always guarantee the connection.

**To cancel the Network Connection Test:**  
Press **BACK** while searching for the Internet connection.

- 14** Press **OK**. If your country supports Network Guide, The **Guide Type** screen will appear.



Press ◀ or ▶ to select **Broadcast Guide** or **MediaGuide**.

**NOTE:** If you select **MediaGuide**, it may take time to access the Guide screen depending on active channel numbers.

- 15** Press **OK**. If the **Ant/Cable In** screen appears, press ▲ or ▼ to select **Antenna** or **Cable**, and then press **OK** to check (✓).

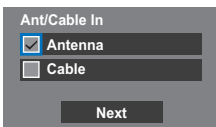

- 16** Select **Next** and press **OK**. The **Auto Tuning** start up screen will appear with the option to select between **DTV and ATV**, **DTV** or **ATV** if available. Use ◀ or ▶ to select the appropriate mode.

- 17** Press ▲ or ▼ to highlight **Start Scan**, and then press **OK**.

The television will start to search for available **DTV** and/or **ATV** channels. The progress bar will indicate the scan status.

**You must allow the television to complete the search.**

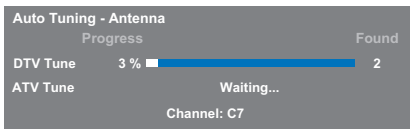

When the search is complete, the television will automatically select channel one.

The **Auto Tuning** screen will display the total number of services found.

- 18** Press ◀ or ▶ to view the **DTV** (digital channel) or **ATV** (analogue channel) lists.

- 19** Use ▲ or ▼ to move through the list to select a channel, and then press **OK** to view.

In **ATV** mode, some areas may receive duplicate stations. There may not be a clear picture or the signal may be weak, so the station order can be changed using **ATV Manual Tuning**.

**REMEMBER:** Press **TV** at any time to select between **ATV** and **DTV** modes.

**NOTE:** The time will be set automatically by transmission but can be advanced or decreased by using **Local Time Setting** in the **DTV Settings** screen.

**PLEASE NOTE**

The **Quick Setup** menu can also be accessed at any time from the **Setup / System Setup** menu.

**Ant/Cable In (if available)**

*From this menu, you can set the RF input configuration.*

- 1** Press **MENU** / ◀▶ to highlight **Setup** icon.
- 2** Press ▲ / ◀▶ to highlight **System Setup** icon and press **OK**.
- 3** Press ▼ to select **Ant/Cable In** and press ◀ or ▶ to select **Antenna** or **Cable**.

**NOTE:** When you attempt to change the **Ant/Cable In** setting, a warning message will appear followed by PIN entry (if PIN has been set) and a prompt for **Auto Tuning**.

- 4** When **Ant/Cable In** is set to **Cable**, the following setting options will be provided in the **Auto Tuning** screen.

Press ▲ or ▼ to select an item and press ◀ or ▶ to select your desired option.

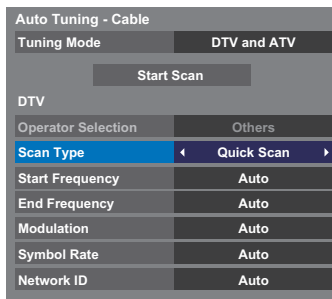

With the exception of **DTV Scan Type** and **DTV Modulation** items, all of the following items will have 2 operating modes. The first is **Auto** where the values for each item are preset by the system. The second is an **Input** mode where you will be able to enter a single value in place of the pre-set value. If no channel is currently tuned and the **Input** state is chosen, a system default value will be shown. However, if a channel is currently tuned when the item is accessed, the value of the current channel will be displayed.

### Operator Selection:

You can choose the Cable operator depending on the **Country** you set.

### DTV Scan Type:

This item determines whether a **Quick Scan** or a **Full Scan** will be executed.

The **Quick Scan** is a simplified version of the **Full Scan** that is designed to complete in less time.

### DTV Start Frequency:

This sets the frequency from which the scan will begin.

### DTV End Frequency:

This sets the frequency at which the scan will end.

### DTV Modulation:

You can choose from five QAM modulation settings.

### DTV Symbol Rate:

This is the baud rate (KS/s) of the scan.

### DTV Network ID:

This is the Network ID to be utilized for the scan. This item is grayed out when DTV Scan Type is set to "Full Scan".

## Auto Tuning

**NOTE:** As new services are broadcast, it will be necessary to re-tune the television in order to view them.

**Auto Tuning** will completely re-tune the television and can be used to update the channel list. **It is recommended that Auto Tuning is run periodically to ensure that all new services are added.** All current channels and settings, i.e. locked channels, will be lost.

- 1 Press **MENU** / ◀▶ to highlight **Setup** icon.
- 2 Press ▲ / ◀▶ to highlight **System Setup** icon and press **OK**.

- 3 Press ▲ or ▼ to select **Auto Tuning** and press **OK**.

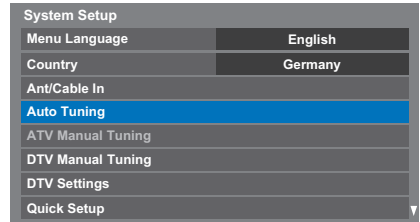

- 4 Press ◀ or ▶ to select **Yes** and press **OK**.

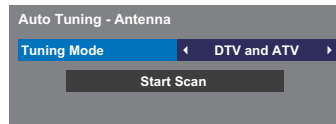

Press ◀ or ▶ to select **DTV and ATV**, **DTV** or **ATV**, if available, then highlight **Start Scan** and press **OK** to continue with the **Auto Tuning**.

**NOTE:** If you have selected "Others" for the **Country** field in the **System Setup** menu, and selected a tuning mode other than "DTV", choose the optimum ATV broadcasting system (B/G, I, D/K or L).

The television will start to search for all available DTV and/or ATV services.

**You must allow the television to complete the search.**

When the search is complete, the **Auto Tuning** screen will display the services found.

- 5 Press ▲ or ▼ to move through the list to select a channel and press **OK** to view.

# ATV Manual Tuning

## Tuning

The television can be tuned-in manually using **ATV Manual Tuning**. For example, you might use the feature if the television cannot be connected to a media recorder/decoder with a SCART lead or when you want to tune-in a station on another **System**.

Use ◀ and ▶ to move across the screen and select any of the ATV Manual Tuning options. Then use ▲ or ▼ to adjust the settings.

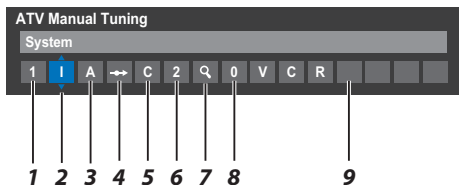

### 1 Position

The number to be pressed on the remote control to tune the channel.

### 2 System

Specific to certain areas.

### 3 Colour System

Factory set to Auto, should only be changed if problems are experienced, i.e. NTSC input from external source.

### 4 Skip

Set Skip to On (↶↷) or Off (↷↶) for the selected channel. See page 21.

### 5 Signal Class

The channel classification.

### 6 Channel

The channel number on which a station is being broadcast.

### 7 Search

Search up and down for a signal.

### 8 Manual Fine Tuning

Only used if interference/weak signal is experienced. See page 72.

### 9 Station

Station identification. Use the ▲ ▼ and ◀ ▶ buttons to enter up to seven characters.

To allocate a position on the television for a decoder and media recorder: turn the decoder on, insert a pre-recorded film in the media recorder, press PLAY and manually tune.

- In the **System Setup** menu, press ▼ to select **ATV Manual Tuning** and press **OK**.

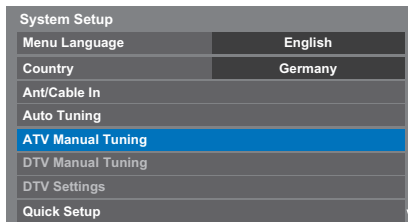

- Use ▲ or ▼ to select the desired position. We suggest **Pos. 0** for a media recorder.

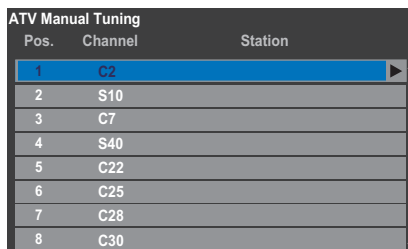

Different **Channel** numbers may be displayed.

- Press **OK** to select. If the channel chosen for the media recorder is set to skip, Skip should be removed before storing.

- Press ▶ to select **System** and press ▲ or ▼ to change if required.

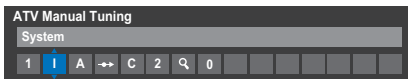

- Then press ▶ to select **Search**.

- Press ▲ or ▼ to begin the search. The search symbol will flash.



**7** Each signal will show on the television. If it is not your media recorder, press ▲ or ▼ again to restart the search.

**8** When your media recorder signal is found, press ► to move along to **Station**. Use ▲, ▼, ◀ and ▶ to put in the required characters, e.g. **VCR**.

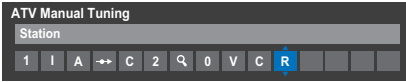

**9** Press **OK** to save.

**10** Repeat for each **position** you want to tune.

**11** Press **EXIT** when you have finished.

#### PLEASE NOTE

This television has direct channel entry if the channel numbers are known. Select the **ATV Manual Tuning** screen in **Step 3**. Enter the **Position number**, the **System**, then **C** for standard (terrestrial) channels or **S** for cable channels and the **Channel** number. Press **OK** to save.

## Skip

To prevent certain channels from being viewed, positions can be *skipped*.

**1** Select **ATV Manual Tuning** from the **System Setup** menu.

**2** Use ▲ or ▼ to highlight the position to be skipped and press **OK** to select.

Pos.	Channel	Station
1	C2	
2	S10	
3	C7	
4	S40	ABC1
5	C22	ABC1
6	C25	
7	C28	
8	C30	

**3** Press ► to select **Skip**.

**4** Use ▲ or ▼ to turn **Skip** on. Press **OK**.

↻ on the screen indicates a skipped position.

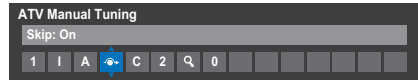

**5** Press **EXIT** and repeat steps 1 through 4 to set other positions if necessary.

Each position has to be *individually* selected. To turn **Skip** off, repeat the procedure for each position.

Skipped positions **cannot** be selected by **P▲** and **P▼** or by the controls on the television but **can** still be accessed by the number buttons on the remote control.

## Sorting positions

Channels may be moved and saved to the position of your choice.

- 1 Select **ATV Manual Tuning** from the **System Setup** menu.
- 2 With the list of channels showing, use ▲ or ▼ to highlight the channel you want to move and press ►.

ATV Manual Tuning		
Pos.	Channel	Station
2	S10	
3	C7	
4	S40	ABC1
5	C22	ABC1
1	C2	
6	C25	
7	C28	
8	C30	

- 3 Use ▲ or ▼ to move through the list to your preferred position. As you do so, the other channels will move to make room.
- 4 Press ◀ to save your move.  
Repeat as necessary and press **EXIT**.

## DTV Manual Tuning

**NOTE:** This feature varies depending on the **Ant/Cable In** setting.

### Manual Tuning

*This feature is available for service engineers or can be used for direct channel entry if the multiplex channel is known.*

- 1 Select **DTV Manual Tuning** from the **System Setup** menu and press **OK**.

DTV Manual Tuning - Antenna	
Signal Strength	WEAK AVERAGE STRONG
Quality	GOOD
Channel	67
Frequency	842.0 MHz
Bandwidth	8 MHz
Start Scan	

- 2 Enter the multiplex number using the number buttons or use ◀ or ▶ to adjust the number up or down.
- 3 Highlight **Start Scan** and press **OK**. The television will automatically search for that multiplex.

DTV Manual Tuning - Antenna			
0 New Channels - Total 6			
New	Pos.	Name	Type
1		ABC ONE	<input type="text"/>
2		ABC TWO	<input type="text"/>
7		ABC THREE	<input type="text"/>
40		ABC NEWS 24	<input type="text"/>
51		ABC1	<input type="text"/>

When the multiplex is found, any channels that are not currently in the channel list will be added and the channel information at the top of the screen will be updated.

- 4 Repeat as necessary. Press **EXIT** to finish.

## Manual Tuning for DVB-C

When **Ant/Cable In** is set to **Cable**, **DTV Manual Tuning** items are as follows:

**Frequency** – input a specific frequency to be scanned

**Modulation** – choose from one of five QAM modulation options

**Symbol Rate** – input a specific baud rate (KS/s) to be used for the manual scan

## DTV Settings

### Channels

*The channel order may be changed to suit your personal preference.*

- 1 Select **DTV Settings** from the **System Setup** menu and press **OK**.
- 2 Select **Channels** and press **OK**.

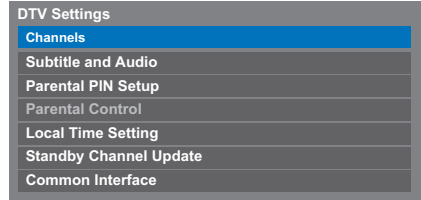

- 3 For your convenience, you can jump to specific places in the list by one of two methods.

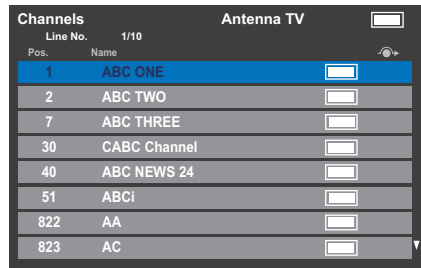

**Line Number Jump** — Use the **number buttons** (0-9) to input the line number you want to select and press **OK**.

It is also possible to change the Position number of a particular channel.

**Renumber** — Press the **RED** button to renumber the highlighted channel. Edit the channel number using the **number buttons** and press **OK**. If the position number you input already exists, a confirmation window will appear.

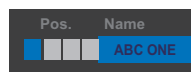

**Move** — Press the **GREEN** button to activate the **Move** feature. Press the **▲** or **▼** buttons to select the channel you wish to move and press **OK** to check. If you wish to move multiple channels at once, select another channel and check in the same way. Repeat as necessary.

Once all desired channels have been checked, press the **▲** or **▼** buttons to place the focus at the position to which you wish to move the channels. The channels will be inserted above the highlighted channel. Press the **GREEN** button to execute the move.

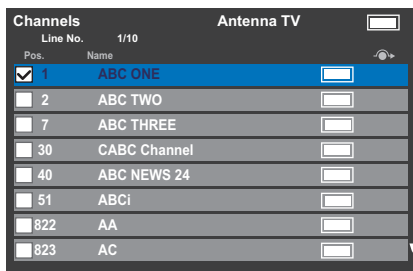

**Position No. Sort** — Press the **YELLOW** button. A confirmation window will appear. Press **◀** or **▶** to select **Yes** and press **OK**.

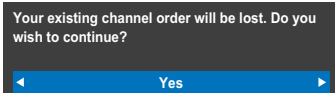

## Standby Channel Update

If the **Standby Channel Update** is set to **On**, when the TV is in standby mode, **Digital Tuning** is automatically executed and any new channels are saved.

- 1 Select **DTV Settings** from the **System Setup** menu and press **OK**.
- 2 Press **▼** to select **Standby Channel Update** and press **◀** or **▶** to select **On**.

## Location setting

You can select either **Home** or **Store** mode. **Home** is recommended for normal home use. Select **Store** when using the television for displaying in a shop, etc.

- 1 Select **Location** from the **System Setup** menu.
- 2 Press **◀** or **▶** to select **Home** or **Store**.

## Analogue switch-off

This is a **digital** television which is integrated to allow the use of both **digital** and **analogue** services. However, during the lifetime of this set it is very likely that **analogue** services will be switched off to allow for more new **digital** services.

This 'switch-off' will happen in a number of phases, which will be advertised in your area well in advance. It is recommended that at each phase the television is re-tuned to ensure that existing and new **digital** services can be viewed without disruption.



## General controls

### Quick Menu

**Quick Menu** helps you access some options quickly, such as **Picture Mode**, **Picture Size**, **More Information**, **Sleep Timer** etc.

Press **QUICK** to display the **Quick Menu** and use ▲ or ▼ to select the option.

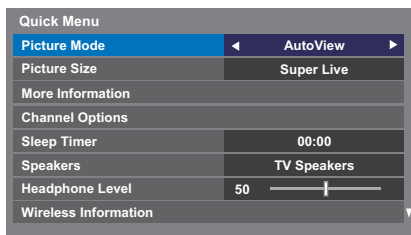

**NOTE:** **Quick Menu** items are different depending on the current mode.

### Quick menu item example

Mode	Quick menu item	Description
When viewing a TV programme or pictures from the external input	Picture Mode	See page 30.
	Picture Size	See page 28.
	More Information	See page 59.
	Channel Options	See page 62.
	Sleep Timer	See page 57.
	Speakers	See page 68.
	Headphone Level	See page 27.
When using EPG	Genre Colour	See page 60.
USB Media Player (Photo Single View, Slide Show)	Picture	See page 30.
	Sound	See page 26.
	Interval Time	See page 51.
	Repeat	See page 51.
	Background Music	See page 51.
	Play List	See page 52.
	Sleep Timer	See page 57.
	Speakers	See page 68.
	Headphone Level	See page 27.

### Selecting channels

To select a channel, use the numbered buttons on the remote control.

Channels can also be selected using **P▲** and **P▼**.

To display on-screen information such as channel, input mode or stereo/mono signal, press **[+]**. Press again to cancel.

### The Time Display – analogue only

*The time display facility allows the current (text service) time to be seen on the television screen.*

Press **[⏸]/[⏹]** whilst watching a normal television broadcast to see the time display from the broadcaster. It will remain on screen for about 5 seconds.

**NOTE:** This display may not be available in some cases.

### Stereo and Bilingual transmissions

#### For DTV programmes

For stereo or dual mono broadcasts, press **[⏸]/[⏹]** and use ◀ or ▶ to select settings.

Mode Display	Pressing ▶
⦿ Stereo	Stereo → Left → Right
● Dual mono	Dual 1 → Dual 2 → Dual
○ Mono	-
⦿ Multichannel	-

For multi-audio track broadcasts, press **[⏸]/[⏹]** repeatedly to change the audio language (see “Audio languages” on page 63).

#### For ATV programmes

If stereo or dual language broadcasts are transmitted, the word **Stereo** or **Dual** will appear on the screen each time channels are changed, disappearing after a few seconds. If the broadcast is not in stereo, the word **Mono** will appear.

**Stereo...** Press **[⏸]/[⏹]** to select **Stereo** or **Mono**.

**Bilingual...** Bilingual transmissions are rare. If they are transmitted, the word **Dual** will be displayed. Choose the required programme number, and if the word **Dual** appears, press **[⏸]/[⏹]** to select **Dual 1**, **Dual 2** or **Mono**.

## Sound controls

### Volume controls and sound mute

#### Volume

Press  $\triangleleft$ + or  $\triangleright$ - to adjust the volume.

#### Sound Mute

Press  $\boxtimes$  once to turn the sound off and again to cancel.

### Dual

If a programme or film is being broadcast with a soundtrack in more than one language, the **Dual** feature allows selection between them.

- 1 Press **MENU** /  $\triangleleft$  $\triangleright$  to highlight **Setup** icon.
- 2 Press  $\triangle$  /  $\triangleleft$  $\triangleright$  to highlight **Sound** icon and press **OK**.
- 3 Press  $\triangle$  or  $\triangleright$  to select **Dual** and press  $\triangleleft$  or  $\triangleright$  to choose between **Dual 1** or **Dual 2**.

Sound	
Dual	$\triangleleft$ Dual 1 $\triangleright$
Balance	0
Advanced Sound Settings	
Stable Sound	Off
Dynamic Range Control	On
Audio Level Offset	
TV Speakers	On
Headphone Settings	

### Balance

- 1 In the **Sound** menu, press  $\triangle$  or  $\triangleright$  to select **Balance** and press  $\triangleleft$  or  $\triangleright$  to emphasize left or right speaker balance.

### Bass, Treble

- 1 In the **Sound** menu, press  $\triangle$  or  $\triangleright$  to select **Advanced Sound Settings** and press **OK**.
- 2 Press  $\triangle$  or  $\triangleright$  to select **Bass** or **Treble**.
- 3 Press  $\triangleleft$  or  $\triangleright$  to change the setting.

### Voice Enhancement

**Voice Enhancement** emphasises the frequency range of the speaker's voice, making it easier to catch what they are saying.

- 1 In the **Advanced Sound Settings** menu, press  $\triangle$  or  $\triangleright$  to select **Voice Enhancement**.
- 2 Press  $\triangleleft$  or  $\triangleright$  to select **On** or **Off**.

### Dynamic Bass Boost

**Dynamic Bass Boost** enhances the depth of the sound on the TV speakers. The difference will only be noticeable on sound with strong bass.

- 1 In the **Advanced Sound Settings** menu, press  $\triangle$  or  $\triangleright$  to select **Dynamic Bass Boost**.
- 2 Press  $\triangleleft$  or  $\triangleright$  to select the desired bass expansion level (**Low**, **High** or **Off**).

### Stable Sound®

**Stable Sound** reduces the volume level differences between channels. It automatically remains on the same volume level when you change channels.

- 1 In the **Sound** menu, press  $\triangle$  or  $\triangleright$  to select **Stable Sound**.
- 2 Press  $\triangleleft$  or  $\triangleright$  to select **On** or **Off**.

### Dynamic Range Control

This feature allows control of audio compression for some digital TV programmes (MPEG-1 and MPEG-2 audio programmes are not supported).

- 1 In the **Sound** menu, press  $\triangle$  or  $\triangleright$  to select **Dynamic Range Control**.
- 2 Press  $\triangleleft$  or  $\triangleright$  to select **On** or **Off**.

## Audio Level Offset

Sometimes there can be large changes in volume when switching from a DTV 5.1ch to a DTV 2ch, an ATV channel, or an external input. Using the **Audio Level Offset** feature reduces these volume differences.

- 1 Set the volume level usually used when watching a DTV 5.1ch programme.
- 2 Tune to a channel which is DTV 2ch, ATV or an external input.
- 3 In the **Sound** menu, press ▲ or ▼ to select **Audio Level Offset** and press **OK**.
- 4 Press ▲ or ▼ to select an option, and then press ◀ or ▶ to adjust the volume level.

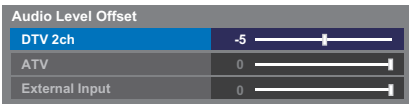

### NOTE:

- The available item changes depending on the current input source. For example, while watching a DTV 2ch programme, only **DTV 2ch** is available and the other two items are grayed out in the menu. This allows you to easily adjust according to each condition.
- When watching a DTV 5.1ch programme, this feature is not available.

## TV Speakers On/Off

This feature allows you to turn the TV speakers off when connecting the audio system.

- 1 In the **Sound** menu, press ▲ or ▼ to select **TV Speakers**.
- 2 Press ◀ or ▶ to select **Off**.

### To turn on the built-in speakers:

Choose **On** in step 2.

## Headphone Settings

This setting is used to set the sound output when headphones are connected.

Speaker Link	Headphone	Speakers
On	Sound is output (◀ ± is available.)	No sound
Off	Sound is output (Headphone level menu is available.)	Sound is output (◀ ± is available.)

- 1 In the **Sound** menu, press ▲ or ▼ to select **Headphone Settings** and press **OK**.
- 2 Press ▲ or ▼ to select **Speaker Link** and press ◀ or ▶ to select **On** or **Off**.
- 3 If you select **Off**, then highlight **Headphone Level** and use ◀ or ▶ to adjust the headphone sound.

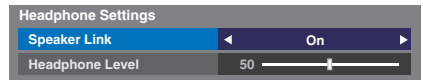

## Audio Description

*Audio Description is an additional narrative sound track for visually impaired individuals to understand and enjoy the story line more fully. The letters AD will be displayed in the channel banner when programmes contain AD content.*

- 1 In the **Sound** menu, press ▲ or ▼ to select **Audio Description** and press **OK**.
- 2 Press ▲ or ▼ to select **Audio Description** and press ◀ or ▶ to select **On**.

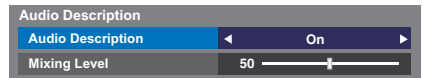

The **AD** button on the Remote can also be used to toggle the **Audio Description** feature between On and Off.

- 3 To adjust the level of the audio description sound to the main sound, highlight **Mixing Level** and press ◀ or ▶.

## Widescreen viewing

Depending on the type of broadcast being transmitted, programmes can be viewed in a number of formats.

### WIDE

Use this setting when watching a widescreen DVD, widescreen video tape or a 16:9 broadcast (when available). Due to the range of widescreen formats (16:9, 14:9, 20:9 etc.) black bars may be visible on the top and bottom of the screen.

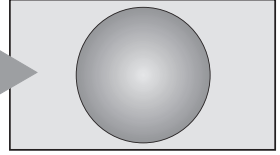

### 4:3

Use this setting to view a true 4:3 broadcast.

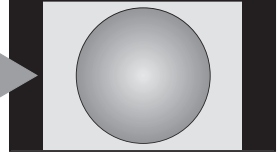

### SUPER LIVE

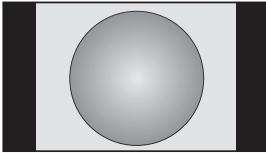

This setting will enlarge a 4:3 image to fit the screen by stretching the image horizontally and vertically, holding better proportions at the centre of the image. Some distortion may occur.

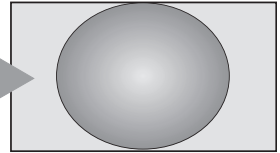

### CINEMA

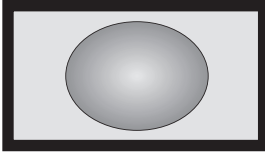

When watching 'all sides panel format' films/video tapes, this setting will eliminate or reduce the black bars at all sides of the screen by zooming in and selecting the image without distortion.

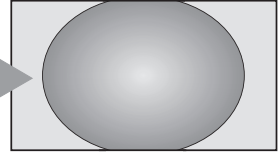

### SUBTITLE

When subtitles are included on a letterbox format broadcast, this setting will raise the picture to ensure that all the text is displayed.

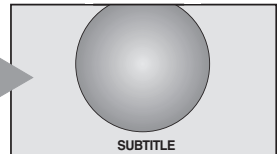

### 14:9

Use this setting when watching a 14:9 broadcast.

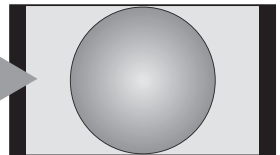

**NATIVE**

*This setting will show the picture without overscan, i.e. WYSIWYG.*

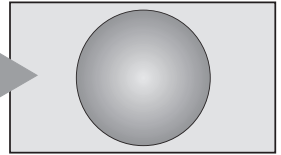
**PC NORMAL**

*This setting will show the picture without overscan, i.e. WYSIWYG. This option is only available when watching a PC signal source via HDMI or PC terminal.*

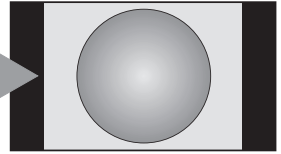
**PC WIDE**

*This setting will show the picture without overscan or side panels. This option is only available when watching a PC signal source via HDMI or PC terminal.*

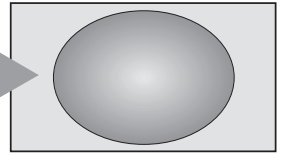
**Dot by Dot**

*"Dot by Dot" is a non-scaling display. Depending on the input signal format, the picture is displayed with side panels and/or bars at the top and bottom (e.g. VGA input source).*

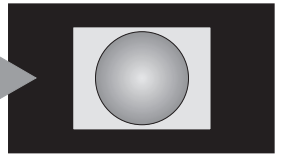

Press the  button on the Remote to display the list of available widescreen formats.

Press the button repeatedly to highlight the required format.

The **Quick Menu** feature can also be used to select **Picture Size**.

## AV format

Picture Size
Wide
4:3
Super Live
Cinema
Subtitle
14:9
Native

## PC format

Picture Size
PC Normal
PC Wide
Dot by Dot

*Using the special functions to change the size of the displayed image (i.e. changing the height/width ratio) for the purposes of public display or commercial gain may infringe on copyright laws.*

## Picture controls

Most of the picture controls and functions are available in both **digital** and **analogue** modes.  
**PLEASE NOTE:** Features not available will be grayed out.

### Picture Mode

This television offers the choice of personalising the picture style.

**AutoView, Dynamic, Standard, Hollywood 1, Hollywood 2, Store, Game** and **PC** are preset options and affect many features/settings within the television.

#### NOTE:

- Because the **AutoView** mode automatically adjusts picture settings based on ambient light conditions and input signal content, the **Auto Brightness Sensor** menu is grayed out when it is selected.
- **Store** mode is only available when **Location** is set to **Store**.
- **Game** mode is available in external input mode (other than aerial input). When you select **Game** mode, suitable widescreen formats will be selected.
- **PC** mode is available in RGB/PC input mode or HDMI input mode.

- 1 Press **MENU** / ◀▶ to highlight **Setup** icon.
- 2 Press ▲ / ◀▶ to highlight **Picture** icon and press **OK**.
- 3 Press ▲ or ▼ to select **Picture Mode**.

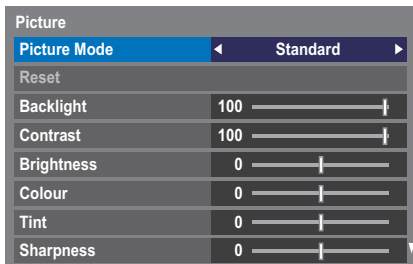

- 4 Press ◀▶ to select the picture mode you prefer and press **OK**.

The Picture Mode can also be selected using the **Picture** button on the remote control.

**NOTE:** The picture mode you select affects the current input only. You can select a different picture mode for each input.

### Picture preferences

You can customize current picture mode settings as desired. For example, while selecting "**Dynamic**", if you change the following items, such as **Backlight, Contrast, Brightness, Colour, Tint, Sharpness** and the **Advanced Picture Settings** items, your new settings are saved for "**Dynamic**" picture mode.

- 1 In the **Picture** menu, press ▲ or ▼ to select either **Backlight, Contrast, Brightness, Colour, Tint** or **Sharpness** and press **OK**.

- 2 Press ◀▶ to adjust the settings.

### Reset

This feature resets all picture settings to the factory settings except **Picture Mode**.

- 1 In the **Picture** menu, press ▲ or ▼ to select **Reset** and press **OK**.
- 2 A confirmation message will appear. Press ◀▶ to select **Yes** and press **OK**.

### ColourMaster

When **ColourMaster** is set to **On**, it allows the 'Base Colour Adjustment' feature to become available.

- 1 In the **Picture** menu, press ▲ or ▼ to select **Advanced Picture Settings** and press **OK**.
- 2 Press ▼ to select **ColourMaster**.

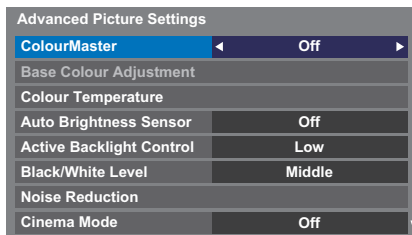

- 3 Press ◀▶ to select **On** or **Off** and press **OK**.

## Base Colour Adjustment

The **Base Colour Adjustment** feature allows the adjustment of individual colours to suit personal preference. This can be useful when using an external source.

- 1 In the **Advanced Picture Settings** menu, press ▲ or ▼ to select **Base Colour Adjustment** and press **OK**.
- 2 Press ▲ or ▼ to select an option and press ► to move to the adjustment window.

Base Colour Adjustment			
	Hue	Saturation	Brightness
<input type="checkbox"/> Red	0	0	0
<input type="checkbox"/> Green	0	0	0
<input type="checkbox"/> Blue	0	0	0
<input type="checkbox"/> Yellow	0	0	0
<input type="checkbox"/> Magenta	0	0	0
<input type="checkbox"/> Cyan	0	0	0
Reset			

- 3 Press ◀ or ▶ to select **Hue**, **Saturation** or **Brightness** and press ▲ or ▼ to adjust the settings as required.

	Hue	Saturation	Brightness
<input type="checkbox"/> Red	0	0	-1

- 4 Press **BACK** to return to the previous menu.  
To return to the factory settings, select **Reset** and press **OK**.

## Colour Temperature

**Colour Temperature** increases the 'warmth' or 'coolness' of the picture by increasing the red or blue tint.

- 1 In the **Advanced Picture Settings** menu, press ▲ or ▼ to select **Colour Temperature** and press **OK**.
- 2 Press ▲ or ▼ to select **Colour Temperature** and press ◀ or ▶ to select **Cool**, **Natural** or **Warm** to suit your preference.
- 3 Press ▲ or ▼ to select **Red Level**, **Green Level** or **Blue Level** and press ◀ or ▶ to adjust the level.

**NOTE:** To return the adjustments to the factory defaults, select **Reset** and press **OK**.

## Auto Brightness Sensor

When the **Auto Brightness Sensor** is activated, it will automatically optimise the backlighting levels to suit ambient light conditions.

- 1 In the **Advanced Picture Settings** menu, press ▲ or ▼ to select **Auto Brightness Sensor**.
- 2 Press ◀ or ▶ to select **On** or **Off**.

## Active Backlight Control

When the **Active Backlight Control** feature is activated, it will control the backlighting levels depending on various scenes such as picture motion, bright scene or dark scene.

- 1 In the **Advanced Picture Settings** menu, press ▲ or ▼ to select **Active Backlight Control**.
- 2 Press ◀ or ▶ to select **High**, **Low** or **Off**.

**High:** To control the backlighting levels depending on various scenes such as picture motion, bright scene or dark scene

**Low:** To control the backlighting levels for dark scene

## Black/White Level

**Black/White Level** increases the strength of dark areas of the picture to improve the definition.

- 1 In the **Advanced Picture Settings** menu, press ▲ or ▼ to select **Black/White Level**.
- 2 Press ◀ or ▶ to select **High**, **Middle**, **Low** or **Off**.

## MPEG NR – Noise Reduction

When watching a DVD, the compression may cause some words or picture elements to become distorted or pixelated. Using the **MPEG NR** feature reduces this effect by smoothing out the edges.

- 1 In the **Advanced Picture Settings** menu, press ▲ or ▼ to select **Noise Reduction** and press **OK**.
- 2 Press ▼ to select **MPEG NR**.

Noise Reduction	
MPEG NR	◀ Low ▶
DNR	Auto

- 3 Press ◀ or ▶ to select **Low**, **Middle**, **High** or **Off** to suit your preference.

## DNR – Digital Noise Reduction

**DNR** allows you to 'soften' the screen representation of a weak signal to reduce the noise effect.

- 1 Select **DNR** from the **Noise Reduction** menu.
- 2 Press ◀ or ▶ to select **Low**, **Middle**, **High**, **Auto** or **Off**. The differences may not always be noticeable (for the best result use lower settings as picture quality can be lost if the setting is too high).

## Cinema Mode

The frame rate of a movie film is generally 24 frames a second whereas the movie software such as DVD, etc. that you enjoy watching on television at home is 30 or 25 frames a second. The difference in frame rate may cause flickers while viewing the films on television; set the **Cinema Mode** to convert the signal to reproduce a smooth motion and picture quality.

- 1 In the **Picture** menu, press ▼ to select **Advanced Picture Settings** and press **OK**.
- 2 Press ▼ to select **Cinema Mode** and press ◀ or ▶ select from **On** or **Off**.

**NOTE:** When **Picture Mode** is set to **Game** or **PC**, this feature will be grayed out and automatically set to **Off**.

## Resetting the advanced picture settings

This feature allows you to reset the current **Advanced Picture Settings** to the default values.

- 1 In the **Advanced Picture Settings** menu, press ▲ or ▼ to select **Reset**.
- 2 Press **OK**.

## Automatic Format (Widescreen)

When this television receives a true Widescreen picture and **Auto format** is **On**, it will automatically be displayed in Widescreen format irrespective of the television's previous setting.

- 1 Press **MENU** / ◀▶ to highlight **Setup** icon.
- 2 Press ▲ / ◀▶ to highlight **Preferences** icon and press **OK**.
- 3 Press ▲ or ▼ to select **Display Settings** and press **OK**.
- 4 Press ▲ or ▼ to select **Auto Format** and press ◀ or ▶ to select **On** or **Off**.



## 4:3 Stretch

When **4:3 Stretch** is activated, the size switching system changes 4:3 programmes into full screen picture.

- 1 In the **Preferences** menu, press ▲ or ▼ to select **Display Settings** and press **OK**.
- 2 Press ▲ or ▼ to select **4:3 Stretch** and press ◀ or ▶ to select **On** or **Off**.

## Blue Screen

When **Blue Screen** is selected, the screen will turn blue and the sound will be muted on analogue channels and external input modes when no signal is received.

**NOTE:** Some external input sounds may not be muted.

- 1 In the **Preferences** menu, press ▲ or ▼ to select **Blue Screen**.
- 2 Press ◀ or ▶ to select **On** or **Off**.

## Picture Position

The picture position may be adjusted to suit personal preference and can be particularly useful for external inputs.

**NOTE:** The **Picture Position** feature cannot be selected in the **DTV** mode.

- 1 In the **Preferences** menu, press ▲ or ▼ to select **Display Settings** and press **OK**.
- 2 Press ▲ or ▼ to select **Picture Position**.



- 3 Press **OK** to view the options available for the picture format that has been selected.
- 4 Press ▲ or ▼ to select an option and press ◀ or ▶ to adjust the settings.

The options differ depending on the currently selected widescreen format and the input signal.

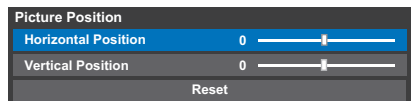

To return to the original factory settings, select **Reset** in the **Picture Position** menu and press **OK**.

## Picture still

This feature is used to hold a still image on the screen.

- 1 Press ▼ to hold an image on the screen, and press ▼ again to cancel.



## Using your home network

This TV is a DLNA CERTIFIED™ Player. This TV can play digital content stored on a DLNA CERTIFIED™ product with server function.

If you want to use this TV as a DLNA CERTIFIED™ Player, you will have to configure the network on your TV (see page 13).

If you want to use your home network, you will have to configure the network on your TV. (see page 13)

Change the network settings if necessary (see “Setting up the Network” on page 34).

### When using a wireless home network:

#### Wireless Interoperability

The TOSHIBA Dual Band WLAN Adaptor is designed to be interoperable with any wireless LAN product that is based on Direct Sequence Spread Spectrum (DSSS)/Orthogonal Frequency Division Multiplexing (OFDM) radio technology, and is compliant to:

- The IEEE 802.11 Standard on Wireless LANs (Revision a/b/g/n), as defined and approved by the Institute of Electrical and Electronics Engineers.
- The TOSHIBA Dual Band WLAN Adaptor is intended for use with the RL93/RL95 series LCD TV's and should not be used with any other devices.

Use of the WLAN Adaptor in other USB products may result in damage to the WLAN Adaptor and/or the equipment. Such use will void any warranty that may otherwise apply, and TOSHIBA will have no liability for any damage that may result from such use.

#### CAUTION

Bluetooth™ and Wireless LAN devices operate within the same radio frequency range and may interfere with one another. If you use Bluetooth™ and Wireless LAN devices simultaneously, you may occasionally experience a less than optimal network performance or even lose your network connection.

If you should experience any such problem, immediately turn off either your Bluetooth™ or Wireless LAN device.

Actual performance can vary, including lower wireless network capacity, data throughput rate, range and coverage.

Performance depends on many factors, conditions and variables, including distance from the access point, volume of network traffic, building materials and construction, operating system used, mix of wireless products used, interference and other adverse conditions.

### Wireless LAN and your Health

Wireless LAN products, like other radio devices, emit radio frequency electromagnetic energy. The level of energy emitted by Wireless LAN devices, however, is far less than the electromagnetic energy emitted by wireless devices such as mobile phones.

Because Wireless LAN products operate within the guidelines found in radio frequency safety standards and recommendations, TOSHIBA believes Wireless LAN is safe for use by consumers. These standards and recommendations reflect the consensus of the scientific community and result from deliberations of panels and committees of scientists who continually review and interpret the extensive research literature.

In some situations or environments, the use of Wireless LAN may be restricted by the proprietor of the building or responsible representatives of the organization. Such restrictions may apply in environments where the risk of interference to other devices or services is perceived or identified as harmful.

If you are uncertain of the policy that applies to the use of wireless devices in a specific organization or environment, you are encouraged to ask for authorization to use the Wireless LAN device prior to turning on the equipment.

This Dual Band Wireless LAN Adaptor may be operated in the following countries:

<b>AT</b>	Austria	<b>IS</b>	Iceland
<b>BE</b>	Belgium	<b>LI</b>	Liechtenstein
<b>CH</b>	Switzerland	<b>LT</b>	Lithuania
<b>CY</b>	Cyprus	<b>LU</b>	Luxembourg
<b>CZ</b>	Czech Republic	<b>LV</b>	Latvia
<b>DE</b>	Germany	<b>MT</b>	Malta
<b>DK</b>	Denmark	<b>NL</b>	Netherlands
<b>ES</b>	Spain	<b>NO</b>	Norway
<b>FI</b>	Finland	<b>PL</b>	Poland
<b>FR</b>	France	<b>PT</b>	Portugal
<b>GB</b>	United Kingdom	<b>SE</b>	Sweden
<b>GR</b>	Greece	<b>SI</b>	Slovenia
<b>EE</b>	Estonia	<b>SK</b>	Slovakia
<b>HU</b>	Hungary	<b>BG</b>	Bulgaria
<b>IT</b>	Italy	<b>RO</b>	Romania
<b>IE</b>	Ireland	<b>TR</b>	Turkey

### How to use this Dual Band Wireless LAN Adaptor

- If this device is going to be operated in the frequency range of 5.15 GHz to 5.35 GHz, it is restricted to indoor use.
- If this device is going to be operated for 802.11 b/g/n function in the frequency range of 2.454 GHz to 2.4835 GHz in France, it is restricted to indoor use.
- A general authorization is required for using this device outdoors or in public places in Italy.
- This device is NOT ALLOWED to be used in the geographical area within a radius of 20km from the centre of Ny-Alesund in Norway.

## Setting up the Network

You can select the Network Type.

- 1 Press **MENU** / ◀ to highlight **Setup** icon.
- 2 Press ▲ / ◀ to highlight **Preferences** icon and press **OK**.
- 3 Press ▲ or ▼ to select **Network Setup** and press **OK**.

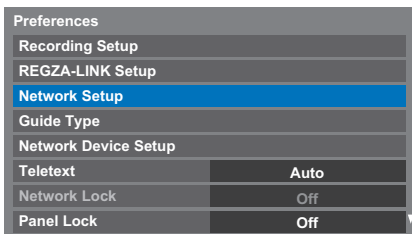

- 4 Press ▲ or ▼ to select **Network Type** and press ◀ or ▶ to select **Wired** or **Wireless**.

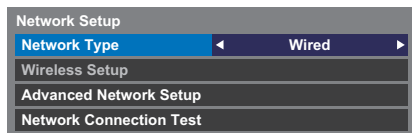

**NOTE:** If the Dual Band WLAN Adaptor is not connected, Wireless cannot be selected.

- 5 If you selected **Wired**, see “Advanced Network Setup” on page 36.

### Wireless Setup

#### NOTE:

- This feature is grayed out when the Dual Band WLAN Adaptor is not connected or Network Type is set to Wired.
- When you insert or remove the wireless LAN adaptor, you must turn off your TV and unplug the power cord, and then plug and turn on again.
- Continued connection of **AP** (Access Point) is not guaranteed. The connection may be disconnected while watching TV.
- Do not remove the Dual Band WLAN Adaptor when **Network Type** is set to **Wireless** or wireless communication is active.

There are 2 methods for Wireless Setup:

#### Assisted setup by using the Wi-Fi Routers notification information.

Network name, Authentication and Encryption are decided based on information sent from the Wi-Fi router. Security key to be set manually.

#### Manual setup

Network name, Authentication, Encryption and Security Key all to be inputted manually.

#### Assisted Setup

- 1 In the **Preferences** menu, press ▲ or ▼ to select **Network Setup** and press **OK**.
- 2 Press ▲ or ▼ to select **Network Type** and press ◀ or ▶ to select **Wireless**.
- 3 Press ▲ or ▼ to select **Wireless Setup** and press **OK**.
- 4 Press ▲ or ▼ to select **Assisted Setup** and press **OK**.



- 5 Press ▲ or ▼ to select the desired AP and press **OK**.

**NOTE:** Check the MAC address on the label of the AP or in the manual, and select your AP.

- 6 Highlight **Security Key** and press **OK**. The Software Keyboard window will appear.
- 7 Input the Security Key by using the Software Keyboard (see page 38). To save your setting, press the **BLUE** button.

#### NOTE:

- The Security Key must adhere to these conditions:
  - TKIP/AES: 8-63 ASCII or 64 Hex characters
  - WEP: 5 or 13 ASCII or 10 or 26 Hex characters
- There is only one key ID to set for WEP encryption.

- 8 Highlight **Done** and press **OK**.

**NOTE:** If **Network Name** is not displayed, see step 4 and 5 in **Manual Setup** below to set **Network Name** before pressing **Done**.

**NOTE:** Settings are not saved if **BACK** is pressed before **Done** is selected.

#### Manual Setup

- 1 In the **Preferences** menu, press ▲ or ▼ to select **Network Setup** and press **OK**.
- 2 Press ▲ or ▼ to select **Network Type** and press ◀ or ▶ to select **Wireless**.
- 3 Press ▲ or ▼ to select **Wireless Setup** and press **OK**.
- 4 Press ▲ or ▼ to select **Manual Setup** and press **OK**.

**5** Press ▲ or ▼ to select **Network Name** and press **OK**. The Software Keyboard window will appear.

**6** Input the Network Name by using the Software Keyboard (see page 38). To save your setting, press the **BLUE** button.

**7** Press ▲ or ▼ to select **Authentication** and press ◀ or ▶ to select **Open System, Shared Key, WPA-PSK or WPA2-PSK**.

**8** Press ▲ or ▼ to select **Encryption** and press ◀ or ▶ to select **None, WEP, TKIP or AES**.

**NOTE:**

- Certain encryption types are only compatible with specific authentication types.
  - When Authentication is Open System, only WEP or None is compatible.
  - When Authentication is Shared Key, only WEP is compatible.
  - When Authentication is WPA-PSK or WPA2-PSK, only TKIP or AES is compatible.
- When incompatible Authentication/Encryption pairings are detected, a warning message will be displayed, and no connection attempt will be made until the incompatibility is resolved.
- There is only one key ID to set for WEP encryption.

**9** Press ▲ or ▼ to select **Security Key** and press **OK**.

**10** Input the Security Key by using the Software Keyboard (see page 38). To save your setting, press the **BLUE** button.

**NOTE:** This item is grayed out when **Encryption** is **None**.

**11** Highlight **Done** and press **OK**.

**NOTE:** When **Encryption** is **None**, a message will appear. Press ◀ or ▶ to select **Yes** and press **OK**.

**NOTE:** Settings are not saved if **BACK** is pressed before **Done** is selected.

## Wireless Information

The settings configured in Wireless Setup can be confirmed.

**1** Press **QUICK** to open the **Quick Menu**.

**2** Press ▲ or ▼ to select **Wireless Information** and press **OK**.

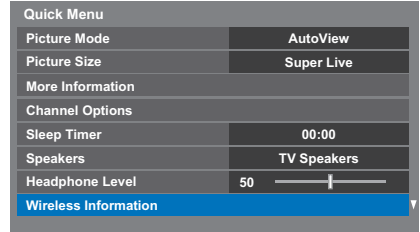

**3** When the **Network Type** is **Wireless**, a Wireless Information window will appear.

**NOTE:** Press the **RED** button to scan for all APs.

Item	Description
Status	<b>Connected</b> is displayed when the TV is connected with the AP. <b>Disconnected</b> is displayed when the TV is not connected with the AP.
Signal	Connection signal strength with AP ( <b>STRONG/MEDIUM/WEAK</b> )
Speed	Link with AP
Mode	Working mode (11a, 11b, 11g, 11n)
Network Name	SSID set
Authentication	Authentication set
Encryption	Encryption set
Security Key	Security Key set
AP MAC Address	The AP's MAC address is displayed when the TV is connected with the AP.
TV MAC Address	The MAC address of the USB (Dual Band WLAN Adaptor) is displayed.
DHCP	<b>Enabled</b> is displayed when using DHCP. <b>Disabled</b> is displayed when not using DHCP.
IP Address	The TV's IP address
Subnet Mask	Value of the Subnet Mask
Default Gateway	Address of the Default GATEWAY
DNS	Address of the DNS

**NOTE:** Even if an AP for IEEE 802.11n is used when **Encryption** is set to **WEP** or **TKIP**, the Speed value might be low. It is recommended that **Encryption** be changed to **AES** (see “Manual Setup” on page 34).

### Notes on wireless LAN environment:

- The function of all IEEE802.11 is not supported.
- The ad-hoc mode is not supported.
- It is recommended to use IEEE 802.11a or IEEE 802.11n on 5 GHz for audio and SD video streaming.
- It is recommended to use IEEE 802.11n on 5 GHz for HD video streaming.
- It is recommended that the encoding rate for streaming video content is 20 Mbps or less.
- It is not recommended to use 2.4 GHz for audio and video streaming.
- Content playback may be interrupted by various surrounding interference.

## Advanced Network Setup

### NOTE:

- When the DHCP function of the router connected with this TV is On, you can set **Auto Setup** to **On** or **Off**. (This should usually be set to **On**.)
- When the DHCP function of the router is Off, set **Auto Setup** to **Off**, and set the IP Address manually.

### IP Address Setup

#### Auto Setup:

- 1 In the **Preferences** menu, press **▲** or **▼** to select **Network Setup** and press **OK**.
- 2 Press **▲** or **▼** to select **Advanced Network Setup** and press **OK**.

Network Setup	
Network Type	Wired
Wireless Setup	
Advanced Network Setup	

- 3 Press **▲** or **▼** to select **IP Address Setup** and press **OK**.

Advanced Network Setup	
IP Address Setup	
DNS Setup	
MAC Address	

- 4 Highlight **Auto Setup** and press **◀** or **▶** to select **On**.

IP Address Setup	
Auto Setup	On
IP Address	XXX . XXX . XXX . XXX
Subnet Mask	XXX . XXX . XXX . XXX
Default Gateway	. . .

**NOTE:** Other items will be grayed out when **Auto Setup** is set to **On**.

### Manual Setup:

- 1 In the **Preferences** menu, press **▲** or **▼** to select **Network Setup** and press **OK**.
- 2 Press **▲** or **▼** to select **Advanced Network Setup** and press **OK**.
- 3 Press **▲** or **▼** to select **IP Address Setup** and press **OK**.
- 4 Highlight **Auto Setup** and press **◀** or **▶** to select **Off**.

IP Address Setup	
Auto Setup	Off
IP Address	XXX . XXX . XXX . XXX
Subnet Mask	XXX . XXX . XXX . XXX
Default Gateway	XXX . XXX . XXX . XXX

- 5 Press **▲** or **▼** to select **IP Address**.
  - 6 Press **◀** or **▶** to highlight the field you want to change, and then use the number buttons to input the IP address. To save the setting, press **OK**.
- NOTE:** IP address field numbers must be between 0 and 255. After each field number has been set, press **OK** to store the entire address. If the entire IP Address is invalid, a warning message will appear after **OK** is pressed.
- 7 Press **▲** or **▼** to select **Subnet Mask**, and edit in the same way as IP Address.

IP Address Setup	
Auto Setup	Off
IP Address	XXX . XXX . XXX . XXX
Subnet Mask	XXX . XXX . XXX . XXX
Default Gateway	XXX . XXX . XXX . XXX

- 8 Press **▲** or **▼** to select **Default Gateway**, and edit in the same way as IP Address.

**NOTE:** If you manually set the IP address, you must not use the same IP address for any other device. The IP address you use should be a private address.

## DNS Setup

**NOTE:** When the DHCP function of the router connected to this TV is Off, set Auto Setup to Off, and manually set the DNS address(es). Your internet service provider should have provided these to you.

### Auto setup:

- 1 In the **Preferences** menu, press ▲ or ▼ to select **Network Setup** and press **OK**.
- 2 Press ▲ or ▼ to select **Advanced Network Setup** and press **OK**.
- 3 Press ▲ or ▼ to select **DNS Setup** and press **OK**.
- 4 Press ▲ or ▼ to highlight **Auto Setup** and press ◀ or ▶ to select **On**.

**NOTE:** Other items will be grayed out when **Auto Setup** is set to **On**.

### Manual setup:

- 1 In the **Preferences** menu, press ▲ or ▼ to select **Network Setup** and press **OK**.
- 2 Press ▲ or ▼ to select **Advanced Network Setup** and press **OK**.
- 3 Press ▲ or ▼ to select **DNS Setup** and press **OK**.
- 4 Press ▲ or ▼ to select **Auto Setup** and press ◀ or ▶ to select **Off**.

DNS Setup	
Auto Setup	◀ Off ▶
Primary DNS Address	xxx . xxx . xxx . xxx
Secondary DNS Address	xxx . xxx . xxx . xxx

- 5 Press ▲ or ▼ to select **Primary DNS Address**.
- 6 Press ◀ or ▶ to highlight the field you want to change, and then use the number buttons to input the Primary DNS Address. To save the setting, press **OK**.

**NOTE:** DNS address field numbers must be between 0 and 255. If you input an incompatible number and press **OK**, the field number will reset to the previous value.

- 7 Press ▲ or ▼ to select **Secondary DNS Address**, and edit in the same way as Primary DNS Address.

## MAC Address

You can view the fixed MAC address for the TV and for the Dual Band WLAN Adaptor, if one is installed.

- 1 In the **Preferences** menu, press ▲ or ▼ to select **Network Setup** and press **OK**.
- 2 Press ▲ or ▼ to select **Advanced Network Setup** and press **OK**.
- 3 Press ▲ or ▼ to select **MAC Address** and press **OK**.

## Network Connection Test

*This function checks the Internet connectivity.*

- 1 In the **Preferences** menu, press ▲ or ▼ to select **Network Setup** and press **OK**.
- 2 Press ▲ or ▼ to select **Network Connection Test** and press **OK**.

A message will appear to indicate if the connection was successful or if it could not be completed.

**NOTE:** The result of Network Connection Test does not always guarantee the connection.

### To cancel the Network Connection Test:

- 1 Press **BACK** while searching for the Internet connection.

## Using the software keyboard

You can enter text by using the Software Keyboard. The Software Keyboard window will appear when you press **OK** on a field that accepts character input.

### To enter text using the software keyboard:

- 1** Highlight the desired character on the on-screen software keyboard.
- 2** Press **OK**.
- 3** Repeat steps 1 and 2 until you have entered all desired text.
- 4** Press the **BLUE** button to close the software keyboard and return to the previous screen.

**NOTE:** If **BACK** is pressed, changes are not saved and the software keyboard window is closed. The text will remain as it was before starting the keyboard.

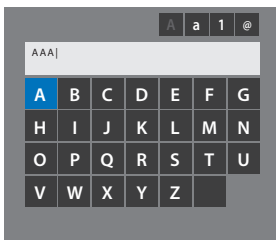

### Input operation on the remote control:

Button	Description
<b>OK</b>	Inputs the selected character.
<b>0-9</b>	Inputs the number directly.
<b>▲▼◀▶</b>	Moves the character highlight.
<b>◀▶▶▶</b>	Moves the cursor.
<b>◀◀</b>	Moves the cursor to the head of a character string.
<b>▶▶</b>	Moves the cursor to the end of a character string.
<b>RED</b>	Deletes 1 character to the left of the cursor.
<b>GREEN</b>	Cycles through upper case, lower case, numbers, and symbols, if available.
<b>BLUE</b>	Saves changes and closes the Software Keyboard window.
<b>BACK</b>	Closes the Software Keyboard window without saving changes.

## Network Device Setup

### External Control Setup

This setup allows you to operate a home network-connected your TV from an external device.

### Media Controller Setup

- 1** In the **Preferences** menu, press **▲** or **▼** to select **Network Device Setup** and press **OK**.

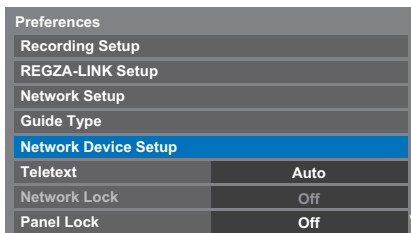

- 2** Press **▲** or **▼** to select **External Control Setup** and press **OK**.
- 3** Press **▲** or **▼** to select an option and press **OK**.

The Software Keyboard window will appear.

**User Name** — Input the User Name (to control the TV from the iPhone etc.) by using the on-screen software keyboard (see page 38). The maximum number of characters is 16.

**Password** — Input the Password (to control the TV from the iPhone etc.) by using the on-screen software keyboard (see page 38). The maximum number of characters is 16.

**NOTE:** Toshiba does not guarantee normal operation with all connected devices.

## Device Name Setup

*The TV's device name can be changed.*

- 1** In the **Preferences** menu, press ▲ or ▼ to select **Network Device Setup** and press **OK**.
- 2** Press ▲ or ▼ to highlight **Device Name Setup** and press **OK**.
- 3** Highlight the **Device Name** field and press **OK**. The Software Keyboard window will appear.
- 4** Input the Device Name by using the software keyboard (see page 38). Press the **BLUE** button.  
**NOTE:** The Device Name can be up to 15 characters long.
- 5** Highlight **Done** and press **OK** to save your setting.

## USB HDD Record Function

This function can be used to record and play digital broadcast programmes. Read the precautions below before recording or viewing programmes using the USB HDD record function.

### NOTE:

- In order to use this function a USB HDD needs to be connected to the TV.
- Recorded programmes saved on the USB HDD can only be viewed on this TV. They cannot be viewed when connected to another TV (including the same model of TV), a PC, or other device.
- You cannot watch one channel while recording another.
- If the recording time to the USB HDD is too short, no data may be saved.
- You cannot record video input signals on the USB HDD.
- Not all types of broadcast may be recordable.
- After programming the TV to record digital broadcasting, do not disconnect the power plug before recording starts. Also, leaving the power switch "ON" until recording is scheduled to start, may cause the recording to fail.
- Should video or audio recording fail due to malfunction of the TV or poor reception, no compensation shall be paid.
- If there is a power failure or the power plug is disconnected during programmed recording, recording will stop and will not resume when the power returns or the plug is reconnected.
- Do not disconnect the power plug when the indicator LED is lit.
- Any changes implemented by the broadcasting station may affect programme scheduling.
- Scheduling of multiple consecutive programmes may result in the beginning of each programme not being recorded.
- Programmed recording cannot take place if the power plug is not connected.
- Disconnecting the power plug during recording may result in failure to save the recorded programme.
- USB HDD recording feature not available in all countries.
- Do not turn off the TV during recording.
- When the USB HDD is formatted, all the data stored on the HDD will be deleted.

## Setting up the USB HDD for recording

### To connect an USB HDD (not supplied)

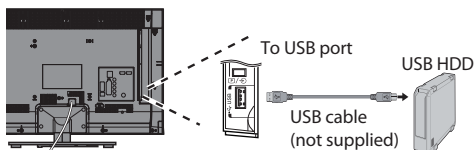

When you connect a USB HDD to the USB port on the TV, a prompt will appear.

- 1 Press ◀ or ▶ to select **No** and press **OK**.

**NOTE:** Not guaranteed to work with all USB HDD.

## To record DTV programmes (One Touch Recording)

*To record the programme currently being viewed.*

- 1 Press the ●REC button on the remote control. The currently viewed programme will start to be recorded. The programme indicator (red) will be lit.

### To stop recording

- 1 Press the ■ (stop) button. A confirmation window "Do you want to stop Recording?" will appear.
- 2 Press ◀ or ▶ to select **Yes** and press **OK**. Recording will stop.



## How to set recordings via the Programme Guide

*Programmed recording can be scheduled easily using the Programme Guide or by specifying the date and time.*

### PLEASE NOTE:

When a timed programme is about to start, an information screen will appear offering the option of watching or cancelling the programme. Other channels will not be available during the timed programme unless the programme timer is cancelled.

It will only be possible to create or edit programme timers for the currently tuned DTV input.

### Using the Programme Guide to set future recordings

- 1 Press the **GUIDE** button on the remote control (or select **TV Programmes / Guide** menu from the menu system) to display the Electronic Programme Guide (EPG).
- 2 Press **▲▼◀▶** to highlight the programme you want to record.
- 3 Press **OK**. The **Edit Timer** menu will appear.

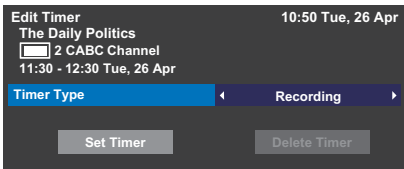

- 4 Press **▲** or **▼** to highlight **Timer Type** and press **◀▶** to select **Recording**.
- 5 Press **▲** or **▼** to highlight **Set Timer** and press **OK**. The **ORANGE LED** will be lit.

### To search for and record a programme using Genre Search

- 1 Press **MENU / ◀▶ / ▲ / ▶** to highlight **TV Programmes / Genre Search** icons and press **OK** to access the **Genre Search** screen.

Genre Search		10:50 Tue, 6 Apr
34 AB1	Hard Rain	Wed,27 Apr 0:15-1:45
31 PARIS PREMIERE	Red Corner	Wed,27 Apr 22:15-23:55
11 NT1	The Lawnmower Man	Thu,28 Apr 1:20-3:00
9 W9	A Vow to Kill	Fri,29 Apr 1:30-3:00
34 AB1	Parenthood	Sat,30 Apr 0:45-2:40
11 NT1	Body and Soul	Sat,30 Apr 1:15-3:00
31 PARIS PREMIERE	The Nun's Story	Sat,30 Apr 15:00-17:30
9 W9	Red Corner	Sat,30 Apr 23:20-1:15
11 NT1	The Real Blonde	Sun,1 May 0:40-2:00
31 PARIS PREMIERE	Critters	Sun,1 May 0:40-2:20
11 NT1	Indiana Jones and the Temple of Doom	Sun,1 May 21:10-23:20
11 NT1	The Jackal	Sun,1 May 23:20-1:15
34 AB1	Coup De Ville	Mon,1 May 1:10-3:00

- 2 Press **◀▶** to select the genre. Programmes listed will change for the new genre. Press **▲** or **▼** to select the programme for which you want to schedule recording.
- 3 Press **OK**. The **Edit Timer** menu will appear.

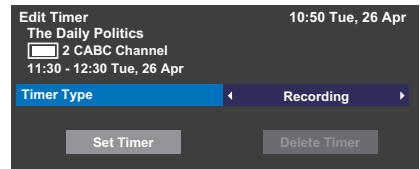

- 4 Press **▲** or **▼** to highlight **Timer Type** and press **◀▶** to select **Recording**.
- 5 Press **▲** or **▼** to highlight **Set Timer** and press **OK**. The **ORANGE LED** will be lit.

## To programme the timer

- 1 Press **MENU** / ◀▶ / ▲ / ▶▶ to highlight **TV Programmes / Programme Timers** icons and press **OK**.
- 2 Select the unprogrammed column (blank column) and press **OK**.  
The **Edit Timer** menu will appear.

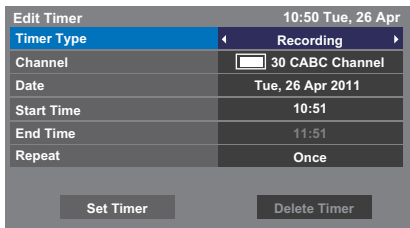

- 3 Press ▲ or ▼ to highlight **Timer Type** and press ◀ or ▶ to select **Recording**.
- 4 Press ▲ and ▼ to go through the list adding the details of the programme by using the number buttons and ◀ and ▶ to make selections.

### Channel:

Select the channel you wish to record.

### Date:

Select the date that you wish recording to start.

### Start Time:

Select the time to start recording.

### End Time:

Select the time to end recording.

### Repeat:

Select **"Once"**, **"Daily"** or **"Weekly"**.

<b>Once</b>	The selected content is recorded once.
<b>Daily</b>	The same time slot on the same channel is recorded every day on and after the selected day.
<b>Weekly</b>	The same time slot on the same channel on the same day of the week is recorded on and after the selected day.

- 5 Press ▲ or ▼ to highlight **Set Timer** and press **OK**. The **ORANGE LED** will be lit.

## To schedule a programme using the information screen

- 1 Press **i+**, the information screen will appear giving details of the channel and programme currently being viewed.

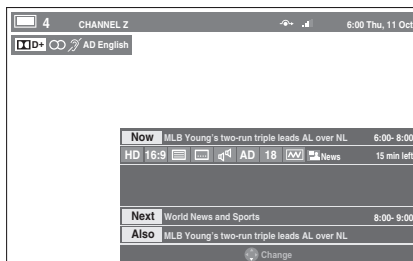

- 2 Press ▲ or ▼ to select the **Next** and press **OK**. The **Edit Timer** menu will appear.

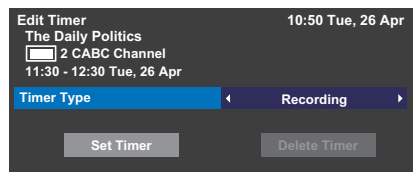

- 3 Press ▲ or ▼ to highlight **Timer Type** and press ◀ or ▶ to select **Recording**.
- 4 Press ▲ or ▼ to highlight **Set Timer** and press **OK**. The **ORANGE LED** will be lit.

## To check, edit or delete scheduling information

You can check, edit or delete scheduling information.

- 1 Press **MENU** / ◀▶ / ▲ / ▶▶ to highlight **TV Programmes / Programme Timers** icons and press **OK**. **Programme Timers** screen will appear.

### Recording List:

- Depending on the transmitter information, the programme broadcast time or other information may not be correctly displayed in the recording list.
- The programme does not appear in the recording list immediately at the start of recording, but appears a few minutes after recording starts.
- Up to 500 programmes can be displayed in the recording list.
- If the channel settings are changed, the digital channel number, or other information may not appear correctly in the recording list.

- As the displayed programme time is calculated from the actual recording information, it may not match the recording time on the USB HDD.

## To check a schedule

- Press **▲** or **▼** on the **Programme Timers** screen to check the schedule.

## To edit a schedule

- Press **▲** or **▼** on the **Programme Timers** screen to select the title whose schedule you want to edit and press **OK**.

The **Edit Timer** screen will appear. Change the settings as required, following the same procedure as for setting the schedule.

- Press **▲** or **▼** to highlight **Set Timer** and press **OK**.

## To delete a schedule

- Press **▲** or **▼** on the **Library** screen to select the title whose schedule you want to delete.

- Press the **RED** button. Press **◀** or **▶** in the displayed confirmation window to select **Yes** and press **OK**. The selected schedule will be deleted.

**NOTE:** You can also delete a schedule by selecting **Delete Timer** from the **Edit Timer** menu for each programming method.

## To view a recorded programme

To view the recorded **Library** screen and select a title from the recorded programme list.

- Press **MENU** / **◀▶** / **▲** / **◀▶** to highlight **TV Programmes** / **Library** icons and press **OK**. **Library** screen will appear.

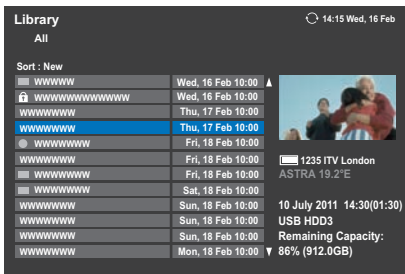

- Press **▲** or **▼** to select the title you want to view. A preview of the content selected can be seen on the preview screen.

To change the order in which the titles are listed, press the **BLUE** button.

- Press **OK**. Viewing starts. ● icon appears next to the title currently being recorded.

When the title currently being recorded is selected and **OK** is pressed, playback will start from the beginning of the programme currently being recorded.

## Operations during viewing

The following operations can be performed using the remote control buttons.

<b>▶</b>	To PLAY	<b>▶▶</b>	To FAST FORWARD
<b>■</b>	To STOP	<b>▶▶▶</b>	To SKIP-FORWARD
<b>II/II</b>	To PAUSE/STEP	<b>◀◀</b>	To shift playback position
<b>◀◀</b>	To SKIP-BACK		
<b>◀◀◀</b>	To REWIND		

## Operations from the Library screen

As well as viewing the list of recorded titles on the **Library** screen, you can protect or delete titles and register titles to Personal Mode.

## To display the Library screen

- Press **MENU** / **◀▶** / **▲** / **◀▶** to highlight **TV Programmes** / **Library** icons and press **OK**. The **Library** screen will appear.

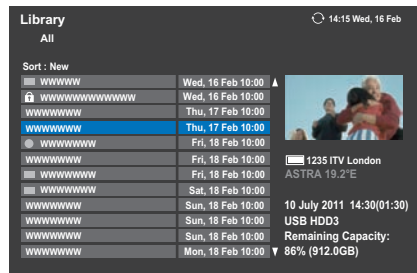



## To protect or unprotect a recorded programme

Protecting a programme prevents it from being accidentally deleted.

Select the title of the programme you want to protect and press the **GREEN** button.  icon appears next to the title and the programme is protected.

If Protect is set to **On** when the programme is recorded,  icon appears next to the title of the recorded programme.

When a title with  icon is selected and the **GREEN** button is pressed,  icon disappears and the programme is unprotected.

## To delete a recorded programme

**1** Press the **RED** button. Check boxes will appear next to the titles.

**2** Press **▲** or **▼** to select the title you want to delete and press **OK**. A check mark will be inserted in the check box.

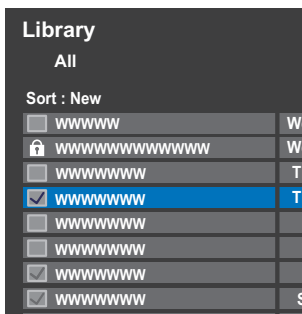

To insert a check mark against all the titles, press the **YELLOW** button.

To uncheck all the check boxes, press the **BLUE** button.

### NOTE:

- A check mark will not be inserted against protected titles.
- Note that once deleted, a title cannot be restored.

**3** Press the **RED** button.

Select **Yes** in the confirmation window and press **OK**. All the titles with check marks will be deleted.

## USB HDD capacity

You can check the remaining capacity of the USB HDD using **Remaining Capacity**.

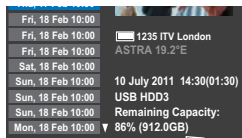

**NOTE:** The remaining capacity displayed is only a guide; it is not guaranteed.

## Recording Setup

*You can set your preferences for recording.*

### To select USB HDD and Partition for Recording

- 1** Press **MENU** / **◀▶** to highlight **Setup** icon.
- 2** Press **▲** / **◀▶** to highlight **Preferences** icon and press **OK**.
- 3** Press **▲** or **▼** to select **Recording Setup** and press **OK**.

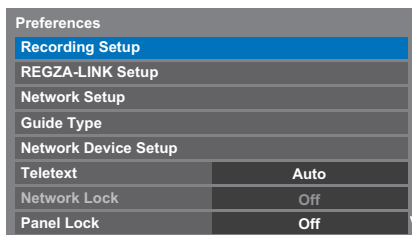

- 4** Press **▲** or **▼** to select **Select Device** and press **OK**. USB HDD and Partition list will be appear. If USB HDD is partitioned by PC, several partitions will be displayed.
- 5** Select USB HDD and Partition you want to recording.

### To set the recording time for One Touch Recording

- 1** Press **MENU** / **◀▶** to highlight **Setup** icon.
- 2** Press **▲** / **◀▶** to highlight **Preferences** icon and press **OK**.
- 3** Press **▲** or **▼** to select **Recording Setup** and press **OK**.

- 4** Press ▲ or ▼ to select **One Touch Recording Time**.

Recording Setup	
Select Device	
One Touch Recording Time	◀ Programme End Time ▶
TimeShift Size	512 MB
Start Padding Time	None
End Padding Time	None
Device Test	
Format Device	

- 5** Press ◀ or ▶ to select the recording time.  
You can set the **Programme End Time** in 30-minute increments in the range of 30 minutes to 360 minutes.

### To select the TimeShift Size

- 1** In the **Recording Setup** screen, press ▲ or ▼ to select **TimeShift Size**.
- 2** Press ◀ or ▶ to select **512MB**, **1GB**, **2GB** or **4GB** and press **OK**.

### To use TimeShift recording

**Time Shift recording** allows you to pause live TV for a fixed period of time.

For Example: If you move away from the TV for a short period, such as when the phone rings while you are watching TV, you can easily pause live TV and then continue to view from the same point in the programme when you return.

- 1** Press **III|▶** on the remote control while viewing the DTV programme.  
The screen will switch to a still image and recording will start automatically.  
The recording time is decided by **TimeShift Size**. If the TimeShift file size reaches the limit set, then the TV will continue to be paused, but the recording buffer will be reset to the beginning.
- 2** Press **▶** (play).  
Catch-up viewing will start from where the programme was paused.
- 3** Press **■** (stop) to stop the recording.

### To set the padding time for programmed recording start time and end time

- 1** In the **Recording Setup** screen, press ▲ or ▼ to select **Start Padding Time**.
- 2** Press ◀ or ▶ to select a time.  
You can select from **None**, 3 minutes, 5 minutes, 10 minutes, 15 minutes, 30 minutes, and 45 minutes.  
Recording will start at the selected number of minutes prior to the recording start time.
- 3** Press ▲ or ▼ to select **End Padding Time**.
- 4** Press ◀ or ▶ to select a time.  
You can select from **None**, 3 minutes, 5 minutes, 10 minutes, 15 minutes, 30 minutes, and 45 minutes.  
Recording will end at the recording end time plus the selected number of minutes.

### To perform a USB HDD operation test

- 1** In the **Recording Setup** screen, press ▲ or ▼ to select **Device Test** and press **OK**.  
USB HDD operation test will start.  
Wait until the test ends.

**NOTE:** The results of the device test are only a guide. The device may not function as shown in the results.

## To format a USB HDD

- 1 In the **Recording Setup** screen, press ▲ or ▼ to select **Format Device** and press **OK**.
- 2 Press ◀ or ▶ to select **Yes** in the confirmation window that will appear and press **OK**. Formatting will start. Wait until formatting ends.

### NOTE:

- If the USB HDD is separated several partitions by PC and multiple Partition appear on the **Device List** screen, press ▲ or ▼ to select the Partition you want to format.
- When the USB HDD (or Partition) is formatted, all the data stored on the USB HDD (or Partition) will be deleted.

## Scheduling priority

If scheduled time slots are next to each other and there is more than one minute between the end time of the first schedule and the start time of the next schedule, programmed recording will be performed correctly.

- When **Start Padding Time** and **End Padding Time** are set (see page 45), the start time and end time will be the time plus the additional minutes.



If scheduling times overlap, priority will be given to the programmed recording which starts first. When the programmed recording that started first ends, recording will switch to the next scheduled programme. At this time, depending on how far the scheduling times overlap, the beginning section of the next scheduled programme may not be recorded.

- When **End Padding Time** is set for the first programmed recording (see page 45), depending on how far the scheduling times overlap, the **End Padding Time** may be ignored and recording of the next scheduled programme may start. As priority is given to the time set in the **Set Timer** menu over the Padding Time, recording will automatically be triggered when the next scheduled programme start time is reached during **End Padding Time**.

## Using Toshiba Places

A new cloud based service, where content (movies, photos, etc.) can be viewed and shared across the web through a simple user interface called “Toshiba Places”.

**NOTE:** You need to configure a home network before using this feature (see page 13).

- 1 Press  on the remote control, or press **MENU** /  to highlight **Connected TV** icon and press **▲** /  to highlight **Toshiba Places** icon and press **OK**.
- 2 Press **▲▼◀▶** to select the desired place and press **OK**.





### NOTE:

- Some features require an always-on broadband internet connection, firmware update and/or additional bandwidth dedicated to this product. Third party internet services may change or be discontinued or restricted at any time. Toshiba makes no warranties, representations, or assurances about the content, availability or functionality of third-party content or services. Use of third party internet services may require registration by a computer and/or payment of charges and membership. Not all services or content may be available on this product, in your country or with your language. In order to experience the full capabilities of this product, fully compatible devices may be required. For more information, visit <http://www.toshibaplaces.com/about>.
- This service may be forcibly blocked according to the situation of CSP service.

## Using Hybrid TV Standard (if available)

Hybrid TV Standard enables the TV to receive HbbTV services. TV services which support this feature often show “press RED” on the screen.

**NOTE:** You need to configure a home network before using this feature (see page 13).

- 1 Press **MENU** /  to highlight **Setup** icon.
- 2 Press **▲** /  to highlight **Preferences** icon and press **OK**.
- 3 Press **▼** to select **Hybrid TV Standard**.
- 4 Press  or  to change from **Disabled** to **Enabled**.

When changing from **Disabled** to **Enabled**, a **Network Connection Test** is performed. If the result is OK, then the setting changes to **Enabled**. If not, the setting remains **Disabled**.

When “**press RED**” is indicated on the screen, press the **RED** button to access HbbTV service site, and then press **▲▼◀▶** to select the desired contents.

### NOTE:

- This service is not available outside Germany.
- The HbbTV service indication or required key operations may not be possible depending on the service contents. In this case set the **Hybrid TV Standard** setting to **Disabled**.
- Toshiba makes no warranties, representations, or assurances about the content.

## Using Intel® Wireless Display

Intel® Wireless Display (Intel® WiDi) is supported on this TV. You can use your TV as second display for Intel® Wireless Display ready computers.

**NOTE:** In order to use this feature, the TOSHIBA Dual Band WLAN Adaptor WLM-20U2 (not supplied) is required (see page 13).

- 1** Press **MENU** / ◀▶ to highlight **Function** icon.
- 2** Press ▲ / ◀▶ to highlight **Intel® Wireless Display** icon and press **OK**.  
A prompt will appear on the TV screen. Select **Yes**.
- 3** Launch the Intel® WiDi software on your PC/Control device and select “scan for available adaptors”.  
Intel® WiDi device name and ID list will then be displayed on the PC/Control device screen.  
Select the TV which you wish to connect to.  
“Connecting” will be shown on the TV.

### **4** Connecting your PC to your TV the first time:

When selecting the Toshiba TV for the first time, a 4-digit code will appear on your TV screen. This code needs to be inputted into your computer to authenticate the connection.

#### **If authentication has already taken place:**

“Connected to Intel® Wireless Display. Please Wait” will appear on screen.

- 5** After the Intel® WiDi connection is complete, the TV screen will mirror the content shown on the PC screen.

#### **NOTE:**

- When connecting Intel® WiDi, PC must have power turned on.
- When the Intel® WiDi software is active, other TV network connections are not available.
- When the Intel® WiDi software is active, other applications may not be usable.
- Intel® WiDi device name of the TV can be changed from the Intel® WiDi software.

### **To exit Intel® Wireless Display**

Exit Intel® Wireless Display by pushing the disconnect button on Intel® WiDi software or by pressing **EXIT** on the TV remote control.

**NOTE:** If the PC has been inactive for some time, the Intel® WiDi connection will be disconnected automatically.

## Intel® Wireless Display Device Name

*The TV's device name can be changed.*

- 1** In the **Preferences** menu, press ▲ or ▼ to select **Setup** and press **OK**.
- 2** Press ▲ or ▼ to highlight **Intel® Wireless Display Setup** and press **OK**.
- 3** Highlight the **Intel® Wireless Display Name** and press **OK**.  
The Software Keyboard window will appear.
- 4** Input the Device Name by using the software keyboard (see page 38). Press the **BLUE** button.
- 5** Highlight **Done** and press **OK** to save your setting.

## PC List

*PC List displays a list of MAC addresses for previously connected PC/Control devices that have been connected before. The maximum number that can be stored is 20.*

If the list run out of space, the least-recently-used MAC address will be deleted and the new MAC address added automatically.

- 1** In the **Intel® Wireless Display Setup** screen, highlight the **PC List** and press **OK**.  
PC List will appear.

The registered PC/Control devices can be deleted one by one by pressing **RED** key in the List.

When doing so the following text can be seen “Do you want to unregister this PC? Yes/No” (default cursor is “No”).



## Using the Media Player

This TV allows you to enjoy movie, music and photo files stored on a USB device connected to the USB port.

Moreover, you can also play photos, movies or music files from your PC by connecting the TV to your home network.

### Terminology:

DMP: DLNA CERTIFIED™ Player

DMS: DLNA CERTIFIED™ Server

- DMP: The TV can control and play content from a DMS.
  - A DMS is a device that can function as a server for DMP.

### NOTE:

- Do not insert/remove USB device while in use.
- MENU is not available during playback.

### Media Player Specifications

#### Device

USB device

Interface version: USB2.0 HS

USB Mass Storage Class devices (MSC)

#### NOTE:

- Connectivity is not guaranteed for all devices.
- Incorrect behaviour may occur with a USB hub connection.

File system: FAT16 and FAT32

Maximum memory size: Unlimited

DLNA CERTIFIED™ Server: Your PC (for example)

You must obtain any required permission from copyright owners to download or use copyrighted content. TOSHIBA cannot and does not grant such permission.

## Basic operation

### Using Media Player with USB

When Auto Start is enabled, you will be asked if you want to start the Media Player whenever a USB device is inserted. If Auto Start is disabled (or if you want to connect to a DMS on the network), you must manually start the Media Player from the menu.

#### To change the Auto Start setting:

- 1 Press **MENU** / **◀▶** to highlight **Media Player** icon.
- 2 Press **▲** / **◀▶** to highlight **USB Media Player** and press **OK**.

- 3 Press **▲** or **▼** to select **Media Player setup** and press **OK**.

- 4 Press **▲** or **▼** to select **USB Auto Start** and press **◀** or **▶** to select **On** or **Off**.

#### Auto Start:

- 1 Insert USB device into the USB socket on the left side of the TV. A prompt will appear.
- 2 Press **◀** or **▶** to select **Yes** and press **OK**.
- 3 Press **▲** or **▼** to select **Photo**, **Movie**, or **Music** and press **OK**.
- 4 Select the connected USB device and press **OK**.

**Multi View** will appear.

**NOTE:** If **Auto Start** is set to **Off**, you can start the Media Player manually.

#### Manual Start:

- 1 Insert USB device into the USB socket on the left side of the TV.
- 2 Press **MENU** / **◀▶** to highlight **Media Player** icon.
- 3 Press **▲** / **◀▶** to highlight **USB Media Player** and press **OK**.
- 4 Press **▲** or **▼** to select **Photo**, **Movie** or **Music** and press **OK**.
- 5 Select the connected USB device and press **OK**.

**Multi View** will appear.

#### To select a file in the Multi View:

- 1 Press **▲▼◀▶** to select a file or folder.
- 2 Press **OK** to move to the next layer, or press **BACK** to return to the previous layer.

**NOTE:** You can also return to the previous layer by selecting the icon at the top left of the **Multi View** screen and pressing **OK**.

#### To close the Media Player:

- 1 Press **EXIT**.

## Using the Media Player with a DLNA CERTIFIED™ Server

You need to configure a home network before using this feature (see page 13).

- 1 Press **MENU** / ◀▶ to highlight **Media Player** icon.
- 2 Press ▲/◀▶ to highlight **Network Media Player** and press **OK**.
- 3 Select the server you want to use and press **OK**.

**Multi View** will appear.

### Multi View (DMS)

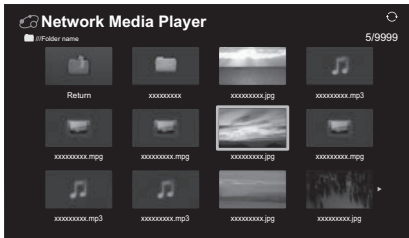

Photo, Movie and Music files and folders are displayed in the **Multi View** (DMS).

Files are displayed according to the type first selected (**Photo**, **Movie** or **Music**).

e.g. If you first selected a Photo file, only Photo files will be displayed.

### To select a file in the Multi View:

- 1 Press ▲▼◀▶ to select a file or folder.
- 2 Press **OK** to move to the next layer, or press **BACK** to return to the previous layer.

**NOTE:** You can also return to the previous layer by selecting the icon at the top left of the **Multi View** screen and pressing **OK**.

### To close the Media Player:

- 1 Press **EXIT**.

## Viewing photo files (on a DLNA CERTIFIED™ Server or USB device)

*There are three types of viewing modes.*

### Multi View (USB Photo)

This view allows you to search for photos in a grid format. The pictures are displayed using thumbnail data in each image file.

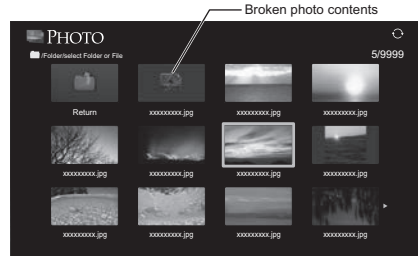

The initial highlighted position will be on the top left thumbnail in the Multi View.

- 1 Press ▲▼◀▶ to move the highlight in one window. If all of the photos will not fit in one screen, when pressing ◀ at the top left thumbnail, the screen will move to the previous page. Conversely, when pressing ▶ at the bottom right thumbnail, the screen will move to the next page.

**P▲P▼** buttons can be used to page up/down the **Multi View** when there are more photos than will fit onto one screen. When the **P▲P▼** buttons are pressed, the highlight shall be on the photo at the top left of Previous/Next **Multi View**.

### NOTE:

- The page down function on the last page and page up function on the first page are not available.
- The remote control CT-90420 does not have ◀◀ / ▶▶ / ⤴ / ⤵ buttons.

- 2 When you select a folder, press **OK** to move to the next layer. Press **BACK** to move back to the previous layer.
- 3 Press **OK** to view the selected photo in Single View mode.

## Single View

In this mode, only files located in the selected directory will be displayed. This view allows you to change the photo content manually. When moving from Multi View to Single View, the currently selected photo will be displayed.

- 1 Press **▶** to view the next photo. Press **◀** to view the previous photo.
- 2 Press **▲** to rotate the image 90° clockwise. Press **▼** to rotate the image 90° counterclockwise.
- 3 Press **i+** to display file status information (file number, photo title, resolution etc.).

**NOTE:** The information may not be correctly displayed depending on the contents or DMS.

## Slide Show

This view allows you to watch a slide show of your photos. In this mode, only files located in the selected directory will be played.

- 1 To start slide show, press **OK** in the Single View mode.
- 2 Press **◀** or **▶** to view the previous/next photo.
- 3 Press **i+** to display file status information.

**NOTE:** Pressing **▲** or **▼** while in the **Slide Show** mode will stop the slideshow and rotate the photo.

## To set Interval Time and Repeat settings:

- 1 Press **QUICK** to open the **Quick Menu**.
- 2 Press **▲** or **▼** to select either **Interval Time** or **Repeat**.
- 3 Press **◀** or **▶** to adjust the setting and press **OK**.

**NOTE:** When in the DMS and **Multi View** modes, this feature cannot be used.

## To set Background Music (USB only)

- 1 Press **QUICK** to open the **Quick Menu** while in the Slide Show mode.
- 2 Press **▲** or **▼** to select **Background Music** and press **◀** or **▶** to select **On**.

The music file in the same folder as the displayed photo will start playing.

### NOTE:

- When the music file repeat mode is set to **All** (see page 55), all the music files in the same folder as the photo will be played repeatedly.
- To stop music file playback, select **Off** in **Background Music**.

## To zoom in/out photos

During the Single View mode or Slide Show mode, the zoom function can be used.

### RED button (Zoom in)

**USB:** x1 → x2 → x4 → x8 zoom

**DMP:** x1/8 → x1/4 → x1/2 → x1 → x2 → x4 → x8 zoom

### GREEN button (Zoom out)

**USB:** x8 → x4 → x2 → x1 zoom

**DMP:** x8 → x4 → x2 → x1 → x1/2 → x1/4 → x1/8 zoom

**BACK button:** Normal playback

**▲ ▼ ◀ ▶ buttons:** Vertical or Horizontal scrolling

**NOTE:** Using the zoom function while in the **Slide Show** mode will stop the slideshow and zoom in/out the photo.

### To select a photo from Play List

While in the **Single View** mode or **Slide Show** mode, you can select a different photo from the **Play List**.

- 1 Press **QUICK** to open the **Quick Menu** from **Single View** mode or **Slide Show** mode.
- 2 Press **▲** or **▼** to select **Play List** and press **OK**.  
The Photo List will appear.
- 3 Press **▲** or **▼** to select a file name.

### To close the Photo Viewer

- 1 Press **EXIT**. The television will return to the last viewed channel or external input.

### File Compatibility

See page 79.

## Viewing movie files (on a DLNA CERTIFIED™ Server or USB device)

You can select movies from a **Multi View** of available files.

### Multi View (USB Movie)



- 1 Press **▲▼◀▶** to select a file or folder. **P▲P▼** buttons can be used to page up/down the **Multi View** when there are more files than will fit onto one screen.

**NOTE:** The page down function on the last page and page up function on the first page are not available.

- 2 When you select a folder, press **OK** to move to the next layer. Press **BACK** to move back to the previous layer.

- 3 With the desired file selected, press **OK** or **▶** (play) to start playback.

**NOTE:**

- On preview screen, if you highlight the file without pressing **OK**, the content is played on a preview screen. When **OK** is pressed, it is played in full screen mode.
- Depending on the file size, it may take some time to start playback.

- 4 Press **■** to stop playback.

**NOTE:**

- If playback finishes before **■** is pressed, the screen will return to the **Multi View**.
- Depending on the file size, it may take some time for playback to begin.

### During playback:

- Press **IIII** to pause.  
PAUSE may not be available depending on the contents or DMS.
- To resume normal playback, press **▶** (play).
- To play in fast reverse or fast forward directions, press **◀◀** or **▶▶** during playback. Each time you press the **◀◀** or **▶▶**, the playback speed will change.
- To locate a specific file, press **◀◀** or **▶▶** repeatedly.
- Press **(+)** to display the file status information (content number, movie title, progress time etc.).

#### NOTE:

- The information may not be correctly displayed depending on the contents or DMS.
- During playback, you can adjust the **PICTURE** and **SOUND** menu functions from the **Quick Menu**.
- The playback speed (**◀◀**/**▶▶**) may not change depending on the stream.

### To select subtitle and audio languages (USB only)

- Press **SUBTITLE** repeatedly to select your preferred subtitle language.
- Press **◻/II** repeatedly to select your preferred audio language.

**NOTE:** This feature is not available depending on the contents.

### To set the repeat mode

- 1 Press **QUICK** to open the **Quick Menu**.
- 2 Press **◀** or **▶** to select **Off**, **All** or **1**.

Mode	Description
<b>Off</b>	The file is played back only once.
<b>All</b>	Files in the same folder are repeatedly played back.
<b>1</b>	The same file is repeatedly played back.

- 3 Press **BACK**.

**NOTE:** When in the DMS and **Multi View** modes, this feature cannot be used.

### Resume Play (USB only)

You can resume playback from where it was last stopped.

Press **■** while playing the movie to memorize the stopped position.

On the **Multi View** screen, if you select a movie whose stopped position has been memorized, the message "Resume Play?" will appear. Select **Yes** to resume playback from the last stopped position.

**NOTE:** If you play different content or exit **Media Player**, the memorized stopped position will be deleted.

### To select a movie from Play List

While playing a movie, you can select a different movie from the **Play List**.

- 1 Press **QUICK** to open the **Quick Menu**.
- 2 Press **▲** or **▼** to select **Play List** and press **OK**.

The Movie List will appear.

- 3 Press **▲** or **▼** to select a file name.

### To close the Movie Viewer

- 1 Press **EXIT**.

### File Compatibility

See page 79.

## To register your TV to a DivX® account

This TV allows you to play back files purchased or rented from DivX® Video-On Demand (VOD) services. When you purchase or rent DivX® VOD files on the internet, you will be asked to enter a registration code.

- 1 In the **Media Player Setup** menu, press ▲ or ▼ to display **DivX® VOD** and press **OK**.
- 2 Press ▲ or ▼ to highlight **DivX® VOD Registration** and press **OK**.

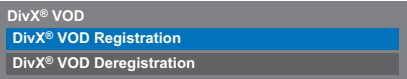

DivX® VOD  
**DivX® VOD Registration**  
 DivX® VOD Deregistration

- 3 The **DivX® VOD** window will appear and you will see the registration code. For details on registration, please visit the DivX® website at

<http://vod.divx.com>

- 4 Copy the activation file to a memory device and play it on the TV.

## To deregistration your device

- 1 In step 2 above, highlight **DivX® VOD Deregistration**, and then press **OK**.
- 2 A confirmation message will appear. Select **Yes** and press **OK**.
- 3 The **DivX® VOD** window will appear and you will see the deregistration code. For details on registration, please visit the DivX® website at

<http://vod.divx.com>

**ABOUT DIVX VIDEO:** DivX® is a digital video format created by DivX, LLC, a subsidiary of Rovi Corporation. This is an official DivX Certified® device that plays DivX video. Visit [divx.com](http://divx.com) for more information and software tools to convert your files into DivX videos.

**ABOUT DIVX VIDEO-ON-DEMAND:** This DivX Certified® device must be registered in order to play purchased DivX Video-on-Demand (VOD) movies. To obtain your registration code, locate the DivX VOD section in your device setup menu. Go to [vod.divx.com](http://vod.divx.com) for more information on how to complete your registration.

DivX Certified® to play DivX® video up to HD 1080p, including premium content.

## To playback DivX Plus HD content:

- To play in fast reverse or fast forward directions, press ◀◀ or ▶▶ during playback. Each time you press the ◀◀ or ▶▶, the playback speed will change.
- This TV generates original chapter point in 10% increments for 10 chapters in total, that are accessible by using the **Number** buttons on the remote control.

During playback, press ▶▶ to skip to the beginning of the next chapter. When ▶▶ is pressed twice in succession, it will repeat two times of above. If ▶▶ is pressed at the last chapter, playback will skip to the beginning of the next content.

Press ◀◀ to skip to the beginning of the current chapter. When ◀◀ is pressed twice in succession, it will skip to the beginning of the previous chapter. If ◀◀ is pressed twice in succession at the first chapter, stop playing the current content and skip to the beginning of the previous content.

The **Number** button is used for direct jump. If the 3 button is pressed, playback will jump to the beginning of 3rd chapter. Even if the playback content has authored chapters, the **Number** button is used to jump directly to Auto Generated Chapter.

If the content has Authored Chapters, ◀◀ / ▶▶ are using for Authored Chapters.

### NOTE:

- Depending on the content data will not be operated.
- The playback speed (◀◀ / ▶▶) may not change depending on the stream.

## Using Multi Title and Alternative Timelines Multi Title

DivX Plus HD files may contain up to 100 titles.

You can change the title (It contains same video file) by pressing the **RED** button.

When the **RED** button is pressed, it will display the title change window at the bottom on the screen (same as Subtitle or Audio change window).

The title is changed cyclically each time the **RED** button is pressed. Playback will start from start time of selected title every ▲ or ▼.

**NOTE:** Depending on the content data will not be operated.

## Playing music files (on a DLNA CERTIFIED™ Server or USB device)

You can listen to music from a **Multi View** of available files.

### Multi View (USB Music)



- 1 Press **▲▼◀▶** to select a file or folder. **P^Pv** buttons can be used to page up/down the **Multi View** when there are more files than will fit onto one screen.

**NOTE:** The page down function on the last page and page up function on the first page are not available.

- 2 When you select a folder, press **OK** to move to the next layer. Press **BACK** to move back to the previous layer.

- 3 With the desired file selected, press **OK** or **▶** (play) to start playback.

**NOTE:** If you highlight the file without pressing **OK**, the content is played on a **Multi View**. When **OK** is pressed, it is played in full screen mode.

- 4 Press **■** to stop playback.

#### NOTE:

- Depending on the file size, it may take some time for playback to begin.
- During playback, you can adjust the **SOUND** menu functions from the **Quick Menu**.

#### During playback:

- Press **||/▶** to pause.
- To resume normal playback, press **▶** (play).  
PAUSE may not be available depending on the contents or DMS.
- To play in fast reverse or fast forward directions, press **◀◀** or **▶▶**. Each time you press **◀◀** or **▶▶**, the playback speed will change.

#### To set the repeat mode:

- 1 Press **QUICK** to open the **Quick Menu**.
- 2 Press **▲** or **▼** to select **Repeat**.
- 3 Press **◀** or **▶** to select **Off**, **All** or **1**.

Mode	Description
<b>Off</b>	Files in the same folder are played back once.
<b>All</b>	Files in the same folder are repeatedly played back.
<b>1</b>	The same file is repeatedly played back.

- 4 Press **BACK**.

**NOTE:** When in the DMS and **Multi View** modes, this feature cannot be used.

#### To select a music file from Play List

While playing a music file, you can select a different music file from the **Play List**.

- 1 Press **QUICK** to open the **Quick Menu**.
- 2 Press **▲** or **▼** to select **Play List** and press **OK**.  
The Music List will appear.
- 3 Press **▲** or **▼** to select a file name

#### To display the file status information

- 1 Press **i+** during playback. The information will be displayed on the bottom of the screen.
- 2 Press **i+** again to remove the information.

**NOTE:** The information may not be correctly displayed depending on the contents or DMS.

#### To close the Music Player:

- 1 Press **EXIT**.

#### File Compatibility

See page 79.

## Other features

### Panel Lock

**Panel Lock** disables the buttons on the television. All buttons on the remote control can still be used.

- 1 Press **MENU** / ◀▶ to highlight **Setup** icon.
- 2 Press ▲ / ◀▶ to highlight **Preferences** icon and press **OK**.
- 3 Press ▲ or ▼ to select **Panel Lock**.
- 4 Press ◀ or ▶ to select **On**.

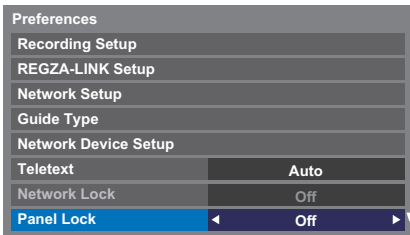

When **Panel Lock** is **On**, a reminder will appear when the buttons on the television are pressed. **If the standby button is pressed, the television will switch off and can only be brought out of standby by using the remote control.**

## The timers

### Programme Timers – digital only

*This feature will set the television to go to a specific channel at a certain time. It can be used to view a particular programme, or by setting the mode to daily or weekly, can be used to view a series of programmes.*

- 1 Press **MENU** / ◀▶ to highlight **TV Programmes** icon.
- 2 Press ▲ / ◀▶ to highlight **Programme Timers** icon and press **OK**.
- 3 Press ▼ if necessary to select an open timer position, then press **OK**. The **Edit Timer** menu will now appear on screen.
- 4 Press ▲ and ▼ to go through the list adding the details of the programme by using the number buttons and ◀ and ▶ to make selections.

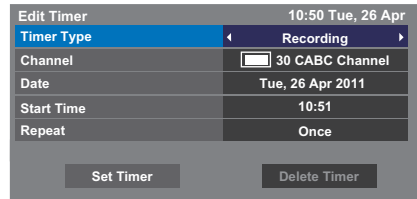

- 5 When all of the details have been entered, highlight **Set Timer** and press **OK** to save the timer.  
The ORANGE programme timer indicator on the front of the television will be lit (see page 74 for details).



## On Timer

The feature allows you to set the television to turn on automatically to a preset channel at a certain time of day or after a certain length of time.

- 1 Press **MENU** / ◀▶ to highlight **Function** icon.
- 2 Press ▲ / ◀▶ to highlight **On Timer** icon and press **OK**.
- 3 Press ▲ or ▼ to select **Enable On Timer** and press ◀▶ to select **On**.



- 4 Press ▼ to select **Enable DTV Clock**, and then press ◀▶ to select **On** or **Off**.
- 5 Press ▲ or ▼ to go through the list adding the details of the On Timer by using the number buttons and ◀▶ to make selections.

**Power On Time** (only for DTV Clock On mode): Set the time you prefer with the number buttons.

**Repeat** (only for DTV Clock On mode): Select the desired On Timer operation (**Once, Every Day, Mon-Fri, Mon-Sat, Sat-Sun**).

**Input**: Select a video input source (ATV, DTV Ant, EXT 1, EXT 2, HDMI 1, HDMI 2, HDMI 3 or PC).

**Channel**: Set the channel that will be tuned when the television turns on.

**NOTE**: When an external input is selected in the **Input** field, a channel cannot be selected.

**Volume**: Set the volume that will be applied when the television turns on.

**Time until Power On** (only for DTV Clock Off mode): Set the amount of time from now until the TV turns on using the number buttons (maximum of 12 hours).

- 6 Press ▲ or ▼ to highlight **Done** and press **OK**.

## To cancel the On Timer

- 1 In the **On Timer** menu, select **Enable On Timer**.
- 2 Press ◀▶ to select **Off**.
- 3 Press ▲ or ▼ to highlight **Done** and press **OK**.

## Sleep Timer

The television can be set to turn itself **Off** after a certain length of time.

- 1 Press **MENU** / ◀▶ to highlight **Function** icon.
- 2 Press ▲ / ◀▶ to highlight **Sleep Timer** icon and press **OK**.
- 3 Use the number buttons to set the desired time. For example, to switch the television off in one and a half hours enter 01:30, or press ▶ / ◀ to increase/decrease in steps of 10 minutes. (Maximum time setting is 12 hours)
- 4 Press **EXIT** to finish.
- 5 To cancel the **Sleep Timer**, enter all zeros for the above setting.

## Energy Saving Settings

### Automatic Power Down

The TV will automatically turn itself off (standby) after 4 hours, if you do not operate the TV either from the remote control or the TV control panel.

- 1 Press **MENU** / **◀▶** to highlight **Setup** icon.
- 2 Press **▲** / **◀▶** to highlight **Preference** icon and press **OK**.
- 3 Press **▲** or **▼** to select **Energy Saving Settings** and press **OK**.
- 4 Press **▲** or **▼** to select **Automatic Power Down**.
- 5 Press **◀▶** to select **On** or **Off**.

#### NOTE:

- This feature is set to **On** when **Location** is set to **Home**.
- 1 minute before switching to standby, a Warning message will appear.
- When the following features are set, the feature that is set for the nearest time will function.
  - Automatic Power Down
  - Sleep Timer
  - Auto shutdown after 1 hour of inactivity (after power on by On Timer)
  - No signal auto power off (after 15 minute of no signal)

### No Signal Power Down

The TV will automatically turn itself off after 15 minutes when no signal is detected. You can change the setting to Off for the following purposes:

- Low signal strength of analog channel (no signal detection)
- Only Audio L/R is connected to external input to listen to music through the TV speakers.

- 1 In the **Energy Saving Settings** menu, press **▲** or **▼** to select **No Signal Power Down** and press **OK**.
- 2 Press **▲** or **▼** to select the item you want to change and press **◀▶** to select **On** or **Off**.

#### NOTE:

- Default setting is all On.
- A warning message will appear 1 minute before turning off.

## Digital on-screen information

When viewing in **digital** mode, the on-screen information and programme guide provide access to programme details for all available channels.

### Information

- 1 Press **i+**, the information screen will appear giving details of the channel and programme currently being viewed.

#### Display Example

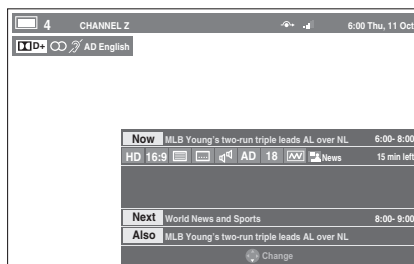

- 2 Press **▲** or **▼** to select the **"Now"**, **"Next"** or **"Also"** information guide.

The selected information content will appear.

- 3 To record the next scheduled programme, select **Next** and press **OK**. The **Edit Timer** screen will appear.

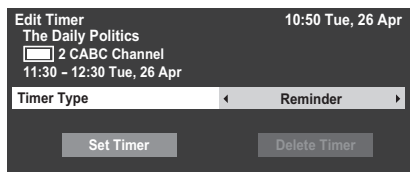

- 4 The details of the programme will already have been added to the timer. Highlight **Set Timer** and press **OK** to save.

To indicate that a Recording Timer has been set, a clock icon will be displayed in the **Next** fields of the information screen. A check mark will appear if the timer is a Reminder Timer.

## To display More Information

- 1 Press **QUICK** to open the **Quick Menu**.
- 2 Press **▼** to highlight **More Information** and press **OK**.

## On-screen Information icons

	Icon	Description
Service info		Service type (TV, Radio, Text)
		Skip
Audio info		Mono
		Stereo
		Dual mono
		Multichannel
		Dolby Digital
		Dolby Digital+
		When HE-AAC is decoded
		Audio Description
Audio/Subtitle info		For Hard of Hearing
Recording info		Recording + Service info
Event info		Video format (HD, SD)
		Video Aspect
		Teletext
		Subtitle (Single, Multi)
		Audio track (Mono, Multi)
		Parental rating
		Encrypted
Timer info		Recording
		Reminder

## Using EPG (Electronic Programme Guide)

You can choose the desired EPG system between the **Broadcast Guide** or **MediaGuide** that needs a internet connection.

### Using Broadcast Guide

Make sure you selected **Broadcast Guide** in the **Guide Type** menu of **Initial Setup** (see page 18.) This setup can also be done from the **Setup / System Setup / Quick Setup** menu or **Setup / Preferences / Guide Type** menu any time.

- 1 Select the on-screen Guide by pressing **GUIDE**, and the Guide screen will appear highlighting details of the channel and programme currently being viewed. This may take a few moments to appear.

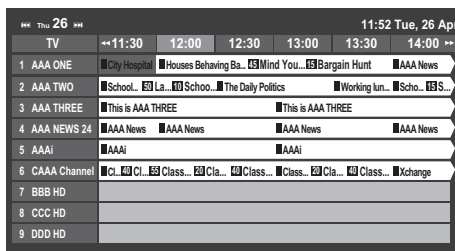

You can switch the time scale to 1.5 or 3 hours by pressing the **GREEN** button.

- 2 Press **◀** or **▶** for information on other programmes scheduled for the channel selected. To highlight the first programme in the genre grid, press the **RED** button.
- 3 For details of other programmes currently available, press **▲** and **▼** to scroll up and down the channel list. As channels are selected, details of the programme currently being broadcast will appear. Press **◀** or **▶** to view information for future programmes.
- 4 For information on a highlighted programme, press **i+**.
- 5 To set the timer for that programme, press the **BLUE** button to bring up the **Programme Timers** menu.
- 6 Press **Pv** to advance to the next page, or press **Pa** to go back to the previous page.

## Genre selection/searching

From the Guide screen, you can use the genre selection and search features.

- 1 In the Guide screen, press **QUICK**.
- 2 Press **▲** or **▼** to highlight **Genre Colour** in the **Quick Menu** and press **OK**.

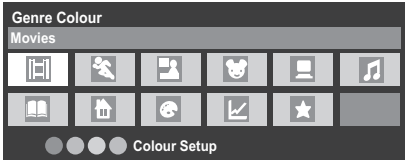

- 3 With the focus on a particular genre, press the desired coloured button to assign. Four colours will be available to set. Press **BACK** to go back to the Guide screen.

## Using MediaGuide

MediaGuide is a service of Rovi Corporation. This service is an integrative media guide through the Internet besides television contents and internet contents.

**NOTE:**

- You need to configure a home network before using this feature (see page 13).
- Make sure you selected **MediaGuide** in the **Guide Type** menu of Initial Setup (see page 18.) This setup can also be done from the **Setup / System Setup / Quick Setup** menu any time.

## MediaGuide screen

- 1 Press **GUIDE** on the remote control, or select **Guide** in the **TV Programmes** menu and press **OK**.

The **Listings** menu in the Secondary Navigation will be selected.

Default focus position is the current channel.

### Remote control key operation



This will tune to live TV for the particular show.

If the show is not being aired, you will be directed to the Overview screen with upcoming show times.

## Primary Navigation menu

- 1 In the Secondary Navigation menu, press **◀** to expand the Primary Navigation menu.

### Primary Navigation

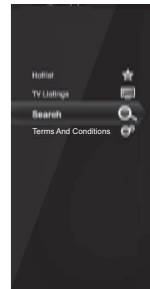

### Hotlist

Press **▲** or **▼** to select **Hotlist** and press **OK**. Shows will be listed. Selecting a movie or show will bring you to the overview page.

### Search

Press **▲** or **▼** to select **Search** and press **OK**.

### Terms And Conditions

Press **▲** or **▼** to select **Terms And Conditions**. The License Terms And Conditions will be displayed.

### Search screen

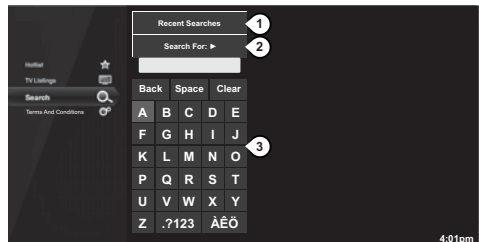

① Recent Searches button. Pressing **OK** will take you to the Recent Searches screen.

② Search input area displays what you are typing. Pressing **Search For** will conduct the search and take you to Search Results.

③ Search keyboard.

**NOTE:**

- Toshiba does not take responsibility for the accuracy of content displayed.
- Service Information may not be displayed or there may be little service information displayed depending on the area or the kind of broadcast.
- The MediaGuide can only be used when your TV is connected to the internet.
- Starting and operation of this service may take time.
- Software update may be needed in order to use this service.
- This service does not support all languages.
- MediaGuide is a service of Rovi Corporation.
- During use of the MediaGuide usage information will be notified to the Rovi server to ensure continued efficient operation of the guide.

- Rovi Corporation and/or its subsidiaries and related affiliates are not in any way liable for the accuracy or availability of the program schedule information or other data in the Rovi Guide system and cannot guarantee service availability in your area. In no event shall Rovi Corporation and/or its related affiliates be liable for any damages in connection with the accuracy or availability of the program schedule information or other data in the Rovi Guide system.
- Third party internet services are not provided by Toshiba, may change or be discontinued at any time and may be subject to internet service provider restrictions. Toshiba makes no warranties, representations, or assurances about the content, availability or functionality of third-party content or services. Use of third party internet services may require the creation of a separate account through a computer with internet access and/or payment of one-time and/or recurring charges and membership. Not all third party services may be available on or compatible with this product. In order to experience the full suggested capabilities of this product, fully-compatible devices may be required.

## Digital settings – parental control

In order to prevent viewing of unsuitable films and programmes, channels and menus can be locked in digital mode. These can then only be accessed with a security code PIN.

### Parental PIN Setup

- 1 Press **MENU** / ◀▶ to highlight **Setup** icon.
- 2 Press ▲ / ◀▶ to highlight **System Setup** icon and press **OK**.
- 3 Press ▲ or ▼ to select **DTV Settings** and press **OK**.

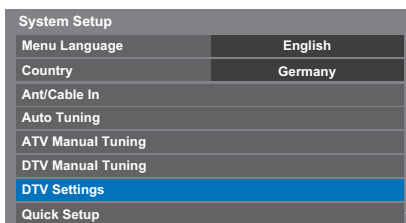

- 4 Press ▲ or ▼ to highlight **Parental PIN Setup** and press **OK**.

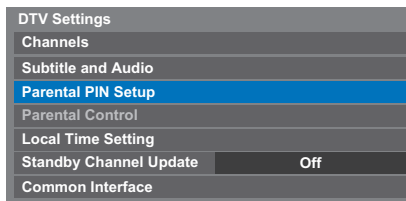

- 5 Using the number buttons enter a four digit number. Once entered you will be prompted to confirm by entering again.



The PIN number is now set.

If the PIN code has been set, when **Auto Tuning** and **Reset TV** are executed, entering the PIN will be necessary. "0000" is not acceptable.

## Parental Setup

The **Parental Control** feature allows you to block programmes according to their rating levels. If a PIN has been set, you will need to enter it before adjusting the level.

- 1 In the **DTV Settings** menu, press **▲** or **▼** to select **Parental Control** and press **OK**.
- 2 Use **◀** or **▶** to choose an option (**None** or an age setting (4-17 or 4-18 depending on the **Country** setting)).



To view blocked programmes, enter the PIN. To reactivate the Parental Control, turn the TV off and then on again.

## Network Lock

You can **use** the **Network Lock** feature to prevent the Web browser from launching. When this feature is set to **On**, PIN input will be necessary to use network functions.

This feature will be grayed out until a PIN is set.

- 1 Press **MENU** / **◀▶** to highlight **Setup** icon.
- 2 Press **▲** / **◀▶** to highlight **Preferences** icon and press **OK**.
- 3 Press **▲** or **▼** to select **Network Lock**.

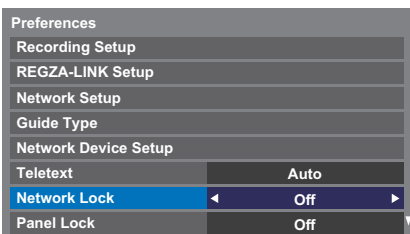

- 4 Press **◀** or **▶** to select **On**.

### To unlock the Network:

- 1 Select **Off** in step 4 above.

## Digital settings – Channel Options

### Selecting favourite channels

From the **Quick Menu** / **Channel Options** menu, it is possible to create a list of the digital channels that are watched most. Press **LIST** / **◀▶** to select the Favourite Channel list.

- 1 Select a channel you want to add to your favourite list.
- 2 Press **QUICK** to open the **Quick Menu**.
- 3 Press **▼** to select **Channel Options** and press **OK**.
- 4 Press **▶** to select the favourite list (Fav.).

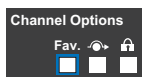

- 5 Press **OK** to select the ones required. A tick will appear in the box as they are selected.
- 6 Repeat steps 1 through 5 for other channels.
- 7 When all favourites have been selected, press **EXIT**.

### Favourite Channel Lists

- 1 Press **LIST** to display **Channel List**.  
Each time you press **◀** or **▶**, **All Channels**, **TV Channels**, **Radio channels**, **Text channels** or **Favourites** is selected in order.
- 2 Press **◀** or **▶** to select **Favourites**. The number of favourites available depends on how many lists have been created.

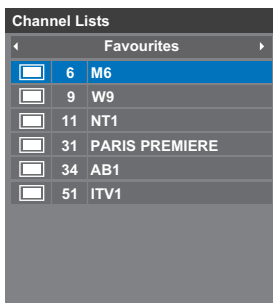

- 3 Press **▲** or **▼** to highlight a channel and press **OK** to watch.

## Skip channels

This feature allows you to set channels that will be skipped when **P** or **P** are used to tune.

- 1 Select the channel you want to skip in your channel list.
- 2 From the **Quick Menu**, press **▼** to select **Channel Options** and press **OK**.
- 3 Press **▶** repeatedly to highlight the skip (↺) box.
- 4 Press **OK** to select. A tick will appear in the box.
- 5 Repeat steps 1 through 4 for other channels.
- 6 Press **EXIT**.

**NOTE:** Skipped channels cannot be selected by **P** or **P** but still be accessed by direct number entry (when tuned a ↺ icon will be displayed in the banner to indicate as a skipped channel).

## Locking channels

**Locking Channels** stops the viewing of **digital** channels, and they can only be accessed by entering the **PIN**.

- 1 Select the channel you want to lock in your channel list.
- 2 From the **Quick Menu**, press **▼** to select **Channel Options** and press **OK**.
- 3 Press **▶** repeatedly to highlight the lock (🔒) box.
- 4 Press **OK** to select. A tick will appear in the box.  
If a PIN has already been set, PIN entry will be required to set the locked channels.
- 5 Repeat steps 1 through 4 for other channels.
- 6 Press **EXIT**.
- 7 From this point on, when any of the channels in the **Locked Channel** list are selected, the PIN must be entered before they can be accessed.

## Digital settings – other settings

### Subtitles

In **digital mode**, this feature will show subtitles on the screen in the selected language provided they are being broadcast.

- 1 In the **DTV Settings** menu, press **▲** or **▼** to select **Subtitle and Audio** and press **OK**.
- 2 Press **▼** to select **Subtitle Display** and press **◀** or **▶** to select **On** or **Off**.

Subtitle and Audio	
Subtitle Display	◀ Off ▶
Subtitle Type	Normal
Primary Subtitle Language	English
Secondary Subtitle Language	English
Audio Type	Normal
Primary Audio Language	English
Secondary Audio Language	English

- 3 Press **▲** or **▼** to select **Primary Subtitle Language** or **Secondary Subtitle Language** and press **◀** or **▶** to select an option.

The **SUBTITLE** button can be used to select subtitle on or off for the current channel only and to select the subtitle language if more than one subtitle is available.

### Audio languages

This feature allows a programme or film to be viewed with a choice of soundtrack language, provided multiple language tracks are being broadcast.

- 1 In the **Subtitle and Audio** menu, press **▲** or **▼** to select **Audio Type** and press **◀** or **▶** to select **Normal** or **For Hard of Hearing**.
- 2 Press **▲** or **▼** to select **Primary Audio Language** or **Secondary Audio Language** and press **◀** or **▶** to select an option.

If more than one soundtrack is available, use the **◻/◻** button to select between them.

## Common Interface

The *Common Interface Slot*, situated on the side of the television, enables the insertion of a CAM (Conditional Access Module) and card. These are purchased from a service provider and allow additional subscription broadcasts to be viewed. For information, see a service provider.

- 1 Insert the CAM and card into the Common Interface Slot, following the instructions provided with the CAM. A box will appear on screen to confirm that the CAM has been inserted.
- 2 Press **MENU** / ◀▶ to highlight **Setup** icon.
- 3 Press ▲ / ◀▶ to highlight **System Setup** icon and press **OK**.
- 4 Press ▲ or ▼ to select **DTV Settings** and press **OK**.
- 5 Press ▲ or ▼ to select **Common Interface** and press **OK**.
- 6 Details of the CAM should now be available.

### NOTE:

- Software update of a CI Plus CAM may occur automatically if instigated by the broadcaster. This could cause the cancellation of any Reminders/Recordings during this process.
- Some CI or CI+ CAM may not be supported.
- CI+ operation is not guaranteed except for Canal Ready DTT services on suffix FC models.

## Software Upgrade and Licences

### Searching for New Software

If preferred, software upgrades can be searched for manually using **Search for New Software**.

- 1 In the **System Setup** menu, press ▲ or ▼ to select **Software Upgrade** and press **OK**.
- 2 Press ▲ or ▼ to select **Search for New Software**.
- 3 Press **OK**. The television will automatically start searching for a software upgrade, the progress bar will move along the line.



SEARCHING FOR NEW SOFTWARE  
Searching for a new software upgrade for this TV.  
48 %... CH 31

If an upgrade is found, the television will automatically start downloading. If not, a screen will appear stating that an upgrade is unavailable.

### Network Upgrade

TOSHIBA may offer upgrades for the TV's software in the future. The TV's software is upgraded via the Network.

#### Before downloading software:

Configure your TV to connect to the Internet.

**NOTE:** While the upgrade is being performed, you will not be able to watch the TV.

- 1 In the **System Setup** menu, press ▲ or ▼ to select **Software Upgrade** and press **OK**.
- 2 Press ▲ or ▼ to select **Network Upgrade** and press **OK**.  
  
**NOTE:** If the network is not available, a warning message will appear.
- 3 The TV software upgrade will start when download succeeds.

### Software Licences

The licences for the software used in this television are available for viewing.

- 1 In the **System Setup** menu, press ▲ or ▼ to select **Software Licences** and press **OK**.  
  
A screen will appear displaying all the licensing information required for the televisions software.



## System Information and Reset TV

### System Information

This feature can be used to check the version of software currently installed. When in DTV mode, it includes additional diagnostic information such as signal strength, signal quality, centre frequency, modulation, etc.

- 1 In the **System Setup** menu, press **▲** or **▼** to select **System Information**.
- 2 Press **OK** to display the **System Information**.

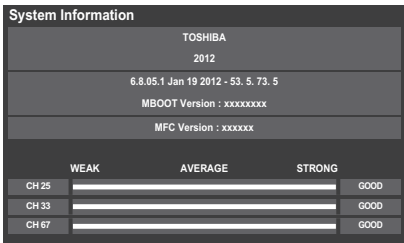

- 3 For information about the signal quality of a particular multiplex, press **▲** or **▼** to select that multiplex.
- 4 Press **OK** for a screen showing detailed technical information about the selected multiplex.

### Reset TV

Selecting **Reset TV** will reset all TV settings, including saved channels, to their original factory values.

- 1 In the **System Setup** menu, press **▲** or **▼** to select **Reset TV**.
- 2 Press **OK** to select. A screen will appear warning that all settings will be lost. Press **OK** to continue.

When the set powers back on, the **Quick Setup** screen will appear. Press **OK** to advance the setup and perform an auto tune. (See "Quick Setup" section on page 16.)

## PC Settings

### Horizontal and Vertical Position

Connect the PC (as shown in the 'Connecting a computer' section) and ensure that a picture is showing on the television screen. The picture position may now be adjusted to suit personal preference.

- 1 Press **MENU** / **◀▶** to highlight **Setup** icon.
- 2 Press **▲** / **◀▶** to highlight **Preferences** icon and press **OK**.
- 3 Press **▲** or **▼** to select **Display Settings** and press **OK**.
- 4 Press **▲** or **▼** to select **PC Setting** and press **OK**.



- 5 Press **▲** or **▼** to select an option and press **◀▶** to adjust the settings.

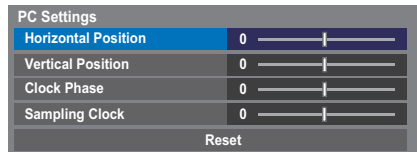

### Clock Phase

The **Clock Phase** matches the PC signal with the LCD display. Adjusting this can clear horizontal stripes and picture blur.

- 1 In the **Display Settings** menu, press **▲** or **▼** to select **PC Settings** and press **OK**.
- 2 Press **▲** or **▼** to select **Clock Phase**.
- 3 Press **◀▶** to adjust until the picture clears.

## Sampling Clock

Adjusting the **Sampling Clock** alters the number of pulses per scan, this will clear vertical lines on the screen.

- 1 In the **Display Settings** menu, press ▲ or ▼ to select **PC Settings** and press **OK**.
- 2 Press ▲ or ▼ to select **Sampling Clock**.
- 3 Press ◀ or ▶ to adjust until the picture clears.

## Reset

Use **Reset** to return all items to the original factory settings.

- 1 In the **Display Settings** menu, press ▲ or ▼ to select **PC Settings** and press **OK**.
- 2 Press ▲ or ▼ to select **Reset** and press **OK**.

**NOTE: When a PC is connected using HDMI, none of these functions will be available.**

The screen is disrupted momentarily when adjusting PC Settings. This is not a sign of malfunction.

The default settings and adjustment ranges may vary depending on the input signal format.

## Input selection and AV connections

See page 9 for a detailed image showing recommended connections.

Most media recorders and decoders send a signal through the SCART lead to switch the television to the correct *Input* socket.

Alternatively, press the external source selection button  until the picture from connected equipment is shown.



## Input selection



Use the **Input Selection** window if the television does not switch over automatically.

- 1 By pressing  on the remote control or TV, a list will appear on screen showing all inputs and external equipment.

Press  on the remote control

Press and hold  on the TV

Inputs
TV
 1
 2
HDMI 1
HDMI 2
HDMI 3
PC

Inputs
DTV Ant
 1
 2
HDMI 1
HDMI 2
HDMI 3
PC
ATV

HDMI® displays equipment connected to *Input HDMI* on the back or side of the television.

PC displays a computer connected to *Input RGB/PC* on the back of the television.

## Labeling video input sources

These input labels are shown in the input selector. You can label video inputs according to the devices you have connected to the TV.

- 1 Press **MENU** / ◀▶ to highlight **Setup** icon.
- 2 Press ▲/◀▶ to highlight **Preferences** icon and press **OK**.
- 3 Press ▲ or ▼ to select **AV Connection**.

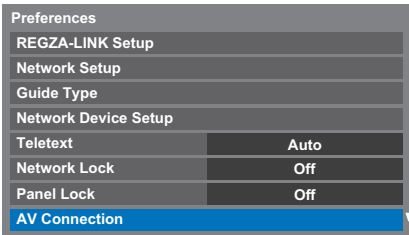

- 4 Press **OK** to display the **AV Connection** menu.
- 5 Press ▲ or ▼ to highlight **Input Labeling** and press **OK**.



- 6 Press ▲ or ▼ to select **Input Labeling** and press **OK**.

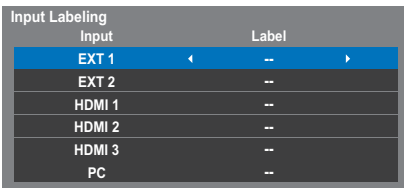

- 7 Press ▲ or ▼ to select the item you want to label, and then press ◀ or ▶ to select --, **Amplifier**, **Cable**, **DVD**, **Game**, **PC**, **Recorder** or **Satellite**.
- 8 Repeat step 7 for other video inputs.

## Digital Audio Output

When connecting a surround sound amplifier to the digital audio output (Sony/Philips Digital Interface Format [S/PDIF]), the following options can be selected or adjusted.

- 1 In the **Preferences** menu, press ▲ or ▼ to select **AV Connection** and press **OK**.
- 2 Press ▲ or ▼ to select **Digital Audio Output**.



- 3 Press **OK** to display **Digital Audio Output** menu and press ▲ or ▼ to select an option.

### Audio Format:

Press ◀ or ▶ to select **PCM** or **Auto**.

**PCM:** This mode outputs PCM format to the digital audio output socket.

**Auto:** This mode outputs Dolby Digital (if available) or PCM to the digital audio output socket.

Dolby Digital → Dolby Digital  
Dolby Digital Plus → Dolby Digital  
MPEG → PCM  
HE-AAC → Dolby Digital

### Audio Delay:

Press ◀ or ▶ to select **Auto** or **Manual**.

**Auto:** This mode automatically adjusts the audio timing to meet the video timing.

**NOTE:** The time lag might be large between the image and sound depending on the connected equipment (amplifier etc.). In that case, select **Manual**.

**Manual:** You can manually adjust the audio signal timing to meet the video signal timing.

### Delay Adjustment:

Press ◀ or ▶ to adjust the audio signal timing (0 – 250ms) to meet the video signal timing.

### NOTE:

- This feature is grayed out when **Audio Delay** is in **Auto**.
- A time lag will occur when the video signal or audio signal is changed. Adjust the timing accordingly.
- When adjusting the timing, turn down the volume of the AV equipment used as far as possible. Depending on the equipment, noise etc. may occur when the signal is changed.
- Depending on the connected equipment (amplifier, etc.), adjustment may not be possible.
- When the optical digital output setting (Auto ↔ PCM) is changed, it may be necessary to adjust the timing again.
- Do not use other than for audio output from the AV amplifier, etc. (Malfunction may occur)

## Using REGZA-LINK

This is a new feature that uses CEC technology and allows you to control Toshiba REGZA-LINK compatible devices from the television remote control via HDMI connection (page 11).

When the **Enable REGZA-LINK** item in the **REGZA-LINK Setup** menu is set to **On**, individual functions also set to **On** will be activated.

### Enable REGZA-LINK

- 1 Press **MENU** / ◀▶ to highlight **Setup** icon.
- 2 Press ▲/◀▶ to highlight **Preferences** icon and press **OK**.
- 3 Press ▲ or ▼ to select **REGZA-LINK Setup** and press **OK**.
- 4 Press ▼ to select **Enable REGZA-LINK** and press ◀ or ▶ to select **On**.

REGZA-LINK Setup	
Enable REGZA-LINK	◀ On ▶
TV Auto Power	On
Auto Standby	On
Amplifier Control	On
Initial Speaker Setting	TV Speakers

**NOTE:** If you set **Enable REGZA-LINK** to **Off**, all other items will be grayed out.

### TV Auto Power

The **TV Auto Power** setting allows the television to be automatically switched on if a REGZA-LINK device is turned on.

- 1 In the **REGZA-LINK Setup** menu, press ▼ to highlight **TV Auto Power**.
- 2 Press ◀ or ▶ to select **On** or **Off**.

### Auto Standby

When **Auto Standby** is enabled, the television, when switched off, will automatically switch off (standby mode) all connected REGZA-LINK equipment.

- 1 In the **REGZA-LINK Setup** menu, press ▼ to highlight **Auto Standby**.
- 2 Press ◀ or ▶ to select **On** or **Off**.

### Amplifier Control

When **Amplifier Control** is set to on/off the connected REGZA-LINK amplifier.

- 1 In the **REGZA-LINK Setup** menu, press ▼ to highlight **Amplifier Control**.
- 2 Press ◀ or ▶ to select **On** or **Off**.

### Initial Speaker Setting

The **Initial Speaker Setting** allows to select TV speakers or Amplifier speakers.

- 1 In the **REGZA-LINK Setup** menu, press ▼ to highlight **Initial Speaker Setting**.
- 2 Press ◀ or ▶ to select **TV Speakers** or **Amplifier**.

### REGZA-LINK input source selection

If a REGZA-LINK device with HDMI switching capability (e.g. AV amplifier) is connected to the HDMI input, you can select another REGZA-LINK device that is connected to the master HDMI device on the input source list.

- 1 Press ⏻ and a list will appear on screen showing available input sources.
- 2 Press ▼ to select the desired input source with REGZA-LINK icon.
- 3 Press ▶ and a second selection screen will appear showing all connected REGZA-LINK equipment.

Inputs	
TV	◀ 1 DVD
⏻ 1	2 VCR/DVR
⏻ 2	3 CBL/SAT
HDMI 1	4 GAME/TV
HDMI 2	5 AUX
HDMI 3	
PC	

- 4 Press ▲ or ▼ to select the desired input source, and then press **OK**.

**NOTE:**

- These functions depend on the device connected.
- If you select the REGZA-LINK input source from the popup window, some REGZA-LINK devices may automatically turn on.
- When the television is switched on it will take a few minutes for the REGZA-LINK icon to appear in the list. When an HDMI cable is removed, it will take a few minutes for the icon to disappear.
- If the HDMI cable from connected equipment is changed, **Enable REGZA-LINK** in the REGZA-LINK Setup menu may need to be reset to **On**.
- If you change the HDMI lead to a connected device or change an HDMI device setting, reset the **Enable REGZA-LINK** item on the REGZA-LINK Setup menu from **Off** to **On**.

### REGZA-LINK one touch play

When connected equipment is switched on, REGZA-LINK will automatically detect the television through the input selection. If the television is in standby, it will be switched on automatically.

These functions can be enabled or disabled from the REGZA-LINK Setup (see page 68).

**NOTE:**

- Even if the equipment is showing a menu, the television may automatically show the input source.
- This feature depends on the connected equipment and television state.

### REGZA-LINK system standby

If the television is turned off (standby mode), the television will send a message to turn off (standby mode) all of the REGZA-LINK devices connected to the television.

These functions can be enabled or disabled from the REGZA-LINK Setup (see page 68).

**NOTE:** This feature depends on the connected equipment and television state.

## Text services

This television has a multi-page text memory, which takes a few moments to load. It offers two **Modes** of viewing text – **Auto** will display **Fasttext**, if available. **List** will save your four favourite pages.

### Selecting modes

The text character set will be automatically chosen by the language setting in the **Setup** menu.

- 1 Press **MENU** / ◀▶ to highlight **Setup** icon.
- 2 Press ▲/◀▶ to highlight **Preferences** icon and press **OK**.
- 3 Press ▲ or ▼ to select **Teletext**, and then press ◀ or ▶ to select **Auto** or **List**.

Preferences	
Recording Setup	
REGZA-LINK Setup	
Network Setup	
Guide Type	
Network Device Setup	
Teletext	◀ Auto ▶
Network Lock	Off
Panel Lock	Off

### Text information

#### The TEXT button:

To view text services press **TEXT**. Press again to superimpose the text over a normal broadcast picture and again to return to normal viewing. Channels cannot be changed until text is cancelled.

The first text page shown will be the *initial* page.

Any text page can be accessed by entering the 3 digit page number using the numbered buttons, pressing the coloured buttons or pressing **P**^ to advance to the next page and **P**^ to go back to the previous page.

#### Sub-pages

The pages on the screen will dynamically update as sub-pages are received.

If you open a page containing sub-pages, the sub-pages are automatically displayed in sequence. To quit automatic sub-page change, press ◀ or ▶.

Once selected, the sub-page you are viewing will be highlighted and, as the television loads any additional sub-pages, the colour of the numbers will change, indicating that these pages have been loaded.

These sub-pages will remain available to view until another page is chosen or, in normal TV mode, the channel is changed.

### Navigating pages using Auto

If **Fasttext** is available, four coloured titles will appear at the base of the screen.

To access one of the four given subjects, press the relevant coloured button on the remote control.

For further information on your particular text system(s), see the broadcast text index page or consult your local Toshiba dealer.

### Navigating pages using LIST

The four coloured choices at the bottom of the screen are numbers – 100, 101, 102 and 103, which have been programmed into the television's memory. To view these pages, press the relevant coloured buttons.

To change these saved pages, press the relevant coloured button and enter the 3 digit number. This number will change in the top left of the screen and in the coloured highlight.

Press **OK** to save. **Whenever OK is pressed, all four page numbers showing at the bottom will be saved and the previous ones will be lost.**

**NOTE:** The video signal from the external inputs (EXT-1 and EXT-2) is not saved.

If **OK** is not pressed, the selection will be forgotten when the channel is changed.

Other pages may be viewed by entering the 3 digit page number – but DO NOT press **OK** or these pages will be saved.

## Control buttons

Below is a guide to the functions of the remote control text buttons.

### **To display the index/initial page:**

Press  to access the index/initial page. The one displayed is dependant on the broadcaster.



### **TEXT To display a page of text:**

Press **TEXT** to display text. Press again to superimpose text over a normal picture. Press again to return to normal television viewing. Channels cannot be changed until this has been done.

### **To reveal concealed text:**

To discover the solutions on quiz and joke pages press the  button.



### **To hold a wanted page:**

At times it is convenient to hold a page of text. Press  and  will appear in the top left of the screen. The page will be held on screen until the button is pressed again.

### **To enlarge the text display size:**

Press  once to enlarge the top half of the page, press again to enlarge the bottom half of the page. Press again to revert to normal size.

### **To temporarily erase the text screen:**

Press   once to erase the text screen temporarily. To recall the text screen, press the button again.

*To display news flashes:*

Select the news flash page for the chosen text service (see the index page of text service). The news flashes will be displayed as and when they are broadcast.

 **Remember to cancel text before changing channels - press the TEXT button twice.**

## Questions and Answers

Below are the answers to some of the most common queries.

**Q** *Why is there no sound or picture?*

**A** Check the television is not in standby mode. Check the mains plug and all mains connections.

**Q** *There is a picture, but why is there little or no colour?*

**A** When using an **external** source, for instance, a poor quality video tape, if there is little or no colour, improvements may sometimes be achieved. The colour is factory set to **Auto** to automatically display the best colour system.

To check that you have the best colour:

- 1 With the external source playing, select **Colour System** from the **System Setup** menu.

System Setup	
Menu Language	English
Country	Germany
Colour System	Auto

- 2 With ◀ or ▶ choose between **Auto**, **PAL**, **SECAM**, **NTSC 4.43** or **NTSC 3.58**.

**Q** *Why doesn't the video/DVD being played show on screen?*

**A** Make sure the media recorder or DVD player is connected to the television as shown on page 9, and then select the correct input by pressing **◀**.

**Q** *Why is there a picture but no sound?*

**A** Check all lead connections.  
No sound or unacceptable format sound may be received.  
Check the volume has not been turned down or that sound mute has not been selected.  
Check shared audio settings.

**Q** *What else can cause a poor picture?*

**A** Interference or a weak signal. Try a different television station. **Manual Fine Tuning** may help.

- 1 Select the **ATV Manual Tuning** menu. Highlight the station and press **OK**. Then press ▶ to select **Manual Fine Tuning**.
- 2 Using ▲ or ▼ adjust to get the best picture and sound. Press **OK** and then **EXIT**.

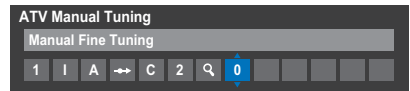

**Q** *Why don't the controls of the television work?*

**A** Check that **Panel Lock** is not **On**.

**Q** *Why doesn't the remote control work?*

**A** Check that the batteries aren't dead or inserted incorrectly.

**Q** *Why is the digital channel locked?*

**A** The channel has been locked in **Channel Options** (see "Digital settings – Channel Options" section).

**Q** *Why are some of the digital subscription channels unavailable?*

**A** Your subscription needs upgrading. Contact your service provider.

**Q** *Why is the soundtrack in English when a different audio language has been selected?*

**A** The programme is currently being broadcast with an English soundtrack only.

**Q** *Why is there incorrect or no sound when in DTV mode?*

**A** Press ◻/I to ensure the hard of hearing option has not been selected.



**Q** *What is DVB-T?*

**A** Digital Video Broadcast via an aerial/antenna.

**Q** *What is DVB-C?*

**A** Digital Video Broadcast via a cable connection.

**Q** *How are DTV radio channels selected?*

**A** Select from All Channel List (**LIST** button).

**Q** *What can be done if the PIN number has been forgotten?*

**A** Use the Master PIN code of 1276, then change to a number of your choice. Select **Parental PIN Setup** from the **DTV Settings** menu to enter PIN. Ensure that no-one else can use the Master PIN by removing the Owner's Manual.

**Q** *Why are there vertical stripes on the screen when in PC mode?*

**A** The **Sampling Clock** may need adjustment. Select **PC Settings** from the **Display Settings** menu, highlight **Sampling Clock** and adjust until the lines clear.

**Q** *Why are there horizontal stripes and/or blurred images on the screen when in PC mode?*

**A** The **Clock Phase** may need adjustment. Select **PC Settings** from the **Display Settings** menu, highlight **Clock Phase** and adjust until the picture clears.

**Q** *Why when digital subtitles have been selected are they not showing on screen?*

**A** Subtitles are not currently being transmitted by the broadcaster.

**Q** *Why are there problems with analogue text?*

**A** Good performance of text depends on a good strong broadcast signal. This normally requires a roof or loft aerial. If the text is unreadable or garbled, check the aerial. Go to the *main index* page of the text service and look for the *User Guide*. This will explain the basic operation of text in some detail. If further information is needed on how to use text see the *text section*.

**Q** *Why is a page number visible at the top of the screen but no text?*

**A** Text has been selected but Teletext information is currently unavailable on the current source.

**Q** *Why are the colours wrong when an NTSC source is played?*

**A** Connect the source via a SCART lead and play. Select **Colour System** from the **Setup** menu.

**1** Set the Colour to **Auto** and exit.

**2** Go to the **PICTURE** menu and adjust the tint.

**Q** *Why don't the devices connected via HDMI operate properly?*

**A** Make sure to use cables with the HDMI logo  (see page 10).

Some early HDMI equipment may not work properly with the latest HDMI TV products, due to new standard adoption.

**Q** *Why don't the REGZA-LINK devices work?*

**A** When the connected REGZA-LINK device does not work correctly after you have changed the settings of the device, turn off your television and unplug the power cord, and then plug and turn on again. Unplug the HDMI cable of the REGZA-LINK device and lead again.

**Q** *Why is the REGZA-LINK logo still showing when the equipment has been disconnected?*

**A** If the REGZA-LINK device is disconnected, the logo will disappear after approximately one minute.

**Q** *Why don't the networked devices work?*

**A** The LAN cables are not connected properly or at all. Connect all cables (see page 13). Make sure your network address is set up correctly (see page 36).

**Q** *Why doesn't the wireless network work?*

**A** Make sure the TOSHIBA Dual Band WLAN Adaptor is used (see page 13). Check that the AP is powered on.

**Q** *Why doesn't the Media Player feature operate?*

**A** Make sure that devices are connected correctly. Incorrect behaviour may occur with a USB Hub connection. Check your network setup if using DLNA CERTIFIED™ Server.

**Q** *What do the LEDs on the front of the television indicate?*

**A** Check the table below.

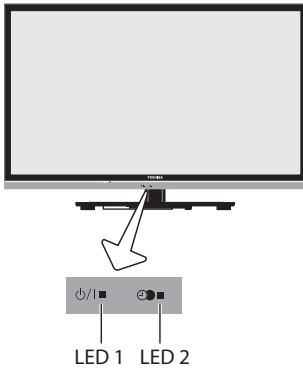

LED indication		Condition
LED-1	LED-2	
Green	Orange	Power ON Programme Timer is set
Green	Red	Power ON Programme Timer(Recording) or Recording is working
Green	OFF	Power ON Programme Timer is NOT set
Red	Orange	Power OFF (Standby) Programme Timer is set
Red	Red	Power OFF (Standby) Program Timer(Recording) or Recording is working
Red	OFF	Power OFF (Standby) Programme Timer is NOT set

**Other problems**

If your TV's problem is not addressed in this Questions and Answers section or the recommended solution has not worked, do one of the following:

- 1 Turn off your TV. After 30 seconds, turn it on.
- 2 Turn off the TV and unplug the power cord. After 1 minute, plug the power cord in and turn on the TV.
- 3 Perform the **Reset TV** function in the **System Setup** menu.

## License Information

- 
 Manufactured under license from Dolby Laboratories. Dolby and the double-D symbol are trademarks of Dolby Laboratories.
- 
 HDMI, the HDMI logo, and High-Definition Multimedia Interface are trademarks or registered trademarks of HDMI Licensing, LLC.
- This product contains Adobe® Flash® Player software under license from Adobe Systems Incorporated. Copyright © 1995-2009 Adobe Systems Incorporated. All rights reserved. Adobe and Flash are trademarks of Adobe Systems Incorporated.
- 
 DivX®, DivX Certified®, DivX Plus® HD and associated logos are trademarks of Rovi Corporation or its subsidiaries and are used under license. Covered by one or more of the following U.S. patents: 7,295,673; 7,460,668; 7,515,710; 7,519,274
- This product contains technology subject to certain intellectual property rights of Microsoft. Use or distribution of this technology outside of this product is prohibited without the appropriate license(s) from Microsoft.
- This product includes technology owned by Microsoft Corporation and can not be used or distributed without a license from Microsoft Licensing, GP.
- Content owners use Windows Media digital rights management technology (WMDRM) to protect their intellectual property, including copyrights. This device uses WMDRM software to access WMDRM-protected content. If the WMDRM software fails to protect the content, content owners may ask Microsoft to revoke the software's ability to use WMDRM to play or copy protected content. Revocation does not affect unprotected content. When you download licenses for protected content, you agree that Microsoft may include a revocation list with the licenses. Content owners may require you to upgrade WMDRM to access their content. If you decline an upgrade, you will not be able to access content that requires the upgrade.
- DLNA™, DLNA CERTIFIED™, DLNA CERTIFIED Logo are trademarks, service marks, or certification marks of the Digital Living Network Alliance.
- 
 Rovi and Rovi Guide are trademarks of Rovi Corporation and/or its subsidiaries. The Rovi Guide system is manufactured under license from Rovi Corporation and/or its subsidiaries.
- DVB is a registered trademark of the DVB Project.
- THIS PRODUCT IS LICENSED UNDER THE AVC PATENT PORTFOLIO LICENSE FOR THE PERSONAL AND NONCOMMERCIAL USE OF A CONSUMER TO (i) ENCODE VIDEO IN COMPLIANCE WITH THE AVC STANDARD (AVC VIDEO) AND/OR (ii) DECODE AVC VIDEO THAT WAS ENCODED BY A CONSUMER ENGAGED IN A PERSONAL AND NONCOMMERCIAL ACTIVITY AND/OR WAS OBTAINED FROM A VIDEO PROVIDER LICENSED TO PROVIDE AVC VIDEO. NO LICENSE IS GRANTED OR SHALL BE IMPLIED FOR ANY OTHER USE. ADDITIONAL INFORMATION MAY BE OBTAINED FROM MPEG LA, L.L.C. SEE [HTTP://WWW.MPEGLA.COM](http://www.mpegla.com)
- THIS PRODUCT IS LICENSED UNDER THE MPEG-4 VISUAL PATENT PORTFOLIO LICENSE FOR THE PERSONAL AND NONCOMMERCIAL USE OF A CONSUMER FOR (i) ENCODING VIDEO IN COMPLIANCE WITH THE MPEG-4 VISUAL STANDARD ("MPEG-4 VIDEO") AND/OR (ii) DECODING MPEG-4 VIDEO THAT WAS ENCODED BY A CONSUMER ENGAGED IN A PERSONAL AND NON-COMMERCIAL ACTIVITY AND/OR WAS OBTAINED FROM A VIDEO PROVIDER LICENSED BY MPEG LA TO PROVIDE MPEG-4 VIDEO. NO LICENSE IS GRANTED OR SHALL BE IMPLIED FOR ANY OTHER USE. ADDITIONAL INFORMATION INCLUDING THAT RELATING TO PROMOTIONAL, INTERNAL AND COMMERCIAL USES AND LICENSING MAY BE OBTAINED FROM MPEG LA, L.L.C. SEE [HTTP://WWW.MPEGLA.COM](http://www.mpegla.com)
- MPEG Layer-3 audio coding technology licensed from Fraunhofer IIS and Thomson.
- Hybrid TV Standard is implemented according to ETSI TS 102 796 v1.1.1.
- Intel and the Intel logo are trademarks of Intel Corporation in the U.S. and/or other countries.

**Cleaning the screen and cabinet...**

Turn off the power, and clean the screen and cabinet with a soft, dry cloth. We recommend that you **do not** use any proprietary polishes or solvents on the screen or cabinet as this may cause damage.

**Disposal...**

The following information is only for EU-member states:

**Disposal of products**

The crossed out wheeled dust bin symbol indicates that products must be collected and disposed of separately from household waste. Integrated batteries and accumulators can be disposed of with the product. They will be separated at the recycling centres.

The black bar indicates that the product was placed on the market after August 13, 2005.

By participating in separate collection of products and batteries, you will help to assure the proper disposal of products and batteries and thus help to prevent potential negative consequences for the environment and human health.

For more detailed information about the collection and recycling programmes available in your country, please contact your local city office or the shop where you purchased the product.

**Disposal of batteries and/or accumulators**

The crossed out wheeled dust bin symbol indicates that batteries and/or accumulators must be collected and disposed of separately from household waste.

If the battery or accumulator contains more than the specified values of lead (Pb), mercury (Hg), and/or cadmium (Cd) defined in the Battery Directive (2006/66/EC), then the chemical symbols for lead (Pb), mercury (Hg) and/or cadmium (Cd) will appear below the crossed out wheeled dust bin symbol.

By participating in separate collection of batteries, you will help to assure the proper disposal of products and batteries and thus help to prevent potential negative consequences for the environment and human health.

For more detailed information about the collection and recycling programmes available in your country, please contact your local city office or the shop where you purchased the product.



## Information

**Before connecting any external equipment, turn off all main power switches. If there is no switch, remove the mains plug from the wall socket.**

### Signal information for Mini D-sub 15 pin connector

Pin No.	Signal name	Pin No.	Signal name	Pin No.	Signal name
1	R	6	Ground	11	NC
2	G	7	Ground	12	DDC Data
3	B	8	Ground	13	H-sync
4	NC*	9	+5V	14	V-sync
5	Ground	10	Ground	15	DDC Clock

\* NC = not connected

### Acceptable PC signals through the PC terminal

The PC input on this TV only accepts signal formats which are compliant with VESA-DMT as shown in the table below. Since some PCs input signals which are different from the resolution and frequency described in the table below, the following phenomenon may occur; incorrect display, false format detection, picture position failure, blur, or judder. In this case, set the monitor output format on your PC to conform to a signal in the table below.

Format	Resolution	V. Frequency	H. Frequency	Pixel Clock Frequency	VESA Standard (DMT)
VGA	640 × 480	59.940Hz	31.469kHz	25.175MHz	●
		72.809Hz	37.861kHz	31.500MHz	●
		75.000Hz	37.500kHz	31.500MHz	●
SVGA	800 × 600	56.250Hz	35.156kHz	36.000MHz	●
		60.317Hz	37.879kHz	40.000MHz	●
		72.188Hz	48.077kHz	50.000MHz	●
		75.000Hz	46.875kHz	49.500MHz	●
XGA	1024 × 768	60.004Hz	48.363kHz	65.000MHz	●
		70.069Hz	56.476kHz	75.000MHz	●
		75.029Hz	60.023kHz	78.750MHz	●
WXGA	1280 × 768	59.995Hz	47.396kHz	68.250MHz	●
		59.870Hz	47.776kHz	79.500MHz	●
		74.893Hz	60.289kHz	102.250MHz	●
	1280 × 800	59.810Hz	49.702kHz	83.500MHz	
	1360 × 768	60.015Hz	47.712kHz	85.500MHz	●
WXGA+	1440 × 900	59.887Hz	55.935kHz	106.500MHz	
SXGA	1280 × 1024	60.020Hz	63.981kHz	108.000MHz	●
		75.025Hz	79.976kHz	135.000MHz	●
1080p	1920 × 1080p	60.000Hz	67.500Hz	148.500MHz	

## Acceptable video or PC signals through the HDMI terminals

The HDMI inputs on this TV only accept VGA, SVGA, XGA, WXGA, and SXGA signal formats which are compliant with VESA as shown in the table below. Since some PCs and HDMI or DVI devices input signals which are different from the resolution and frequency described in the table below, the following phenomenon may occur; incorrect display, false format detection, picture position failure, blur, or judder. In this case, set the monitor output format on your PC, HDMI or DVI device to conform to a signal in the table below.

Format	Resolution	V. Frequency	H. Frequency	Pixel Clock Frequency	VESA Standard
480i	720 × 480i	59.940/60.000Hz	15.734/15.750kHz	27.000/27.027MHz	
576i	720 × 576i	50.000Hz	15.625kHz	27.000MHz	
480p	720 × 480p	59.940/60.000Hz	31.469/31.500kHz	27.000/27.027MHz	
576p	720 × 576p	50.000Hz	31.250kHz	27.000MHz	
1080i	1920 × 1080i	59.940/60.000Hz	33.716/33.750kHz	74.176/74.250MHz	
1080i	1920 × 1080i	50.000Hz	28.125kHz	74.250MHz	
720p	1280 × 720p	59.940/60.000Hz	44.955/45.000kHz	74.176/74.250MHz	
720p	1280 × 720p	50.000Hz	37.500kHz	74.250MHz	
1080p	1920 × 1080p	59.940/60.000Hz	67.433/67.500kHz	148.352/148.500MHz	
1080p	1920 × 1080p	50.000Hz	56.250kHz	148.500MHz	
1080p	1920 × 1080p	24.000Hz	27.000kHz	74.250MHz	
VGA	640 × 480	59.940/60.000Hz	31.469/31.500kHz	25.175/25.200MHz	●
		72.809Hz	37.861kHz	31.500MHz	●
		75.000Hz	37.500kHz	31.500MHz	●
SVGA	800 × 600	56.250Hz	35.156kHz	36.000MHz	●
		60.317Hz	37.879kHz	40.000MHz	●
		72.188Hz	48.077kHz	50.000MHz	●
		75.000Hz	46.875kHz	49.500MHz	●
XGA	1024 × 768	60.004Hz	48.363kHz	65.000MHz	●
		70.069Hz	56.476kHz	75.000MHz	●
		75.029Hz	60.023kHz	78.750MHz	●
WXGA	1280 × 768	59.995Hz	47.396kHz	68.250MHz	●
		59.870Hz	47.776kHz	79.500MHz	●
		74.893Hz	60.289kHz	102.250MHz	●
	1360 × 768	60.015Hz	47.712kHz	85.500MHz	●
SXGA	1280 × 1024	60.020Hz	63.981kHz	108.000MHz	●
		75.025Hz	79.976kHz	135.000MHz	●

## Media Player Supported Format

Media Player	Media Format	File Extension	Video codec	Audio codec	USB	DMS	Note
Photo	JPEG	.jpg .jpeg	JPEG	-	yes	yes	<USB> Data compatibility: JPEG Exif ver 2.2 Maximum viewable resolution: -JPEG 15360 × 8640 (Base-line) 1024 × 768 (Progressive) -BMP 9600 × 6400 Maximum number of files: 1000 / folder <DMS> Data compatibility: JPEG Exif ver 2.2 Maximum viewable resolution: 1024 × 768 Maximum number of files: 1000/folder *) Some files may not be played depending on file size.
	MPO	.mpo	MPO	-	yes	no	
	BMP	.bmp	BMP	-	yes	no	
Movie	AVI	.avi	MPEG-2 MPEG-4 part2 H.264 (MPEG-4 AVC) DivX Xvid	MPEG-1/2 Layer2 MPEG-1/2 Layer3 Dolby Digital (AC-3) L-PCM ADPCM MPEG-2/4 LC AAC MPEG-4 HE-AAC	yes	no	<USB> Maximum number of files: 1000 / folder Maximum viewable resolution: -Motion-JPEG:640 × 480 -Other:1920 × 1080
	MPEG-2 PS	.mpg .mpeg	MPEG-1 Video MPEG-2 Video	MPEG-1/2 Layer2 MPEG-1/2 Layer3 Dolby Digital (AC-3) L-PCM	yes	yes	*) Some files may not be played.
	MPEG-2 TS	.ts .trp .tp	MPEG-2 Video	MPEG-1/2 Layer2 MPEG-1/2 Layer3 Dolby Digital (AC-3) L-PCM	yes	yes	
			H.264(MPEG-4 AVC) VC-1(WMV9)	MPEG-4 LC AAC MPEG-4 HE-AAC		no	
	MPEG-2 VOB	.vob	MPEG-1 Video MPEG-2 Video	MPEG-1/2 Layer2 MPEG-1/2 Layer3 Dolby Digital (AC-3) L-PCM	yes	no	
	MOV	.mov	H.264 (MPEG-4 AVC) MPEG-4 part2	MPEG-1/2 Layer3 MPEG-2/4 LC AAC MPEG-4 HE-AAC	yes	no	
	MP4	.mp4 .m4v	H.264 (MPEG-4 AVC) MPEG-4 part12,14	MPEG-4 HE-AAC	yes	no	
	ASF	.asf .wmv	VC-1 (WMV9)	WMA7/8/9 Std WMA9 Pro	yes	no	
	DivX	.divx .div	DivX 3,4,5,6	MPEG-1/2 Layer2 MPEG-1/2 Layer3 Dolby Digital (AC-3) PCM	yes	no	
	Xvid	.xvid	Xvid	ADPCM			

Media Player	Media Format	File Extention	Video codec	Audio codec	USB	DMS	Note
Movie	MKV	.mkv	MPEG-1 Video MPEG-2 Video MPEG-4 part2 H.264 (MPEG-4 AVC)	MPEG-1/2 Layer2 MPEG-1/2 Layer3 Dolby Digital (AC-3) L-PCM MPEG-2/4 LC AAC MPEG-4 HE-AAC	yes	no	
	RealMedia	.rm .rmvb	RealVideo 8,9,10	Dolby Digital (AC-3) MPEG-2/4 LC AAC	yes	no	
	Flash Video (FLV1)	.flv .swf	Sorenson H.263 (FLV1) H.264 (MPEG-4 AVC)	MPEG-1/2 Layer3 MPEG-2/4 LC AAC L-PCM ADPCM	yes	no	
	3GPP	.3gp	MPEG-4 part2 H.264 (MPEG-4 AVC)	MPEG-2/4 LC AAC AMR	yes	no	
	Motion JPEG	.avi .mp4 .mkv	JPEG	L-PCM ADPCM	yes	no	
Music	MP3	.mp3	-	MPEG-1/2 Layer-3	yes	yes	<USB> Maximum number of files: 1000 / folder
	MP4	.m4a	-	MPEG-2/4 LC AAC	yes	no	
	WMA	.wma	-	WMA7/8/9/ Std	yes	no	
			-	WMA9 Pro	yes	no	
	WAV	.wav	-	LPCM ADPCM MPEG-1/2 Layer-3 WMA7/8/9/ Std WMA9 Pro	yes	no	
LPCM		-		no	yes		



# Specifications and accessories

## Receiving systems

DVB-T Broadcast systems/channels		Broadcast systems/channels	
UK	UHF 21-68	PAL-I	UHF UK21-UK69
France	VHF 05-10 (VHF 01-05) UHF 21-69	PAL-B/G	UHF E21-E69 VHF E2-E12, S1-S41
Germany	VHF 05-12 UHF 21-69	SECAM-L	UHF F21-F69 VHF F1-F10, B-Q
Austria	VHF 05-12 UHF 21-69	SECAM-D/K	UHF R21-R69 VHF R1-R12
Switzerland	VHF 05-12 UHF 21-69		
Italy	VHF 05-12 (D,E,F,G,H,H1,H2) UHF 21-69		
Spain	UHF 21-69		
Nederlands	VHF 05-12 UHF 21-69		
Greece	VHF 05-12 UHF 21-69		

## DVB-C Broadcast systems

### DVB-T2 Broadcast systems (RL95 series only)

**Video Input** PAL, SECAM, NTSC 3.58/4.43

## External connections

EXT 1	Input/Output	21-pin SCART	RGB, A/V input AV out, TV out
EXT 2	Input	RCA jacks RCA jack RCA jacks	Y, P <sub>B</sub> /C <sub>B</sub> , P <sub>R</sub> /C <sub>R</sub> Video (Y is shared) Audio L + R (shared)
HDMI	Input	HDMI® compliant HDCP compliant	
PC	Input	Mini D-sub 15-pin Analogue	
Digital Audio Output (S/PDIF)	Optical		
LAN port		RJ-45	
USB port		Media Player Interface version: USB 2.0 USB class: Mass Storage File system: FAT16 and FAT32 Wireless LAN adaptor ready for a home network, IEEE802.11a/b/g/n compatible USB HDD connection ready	
Headphone socket		3.5mm stereo	
<b>Stereo</b>		A2, Nicam 2 carrier system	
<b>Visible Screen Size</b> (approx.)		23 32 40	58cm 80cm 102cm
<b>Display</b>		16:9	
<b>Sound output</b> (at 10% distortion)	Main:	10W + 10W (32/40) 5W + 5W (23)	

<b>Power consumption</b> (approx.)	23RL 32RL 40RL	45W 71W 90W
---------------------------------------	----------------------	-------------------

<b>Standby power consumption</b> (approx.)	0.3W
---	------

<b>Energy Efficiency Class</b>	23RL 32RL 40RL	A A+ A+
--------------------------------	----------------------	---------------

<b>On-mode power consumption*</b> (approx.)	23RL 32RL 40RL	26.0W 33.6W 48.6W
---	----------------------	-------------------------

<b>Average annual energy consumption**</b> (approx.)	23RL 32RL 40RL	38.0kWh/y 49.1kWh/y 71.0kWh/y
--	----------------------	-------------------------------------

\* Tested in accordance with IEC 62087-BD Ed. 2.0:2008 in default settings.

\*\* Operating 4 hours a day and 365 days a year.

<b>Dimensions</b> (approx.)	23RL 32RL 40RL	39cm (H) 55cm (W) 18cm (D) 51cm (H) 74cm (W) 21cm (D) 61cm (H) 92cm (W) 22cm (D)
--------------------------------	----------------------	--

(Height dimension includes foot stand)

<b>Weight</b> (approx.)	23RL 32RL 40RL	5.0kg 9.5kg 14.0kg
-------------------------	----------------------	--------------------------

<b>Operating condition</b>	Temperature 5°C - 35°C (41°F - 94°F) Humidity 20 - 80% (non-condensing)
----------------------------	--

<b>Supplied accessories</b>	<ul style="list-style-type: none"> <li>Remote control CT-90404, CT-90420 2 batteries (AA, IEC R6 1.5V for CT-90404, AAA, IEC R03 1.5V for CT-90420)</li> <li>'P' Clip/Screw (for TV mounting) See page 5.</li> <li>4 spacers for wall mounting</li> </ul>
-----------------------------	---

<b>Optional accessories</b>	<ul style="list-style-type: none"> <li>TOSHIBA Dual Band WLAN Adaptor WLM-20U2</li> <li>Not guaranteed to work with all USB HDD</li> </ul>
-----------------------------	--

Specification is subject to change without notice.

**> SUPPORT**

 **PLEASE VISIT:**  
**[WWW.TOSHIBA.CO.UK/TV-DVD-SUPPORT](http://WWW.TOSHIBA.CO.UK/TV-DVD-SUPPORT)**

 **OR CONTACT THE TOSHIBA CUSTOMER  
HELPLINE ON 0844 856 0730**

Register your TV online at  
[www.toshiba.co.uk/registration](http://www.toshiba.co.uk/registration)

© TOSHIBA Television Central Europe Sp. z o.o.  
All rights reserved.  
Reproduction in whole or part without written permission is strictly prohibited.

**TOSHIBA Television Central Europe Sp. z o.o.**  
ul. Pokoju 1, Biskupice Podgórne, 55-040 Kobierzyce, Poland