

TOSHIBA

Leading Innovation >>>

ON-LINE MANUAL

40L345*DB

LED Backlight LCD TV

During the life of your TV firmware updates will be made available to ensure that your TV maintains optimum performance. You can download the latest version of firmware from

www.toshiba-om.net/firmware.php

Some features listed in this document are limited due to local legislation and may not be available in all countries.



"Register your TV online at: www.toshiba-europe.com/registration"



Get started with Freeview

Freeview gives you over 50 TV channels to play with, not to mention 25 radio stations.

Start watching all your favourite TV content today, just connect your aerial and tune in.

Keep up-to-date

New channels are launched on Freeview from time to time along with other updates to the service. So it pays to retune your digital TV periodically to make sure your Digital TV/Radio channels are up to date. To retune your Toshiba Digital TV, please refer to the Re-tune section for guidance.

Alternatively find out more on the dedicated Freeview website:

www.freeview.co.uk/retune

Freeview service is subject to availability. Aerial upgrade may be required.

Contents

Safety Precautions	4	Renaming a Channel	20
Air Circulation	4	Locking a Channel	20
Heat Damage	4	Viewing Info Banner, Electronic Programme Guide	21
Mains Supply	4	Viewing Info Banner	21
Warning	4	Electronic Programme Guide	21
Do	4	Language Selection	22
Do not	4	Language Settings	22
Installation and Important Information	5	Preferred	22
EXCLUSION CLAUSE	5	Current	22
Important safety information	6	Digital Settings - Parental Control, Menu Lock, Set PIN	23
Removing the pedestal stand	7	Viewing Parental Control Menu	23
The Remote Control	8	Menu Lock	23
Inserting Batteries and Effective Range of the Remote Control	8	Maturity Lock (*)	23
Connecting External Equipment	9	Child Lock	23
Connecting an HDMI® or DVI Device to the HDMI Input	10	Set PIN	23
To Connect an HDMI Device	10	Configuring Picture Settings	24
To Connect a DVI Device	10	Configuring Picture Settings	24
To Connect a Computer	11	Mode	24
Connecting a DVD Player	11	Contrast	24
Connecting to a DVD Player via YPbPr	11	Brightness	24
Connecting a USB Memory	11	Sharpness	24
To Connect a USB Flash Drive	11	Colour	24
Connecting a Computer	11	Power Save Mode	24
Connecting a home network	12	Backlight	24
Power Save Mode	13	Noise Reduction	24
Environmental Information	13	Advanced Settings	24
Controlling the TV	14	Reset	25
Switching on	14	Changing Picture Format	26
Using the Remote Control	14	Configuring PC Picture Settings	27
Using the Controls on the TV	14	PC Picture Settings (*)	27
Initial Installation	15	PC Position	27
Auto Tuning	17	Autoposition	27
Auto Tuning	17	H Position	27
Manual Tuning, Analogue Fine Tuning	18	V Position	27
Digital Aerial Manual Search	18	Dot Clock	27
Digital Cable Manual Search	18	Phase	27
Analogue Manual Search	18	Configuring Sound Settings	28
Analogue Fine Tune	18	Configuring Sound Settings	28
Clear Service List (*)	18	Operating Sound Settings Menu Items	28
General Operation	19	Volume	28
Stereo and Bilingual Transmissions	19	Equalizer (Only for speaker)	28
Displaying Subtitles	19	Balance (Only for speaker)	28
Viewing Main Menu	19	Headphone	28
Controlling Volume and Muting Sound	19	Sound Mode	28
Selecting Programme Positions	19	AVL	28
Standby Notifications	19	Headphone/Lineout	28
Channel List, Sorting Programmes, Programme Locking	20	Dynamic Bass	28
Viewing Channel List	20	Surround Sound	28
Moving a Channel	20	Digital Out	28
Deleting a Channel	20	Settings Menu Operation, Conditional Access	29
		Configuring Your TV's Settings	29
		Viewing Settings Menu	29
		Conditional Access	29

Language.....	29	Appendix C: PC Input Typical Display Modes	41
Parental	29	Appendix D: AV and HDMI Signal Compatibility (Input Signal Types).....	42
Timers	29	Appendix E: PIN Information	43
Date/Time	29	Appendix F: Supported File Formats for USB Mode.....	44
Sources.....	29	Supported File Formats for USB Mode	44
Network Settings.....	29	Re-tune Section.....	45
Other Settings.....	29	Re-tuning: TOSHIBA Freeview Products.....	45
Netflix.....	29	Specifications and Accessories	46
Using a Conditional Access Module	29	License Information	47
Setting Timers, Setting Date/Time	30	Q & A Section	48
Timers	30	Warranty Card	50
Setting Sleep Timer	30	Warranty Card	51
Setting Programme Timers	30	Warranty Card	52
Configuring Date/Time Settings.....	30		
Source Settings, Other Controls.....	31		
Configuring Source Settings.....	31		
Input Selection.....	31		
Configuring Other Settings - General	31		
Operation.....	31		
Menu Timeout.....	31		
Scan Encrypted Channels	31		
Blue Background	32		
Software Upgrade.....	32		
Application Version	32		
Hard of Hearing	32		
Audio Description.....	32		
Auto TV Off	32		
Store Mode	32		
MEDIA Renderer.....	32		
Power Up Mode.....	32		
CEC	33		
CEC Auto Power On.....	33		
Network Settings, Portal, Internet Browser and YouTube	34		
Configuring Network Settings	34		
First enter to Toshiba Portal.....	34		
Using the Toshiba Portal.....	34		
Using the Internet Browser	34		
Using YouTube™	35		
Using Media Browser	36		
Manual Start	36		
Auto Start.....	36		
Playing MP3 Files	37		
Viewing JPEG Files	37		
Slideshow Feature	38		
Video Playback.....	38		
Media Browser Settings.....	39		
Using MENU button in Media Browser Mode ...	39		
To Close the Media Player.....	39		
Analogue Only Text Services.....	40		
Using Text Button -TEXT	40		
Accessing Sub-pages.....	40		
Revealing Concealed Text.....	40		
Holding a Page.....	40		
To display an initial page.....	40		

Safety Precautions

This equipment has been designed and manufactured to meet international safety standards but, like any electrical equipment, care must be taken to obtain the best results and for safety to be assured. Please read the points below for your own safety. They are of a general nature, intended to help with all electronic consumer products and some points may not apply to the goods you have just purchased.

Air Circulation

Leave more than 10cm around all edges when wall mounting the television to allow adequate ventilation. This will prevent overheating and possible damage to the television. Dusty places should also be avoided.

Heat Damage

Damage may occur if the television is left in direct sunlight or near a heater. Avoid places subject to extremely high temperatures or humidity, or locations where the temperature is likely to fall below 5°C (41°F).

Mains Supply

The set should be operated only from a 220-240 V AC 50 Hz outlet. DO ensure that the television is not standing on the mains lead. DO NOT cut off the mains plug from this equipment, this incorporates a special Radio Interference Filter, the removal of which will impair its performance. In the UK, the fuse fitted in this plug is approved by ASTA or BSI to BS1362. It should only be replaced by a correctly rated and approved type. IF IN DOUBT PLEASE CONSULT A COMPETENT ELECTRICIAN.

Warning

To prevent the spread of fire, keep candles or other open flames away from this product at all times.



Do

DO read these operating instructions before you attempt to use the equipment.

DO ensure that all electrical connections (including the mains plug, extension leads and interconnections between pieces of equipment) are properly made and in accordance with the manufacturers' instructions. Switch off and withdraw the mains plug before making or changing connections.

DO consult your dealer if you are ever in doubt about the installation, operation or safety of your equipment.

DO be careful with any glass panels or doors on equipment.

Do not

DON'T remove any fixed cover as this may expose dangerous voltages.

DON'T obstruct the ventilation openings of the equipment with items such as newspapers, tablecloths, curtains, etc. Overheating will cause damage and shorten the life of the equipment.

DON'T allow electrical equipment to be exposed to dripping or splashing or objects filled with liquids, such as vases, to be placed on the equipment.

DON'T place hot objects or naked flame sources, such as lighted candles or nightlights on, or close to equipment. High temperatures can melt plastic and lead to fires.

DON'T use makeshift stands and NEVER fix with wood screws. Use the stand manufacturers supplied screws.

DON'T leave equipment switched on when it is unattended, unless it is specifically stated that it is designed for unattended operation or has a standby mode. Switch off by withdrawing the plug, make sure your family know how to do this. Special arrangements may need to be made for people with disabilities.

DON'T continue to operate the equipment if you are in any doubt about it working normally, or it is damaged in any way - switch off, withdraw the mains plug and consult your dealer.

WARNING - excessive sound pressure from earphones or headphones can cause hearing loss.

ABOVE ALL - NEVER let anyone, especially children, push or hit the screen, push anything into holes, slots or any other openings in the case.

NEVER guess or take chances with electrical equipment of any kind - it is better to be safe than sorry.

THE MAINS PLUG IS USED AS A DISCONNECTING DEVICE AND THEREFORE SHOULD BE READILY OPERABLE.

Note : Interactive video games that involve shooting a "gun" type of joystick at the on-screen target may not work with this TV.

Installation and Important Information

Where to install

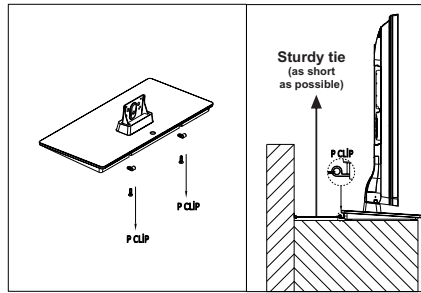

* Button and stand style is dependent on model.

Locate the television away from direct sunlight and strong lights. Soft, indirect lighting is recommended for comfortable viewing. Use curtains or blinds to prevent direct sunlight falling on the screen.

Place the TV on a stable, level surface that can support the weight of the TV. In order to maintain stability and prevent it falling over, its recommended to secure the TV to a wall using a sturdy tie on the back of the stand.

The LCD display panels are manufactured using an extremely high level of precision technology; however, sometimes some parts of the screen may be missing picture elements or have luminous spots. This is not a sign of a malfunction. Make sure the television is located in a position where it cannot be pushed or hit by objects, as pressure will break

or damage the screen. Also, please ensure that small items are not inserted into slots or openings in the case.



Avoid using chemicals (such as air refreshers, cleaning agents, etc.) on or near the TV pedestal. Studies indicate that plastics may weaken and crack over time from the combination effects of chemical agents and mechanical stress (such as weight of TV). Failure to follow these instructions could result in serious injury and/or permanent damage to TV and TV pedestal.

Cleaning the screen and cabinet...

Turn off the power, and clean the screen and cabinet with a soft, dry cloth. We recommend that you do not use any proprietary polishes or solvents on the screen or cabinet as this may cause damage.

Please take note

The digital reception function of this television is only effective in the countries listed in the "Country" section during the first time installation menu. Depending on country/area, some of this television's functions may not be available. Reception of future additional or modified services cannot be guaranteed with this television.

If stationary images generated by 4:3 broadcasts, text services, channel identification logos, computer displays, video games, on screen menus, etc. are left on the television screen for any length of time, they could become conspicuous. It is always advisable to reduce both the brightness and contrast settings.

Very long, continuous use of the 4:3 picture on a 16:9 screen may result in some retention of the image at the 4:3 outlines. This is not a defect of the LCD TV and is not covered under the manufacturer's warranty. Regular use of other size modes will prevent permanent retention.

EXCLUSION CLAUSE

Toshiba shall under no circumstances be liable for loss and/or damage to the product caused by:

- i) fire;
- ii) earthquake;
- iii) accidental damage;
- iv) intentional misuse of the product;
- v) use of the product in improper conditions;
- vi) loss and/or damage caused to the product whilst in the possession of a third party;
- vii) any damage or loss caused as a result of the owner's failure and/or neglect to follow the instructions set out in the owner's manual;
- viii) any loss or damage caused directly as a result of misuse or malfunction of the product when used simultaneously with associated equipment;

Furthermore, under no circumstances shall Toshiba be liable for any consequential loss and/or damage including but not limited to the following, loss of profit, interruption of business, the loss of recorded data whether caused during normal operation or misuse of the product.

Important safety information

- Any function related to the digital television (with the DVB logo) is available only within the country or area where such signals are transmitted. Verify with the salesperson if it is possible to receive a DVB - T/C signal in the area where you live.
- Even if the television conforms to the required DVB - T/C specifications, the compatibility with future digital DVB - T/C transmissions is not guaranteed.
- Some digital television functions may not be available in certain countries.
- The DVB - T/C system present in this device, allows reception of both FTA (Free To Air) and Encrypted channels.

Note; Encrypted channels require a specific encryption system to view, which may not be available in certain countries.

- DVB is a registered trademark of the DVB Project. This logo indicates that the product is compliant with European Digital Broadcasting.

IMPORTANT INFORMATION

TV Installation

- Do not stand the televisions on cloth or other materials placed between the television and supporting furniture.
- Educating children about the dangers of climbing on furniture to reach the television or its controls.
- Always hold the plug when disconnecting the unit from the socket outlet. Do not pull on flex. The flex can become damaged and cause a short circuit.
- Use a soft, dry cloth to clean the unit.
- Set up unit so that no one will trip over the flex.
- If you intend to wall mount the unit, contact the shop where you purchased the unit for advice, and leave the installation work to professionals. Improper installation can cause damage and/or injuries.
- To protect the unit during a thunder storm, unplug the AC power cord and disconnect the aerial, cable and satellite decoder/systems etc.

Caution: Do not touch the aerial connector.

- The unit becomes warm when in operation. Do not place any covers or blankets on the unit in order to prevent overheating.

The ventilation holes should not be blocked. Do not set up near radiators. Do not place in direct sunshine.

- Moisture condensation occurs in the following situations:
 - When you move the unit from a cold place to a warm place.
 - When you use the unit in a room where the heater was just turned on.
 - When you use the unit in an area where cold air from an air conditioner directly hits the unit.
 - When you use the unit in a humid place.
- Never use the unit when moisture condensation could occur.
- Using the unit when moisture condensation exists may damage its own internal parts. After two or three hours, the unit will warm up and moisture will be evaporated.

Removing the pedestal stand

When using a Wall Bracket

Please use a wall bracket appropriate for the size and weight of the LCD TV.

- Two people are required for installation.
 - To install a wall-mount;
- (1) Unplug and remove any cables and/or other component connectors from the rear of the TV.
 - (2) Carefully lay the front of the unit face down on a flat, cushioned surface such as a quilt or blanket.
 - (3) Follow the instructions provided with your wall bracket. Before proceeding, make sure the appropriate bracket(s) are attached to the wall and the back of the TV as described in the instructions provided with the wall bracket.
 - (4) Always use the screws supplied or recommended by the wall mount manufacturer.

Removing the pedestal stand

- (1) Carefully lay the front of the unit face down on a flat, cushioned surface with the stand hanging over the edge.
- (2) Remove the screws.
- (3) After the screws are removed, hold the pedestal stand in place, then remove the pedestal stand and the plastic moulding from the TV by removing away from the TV.

NOTE: Extreme care should always be used when removing the pedestal stand to avoid damage to the LCD panel.

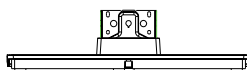
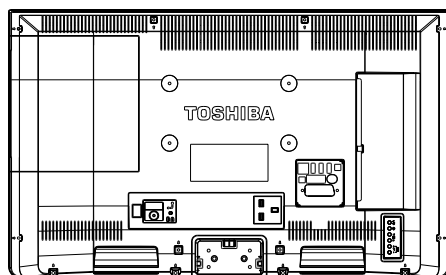

For 40L345*DB model

The Remote Control

Simple at-a-glance reference of your remote control.

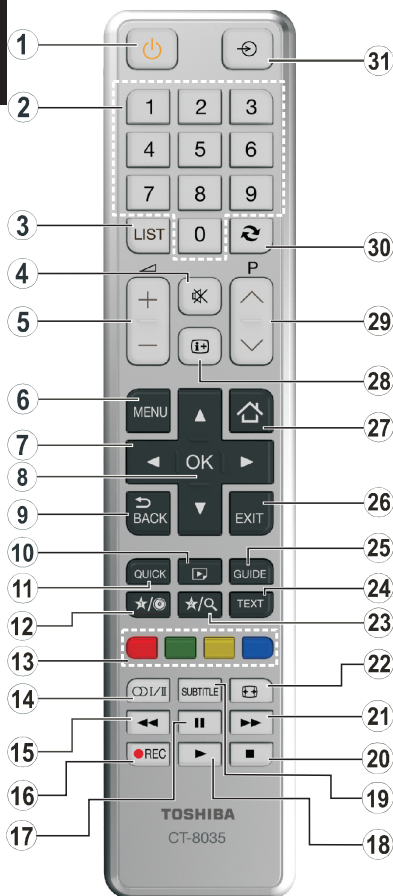

- | | |
|--|---|
| 1. Standby | 17. Pause |
| 2. Numeric buttons | 18. Play |
| 3. TV-AV / Channel list / Switches among broadcast types | 19. Subtitle on-off (in Media Browser mode and in DVB channels) |
| 4. Mute | 20. Stop |
| 5. Volume Up / Down | 21. Rapid advance |
| 6. Menu on-off | 22. Image size |
| 7. Navigation buttons (Up/Down/Left/Right) | 23. My button 2 (*) |
| 8. Okay (Confirm) / Hold (in TXT mode) / Channel List | 24. Teletext / Mix (in TXT mode) |
| 9. Return / Index page (in TXT mode) | 25. Electronic programme guide (in DVB channels) |
| 10. Media Browser | 26. Exit |
| 11. Quick Menu | 27. Internet portal |
| 12. My button 1 (*) | 28. Info / Reveal (in TXT mode) |
| 13. Coloured buttons | 29. Programme Down / Page up - Programme Up / Page down |
| 14. Mono/Stereo - Dual I-II / Current Language (in DVB channels) | 30. Previous programme |
| 15. Rapid reverse | 31. AV / Source selection |

(*) MY BUTTON 1 & MY BUTTON 2

These buttons may have default functions depending on the model. However you can set a special function to these buttons by pressing on them for five seconds when on a desired source, channel or link. A confirmation message will be displayed on the screen. Now the selected MY BUTTON is associated with the selected function.

Note that if you perform first time installation, MY BUTTON 1&2 will return to their default function.

Inserting Batteries and Effective Range of the Remote Control



Remove the back cover to reveal the battery compartment and make sure the batteries are inserted the right way round. Suitable battery types for this remote are AAA, IEC R03 1.5V.

Do not combine a used, old battery with a new one or mix battery types. Remove exhausted batteries immediately to prevent acid from leaking into the battery compartment. Dispose of them in a designated disposal area.

Warning: Batteries must not be exposed to excessive heat such as sunshine, fire or the like.

The performance of the remote control will deteriorate beyond a distance of five metres or outside an angle of 30 degrees from the IR receiver. If the operating range becomes reduced the batteries may need replacing.

Connecting External Equipment

Before connecting any external equipment, remove the mains plug from the wall socket.

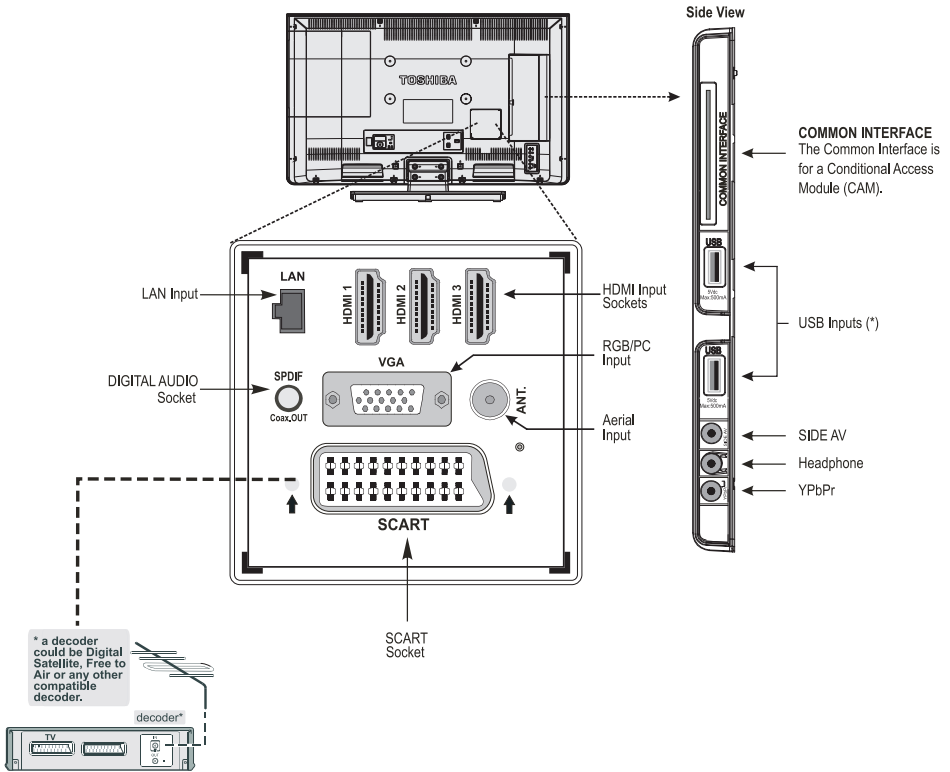

(*) Number of these inputs may change according to the model of your TV.

Aerial cable:..... Connect the aerial to the ANT. socket on the rear of the TV.

SCART lead:..... If you use a **decoder*** or a **media recorder**, it is essential that the scart cable is connected to the TV.

Before running **first time installation**, any connected devices need to be set to standby mode.

The DIGITAL AUDIO socket enables the connection of a suitable surround sound system.

HDMI® (High-Definition Multimedia Interface) is for using with a DVD decoder or other equipment with digital audio and video output. It is designed for best performance with 1080i and 1080p high-definition video signals but will also accept and display VGA, 480i, 480p, 576i, 576p and 720p signals. PC format signals will also be displayed.

NOTE: Although this TV is able to connect to HDMI equipment, it is possible that some equipment may not operate correctly.

When connecting a device via the Side AV input, you must use the supplied connection cable to enable connection.

When connecting a device via YPbPr input, you must use the supplied connection cable to enable connection.

LAN Input is used to connect the TV to your home network. A wide variety of external equipment can be connected to the TV; therefore, the relevant owner's manuals for all additional equipment must be referred to for exact instructions.

If the TV automatically switches over to monitor external equipment, return to normal TV by pressing the desired programme position button. To recall external equipment, press **SOURCE** button repeatedly to switch between sources.

Regardless of source's property, audio output from the DIGITAL AUDIO socket cannot be copied.

Connecting an HDMI® or DVI Device to the HDMI Input

The HDMI inputs on your TV receive digital audio and uncompressed digital video from an HDMI source device or uncompressed digital video from a DVI (Digital Visual Interface) source device.

These inputs are designed to accept HDCP (High-Bandwidth Digital-Content Protection) programme material in digital form from EIA/CEA-861-D-compliant [1] consumer electronic devices (such as a set-top box or DVD player with HDMI or DVI output).

NOTE:

- Some early HDMI equipment may not work properly with your latest HDMI TV.
- Supported Audio format: Linear PCM, sampling rate 32/44.1/48kHz.

To Connect an HDMI Device

Connect an HDMI cable (type A connector) to the HDMI terminal. For proper operation, it is recommended that you use an HDMI cable with the HDMI Logo (**HDMI**).

- If your HDMI connection is capable of 1080p and/or your TV is capable of refresh rates greater than 50Hz, you will need a Category 2 cable. Conventional HDMI/DVI cable may not work properly with this mode.
- HDMI cable transfers both video and audio. Separate analogue audio cables are not required (see illustration).
- To view the HDMI device video, press **SOURCE** button to select the appropriate HDMI input.

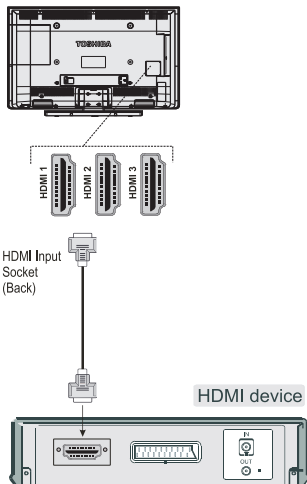

To Connect a DVI Device

Connect an HDMI-to-DVI cable (HDMI type A connector) to the HDMI input socket and audio cables to the RED and WHITE SIDE AV AUDIO inputs on the Audio/Video connection cable supplied (see illustration).

- The maximum recommended HDMI-to-DVI cable length is 6.6 ft (2m).
- An HDMI-to-DVI cable transfers video only. Separate analogue audio cables are required.

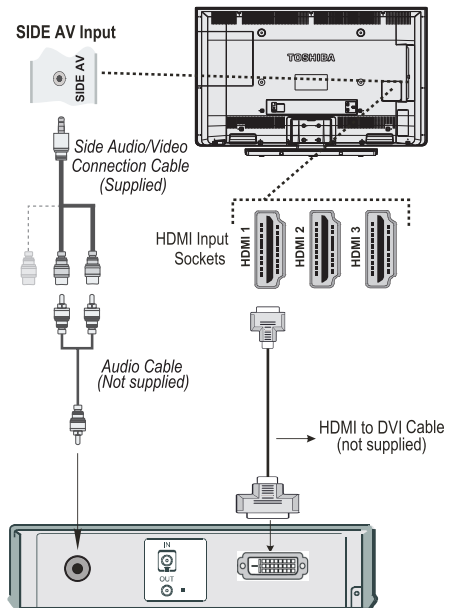

NOTE:

To ensure that the HDMI or DVI device is reset properly, it is recommended that you follow these procedures:

- When turning on your electronic components, turn on the TV first, and then the HDMI or DVI device.
- When turning off your electronic components, turn off the HDMI or DVI device first, and then the TV.

Connecting a Computer

To Connect a Computer

With either an RGB/PC or an HDMI connection, you can watch your computer's display on the TV and hear the sound from the TV's speakers.

When connecting a PC to the RGB/PC input on TV, use an analogue RGB (15-pin) computer cable and use the SIDE AV socket with a PC audio cable (not supplied) for audio connection, using the supplied Side AV connection cable's RED and WHITE inputs (see illustration).

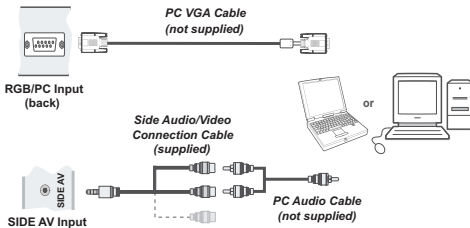

To use a PC, set the monitor output resolution on the PC before connecting it to the TV. To display the optimum picture, use the PC setting feature.

NOTE:

- Some PC models cannot be connected to this TV. An adaptor is not needed for computers with a compatible mini D-sub15-pin terminal.
- Depending on the DVD's title and the specifications of the PC on which you are playing the DVD-Video, some scenes may be skipped or you may not be able to pause during multiangle scenes.

Connecting a DVD Player

Connecting to a DVD Player via YPbPr

Some DVD players are connected through COMPONENT SOCKETS (YPbPr). In this case, you must use the supplied Component YPbPr video connection cable for enabling connection. First, plug the single jack of the cable to the TV's YPbPr socket (side). Afterwards, insert your YPbPr cable's (not supplied) connectors into the plural part of the supplied YPbPr video connection cable (see illustration below). Colours of the connected jacks should match.

To enable audio connection, use the supplied Side AV connection cable. First, plug single jack of the cable to the Side AV Input of the TV. Afterwards, insert your DVD player's audio cable's connectors into the plural part of the supplied Side AV connection cable (see illustration below). Colours of the connected jacks should match.

Video Connection

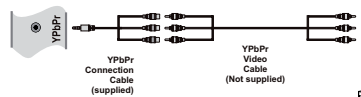

Audio Connection

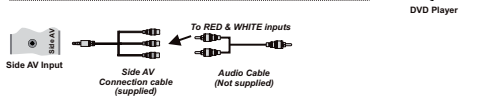

Connecting a USB Memory

To Connect a USB Flash Drive

- You can connect a USB Flash Drive to your TV by using the USB inputs on the TV. This feature allows you to display/play music, photo or video files stored in a USB stick.
- It is possible that certain types of USB devices (e.g. MP3 Players) may not be compatible with this TV.
- You may back up your files before making any connections to the TV set in order to avoid any possible data loss. Note that manufacturer will not be responsible for any file damage or data loss.
- Do not pull out USB module while playing a file.

CAUTION: Quickly plugging and unplugging USB devices may cause damage to the USB device.

Connecting a home network

Connectivity feature allows the TV to connect to the home network wired or wirelessly. You can use this networking system to connect to the Toshiba Cloud TV Portal or to access photo, video and audio files that are stored on a MEDIA SERVER connected to the network and play/display them on the TV.

Wired connection

Connect the TV to the modem/router via a LAN cable (not supplied). Select **Network Type** as **Wired Device** in **Network Settings** menu and press **OK** to connect.

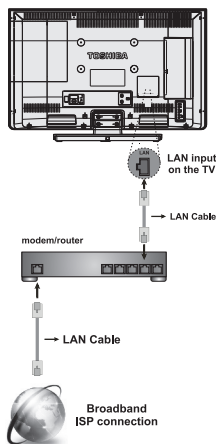

Wireless connection for models without integrated WIFI

You need to connect a USB LAN adaptor (sold separately) to one of the USB inputs on your TV to connect to your network wirelessly.

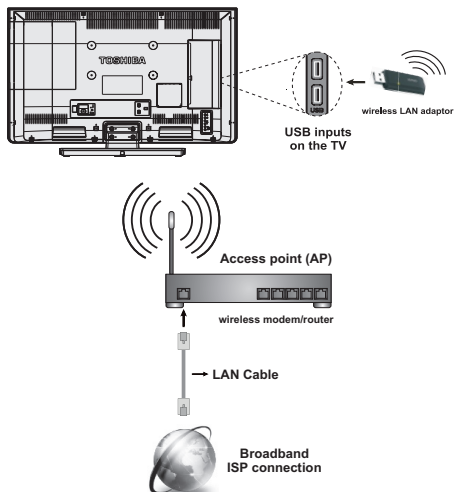

Note: Wireless USB LAN adaptor can be purchased from the retail outlet or Toshiba service company. You can find the phone numbers of the local services on the back cover of this manual.

Wireless connection for models with integrated WIFI

To connect the TV to the home network wirelessly just select **Network Type** as **Wireless Device** in **Network Settings** menu and press **OK** button. The TV will search for available networks. Select the desired network and press **OK**. The TV has a built-in WLAN system and has no need for additional devices to connect to a wireless network.

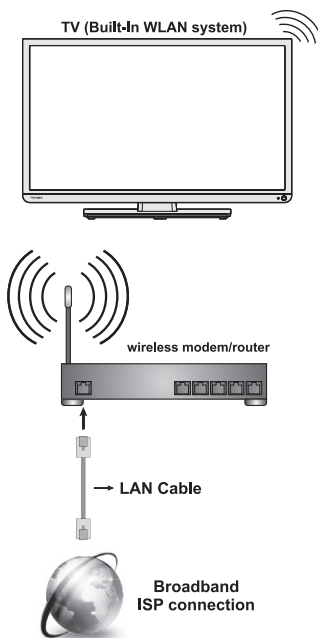

Note: Performance depends on many factors, conditions and variables, including distance from access point (AP), volume of network traffic, building materials and construction, operating system used, mix of wireless products used, interference and other adverse conditions.

Please refer to **Network Settings** section on **page 34** to configure a wired or a wireless connection.

Power Save Mode

Environmental Information

This television is designed to be environment friendly. You not only help to save the environment but also you can save money by reducing electricity bills thanks to the energy efficiency feature of this TV. To reduce energy consumption, you should take the following steps:

You can use Power Save Mode setting, located in the Picture Settings menu. If you set Power Save Mode as **Eco**, the TV will switch to energy-saving mode and luminance level of TV set will be decreased to optimum level. Note that some picture settings will be unavailable to be changed when the TV is in Power Save Mode.

Power Save Mode

Eco

If pressed Right button, "**Screen will be off in 15 seconds.**" message will be displayed on the screen. Select **Proceed** and press **OK** to turn the screen off immediately. If you don't press any button, the screen will be off in 15 seconds. Press any button on the remote or on the TV to turn the screen on again. If you disable **Power Save Mode**, picture mode will be automatically set to **Dynamic**.

It is highly recommended to activate **Power Save Mode** to reduce your annual power consumption. And also it is recommended to disconnect the TV from the mains plug to save more energy when you are not going to use it for a long period of time.

Repair Information

Please refer all servicing to qualified personnel. Only qualified personnel must repair the TV. Please contact your local dealer, where you have purchased this TV for further information.

Controlling the TV

A wide variety of external equipment can be connected via the sockets located on the side and back of the TV. Whilst all the necessary adjustments and controls for the TV are made using the remote control, the buttons on the Back of the TV may be used for some functions.

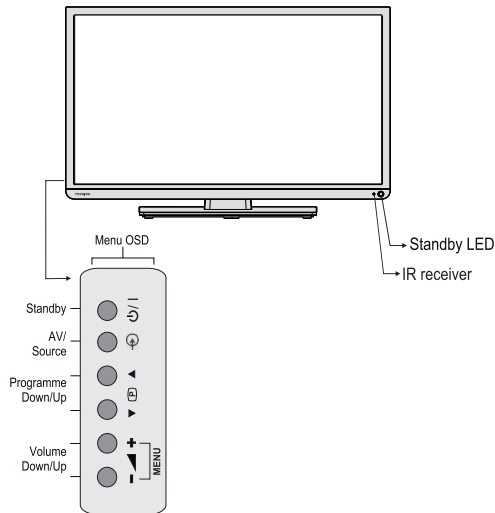

Switching on

If the standby LED is unlit, check that the mains plug is connected to the power and press the button on the back side of the television to switch the television on.

To put the television into Standby, press button on the remote control or on the TV. To view the television, press button again. The picture may take a few seconds to appear.

Note: The active Standby LED colour will turn to red in a few moments when the TV is switched into Standby.

For energy saving:

Turning the TV off at its mains supply, or un-plugging it, will cut energy use to nearly zero for all TV's. This is recommended when the TV is not being used for a long time, e.g. when on holiday.

Reducing the brightness of the screen will reduce energy use. Energy efficiency cuts energy consumption and thus saves money.

NOTE: Putting the TV into standby mode, will reduce energy consumption, but will still draw some power.

Using the Remote Control

Press the **MENU** button on the remote control to see the menus.

The main menu appears as a group of icons each for a menu option. Press the Left or Right button to select a topic.

In sub menu screen mode the menu appears as a list. Press the Up or Down button to select a topic.

To use the options press the Up and Down buttons on the remote control to move up and down through them and **OK**, Left or Right buttons to select the required choice. Follow the on screen instructions. The functions of each menu are described in detail throughout the manual.

Using the Controls on the TV

Using the control buttons on the Back of the TV:

- To alter the volume press or .
- To alter the programme position press on the Back of the TV.
- Press - buttons at the same to view main menu and use to navigate and - to change value.

To select an external input, press until the appropriate input source is selected.

Please always refer to the owner's manual of the equipment to be connected for full details..

Initial Installation

Before switching on the TV, put your decoder and media recorder to **Standby** if they are connected and ensure the aerial is connected to your TV. To set up the TV, use the buttons on the remote control as detailed on **page 8**.

IMPORTANT: Ensure that the aerial is connected and a Common Interface module is not inserted before switching on the TV for the first time installation.

1. Connect the mains plug and switch the TV on using the **Power** button. If the TV does not switch on, press any numbered or **Power** button on the remote control, then the language selection menu will be displayed. This screen will appear the first time that the TV is switched on and each time the TV is reset.

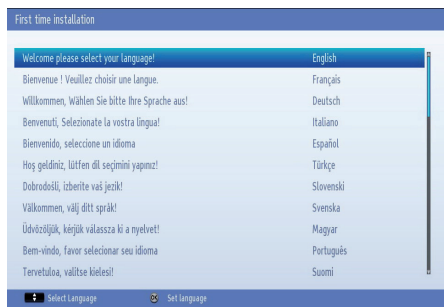

2. By pressing **Up** or **Down** button, highlight the language you want to set and press **OK** button. The following screen will be displayed next:

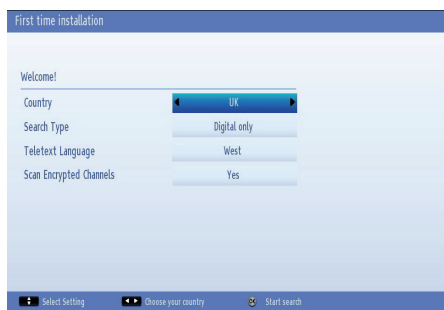

3. By pressing **Left** or **Right** button, select the **country** you want to set and press **Down** button to highlight the **Search Type** option. Use **Left** or **Right** to set the desired search type. Available search types are digital only, analogue TV only and full.
4. When set, press **Down** button to highlight Teletext Language. Use **Left** or **Right** button to select desired language region. Highlight **Scan Encrypted Channels** and enable/disable this

option by using **Left** or **Right** buttons.

5. Press **OK** button on the remote control to continue and the following message will be displayed on the screen:

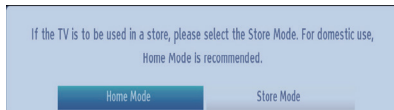

Select **Store mode** if the TV will be placed in a store to exhibit. This option will configure your TV's settings for best display quality and the supported features of the TV will be displayed on the top of the screen as a info banner. If **Store mode** is selected, a confirmation screen will be displayed. Select **YES** to proceed. This option will be available in **Other Settings** menu and can be turned off/on later.

If **Home Mode** is selected, **Store Mode** will not be available after the **First Time Installation**. For home use select **Home Mode**.

6. Press **OK** button on the remote control to continue and the following message will be displayed on the screen:

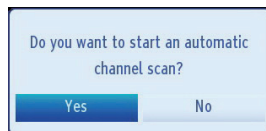

7. Select **Yes** button by using **Left** or **Right** button and press **OK** button to continue. Afterwards, the following OSD will be displayed on the screen:

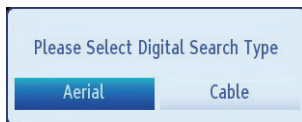

8. If you select **Cable** option, a confirmation screen will be displayed. Select **YES** to proceed. The following screen will be displayed:

Note: Although this cable feature can be selected, it is not fully supported in the UK. If cable signals are input to this TV from a Cable Network Provider some may be displayed.

Initial Installation - continued



9. You can select **Network**, **Frequency**, **Network ID** and **Search Step** from this screen. For highlighting lines you see, use **Up** or **Down** button. You can set **Search Step** as 8000 kHz or 1000 kHz. If you select 1000 kHz, the TV will perform search process in a detailed way. Searching duration will thus increase accordingly. When finished, press **OK** button to start automatic search.
10. If you select **Aerial** option from the Search Type screen, the television will search for broadcasts.
11. The Auto tuning screen will appear and the television will start to search for available stations. The progress bar will move along the line. You must allow the television to complete the search.

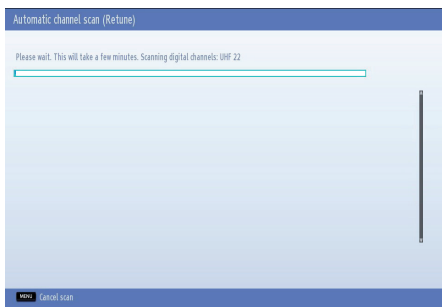

Note: You can press **MENU** button to cancel.

While the search continues a message will appear, asking whether you want to sort channels according to the LCN(*). Select **Yes** and press **OK** to confirm.

(* LCN is the Logical Channel Number system that organizes available broadcasts in accordance with a recognizable channel sequence (if available).

After the available stations are stored, **Edit Channel List** will be displayed on the screen.

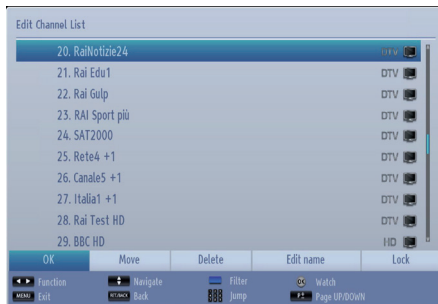

Press **OK** button to quit channel list and watch TV.

Note: Do not turn off the TV while initializing first time installation.

Auto Tuning

As new services are broadcast, it will be necessary to retune the television in order to view them.

- It is recommended to run Auto Tuning periodically to ensure that all new services are added. Please be aware that Auto Tuning will completely retune the television and all current channels and settings will be lost.
- Press **MENU** button on the remote control and select **Install and Retune** by using **Left** or **Right** button. Press **OK** button and the following menu screen will be displayed.

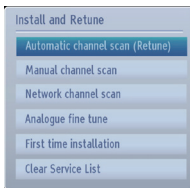

- Select **Automatic Channel Scan (Retune)** by using **Up** or **Down** button and press **OK** button. **Automatic Channel Scan** options will be displayed. You can select options by using **Up** or **Down** and **OK** buttons.

Auto Channel Scan Menu Operation

Digital Aerial: Searches and stores aerial DVB stations.

Digital Cable: Searches and stores cable DVB stations.

Analogue: Searches and stores analogue stations.

Digital Aerial & Analogue: Searches and stores aerial DVB and analogue stations.

Digital Cable & Analogue: Searches and stores cable DVB and analogue stations.

Note: Although this cable feature can be selected, it is not fully supported in the UK. If cable signals are input to this TV from a Cable Network Provider some may be displayed.

- Whenever you select an automatic search type and press **OK** button, a confirmation screen will appear on the screen. To start installation process, select **Yes**, to cancel select **No** by using **Left** or **Right** and **OK** button.
- After auto channel scan type is set and selected and confirmed, installation process will start and progress bar will move along. The television will

search for all available stations. You must allow the television to complete the search. Press **MENU** button to cancel the process. In such a case, located channels are not stored.

Manual Tuning, Analogue Fine Tuning

The television can be tuned-in manually using Manual Search feature.

Digital Aerial Manual Search

The feature is available for service engineers or can be used for direct channel entry if the multiplex channel is known.

- Select **Manual channel scan** from the **Install and Retune** menu and press **OK**.



After selecting search type as **Digital Aerial**, you can enter the multiplex or frequency number using the numeric buttons and press **OK** button to search.

- Enter the multiplex number using the numeric buttons. The television will automatically search for that multiplex. When the multiplex is found any channels not currently on the programme list will be added and the programme information at the top of the screen will be updated.
- Repeat as necessary.

Digital Cable Manual Search

- In cable manual scan, you can enter frequency, modulation, symbol rate and network channel scan options. After selecting search type as **Digital Cable**, you can set the desired options and press **OK** button to search.



Analogue Manual Search

Only if an analogue signal or Service is available.

The television can be tuned-in manually. For example: if the television cannot be connected to a media recorder/decoder with a **SCART** lead or to tune-in a station on another System.

To allocate a programme position on the television for a decoder and media recorder: turn the decoder on, insert a pre-recorded film into the media recorder and press **PLAY**, then manually tune.



After selecting search type as **Analogue**, you can use **Up** or **Down** button to highlight an item and then press **Left** or **Right** button to set an option.

Enter the channel number or frequency using the numeric buttons. You can then press **OK** button to search. When the channel is located, any new channels that are not on the list will be stored.

Analogue Fine Tune

Only if an analogue signal or Service is available.

- Select **Analogue Fine Tune** from the **Install and Retune** menu by using **Up** or **Down** and **OK** buttons. Analogue fine tune screen will be displayed. Analogue Fine Tune feature will not be available if there are no analogue channels stored.
- Use **Left** or **Right** button to set Fine Tune. When finished, press **OK** button.

Clear Service List (*)

(*) This setting is visible only when the Country option is set to Denmark, Sweden, Norway or Finland.

- Select **Clear Service List** from the **Install and Retune** menu by using **Up** or **Down** and **OK** buttons. A confirmation message will be displayed. If you want to delete all channels, select **Yes** and press **OK**. Use this setting to clear channels stored.

General Operation

Stereo and Bilingual Transmissions

If stereo or dual language broadcasts are transmitted, the word **Stereo** or **Dual** will appear on the screen each time positions are changed, disappearing after a few seconds. If the broadcast is not in stereo, the word **Mono** will appear.

Stereo... Press "**LANG - **" to select **Stereo** or **Mono**.

Bilingual... Bilingual transmissions are rare. If they are transmitted, the word **Dual** will be displayed. Choose the required programme number, and if the word **Dual** appears, press "**LANG - **" to select **Dual I**, **Dual II** or **Mono**.

For DTV broadcasts



To view current language and for changing to an alternative language (if available), press "**LANG - **" button. Available options will be listed.

Displaying Subtitles

In digital broadcasts, this feature will show subtitles on the screen in the selected language provided they are being broadcast.

Press **SUBTITLE** button to turn the subtitles on. Press **SUBTITLE** button again to turn the subtitles off.

Viewing Main Menu

Press **+ ** or **- ** buttons on the TV at the same time to view main menu.

Press **MENU** button on the remote control to view main menu.

Controlling Volume and Muting Sound



Volume

Press **+ ** or **- ** button on the remote control to adjust the volume.

Sound Mute

Press "****" button once to turn the sound off and again to cancel.

Selecting Programme Positions

To select a programme position use the numeric buttons on the remote control. Programme positions can also be selected using **P ** or **P ** buttons.

Press "**INFO - **" button to display the on-screen information i.e. programme position, stereo/mono signal and picture format.

Standby Notifications

If the TV switches off while in No Signal mode, the following on-screen message will be displayed on the next switch-on:

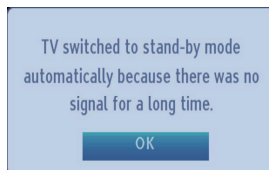

When the **Auto TV OFF** timeout is reached, the following message will be displayed on the screen. Select **Yes** to shut down the TV. Select **No** to cancel. The TV will switch off as well, if you do not make a selection on this screen.

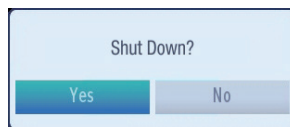

If the TV switches off owing to the auto power down feature, the following on-screen message will be displayed on the next switch-on:

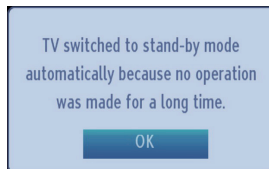

Channel List, Sorting Programmes, Programme Locking

You can view stored channels and sort them by using the Channel List feature.

Viewing Channel List

The channel order may be changed to suit your personal preference.

- Select **Channel List** from the main menu and press **OK** button. The following menu will be displayed:

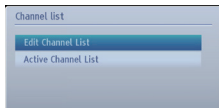

- Select **Edit Channel List** to manage all stored channels. Use **Up** or **Down** and **OK** buttons to select **Edit Channel List**.



- Press **Up** or **Down** button for selecting a channel. You can press **P▼** or **P▲** button to move page up or page down.
- To watch a specific channel, highlight it by using **Up** or **Down** button. Afterwards press **OK** button.
- Press **BLUE** button to view filtering options.
- Press **MENU** or **EXIT** button to exit.

Note: The channels listed are mixed at the channel list. Channel types can be differentiated by the icons next to them: DTV (digital tv), HD (HD TV), ATV (Analogue TV), TV (TV), Radio symbol (Radio), encrypted, lock, and FAV symbols (for channels in the favourite list). Listed channels can also be sorted by using the active channel list filter.

Moving a Channel

- Highlight the desired channel by using **Up** or **Down** button.
- Select **Move** option in the channel list by using **Left** or **Right** button and press **OK** button.
- **Edit Number** screen will be displayed. Enter the desired channel number by using the numeric buttons on the remote control and press **OK**. If there is a previously stored channel on that number, a warning screen will be displayed. Select **Yes** if you want to move the channel and press **OK**.

- Selected channel is now moved.

Deleting a Channel

You can press **GREEN** button to tag/untag all channels; **YELLOW** button to tag/untag channel.

- Select the channel that you want to delete and select **Delete** option by using **Left** or **Right** button. Press **OK** button to continue.
- A warning screen will appear. Select **Yes** to delete, select **No** to cancel. Press **OK** button to continue.

Renaming a Channel

- Select the channel that you want to rename and select **Edit Name** option by using **Left** or **Right** button. Press **OK** button to continue.
- Pressing **Left** or **Right** button moves to the previous/next character. Pressing **Up** or **Down** button changes the current character. Pressing the numeric buttons **0...9** replaces the highlighted character with the characters printed above the button one by one as the button is pressed.
- When finished, press **OK** button to save. Press **MENU** or **BACK** to cancel.

Locking a Channel

You can press **GREEN** button to tag/untag all channels; **YELLOW** button to tag/untag a single channel.

- Select the channel that you want to lock by using **Up** or **Down** button.
- Select **Lock** option by using **Left** or **Right** button. Press **OK** button to continue.
- You will be asked to enter parental control PIN. Enter the PIN number.

Note: Default PIN is set to 0000.

- Press **OK** button when the desired channel is highlighted to lock/unlock the channel. Lock symbol will be displayed next to the selected channel.

Viewing Info Banner, Electronic Programme Guide

Viewing Info Banner

- Press **INFO** -  button. The information screen will appear giving details of the channel and programme currently being viewed.

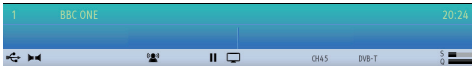

- Whenever you change channel, the TV displays the broadcast picture along with an information banner at the bottom of the screen. This will remain on the screen for a few seconds.
- If the selected channel is locked, you must enter the correct four numeric code to view the channel. "Enter PIN" will be displayed on the screen in such a case:

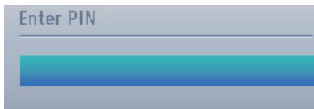

- Enter the 4-digit PIN number to continue.

Note: Factory set default PIN code is 0000.

Electronic Programme Guide

- Select the on-screen guide by pressing **GUIDE** button, the guide screen will appear highlighting details of the channel and programme currently being viewed. This may take a few moments to appear.



- For details of other programmes currently available, press navigation buttons to scroll up and down or scroll left/right through the list. As channels are selected, details of the programme currently being broadcast will appear.
- Press **RED** button to view the previous day.
- Press **GREEN** button to view the next day.
- Press **YELLOW** button for zooming to a programme.
- Press **BLUE** button to display filtering options.

- Press **SUBTITLE** button to sort channels by a genre.
- For information on a highlighted programme, press **i** button.
- Use **numeric buttons** for quickly selecting a broadcast.
- To set the timer for a selected programme, press **OK** button to select **Options** menu.
- Press **TEXT** button to display searching options.
- Press **"SWAP"** -  button for displaying current programmes.

Language Selection

Language Settings

Using this menu you can adjust the preferred language settings.

- Press **MENU** button and select **Settings** by using **Left** or **Right** button.
- Select **Language** and press **OK** to view this menu. Select the desired language by using **Left** or **Right** button. Press the **MENU** button on the remote control to exit.



Preferred

These settings will be used if available. Otherwise the current settings will be used.

Audio: By pressing **Left** or **Right** button change the audio language.

Subtitle: Alter the subtitle language with **Left** or **Right** button. The chosen language will be seen in subtitles.

Teletext: Changes the preferred teletext language.

Guide: By pressing **Left** or **Right** button change the guide language.

Current

Audio: If audio language is supported, change the audio language by pressing **Left** or **Right** button.

Subtitle: If subtitle is supported, alter the subtitle language with **Left** or **Right** button. The chosen language will be seen in subtitles.

Digital Settings - Parental Control, Menu Lock, Set PIN

You can view or set parental preferences of your TV.

Viewing Parental Control Menu

Press **MENU** button and select the **Settings** by using **Left** or **Right** button. Press **OK** button to view Settings menu. Use **Up** or **Down** button to highlight **Parental** and press **OK** to continue:

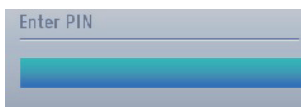

- A dialogue box asking for the lock key will be displayed. The default key is set to **0000**. Enter the PIN.
- If it is incorrect, "**Wrong PIN**" OSD will be displayed. If it is correct, the Parental Control menu will be displayed:

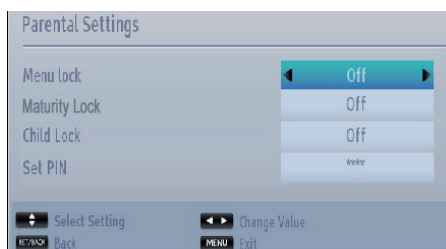

Note: Factory set default PIN code is 0000.

Menu Lock

In Menu lock you can set locking for **All menus**, or the **Installation menu** to restrict access to these menus. If the menu lock is disabled, there will be free access to the menu system.

- Use **Up** or **Down** buttons to go to **Menu Lock** option. Use **Left** or **Right** buttons to choose Menu Lock Mode.

OFF : All menus are unlocked.

ALL MENUS : All Menus are accessible only with the correct lock key. So the user cannot add, delete, rename, channels or set timers.

INSTALLATION MENU: Installation menu is locked. So the user can't add channels.

Maturity Lock (*)

When set, this option gets the maturity information from the broadcast and if this maturity level is disabled, disables access to the broadcast.

(*) *Not available for UK.*

Child Lock

Child Lock disables the buttons on the television. All buttons on the remote control can still be used.

Set PIN

- Use **Up** or **Down** buttons to select **Set PIN** option. Press **OK** to display the **Set PIN** window.
- Use numeric buttons to enter new pin number. You will need to input your new pin a second time for verification purposes.
- After typing correct PIN numbers, PIN number will be changed.

Note: If you change the pin number make sure you write it down and keep it safe.

Configuring Picture Settings

You can configure picture settings of your TV by using Picture Settings menu.

Configuring Picture Settings

You can use different picture settings in detail. You can customize current picture mode settings as desired. For example, you can change items such as, Brightness, Contrast, Colour and Sharpness.

Press **MENU** button and select **Picture** by using **Left** or **Right** button. Press **OK** button to view **Picture Settings** menu.



Operating Picture Settings Menu Items

- Press **Up** or **Down** button to highlight a menu item.
- Use **Left** or **Right** button to set an item.
- Press **MENU** button to exit.

Mode

This TV offers the choice of personalising the picture style. **Natural**, **Cinema**, **Game**, **Sports** and **Dynamic** are preset options and affect settings within the TV. Press **Left** or **Right** button to select the picture mode you prefer.

Note: Some options may be inactive depending on the selected mode.

Contrast

Sets the lightness and darkness values of the screen. Press **Left** or **Right** button to adjust the contrast.

Brightness

Sets the brightness value for the screen. Press **Left** or **Right** button to adjust the brightness.

Sharpness

Sets the sharpness value for the objects displayed on the screen. Press **Left** or **Right** button to adjust the sharpness.

Colour

Sets the colour value, adjusting the colours. Press **Left** or **Right** button to adjust the colour.

Power Save Mode

Enables or disables the power save mode. Press **Left** or **Right** button to set as **Disabled**, **Eco** or to turn the screen off. See the section **Environmental Information** in this manual for further information on **Power Save Mode**.

*Note: Picture mode will be set to **Dynamic** automatically if the **Power Save Mode** is set to **Disabled**.*

Backlight

This setting controls the backlight level and it can be set to **Auto**, **Low**, **Medium** and **High**.

*Note: The backlight function will be inactive if **Power Save Mode** is set to **Eco** or picture mode is set to **Game**.*

Noise Reduction

Sometimes some words or picture elements may become distorted or pixelated. Using the **Noise Reduction** feature reduces this effect by smoothing out the edges. Press **Left** or **Right** button to set noise reduction level.

Advanced Settings

Some additional controls in the picture menu are grouped under the title **Advanced Settings**. To view or change, first highlight **Advanced Settings** and press **OK** button to view. **Advanced Settings** menu controls are as the following:

Dynamic Contrast: You can change contrast rate by using dynamic contrast function. Dynamic contrast can be set to one of these options: **Low**, **Medium**, **High** or **Off**.

Colour Temp: Colour Temperature increases the 'warmth' or 'coolness' of the picture by increasing the red or blue tint. Colour temperature can be set to one of these options: **Normal**, **Warm** or **Cool**.

Picture Zoom: Sets the picture size to **Auto**, **Full**, **16:9**, **Subtitle**, **14:9**, **14:9 Zoom**, **4:3** or **Cinema**. Press **Left** or **Right** button to change the setting.

Film Mode (optional): Films are recorded at a different number of frames per second to normal television programmes. Press **Left** or **Right** button to set this feature to **Auto** or **Off**. Turn this feature to Auto when you are watching films to see the fast motion scenes clearly.

Skin Tone: Adjust the desired skin tone.

Colour Shift: Adjust the desired colour tone.

RGB Gain: Press **OK** button to edit RGB gain. You can configure the colour temperature values using the RGB Gain feature.

HDMI True Black (optional): While watching from HDMI source, this feature will be visible in the **Advanced Settings** menu.

You can use this feature to enhance blackness in the picture. Set this feature to **On** to activate.

Note: *HDMI True Black On/Off feature functions only when the HDMI device output is set to RGB.*

Reset

This feature allows you to reset the current Picture Settings to the default values. Press **MENU** button and select **Picture** by using **Left** or **Right** button. Press **Up** or **Down** button to select **Reset** and press **OK** button.

Note: *The reset function does not reset the settings for Mode, Noise Reduction, Colour Temp, Picture Zoom and HDMI True Black.*

Changing Picture Format

Press "SCREEN - " button repeatedly to select between **Auto(*)**, **Full(**)**, **16:9**, **Subtitle**, **14:9**, **14:9 Zoom**, **4:3** or **Cinema**.

Note: Using the special functions to change the size of the displayed image (i.e. changing the height/width ratio) for the purposes of public display or commercial gain may infringe on copyright laws.

Note: You can shift to screen up or down by pressing "▲"/"▼" buttons while picture zoom is selected as 14:9 Zoom, Cinema or Subtitle.

(*) When AUTO is selected, the aspect ratio of the screen is adjusted by the information provided by the selected source (if available). The format being displayed in AUTO mode is completely independent of WSS information which could be included in the broadcast signal or the signal from an external device.

Note: Auto mode will only be available in SCART, HDMI, YPbPr and DTV.

(**) Full mode is only available on HD channels.

16:9

Use this setting when watching a widescreen DVD, widescreen video tape or a 16:9 broadcast (when available). Due to the range of widescreen formats (16:9, 14:9 etc.) black bars may be visible on the top and bottom of the screen.

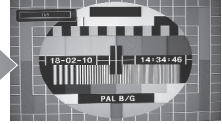

Subtitle

When subtitles are included on a letterbox format broadcast, this setting will raise the picture to ensure that all the text is displayed.

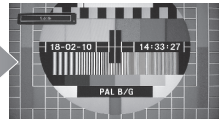

14:9

This zooms up the wide picture (14:9 aspect ratio) to the upper and lower limits of the screen.

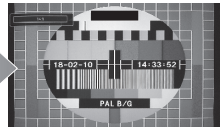

14:9 Zoom

This option zooms to the 14:9 picture.

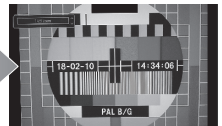

4:3

Use this setting to view a true 4:3 broadcast.

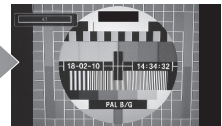

Cinema

This zooms up the wide picture (16:9 aspect ratio) to the full screen.

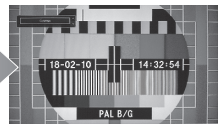

Configuring PC Picture Settings

PC Picture Settings (*)

(*) While in VGA/PC mode, some sections in Picture menu will be unavailable. Instead, VGA mode settings will be added to the Picture Settings while in VGA/PC mode.

PC Picture controls

Contrast, **Brightness** and **Colour** adjustments in this menu are identical to adjustments defined in TV picture menu.

Select **Reset** and press **OK** button to reset the adjustments.

Note:

For switching to **VGA/PC** source, press "**SOURCE -**  " button on your remote control and select **VGA/PC** input.

Note that **VGA/PC** mode menu settings are available only while the TV is in **PC** source.

PC Position

Select this to display PC position menu sections.



Autoposition

If you shift the picture horizontally or vertically to an unwanted position, use this section to put the picture into correct place automatically.

Highlight **Autoposition** and then press the **OK** button.

H Position

H (Horizontal) Position shifts the image horizontally to right hand side or left hand side of the screen.

Press **Down** button until **H Position** is highlighted.

Press **Left** or **Right** button to adjust the value.

V Position

V (Vertical) Position shifts the image vertically towards the top or bottom of the screen.

Press **Down** button until **V Position** is highlighted.

Press **Left** or **Right** button to adjust the value.

Dot Clock

Dot Clock adjustment corrects the interference that appear as vertical banding in dot intensive presentations like spreadsheets or paragraphs or text in smaller fonts.

Press **Down** button until **Dot Clock** is highlighted.

Press **Left** or **Right** button to adjust the value.

Phase

Depending on the resolution and scan frequency that you input to the TV Set, you may see a hazy or noisy picture on the screen. In such a case you can use this item to get a clear picture by trial and error method.

Press **Down** button until **Phase** is highlighted.

Press **Left** or **Right** button to adjust the value.

Configuring Sound Settings

You can configure sound settings of your TV by using Sound Settings menu.

Configuring Sound Settings

Sound settings can be configured according to your personal preferences.

Press **MENU** button and select **Sound** by using **Left** or **Right** button. Press **OK** button to view Sound Settings menu.

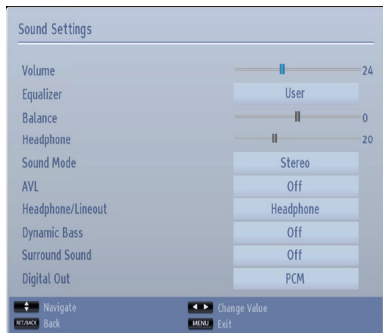

Operating Sound Settings Menu Items

- Press **Up** or **Down** button to highlight a menu.
- Use **Left** or **Right** button to set.
- Press **MENU** button to exit.

Volume

Select **Volume** using **Up** or **Down** button and then use **Left** or **Right** button to set volume level.

Equalizer (Only for speaker)

You can customize current sound mode settings. Select the appropriate mode in accordance with the installation location of the TV and adjust the equalizer on-screen as desired. Press **OK** button to view equalizer submenu.

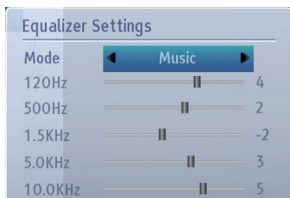

In equalizer menu, the preset can be changed to **Music**, **Movie**, **Speech**, **Flat**, **Classic** and **User**. Press the **MENU** button to return to the previous menu.

Note: Equalizer menu settings can be changed manually only when the **Equalizer Mode** is in **User**.

Balance (Only for speaker)

This setting is used for emphasizing left or right speaker balance.

- Press **Left** or **Right** button to change the level of the balance. Balance level can be adjusted between **-31** and **+31**.

Headphone

This setting is used to set the sound output when headphones are connected.

- Press **Up** or **Down** button to select **Headphone**.
- Press **Right** button to increase headphone volume level. Press **Left** button to decrease headphone volume level. Headphone volume level can be adjusted between 0 and 63.

Sound Mode

This setting is used to set the **Sound Mode**. Highlight **Sound Mode** by using **Up** or **Down** button. Press **Left** or **Right** button to set.

You can select **Mono**, **Stereo**, **Dual I** or **Dual II** mode, only if the selected channel supports that mode.

AVL

Sometimes there can be large changes in volume when switching from a DTV 5.1ch to a DTV 2ch, an ATV channel, or an external input. Using the AVL feature reduces these volume differences.

- Press **Up** or **Down** to highlight **AVL**. Press **Left** or **Right** button to set AVL as **On** or **Off**.

Headphone/Lineout

Set this option as **Lineout**, when an external amplifier is connected to the TV using the headphone jack. If headphones are connected to the TV, set this option as **Headphone**.

Dynamic Bass

Dynamic Bass is used to increase bass effect of the TV set. Select **Dynamic Bass** using **Up** or **Down** buttons and press **Left** or **Right** button to set.

Surround Sound

In the **Sound** menu, press **Up** or **Down** to highlight **Surround Sound**. Press **Left** or **Right** button to set **Surround Sound** as **On** or **Off**.

Digital Out

This setting enables you to set **Digital Out** preference as **Compressed** or **PCM**. You should set this feature in accordance with the received broadcast's content. Select **Digital Out** using **Up** or **Down** button and then use **Left** or **Right** button to set.

Settings Menu Operation, Conditional Access

Configuring Your TV's Settings

Detailed settings can be configured to suit your personal preferences.

Viewing Settings Menu

Press **MENU** button and select **Settings** by using **Left** or **Right** button. Press **OK** button to view Settings menu.

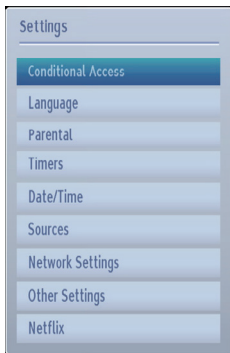

Operating Settings Menu Items

- Press **Up** or **Down** button to highlight a menu item.
- Press **OK** button to select an item.
- Press **MENU** button to exit.

Conditional Access

This setting controls conditional access modules when available. Use **Up** or **Down** button to highlight **Conditional Access**. Press **OK** button to continue.

Language

Configures language settings. See [page 22](#).

Parental

Configures parental settings. See [page 23](#).

Timers

Sets timers for selected programmes. See [page 30](#).

Date/Time

You can configure date/time preferences by using this menu screen. See [page 30](#).

Sources

Enables or disables selected source options. See [page 31](#).

Network Settings

Configures network settings. See [page 34](#).

Other Settings

Displays other setting options of the TV set.

Netflix

Netflix is a provider of on-demand internet streaming media. Press **Up** or **Down** button to highlight **Netflix**. Press **OK** button to proceed. **Deactivate** option is highlighted. Press **OK** button to deactivate Netflix. "**Deactivate Completed**" message appears on the screen. Once you deactivate Netflix, you have to sign in to use Netflix again.

Also use this option to view your ESN-number, which is a unique ID number for Netflix, created especially to identify your TV. Enter this number if requested by creating or using your Netflix account.

Netflix services are accessible via the Netflix app on the portal.

Using a Conditional Access Module

The Common Interface Slot, situated on the side of the television, enables the insertion of a CAM (Conditional Access Module) and card. These are purchased from a service provider and allow additional subscription broadcasts to be viewed. For more information, see a service provider.

IMPORTANT: Insert or remove the CAM only when the TV is SWITCHED OFF.

- In order to watch certain digital channels, a conditional access module (CAM) is necessary. This module must be inserted in the CI slot of your TV.
- Obtain the Conditional Access Module (CAM) and the viewing card by subscribing to a pay channel company, then insert those to the TV using the following procedure.
- Insert the CAM and then the viewing card to the slot that is located in the terminal cover at the rear side of the TV.
- The CAM should be correctly inserted, it is impossible to insert fully if reversed. The CAM or the TV terminal may be damaged if the CAM is forcefully inserted.
- Connect the TV to the mains supply, switch on and then wait for few moments until the card is activated.
- When no module is inserted, "**No common interface module detected.**" message appears on the screen.
- Refer to the module instruction manual for details of the settings.

Viewing Conditional Access Menu (*)

(*) *These menu settings may change depending on the service provider.*

Press **MENU** button and select **Settings** by using **Left** or **Right** button. Press **OK** button to view **Settings** menu. Use **Up** or **Down** button to highlight **Conditional Access** and press **OK** to view menu items.

Setting Timers, Setting Date/Time

Timers

To view Timers menu, press **MENU** button and select **Settings** by using **Left** or **Right** button. Press **OK** button to view **Settings** menu. Use **Up** or **Down** button to highlight **Timers** and press **OK** to continue:

Setting Sleep Timer

The television can be set to turn itself off after a certain length of time.

- Highlight **Sleep Timer** by using **Up** or **Down** button.
- Use **Left** or **Right** button to set. The timer can be programmed between **Off** and **2.00** hours (120 minutes) in steps of 30 minutes.

Setting Programme Timers

This feature will set the television to go to a specific channel at a certain time. It can be used to view a particular programme or can be used to view a series of programmes by setting the **Repeat** option to **Daily**, **Weekly** or **Weekdays**.

Press **Down** button to set timers on an event. Programme timer function buttons will be displayed on the screen.

Note: This feature will be available only when a timer has been programmed.

Adding a Timer

Press **YELLOW** button on the remote control to add a timer. The following menu appears on the screen:

Network Type: Set the network type to filter the channels that will be listed in the **Channel** option.

Timer Type: This feature is unavailable to be set.

Channel: Changes channel by using **Left** or **Right**.

Record Type: This feature is unavailable to be set.

Date: Enter a date using the numeric buttons.

Start: Enter a starting time using the numeric buttons.

End: Enter an ending time using the numeric buttons.

Duration: Displays duration between the starting and ending time.

Repeat: Sets a timer to be repeated as **Once**, **Daily**, **Weekly** or **Weekdays**. Use **Left** or **Right** button to select an option.

Change/Delete: Controls parental settings on timers.

Press **OK** button to save the timer. Press **BACK** button to cancel.

Editing a Timer

- Select the timer you want to edit by pressing **Up** or **Down** button.
- Press **GREEN** button to edit.
- When finished with editing, press **OK** button to save. You can press **RET/BACK** button to cancel.

Deleting a Timer

- Select the timer you want to delete by pressing **Up** or **Down** button.
- Press **RED** button.
- Select **Yes** by using **Left** or **Right** button and press **OK** to delete the timer. Select **No** to cancel.

Configuring Date/Time Settings

You can configure date/time preferences by using this menu screen.

- Select **Date/Time** in the Settings menu to configure Date/Time settings. Press **OK** button.



Use **Up** or **Down** button to highlight the **Time Settings Mode**. It can be set to **Auto** or **Manual**.

When **Auto** is selected, **Date**, **Time** and **Time Zone** options will not be available to be set. If **Manual** option is selected as the **Time Zone** can be altered:

Press **Up** or **Down** button to select **Time Zone**.

Use **Left** or **Right** button to change the **Time Zone** between GMT-12 or GMT+12. Date/Time on the top of the menu list will then change according to the selected Time Zone.

Note: For countries without Digital channels, only the Date and Time option will be displayed.

Source Settings, Other Controls

Configuring Source Settings

You can enable or disable selected source options. The TV will not switch to the disabled source options when the "SOURCE - " button is pressed.



- Select **Sources** in the **Settings** menu and press **OK** button.
- Press **Up** or **Down** buttons to select a source.
- Use **Left** or **Right** button to enable or disable the selected source. Changes are automatically stored.

Input Selection

Use the Input Selection window if the television does not switch over to a connected source automatically. Press "SOURCE - " button on your remote control for directly changing sources. Use the **Up** or **Down** button to highlight an input and press **Right** button to select.

Configuring Other Settings - General

You can configure the settings of your TV. Select **Settings** from main menu and press **OK** to view the **Settings** menu. Press the **MENU** button on the remote control to exit.

To view general configuration preferences, select **Other Settings** in the **Settings** menu and press **OK** button.



Operation

- Press **Up** or **Down** button to select an item.
- Use **Left** or **Right** button to set an option or press **OK** button to view a sub-menu.

Menu Timeout

To set a specific display timeout for menu screens, set a value for this option.

In the **Other Settings** menu, select **Menu Timeout** and choose **15 sec**, **30 sec**, **60 sec** or **Off** using **Left** or **Right** button.

Scan Encrypted Channels

When this setting is set as **Yes**, search process will locate the encrypted channels as well. If it is set as **No** manually, encrypted channels will not be located while in automatic search or manual search. Scan Encrypted Channel feature will always be **Yes** after performing first time installation.

- In the **Other Settings** menu, use **Up** or **Down** button to select **Scan Encrypted**.
- Press **Left** or **Right** button to set this function as **Yes** or **No**.

Blue Background

If the signal is weak or absent, the TV can automatically change to a blue screen. To enable this, set **Blue Background** to **On** from.

- The **Other Settings** menu, **Background** and select **On** or **Off** using **Left** or **Right** button.

Software Upgrade

This feature helps to keep your TV updated. It works automatically and searches for new information when available and selected.

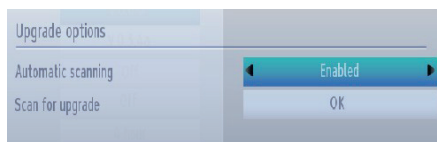

You can enable or disable automatic upgrade by the **Automatic Scanning** option.

You can manually start searching for new software by selecting **Scan for upgrade** and pressing **OK** button.

Press **BACK** or **MENU** button to cancel the process.

Application Version

Displays the current application version.

Hard of Hearing

If the broadcaster enables any special signal concerning the audio, you can set this setting as **On** to receive such signals.

- Use **Up** or **Down** button to select **Hard of Hearing** and then press **Left** or **Right** button to set this setting as **On** or **Off**.

Audio Description

Audio description refers to an additional narration track for blind and visually impaired viewers of visual media, including television and movies. The description narrator talks through the presentation, describing what is happening on the screen during the natural pauses in the audio (and sometimes during dialogue, if deemed necessary). You can use this feature, only if the broadcaster supports that additional narration track.

- Highlight **Audio Description** by pressing **Up** or **Down** button.
- Press **OK** button to enter Audio Description submenu.

- Use **Up** or **Down** button to select Audio Description setup and then press **Left** or **Right** button to set this setting.

Auto TV Off

You can set the timeout value of auto off feature. After the timeout value is reached and the TV is not operated for selected time, the TV will go off. Press **MENU** button and select **Settings** by using **Left** or **Right** button. Press **OK** button to continue. Use **Up** or **Down** button to select **Other Settings** and then press **OK** button. Select **Auto TV Off** using **Up** or **Down** button.

Store Mode

If you set **Store Mode** to **Enabled**, your TV's features will be illustrated on the top of the screen. To deactivate this feature, set to **Disabled**.

MEDIA Renderer

This feature allows to share/play files stored in a **MEDIA** compatible smartphone, tablet pc or laptop on the TV. Install an appropriate software on your device and read instructions of the sharing software for more information. Highlight **MEDIA Renderer** and press **Left** or **Right** button to enable or disable.

Power Up Mode

This setting configures the power up mode preference.

Standby: The TV always powers up in Standby mode.

Last State: The TV always switches on with the last selected channel/source.

CEC

This function allows to control the connected HDMI-CEC compatible devices with the remote control of the TV.

Select the HDMI input of the connected device from the source menu. The TV remote is automatically able to control most functions of the device (navigate menus, change channels, launch the disc etc.).

To disable this feature hold the "0-Zero" button on the remote control for 3 seconds. It is also possible to disable this feature in the configuration menu of the connected HDMI device. Refer to the operating instructions of the related device.

Press **Left** or **Right** button to enable or disable the feature.

CEC operation is available if a CEC device is present. The CEC osd menu is accessed through the "**QUICK**" button on the remote. The CEC osd menu will only be displayed if a CEC product is connected.

CEC Auto Power On

This function allows the connected HDMI-CEC compatible device to turn on the TV and switch to its input source automatically.

Press **Left** or **Right** button to enable or disable the feature.

Configuring Network Settings

Press the **MENU** button to open the main TV menu. Highlight **Settings** by pressing **Left** or **Right** buttons and press **OK** to enter. Highlight **Network Settings** and press **OK**. While **Network Type** is highlighted, press **Left** or **Right** buttons to select connection type. Press **OK** to enable the connection.

If you are going to make a wireless connection for the first time, press **YELLOW** button to search for available networks. If there is no presaved wireless profile on the TV, the TV will also search for available networks when pressed **OK**. Choose a network from the list and press **OK**. You may have to enter a password if the selected network is password-protected. Enter the password and choose **OK** on the virtual keyboard and press **OK**.

Wait a while and **Configuration Status** will change to **Connected**. **IP address** and **Network name** will appear, which means that the connection is done.

First enter to Toshiba Portal

At first time the  button is pressed, the TV downloads and installs the latest version of the portal if available. Then the introduction page of the portal setup wizard will be displayed. Press **OK** to proceed.

Next step is **End User License Agreement(EULA)**. The user have to scroll the whole text down to the end and check the box next to **Agree** by highlighting it and pressing the **OK** button. This means that the user accepts the agreement. Now, the user can highlight **Next** and proceed by pressing **OK**.

The user can skip the rest and portal page will be displayed. Account and profile settings can be configured later from the **Settings** menu on the portal.

Using the Toshiba Portal

You need to configure a home network before using this feature.

Toshiba Portal is a service, where content (web sites, applications, online services etc.) can be viewed across the web through a simple user interface.

Press  button on the remote. Select the desired application using the navigation buttons. Press **OK** to launch the application or go to related link. This can take up to a minute or two to connect.

From the portal page, the user can also access to the media files stored on USB storage devices connected to the TV or on the **MEDIA** servers in the same network.



NOTES:

- Some applications may require an always-on broadband internet connection, firmware update and/or additional bandwidth dedicated to this product.
- Third party internet services may change, be discontinued or restricted at any time.
- Use of third party internet services may require registration by a computer and if needed payment of charges and membership.
- Service content and the interface may be changed at any time without prior notice.

Toshiba makes no warranties about the content, availability or functionality of third-party content or services.

Using the Internet Browser

To use the internet browser, enter the portal first. Then launch the **Internet** application on the portal.

Predefined web sites and logos will be displayed on the browser's opening page to provide quick access. The user can add desired websites to the quick access page. To add a new quick access item, point the cursor to  whilst on the website and press **OK**. A submenu will be opened. Then point the cursor to  and press **OK**. On the next window, point the cursor to one of the quick access items and press **OK** to replace it with the new one.

To visit a web site move the cursor to the address bar using the navigation buttons on the remote and press **OK**. The virtual keyboard will be opened in a new window.

Enter the URL in the address bar. Point the cursor to  button and press **OK**.

To make a search on internet, enter a keyword in the address bar. Point the cursor to  button and press **OK**.

Press the **BACK** button to close the virtual keyboard or to go to previous page in the browser.

Press the  button to turn back to portal home page.

Press the **EXIT** button to close the portal and watch TV again.



NOTES:

- The virtual keyboard or numeric buttons on the remote, which are associated with the letters of the alphabet, can be used for entries.
- The browser does not support multiple tabs.
- Some internet pages include flash content. These are not supported by the browser.
- The TV does not support any download processes from the web browser.

Using YouTube™

You need to configure a home network before using this feature.

This TV allows you to view Youtube content.

Press "**Mybutton1** -  to connect YouTube directly. You can also press " button on the remote and launch the YouTube application on the portal to access YouTube.

NOTES:

- Depending on the network environment and use case, you may experience difficulty viewing the content.
- It may take time for the TV to load and begin playing back the content.
- Service content and the interface may be changed at any time without prior notice.

Using Media Browser

This TV allows you to enjoy photo, music or video files stored on a USB device or on a MEDIA SERVER.

Manual Start

To display **Media Browser** window, press the "▶" button on the remote control. The Media Browser menu is also accessible from the main menu. Press the **MENU** button on the remote. Select **Media Browser** by pressing **Left** or **Right** button and press **OK**.

Select the media type to be listed and press **OK**.

If there is more than one media source available, a list of devices and servers will be displayed. Highlight the device or server from the list and press **OK**.

Auto Start

When you plug a USB storage device, the following menu will be displayed.

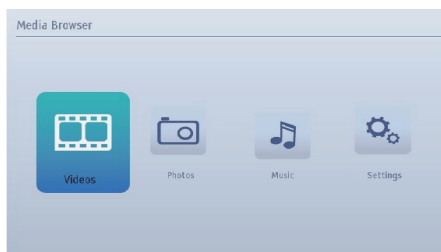

You can play or view music, video and picture files from an USB storage device connected to the USB port.

Moreover you can also play or view music, video and picture files from a **MEDIA SERVER** on the same network.

To display the files with folders, select **Settings** tab and change **View Style** to **Folder**. So the selected type of files in the selected folder will be displayed. Additionally the **All** tab will be added to the main **Media Browser** menu. To list all available music, video and picture files in the selected folder at once, select **All** tab and press **OK** button.

If **View Style** is set to **Flat**, all selected type of files will be listed. If for instance, **Video** is selected in the main **Media Browser** menu, TV will search the source for all video files and list them.

Note:

Some USB compliant devices may not be supported.

If the USB storage device is not recognized after power off/on or First Time Installation, plug the USB

device out and power off/on the TV set. Then plug it in again.

- Do not use a USB Hub.
- You must obtain any required permission from copyright owners to use copyright content.

Toshiba cannot and does not grant such permission.

- Depending on the file size and amount in your USB storage device or DMS, it may take some time for loading to view. A message will be displayed on the screen when loading files from the USB device or DMS.
- Only limited types of USB devices are supported. Therefore, it is suggested not to use USB for playing Media Player.
- Non-supported characters will be replaced with a square (□).

Using Media Browser - continued

This TV allows you to enjoy photo, music or video files stored on a USB device or on a MEDIA SERVER.

Playing MP3 Files

To play mp3 files from a USB memory or a DMS, you can use this menu screen.

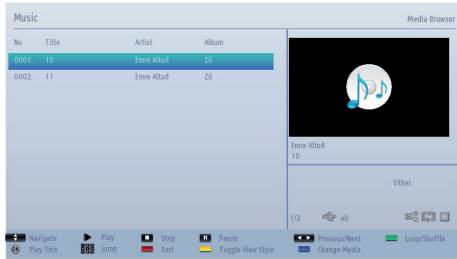

- **▼ / ▲:** Navigate menu.
- **Play (▶ button):** Start to play all files listed beginning with the selected one.
- **Stop (■ button):** Stop the playback.
- **Pause (⏸ button):** Pause/Resume the playback.
- **Red button:** Sort files by **Title**, **Artist** or **Album**.

*Note: If the **Viewing Style** in Media Browser Settings menu is set to **Folder**, the files will be displayed as sorted and there is no need to sort files again by pressing the **RED** button. In that case the **RED** button will not function anyway.*

- **Loop/Shuffle (Green button):** Press once to enable Loop. Press again to enable both Loop and Shuffle. Press once more to disable Loop. Press again to disable Shuffle. You can follow the disabled and enabled functions with the change of the icons.
- **Jump (Numeric buttons):** Type the file number using the numeric buttons on your remote to jump to a file directly. The file with the typed number will be only highlighted and will not be played.
- **Play This (OK button):** Play the selected file.
- **Previous/Next (Left/Right buttons):** Jump to previous or next file and play.
- **Yellow button:** Change viewing style.
- **Blue button:** Change media type.
- **Swap button:** Open the **Device Selection** menu. This option appears only when more than one media source is detected.

Viewing JPEG Files

To view photo files from a USB Memory or a DMS, you can use this menu screen. When you select **Photos** in the main **Media Browser** menu, available image files will be filtered and listed on this screen.

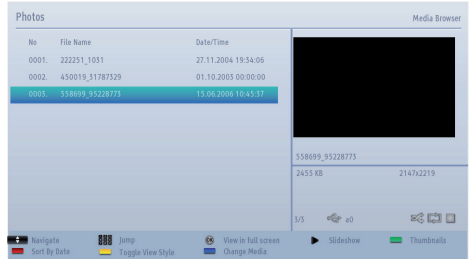

- **▼ / ▲:** Navigate menu.
- **Jump (Numeric buttons):** Type the file number using the numeric buttons on your remote to jump to a file directly.
- **OK:** View the selected image in full-screen.
- **Slideshow (▶ button):** Start the slideshow to view all the images automatically.
- **Green button:** View the images in thumbnails. Press again to turn back to previous layout.
- **Red button:** Sort files by date.
- **Yellow button:** Change viewing style.
- **Blue button:** Change media type.
- **Swap button:** Open the **Device Selection** menu. This option appears only when more than one media source is detected.

Using Media Browser - continued

This TV allows you to enjoy photo, music or video files stored on a USB device or on a MEDIA SERVER.

Slideshow Feature

You can use this feature to display all images automatically on your USB Memory or a DMS.

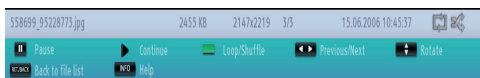

- **Pause (II button):** Pause the slideshow.
- **Continue (▶ button):** Continue the slideshow.
- **Loop/Shuffle (Green button):** Press once to enable Loop. Press again to enable both Loop and Shuffle. Press once more to disable Loop. Press again to disable Shuffle. You can follow the disabled and enabled functions with the change of the icons.
- **Previous/Next (Left/Right buttons):** Jumps to previous or next file on slideshow. When pressed, the slideshow pauses.
- **Rotate (Up/Down buttons):** Rotate the image using up/down buttons. When pressed, the slideshow pauses.
- **Return/Back:** Back to file list.
- **Info button:** Display info bar.

Video Playback

When you select **Videos** from Media Browser menu, available video files will be filtered and listed on this screen. You can use **Up** or **Down** button to select a video file and press **OK** button to play a video.

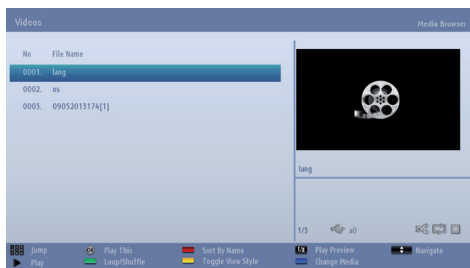

Note: If you select a subtitle file and press **OK** button, you can select or deselect that subtitle file.

Jump (Numeric buttons): Type the file number using the numeric buttons on your remote to jump to a file directly. The file with the typed number will be only highlighted and will not be played.

Play This (OK button): Play the selected file.

▼ / ▲: Navigate menu.

LANG - (O/I/I) (Play Preview): Display selected file in a small preview screen. Press again to stop preview.

Red button: Sort files by name.

Play (▶ button): Start to play all files listed beginning with the selected one.

Yellow Button: Change viewing style.

Loop/Shuffle (Green button): Press once to enable Loop. Press again to enable both Loop and Shuffle. Press once more to disable Loop. Press again to disable Shuffle. You can follow the disabled and enabled functions with the change of the icons.

Blue: Change media type.



Play (▶ button): Start the video playback.

Stop (■ button): Stop the video playback.

Pause (II button): Pause the video playback.

Rewind (◀◀ button): Goes backward.

Forward (▶▶ button): Goes forward.

Previous/Next (Left/Right buttons): Plays the previous/next file.

Subtitle/Audio (LANG - (O/I/I) button): Set Subtitle/Audio.

Green: Jumps to the selected time.

Ret/Back: Back to file list.

Yellow: Open subtitle time correction menu.

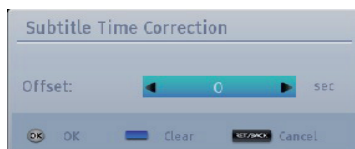

Press **OK** to confirm.

Press **BLUE** button to clear.

Press **BACK** button to switch back to previous menu.

Note:

You can set subtitles by using **OK** button before starting the playback or by using "**LANG - (O/I/I)**" button during the playback. Selected subtitles may not be displayed correctly in some cases.

Using Media Browser - continued

This TV allows you to enjoy photo, music or video files stored on a USB device or on a MEDIA SERVER.

In order to display movie subtitles correctly, you should set a subtitle language. See the section, *Subtitle in Language Settings for selecting movie subtitle language.*

Media Browser Settings



You can set your Media Browser preferences by using the **Settings** dialogue. Press **Up** or **Down** button to highlight an item and use **Left** or **Right** button to set.

View Style: Set default browsing mode. Set as **Flat** to list all selected type of files stored in the USB device or DMS. Set as **Folder** to list all selected type of files in the selected folder.

Slideshow Interval: Set slide show interval time.

Show Subtitle: Set subtitle enabling preference.

Subtitle Language: Set supported subtitle language.

Subtitle Position: Set subtitle position as **Up** or **Down**.

Subtitle Font Size: Set subtitle font size (max. 47pt).

Using MENU button in Media Browser Mode

Pressing **MENU** button while in Media Browser mode displays the following menu screen:

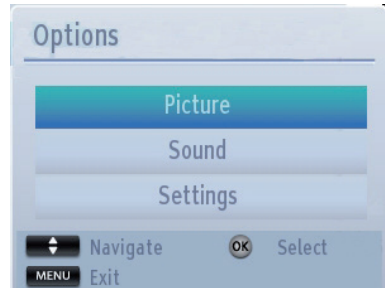

You can access **Picture**, **Sound** and **Settings** menu options using this screen. Press **MENU** again to exit from this screen.

To Close the Media Player

- Press **EXIT** button on the remote control.

Analogue Only Text Services

This television has a multi-page text memory, which takes a few moments to load.
Only available if an analogue service is transmitted.

Before using the text services, the required language region must be chosen.

- Select **Language** from the **Settings** menu.
- Highlight **Teletext** in the **Language Settings** menu and press **Left** or **Right** button to choose the required language region.

After the Teletext language is selected, press **MENU** button to exit.

Using Text Button -TEXT

- To view text services press **TEXT**. Press **TEXT** again to superimpose text over a normal broadcast picture.
- Press **TEXT** again to return to normal viewing.
- Programmes cannot be changed until text is cancelled.
- The first text page shown will be the initial page.
- Any text page can be accessed by entering the 3 digit page number using the numbered buttons. Press **P▼/▲** or **Up/Down** buttons to go to the next/previous page.
- Four coloured titles will appear at the base of the screen. To access one of the four given subjects, press the relevant coloured button on the remote control.
- For further information on your particular text system(s), see the broadcast text index page or, consult your local Toshiba dealer.

Below is a guide to the functions of the remote control text buttons.

Accessing Sub-pages

If a text page has sub-pages, press Left/Right buttons or enter the sub-page number 0001, 0002, 0003 etc. to access.

Revealing Concealed Text

To discover the solutions on quiz and joke pages press the "**INFO - I+**" button.

Holding a Page

At times it is convenient to hold a page of text. Press **OK** and "**HOLD**" will appear in the top left of the screen. The page will be held on screen until the button is pressed again.

To display an initial page

Press **RET/BACK** to access an initial page. The one displayed is dependant on the broadcaster.

Appendix C: PC Input Typical Display Modes

The following table is an illustration of some of the typical video display modes. Some, due to the display native resolution, are scaled automatically to enable correct image to be displayed.

Your TV may not support different resolutions. Supported resolution modes are listed below.

If you switch your PC to an unsupported mode, a warning OSD will appear on the screen.

Index	Resolution	Frequency
1	640x400	70Hz
2	640x350	85Hz
3	640x400	85Hz
4	640x480	60Hz
5	640x480	66Hz
6	640x480	72Hz
7	640x480	75Hz
8	640x480	85Hz
9	800x600	56Hz
10	800x600	60Hz
11	800x600	70Hz
12	800x600	72Hz
13	800x600	75Hz
14	800x600	85Hz
15	832x624	75Hz
16	1024x768	60Hz
17	1024x768	66Hz
18	1024x768	70Hz
19	1024x768	72Hz
20	1024x768	75Hz
21	1024x768	85Hz
22	1152x864	60Hz
23	1152x864	70Hz

24	1152x864	75Hz
25	1152x864	85Hz
26	1152x870	75Hz
27	1280x768	60Hz
28	1360x768	60Hz
29	1280x768	75Hz
30	1280x768	85Hz
31	1280x960	60Hz
32	1280x960	75Hz
33	1280x960	85Hz
34	1280x1024	60Hz
35	1280x1024	75Hz
36	1280x1024	85Hz
37	1400x1050	60Hz
38	1400x1050	75Hz
39	1400x1050	85Hz
40	1440x900	60Hz
41	1440x900	75Hz
42	1600x1200	60Hz
43	1680x1050	60Hz
44	1920x1080	60Hz
45	1920x1200	60Hz

Appendix D: AV and HDMI Signal Compatibility (Input Signal Types)

Source	Supported Signals		Available
EXT-1 (SCART1)	PAL		○
	NTSC 60		○
	RGB 50/60		○
	SECAM		○
EXT-1 (SCART2)	PAL		○
	NTSC 60		○
	SECAM		○
Side AV	PAL 50/60		○
	NTSC 60		○
	SECAM		○
YPbPr	480I	60Hz	○
	480P	60Hz	○
	576I	50Hz	○
	576P	50Hz	○
	720P	50Hz	○
	720P	60Hz	○
	1080I	50Hz	○
	1080I	60Hz	○
HDMI1 HDMI2 HDMI3	480I	60Hz	○
	480P	60Hz	○
	576I	50Hz	○
	576P	50Hz	○
	720P	50Hz	○
	720P	60Hz	○
	1080I	50Hz	○
	1080I	60Hz	○
	1080P	24Hz 25Hz 30Hz 50Hz 60Hz	○

Note: In some cases a signal on the LCD TV may not be displayed properly. The problem may be an inconsistency with standards from the source equipment (DVD, Set-top box, etc.). If you do experience such a problem please contact your dealer and also the manufacturer of the source equipment.

Appendix E: PIN Information

Before connecting any external equipment, turn off all main power switches. If there is no switch, remove the mains plug from the wall socket.

Signal information for Mini D-sub 15 pin connector

Pin No.	Signal name	Pin No.	Signal name	Pin No.	Signal name
1	R	6	Ground	11	NC
2	G	7	Ground	12	NC
3	B	8	Ground	13	H-sync
4	NC*	9	NC	14	V-sync
5	NC	10	Ground	15	NC

* NC = not connected

Appendix F: Supported File Formats for USB Mode

Supported File Formats for USB Mode

Media	Extension	Format		Notes
		Video	Audio	
Movie	.dat, .mpg, .mpeg	Mpeg1,2	MPEG1/2 Layer 1/2/3, AAC/HEAAC, AC3/EAC3, LPCM/ADPCM	1080P@30fps 50Mbit/sec
	.ts, .trp, .tp, .m2ts	MPEG2, H.264, VC1, AVS, MVC	MPEG1/2 Layer 1/2/3, AAC/HEAAC, AC3/EAC3, LPCM/ADPCM	H.264:1080Px2@25fps 1080P@50fps MVC: 1080P@24fps Other: 1080P@30fps 50Mbit/sec
	.vob	MPEG2	MPEG1/2 Layer 1/2/3, AC3, LPCM	1080P@30fps 50Mbit/sec
	.mkv	MPEG1,2,4, XviD, H.264, VC1,WMV3, Motion JPEG	MPEG1/2 Layer 1/2/3, AAC/HEAAC, AC3/EAC3, LPCM	H.264:1080Px2@25fps 1080P@50fps 1080P@30fps 50Mbit/sec
	.mp4		MPEG1/2 Layer 3, AAC/HEAAC, AC3/EAC3, LPCM/ADPCM	H.264: 1080Px2@25fps 1080P@50fps Other: 1080P@30fps 50Mbit/sec
	.avi	MPEG1,2,4 Xvid H.264, VC1,WMV3, Sorenson H.263 Motion JPEG	MPEG1/2 Layer 1/2/3, AAC/HEAAC, AC3/EAC3, LPCM/ADPCM, WMA	H.264: 1080Px2@25fps 1080P@50fps 1080P@30fps 50Mbit/sec
	.fla, .flv	H.264, Sorenson H.263	MPEG1/2 Layer 3, AAC/HEAAC, LPCM/ADPCM	H.264: 1080Px2@25fps 1080P@50fps 1080P@30fps 40Mbit/sec
	.3gp	MPEG4, H.264		1920x1080@30P 20Mbit/sec
.asf, .wmv	MPEG2,4, XviD, H.264, VC1,WMV3	MPEG1/2 Layer 1/2/3, AAC/HEAAC, AC3/EAC3, LPCM, WMA	1080P@30fps 50Mbit/sec	
Music	.mp3		MPEG1/2 Layer 1/2/3 (MP3)	
	.wav		LPCM	
	.WMA/ASF		WMA, WMA Pro	
	.m4a/ .aac		AAC, HEAAC	
Photo	.jpg, .jpeg	Baseline		MAX WxH = 14592x12288 Up to 8 MegaByte
		Progressive		
	.png	non-interlace		
		interlace		
	.bmp			
Subtitle	.sub	-	-	Sub1, Sub2, Sub3
	.srt	-	-	

Re-tune Section

Re-tuning: TOSHIBA Freeview Products

Toshiba Digital TV

This guide can be used to help you re-tune the following product with the remote control below.

Make sure your TV is on and a digital channel is selected



- 1) Press **MENU** and press ◀ or ▶ to select **Install and Retune** and press **OK**. Press ▲ or ▼ to select **Automatic channel scan (Retune)** to start the process.

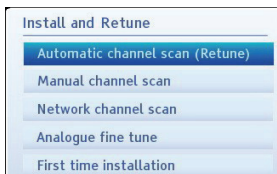

- 2) Select the desired search mode using ▶ and press **OK** button.
- 3) Whenever you select an automatic search type and press **OK** button, a confirmation screen will appear on the screen. To start installation process, select **Yes** by using ◀ or ▶ and **OK** button.

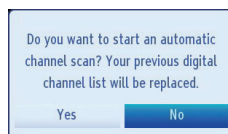

- 4) After auto channel scan type is set and selected and confirmed, installation process will start and progress bar will move along. The television will start to search for all available stations. You must allow the television to complete the search.

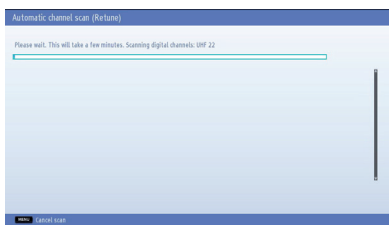

* This retune process may affect any saved information stored on your product. Please consult your on-line web manual or contact the Toshiba support as detailed below.

Specifications and Accessories

Broadcast Systems/Channels

DVB-T MPEG2, DVB-T MPEG4 HD, DVB-T2

DVB-C MPEG2, DVB-C MPEG4

Video Input

Stereo Nicam

PAL, SECAM, NTSC 4.43

External Connections

1-SCART 1

Input 21-pin SCART RGB, A/V

2-SCART-S (via SCART 1)

Input 21-pin SCART S-Video

3-YPbPr (via VGA)

Input Mini D-Sub 15-Pin Analogue

4-SIDE AV

Input Side AV Cable input Video + Audio L + R

5-HDMI 1/2/3

Input Type A

6-PC

Input Mini D-Sub 15-Pin Analogue RGB Signal

7-Digital Audio

Output S/PDIF (Coaxial)

8-YPbPr

Input YPbPr Connection Jack

9-LAN port

RJ-45

USB Ports

Media Browser Interface Version: USB 2.0

USB Class: Mass Storage

File System: FAT32

**For sets with built in wireless unit
the Home network with a wireless
router must be compatible with;**

IEEE 80211 a/b/g/n

Security Protocols WEP 64/128, WPA, WPA2, TKIP, AES, WAPI.

USB 2.0

3.5mm stereo

Temperature 5°C - 35°C (41°F - 94°F)

Humidity 20 - 80% (non-condensing)

Headphone Socket

Operating Conditions

Supplied Accessories

Remote Control

2 batteries (AAA, IEC R03 1.5V)

Four screws

Side AV cable

YPbPr Connection Cable

Stand fixing cover

P Clip

Optional Accessories

Wireless USB Adaptor - Toshiba WLM -30U2 and is available from the retail outlet or Toshiba service company.

	40" L
Energy Efficiency Class	A
Visible Screen Size (approx.)	102 cm / 40"
On Mode Power Consumption (approx.) (*)	62 W
Annual Power Consumption (approx.) (**)	90 kWh
Standby Power Consumption (approx.)	< 0.50 W
Screen Resolution (pixels)	1920 x 1080
Display	16:9
Sound Output (at 10% distortion)	2 x 8
Power Consumption Model (approx.)	100 W
Weight	TV with stand 13.5 kg
	Gross weight 17.0 kg
	TV without stand 10.0 kg

(*) Tested in accordance with IEC 62087-BD in default settings.

(**) Energy consumption 90 kWh per year, based on the power consumption of the television operating 4 hours per day for 365 days. The actual energy consumption will depend on how the television is used.

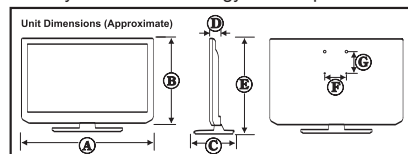

Specification is subject to change without notice.

	A (mm)	B (mm)	C (mm)	D (mm)	E (mm)	F (mm)	G (mm)
40L345*DB	932.83	560.23	249.00	107.00	602.80	200.00	200.00

License Information

- HDMI, the HDMI logo, and High-Definition Multimedia Interface are trademarks or registered trademarks of HDMI Licensing LLC in the United States and other countries.



- DVB is a registered trademark of the DVB Project.
- [1] EIA/CEA-861-D compliance covers the transmission of uncompressed digital video with high-bandwidth digital content protection, which is being standardized for reception of high-definition video signals. Because this is an evolving technology, it is possible that some devices may not operate properly with the television.
- YouTube and the YouTube logo are trademarks of Google Inc.
- NETFLIX is a registered trademark of NETFLIX, inc.

AVC licence letter

THIS PRODUCT IS LICENSED UNDER THE AVC PATENT PORTFOLIO LICENSE FOR THE PERSONAL AND NON-COMMERCIAL USE OF A CONSUMER TO (I)ENCODE VIDEO IN COMPLIANCE WITH THE AVC STANDARD ("AVC VIDEO") AND/OR (II)DECODE AVC VIDEO THAT WAS ENCODED BY A CONSUMER ENGAGED IN A PERSONAL AND NON-COMMERCIAL ACTIVITY AND/OR WAS OBTAINED FROM A VIDEO PROVIDER LICENSED TO PROVIDE AVC VIDEO. NO LICENSE IS GRANTED OR SHALL BE IMPLIED FOR ANY OTHER USE. ADDITIONAL INFORMATION MAY BE OBTAINED FROM MPEG LA, L.L.C. SEE [HTTP://WWW.MPEGLA.COM](http://www.mpegla.com)

Licence Notification

Manufactured under license from Dolby Laboratories.

TRADEMARK ACKNOWLEDGMENT

"Dolby" and the double-D symbol are trademarks of Dolby Laboratories.



Disposal...

The following information is only for EU-member states:

Disposal of products

The crossed out wheeled dust bin symbol indicates that products must be collected and disposed of separately from household waste. Integrated batteries and accumulators can be disposed of with the product. They will be separated at the recycling centres.

The black bar indicates that the product was placed on the market after August 13, 2005.

By participating in separate collection of products and batteries, you will help to assure the proper disposal of products and batteries and thus help to prevent potential negative consequences for the environment and human health.

For more detailed information about the collection and recycling programmes available in your country, please contact your local city office or the shop where you purchased the product.



Disposal of batteries and/or accumulators

The crossed out wheeled dust bin symbol indicates that batteries and/or accumulators must be collected and disposed of separately from household waste.

If the battery or accumulator contains more than the specified values of lead (Pb), mercury (Hg), and/or cadmium (Cd) defined in the Battery Directive (2006/66/EC), then the chemical symbols for lead (Pb), mercury (Hg) and/or cadmium (Cd) will appear below the crossed out wheeled dust bin symbol.

By participating in separate collection of batteries, you will help to assure the proper disposal of products and batteries and thus help to prevent potential negative consequences for the environment and human health. For more detailed information about the collection and recycling programmes available in your country, please contact your local city office or the shop where you purchased the product.



Q & A Section

	Question	Answer
Sound	Why is there no sound or picture?	Check if the TV is not in standby mode Check the mains plug and all mains connections
	Why is there a picture but no sound?	Check if the volume has not been turned off or sound mute has not been selected
	Why does the sound come only from one speaker when stereo sound is selected?	Check the balance in the SOUND menu if it has been set to one side or not
	Why is the soundtrack in English when a different audio language has been selected?	The programme is currently being broadcast with an English soundtrack only.
Picture	What can cause a poor picture?	Interference or a weak signal. Try a different TV station
	Why isn't the video / DVD being played shown on screen?	Make sure the Blu-ray of DVD player is connected to the TV as illustrated in the beginning chapters, then select the correct input by pressing SOURCE.
	Why is the Blu-ray / DVD player in black and white?	Check if the correct input has been chosen or not.
	Why are there horizontal stripes and/or blurred images on the screen when in PC mode?	The phase may need adjusting. Select PC settings and highlight Phase and adjust until the picture is clear.
General	Why doesn't the remote control work?	Check if the batteries are exhausted or inserted incorrectly
	Why doesn't the Media browser feature operate?	Make sure the USB stick / HDD is connected correctly. Incorrect operation may occur from a USB Hub connection. Check your network setup if using MEDIA SERVER.
	Why digital subtitles are not shown on screen when they are selected?	Subtitles are not currently being transmitted by the broadcaster
	Why is the digital channel locked?	Parental control is activated. Check parental settings
	Why are some encrypted digital channels unavailable?	Your subscription needs upgrading. Contact your service provider.
	Why does the active standby LED sometimes take longer to go out?	When in active standby, the TV's active standby will automatically search all available channels for updates, provided automatic update is enabled. The required time to do this may vary. Led blinks as red and green in this mode.
	Why don't the controls of the TV work?	Check if CHILD LOCK is selected or not
	What is DVB-T?	Digital Video Broadcast via an aerial / antenna.
	What is DVB-C?	Digital Video Broadcast via a cable system.
	How are radio channels selected?	You can select them via Channel list
	What can be done if the pin number is forgotten?	You can reset the TV and perform the first time installation again. Ensure that no one else is aware of this procedure by securely storing the Owner's Manual.
	Why don't the networked devices work?	Check the LAN cables if they are connected properly or not. If it is wireless connection, make sure the wireless network settings are done accordingly.

REACH information

The European Union (EU) chemical regulation, REACH (Registration, Evaluation, Authorization and Restriction of Chemicals), entered into force on 1 June 2007, with phased deadlines to 2018.

Toshiba will meet all REACH requirements and is committed to provide our customers with information about the presence in our articles of substances included on the candidate list according to REACH regulation.

Please consult the following website www.toshiba.eu/reach for information about the presence in our articles of substances included on the candidate list according to REACH in a concentration above 0.1 % weight by weight.

Toshiba hereby declares that this product with an integrated Wireless Function is in compliance with the essential requirements and other relevant provisions of Directive 1999/5/EC..



EU Conformity Statement



This product is carrying the CE-Mark in accordance with the related European Directives.

Responsible for CE-Marking is TOSHIBA TELEVISION CENTRAL EUROPE Sp. z o.o., ul. Pokoju 1 Biskupice Podgórne 55-040 Kobierzyce, Poland

This product is labeled with the CE Mark in accordance with the related European Directives, notably Low Voltage Directive 2006/95/EC, Electromagnetic Compatibility Directive 2004/108/EC and RoHS Directive 2011/65/EU. Furthermore the product complies with the Ecodesign Directive 2005/32/EC (EuP) and 2009/125/EC (ErP) and its related implementing measures.

If this product has an integrated Wireless LAN feature, the Radio Equipment and Telecommunications Terminal Equipment Directive 1999/5/EC is also applicable.

© TOSHIBA Television Central Europe Sp. z o.o. 2012
All rights reserved.

Reproduction in whole or part without written permission is strictly prohibited.

TOSHIBA Television Central Europe Sp. z o.o.
Ul. Pokoju 1, Biskupice Podgórne 55-040 Kobierzyce, Poland
Specification is subject to change without notice.

This equipment corresponds to requirements of the Technical Regulation on limitation of usage of certain dangerous substances in electrical and electronic equipment.

➤ CONSUMER PRODUCTS EUROPEAN STANDARD WARRANTY

➤ WARRANTY COVERAGE

a. System Warranty

The Toshiba Limited Warranty is applicable to all "Systems" sold since 01.01.2013. Toshiba warrants any Toshiba TV, Blu-ray-/DVD-Player, Satellite Receiver as well as TV-Accessory ("System") first sold to an end-user to be free from defects in components and workmanship under normal use for the duration of the warranty period which is twelve (12) months (Warranty Period), provided that any claims under this Limited Warranty must be applied for within the Warranty Period. The warranty period commences on the original date of purchase. Your original purchase invoice (sales receipt), showing the date of purchase, model number and serial number of the System, is your proof of the date of purchase.

This warranty is only applicable in countries which are covered under this Limited Warranty for your product, i.e. any country where Toshiba or its Authorised Service Providers offer warranty service subject to the terms and conditions provided in this warranty. You will find the list of covered countries at the end of this booklet.

This warranty covers the costs of service parts and labour required to restore your System to full working order. Toshiba will, at its option, repair or replace any defective Systems or parts thereof covered by this warranty with new or factory refurbished parts or Systems that are equal to new products in performance. A System or part that is repaired or replaced under this Limited Warranty shall be covered for the remainder of the original warranty period applying to the System or part, or for three months (3), whichever is longer. All exchanged parts and Systems replaced under this warranty will become the property of Toshiba. Further claims against Toshiba are expressly excluded.

This Limited Warranty is a commercial warranty granted by Toshiba and it does not affect your statutory rights, which may provide for additional rights available to consumers.

b. Customer Replaceable Units

Toshiba may service Customer Replaceable Units such as TV stands or remote control to end-user by shipment. Upon receipt by the end-user of the replacement part, the original part becomes the property of Toshiba. If requested by Toshiba, the original part should be returned to Toshiba at Toshiba's expense. In the event that the original part is not received by Toshiba within fifteen (15) working days following end-user's receipt of the shipment instructions, end-user will be charged the retail value of the replacement part.

➤ WARRANTY EXCLUSIONS AND DISCLAIMER

The Limited Warranty with respect to your System is subject to the following exclusions and limitations:

a. Exclusions

This Limited Warranty does not extend to:

1. Any System not manufactured by or for Toshiba, or sold to an end-user in a country not covered under this warranty.
2. Any System that has been damaged or rendered defective (a) as a result of use of the System other than for its normal intended use, failure to use the System in accordance with the User's Manual or other misuse, abuse, or negligence to the System; (b) by the use of parts not manufactured or sold by Toshiba; (c) by modification of the System; (d) as a result of service by anyone other than Toshiba or a Toshiba Authorised Service Provider; (e) by improper transportation or packing when returning the System to Toshiba or a Toshiba Authorised Service Provider; or (f) by improper installation of third party products (e. g. memory expansion cards).
3. Any System or parts thereof from which labels or serial numbers have been modified or made illegible.
4. Regular maintenance, inspection, fair wear and tear of consumable parts, e. g. remote control.
5. Cosmetic damages such as scratches and dents, scratched, faded or discolored frames, covers and plastics.
6. Commercial or professional use of the System.
7. Environmental damages and/or defects resulting from smoke, dust, carbon black or other external influences.
8. Defects due to force majeure as e.g. lightning, water, fire, incorrect voltage, insufficient ventilation.

If Toshiba's operating and maintenance instructions are not complied with, replacement parts or materials are used which do not correspond to the original specifications, or interventions are carried out through unqualified personnel or if the System shows any indication of misuse, overuse, negligent handling you will have to furnish proof that the defect was not caused by one of these circumstances.

TOSHIBA
Leading Innovation >>>

If the system is not entitled to this Limited Warranty due to one of the above mentioned reasons, Toshiba can still offer a repair, if requested by the customer. Please note that in this case Toshiba may charge the end-user for parts, labour and expenses. Furthermore Toshiba reserves the right to charge the end-user for the preparation of the cost estimate. Moreover, Toshiba may charge the costs incurred for the inspection of the System in cases where a damage or defect under this Limited Warranty has been negligently alleged which actually did not exist.

Toshiba is not liable for any transport/delivery/insurance costs, import duties, taxes, licensing fees and any charges from telephone/fax communication as consequence of the failure of the System.

b. Disclaimer of Warranty

Except for the express warranty provided and to the extent permitted by applicable law, Toshiba, its Authorised Resellers or Authorised Service Providers do not issue any warranty or guarantee for your System. Toshiba expressly excludes any other liability, whether express or implied, to the fullest extent allowed by the law. In particular, but without limit to the generality of the exclusion, any implied terms as to merchantability, satisfactory quality, fitness for a particular purpose and/or non-infringement of third party rights are excluded whether in contract or tort. Any implied warranties that may be imposed by law are limited in duration to the term of the express limited warranty given by Toshiba to the extent permitted by applicable law. To the maximum extent permitted by applicable law, in no event shall Toshiba or its supplier be liable for (1) damage to, or loss or corruption of records, data or removable storage media, or (2) any damages whatsoever (including direct or indirect damages, loss of business profits, lost savings or other special, incidental, exemplary or consequential damages whether for breach of warranty, contract, strict liability, tort or otherwise) arising out of or resulting from the use of or inability to use the products and/or the enclosed written materials, even if Toshiba, its supplier, an authorised Toshiba representative, service provider or dealer have been advised of the possibility of such damages or of any claim by any third party. Any liability of Toshiba or its supplier which is not excluded shall be limited to the purchase price of the System.

➤ OBTAINING WARRANTY SERVICE

Your Toshiba Limited Warranty includes a Carry-in or Send-in warranty service. In some countries, a Pick-up & Return warranty service might also be provided. To find out about the local coverage, please contact Toshiba or your Authorised Service Provider.

The warranty service will be subject to the following terms and conditions:

1. Repair service is available for Systems purchased and located within a country where Toshiba or its Authorised Service Providers offer warranty service subject to the terms and conditions provided in this Limited Warranty. Claims under this Limited Warranty will be honoured only if made within the warranty period.

2. Refer to the list with contact information for Toshiba and its Authorised Service Providers in the respective countries at the end of this booklet.

3. Before contacting Toshiba, please:

- Check if your System is connected to mains and switched on correctly;

Reset the System to its original configuration by removing accessories and external connections; unplug any remote storage devices or other peripherals;

- Consult the User's Manual for important tips on how to operate and troubleshoot your System;
- Note down System name, model number, serial number, hardware and software configuration and a description of the problem (e. g. error messages that appear on the screen);

4. Call the Toshiba Support Centre in the country where you are located in. Toshiba will attempt to resolve warranty issues over the telephone and may require your assistance in performing routine diagnostic procedures in connection with this call. Should the Toshiba Support Centre isolate hardware malfunctions on your system, you will be provided with an identification number and service instructions by the most convenient means (e. g. fax, email, voice).

5. If your System is eligible for Pick-up & Return warranty service, Toshiba will arrange pick-up of the defective unit from your location, repair it and return it back to your location. Toshiba will incur all repair, logistics and insurance costs in this process.

6. Under the terms of Carry-in or Send-in warranty service, you will be required to deliver your Toshiba System to a Toshiba Authorised Service Provider for warranty repair and arrange for its collection on completion of repair. You must prepay any shipping charges, taxes, or duties associated with transportation of the System to and from the Toshiba Authorised Service Provider. In addition, you are responsible for insuring the System both for delivery and collection as neither Toshiba nor the company offering warranty service on Toshiba's behalf, have any liability for damage or loss in transit.

7. Secure proper packing of the unit if you send it in or in case of pick up through Toshiba. Damages caused by improper packing by the end user will not be covered by Toshiba.

> REGISTRATION

Please register your warranty now at:

www.toshiba-europe.com/registration

Registration will help us to provide you with speedy service should you need to have your product repaired under warranty and it enables you to receive news about essential updates, details about new products and special offers to help you get the most from your Toshiba product.

The latest terms and conditions of the Toshiba Limited Warranty can be found at our website:

www.toshiba-europe.com/services

> GEOGRAPHIC COVERAGE

Below you will find a list of countries which are covered under the Toshiba Limited Warranty for your products. You can find the contact details of our Toshiba Support Center or Authorised Service Providers at:

www.toshiba-europe.com/asp-locator

Warrantor of the Toshiba Limited Warranty in the respective countries are the following Toshiba entities:

Toshiba Europe GmbH, Germany

Albania, Austria, Bosnia & Herzegovina, Bulgaria, Croatia, Cyprus, Czech Republic, Estonia, Germany, Greece, Hungary, Kosovo, Latvia, Lithuania, Macedonia, Malta, Montenegro, Poland, Portugal, Romania, Serbia, Slovakia, Slovenia, Spain, Switzerland

Toshiba Information Systems (UK) Ltd., United Kingdom

Denmark, Finland, Iceland, Ireland, Norway, Sweden, United Kingdom

Toshiba Systemes (France) S.A.S., France

France Métropolitaine, Italy

If you wish to view the advanced functions but do not have access to a computer or the internet then please contact your nearest owner's manual Helpline number from the numbers shown below.

Country name locally	Contact Number
Österreich	0810 - 144 122 (7,3 ct/min aus dem Festnetz der Telekom Austria, Mobil ggf. abweichend)
Belgique / Belgie	02 391 01 01
България	0294 21141
Hrvatska	01 653 9737
Κύπρος	22 872 111
Česká republika	323 204191
Danmark	80 88 93 38
Eesti Vabariik	69 97 800
Suomen tasavalta	0800 77 35 03
France	09 69 32 64 84
Deutschland	02131 52 40 999 (Ortsarif, abweichender Mobilfunktarif möglich)
Gibraltar	200 76334
Ελληνική	210 9554298
Magyar Köztársaság	23 428 870
Ísland	00 45 80 88 93 38
Yisrâ'el	03 953 5900
Italia	039 609 9301
Latvijas	00 372 69 97 800
Lietuvos	00 372 69 97 800
Luxembourg	00 32 2 391 01 01
Moldova	00380 443 511 317
Nederlanden	00 32 2 391 01 01
Norge	800 573 57
Polska	0 71 796 95 05
Portugal	707 265 265
Republic of Ireland	01 246 7780
România	021 3169 393
Россия	8 800 100 05 05
Slovensko	0042 323 204191
España	902 33 22 34
Sverige	0201 70 16 00
Schweiz / Suisse	0900 57 58 58 (CHF 1.49 / Min.)
Türkiye	0 212 340 6080
U.K.	0871 495 0730
Україна	8(044) 351 13 17

Please note the telephone number only applies to advanced owner's manual enquiries and not general operation of the TV.