

TOSHIBA
Leading Innovation >>>



REGZA

RV6D Digital
Series**
LV6D Digital
Series**



Contents

INSTALLING YOUR TV

Difference List between LV and RV Series	4
Safety Precautions	5
Installation and important information	6
The remote control	7
CT-90327 (for RV series)	7
CT-90326 (for LV series)	8
Inserting batteries and effective range of the remote	8

CONNECTING YOUR TV

Connecting external equipment	9
Connecting an HDMI™ or DVI device to the HDMI input	10
To connect an HDMI device	10
To connect a DVI device	10
Connecting a computer	11
To connect a PC to the RGB/PC terminal	11
To connect a PC to the HDMI terminal	11
Controls and input connections	12
Switching on	12
Using the remote control	12
Using the controls and connections	12

SETTING UP YOUR TV

Startup Application	13
Quick Setup	13
Ant/Cable In (if available)	14
Auto Tuning	15
ATV Manual Tuning	15
Tuning	15
Skip	17
Sorting positions	17
DTV Manual Tuning	18
Manual Tuning	18
Manual Tuning for DVB-C	18
DTV Settings	18
Channels	18
Auto Channel Update	19
DVB Character Set	19
Dynamic Scan	19
Location setting	19
Analogue switch-off	19

CONTROLS AND FEATURES

General controls	20
Selecting positions	20
The Time Display – analogue only	20
Stereo and Bilingual transmissions	20
Quick Menu	20
Sound controls	21
Volume controls and mute sound	21
Dual	21
Bass, Treble and Balance	21
Advanced Sound Settings	21
Stable Sound® (LV series only)	21
Dolby Volume® (RV series only)	21
Dynamic Range Control	21
Audio Level Offset	22
Headphone Settings	22
Audio description	22
Widescreen viewing	23
Picture controls	25
Picture Position	25
Picture Mode	25
Picture preferences	25
Reset	26
3D Colour Management	26
Base Colour Adjustment	26
Colour Temperature	26
Auto Brightness Sensor Settings	27
Active Backlight Control	27
Black/White Level	27
Static Gamma	27
MPEG NR – Noise Reduction	27
DNR – Digital Noise Reduction	27
Resolution+	28
Cinema Mode	28
Expert Mode	28
Resetting the advanced picture settings	28
Control Visualization	29
Automatic Format (Widescreen)	29
4:3 Stretch	29
Blue Screen	29
Side panel adjustment	29
Picture still	29
HDMI Information Display	29
Enjoying Photos through the USB port	30
To select the Auto Start function	30
To open Photo Viewer	30
Viewing photo files	31
Other features	32
Panel Lock	32
TOSHIBA Illumination (RV series only)	32

The timers	32
Programme Timers – digital only	32
On Timer	33
Sleep Timer	33
Digital on-screen information and Programme	
Guide	34
Information	34
Guide	35
Genre selection/searching	35
Digital settings – parental control	36
Setting the PIN	36
Parental Setup	36
Digital settings – Channel Options	37
Skipping channels	37
Locking channels	37
Digital settings – other settings	37
Subtitles	37
Audio languages	37
Common Interface	38
Software Upgrade and Licenses	38
Auto Upgrade	38
Searching for New Software	38
Software Licenses	38
System Information and Reset TV	39
System Information	39
Automatic Power Down	39
Reset TV	39
PC Settings	39
Horizontal and Vertical Position	39
Clock Phase	39
Sampling Clock	40
Reset	40
Input selection and AV connections	40
Input selection	40
External input skip	40
Input signal selection	41
PC Audio	41
HDMI 1 Audio	41
HDMI Settings	41
Digital Audio Output	42

TEXT SERVICES

Text services	43
Selecting modes	43
Text information	43
Navigating pages using Auto	43
Navigating pages using LIST	43
Control buttons	44

PROBLEM SOLVING

Questions and Answers	45
-----------------------------	----

INFORMATION

License Information	48
Information	50
Specifications and accessories	52

Difference List between LV and RV Series

Please confirm your TV's specifications in the following table.

NOTE: The model number is on the back of your TV.

Item	RV685D/RV675D	LV685D/LV675D	RV665D	LV665D
Receiving signal				
DVB-T	●	●	●	●
DVB-C	●	●	●	●
H.264	●	●	—	—
Sound				
HE-AAC	●	●	—	—
Dolby Digital	●	●	—	—
Dolby Digital Plus	●	●	—	—
Dolby Volume	●	—	●	—
TOSHIBA LOGO Illumination	●	—	●	—
Remote control	CT-90327	CT-90326	CT-90327	CT-90326

NOTE: The illustrations of the menu display in this manual show the LV685D as an example.

Safety Precautions

This equipment has been designed and manufactured to meet international safety standards, but like any electrical equipment, care must be taken to obtain the best results and for safety to be assured. Please read the points below for your own safety. They are of a general nature and are intended to help with all electronic consumer products. Some points may not apply to the goods you have just purchased.

Air Circulation

Leave more than 10cm clearance around the television to allow adequate ventilation. This will prevent overheating and possible damage to the television. Dusty places should also be avoided.

Heat Damage

Damage may occur if the television is left in direct sunlight or near a heater. Avoid places subject to extremely high temperatures or humidity. Place in a location where the temperature remains between 5°C (41°F) min. and 35°C (94°F) max.

Mains Supply

The mains supply required for this equipment is 220-240v AC 50/60Hz. Never connect to a DC supply or any other power source. DO ensure that the television is not standing on the mains lead. Use only the supplied lead.
DO NOT cut off the mains plug from this equipment. The plug incorporates a special Radio Interference Filter, the removal of which will impair its performance.
IF IN DOUBT PLEASE CONSULT A COMPETENT ELECTRICIAN.

Do

DO read the operating instructions before you attempt to use the equipment.

DO ensure that all electrical connections (including the mains plug, extension leads and inter-connections between pieces of equipment) are properly made and in accordance with the manufacturers' instructions. Switch off and withdraw the mains plug before making or changing connections.

DO consult your dealer if you are ever in doubt about the installation, operation or safety of your equipment.

DO be careful with glass panels or doors on equipment.

DO NOT REMOVE ANY FIXED COVERS AS THIS WILL EXPOSE DANGEROUS AND 'LIVE' PARTS.

THE MAINS PLUG IS USED AS A DISCONNECTING DEVICE AND THEREFORE SHOULD BE READILY OPERABLE.

Do not

DO NOT obstruct the ventilation openings of the equipment with items such as newspapers, tablecloths, curtains, etc. Overheating will cause damage and shorten the life of the equipment.

DO NOT allow electrical equipment to be exposed to dripping or splashing or objects filled with liquids, such as vases, to be placed on the equipment.

DO NOT place hot objects or naked flame sources, such as lighted candles or nightlights, on or close to equipment. High temperatures can melt plastic and lead to fires.

DO NOT use makeshift stands and NEVER fix legs with wood screws. To ensure complete safety, always fit the manufacturers' approved stand, bracket or legs with the fixings provided according to the instructions.

DO NOT leave equipment switched on when it is unattended, unless it is specifically stated that it is designed for unattended operation or has a standby mode. Switch off by withdrawing the plug, and make sure your family knows how to do this. Special arrangements may need to be made for people with disabilities.

DO NOT continue to operate the equipment if you are in any doubt about it working normally, or it is damaged in any way – switch off, withdraw the mains plug and consult your dealer.

WARNING – excessive sound pressure from earphones or headphones can cause hearing loss.

ABOVE ALL – NEVER let anyone, especially children, push or hit the screen, push anything into holes, slots or any other openings in the case.

NEVER guess or take chances with electrical equipment of any kind – it is better to be safe than sorry.

Installation and important information

Where to install

Locate the television away from direct sunlight and strong lights. Soft, indirect lighting is recommended for comfortable viewing. Use curtains or blinds to prevent direct sunlight falling on the screen.

Place the TV on a stable, level surface that can support the weight of the TV. **In order to maintain stability and prevent it falling over, secure the TV to the level surface using the strap located under the table top stand, or to a wall using a sturdy tie to the clip on the back of the table top stand.**

The LCD display panels are manufactured using an extremely high level of precision technology, however, sometimes some parts of the screen may be missing picture elements or have luminous spots. This is not a sign of a malfunction.

Make sure the television is located in a position where it cannot be pushed or hit by objects, as pressure will break or damage the screen. Also please be certain that small items cannot be inserted into slots or openings in the case.

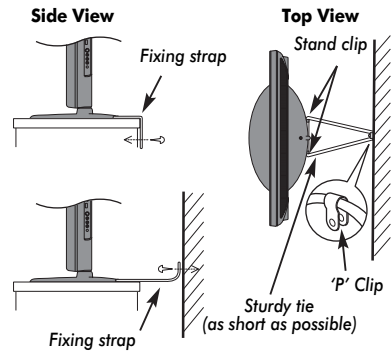

Cleaning the screen and cabinet...

Turn off the power, and clean the screen and cabinet with a soft, dry cloth. We recommend that you do not use any proprietary polishes or solvents on the screen or cabinet as this may cause damage.

Please take note

The digital reception function of this television is only effective in the countries listed in the "Country" section of the "SETUP" menu. Depending on country/area, some of this television's functions may not be available. Reception of future additional or modified services can not be guaranteed with this television.

If stationary images generated by 4:3 broadcasts, text services, channel identification logos, computer displays, video games, on screen menus, etc. are left on the television screen for any length of time, they could become conspicuous. It is always advisable to reduce both the brightness and contrast settings.

Very long, continuous use of the 4:3 picture on a 16:9 screen may result in some retention of the image at the 4:3 outlines. This is not a defect of the LCD TV and is not covered under the manufacturer's warranty. Regular use of other size modes (eg: Super Live) and varying the "side panel" brightness (if available on the model) will prevent permanent retention.

EXCLUSION CLAUSE

Toshiba shall under no circumstances be liable for loss and/or damage to the product caused by:

- i) fire;
- ii) earthquake;
- iii) accidental damage;
- iv) intentional misuse of the product;
- v) use of the product in improper conditions;
- vi) loss and/or damage caused to the product whilst in the possession of a third party;
- vii) any damage or loss caused as a result of the owner's failure and/or neglect to follow the instructions set out in the owner's manual;
- viii) any loss or damage caused directly as a result of misuse or malfunction of the product when used simultaneously with associated equipment;

Furthermore, under no circumstances shall Toshiba be liable for any consequential loss and/or damage including but not limited to the following, loss of profit, interruption of business, the loss of recorded data whether caused during normal operation or misuse of the product.

NOTE: A Toshiba wall bracket or stand, where available, must be used.

The remote control

Simple at-a-glance reference for your remote control.

CT-90327 (for RV series)

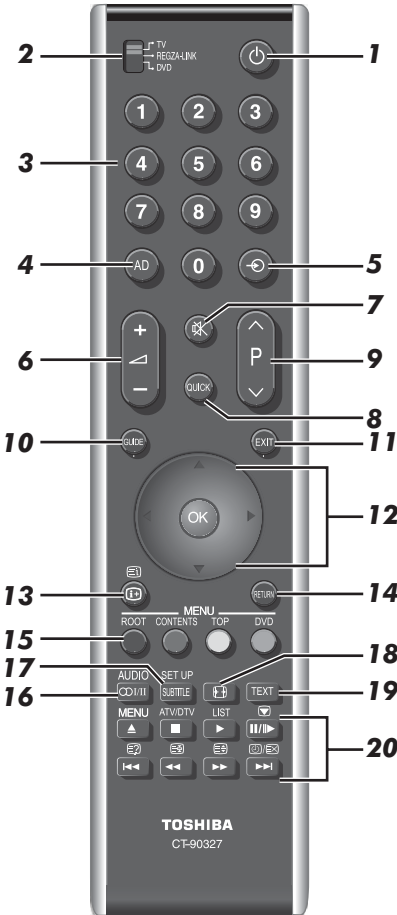

- 1 For On/Standby mode (T/D)*
- 2 To select device mode (T/D)**
- 3 Number buttons (T/D)
- 4 Switch the Audio Description On/Off (T)
- 5 To select external input sources (T)
To select line input (D)
- 6 To alter the TV volume (T/D)
- 7 To mute the TV sound (T/D)

- 8 To access Quick Menu (T)
- 9 To change programme positions (T)
To change text pages (T)
- 10 To display the digital on-screen Programme Guide (T)
- 11 To exit menus (T)
- 12 When using menus, the arrows move the cursor on the screen up, down, left or right. Press **OK** to confirm your selection (T/D)
- 13 To display on-screen information (T/D)
To access index page in Text mode (T)
- 14 To return to previous menu (T/D)
- 15 **Colour buttons** Text and interactive service control buttons (T)
 - TOP** To access Top Menu (D)
 - DVD** DVD Menus (D)
- NOTE: ROOT and CONTENTS are not used for this model.**
- 16 **COOL III** Stereo/bilingual transmissions (T)
AUDIO To Access Audio menu (D)
- 17 **SUBTITLE** Digital Subtitles or Analogue TEXT Subtitle pages if available (T)
SET UP To access Setup menu (D)
- 18 Widescreen viewing (T/D)
- 19 To call up text services (T)
- 20 **When in TV mode:**
 - MENU** On-screen menus
 - ATV/DTV** To switch between ATV (analogue television) and DTV (digital television)
 - LIST** To switch between TV and Radio programmes when in digital mode
 - Picture still** Picture still
 - Analogue time display** Analogue time display
- When in Text mode:**
 - To reveal concealed text**
 - To hold a wanted page**
 - To enlarge text display size**
 - To select a page whilst viewing a normal picture**

- When using the Programme Guide:**
 - Left arrow** - 24 hours
 - Right arrow** + 24 hours
 - Up arrow** - 1 page
 - Down arrow** + 1 page

- DVD mode:**
 - press **Up arrow** to EJECT
 - press **Stop** to STOP
 - press **Right arrow** to PLAY
 - press **Pause/Play** to PAUSE/STEP
 - press **Left arrow** to SKIP-BACK
 - press **Left arrow** to REWIND
 - press **Right arrow** to FAST FORWARD
 - press **Right arrow** to SKIP-FORWARD

* T=TV mode, D=DVD mode
** REGZA-LINK mode is not available for this TV.

CT-90326 (for LV series)

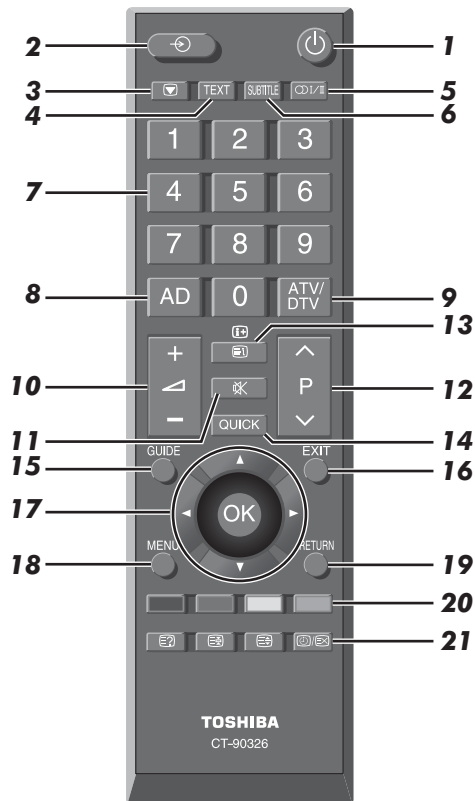

- 1 For On/Standby mode
- 2 To select external input sources
- 3 Picture still
- 4 To call up text services
- 5 Stereo/bilingual transmissions
- 6 Digital Subtitles or Analogue TEXT Subtitle pages if available
- 7 Number buttons
- 8 Switch the Audio Description On/Off
- 9 To switch between ATV (analogue television) and DTV (DTV TV/DTV RADIO/DTV TEXT if available)
- 10 To alter the TV volume
- 11 To mute the TV sound

- 12 In TV mode: To change programme positions
In Text mode: To change text pages
- 13 In TV mode: To display on-screen information
In Text mode: To access index page in Text mode
- 14 To access Quick Menu
- 15 To display the **digital** on-screen Programme Guide
- 16 To exit menus
- 17 When using menus, the arrows move the cursor on the screen up, down, left or right. Press **OK** to confirm your selection
- 18 To display the on-screen menu
- 19 To return to the previous menu
- 20 Text control buttons
- 21 **When in Text mode:**
 - To reveal concealed text
 - To hold a wanted page
 - To enlarge text display size
 - To select a page whilst viewing a normal picture
- When in TV mode:**
 - Analogue time display

Inserting batteries and effective range of the remote

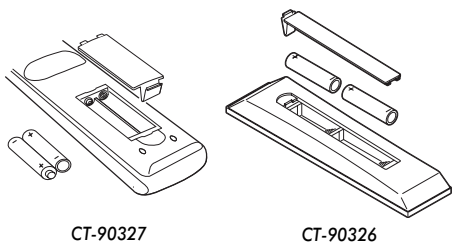

Remove the back cover to reveal the battery compartment and make sure the batteries are inserted the proper way. Suitable battery types for this remote are AAA, IEC R03 1.5V.

Do not combine a used, old battery with a new one or mix battery types. Remove dead batteries immediately to prevent acid from leaking into the battery compartment. Dispose of them in accordance with instructions on page 48 of this manual. **Warning:** batteries must not be exposed to excessive heat such as sunshine, fire or the like.

The performance of the remote control will deteriorate beyond a distance of five metres or outside an angle of 30 degrees from the centre of the television. If the operating range becomes reduced, the batteries may need replacing.

Connecting external equipment

Before connecting any external equipment, turn off all main power switches. If there is no switch, remove the mains plug from the wall socket.

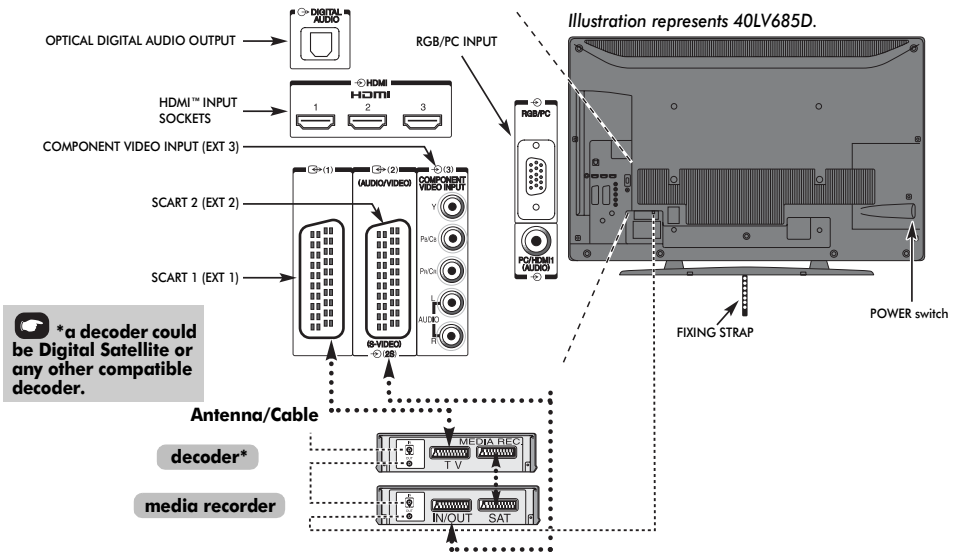

Aerial cables:

Connect the aerial to the socket on the rear of the television. If you use a decoder* and/or a media recorder, it is essential that the aerial cable is connected through the decoder and/or through the media recorder to the television.

SCART leads:

Connect the video recorder **IN/OUT** socket to the television. Connect the decoder **TV** socket to the television. Connect the media recorder **SAT** socket to the decoder **MEDIA REC.** socket.

Before running **Auto Tuning**, put your decoder and media recorder to **Standby**.

The phono sockets alongside the COMPONENT VIDEO INPUT sockets will accept L and R audio signals.

The Digital Audio Output socket enables the connection of a suitable surround sound system. **NOTE: this output is always active.**

HDMI™ (High-Definition Multimedia Interface) is for use with a DVD decoder or electrical equipment with digital audio and video output.

For acceptable video or PC signal formats through the HDMI terminals, see page 51.

NOTE: Although this television is able to connect to HDMI equipment, it is possible that some equipment may not operate correctly.

A wide variety of external equipment can be connected to the back of the television; therefore, the relevant owner's manuals for all additional equipment must be referred to for exact instructions.

We recommend SCART 1 for a decoder and SCART 2 for a media recorder.

If connecting S-Video equipment, set **EXT 2 Input** mode to **S-VIDEO**. See page 41.

If the television automatically switches over to monitor external equipment, return to normal television by pressing the desired programme position button. To recall external equipment, press \odot to select between **DTV, EXT 1, EXT 2, EXT 3, HDMI 1, HDMI 2, HDMI 3, HDMI 4, PC** or **ATV**.

When the external input mode is selected while viewing DTV mode, the SCART socket does not output video/audio signals. The SCART output will also be muted in EPG mode.

DOLBY DIGITAL PLUS Manufactured under license from Dolby Laboratories.
Dolby and the double-D symbol are registered trademarks of Dolby Laboratories.

HDMI HDMI, the HDMI logo, and High-Definition Multimedia Interface are trademarks or registered trademarks of HDMI Licensing, LLC.

INSTAPORT™ and INSTAPORT logo are trademarks of Silicon Image, Inc. in the United States and other countries.

Connecting an HDMI™ or DVI device to the HDMI input

The HDMI input on your television receives digital audio and uncompressed digital video from an HDMI source device or uncompressed digital video from a DVI (Digital Visual Interface) source device.

This input is designed to accept HDCP (High-Bandwidth Digital-Content Protection) programme material in digital form from EIA/CEA-861-D-compliant [1] consumer electronic devices (such as a set-top box or DVD player with HDMI or DVI output). For acceptable video signal formats, see page 51.

NOTE:

- Some early HDMI equipment may not work properly with your latest HDMI TV, due to the adoption of a new standard. Please unplug your HDMI cable first and then try setting the following options (**Lip Sync**, **INSTAPORT™**) to "Off". Your early HDMI source should operate properly with your television. See page 41.
- Supported Audio format: Linear PCM, sampling rate 32/44.1/48kHz.

To connect an HDMI device

Connect an HDMI cable (type A connector) to the HDMI terminal.

For proper operation, it is recommended that you use an HDMI cable with the HDMI Logo (HDMI).

- If your HDMI connection is capable of 1080p and/or your television is capable of refresh rates greater than 50Hz, you will need a Category 2 cable. Conventional HDMI/DVI cable may not work properly with this mode.
- HDMI cable transfers both video and audio. Separate analogue audio cables are not required (see illustration).
- See "HDMI 1 Audio" on page 41.

The HDMI 4 terminal is located on the side of the television.

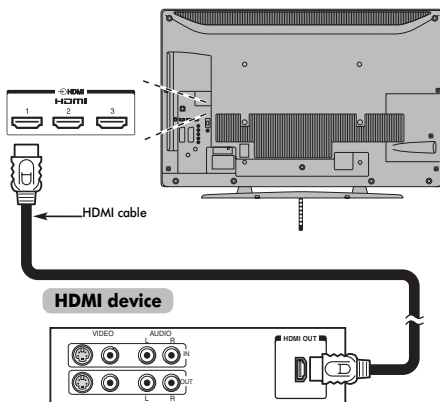

To view the HDMI device video, press the  button to select HDMI 1, HDMI 2, HDMI 3 or HDMI 4 mode.

To connect a DVI device

Connect an HDMI-to-DVI adapter cable (HDMI type A connector) to the HDMI 1 terminal and audio cables to the PC/AUDIO1 (AUDIO) socket (see illustration).

- The recommended HDMI-to-DVI adapter cable length is 6.6 ft (2m).
- An HDMI-to-DVI adapter cable transfers video only. Separate analogue audio cables are required.
- See "HDMI 1 Audio" on page 41.

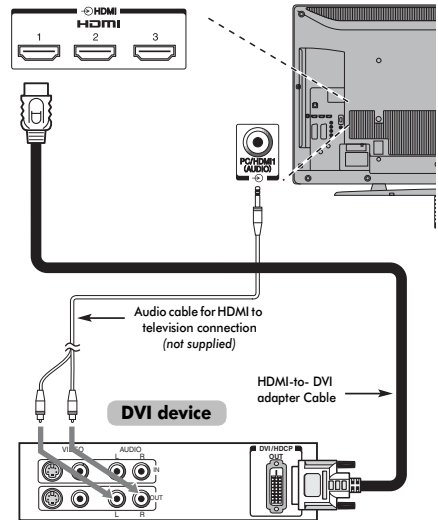

NOTE:

To ensure that the HDMI or DVI device is reset properly, it is recommended that you follow these procedures:

- When turning on your electronic components, turn on the television first, and then the HDMI or DVI device.
- When turning off your electronic components, turn off the HDMI or DVI device first, and then the television.

[1] EIA/CEA-861-D compliance covers the transmission of uncompressed digital video with high-bandwidth digital content protection, which is being standardized for reception of high-definition video signals. Because this is an evolving technology, it is possible that some devices may not operate properly with the television. HDMI, the HDMI logo and High-Definition Multimedia Interface are trademarks or registered trademarks of HDMI Licensing LLC.

Connecting a computer

With either an RGB/PC or an HDMI connection, you can watch your computer's display on the television and hear the sound from the television's speakers.

To connect a PC to the RGB/PC terminal

When connecting a PC to the RGB/PC terminal on the television, use an analogue RGB (15-pin) computer cable and a PC audio cable for the PC/HDMI1 (AUDIO) socket. Select PC from the **PC/HDMI 1 Audio** options in the **AV Connection** menu located in the **SETUP** menu.

the back of your television

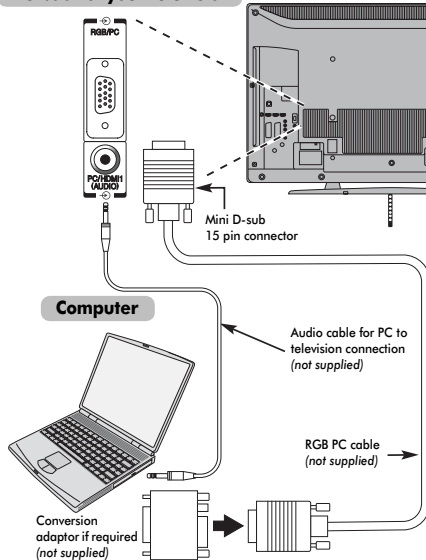

To use a PC, set the monitor output resolution on the PC before connecting it to the television. For acceptable PC signal formats, see page 50.

To display the optimum picture, use the PC setting feature (see page 39).

NOTE:

- The PC audio input terminal on the television is shared with the HDMI 1 analogue audio input terminal (see page 41).
- Some PC models cannot be connected to this television.
- An adapter is not needed for computers with a compatible mini D-sub 15-pin terminal.
- Depending on the DVD's title and the specifications of the PC on which you are playing the DVD-Video, some scenes may be skipped or you may not be able to pause during multi-angle scenes.
- A band may appear at the edges of the screen or parts of the picture may be obscured. This is due to scaling of the picture by the set, it is not a malfunction.

- When PC input mode is selected, some of the television's features will be unavailable e.g. **Manual Settings** in the **SETUP** menu, **Colour**, **Tint**, **Sharpness** and **Black/White Level** in the **PICTURE** menu.
- If connecting a certain PC model with a unique PC signal, the PC signal may not be detected correctly.

To connect a PC to the HDMI terminal

When connecting a PC to the HDMI terminal on the television, use an HDMI-to-DVI adapter cable and an analogue audio cable.

If connecting a PC with an HDMI terminal, use an HDMI cable (type A connector). A separate analogue cable is not necessary (see page 10).

the back of your television

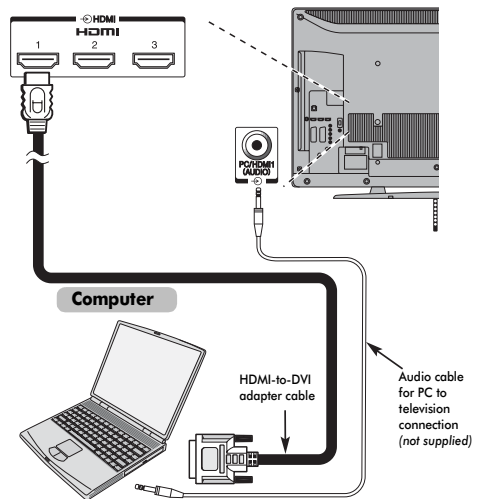

For acceptable PC and video signal formats, see page 51.

NOTE:

- The edges of the images may be hidden.
- If connecting a certain PC model with a unique PC signal, the PC signal may not be detected correctly.

Controls and input connections

A wide variety of external equipment can be connected to the input sockets on the side of the television. Whilst all the necessary adjustments and controls for the television are made using the remote control, the buttons on the television may be used for some functions.

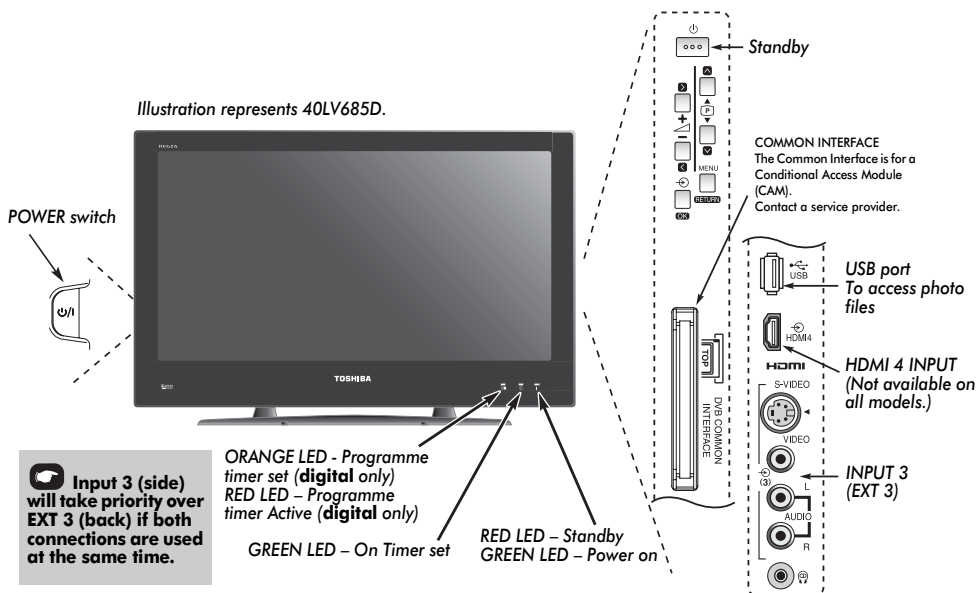

Switching on

If the RED LED is unlit, check that the mains plug is connected to the power supply and press the O/I (POWER) button on the left side of the television to switch the television on. If the picture does not appear, press O on the remote control. It may take a few moments. The GREEN LED will be lit.

To put the television into Standby, press O on the remote control. To view the television, press O again. The picture may take a few seconds to appear.

Using the remote control

Press **MENU** on the remote control to display the menu.

The menu appears as a list of five topics. As each symbol is selected by pressing \blacktriangleleft or \blacktriangleright on the navigation ring on the remote control, its respective options will appear below.

NOTE: The same menu is displayed in DTV (Digital TV) and ATV (Analogue TV) modes; however, some items are greyed out in each case.

To operate the menu, press \blacktriangle and \blacktriangledown on the remote control to move up and down, press \blacktriangleleft or \blacktriangleright to select your desired setting. Follow the on-screen instructions. The functions of each menu are described in detail throughout the manual.

Using the controls and connections

To alter the volume press $-$ \blacktriangle $+$.

To alter the programme position press \blacktriangledown P \blacktriangle .

Press **MENU** and \blacktriangleleft , \blacktriangleright , \wedge or \vee to control the sound and picture options.

Press **MENU** to finish.

An S-Video cable provides better picture performance than a composite video cable. If you connect an S-Video cable to **EXT 3**, be sure to disconnect the standard (composite) video cable or the picture performance will be unacceptable.

To select an external input, press O until the appropriate input source is selected as described on page 40.

Please always refer to the owner's manual of the equipment to be connected for full details.

NOTE: Interactive video games that involve shooting a "gun" at an on-screen target may not work with this TV.

Startup Application

Before switching on the television, put your decoder and media recorder, if applicable, to **Standby**. To set up the television, use the buttons on the remote control as detailed on page 7.

Quick Setup

- 1 Press the **⏻** button. The **Quick Setup** screen will appear. This screen will appear the first time that the television is switched on and each time **Reset TV** is selected.

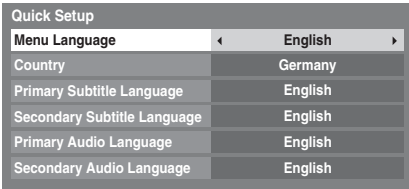

- 2 Highlight **Menu Language** and press **◀** or **▶** to select the menu language.
- 3 Press **▼** to highlight **Country** and **◀** or **▶** to select. The television is now set to tune the stations for your country.

NOTE:

- The following display menus will differ slightly according to the country you selected.
- If there is not a country that you want to select in the list or you want to view DTV programmes but **DTV** is not selectable, select **Others**.

- 4 Press **OK**, and the **Location** screen will appear.

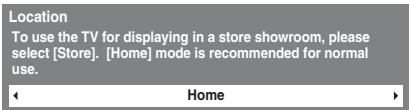

- 5 Press **◀** or **▶** to select **Home** or **Store**. For normal home use, select **Home**.
- 6 Press **OK**. If the **Ant/Cable In** screen appears, press **◀** or **▶** to select **Antenna** or **Cable**.



- 7 Press **OK**, and the **Auto Tuning** start up screen will appear with the option to select between **DTV and ATV, DTV** or **ATV** if available. Use **◀** or **▶** to select the appropriate mode.
- 8 Press **▼** or **▲** to highlight **Start Scan**, and then press **OK**.

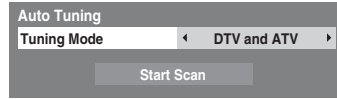

NOTE: If **Cable** is selected in step 6, additional setting options appear in the **Auto Tuning** screen. See the "Ant/Cable In" section on the next page.

The television will start to search for available **DTV** and/or **ATV** channels. The progress bar will indicate the scan status.

You must allow the television to complete the search.

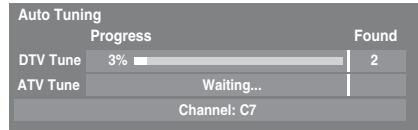

When the search is complete the television will automatically select position one.

The **Auto Tuning** screen will display the total number of services found.

- 9 Press **◀** or **▶** to view the **DTV** (digital channel) or **ATV** (analogue channel) lists.
- 10 Use **▼** or **▲** to move through the list to select a channel, and then press **OK** to view.

In **ATV** mode some areas may receive duplicate stations. There may not be a clear picture or the signal may be weak, so the station order can be changed using **ATV Manual Tuning**.

REMEMBER: Press **ATV/DTV** at any time to select between **ATV** and **DTV** (DTV TV/DTV RADIO/DTV TEXT if available) modes.

NOTE: The time will be set automatically by transmission but can be advanced or decreased by using **Local Time Setting** in the **DTV Settings** screen.

PLEASE NOTE

The **Reset TV** menu can also be accessed at any time from the **SETUP** menu.

Ant/Cable In (if available)

From this menu, you can set the RF input configuration to cable.

- 1 Press **MENU**, and select **SETUP** menu.
- 2 Use **▼** to highlight **Ant/Cable In** and use **◀** or **▶** to select **Antenna** or **Cable**.

NOTE: When you attempt to change the **Ant/Cable In** setting, a warning message will appear followed by PIN entry (if PIN has been set) and a prompt for **Auto Tuning**.

- 3 When **Ant/Cable In** is set to **Cable**, the following setting options will be provided in the **Auto Tuning** screen.

Press **▲** or **▼** to select an item, and then press **◀** or **▶** to select your desired option.

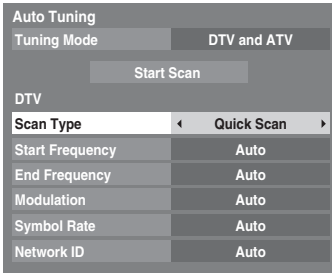

With the exception of **DTV Scan Type** and **DTV Modulation** items, all of the following items will have 2 operating modes. The first is **Auto** where the values for each item are preset by the system. The second is an **Input** mode where you will be able to enter a single value in place of the pre-set value. If no channel is currently tuned and the **Input** state is chosen, a system default value will be shown. However, if a channel is currently tuned when the item is accessed, the value of the current channel will be displayed.

DTV Scan Type:

This item determines whether a **Quick Scan** or a **Full Scan** will be executed.

The **Quick Scan** is a simplified version of the **Full Scan** that is designed to complete in less time.

DTV Start Frequency:

This sets the frequency from which the scan will begin.

DTV End Frequency:

This sets the frequency at which the scan will end.

* Valid entry range for frequency items is 113.000-858.00 for C-Book/Other and 114.000-858.00 for Nordig-C. If numbers outside of this range are entered, the values will automatically be set to the min. or max. valid value as appropriate.

DTV Modulation:

You can choose from five QAM modulation settings.

DTV Symbol Rate:

This is the baud rate (KS/s) of the scan.

* Valid entry range for Symbol Rate is 4000-7200. If a number outside of this range is entered, the value will be automatically set to the min. or max. valid value as appropriate.

DTV Network ID:

This is the Network ID to be utilized for the scan. This item is greyed out when DTV Scan Type is set to "Full Scan".

* Valid entry range for Network ID is 1-65535. If a number outside of this range is entered, the value will be automatically set to the min. or max. valid value as appropriate.

Auto Tuning

NOTE: As new services are broadcast, it will be necessary to re-tune the television in order to view them.

Auto Tuning will completely re-tune the television and can be used to up date the channel list. **It is recommended that Auto Tuning is run periodically to ensure that all new services are added.** All current channels and settings, e.g. locked channels, will be lost.

- 1 Press **MENU** and use ◀ or ▶ to select **SETUP** menu. Use ▼ to highlight **Auto Tuning**. Press **OK**.

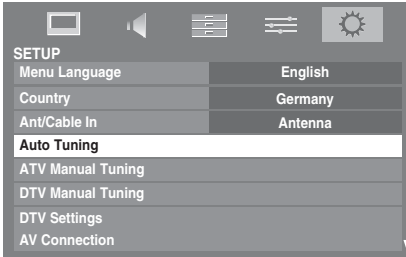

- 2 A screen will appear warning that previous programmes and settings will be deleted.

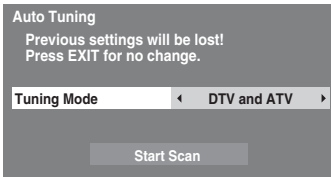

Use ◀ or ▶ to select **DTV** and **ATV**, **DTV** or **ATV**, if available, then highlight **Start Scan** and press **OK** to continue with the **Auto Tuning**.

NOTE: If you have selected "Others" for the **Country** field in the **SETUP** menu, and select a tuning mode other than "**DTV**", choose the optimum ATV broadcasting system (B/G, I, D/K or L).

The television will start to search for all available DTV and/or ATV services.

You must allow the television to complete the search.

When the search is complete, the **Auto Tuning** screen will display the services found.

- 3 Use ▼ or ▲ to move through the list to select a channel, and then press **OK** to view.

ATV Manual Tuning

Tuning

The television can be tuned-in manually using **ATV Manual Tuning**. For example, you might use the feature if the television cannot be connected to a media recorder/decoder with a SCART lead or when you want to tune-in a station on another **System**.

Use ◀ and ▶ to move across the screen and select any of the **ATV Manual Tuning** options. Then use ▲ or ▼ to adjust the settings.

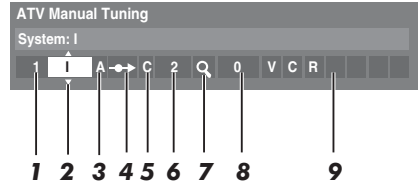

- 1 **Position:**
The number to be pressed on the remote control to tune the channel.
 - 2 **System:**
Specific to certain areas.
 - 3 **Colour System:**
Factory set to Auto, should only be changed if problems are experienced, e.g. NTSC input from an external source.
 - 4 **Skip:**
Set Skip to On (☞) or Off (☜) for the selected channel. See page 17.
 - 5 **Signal Class:**
The channel classification.
 - 6 **Channel:**
The channel number on which a station is being broadcast.
 - 7 **Search:**
Search up and down for a signal.
 - 8 **Manual Fine Tuning:**
Only used if interference/weak signal is experienced. See page 45.
 - 9 **Station:**
Station identification. Use the ▲ or ▼ and ◀ or ▶ buttons to enter up to seven characters.
- To allocate a position on the television for a decoder and media recorder: turn the decoder on, insert a pre-recorded film in the media recorder, press **PLAY**, and then manually tune.

- 1 Press **MENU** and using **◀** or **▶** select the **SETUP** menu. With **▼** highlight **ATV Manual Tuning** and press **OK** to select.

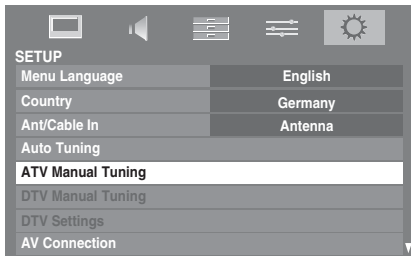

- 2 Use **▲** or **▼** to highlight the desired position. We suggest **Pos. 0** for a media recorder.

Pos.	Channel	Station
1	C2	
2	S10	
3	C7	
4	S40	
5	C22	
6	C25	
7	C28	
8	C30	

Different **Channel** numbers may be displayed.

- 3 Press **OK** to select. If the channel chosen for the media recorder is set to skip, Skip should be removed before storing.

- 4 Press **▶** to select **System** and use **▲** or **▼** to change if required.



- 5 Then press **▶** to select **Search**.

- 6 Press **▲** or **▼** to begin the search. The search symbol will flash.



- 7 Each signal will be shown on the television, if it is not your media recorder, press **▲** or **▼** again to restart the search.

- 8 When your media recorder signal is found, press **▶** to move along to **Station**. With **▲**, **▼**, **◀** and **▶** put in the required characters, e.g. **VCR**.



- 9 Press **OK** to save.

- 10 Repeat for each **position** you want to tune or, press **MENU** to return to the list of channels and select the next number to tune.

- 11 Press **EXIT** when you have finished.

- 12 To name external equipment, e.g. DVD on EXT 2, press **↻** to select **↻2**, then select **Manual Settings** from the **SETUP** menu.

- 13 Press **▶** to select **Label** then using **▲**, **▼**, **◀** and **▶** put in the required characters, and then press **OK**.



PLEASE NOTE

This television has direct channel entry if the channel numbers are known. Select the **ATV Manual Tuning** screen in **Step 3**. Enter the **Position number**, the **System**, then **C** for standard (terrestrial) channels or **S** for cable channels and the **Channel number**. Press **OK** to save.

Skip

To prevent certain channels from being viewed, positions can be skipped.

- 1 Select **ATV Manual Tuning** from the **SETUP** menu.
- 2 Use ▲ or ▼ to highlight the position to be skipped and press **OK** to select.

ATV Manual Tuning		
Pos.	Channel	Station
1	C2	
2	S10	
3	C7	
4	S40	ABC1
5	C22	ABC1
6	C25	
7	C28	
8	C30	

- 3 Press **▶** to select **Skip**.
- 4 Use ▲ or ▼ to turn **Skip** on.
Press **OK**.

↻ on the screen indicates a skipped position.

ATV Manual Tuning		
Skip: On		
1	I A	↻ C 2 Q 0

- 5 Press **RETURN** and repeat from **Step 2** or press **EXIT**.

Each position has to be *individually* selected. To turn **Skip** off, repeat the procedure for each position.

Skipped positions **cannot** be selected by **P▲** and **P▼** or by the controls on the television, but **can** still be accessed by the number buttons on the remote control.

Sorting positions

Channels may be moved and saved to the position of your choice.

- 1 Select **ATV Manual Tuning** from the **SETUP** menu.
- 2 With the list of channels showing, use ▲ or ▼ to highlight the channel you want to move and press **▶**.

ATV Manual Tuning		
Pos.	Channel	Station
2	S10	
3	C7	
4	C40	ABC1
5	C22	ABC1
1	C2	
6	C25	
7	C28	
8	C30	

- 3 Use ▲ or ▼ to move through the list to your preferred position. As you do so, the other channels will move to make room.
- 4 Press **◀** to save your move.
Repeat as necessary, and then press **EXIT**.

DTV Manual Tuning

NOTE: This feature varies depending on the **Ant/Cable In** setting.

Manual Tuning

This feature is available for service engineers or can be used for direct channel entry if the multiplex channel is known.

- 1 Select **DTV Manual Tuning** from the **SETUP** menu and press **OK**.

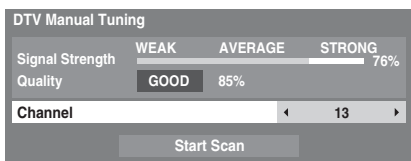

- 2 Enter the multiplex number using the number buttons or use **◀** or **▶** to adjust the number up or down.
- 3 Highlight **Start Scan**, and then press **OK**. The television will automatically search for that multiplex.

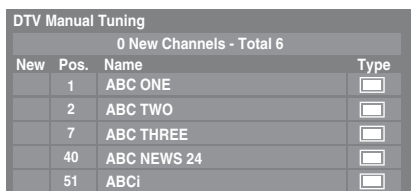

When the multiplex is found any channels that are not currently in the channel list will be added and the channel information at the top of the screen will be updated.

- 4 Repeat as necessary. Press **EXIT** to finish.

Manual Tuning for DVB-C

When **Ant/Cable In** is set to **Cable**, **DTV Manual Tuning** items are as follows:

Frequency – input a specific frequency to be scanned

Modulation – choose from one of five QAM modulation options

Symbol Rate – input a specific baud rate (KS/s) to be used for the manual scan

DTV Settings

Channels

The channel order may be changed to suit your personal preference.

- 1 Select **DTV Settings** from the **SETUP** menu and press **OK**.
- 2 Select **Channels** and press **OK**.

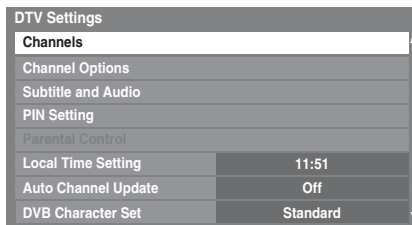

- 3 With the list of channels showing use **▼** or **▲** to highlight the channel you want to move and press **▶**.

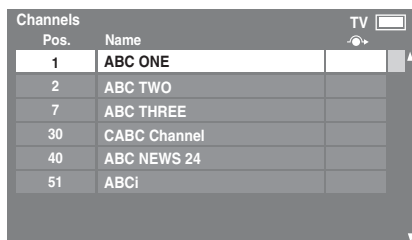

- 4 Use **▼** or **▲** to move through the list to your preferred position. As you do so, the other channels will move to make room.
- 5 Press **◀** to save your move. Repeat as necessary, then press **EXIT**.

To renumber the highlighted channel, press the **RED** button on the remote control.

Edit the channel number using the number buttons and press **OK**.

Pos.	Name	TV
1	ABC ONE	
2	ABC TWO	
7	ABC THREE	
30	CABC Channel	
40	ABC NEWS 24	
5	ABCi	

Auto Channel Update

If the **Auto Channel Update** is set to **On**, when the TV is in standby mode, digital tuning is automatically executed and any new channels are saved.

- 1 Select **DTV Settings** from the **SETUP** menu and press **OK**.
- 2 Press **▼** to select **Auto Channel Update** and use **◀** or **▶** to select **On**.

DVB Character Set

This feature allows you to manually set the character set (**Standard** = Table 0, **West** = Table 5 or **Latin alphabet 9**) to be used for DVB-C or DVB-T channels.

- 1 Select **DTV Settings** from the **SETUP** menu and press **OK**.
- 2 Press **▼** to select **DVB Character Set** and use **◀** or **▶** to select **Standard**, **West** or **Latin alphabet 9**.

Dynamic Scan

If the broadcast information has changed in your DVB-T receiving area, the TV screen will display the message "**Broadcast information has changed. Would you like to rescan now?**" Please follow the message.

- 1 Select **DTV Settings** from the **SETUP** menu and press **OK**.
- 2 Press **▼** to select **Dynamic Scan** and use **◀** or **▶** to select **On**.

Location setting

You can select either **Home** or **Store** mode. **Home** is recommended for normal home use. Select **Store** when displaying the television in a shop, etc.

- 1 Select **Location** from the **SETUP** menu.
- 2 Press **◀** or **▶** to select **Home** or **Store**.

Analogue switch-off

This is a **digital** television which is integrated to allow the use of both **digital** and **analogue** services. However, during the lifetime of this set it is very likely that **analogue** services will be switched off to allow for more new **digital** services.

This 'switch-off' will happen in a number of phases, which will be advertised in your area well in advance. It is recommended that at each phase the television is re-tuned to ensure that existing and new **digital** services can be viewed without disruption.

General controls

Selecting positions

To select a position, use the numbered buttons on the remote control.

Positions can also be selected using **P** and **P**.

To display on-screen information such as position, input mode or stereo/mono signal, press **i+**. Press again to cancel.

The Time Display – analogue only

The time display facility allows the current (text service) time to be seen on the television screen.

Press **⏻**/**⏻** whilst watching a normal television broadcast to see the time display from the broadcaster. It will remain on screen for about 5 seconds.

NOTE: This display may not be available in some cases.

Stereo and Bilingual transmissions

For ATV programmes

If stereo or dual language broadcasts are transmitted, the word **Stereo** or **Dual** will appear on the screen each time positions are changed, disappearing after a few seconds. If the broadcast is not in stereo, the word **Mono** will appear.

Stereo... Press **⏻**/**⏻** to select **Stereo** or **Mono**.

Bilingual... Bilingual transmissions are rare. If they are transmitted, the word **Dual** will be displayed. Choose the required programme number and if the word **Dual** appears press **⏻**/**⏻** to select **Dual 1**, **Dual 2** or **Mono**.

For DTV programmes

For stereo or dual mono broadcasts, press **⏻**/**⏻** and use **◀** or **▶** to select settings.

Mode Display	Pressing ▶
⊖ Stereo	Stereo → Left → Right
●⊖ Dual mono	Dual 1 → Dual 2 → Dual
⊖ Mono	–
⊖ Multichannel	–

For multi-audio track broadcasts, press **⏻**/**⏻** repeatedly to change the audio language (see 'Audio language' on page 37).

Quick Menu

Quick Menu helps you access some options quickly, such as **Picture Mode**, **Picture Size**, **More Information**, **Sleep Timer** etc.

Press **QUICK** to display the **Quick Menu** and use **▲** or **▼** to select the option.

Quick Menu	
Picture Mode	AutoView
Picture Size	Super Live
More Information	
Sleep Timer	00:00
Media Player	
Headphone Level	0 ———
System Information	

NOTE: **Quick Menu** items are different depending on the current mode.

Mode	Quick menu item	Description
When viewing a TV programme or pictures from the external input	Picture Mode	See page 25.
	Picture Size	See page 23.
	Channels	See page 37.
	More Information	See page 35.
	Sleep Timer	See page 33.
	Media Player	See page 30.
	Headphone Level	See page 22.
When using EPG	System Information	See page 39.
	Genre Colour	See page 35.
	EPG Update/ Cancel EPG Update	See page 35.
When using Media Player	Picture Size	See page 23.
	Interval Time	See page 31.
	Repeat	See page 31.

Sound controls

Volume controls and mute sound

Volume

Press or to adjust the volume.

Sound Mute

Press once to turn the sound off and again to cancel.

Dual

If a programme or film is being broadcast with a soundtrack in more than one language, the **DUAL** feature allows selection between them.

- 1 Press **MENU** and or to select **SOUND**.
- 2 Use to highlight **Dual**, and then press or to choose between **Dual 1** or **Dual 2**.

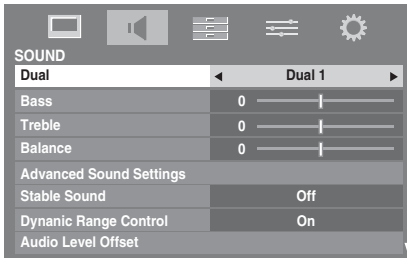

Bass, Treble and Balance

The sound controls are accessible in **digital and analogue** modes.

- 1 Select the **SOUND** menu.
- 2 Press to highlight **Bass**, **Treble** or **Balance** and or to change the setting.

Advanced Sound Settings

Stereo Extension, **Voice Enhancement**, and **Dynamic Bass Boost** help to create an enhanced surround sound experience with deep, rich bass from stereo sound sources. Your TV's audio will sound fuller, richer, and wider.

- 1 In the **SOUND** menu, press to highlight **Advanced Sound Settings**, and then press .
- 2 Press to highlight **Stereo Extension**, and then press or to select **On** or **Off**.

Advanced Sound Settings	
Stereo Extension	◀ Off ▶
Voice Enhancement	On
Dynamic Bass Boost	High

- 3 Press to highlight **Voice Enhancement** then press or to select **On**.
- 4 Press to highlight **Dynamic Bass Boost** and using or select the desired bass expansion level (**Off**, **Low** or **High**).

Stable Sound® (LV series only)

The **Stable Sound** feature limits high volume levels in order to prevent the extreme changes in volume that can occur when channels are changed or a programme switches to a commercial.

- 1 Select the **SOUND** menu.
- 2 Use to highlight **Stable Sound**, and then press or to select **On** or **Off**.

Dolby Volume® (RV series only)

This feature provides a consistent sound volume regardless of programmes, channels or input sources.

- 1 In the **SOUND** menu, press to highlight **Dolby Volume**.
- 2 Press or to select **Low**, **High** or **Off**.

NOTE:

- The **Dolby Volume** setting influences the **Dynamic Range Control** and **Digital Audio Output** settings.
- If **Dynamic Range Control** is set to **On**, this feature will be disabled.

Dynamic Range Control

This feature allows control of audio compression for some digital TV programmes. (MPEG-1 and MPEG-2 audio programmes are not supported.)

- 1 In the **SOUND** menu, press to highlight **Dynamic Range Control**.
- 2 Press or to select **On** or **Off**.

NOTE:

- For LV series:
If the **Stable Sound** and **Dynamic Range Control** features are both set to **On**, each effect may not be noticeable.
- For RV series:
This feature is disabled when **Dolby Volume** is set to **Low** or **High**.

Audio Level Offset

Sometimes there can be large changes in volume when switching from a DTV 5.1ch to a DTV 2ch, an ATV channel, or an external input. Using the **Audio Level Offset** feature reduces these volume differences.

- 1 Set the volume level usually used when watching a DTV 5.1ch programme.
- 2 Tune to a channel which is DTV 2ch or ATV, or an external input.
- 3 In the **SOUND** menu, press ▼ to highlight **Audio Level Offset** and press **OK**.
- 4 Press ▼ to highlight an option, then use ◀ or ▶ to adjust the volume level.

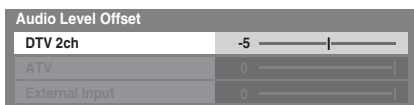

NOTE:

- The available item differs depending on the current input source. For example, while watching a DTV 2ch programme, only **DTV 2ch** is available and the other two items are greyed out in the menu. This allows you to easily adjust each item according to each condition.
- When watching a DTV 5.1ch programme, this feature is not available.

Headphone Settings

This setting is used to set the sound output when headphones are connected.

Speaker Link	Headphone	Speakers
On	Sound is output (◀ - + is available.)	No sound
Off	Sound is output (Headphone level menu is available.)	Sound is output (◀ - + is available.)

- 1 In the **SOUND** menu, press ▼ to highlight **Headphone Settings**, and then press **OK**.
- 2 Press ▼ to highlight **Speaker Link** and use ◀ or ▶ to select **On** or **Off**.
- 3 If you select **Off**, then highlight **Headphone Level** and use ◀ or ▶ to adjust the headphone sound.

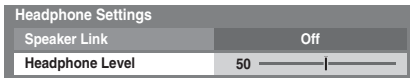

Audio description

Audio description is an additional narrative sound track for visually impaired individuals that allows the story line to be understood and enjoyed more fully. If this function has been activated by pressing the **AD** key, the letters **AD** will be displayed in the channel banner when programmes contain AD content. You can choose to hear sound from the TV speakers and the headphone output or only from the headphone output.

- 1 From the **SOUND** menu select **Audio Description** and press **OK**.
- 2 Highlight **Audio Description**, and then press ◀ or ▶ to select **On**.

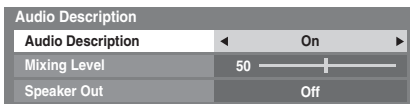

- 3 To adjust the level of the audio description sound to the main sound, highlight **Mixing Level** and use ◀ or ▶.
- 4 Highlight **Speaker Out**, and then press ◀ or ▶ to select **On** or **Off**.

On: sound from both the headphone output and speakers.

Off: sound from the headphone output.

See "Headphone Settings" to adjust the headphone sound.

Widescreen viewing

Depending on the type of broadcast being transmitted, programmes can be viewed in a number of formats.

WIDE

Use this setting when watching a widescreen DVD, widescreen video tape or a 16:9 broadcast (when available). Due to the range of widescreen formats (16:9, 14:9, 20:9 etc.) black bars may be visible on the top and bottom of the screen.

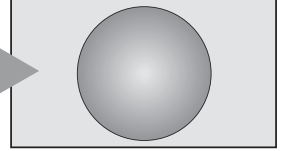

4:3

Use this setting to view a true 4:3 broadcast.

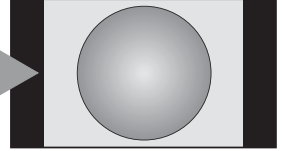

SUPER LIVE

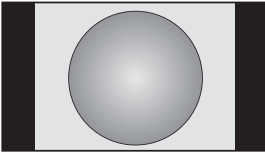

This setting will enlarge a 4:3 image to fit the screen by stretching the image horizontally and vertically, holding better proportions at the centre of the image. Some distortion may occur.

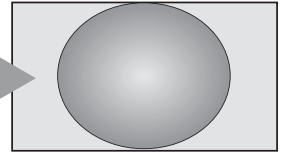

CINEMA

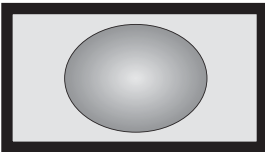

When watching 'all sides panel format' films/video tapes, this setting will eliminate or reduce the black bars at all sides of the screen by zooming in and selecting the image without distortion.

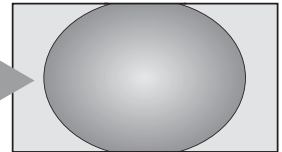

SUBTITLE

When subtitles are included on a letterbox format broadcast, this setting will raise the picture to ensure that all of the text is displayed.

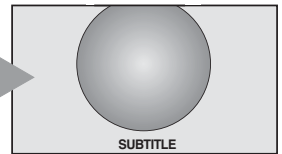

14:9

Use this setting when watching a 14:9 broadcast.

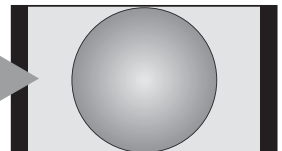

NATIVE

This setting will show the picture without over scan, i.e. WYSIWYG. This option is only available when in the HDMI input mode.

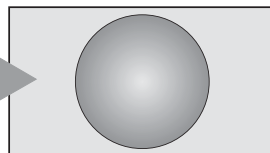

PC NORMAL

This setting will show the picture without over scan, i.e. WYSIWYG. This option is only available when watching a PC signal source via HDMI or PC terminal.

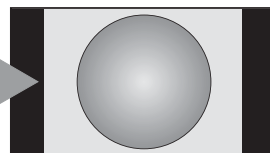

PC WIDE

This setting will show the picture without over scan and side panels. This option is only available when watching a PC signal source via HDMI or PC terminal.

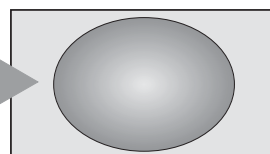

Dot by Dot

“Dot by Dot” is a non-scaling display. Depending on the input signal format, the picture is displayed with side panels and/or bars at the top and bottom (e.g. VGA input source).

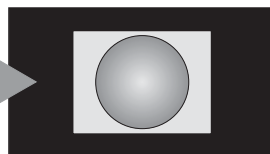

Press **QUICK** and highlight **Picture Size**, then press **OK** to display the list of available widescreen formats. Use **▲** and **▼** to highlight the required format and press **OK** to select.

AV format

Picture Size
Wide
Super Live
Cinema
4:3
Subtitle
14:9
Native

PC format

Picture Size
PC Normal
PC Wide
Dot by Dot

Using the special functions to change the size of the displayed image (i.e. changing the height/width ratio) for the purposes of public display or commercial gain may infringe on copyright laws.

Picture controls

Most of the picture controls and functions are available in both **digital** and **analogue** modes.
PLEASE NOTE: features not available will be greyed out.

Picture Position

The picture position may be adjusted to suit personal preference and can be particularly useful for external inputs.

- 1 In the **SETUP** menu press **▼** until **Picture Position** is highlighted.

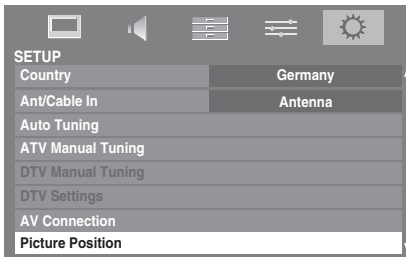

- 2 Press **OK** to view the options available for the picture format that has been selected.

- 3 Press **▲** and **▼** to select an option, then **◀** or **▶** to adjust the settings.

The options differ depending on the currently selected widescreen format and the input signal.

In **Cinema**:

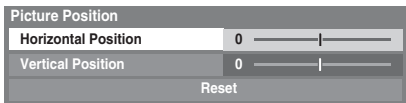

To return to the original factory settings select **Reset** in the **Picture Position** menu and press **OK**.

Picture Mode

This television offers the choice of personalising the picture style.

AutoView, **Dynamic**, **Standard**, **Movie**, **Store**, **Game** and **PC** are preset options and affect many features/settings within the television.

NOTE:

- Because the **AutoView** mode automatically adjusts picture settings based on ambient light conditions and input signal content, the **Auto Brightness Sensor** and **Expert Mode** menus are greyed out when it is selected.
- **Store** mode is only available when **Location** is set to **Store**.
- **Game** mode is available in external input mode (other than aerial input). When you select **Game** mode, suitable widescreen formats will be selected.
- **PC** mode is available in RGB/PC input mode or HDMI input mode.

- 1 In the **PICTURE** menu press **▼** to select **Picture Mode**.

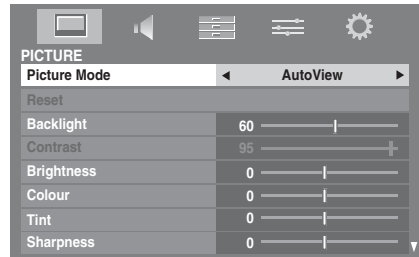

- 2 Press **◀** or **▶** to select the picture mode you prefer and press **OK**.

NOTE: The picture mode you select affects the current input only. You can select a different picture mode for each input.

Picture preferences

You can customise current picture mode settings as desired. For example, while selecting "**Dynamic**," if you change the following items, such as **Backlight**, **Contrast**, **Brightness**, **Colour**, **Tint**, **Sharpness** and the **Advanced Picture Settings** items, your new settings are saved for "**Dynamic**" picture mode.

- 1 In the **PICTURE** menu press **▼** to select either **Backlight**, **Contrast**, **Brightness**, **Colour**, **Tint** or **Sharpness** and press **OK**.

- 2 Press **◀** or **▶** to adjust the settings.

Reset

This feature resets all picture settings to the factory settings except **Picture Mode**.

NOTE: If any picture settings have not been changed, **Reset** is not available.

- 1 In the **PICTURE** menu press ▼ to select **Reset** and press **OK**.
- 2 A confirmation message will appear. Press ◀ or ▶ to select **Yes** and press **OK**.

3D Colour Management

When **3D Colour Management** is set to **On** it allows the 'Base Colour Adjustment' feature to become available.

- 1 In the **PICTURE** menu press ▼ to select **Advanced Picture Settings** and press **OK**.
- 2 Press ▼ to select **3D Colour Management**.

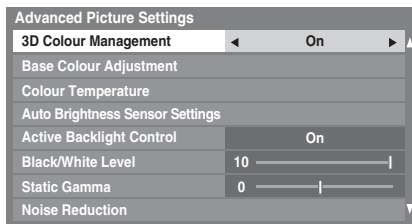

- 3 Press ◀ or ▶ to select **On** or **Off**, and then press **OK**.

Base Colour Adjustment

The **Base Colour Adjustment** feature allows the adjustment of individual colours to suit personal preference. This can be useful when using an external source.

- 1 In the **Advanced Picture Settings** menu press ▼ to select **Base Colour Adjustment**, and then press **OK**.
- 2 Press ▲ or ▼ to select an option, then press ▶ to move to the adjustment window.

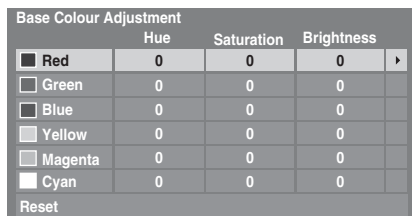

- 3 Press ◀ or ▶ to select **Hue**, **Saturation** or **Brightness**, and then press ▲ or ▼ to adjust the settings as required.

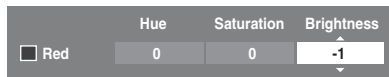

- 4 Press **OK** to return to the previous menu.
To return to the factory settings, select **Reset** and press **OK**.

Colour Temperature

Colour Temperature increases the 'warmth' or 'coolness' of the picture by increasing the red or blue tint.

- 1 In the **Advanced Picture Settings** menu press ▼ to select **Colour Temperature** and press **OK**.
- 2 Press ◀ or ▶ to select the **Colour Temperature** setting (0 (warm) – 10 (cool)).

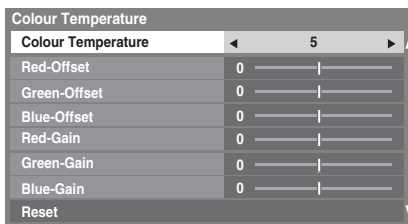

- 3 Press ▲ or ▼ to select the option you want to adjust, and then press ◀ or ▶ to adjust the settings.
- 4 Press **OK** to return to the previous menu.

To return the Colour Temperature settings to the factory defaults, select **Reset** and press **OK**.

NOTE: If **Picture Mode** is set to **AutoView**, you can adjust **Colour Temperature** only, and the range will be -5 to +5.

Auto Brightness Sensor Settings

When the **Auto Brightness Sensor** is activated, it will automatically optimise the backlighting levels to suit ambient light conditions.

- 1 In the **Advanced Picture Settings** menu press ▼ to select **Auto Brightness Sensor Settings** and press **OK**.
- 2 Press ◀ or ▶ to select **On** and press **OK**.

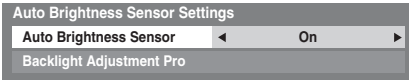

- 3 Press ▼ to select **Backlight Adjustment Pro** and press **OK**.
- 4 The **Backlight Adjustment Pro** window will appear. Press **OK** again to display the adjustment window.
- 5 Press ◀ or ▶ to select a point and press ▲ or ▼ to adjust the level.

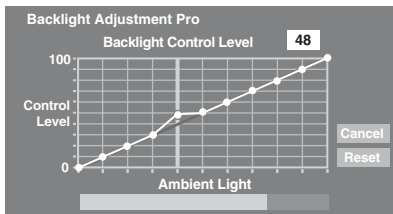

- 6 Press **OK** to fix the adjustment.
To cancel the adjustment when selecting a point, select **Cancel** and press **OK**.
To return the adjustments of all points to the factory defaults, select **Reset** and press **OK**.

Active Backlight Control

When **Active Backlight Control** is activated, it will automatically optimise the backlighting levels for dark scenes.

- 1 In the **Advanced Picture Settings** menu press ▼ to select **Active Backlight Control**.
- 2 Press ◀ or ▶ to select **On** or **Off**.

Black/White Level

Black/White Level increases the strength of dark areas of the picture to improve the definition.

- 1 In the **Advanced Picture Settings** menu press ▼ to select **Black/White Level**.
- 2 Press ◀ or ▶ to adjust the level. The effect depends on the broadcast and is most noticeable on dark colours.

Static Gamma

The **static gamma** feature allows you to adjust the levels of black in the picture.

- 1 In the **Advanced Picture Settings** menu press ▼ to select **Static Gamma**.
- 2 Press ◀ or ▶ to adjust the level.

MPEG NR – Noise Reduction

When watching a DVD, the compression may cause some words or picture elements to become distorted or pixelated. Using the **MPEG NR** feature reduces this effect by smoothing out the edges.

- 1 In the **Advanced Picture Settings** menu press ▼ to select **Noise Reduction** and press **OK**.
- 2 Press ▼ to select **MPEG NR**.



- 3 Press ◀ or ▶ to select **Low**, **Middle**, **High** or **Off** to suit your preference.

DNR – Digital Noise Reduction

DNR allows you to 'soften' the screen representation of a weak signal to reduce the noise effect.

- 1 Select **DNR** from the **Noise Reduction** menu.
- 2 Use ◀ or ▶ to select **Low**, **Middle**, **High**, **Auto** or **Off**. The differences may not always be noticeable (for the best result use lower settings as picture quality can be lost if the setting is too high).

Resolution+

The **Resolution+** feature allows you to adjust the clarity levels for your desired picture settings.

- 1 In the **Advanced Picture Settings** menu, press ▼ to select **Resolution+** and press **OK**.
- 2 In the **Resolution+** field, select **On**.



- 3 Press ▼ to highlight **Level**, then press ◀ or ▶ to adjust the level.

NOTE:

- This feature may not work properly depending on the content.
- Adjustable range varies according to the Picture Mode you set.
- Noise may appear in the picture depending on the device connected to the TV (e.g. a device with a specific enhancer function).

Cinema Mode

If there are lines or jagged edges in the film or programme being viewed, selecting **Cinema Mode** can help correct this by smoothing out the picture.

- 1 In the **Advanced Picture Settings** menu press ▼ to select **Cinema Mode**.
- 2 Press ◀ or ▶ to select **On** or **Off**.

NOTE: When a DVD with subtitles is being played this mode may not work correctly.

Expert Mode

This feature allows you to turn the colours red, green, and blue On/Off individually in order to adjust each colour more accurately.

NOTE: This feature is not available when **Picture Mode** is set to **AutoView**.

- 1 In the **Advanced Picture Settings** menu press ▼ to select **Expert Mode** and press **OK**.
- 2 Press ▲ or ▼ to select either **Red**, **Green** or **Blue** and press ◀ or ▶ to select **On**.
Select **Off** for the other two colours.

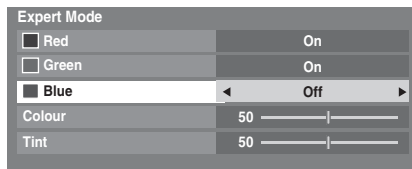

- 3 Press ▼ to select **Colour** or **Tint**, and then press ◀ or ▶ to adjust.

Resetting the advanced picture settings

This feature allows you to reset the current **Advanced Picture Settings** to the default values.

- 1 In the **Advanced Picture Settings** menu press ▼ to select **Reset**.
- 2 Press **OK**.

Control Visualization

This feature displays the brightness histogram and control curve of each scene.

- 1 In the **PICTURE** menu, press ▼ to select **Control Visualization** and press **OK**. The histogram window will appear.

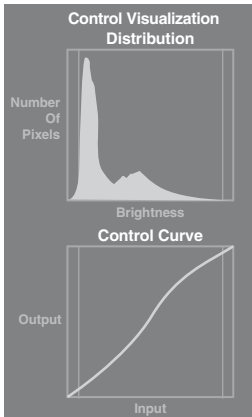

- 2 Press **RETURN** to return to the previous menu.

Automatic Format (Widescreen)

When this television receives a true Widescreen picture and **Auto format** is **On**, it will automatically be displayed in Widescreen format irrespective of the television's previous setting.

- 1 Press **MENU** and ◀ or ▶ to select the **PREFERENCES** menu.
- 2 Press ▼ to highlight **Auto Format**, then ◀ or ▶ to select **On** or **Off**.

PREFERENCES	
Teletext	Auto
Panel Lock	Off
Auto Format	◀ On ▶
4:3 Stretch	Off
Blue Screen	On
Side Panel	1
HDMI Information Display	Off

4:3 Stretch

When **4:3 Stretch** is activated the size switching system changes 4:3 programmes into full screen picture.

- 1 In the **PREFERENCES** menu press ▼ to highlight **4:3 Stretch**.
- 2 Press ◀ or ▶ to select **On** or **Off**.

Blue Screen

When **Blue Screen** is selected the screen will turn blue and the sound will be muted on analogue channels and external input modes when no signal is received.

- 1 In the **PREFERENCES** menu press ▼ to highlight **Blue Screen**.
- 2 Press ◀ or ▶ to select **On** or **Off**.

Side panel adjustment

The **Side Panel** feature lightens or darkens the band on each side of the screen when in 4:3 or 14:9 format. This helps prevent image retention of the band and can also make viewing in bright or dark conditions more comfortable.

- 1 In the **PREFERENCES** menu, press ▼ to select **Side Panel**.
- 2 Press ◀ or ▶ to adjust (1-3).

Picture still

This feature is used to hold a still image on the screen.

Press **STOP** to hold an image on the screen, press **STOP** again to cancel.

HDMI Information Display

When the **HDMI Information Display** feature is **On** and you are watching a HDMI input source, pressing the **INFO** button displays the HDMI signal information banner.

- 1 In the **PREFERENCES** menu, press ▼ to select **HDMI Information Display**.
- 2 Press ◀ or ▶ to select **On**.

HDMI signal information is as follows:
Resolution, Scan Type, Frame Rate, Aspect, Colour Depth, Colour Space, RGB/YUV, Chroma Format

Enjoying Photos through the USB port

The Photo Viewer allows you to playback JPEG files from a USB storage device. Entire files can be viewed individually in a Single View or Slideshow mode, or as thumbnails in a Multi View overview mode.

Photo Viewer specifications

Data type: JPEG Exif ver2.2

File format: DCF ver1.1

Maximum photo size: 9 MB

Maximum number of files: 2000 / Folder

Maximum photo resolution: 16384 X 16384 pixels

PLEASE NOTE

- Gently insert the USB device into the port and do not remove while viewing Media Player.
- USB device: USB Mass Storage Class device (MSC)
- Connectivity is not guaranteed for all devices.
- Connect the USB device to the TV directly.
- Do not use a USB hub.
- You must obtain any required permission from copyright owners to use copyright content. Toshiba cannot and does not grant such permission.

To select the Auto Start function

- 1 Press **MENU** and ◀ or ▶ to select the **APPLICATIONS** menu.
- 2 Press ▼ to select **Media Player**, and then press **OK**.
- 3 Press ▼ or ▲ to select **Auto Start**.
- 4 Press ◀ or ▶ to select **On** or **Off**.

See the **Media Player** menu at right.

To open Photo Viewer

There are two kinds of methods to open Photo Viewer.

Automatically open

- 1 Gently insert a supported USB storage device to the USB port on the side of the TV. A prompt will appear.

NOTE: If you repeatedly insert and remove the USB connector, the prompt may not appear.

- 2 Press ◀ or ▶ to select **Yes**, then press **OK**. The **Media Player** menu will appear. When you select **No**, nothing happens.

USB device was connected to TV. Do you want to open Media Player?

No Yes

NOTE: The prompt will disappear after about 6 sec.

Manually open

- 1 Press **MENU** and ◀ or ▶ to select the **APPLICATIONS** menu.
- 2 Press ▼ to select **Media Player**, and then press **OK**.
- 3 Press ▼ or ▲ to select **Photo** then press **OK**.

Media Player

Photo

Auto Start

On

- 4 Press ▼ or ▲ to select a device if the selection window appears, and then press **OK**. The Photo Viewer will open.

NOTE:

- The viewer will also open even if there are no photo files.
- While the **Media Player** is active, the main menus cannot be displayed.

Viewing photo files

There are three types of view modes.

Multi View

This view allows you to search for photos in a grid format. These pictures are displayed using thumbnail data in each image file.

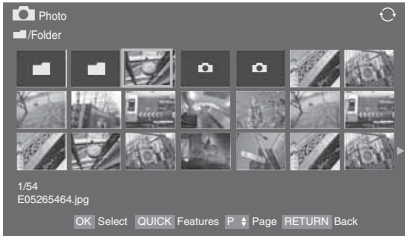

The initial highlighted position will be on the top left thumbnail in the Multi view.

- 1 Press **▲▼◀▶** to move the highlight in one window. If all of the photos will not fit in one screen, when pressing **◀** at the top left thumbnail, the screen will move to the previous page. Conversely, when pressing **▶** at the bottom right thumbnail, the screen will move to the next page.

P▲ P▼ buttons can be used to page up/down the photo list when there are more photos than will fit onto one screen. When the **P▲ P▼** buttons are pressed, the highlight shall be on the photo at the top left of Previous/Next list.

- 2 When you select a folder, press **OK** to move to next layer. Press **RETURN** to move back to previous layer.
- 3 Press **OK** to view the selected photo in Single View mode.

Single View

In this view mode, only files located in the selected directory shall be displayed. This view allows you to change the photo content manually. When moving from Multi View to Single View, the currently selected photo shall be displayed.

- 1 Press **▶** to view the next photo. Press **◀** to view the previous photo.
- 2 Press **▲** to rotate the image 90° clockwise. Press **▼** to rotate the image 90° counterclockwise.
- 3 Press **i+** to display file status information (file number, photo title, date and time taken, resolution etc.). The information display will time out (after about 6 seconds) or you can close by pressing **i+** again.

Slideshow

This view allows you to watch a slideshow of the photos. In this mode, only files located in the selected directory will be played.

- 1 To start slideshow, press **OK** in the single view mode.
- 2 Press **◀/▶** to view the previous/next photo content.
- 3 Press **▲** or **▼** to rotate the photo.
- 4 Press **i+** to display file status information. The information display will time out (after about 6 seconds) or you can close by pressing **i+** again.

To set Picture Size, Interval Time and Repeat settings:

- 1 Press **QUICK** to open the **Quick Menu**.

Quick Menu	
Picture Size	Normal
Interval Time	◀ 3sec ▶
Repeat	On

- 2 Press **▲** or **▼** to select either **Picture Size**, **Interval Time** or **Repeat**.
- 3 Press **◀** or **▶** to adjust the setting and press **OK**.

To close the Photo Viewer

- 1 Press **EXIT**. The television will return to the last viewed channel or external input.

Other features

Panel Lock

Panel Lock disables the buttons on the television. All buttons on the remote control can still be used.

- 1 From the **PREFERENCES** menu select **Panel Lock** and choose **On** or **Off** using ◀ or ▶.

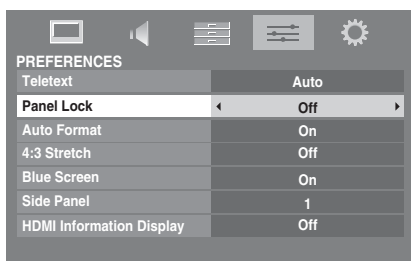

When **Panel Lock** is **On**, a reminder will appear when the buttons on the television are pressed. **If the standby button is pressed the television will switch off and can only be brought out of standby by using the remote control.**

TOSHIBA Illumination (RV series only)

You can set the illumination mode of the TOSHIBA logo located on the front panel to **On** or **Off**.

- 1 In the **PREFERENCES** menu, press ▼ to select **TOSHIBA Illumination**.
- 2 Press ◀ or ▶ to select either **On** or **Off**.

The timers

Programme Timers – digital only

This feature will set the television to go to a specific channel at a certain time. It can be used to view a particular programme, or by setting the mode to daily or weekly, can be used to view a series of programmes.

- 1 Press **MENU** and ◀ or ▶ to select the **APPLICATIONS** menu.

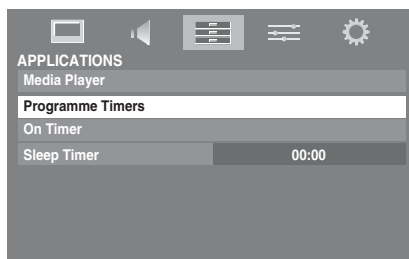

- 2 Press ▼ to select **Programme Timers**, and then press **OK**.
- 3 Press ▼ if necessary to select an open timer position, then press **OK**. The **Edit Timer** menu will now appear on screen.
- 4 Press ▲ and ▼ to go through the list adding the details of the programme by using the number buttons and ◀ and ▶ to make selections.

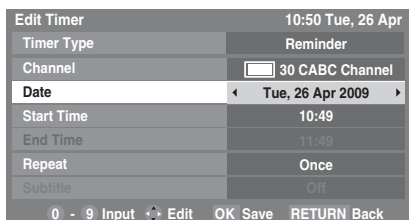

- 5 When all the details have been entered press **OK** to save the timer.

The **ORANGE/RED** programme timer indicator on the front of the television will be lit (see page 47 for details).

PLEASE NOTE: When a timed programme is about to start, an information screen will appear offering the option of watching or cancelling the programme. The menus and other channels will not be available during the timed programme unless the programme timer is cancelled. The programme timer you set is not performed when the TV is turned off with the **POWER** switch.

On Timer

This feature allows you to set the television to turn on automatically to a preset channel at a certain time of day or after a certain length of time. When **On Timer** is set to **On**, the green **On Timer** indicator on the front of the television is lit.

- 1 In the **APPLICATIONS** menu, press **▼** to select **On Timer** and press **(OK)**.
- 2 Press **▲** or **▼** to select **Enable On Timer**, and then press **◀** or **▶** to select **On**.

On Timer	
Enable On Timer	◀ On ▶
Enable DTV Clock	On
Power On Time	00:00
Repeat	Once
Input	DTV
Channel	12 ABC
Volume	20
Time until Power On	00:00

- 3 Press **▼** to select **Enable DTV Clock**, and then press **◀** or **▶** to select **On** or **Off**.
- 4 Press **▲** or **▼** to go through the list adding the details of the **On Timer** by using the number buttons and **◀** and **▶** to make selections.

Power On Time (only for DTV Clock On mode): Set the time you prefer with the number buttons.

Repeat (only for DTV Clock On mode): Select the desired **On Timer** operation (**Once**, **Everyday**, **Mon-Fri**, **Mon-Sat**, **Sat-Sun**).

Input: Select a video input source (ATV, DTV, EXT 1, EXT 2, EXT 3, HDMI 1, HDMI 2, HDMI 3, HDMI 4 or PC).

Channel: Set the channel that will be tuned when the television turns on.

NOTE: When an external input is selected in the **Input** field, a channel cannot be selected.

Volume: Set the volume that will be applied when the television turns on.

Time until Power On (only for DTV Clock Off mode): Set the amount of time from now until the TV turns on using the number buttons (maximum of 12 hours and 50 minutes).

To cancel the On Timer

- 1 In the **On Timer** menu, select **Enable On Timer**
- 2 Press **◀** or **▶** to select **Off**.

Sleep Timer

The television can be set to turn itself **Off** after a certain length of time.

- 1 In the **APPLICATIONS** menu, press **▼** to select **Sleep Timer**. Use the number buttons to set the required time. For example, to switch the television off in one and a half hours enter 01:30, or press **▶/◀** to increase/decrease in steps of 10 minutes.
- 2 Press **EXIT** to finish.
- 3 To cancel the **Sleep Timer**, enter all zeros in the above setting.

Digital on-screen information and Programme Guide

When viewing in **digital** mode, the on-screen information and programme guide provide access to programme details for all available channels.

Information

- 1 Press **i+**, the information screen will appear giving details of the channel and programme currently being viewed.

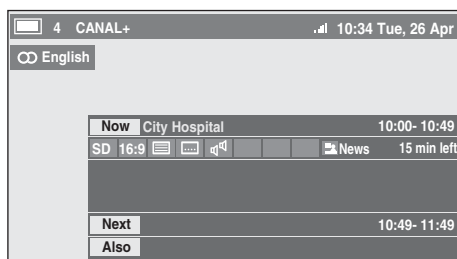

- 2 Press **▲** or **▼** to select the "Now", "Next" or "Also" information guide.
- 3 To record the next scheduled programme, select "Next" and press **OK**. The **Edit Timer** screen will appear.

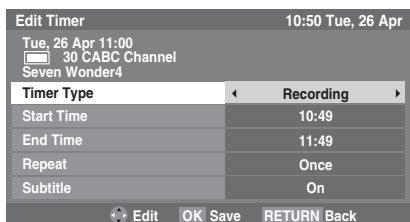

- 4 The details of the programme will already have been added to the timer. Press **OK** to save.

To indicate that a Recording Timer has been set, a clock icon will be displayed in the **Next** and **Also** fields of the information screen. A check mark will appear if the timer is a Reminder Timer.

- 5 Press **▼** to select **Also**. Details of programmes that have started on other channels will be provided. Use **◀** or **▶** to change the display contents.

On-screen Information icons

	Icon	Description
Service info		Service type (TV, Radio, TEXT)
		Skip
Audio info		Mono
		Stereo
		Dual mono
		Multichannel
		Dolby Digital
		Dolby Digital+
Audio/Subtitle info		For Hard of Hearing
Event info		Video format (HD, SD)
		Video Aspect
		Teletext
		Subtitle (Single, Multi)
		Multi-audio track
		Parental rating
		Encrypted
Timer info		Recording
		Reminder

Guide

- 1 Select the on-screen guide by pressing **GUIDE**, the guide screen will appear highlighting details of the channel and programme currently being viewed. This may take a few moments to appear.

Thu6	10:50 Tue, 6 Apr				
TV	18:00	18:30	19:00	19:30	20:00
6 M6	LES SIMPSON	TOP MODEL			
9 W9	SUMMERLAND	SUMMERLAND	LES SIM...		
11 NT1	Nicky La...	Street fight...	Dragon B...	Dragon B...	K 2000
31 PARIS PREMIERE	MA SORCIE...	HAPPY DAYS	HAPPY DAYS		
34 AB1	Evamag	21 jump street	Jerry Springer Show	City guys	L...
800 FlowerGd 6Mbs					
801 FlowerGd 4Mbs					
802 FlowerGd 2Mbs					
804 Codec 4:3					
806 ITV1					
807 ITV3					
808 ITV2					
809 ITV4					

You can switch the time scale to 1.25 or 2.5 hours by pressing the **GREEN** button.

NOTE: Channels are displayed in groups of service type (TV, Radio, Text). Pressing the **ATV/DTV** button will switch the service type.

- 2 Press **◀** or **▶** for information on other programmes scheduled for the channel selected. To highlight the first programme in the genre grid, press the **RED** button.
- 3 For details of other programmes currently available, press **▲** and **▼** to scroll up and down the channel list. As channels are selected, details of the programme currently being broadcast will appear. Press **◀** or **▶** to view information for future programmes.
- 4 For more information on a highlighted programme, press **i+**.
- 5 To set a timer for a programme, press the **BLUE** button to bring up the **Programme Timers** menu.

NOTE: In order for the recording operation to work properly, the media recorder must be set to the same time as the TV. Regarding the process for recording, please refer to the owner's manual of the recording equipment.
- 6 Press **P>** to advance to the next page, or press **P^** to go back to the previous page.

Genre selection/searching

From the guide screen, you can use the genre selection and search features.

- 1 Press the **QUICK** button from the guide screen.
- 2 Press **▼** or **▲** to highlight **Genre Colour** in the **Quick Menu**, then press **OK**.

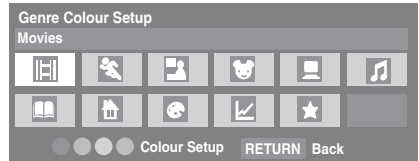

- 3 With the focus on a particular genre, press the desired colour key to assign. Four colours will be available to set. Press **RETURN** to go back to the guide screen.
- 4 Press the **YELLOW** button to access the **Genre Search** screen.

Genre Search		10:50 Tue, 6 Apr
Movies		
34 AB1	Hard Rain	Wed,27 Apr 0:15- 1:45
31 PARIS PREMIERE	Red Corner	Wed,27 Apr 22:15- 23:55
11 NT1	The Lawnmower Man	Thu,28 Apr 1:20- 3:00
9 W9	A Vow to Kill	Fri,29 Apr 1:30- 3:00
34 AB1	Parenthood	Sat,30 Apr 0:45- 2:40
11 NT1	Body and Soul	Sat,30 Apr 1:15- 3:00
31 PARIS PREMIERE	The Nun's Story	Sat,30 Apr 15:00- 17:30
9 W9	Red Corner	Sat,30 Apr 23:20- 1:15
11 NT1	The Real Blonde	Sun,1 May 0:40- 2:00
31 PARIS PREMIERE	Critters	Sun,1 May 0:40- 2:20
11 NT1	Indiana Jones and the Temple of Doom	Sun,1 May 21:10- 23:20
11 NT1	The jackal	Sun,1 May 23:20- 1:15
34 AB	Coup De Ville	Mon,1 May 1:10- 3:00

- 5 Press **◀** or **▶** to select a genre. Programmes listed will change for the new genre. Press **▲** or **▼** to highlight a particular programme.
- 6 When a current programme is selected, pressing **OK** will tune to that programme. When a future programme is selected, pressing **OK** will open the **Edit Timer** menu.
- 7 For information on a highlighted programme press **i+**.
- 8 To exit the **Genre Search** and go back to the guide screen, press the **YELLOW** button.

Digital settings – parental control

In order to prevent viewing of unsuitable films and programmes, channels and menus can be locked in digital mode. These can then only be accessed with a security code PIN.

Setting the PIN

- 1 Press **MENU** and **▶** to select the **SETUP** menu.
- 2 Use **▼** to select **DTV Settings**, and then press **OK**.

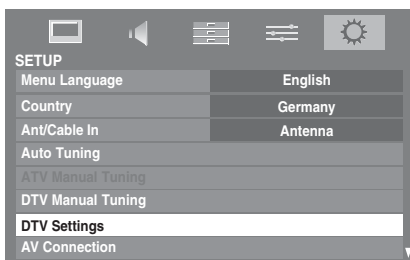

- 3 Press **▼** to highlight **PIN Setting**, and then press **OK**.

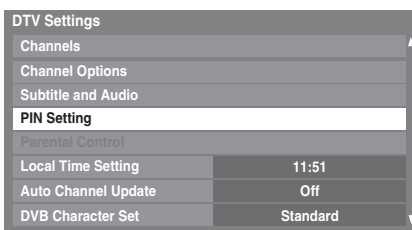

- 4 Using the number buttons enter a four digit number. Once entered you will be prompted to confirm by entering again.



The PIN number is now set.

If the PIN code has been set, when **Auto Tuning** and **Reset TV** are executed, entering the PIN will be necessary.

Parental Setup

The **Parental Control** feature allows you to block programmes according to their rating levels. If a PIN has been set, you will need to enter it before adjusting the level.

- 1 In the **DTV Settings** menu press **▼** to select **Parental Control**, and then press **OK**.
- 2 Use **◀** or **▶** to choose an option (**None** or an age setting (4-17)).



To view blocked programmes, enter the PIN. To reactivate the Parental Control, turn the TV off and then on again.

Digital settings – Channel Options

Skipping channels

This feature allows you to set channels that will be skipped when **P** or **P** are used to tune.

- 1 From the **DTV Settings** menu press **▼** to select **Channel Options** and press **OK**.
- 2 Press **▲** or **▼** to select a channel position to be skipped. Press **OK** to set the ones desired. A tick will appear in the box.

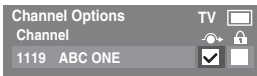

- 3 Press **EXIT**.

NOTE: Skipped channels cannot be selected by **P** or **P** but can still be accessed by direct number entry (when tuned a **↻** icon will be displayed in the banner to indicate as a skipped channel).

Locking channels

Locking Channels stops the viewing of **digital** channels. They can only be accessed by entering the **PIN**.

- 1 From the **DTV Settings** menu, press **▼** to select **Channel Options** and press **OK**.
- 2 Press **▶** to select the Locked Channel list.
- 3 Press **▲** or **▼** to select a channel position to be locked. Press **OK** to set the lock. A tick will appear in the box.

If a **PIN** has already been set, **PIN** entry will be required to set the locked channels.

- 4 Press **EXIT**.
- 5 From this point on, when any of the channels in the **Locked Channel** list are tuned, the **PIN** must be entered before they can be accessed.

Digital settings – other settings

Subtitles

In **digital** mode, this feature will show subtitles on the screen in the selected language provided they are being broadcast.

- 1 In the **DTV Settings** menu press **▼** to select **Subtitle and Audio** and press **OK**.
- 2 Press **▼** to select **Subtitle Type** and use **◀** or **▶** to select **Normal** or **For Hard of Hearing**.

Subtitle and Audio	
Subtitle Type	◀ Normal ▶
Primary Subtitle Language	English
Secondary Subtitle Language	French
Audio Type	Normal
Primary Audio Language	English
Secondary Audio Language	French

- 3 Press **▼** to select **Primary Subtitle Language** or **Secondary Subtitle Language** and use **◀** or **▶** to select an option.

The **SUBTITLE** button can be used to select subtitle **ON** or **OFF**, and to select subtitle language if more than one subtitle is available.

Audio languages

This feature allows a programme or film to be viewed with a choice of soundtrack language, provided multiple language tracks are being broadcast.

- 1 In the **Subtitle and Audio** menu press **▼** to select **Audio Type** and use **◀** or **▶** to select **Normal** or **For Hard of Hearing**.
- 2 Press **▼** to select **Primary Audio Language** or **Secondary Audio Language** and use **◀** or **▶** to select an option.

If more than one soundtrack is available, use the **◻/◻** button to select between them.

Common Interface

The *Common Interface Slot*, situated on the side of the television, enables the insertion of a CAM (Conditional Access Module) and card. These are purchased from a service provider and allow additional subscription broadcasts to be viewed. For information, see a service provider.

- 1 Insert the CAM and card into the Common Interface Slot, following the instructions provided with the CAM. A box will appear on screen to confirm that the CAM has been inserted.
- 2 In the **DTV Settings** menu press ▲ or ▼ to select **Common Interface** and press **OK**.
- 3 Details of the CAM should now be available.

Software Upgrade and Licenses

Auto Upgrade

When **Auto Upgrade** is set to **On** (default setting), the television will automatically upgrade while in standby if new software is available.

- 1 From the **SETUP** menu press ▲ or ▼ to select **Software Upgrade** and press **OK**.
- 2 Press ▼ to select **Auto Upgrade**.
- 3 Use ◀ or ▶ to select **On** or **Off**.

Searching for New Software

If preferred, software upgrades can be searched for manually using **Search for New Software**.

- 1 In the **Software Upgrade** menu press ▲ or ▼ to select **Search for New Software**.
- 2 Press **OK**. The television will automatically start searching for a software upgrade, the progress bar will move along the line.

SEARCHING FOR NEW SOFTWARE

Searching for a new software upgrade for this TV.

Searching 

If an upgrade is found, the television will automatically start downloading. If not, a screen will appear stating that an upgrade is unavailable.

Software Licenses

The licenses for the software used in this television are available for viewing.

- 1 In the **SETUP** menu, press ▲ or ▼ to select **Software Licences** and press **OK**.

A screen will appear displaying all the licensing information required for the television's software.

System Information and Reset TV

System Information

This feature can be used to check the version of software currently installed. When in DTV mode, it includes additional diagnostic information such as signal strength, signal quality, centre frequency, modulation, etc.

- 1 From the **SETUP** menu press **▲** or **▼** to select **System Information**.
- 2 Press **OK** to display the **System Information**.

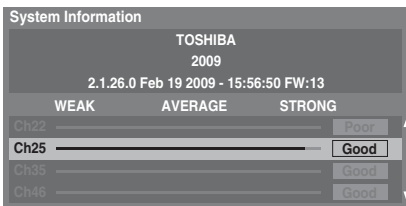

- 3 For information about the signal quality of a particular multiplex, press **▲** or **▼** to select that multiplex.
- 4 Press **OK** for a screen showing detailed technical information about the selected multiplex.

Automatic Power Down

The TV will automatically turn itself off (standby) after approximately 4 hours, if you do not touch the control buttons on the remote control or on the TV control panel.

- 1 In the **SETUP** menu, press **▼** until **Automatic Power Down** is highlighted.
- 2 Use **◀** or **▶** to select **On**.

Reset TV

Selecting **Reset TV** will reset all TV settings, including saved channels, to their original factory values.

- 1 In the **SETUP** menu press **▼** until **Reset TV** is highlighted.
- 2 Press **OK** to select. A screen will appear warning that all settings will be lost. Press **OK** to continue.

When the set powers back on, the **Quick Setup** screen will appear. Press **OK** to advance the setup and perform an auto tune. (See 'Quick Setup' section on page 13.)

PC Settings

Horizontal and Vertical Position

Connect the PC (as shown in the 'Connecting a PC' section) and ensure that a picture is showing on the television screen. The picture position may now be adjusted to suit personal preference.

- 1 Press **☺** to select **PC**, then select **PC Settings** from the **SETUP** menu.

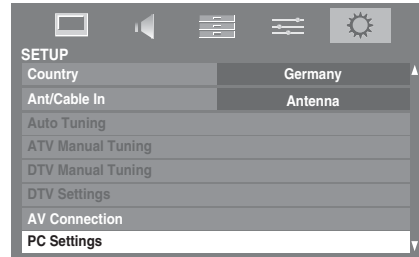

- 2 Press **OK**. Press **▲** and **▼** to select an option, then **▶** to adjust the settings.

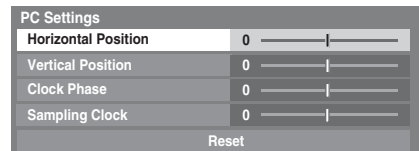

Clock Phase

The **Clock Phase** matches the PC signal with the LCD display. Adjusting this can clear horizontal stripes and picture blur.

- 1 In the **SETUP** menu press **▼** until **PC Settings** is highlighted.
- 2 Press **OK** to select, then **▼** to highlight **Clock Phase**.
- 3 Use **◀** or **▶** to adjust until the picture clears.

Sampling Clock

Adjusting the **Sampling Clock** alters the number of pulses per scan, this will clear vertical lines on the screen.

- 1 In the **SETUP** menu press ▼ until **PC Settings** is highlighted.
- 2 Press **OK** to select, then ▼ to highlight **Sampling Clock**.
- 3 Use ◀ or ▶ to adjust until the picture clears.

Reset

Use **Reset** to return all items to the original factory settings.

- 1 In the **SETUP** menu press ▼ until **PC Settings** is highlighted.
- 2 Press **OK** to select, then ▼ to highlight **Reset**.
- 3 Press **OK**.

NOTE: When a PC is connected using HDMI none of these functions will be available.

The screen is disrupted momentarily when adjusting PC Settings. This is not a sign of malfunction.

The default settings and adjustment ranges may vary depending on the input signal format.

Input selection and AV connections

See page 9 for a detailed image showing recommended connections.

Most media recorders and decoders send a signal through the SCART lead to switch the television to the correct *Input* socket.

Alternatively, press the external source selection button  until the picture from connected equipment is shown.

This button must be used to view equipment connected using the COMPONENT VIDEO INPUT (**EXT 3C**).



An **S** in the display e.g.  **2S (EXT 2S)**, indicates the input is set for an S-Video signal.

Input selection

Use the *Input Selection* window if the television does not switch over automatically.

- 1 By pressing  on the remote control or TV, a list will appear on screen showing all inputs and external equipment.

Pressing on the remote control

Inputs
TV
 1
 2
 3C
HDMI 1
HDMI 2
HDMI 3
HDMI 4
PC

* *HDMI 4 is model dependent*

Pressing on the TV right side panel

Inputs
DTV TV
DTV RADIO *
DTV TEXT *
 1
 2
 3C
HDMI 1
HDMI 2
HDMI 3
HDMI 4
PC
ATV

* *If radio or text channels are currently available for DTV.*

HDMI™ displays equipment connected to *Input HDMI* on the back or side of the television.

PC displays a computer connected to *Input RGB/PC* on the back of the television.

External input skip

This feature is designed to make input selection more convenient.

- 1 Press  to select the external input to be skipped (e.g. HDMI 1).

2 In the **SETUP** menu press ▼ to select **Manual Settings** and press **OK**.

3 Press ▲ or ▼ to turn **Skip** on and press **OK**.

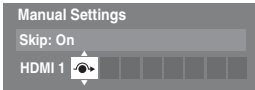

4 Press **OK** to save.

The input set to Skip is greyed out in the Input Selection window and is skipped over when you press **OK** on the remote control.

Input signal selection

This specifies the type of signal going into SCART 2 (**EXT 2**) on the back of the television. Please refer to the manufacturer's instructions for the connected equipment.

1 In the **SETUP** menu press ▼ until **AV Connection** is highlighted, then press **OK**.

2 With ◀ or ▶ select either **AV** or **S-VIDEO** as the required **input** for **EXT 2**.

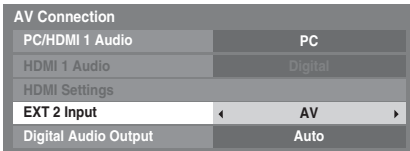

If video colour is absent, try the other setting.

PC Audio

In order to receive sound from a connected PC, plug the audio cable into the back of the television (as shown in the 'Connecting a computer' section), and then use the **PC/HDMI 1 Audio** setting.

1 In the **SETUP** menu, press ▼ until **AV Connection** is highlighted, and then press **OK**.

2 Highlight **PC/HDMI 1 Audio**, and then use ▶ to select the **PC** option.

NOTE: Selecting the **PC** option will force HDMI 1 Audio to Digital mode.

HDMI 1 Audio

If the connected HDMI source does not support digital audio, plug the audio cable into **PC/HDMI 1 (AUDIO)** on the back of the television (as shown in the 'Connecting an HDMI™ or DVI device to the HDMI input' section), then use the **HDMI 1 Audio** setting.

1 In the **AV Connection** menu press ▼ to highlight **PC/HDMI 1 Audio** and using ▶ select **HDMI 1**.

2 Then highlight **HDMI 1 Audio** and using ◀ or ▶ select **Auto** or **Analogue**.

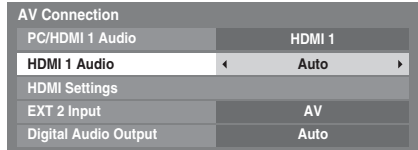

If the sound is absent, try selecting a different setting.

NOTE: HDMI 1 supports digital and analogue sound, HDMI 2, HDMI 3 and HDMI 4 are digital sound only.

Certain DVD disk formats may not output from this TV (32/44.1/48kHz and 16/20/24 bits are acceptable).

HDMI Settings

Some early HDMI equipment may not work properly with your HDMI TV. Please try setting the **Lip Sync** and **INSTAPORT™** options to **Off**. Adjusting these settings should allow your early HDMI source to operate properly with your television.

1 In the **SETUP** menu press ▼ until **AV Connection** is highlighted, then press **OK**.

2 Press ▼ to highlight **HDMI Settings** and press **OK**.

NOTE: **HDMI Settings** is grayed out on non-HDMI inputs.

HDMI, the HDMI logo, and High-Definition Multimedia Interface are trademarks or registered trademarks of HDMI Licensing, LLC.

INSTAPORT™ and INSTAPORT logo are trademarks of Silicon Image, Inc. in the United States and other countries.

- 3** Press ▲ or ▼ to select an item, and then press ◀ or ▶ to select a setting.

HDMI Settings	
Lip Sync	◀ On ▶
INSTAPORT™	On
RGB Range	Auto

• **Lip Sync: On**

This option activates an audio/video display timing adjustment function that allows HDMI source devices to accurately perform synchronization automatically.

• **INSTAPORT™: On**

This feature reduces the lag time when switching HDMI sources.

• **RGB Range: Auto**

This feature adjusts RGB full range signal automatically. When **Limit** is selected, RGB signal is output in the range from 16 to 235. When **Full** is selected, RGB signal is output in the range from 0 to 255.

NOTE:

- If your HDMI connection is capable of 1080p and/or your television is capable of refresh rates greater than 50Hz or supports Deep Colour, you will need a Category 2 cable. Conventional HDMI/DVI cables may not work properly with this mode.
- All of the above HDMI settings need proper HDMI source devices. If the HDMI source products do not support these features, the television may not work properly by activating these features.

Digital Audio Output

When connecting a surround sound amplifier to the digital audio output (Sony/Philips Digital Interface Format [S/PDIF]), the following options can be selected.

- PCM:** this mode outputs PCM format to the digital audio output socket.
- Auto:** this mode outputs Dolby Digital (if available) or PCM to the digital audio output socket.

Dolby Digital → Dolby Digital
 Dolby Digital Plus → Dolby Digital
 MPEG → PCM
 HE-AAC → Dolby Digital

- 1** In the **AV Connection** menu press ▼ to select **Digital Audio Output**.
- 2** Use ◀ or ▶ to select **PCM** or **Auto**.

Text services

This television has a multi-page text memory, which takes a few moments to load. It offers two **Modes** of viewing text – **Auto** will display **Fasttext**, if available. **LIST** will save your four favourite pages.

Selecting modes

The text character set will be automatically chosen by the language setting in the **SETUP** menu.

- 1 Select **Teletext** from the **PREFERENCES** menu.
- 2 With ◀ or ▶ choose **Auto** or **LIST** then press **EXIT**.

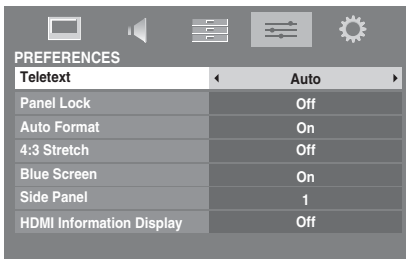

Text information

The **TEXT** button:

To view text services press **TEXT**. Press again to superimpose the text over a normal broadcast picture and again to return to normal viewing. Channels cannot be changed until text is cancelled.

The first text page shown will be the *initial* page.

Any text page can be accessed by entering the 3 digit page number using the numbered buttons, pressing the coloured buttons or pressing **P^** to advance to the next page and **Pv** to go back to the previous page.

Sub-pages

The pages on the screen will dynamically update as sub-pages are received.

If you open a page containing sub-pages, the sub-pages are automatically displayed in sequence. To quit automatic sub-page change, press ◀ or ▶.

Once selected, the sub-page you are viewing will be highlighted and, as the television loads any additional sub-pages, the colour of the numbers will change, indicating that these pages have been loaded.

These sub-pages will remain available to view until another page is chosen or, in normal TV mode, the channel is changed.

Navigating pages using Auto

If **Fasttext** is available four coloured titles will appear at the base of the screen.

To access one of the four given subjects, press the relevant coloured button on the remote control.

For further information on your particular text system(s), see the broadcast text index page or, consult your local Toshiba dealer.

Navigating pages using LIST

The four coloured choices at the bottom of the screen are numbers – 100, 200, 300 and 400, which have been programmed into the television's memory. To view these pages, press the relevant coloured buttons.

To change these saved pages, press the relevant coloured button and enter the 3 digit number. This number will change in the top left of the screen and in the coloured highlight.

Press **OK** to save. **Whenever OK is pressed, all four page numbers showing at the bottom will be saved and the previous ones will be lost.**

If **OK** is not pressed, the selection will be forgotten when the channel is changed.

Other pages may be viewed by entering the 3 digit page number – but DO NOT press **OK** or these pages will be saved.

Control buttons

Below is a guide to the functions of the remote control text buttons.

To display the index/initial page:

Press  to access the index/initial page. The one displayed is dependant on the broadcaster.



TEXT To display a page of text:

Press **TEXT** to display text. Press again to superimpose text over a normal picture. Press again to return to normal television viewing. Channels cannot be changed until this has been done.

To reveal concealed text:

To discover the solutions on quiz and joke pages press the  button.



To hold a wanted page:

At times it is convenient to hold a page of text. Press  and  will appear in the top left of the screen. The page will be held on screen until the button is pressed again.

To enlarge the text display size:

Press  once to enlarge the top half of the page, press again to enlarge the bottom half of the page. Press again to revert to normal size.

/ **To select a page whilst viewing normal picture:**

Enter the page number then press / , normal picture will be displayed. The television will indicate when the page is ready by changing the colour of the page number at the top of the screen. Press **TEXT** to view the page.

To display news flashes:

Select the news flash page for the chosen text service (see the index page of text service). The news flashes will be displayed as and when they are broadcast.



Remember to cancel text before changing channels - press the TEXT button twice.

Questions and Answers

Below are the answers to some of the most common queries.
For more information go to www.toshiba.co.uk

Q *Why is there no sound or picture?*

A Check the television is not in standby mode. Check the mains plug and all mains connections.

Q *There is a picture, but why is there little or no colour?*

A When using an **external** source, for instance, a poor quality video tape, if there is little or no colour, improvements may sometimes be achieved. The colour is factory set to **Auto** to automatically display the best colour system.

To check that you have the best colour:

- 1 With the external source playing, select **Manual Settings** from the **SETUP** menu.

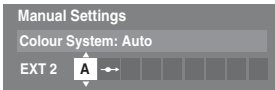

- 2 With **▲** or **▼** choose between **Auto**, **PAL**, **SECAM**, **NTSC 4.43** or **NTSC 3.58**.

Q *Why doesn't the video/DVD being played show on screen?*

A Make sure the VCR or DVD player is connected to the television as shown on page 9, and then select the correct input by pressing **Ⓢ**.

Q *Why is there a picture but no sound?*

A Check all lead connections.
No sound or unacceptable format sound may be received.
Check the volume has not been turned down or that sound mute has not been selected.

Q *Why is the VCR/DVD picture in black and white?*

A Check that the correct setting has been chosen for **EXT 2 Input**, **S-VIDEO** or **AV**. See **AV Connection** on page 41.

Q *What else can cause a poor picture?*

A Interference or a weak signal. Try a different television station. **Manual Fine Tuning** may help.

- 1 Select the **ATV Manual Tuning** menu. Highlight the station and press **(OK)**, then press **▶** to select **Manual Fine Tuning**.

- 2 Using **▲** or **▼** adjust to get the best picture and sound. Press **(OK)** and then **EXIT**.



Q *Why don't the controls of the television work?*

A Check that **Panel Lock** is not **On**.

Q *Why doesn't the remote control work?*

A Check that the mode switch on the remote control is in TV mode.
Check that the batteries aren't dead or inserted incorrectly.

Q *What is DVB-T?*

A Digital Video Broadcast via an aerial/antenna.

Q *What is DVB-C?*

A Digital Video Broadcast via a cable connection.

Q *How are radio channels selected?*

A Press **ATV/DTV** on the remote control and select **DTV RADIO**. Alternatively select from the **GUIDE**.

Q *Why is the digital channel locked?*

A The channel has been selected in **Locked Channels** (see 'Digital Settings' section).

Q Why are some of the digital subscription channels unavailable?

A Your subscription needs upgrading. Contact your service provider.

Q Why is the soundtrack in English when a different audio language has been selected?

A The programme is currently being broadcast with an English soundtrack only.

Q Why is there incorrect or no sound when in DTV mode?

A Press \odot /I to ensure the hard of hearing option has not been selected.

Q What can be done if the PIN number has been forgotten?

A Use the Master PIN code of 1276, then change to a number of your choice. Ensure that no-one else can use the Master PIN by removing the Owner's Manual.

Q Why are there vertical stripes on the screen when in PC mode?

A The **Sampling Clock** may need adjustment. Select **PC Settings** from the **SETUP** menu, highlight **Sampling Clock** and adjust until the lines clear.

Q Why are there horizontal stripes and/or blurred images on the screen when in PC mode?

A The **Clock Phase** may need adjustment. Select **PC Settings** from the **SETUP** menu, highlight **Clock Phase** and adjust until the picture clears.

Q Why when digital subtitles have been selected are they not showing on screen?

A Subtitles are not currently being transmitted by the broadcaster.

Q Why are there problems with analogue text?

A Good performance of text depends on a strong broadcast signal. This normally requires a roof or loft aerial. If the text is unreadable or garbled, check the aerial. Go to the *main index* page of the text service and look for the *User Guide*. This will explain the basic operation of text in some detail. If further information is needed on how to use text see the *text section*.

Q Why is a page number visible at the top of the screen but no text?

A Text has been selected but Teletext information is currently unavailable on the current source.

Q Why are the colours wrong when an NTSC source is played?

A Connect the source via a SCART lead and play. Select **Manual Settings** from the **SETUP** menu.

1 Set the Colour to **Auto** and exit.

2 Go to the **PICTURE** menu and adjust the tint.

Q Why don't the devices connected via HDMI operate properly?

A Make sure to use cables with the HDMI logo **HDMI** (see page 10).

Some early HDMI equipment may not work properly with the latest HDMI TV products, due to new standard adoption. Try the HDMI settings **Lip Sync**, **INSTAPORT™** to **Off**.

Q Why are the LEDs on the front of the television indicate?

A Check the table below.

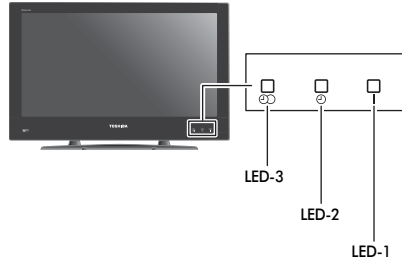

LED indication			Condition	Solution
LED-3	LED-2	LED-1		
Orange (Solid)	Green (Solid)	Green (Solid)	Power ON On Timer is set Programme Timer is set	-
Red (Solid)	Green (Solid)	Green (Solid)	Power ON On Timer is set Programme Timer is active	-
OFF	Green (Solid)	Green (Solid)	Power ON On Timer is set Programme Timer is NOT set	-
Orange (Solid)	OFF	Green (Solid)	Power ON On Timer is NOT set Programme Timer is set	-
Red (Solid)	OFF	Green (Solid)	Power ON On Timer is NOT set Programme Timer is active	-
OFF	OFF	Green (Solid)	Power ON On Timer is NOT set Programme Timer is NOT set	-
Orange (Solid)	Green (Solid)	Red (Solid)	Power OFF (Standby) On Timer is set Programme Timer is set	-
Red (Solid)	Green (Solid)	Red (Solid)	Power ON (Standby) On Timer is set Programme Timer is active	-
OFF	Green (Solid)	Red (Solid)	Power OFF (Standby) On Timer is set Programme Timer is NOT set	-
Orange (Solid)	OFF	Red (Solid)	Power OFF (Standby) On Timer is NOT set Programme Timer is set	-
Red (Solid)	OFF	Red (Solid)	Power ON (Standby) On Timer is NOT set Programme Timer is active	-
OFF	OFF	Red (Solid)	Power OFF (Standby) On Timer is NOT set Programme Timer is NOT set	-

LED indication			Condition	Solution
LED-3	LED-2	LED-1		
OFF	OFF	Green (Blinks)	Abnormal operation of BUS line.	Turn OFF the TV and unplug the power cord. Plug the power cord in again and turn ON the TV.
OFF	OFF	Red (Blinks)	Power protect detection.	
OFF	OFF	Orange (Blinks)	Back Light error.	

License Information

(for RV685/RV675 and LV685/LV675 series)

THIS PRODUCT IS LICENSED UNDER THE AVC PATENT PORTFOLIO LICENSE FOR THE PERSONAL AND NONCOMMERCIAL USE OF A CONSUMER TO (i) ENCODE VIDEO IN COMPLIANCE WITH THE AVC STANDARD ("AVC VIDEO") AND/OR (ii) DECODE AVC VIDEO THAT WAS ENCODED BY A CONSUMER ENGAGED IN A PERSONAL AND NONCOMMERCIAL ACTIVITY AND/OR WAS OBTAINED FROM A VIDEO PROVIDER LICENSED TO PROVIDE AVC VIDEO. NO LICENSE IS GRANTED OR SHALL BE IMPLIED FOR ANY OTHER USE. ADDITIONAL INFORMATION MAY BE OBTAINED FROM MPEG LA, L.L.C.
SEE [HTTP://WWW.MPEGLA.COM](http://www.mpegla.com)

Cleaning the screen and cabinet...

Turn off the power, clean the screen and cabinet with a soft, dry cloth. We recommend that you **do not** use any proprietary polishes or solvents on the screen or cabinet as this may cause damage.

Disposal...

The following information is only for EU-member states:

Disposal of products

The crossed out wheeled dust bin symbol indicates that products must be collected and disposed of separately from household waste. Integrated batteries and accumulators can be disposed of with the product. They will be separated at the recycling centres.

The black bar indicates that the product was placed on the market after August 13, 2005.

By participating in separate collection of products and batteries, you will help to assure the proper disposal of products and batteries and thus help to prevent potential negative consequences for the environment and human health.

For more detailed information about the collection and recycling programmes available in your country, please contact your local city office or the shop where you purchased the product.

Disposal of batteries and/or accumulators

The crossed out wheeled dust bin symbol indicates that batteries and/or accumulators must be collected and disposed of separately from household waste.

If the battery or accumulator contains more than the specified values of lead (Pb), mercury (Hg), and/or cadmium (Cd) defined in the Battery Directive (2006/66/EC), then the chemical symbols for lead (Pb), mercury (Hg) and/or cadmium (Cd) will appear below the crossed out wheeled dust bin symbol.

By participating in separate collection of batteries, you will help to assure the proper disposal of products and batteries and thus help to prevent potential negative consequences for the environment and human health.

For more detailed information about the collection and recycling programmes available in your country, please contact your local city office or the shop where you purchased the product.



Hg Cd Pb

For your own records

Information

Before connecting any external equipment, turn off all main power switches. If there is no switch, remove the mains plug from the wall socket.

Signal information for Mini D-sub 15 pin connector

Pin No.	Signal name	Pin No.	Signal name	Pin No.	Signal name
1	R	6	Ground	11	NC
2	G	7	Ground	12	NC
3	B	8	Ground	13	H-sync
4	NC*	9	NC	14	V-sync
5	NC	10	Ground	15	NC

* NC = not connected

Acceptable PC signals through the PC terminal

The PC input on this TV only accepts the signal formats which are compliant with VESA-DMT as shown in the table below. Since some PCs input signals which are different from the resolution and frequency described in the table below, the following phenomenon may occur; incorrect display, false format detection, picture position failure, blur, or judder. In this case, set the monitor output format on your PC to conform to a signal in the table below.

Format	Resolution	V. Frequency	H. Frequency	Pixel Clock Frequency	VESA Standard (DMT)
VGA	640 × 480	59.940Hz	31.469kHz	25.175MHz	●
		72.809Hz	37.861kHz	31.500MHz	●
		75.000Hz	37.500kHz	31.500MHz	●
SVGA	800 × 600	56.250Hz	35.156kHz	36.000MHz	●
		60.317Hz	37.879kHz	40.000MHz	●
		72.188Hz	48.077kHz	50.000MHz	●
		75.000Hz	46.875kHz	49.500MHz	●
XGA	1024 × 768	60.004Hz	48.363kHz	65.000MHz	●
		70.069Hz	56.476kHz	75.000MHz	●
		75.029Hz	60.023kHz	78.750MHz	●
WXGA	1280 × 768	59.995Hz	47.396kHz	68.250MHz	●
		59.870Hz	47.776kHz	79.500MHz	●
		74.893Hz	60.289kHz	102.250MHz	●
	1360 × 768	60.015Hz	47.712kHz	85.500MHz	●
SXGA	1280 × 1024	60.020Hz	63.981kHz	108.000MHz	●
		75.025Hz	79.976kHz	135.000MHz	●

Acceptable video or PC signals through the HDMI terminals

The HDMI inputs on this TV only accept VGA, SVGA, XGA, WXGA, and SXGA signal formats which are compliant with VESA as shown in the table below. Since some PCs and HDMI or DVI devices input signals which are different from the resolution and frequency described in the table below, the following phenomenon may occur; incorrect display, false format detection, picture position failure, blur, or judder. In this case, set the monitor output format on your PC, HDMI or DVI device to conform to a signal in the table below.

Format	Resolution	V. Frequency	H. Frequency	Pixel Clock Frequency	VESA Standard
480i	720 × 480i	59.940/60.000Hz	15.734/15.750kHz	27.000/27.027MHz	
576i	720 × 576i	50.000Hz	15.625kHz	27.000MHz	
480p	720 × 480p	59.940/60.000Hz	31.469/31.500kHz	27.000/27.027MHz	
576p	720 × 576p	50.000Hz	31.250kHz	27.000MHz	
1080i	1920 × 1080i	59.940/60.000Hz	33.716/33.750kHz	74.176/74.250MHz	
1080i	1920 × 1080i	50.000Hz	28.125kHz	74.250MHz	
720p	1280 × 720p	59.940/60.000Hz	44.955/45.000kHz	74.176/74.250MHz	
720p	1280 × 720p	50.000Hz	37.500kHz	74.250MHz	
1080p	1920 × 1080p	59.940/60.000Hz	67.500kHz	148.500MHz	
1080p	1920 × 1080p	50.000Hz	56.250kHz	148.500MHz	
1080p	1920 × 1080p	24.000Hz	27.000kHz	74.250MHz	
VGA	640 × 480	59.940Hz	31.469kHz	25.175MHz	●
		72.809Hz	37.861kHz	31.500MHz	●
		75.000Hz	37.500kHz	31.500MHz	●
SVGA	800 × 600	56.250Hz	35.156kHz	36.000MHz	●
		60.317Hz	37.879kHz	40.000MHz	●
		72.188Hz	48.077kHz	50.000MHz	●
		75.000Hz	46.875kHz	49.500MHz	●
XGA	1024 × 768	60.004Hz	48.363kHz	65.000MHz	●
		70.069Hz	56.476kHz	75.000MHz	●
		75.029Hz	60.023kHz	78.750MHz	●
WXGA	1280 × 768	59.995Hz	47.396kHz	68.250MHz	●
		59.870Hz	47.776kHz	79.500MHz	●
		74.893Hz	60.289kHz	102.250MHz	●
	1360 × 768	60.015Hz	47.712kHz	85.500MHz	●
SXGA	1280 × 1024	60.020Hz	63.981kHz	108.000MHz	●
		75.025Hz	79.976kHz	135.000MHz	●

Specifications and accessories

DVB-T Broadcast systems/channels		Broadcast systems/channels	
UK	UHF 21-68	PAL-I	UHF UK21-UK69
France	VHF 05-10 (VHF 01-05) UHF 21-69	PAL-B/G	UHF E21-E69 VHF E2-E12, S1-S41
Germany	VHF 05-12 UHF 21-69	SECAM-L	UHF F21-F69 VHF F1-F10, B-Q
Austria	VHF 05-12 UHF 21-69	SECAM-D/K	UHF R21-R69 VHF R1-R12
Switzerland	VHF 05-12 UHF 21-69		
Italy	VHF 05-12 (D,E,F,G,H,H1,H2) UHF 21-69		
Spain	UHF 21-69		
Nederlands	VHF 05-12 UHF 21-69		
Greece	VHF 05-12 UHF 21-69		
Video Input PAL, SECAM, NTSC 3.58/4.43			

External connections

EXT 1	Input/Output	21-pin SCART	RGB, A/V (AV out: TV out)
EXT 2	Input/Output	21-pin SCART	A/V, S-video (AV out: TV out)
EXT 3	Input	Phono jacks Phono jacks	Y, P _B /C _B , P _R /C _R Audio L + R
EXT 3	Input (Side)	Phono jack Phono jacks	Video, S-video Audio L + R
HDMI 1/2/3	Input	HDMI™ (Audio LIP SYNC, INSTAPORT™, RGB Range supported)	
HDMI 4	Input (Side)	HDMI™ (Audio LIP SYNC, INSTAPORT™, RGB Range supported)	
PC	Input	Mini D-sub 15-pin Analogue RGB signal	
PC/HDMI 1 Audio		3.5mm mini jack	Audio
Digital Audio Output (S/PDIF)	Optical		
USB port		USB class: Mass Storage File system: FAT12/16/32	

Stereo Nicam
2 carrier system

Visible Screen Size (approx.) Model 32 80cm
37 94cm
40 102cm
42 107cm

Display 16:9

Sound output (at 10% distortion) Main 10W + 10W

Power consumption (approx.) Model 32 LV 91 W
40 LV 183 W
32 RV 91 W
37 RV 119 W
42 RV 136 W

Standby Model 32 LV 0.3 W
40 LV 0.3 W
32 RV 0.3 W
37 RV 0.3 W
42 RV 0.3 W

Dimensions (approx.) Model 32 LV 57cm (H) 79cm (W) 29cm (D)
40 LV 66cm (H) 98cm (W) 35cm (D)
32 RV 58cm (H) 79cm (W) 29cm (D)
37 RV 65cm (H) 90cm (W) 29cm (D)
42 RV 71cm (H) 101cm (W) 33cm (D)
(Height dimension includes foot stand)

Weight (approx.) Model 32 LV 13.5kg
40 LV 19.0kg
32 RV 15.0kg
37 RV 17.5kg
42 RV 24.0kg

Headphone socket 3.5mm stereo

Operating condition Temperature 5°C - 35°C (41°F - 94°F)
Humidity 20% - 80% (non-condensing)

Accessories Remote control
2 batteries (AAA, IEC R03 1.5V)
Clip
Cleaning cloth (to clean the cabinet and control panel)

DVB is a registered trademark of the DVB Project

© Toshiba Information Systems (U.K.) Limited

All rights reserved.

Reproduction in whole or part without written permission is strictly prohibited.

Toshiba Information Systems (UK) Limited

Consumer Products Division,
Toshiba Court, Weybridge Business Park,
Addlestone Road, Weybridge,
Surrey, KT15 2UL, England

Specification is subject to change without notice.