



TOSHIBA
Leading Innovation >>>

26DL933B
26DL934B
DIGITAL Series

SUPPORT

 PLEASE VISIT:
WWW.TOSHIBA.CO.UK/TV-DVD-SUPPORT

 OR CONTACT THE TOSHIBA CUSTOMER
HELPLINE ON **0844 856 0730**

"Register your TV online at:
www.toshiba.co.uk/registration"



OWNER'S MANUAL

User Manual

DIGITAL Series

This standard user's manual is designed to show you how to connect and tune in your Toshiba TV and to operate the most commonly used functions.

If you want to view advanced functions for your TV you can do so by visiting

www.toshiba-om.net



“Register your TV online at: www.toshiba.co.uk/registration”

Toshiba estimates that the initiative of making the advanced functions available online rather than in this book will save over 25,000 trees per year (1.6 Million kg CO₂).

If you wish to view the advanced functions but do not have access to a computer or the internet then please contact your local owner's manual Helpline number. Contact details are shown at the back of this book.



Digital Switchover

English

When does switchover happen?

*Copeland switches on October 17, 2007



Keep this important information about how to re-tune your TV during the digital TV switchover



get set for digital



Television in the UK is going digital, bringing us all more choice and new services. Starting in late 2007 and ending in 2012, television services in the UK will go completely digital, TV region by TV region.

Please see above to find out when your area switches to digital. Digital UK is the independent, non-profit organisation leading the process of digital TV switchover in the UK.

Digital UK provides impartial information on what people need to do to prepare for the move to digital, and when they need to do it.

How the switchover affects your TV equipment:

Your new TV has a digital tuner built in, which means it is ready to receive the Freeview signal by simply plugging it into your aerial socket (check if you can get digital TV through your aerial now, or whether you'll have to wait until switchover, at www.digitaluk.co.uk).

When the TV switchover happens in your area, there are at least two occasions when you will need to re-tune your TV in order to continue receiving your existing TV channels, and also to pick up new ones. Digital UK, the body leading the digital TV switchover, will advise you when you need to re-tune during the switchover.

If you choose to connect your TV to satellite or cable with a digital box then it will not be affected by

switchover, and you won't need to re-tune. Keep this important information about how to re-tune your TV during the digitalTV switchover

How to re-tune:

As new services are broadcast it will be necessary to re-tune the television in order to view them. Auto tuning will completely retune the television and can be used to update the channel list.

- Press **MENU** button on the remote control unit.
- Select **Install and Retune** option and then select **Automatic channel scan (Retune)**.
- A screen will appear warning that previous digital programmes and settings will be deleted.
- **You must allow the television to complete the search...**
- When the search is complete the Auto tuning screen will display the total number of service found.

NOTE: Further detailed instructions on Auto tuning can be found in the TV owners manual.

If you are missing channels, it may be that they are not available in your area, or that your aerial needs upgrading.

If you have any further questions, please contact your equipment supplier or call Digital UK on 08456 50 50 50 or visit www.digitaluk.co.uk

English - 2 -





Re-tuning: TOSHIBA Freeview Products

Toshiba Digital TV

This guide can be used to help you re-tune the following product with the remote control below.

Make sure your TV is on and press 80 for the BBC News channel

English



- 1) Press **MENU** and press **◀** or **▶** to select **Install and Retune** and press **OK**. Press **▲** or **▼** to select **Automatic channel scan (Retune)** to start the process.

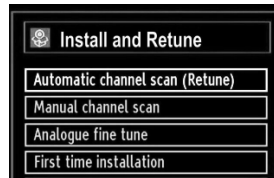

- 2) Select the desired search mode using **▶** and press **OK** button.

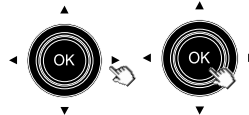

- 3) Whenever you select an automatic search type and press **OK** button, a confirmation screen will appear on the screen. To start installation process, select **Yes** by using **◀** or **▶** and **OK** button.



- 4) After auto channel scan type is set and selected and confirmed, installation process will start and progress bar will move along. The television will start to search for all available stations. You must allow the television to complete the search.

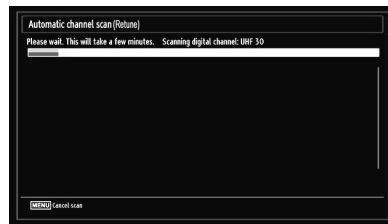

* This process may affect any saved information stored on your product. Please consult your instruction manual or contact the manufacturer using the details above.



TOSHIBA Customer Helpline: 0844 856 0730 TOSHIBA Online Support: www.toshiba.co.uk/tv-dvd-support

English - 3 -

Manual Re-tuning

English

Your guide to

Manual re-tuning

If you are comfortable with technical information and your basic re-tune hasn't worked, you can use this manual re-tune guide.

If your Freeview TV or box picks up a different regional service to your preferred service (e.g. BBC England instead of BBC Scotland, or ITV Central instead of ITV Anglia), you can use this manual re-tune. If you are missing some services you may find they have moved to channel 800 or above, this guide will help you put them in your preferred position. If you find manual re-tuning too difficult, contact your local electrical retailer or installer. This is a guide only, Freeview models operate slightly differently. Some early models do not offer a manual re-tune facility – check your instruction book. Please note: Every time you re-tune, you will need to go through this process.

1) Go to the Postcode Checker at digitaluk.co.uk Enter your postcode on the right hand side of the web page. Remember to include your house number or name. If you do not have internet access, contact the Digital UK helpline on 08456 50 50 50* and ask for manual re-tune guide support.



2) Once you have entered your address details, the next page gives you an indication of which TV services you should receive, based on your most likely transmitter. You may be able to receive television services from more than one transmitter and you can check alternatives, where available. On the results page click on the pink button to see your full reception forecast and channel information for switchover.

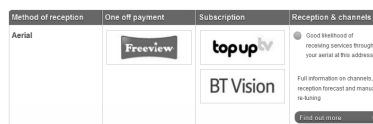

3) Click on the How do I re-tune? pink banner. Scroll down to the manual re-tune table where you will see the relevant "RF Channel" numbers for the digital services that can be received at your home.**

	Friday 19 Jun 2011	Sunday Aug 2011	7 Sep 2011 Switchover stage 1	21 Sep 2011 Switchover stage 2
	No re-tune required	No re-tune required	Re-tune required at switchover stage 1	Re-tune required at switchover stage 2
Group 1	01-52	01-52	01-47	01-47
Group 2	01-60	01-60	01-65	01-64
Group 3	01-66	01-66	01-66	Not available
Group 4	01-43	01-43	01-52	01-51
Group 5	01-58	01-58	01-58	01-52

*Calls are free for BT customers within inclusive calling plans. Call charges from other providers may vary. The standard business hours for Digital UK's contact centre are 9am to 7pm Monday to Friday and 10am to 4pm on a Saturday. Opening hours will be extended during switchover in each area. Digital UK, PO Box 26833, Kirkcaldy, KY2 9AG. **Please note that the Freeview channel line-up is subject to change.



4) Write down the "RF Channel" numbers for your transmitter using the Group boxes here:

Group 1	<input type="text"/>	Group 4	<input type="text"/>
Group 2	<input type="text"/>	Group 5	<input type="text"/>
Group 3	<input type="text"/>	Group 6	<input type="text"/>

5) Press **MENU** and use ◀ or ▶ to select **Install and Retune**.

6) Select **Manual Channel Scan** from the Installation menu and press OK.

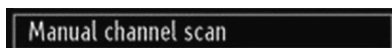

7) Select **Search Type** as **Digital** by using ◀ or ▶.

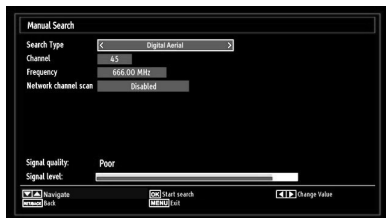

8) Select **Channel** and use ◀ or ▶ to change the channel number.

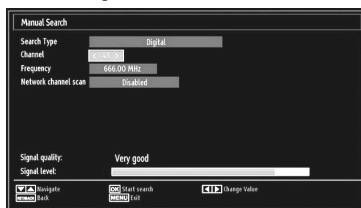

9) Press **OK** to start search.

10) Press **MENU** button. You should find that you now have your preferred service installed.



If you need any more help, contact your retailer, installer, manufacturer or the Digital UK helpline on 08456 50 50 50 *

digitaluk

English

Contents

Digital Switchover	2	Moving a Channel.....	24
Re-tuning: TOSHIBA Freeview Products.....	3	Deleting a Channel	24
Manual Re-tuning	4	Renaming a Channel.....	24
Safety Precautions	8	Locking a Channel.....	24
Air Circulation	8	Viewing Info Banner, Electronic Programme	
Heat Damage.....	8	Guide	25
Mains Supply	8	Viewing Info Banner.....	25
Warning	8	Electronic Programme Guide.....	25
Do	8	Language Selection.....	26
Do not	8	Language Settings.....	26
Installation and Important Information	9	Preferred.....	26
EXCLUSION CLAUSE.....	9	Current.....	26
Important safety information	10	Digital Settings - Parental Control, Menu Lock, Set	
Removing the pedestal stand	12	PIN.....	27
The Remote Control	13	Viewing Parental Control Menu	27
Inserting Batteries and Effective Range of the		Menu Lock	27
Remote Control.....	13	Child Lock	27
Connecting External Equipment	14	Set PIN	27
Connecting an HDMI® or DVI Device to the HDMI		Configuring Picture Settings.....	28
Input.....	15	Configuring Picture Settings	28
To Connect an HDMI Device	15	Picture Mode.....	28
To Connect a DVI Device.....	15	Contrast	28
Connecting a Computer.....	16	Brightness.....	28
To Connect a Computer.....	16	Sharpness.....	28
Connecting a DVD Player.....	16	Colour	28
Connecting to a DVD Player via YPbPr.....	16	Power Save Mode	28
Connecting a USB Memory	17	Backlight (optional)	28
Connect a USB Memory.....	17	Noise Reduction	28
USB Memory Connection	17	Advanced Settings.....	28
Power Save Mode	18	Reset	29
Environmental Information	18	Changing Picture Format.....	30
Controlling the TV.....	19	Configuring PC Picture Settings.....	31
Switching on	19	PC Picture Settings (*).....	31
Using the Remote Control	19	PC Position	31
Using the Controls and Connections on the TV...	19	Autoposition	31
Initial Installation	20	H Position	31
Auto Tuning.....	21	V Position.....	31
Auto Tuning	21	Dot Clock.....	31
Manual Tuning, Analogue Fine Tuning	22	Phase.....	31
Digital Aerial Manual Search.....	22	Configuring Sound Settings.....	32
Digital Cable Manual Search	22	Configuring Sound Settings	32
Analogue Manual Search	22	Operating Sound Settings Menu Items.....	32
Analogue Fine Tune.....	22	Volume.....	32
General Operation.....	23	Equalizer (Only for speaker).....	32
Stereo and Bilingual Transmissions.....	23	Balance (Only for speaker).....	32
Displaying Subtitles	23	Headphone	32
Viewing Main Menu	23	Sound Mode	32
Controlling Volume and Muting Sound	23	AVL	32
Selecting Programme Positions.....	23	Dynamic Bass.....	32
Standby Notifications	23	Digital Out.....	32
Channel List, Sorting Programmes, Programme		Settings Menu Operation, Conditional Access	33
Locking	24	Configuring Your TV's Settings	33
Viewing Channel List	24	Viewing Settings Menu	33
		Conditional Access	33
		Language.....	33

Parental	33
Timers	33
Date/Time Settings	33
Sources	33
Other Settings	33
Using a Conditional Access Module	33
Setting Timers, Setting Date/Time	34
Timers	34
Setting Sleep Timer	34
Setting Programme Timers	34
Configuring Date/Time Settings	34
Source Settings, Other Controls	35
Configuring Source Settings	35
Input Selection	35
Configuring Other Settings - General	35
Operation	35
Menu Timeout	35
Scan Encrypted Channels	35
Blue Background	36
Software Upgrade	36
Application Version	36
Hard of Hearing	36
Audio Description	36
Auto TV Off	36
Broadcast Type	36
Standby Search (*)	36
E-Pop	36
Teletext language	36
Manual Start	37
Auto Start	37
USB Media Browser	37
Playing MP3 Files	38
Viewing JPEG Files	38
Slideshow Feature	39
Video Playback	39
Media Browser Settings	40
To Close the Media Player	40
Analogue Text Services	41
Analogue Text Services	41
Using Text Button -TEXT	41
Accessing Sub-Pages	41
Revealing Concealed Text	41
Holding a Page	41
To display an initial page	41
Appendix A: PC Input Typical Display Modes	42
Appendix B: AV and HDMI Signal Compatibility (Input Signal Types)	43
Appendix C: Supported File Formats for USB Mode	44
Appendix D: PIN Information	44
Specifications and Accessories	45
License Information	46
Questions and Answers	47

Safety Precautions

This equipment has been designed and manufactured to meet international safety standards but, like any electrical equipment, care must be taken to obtain the best results and for safety to be assured. Please read the points below for your own safety. They are of a general nature, intended to help with all electronic consumer products and some points may not apply to the goods you have just purchased.

Air Circulation

Leave more than 10cm clearance around the television to allow adequate ventilation. This will prevent overheating and possible damage to the television. Dusty places should also be avoided.

Heat Damage

Damage may occur if the television is left in direct sunlight or near a heater. Avoid places subject to extremely high temperatures or humidity, or locations where the temperature is likely to fall below 5°C (41°F).

Mains Supply

The set should be operated only from a 220-240 V AC 50 Hz outlet. DO ensure that the television is not standing on the mains lead. DO NOT cut off the mains plug from this equipment, this incorporates a special Radio Interference Filter, the removal of which will impair its performance. In the UK, the fuse fitted in this plug is approved by ASTA or BSI to BS1362. It should only be replaced by a correctly rated and approved type and the fuse cover must be refitted. IF IN DOUBT PLEASE CONSULT A COMPETENT ELECTRICIAN.

Warning

To prevent the spread of fire, keep candles or other open flames away from this product at all times.



Do

DO read the operating instructions before you attempt to use the equipment.

DO ensure that all electrical connections (including the mains plug, extension leads and interconnections between pieces of equipment) are properly made and in accordance with the manufacturers' instructions. Switch off and withdraw the mains plug before making or changing connections.

DO consult your dealer if you are ever in doubt about the installation, operation or safety of your equipment.

DO be careful with glass panels or doors on equipment.

Do not

DON'T remove any fixed cover as this may expose dangerous voltages.

DON'T obstruct the ventilation openings of the equipment with items such as newspapers, tablecloths, curtains, etc. Overheating will cause damage and shorten the life of the equipment.

DON'T allow electrical equipment to be exposed to dripping or splashing or objects filled with liquids, such as vases, to be placed on the equipment.

DON'T place hot objects or naked flame sources, such as lighted candles or nightlights on, or close to equipment. High temperatures can melt plastic and lead to fires.

DON'T use makeshift stands and NEVER fix legs with wood screws. To ensure complete safety, always fit the manufacturers' approved stand, bracket or legs with the fixings provided according to the instructions.

DON'T leave equipment switched on when it is unattended, unless it is specifically stated that it is designed for unattended operation or has a standby mode. Switch off by withdrawing the plug, make sure your family know how to do this. Special arrangements may need to be made for people with disabilities.

DON'T continue to operate the equipment if you are in any doubt about it working normally, or it is damaged in any way - switch off, withdraw the mains plug and consult your dealer.

WARNING - excessive sound pressure from earphones or headphones can cause hearing loss.

ABOVE ALL - NEVER let anyone, especially children, push or hit the screen, push anything into holes, slots or any other openings in the case.

NEVER guess or take chances with electrical equipment of any kind - it is better to be safe than sorry.

THE MAINS PLUG IS USED AS A DISCONNECTING DEVICE AND THEREFORE SHOULD BE READILY OPERABLE.

Note : Interactive video games that involve shooting a "gun" type of joystick at the on-screen target may not work with this TV.



Installation and Important Information

Where to install

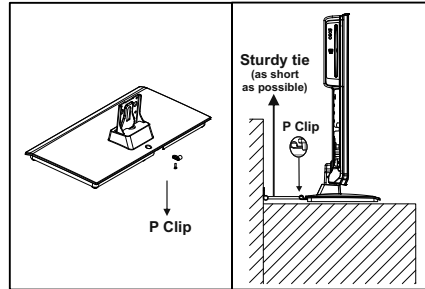

* P Clip position on TV is dependent on model.

* Button and stand style is dependent on model.

English

Locate the television away from direct sunlight and strong lights. Soft, indirect lighting is recommended for comfortable viewing. Use curtains or blinds to prevent direct sunlight falling on the screen.

Place the TV on a stable, level surface that can support the weight of the TV. In order to maintain stability and prevent it falling over, secure the TV to a wall using a sturdy tie to the clip on TV.

Install the P Clip under the stand as shown in the above illustration. The LCD display panels are manufactured using an extremely high level of precision technology; however, sometimes some parts of the screen may be missing picture elements or have luminous spots. This is not a sign of a malfunction.

Make sure the television is located in a position where it cannot be pushed or hit by objects, as pressure will break or damage the screen. Also, please be certain that small items cannot be inserted into slots or openings in the case.



Avoid using chemicals (such as air refreshers, cleaning agents, etc.) on or near the TV pedestal. Studies indicate that plastics may weaken and crack over time from the combination effects of chemical agents and mechanical stress (such as weight of TV). Failure to follow these instructions could result in serious injury and/or permanent damage to TV and TV pedestal.

Cleaning the screen and cabinet...

Turn off the power, and clean the screen and cabinet with a soft, dry cloth. We recommend that you do not use any proprietary polishes or solvents on the screen or cabinet as this may cause damage.

Please take note

The digital reception function of this television is only effective in the countries listed in the "Country" section during the first time installation menu. Depending on country/area, some of this television's functions may not be available. Reception of future additional or modified services can not be guaranteed with this television.

If stationary images generated by 4:3 broadcasts, text services, channel identification logos, computer displays, video games, on screen menus, etc. are left on the television screen for any length of time, they could become conspicuous. It is always advisable to reduce both the brightness and contrast settings.

Very long, continuous use of the 4:3 picture on a 16:9 screen may result in some retention of the image at the 4:3 outlines. This is not a defect of the LCD TV and is not covered under the manufacturer's warranty. Regular use of other size modes will prevent permanent retention.

EXCLUSION CLAUSE

Toshiba shall under no circumstances be liable for loss and/or damage to the product caused by:

- i) fire;
- ii) earthquake;
- iii) accidental damage;
- iv) intentional misuse of the product;
- v) use of the product in improper conditions;
- vi) loss and/or damage caused to the product whilst in the possession of a third party;
- vii) any damage or loss caused as a result of the owner's failure and/or neglect to follow the instructions set out in the owner's manual;
- viii) any loss or damage caused directly as a result of misuse or malfunction of the product when used simultaneously with associated equipment;

Furthermore, under no circumstances shall Toshiba be liable for any consequential loss and/or damage including but not limited to the following, loss of profit, interruption of business, the loss of recorded data whether caused during normal operation or misuse of the product.

English - 9 -



Important safety information

USE OF CONTROLS OR ADJUSTMENTS OR PERFORMANCE OF PROCEDURES OTHER THAN THOSE SPECIFIED HEREIN MAY RESULT IN HAZARDOUS RADIATION EXPOSURE.

DO NOT OPEN COVERS AND DO NOT REPAIR YOURSELF. REFER SERVICING TO QUALIFIED PERSONNEL.

Headphone Warning

Loud music can damage your hearing irreversibly. Do not set the volume to a high level when listening through headphones, particularly for extended listening periods.

Information for the DVB-T function

- Any function relative to the digital television (with the DVB logo) is available only within the country or area where such signals are transmitted. Verify with the salesperson if it is possible to receive a DVB-T signal in the zone where you live.
- Even if the television conforms to the DVB-T specifications, the compatibility to future digital DVB-T transmissions is not guaranteed.
- Some digital television functions may not be available in some countries.
- The DVB-T system present in this device is FTA (Free to air).
- DVB is a registered trademark of the DVB Project. This logo indicates that the product is compliant with European Digital Broadcasting.

Possible Adverse Effects on LCD Screen

If a fixed (non-moving) pattern remains on the LCD screen for long periods of time, the image can become permanently retained on the LCD TV panel and cause subtle but permanent ghost images. This type of damage is NOT COVERED BY YOUR WARRANTY. Never leave your TV on for long periods of time while it is displaying the following formats or images:

- Fixed Images, such as stock tickers, video game patterns, TV station logos, and websites.
- Special Formats that do not use the entire screen. For example, viewing letterbox style (16:9) media on a normal (4:3) display (Black bars at top and bottom of screen); or viewing normal style (4:3) media on a widescreen (16:9) display (Black bars on left and right sides of screen).

IMPORTANT INFORMATION

TV Installation

If a television is not positioned in a sufficiently stable location, it can be potentially hazardous due to falling. Many injuries, particularly to children, can be avoided by taking simple precautions such as:

- Only using furniture that can safely support the television.
- Ensuring the television is not overhanging the edge of the supporting furniture.
- Not placing the television on tall furniture (for example, cupboards or bookcases) without anchoring both the furniture and the television to a suitable support.
- Not standing the television on cloth or other materials placed between the television and supporting furniture.
- Educating children about the dangers of climbing on furniture to reach the television or its controls.

Place the TV on a stable, level surface that can support the weight of the TV. In order to maintain stability and prevent it from falling over, secure the TV to a wall using a sturdy tie to the clip on the back of the table top stand.

This unit has been produced according to all current safety regulations. The following safety tips should safeguard users against careless use and the dangers related to such use.

- Although this unit has been carefully manufactured and rigorously checked prior to leaving the factory as with all electrical appliances, it is possible for problems to develop. If you notice smoke, an excessive build-up of heat or any other unexpected phenomena, you should disconnect the plug from the mains power socket immediately.
- Ensure that the unit is sufficiently ventilated! Never place it next to or underneath curtains!
- This set should only be connected to a 220-240V AC 50Hz mains power supply. Do not attempt to connect it to any other type of supply.
- The socket outlet must be installed near the equipment and is easily accessible.

English - 10 -



Important safety information (continued)

- Do not open this unit. An attempt to repair the unit by a non-expert could be dangerous and potentially cause a fire hazard. All repairs must be carried out by qualified service personnel only.
- Keep away from rodents. Rodents (and also cockatiels) enjoy biting electric flexes. They can cause a short circuit (fire hazard!) and receive a fatal electric shock.
- Always hold the plug when disconnecting the unit from the socket outlet. Do not pull on flex. The flex can become overloaded and cause a short circuit.
- Use a soft, dry cloth to clean the unit.
- Set up unit so that no one will trip over the flex.
- This unit is recommended to be installed on shock-free benches in order to avoid any danger from falling.
- Take note that toddlers can pull the unit down from a table or cupboard by means of its flex. Children can hurt themselves when doing this.
- Do not use the unit near heat sources. The casing and flex could be damaged by the intensity of the heat.
- The screen is made of glass and can break if damage is done to it. Be careful when collecting sharp edged glass splinters.
- If you intend to wall mount the unit, contact the shop where you purchased the unit for advice, and leave the installation work to professionals. Improper installation can cause damage and/or injuries.
- When installing the set on a wall, allow at least 10 cm clearance between the rear of the set and the wall. Clearance of less than 10 cm will obstruct the vents and cause overheating to the interior of the set, resulting in faults or damage to the set.
- Taking fall-prevention measures
 - If these measures are not taken, the unit can fall and cause damage and/or injuries.
 - Contact the shop where you purchased the unit to obtain full details of the measures.
- When a TV stand is used,
 - Ensure the unit is fully on the stand and placed in the centre.
 - Do not leave the stand doors open. You could be hurt as a result of the unit falling or breaking, or your fingers being caught or jammed. Take extra precautions if you have children.
- Avoid placing the unit on any surfaces that may be subject to vibrations or shocks.
- To protect the unit during a thunder storm, unplug the AC power cord and disconnect the aerial.
Caution: Do not touch the aerial connector.
- When you leave your home for a long period of time, unplug the AC power cord for safety.
- The unit becomes warm when in operation. Do not place any covers or blankets on the unit in order to prevent overheating.
The ventilation holes should not be blocked. Do not set up near radiators. Do not place in direct sunshine.
- When placing on a shelf, allow at least 10 cm clearance space around the whole unit.
- The unit shall not be exposed to dripping or splashing, and no objects filled with liquids, such as vases, shall be placed on the apparatus.
- Liquids spilled into the unit can cause serious damage. Switch the set off and disconnect the mains power supply, then consult a qualified service person before attempting to use the unit again.
- Moisture condensation occurs, for example, when you pour a cold drink into a glass on a warm day and drops of water form on the outside of the glass. In the same way, moisture may condense on this unit's internal optical pick-up lens, one of the most crucial internal parts of the unit.
- Moisture condensation occurs in the following situations:
 - When you move the unit from a cold place to a warm place.
 - When you use the unit in a room where the heater was just turned on.
 - When you use the unit in an area where cold air from an air conditioner directly hits the unit.
 - When you use the unit in a humid place.
- Never use the unit when moisture condensation may occur.
- Using the unit when moisture condensation exists may damage its own internal parts and discs. Connect the power cord of the unit to the wall outlet, turn on the unit, remove the disc, and leave it for two or three hours. After two or three hours, the unit will warm up and moisture will be evaporated. Leaving the TV connected to the wall outlet will help prevent moisture condensation in the unit.
- Never place hot objects or open flame sources, such as lighted candles or night lights, on or close to the TV. High temperatures can melt plastic and lead to fires.





Removing the pedestal stand

English

When using a Wall Bracket

Please use a wall bracket appropriate for the size and weight of the LCD TV.

- Two people are required for installation.
 - To install a wall-mount from another manufacturer.
- (1) Unplug and remove any cables and/or other component connectors from the rear of the TV.
 - (2) Carefully lay the front of the unit face down on a flat, cushioned surface such as a quilt or blanket.
 - (3) Follow the instructions provided with your wall bracket. Before proceeding, make sure the appropriate bracket(s) are attached to the wall and the back of the TV as described in the instructions provided with the wall bracket.
 - (4) Always use the screws supplied or recommended by the wall mount manufacturer.

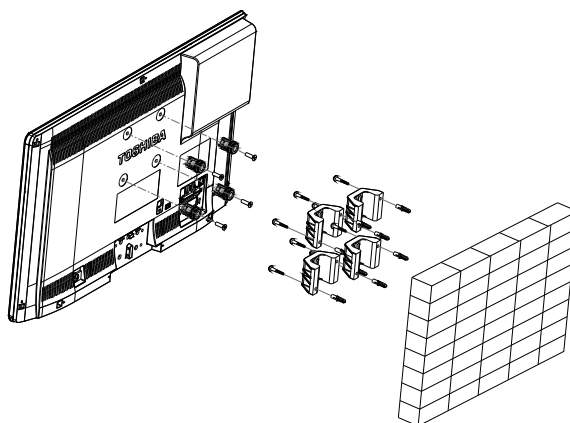

Note :

- The bracket shown above is a sample image. The bracket and fixings are not supplied with the TV.
- A brick wall should not be used.

Removing the pedestal stand

- (1) Carefully lay the front of the unit face down on a flat, cushioned surface with the stand hanging over the edge.
- (2) Remove the screws.
- (3) After the screws are removed, hold the pedestal stand in place, then remove the pedestal stand and the plastic moulding from the TV by removing away from the TV.

NOTE: Extreme care should always be used when removing the pedestal stand to avoid damage to the LCD panel.

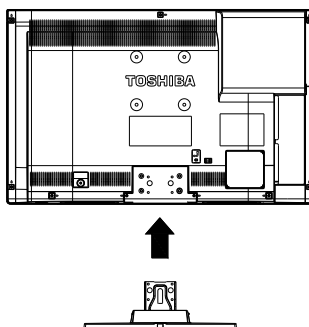

For 26DL933 and 26DL934 models

Note: Follow wall bracket instructions to fit TV to bracket. It is recommended to use screws provided.

The Remote Control

Simple at-a-glance reference of your remote control.

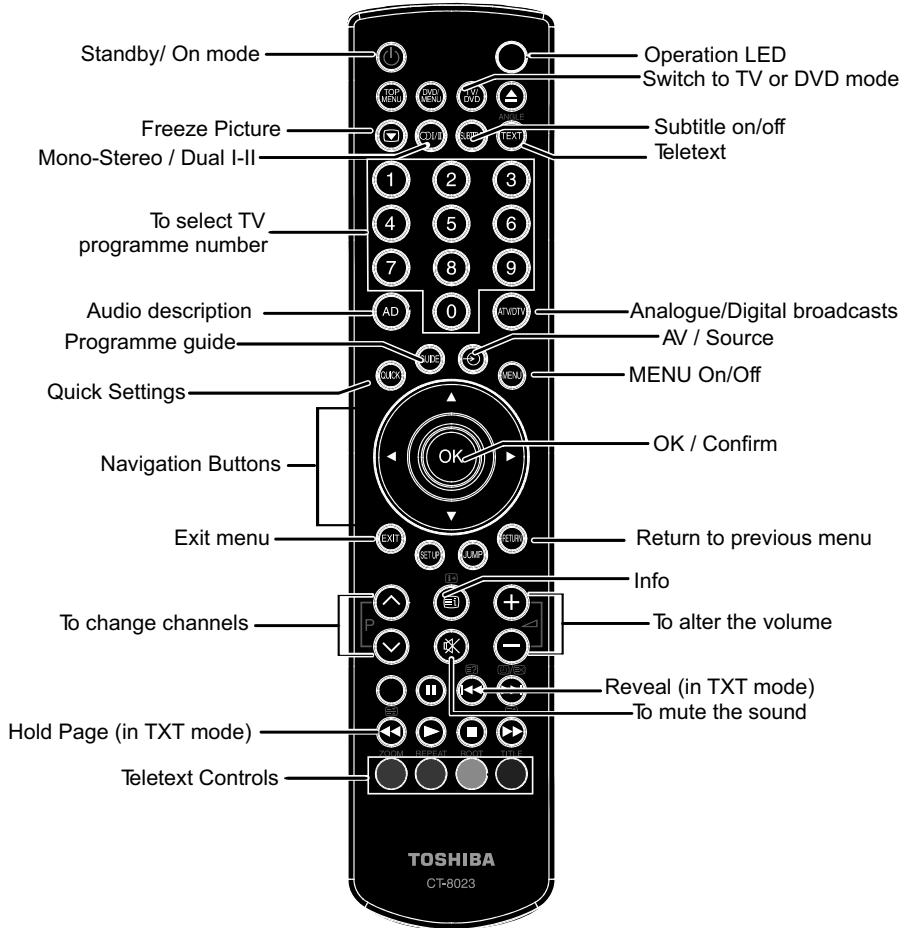

Note: Buttons that are not indicated on the remote control illustration are not functional in TV mode.

Inserting Batteries and Effective Range of the Remote Control



Remove the back cover to reveal the battery compartment and make sure the batteries are inserted the right way round. Suitable battery types for this remote are AAA, IEC R03 1.5V.

Do not combine a used, old battery with a new one or mix battery types. Remove dead batteries immediately to prevent acid from leaking into the battery compartment. Dispose of them in a designated disposal area.

Warning: Batteries must not be exposed to excessive heat such as sunshine, fire or the like.

The performance of the remote control will deteriorate beyond a distance of five metres or outside an angle of 30 degrees from the IR receiver. If the operating range becomes reduced the batteries may need replacing.

English - 13 -

Connecting External Equipment

Before connecting any external equipment, remove the mains plug from the wall socket.

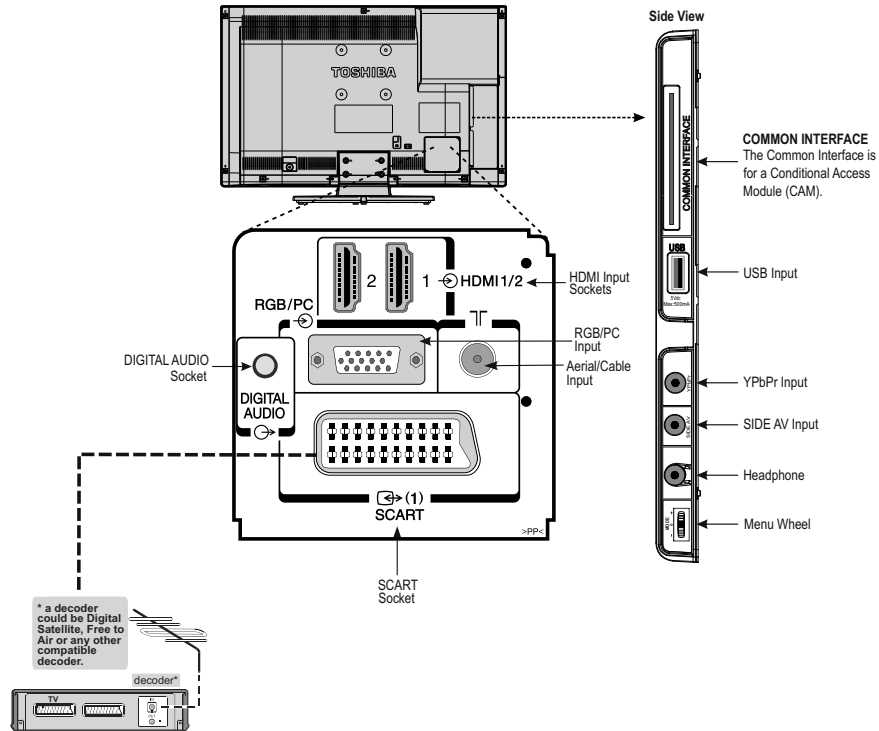

Aerial cable:.....
Connect the aerial to the ANT. socket on the rear of the TV.

SCART lead:.....
If you use a **decoder*** or a **media recorder**, it is essential that the scart cable is connected to the TV.

Before running **first time installation**, any connected devices need to be set to standby mode.

The DIGITAL AUDIO socket enables the connection of a suitable surround sound system.

HDMI® (High-Definition Multimedia Interface) is for using with a DVD decoder or other equipment with digital audio and video output. It is designed for best performance with 1080i and 1080p high-definition video signals but will also accept and display VGA, 480i, 480p, 576i, 576p and 720p signals. PC format signals will also be displayed.

NOTE: Although this TV is able to connect to HDMI equipment, it is possible that some equipment may not operate correctly.

A wide variety of external equipment can be connected to the TV; therefore, the relevant owner's manuals for all additional equipment must be referred to for exact instructions.

If the TV automatically switches over to monitor external equipment, return to normal TV by pressing the desired programme position button. To recall external equipment, press **↺** button repeatedly to switch between sources.

Regardless of source's property, audio output from the DIGITAL AUDIO socket cannot be copied.

Connecting an HDMI® or DVI Device to the HDMI Input

The HDMI inputs on your TV receive digital audio and uncompressed digital video from an HDMI source device or uncompressed digital video from a DVI (Digital Visual Interface) source device.

These inputs are designed to accept HDCP (High-Bandwidth Digital-Content Protection) programme material in digital form from EIA/CEA-861-D-compliant [1] consumer electronic devices (such as a set-top box or DVD player with HDMI or DVI output).

NOTE:

- Some early HDMI equipment may not work properly with your latest HDMI TV.
- Supported Audio format: Linear PCM, sampling rate 32/44.1/48kHz.

To Connect an HDMI Device

Connect an HDMI cable (type A connector) to the HDMI terminal. For proper operation, it is recommended that you use an HDMI cable with the HDMI Logo (HDMI).

- If your HDMI connection is capable of 1080p and/or your TV is capable of refresh rates greater than 50Hz, you will need a Category 2 cable. Conventional HDMI/DVI cable may not work properly with this mode.
- HDMI cable transfers both video and audio. Separate analogue audio cables are not required (see illustration).
- To view the HDMI device video, press  button to select HDMI1 or HDMI2.

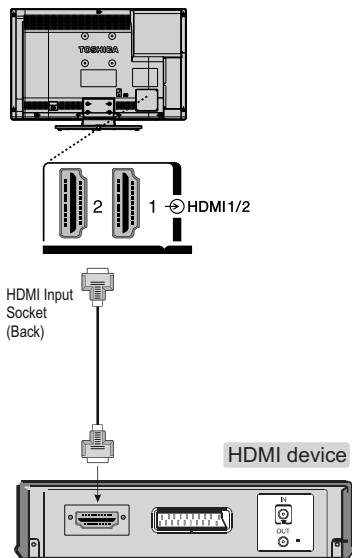

To Connect a DVI Device

Connect an HDMI-to-DVI adaptor cable (HDMI type A connector) to the HDMI input socket and audio cables to the RED and WHITE SIDE AV AUDIO inputs (see illustration).

- The recommended HDMI-to-DVI adaptor cable length is 6.6 ft (2m).
- An HDMI-to-DVI adaptor cable transfers video only. Separate analogue audio cables are required.

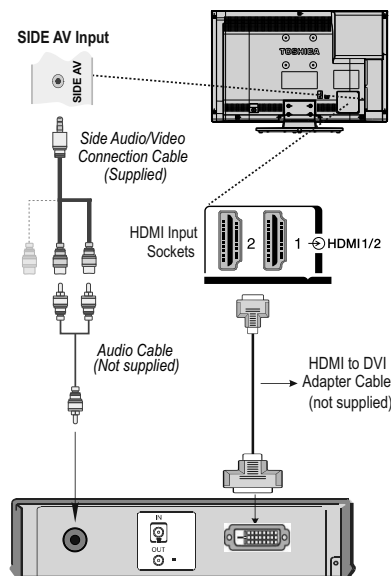

NOTE:

To ensure that the HDMI or DVI device is reset properly, it is recommended that you follow these procedures:

- When turning on your electronic components, turn on the TV first, and then the HDMI or DVI device.
- When turning off your electronic components, turn off the HDMI or DVI device first, and then the TV.

Connecting a Computer

To Connect a Computer

With either an RGB/PC or an HDMI connection, you can watch your computer's display on the TV and hear the sound from the TV's speakers.

When connecting a PC to the RGB/PC input on TV, use an analogue RGB (15-pin) computer cable and use the SIDE AV socket with a PC audio cable (not supplied) for audio connection, using the supplied Side AV connection cable's RED and WHITE inputs (see illustration).

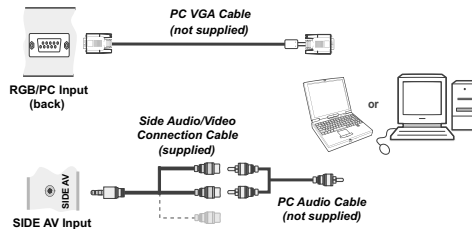

To use a PC, set the monitor output resolution on the PC before connecting it to the TV. To display the optimum picture, use the PC setting feature.

NOTE:

- Some PC models cannot be connected to this TV. An adaptor is not needed for computers with a compatible mini D-sub15-pin terminal.
- Depending on the DVD's title and the specifications of the PC on which you are playing the DVD-Video, some scenes may be skipped or you may not be able to pause during multiangle scenes.

Connecting a DVD Player

Connecting to a DVD Player via YPbPr

Some DVD players are connected through COMPONENT SOCKETS (YPbPr). In this case, you must use the supplied Component YPbPr video connection cable for enabling connection. First, plug the single jack of the cable to the TV's YPbPr socket (side). Afterwards, insert your YPbPr cable's (not supplied) connectors into the plural part of the supplied YPbPr video connection cable (see illustration below). Colours of the connected jacks should match.

To enable audio connection, use the supplied Side AV connection cable. First, plug single jack of the cable to the Side AV Input of the TV. Afterwards, insert your DVD player's audio cable's connectors into the plural part of the supplied Side AV connection cable (see illustration below). Colours of the connected jacks should match.

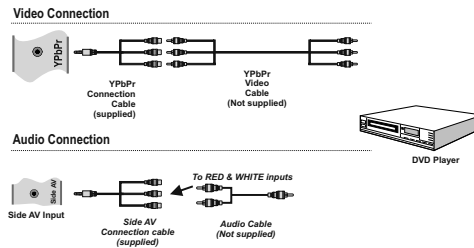

Connecting a USB Memory

Connect a USB Memory

- You can connect a USB memory to your TV by using the USB input of the TV. This feature allows you to display/play music, photo or video files stored in a USB memory.
- It is possible that certain types of USB devices (e.g. MP3 Players) may not be compatible with this TV.
- You may back up your files before making any connections to the TV set in order to avoid any possible data loss. Note that manufacturer will not be responsible for any file damage or data loss.
- Do not pull out USB memory while playing a file.

CAUTION: Quickly plugging and unplugging USB devices, is a very hazardous operation. Especially, do not repeatedly quickly plug and unplug the drive. This may cause physical damage to the USB player and especially the USB device itself.

USB Memory Connection

- Plug your USB memory to the USB input of the TV.

SIDE VIEW

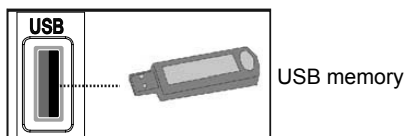

NOTE: The USB socket has limited functionality, and Toshiba can take no responsibility for damage to other connected equipment.



Power Save Mode

English

Environmental Information

- This television is designed to consume less energy to save environment.

You not only help to save the environment but also can save money by reducing electricity bills, thanks to the energy efficiency feature of this TV. To reduce energy consumption, you should take the following steps:

You can use Power Save Mode setting, located on **page 28**. If you set Power Save Mode as On, the TV will switch to energy-saving mode and luminance level of TV set will be decreased to optimum level. Note that some picture settings will be unavailable to be changed when the TV is in Power Save Mode.

Power Save Mode



Off



When the TV is not in use, please switch off or disconnect the TV from the mains plug. This will also reduce energy consumption.

- Disconnect power when going away for longer time.

Note that annually, using the TV set in Power Save Mode has more power efficiency than disconnecting the TV from the mains plug instead of keeping stand-by mode. Therefore it is highly recommended to activate Power Save Mode setting to reduce your annual power consumption. And also it is recommended to disconnect the TV from the mains plug to save energy more when you do not use.

- Please helps us to save environment by following these steps.
- This television is designed to consume less energy.
- Harmful substances and contents that are dangerous to health, are eliminated in its design.
- This product is designed to endure longer and it is subject to recycling at the end of its service life.

When the TV reaches the end of its service life, dispose the product in accordance with the proper recycling process as explained on **page 46**.

Repair Information

Please refer all servicing to qualified personnel. Only qualified personnel must repair the TV. Please contact your local dealer, where you have purchased this TV for further information.







Controlling the TV

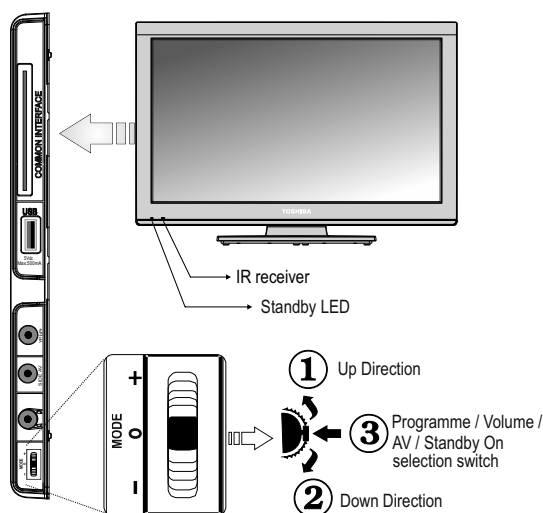

A wide variety of external equipment can be connected via the sockets located on the side and back of the TV. Whilst all the necessary adjustments and controls for the TV are made using the remote control, the button on the left side of the TV may be used for some functions.

English



Switching on

If the standby LED is unlit, check that the mains plug is connected to the power and press the middle of the  button on the left side of the TV to switch the television on. Then the LED lights up in green. If the picture does not appear, press  button on the remote control; it may take a few moments.

To put the television into Standby, press  button on the remote control. To view the television, press  button again. The picture may take a few seconds to appear.

Note: The active Standby LED may appear for a few moments when the TV is switched off.

For energy saving:

Turning the TV off at its mains supply, or un-plugging it, will cut energy use to nearly zero for all TV's. This is recommended when the TV is not being used for a long time, e.g. when on holiday.

Reducing the brightness of the screen will reduce energy use. Energy efficiency cuts energy consumption and thus saves money by reducing electricity bills.

NOTE: Putting the TV into standby mode, will reduce energy consumption, but will still draw some power.

Using the Remote Control

Press the **MENU** button on the remote control to see the menus.

The main menu appears as a group of icons each for a menu option. Press the **Left** or **Right** button to select a topic.

In sub menu screen mode the menu appears as a list. Press the **Up** or **Down** button to select a topic.

To use the options press the **Up** and **Down** buttons on the remote control to move up and down through them and **OK** button, **Left** or **Right** buttons to select the required choice. Follow the on screen instructions. The functions of each menu are described in detail throughout the manual.

Using the Controls and Connections on the TV

Using the menu wheel on the side of the TV:

To change volume: Press the middle button until the volume level OSD appears. Increase the volume by pushing the button up. Decrease the volume by pushing the button down.

To change channel: Press the middle button until the channel information banner appears. Scroll through the stored channels by pushing the button up or down

To change source: Press the middle button until the source list appears. Scroll through the available sources by pushing the button up or down.

To turn the TV off: Press the middle of the button down and hold it down for a few seconds, the TV will turn into standby mode.

Please always refer to the owner's manual of the equipment to be connected for full details.

Initial Installation

Before switching on the TV, put your decoder and media recorder to **Standby** if they are connected and ensure the aerial is connected to your TV. To set up the TV, use the buttons on the remote control as detailed on **page 13**.

IMPORTANT: Ensure that the aerial is connected and a Common Interface module is not inserted before switching on the TV for the first time installation.

1. Connect the mains plug and switch the TV to on using the side control switch. If the TV does not switch on, press any numbered or \cup button on the remote control, then the language selection menu will be displayed. This screen will appear the first time that the TV is switched on and each time the TV is reset.



2. By pressing **Up** or **Down** button, highlight the language you want to set and press **OK** button. The following message will be displayed next:



3. By pressing **Left** or **Right** button, select the **country** you want to set and press **Down** button to highlight the **Search Type** option. Use **Left** or **Right** to set the desired search type. Available search types are digital only, analog TV only and full.
4. When set, **Down** button to select Teletext Language. Use **Left** or **Right** button to select desired Teletext Language.
5. Press **OK** button on the remote control to continue and the following message will be displayed on the screen:

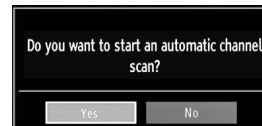

6. Select **Yes** button by using **Left** or **Right** button and press **OK** button to continue. Afterwards, the following OSD will be displayed on the screen:

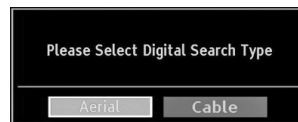

7. If you select **Cable** option, the following screen will be displayed:

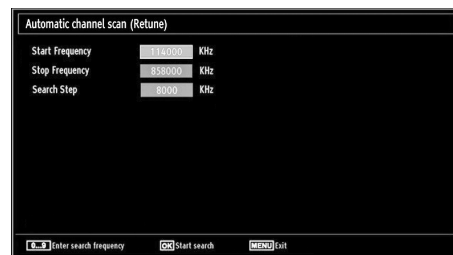

8. You can select frequency ranges from this screen. For highlighting lines you see, use **Up** or **Down** button. You can enter the frequency range manually by using the numeric buttons on the remote control. Set Start and Stop Frequency as desired by using numeric buttons on the remote control. After this operation, you can set Search Step as 8000 kHz or 1000 kHz. If you select 1000 kHz, the TV will perform search process in a detailed way. Searching duration will thus increase accordingly. When finished, press **OK** button to start automatic search.
9. If you select **Aerial** option from the Search Type screen, the television will search for broadcasts.
10. The Auto tuning screen will appear and the television will start to search for available stations. The progress bar will move along the line. You must allow the television to complete the search. The following OSD will be displayed on the screen and the television will search for the selected broadcasts:

Initial Installation - continued

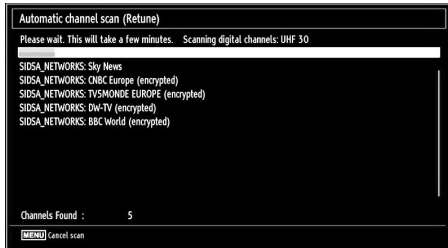

Note: You can press **MENU** button to cancel.

After the available stations are stored, Channel List will be displayed on the screen. If you like the sort channels, according to the LCN, please select **Yes** and then press **OK** button (if available).



- Press **OK** button to quit channel list and watch TV.

Note:

Do not turn off the TV while initializing first time installation.

Keep the menu of Store Mode Disabled and do not change it, when using at home.

Auto Tuning

Auto Tuning

As new services are broadcast, it will be necessary to retune the television in order to view them.

- Auto Tuning will completely retune the television and can be used to update the channel list. It is recommended that Auto Tuning is run periodically to ensure that all new services are added. All current channels and settings, i.e. locked channels, will be lost.
- Press **MENU** button on the remote control and select **Install and Retune** by using **Left** or **Right** button. Press **OK** button and the following menu screen will be displayed.



- Select **Automatic Channel Scan (Retune)** by using **Up** or **Down** button and press **OK** button. Automatic Channel Scan options will be displayed. You can select options by using **Up** or **Down** and **OK** buttons.

Auto Channel Scan Menu Operation

Digital: Searches and stores aerial DVB stations.

Analogue: Searches and stores analogue stations.

Full: Searches and stores both analogue and aerial DVB stations and both analogue and cable DVB stations.

- Whenever you select an automatic search type and press **OK** button, a confirmation screen will appear on the screen. To start installation process, select **Yes**, to cancel select **No** by using **Left** or **Right** and **OK** button.
- After auto channel scan type is set and selected and confirmed, installation process will start and progress bar will move along. Press **MENU** button to cancel process. In such a case, located channels are not stored. The television will start to search for all available stations. You must allow the television to complete the search.

Manual Tuning, Analogue Fine Tuning

The television can be tuned-in manually using Manual Search feature.

Digital Aerial Manual Search

The feature is available for service engineers or can be used for direct channel entry if the multiplex channel is known.

- Select **Manual channel scan** from the **Install and Retune** menu and press **OK**.



After selecting search type as **Digital Aerial**, you can enter the multiplex or frequency number using the numeric buttons and press **OK** button to search.

- Enter the multiplex number using the numeric buttons. The television will automatically search for that multiplex. When the multiplex is found any channels not currently on the programme list will be added and the programme information at the top of the screen will be updated.
- Repeat as necessary.

Digital Cable Manual Search

- In cable manual scan, you can enter frequency, modulation, symbol rate and network channel scan options. After selecting search type as **Digital Cable**, you can set the desired options and press **OK** button to search.

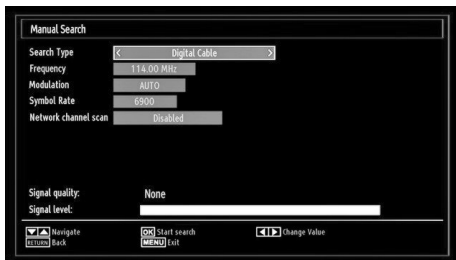

Analogue Manual Search

The television can be tuned-in manually. For example: if the television cannot be connected to a media recorder/decoder with a SCART lead or to tune-in a station on another System.

To allocate a programme position on the television for a decoder and media recorder: turn the decoder on, insert a pre-recorded film into the media recorder and press **PLAY**, then manually tune.

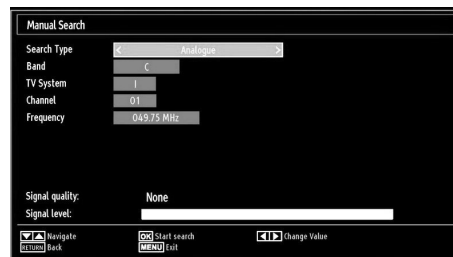

After selecting search type as **Analogue**, you can use **Up** or **Down** button to highlight an item and then press **Left** or **Right** button to set an option.

Enter the channel number or frequency using the numeric buttons. You can then press **OK** button to search. When the channel is located, any new channels that are not on the list will be stored.

Analogue Fine Tune

- Select **Analogue Fine Tune** from the **Install and Retune** menu by using **Up** or **Down** and **OK** buttons. Analogue fine tune screen will be displayed. Analogue Fine Tune feature will not be available if there are no analogue channels, only digital channels and external sources stored.
- Use **Left** or **Right** button to set Fine Tune. When finished, press **OK** button.



General Operation

Stereo and Bilingual Transmissions

If stereo or dual language broadcasts are transmitted, the word Stereo or Dual will appear on the screen each time positions are changed, disappearing after a few seconds. If the broadcast is not in stereo, the word Mono will appear.

Stereo... Press **CDI/II** to select Stereo or Mono.

Bilingual... Bilingual transmissions are rare. If they are transmitted, the word Dual will be displayed. Choose the required programme number, and if the word Dual appears, press **CDI/II**, to select Dual 1, Dual 2 or Mono.

For DTV broadcasts

To view current language and for changing to an alternative language (if available), press **AD** button. Available options will be listed.

Displaying Subtitles

In digital broadcasts, this feature will show subtitles on the screen in the selected language provided they are being broadcast.

Press **SUBTITLE** button to activate available subtitles. Press **SUBTITLE** button again to turn off subtitles.

Viewing Main Menu

• Press **MENU** button on the remote control to view main menu.

Controlling Volume and Muting Sound

Volume

Press **↵+** or **↵-** button on the remote control to adjust the volume. Move the menu wheel on the TV up or down to change the volume.

Sound Mute

Press **⊗** button once to turn the sound off and again to cancel.

Selecting Programme Positions

To select a programme position use the numeric buttons on the remote control. To change the channels using the menu wheel on the TV, first press the middle of the menu wheel and the channel info bar appears. Now move the menu wheel up or down to scroll between the stored channels.

Programme positions can also be selected using **P+** or **P-** button.

Press **ⓘ** button to display the on-screen information i.e. programme position, stereo/mono signal and picture format.

Standby Notifications

If the TV switches off while in No Signal mode, the following on-screen message will be displayed on the next switch-on:

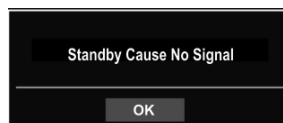

If the TV switches off owing to the auto power down feature, the following on-screen message will be displayed on the next switch-on:

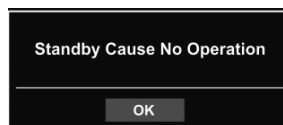

Channel List, Sorting Programmes, Programme Locking

You can view stored channels and sort them by using the Channel List feature.

Viewing Channel List

The channel order may be changed to suit your personal preference.

- Select **Channel List** from the main menu and press **OK** button. The following menu will be displayed:



- Select **Edit Channel List** to manage all stored channels. Use **Up** or **Down** and **OK** buttons to select **Edit Channel List**.



- Press **Up** or **Down** button for selecting a channel. You can press $\hat{\text{P}}$ or P button to move page up or page down.
- To watch a specific channel, highlight it by using **Up** or **Down** button. Afterwards press **OK** button.
- Press **BLUE** button to view filtering options.
- Press **MENU** button to exit.

Note: The channels listed are mixed at the channel list. Channel types can be differentiated by the icons next to them: **DTV** (digital tv), **HD** (HD TV), **ATV** (Analogue TV), **TV** (TV), **RD** (Radio), **encrypted**, **lock**, and **at the favourite list**. Listed channels can also be sorted by using the active channel list filter.

Moving a Channel

- Highlight the desired channel by using **Up** or **Down** button.
- Select **Move** option in the channel list and press **OK** button.
- Edit Number screen will be displayed. Enter the desired channel number by using the numeric buttons on the remote control. If there is a previously stored channel on that number, a warning screen

will be displayed. Select **Yes** if you want to move the channel and press **OK**.

- Selected channel is now moved.

Deleting a Channel

You can press **GREEN** button to tag/untag all channels; **YELLOW** button to tag/untag channel.

- Select the channel that you want to delete and select **Delete** option. Press **OK** button to continue.
- A warning screen will appear. Select **Yes** to delete, select **No** to cancel. Press **OK** button to continue.

Renaming a Channel

- Select the channel that you want to rename and select **Edit Name** option. Press **OK** button to continue.

- Pressing **Left** or **Right** button moves to the previous/next character. Pressing **Up** or **Down** button changes the current character. Pressing the numeric buttons '0...9' replaces the highlighted character with the characters printed above the button one by one as the button is pressed.

- When finished, press **OK** button to save. Press **MENU** to cancel.

Locking a Channel

You can press **GREEN** button to tag/untag all channels; **YELLOW** button to tag/untag a single channel.

- Select the channel that you want to lock by using **Up** or **Down** button.
- Select **Lock** option by using **Left** or **Right** button. Press **OK** button to continue.
- You will be asked to enter parental control PIN. Enter the PIN number.

Note: Default PIN is set to 0000.

- Press **OK** button when the desired channel is highlighted to lock/unlock the channel. Lock symbol will be displayed next to the selected channel.

Viewing Info Banner, Electronic Programme Guide

Viewing Info Banner

- Press **INFO** button. The information screen will appear giving details of the channel and programme currently being viewed.



- Whenever you change channel, the TV displays the broadcast picture along with an information banner at the bottom of the screen (available only in DTV mode). This will remain on the screen for a few seconds.
- If the selected channel is locked, you must enter the correct four numeric code to view the channel. "Enter PIN" will be displayed on the screen in such a case:



- Enter the 4-digit PIN number to continue.

Note: Factory set default PIN code is 0000. It is not available for France country setting.

Electronic Programme Guide

- Select the on-screen guide by pressing **GUIDE** button, the guide screen will appear highlighting details of the channel and programme currently being viewed. This may take a few moments to appear.



- For information on a highlighted programme, press **INFO** button.
- For details of other programmes currently available, press **navigation buttons** to scroll up and down or scroll left/right through the list. As channels are selected, details of the programme currently being broadcast will appear.

- To set the timer for a selected programme, press **OK** button to select Timers menu.
- Press **YELLOW** button to switch to timeline view.
- Press **GREEN** button to list the schedule.
- Press **BLUE** button to display filtering options.

Note: There are alternative views of EPG screen. Button functions will be displayed at the bottom of the menu screen.



Language Selection

English

Language Settings

Using this menu you can adjust the preferred language settings.

- Press **MENU** button and select **Settings** by using **Left** or **Right** button.
- Select Language from setup menu and press **OK** to view this menu. Press the **RETURN** button on the remote control to exit.

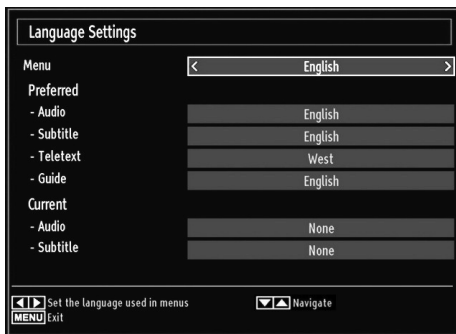

Preferred

These settings will be used if available. Otherwise the current settings will be used.

Audio: by pressing **Left** or **Right** button change the audio language.

Subtitle: alter the subtitle language with **Left** or **Right** button. The chosen language will be seen in subtitles.

Teletext: changes the preferred teletext language.

Guide: By pressing **Left** or **Right** button change the guide language.

Current

Audio: if audio language is supported, change the audio language by pressing **Left** or **Right** button.

Subtitle: if subtitle is backed up, alter the subtitle language with **Left** or **Right** button. The chosen language will be seen in subtitles.

Digital Settings - Parental Control, Menu Lock, Set PIN

You can view or set parental preferences of your TV.

Viewing Parental Control Menu

Press **MENU** button and select the **Settings** by using **Left** or **Right** button. Press **OK** button to view Settings menu. Use **Up** or **Down** button to highlight **Parental** and press **OK** to continue:



- A dialogue box asking for the lock key will be displayed. The default key is set to **0000**. Enter the PIN.
- If it is incorrect, **“Wrong PIN”** OSD will be displayed. If it is correct, the Parental Control menu will be displayed:



Menu Lock

In Menu lock you can set locking for All menus, or the Installation menu to restrict access to these menus. If the menu lock is disabled, there will be free access to the menu system.

- Use **Up** or **Down** buttons to go to Menu Lock option. Use **Left** or **Right** buttons to choose Menu Lock Mode.

OFF : All menus are unlocked.

ALL MENUS : All Menus are accessible only with the correct lock key. So the user cannot add, delete, rename, channels, cannot set timers.

INSTALLATION MENU: Installation menu is locked. So the user can't add channels.

Note: Factory set default PIN code is 0000. It is not available for France country setting.

Child Lock

Press **MENU** button and select **settings** by using **Left** or **Right** button. Press **OK** to continue. Use **Up** or **Down** to select **parental** and then press **OK** to continue. Enter the pin number. Child Lock disables the menu wheel on the television. All buttons on the remote control can still be used.

Set PIN

- Use **Up** or **Down** buttons to select **Set PIN** option. Press **OK** to display the **Set PIN** window.
- Use numeric buttons to enter new pin number. You will need to input your new pin a second time for verification purposes.
- After typing correct PIN numbers, PIN number will be changed.

Note: *The factory default pin number is 0000, if you change the pin number make sure you write it down and keep it safe.*

Configuring Picture Settings

You can configure picture settings of your TV by using Picture Settings menu.

Configuring Picture Settings

You can use different picture settings in detail. You can customize current picture mode settings as desired. For example, you can change items such as, Brightness, Contrast, Colour, Sharpness and Hue.

Press **MENU** button and select Picture by using **Left** or **Right** button. Press **OK** button to view Picture Settings menu.

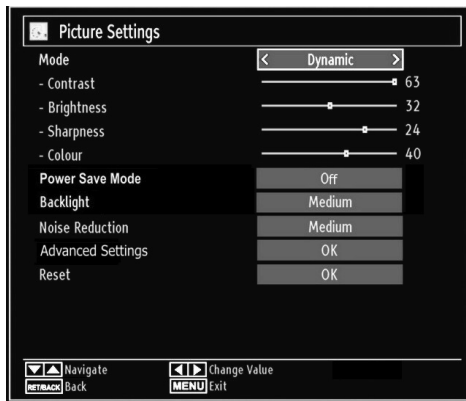

Operating Picture Settings Menu Items

- Press **Up** or **Down** button to highlight a menu item.
- Use **Left** or **Right** button to set an item.
- Press **MENU** button to exit.

Picture Mode

This TV offers the choice of personalising the picture style. **Cinema**, **Game**, **Dynamic** and **Natural** are preset options and affect settings within the TV. Press **MENU** button and select **Picture** by using **Left** or **Right** button. Press **Up** or **Down** button to select **Mode**.

- In the **Picture Settings** menu, press **Up** or **Down** button to select **Mode**. Press **Left** or **Right** button to select the picture mode you prefer.

Contrast

Sets the lightness and darkness values of the screen. Press **MENU** button and select **Picture** by using **Left** or **Right** button. Press **Up** or **Down** button to select **Contrast**.

Brightness

Sets the brightness value for the screen. Press **MENU** button and select **Picture** by using **Left** or **Right** button. Press **Up** or **Down** button to select **Brightness**.

Sharpness

Sets the sharpness value for the objects displayed on the screen. Press **MENU** button and select **Picture** by using **Left** or **Right** button. Press **Up** or **Down** button to select **Sharpness**.

Colour

Sets the colour value, adjusting the colours. Press **MENU** button and select **Picture** by using **Left** or **Right** button. Press **Up** or **Down** button to select **Colour**.

Power Save Mode

Enables or disables the power save mode. Use **Up** or **Down** button to select Power Save Mode. Press **Left** or **Right** button to set **Power Save Mode** as On or Off. See the section, *Environmental Information* in this manual for further information on **Power Save Mode**.

Note: The backlight function will be inactive if Power Save Mode is set to on.

Backlight (optional)

This setting controls the backlight level and it can be set to Auto, Maximum, Minimum and Medium.

Note: Backlight can not be activated in VGA or Media Browser mode or while picture mode is set as Game.

Noise Reduction

Sometimes some words or picture elements may become distorted or pixelated. Using the Noise Reduction feature reduces this effect by smoothing out the edges. Press **MENU** button and select **Picture** by using **Left** or **Right** button. Press **Up** or **Down** button to select **Noise Reduction**.

Advanced Settings

Some additional controls in the picture menu are grouped under the title **Advanced Settings**. To view or change, first press **Up** or **Down** button to select **Advanced Settings**. Press **OK** button to view. **Advanced Settings** menu controls are as the following:

Configuring Picture Settings - continued

Colour Temp: Colour Temperature increases the 'warmth' or 'coolness' of the picture by increasing the red or blue tint.

Picture Zoom: Sets the picture size to **Auto, 16:9, Subtitle, 14:9, 14:9 Zoom, 4:3, Panoramic** or **Cinema**. Press **MENU** button and select **Picture** by using **Left** or **Right** button. Press **Up** or **Down** button to select **Picture Zoom**.

Full Mode (optional): If you connect a device via HDMI or YPbPr connectors and set 1080i/1080p resolutions, Full Mode item will be visible.

HDMI True Black (optional): While watching from HDMI source, this feature will be visible in the Picture Settings menu.

You can use this feature to enhance blackness in the picture. You can set this feature as "On" for activating HDMI True Black mode.

Note: *HDMI True Black On/Off feature functions only when the HDMI device output is set to RGB.*

Film Mode (optional): Films are recorded at a different number of frames per second to normal television programmes. Press "▼" or "▲" buttons to select Film mode. Press "◀" or "▶" buttons to set this feature Auto or Off. Turn this feature to Auto when you are watching films to see the fast motion scenes clearly.

Colour Shift: Adjust the desired colour tone. Press **MENU** button and select **Picture** by using **Left** or **Right** button. Press **Up** or **Down** button to select **Colour Shift**.

Reset

This feature allows you to reset the current Picture Settings to the default values. Press **MENU** button and select **Picture** by using **Left** or **Right** button. Press **Up** or **Down** button to select **Reset** and press **OK** button.

Note: *The reset function does not reset the settings for Mode, Colour Temp, Noise Reduction, Picture Zoom and HDMI True Black.*

Changing Picture Format

Press **QUICK** button repeatedly to open Settings menu, press “▼” button to select Picture Zoom menu then press “◀” / “▶” buttons to select between **Auto(*)**, **16:9**, **Subtitle**, **14:9**, **14:9 Zoom**, **4:3**, **Panoramic** or **Cinema**.

Note: Using the special functions to change the size of the displayed image (i.e. changing the height/width ratio) for the purposes of public display or commercial gain may infringe on copyright laws.

Note: You can shift to screen up or down by pressing “▲”/“▼” buttons while picture zoom is selected as **Panoramic**, **14:9 Zoom**, **Cinema** or **Subtitle**.

(*) When **AUTO** is selected, the aspect ratio of the screen is adjusted by the information provided by the selected source (if available). The format being displayed in **AUTO** mode is completely independent of **WSS** information which could be included in the broadcast signal or the signal from an external device.

Note: Auto mode will only be available in **HDMI**, **YPbPr** and **DTV**.

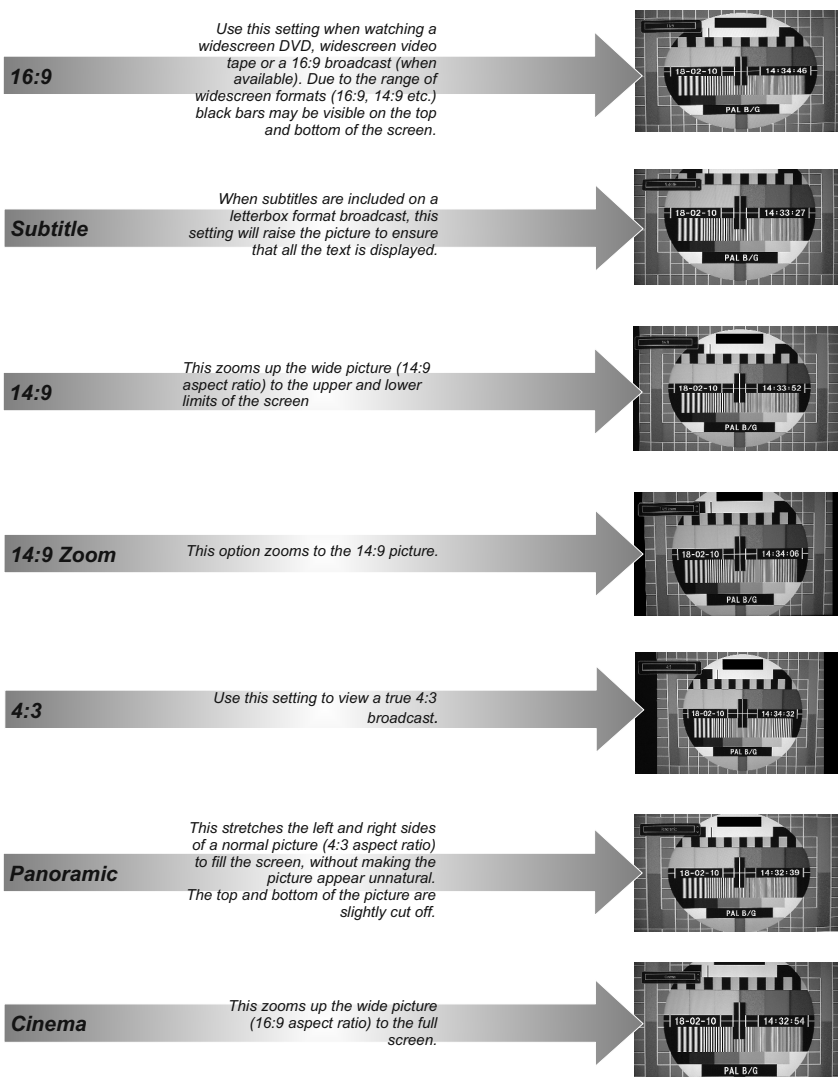

Note: Picture Zoom feature is not available for Radio channel and teletext screen.

Configuring PC Picture Settings

PC Picture Settings (*)

(*) While in VGA/PC mode, some items in Picture menu will be unavailable. Instead, VGA mode settings will be added to the Picture Settings while in VGA/PC mode.

PC Picture controls

Contrast, Brightness and Colour Temperature adjustments in this menu are identical to adjustments defined in TV picture menu.

Select **Reset** and press **OK** button to reset the adjustments.

Note:

For switching to **VGA/PC** source, press \ominus button on your remote control and select **VGA/PC** input.

Note that **VGA/PC** mode menu settings are available only while the TV is in **PC** source.

PC Position

Select this to display PC position menu items.

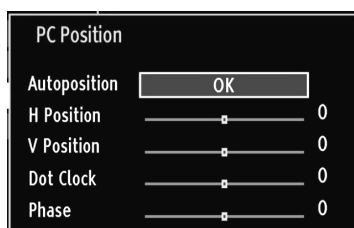

Autoposition

If you shift the picture horizontally or vertically to an unwanted position, use this item to put the picture into correct place automatically.

- Select the **PC Position** option from the main menu. Press **OK** to display the **PC Position** submenu.
- Press the **Down** button to highlight **Autoposition** and then press the **OK** button.

H Position

H (Horizontal) Position shifts the image horizontally to right hand side or left hand side of the screen.

- In the **PC Position** menu press the **Down** button until **H Position** is highlighted.
- Press the **Left** or **Right** button to adjust the value.

V Position

V (Vertical) Position shifts the image vertically towards the top or bottom of the screen.

In the **PC Position** menu press the **Down** button until **V Position** is highlighted.

Press the **Left** or **Right** button to adjust the value.

Dot Clock

Dot Clock adjustment corrects the interference that appear as vertical banding in dot intensive presentations like spreadsheets or paragraphs or text in smaller fonts.

- In the **PC Position** menu press the **Down** button until **Dot Clock** is highlighted.
- Press the **Left** or **Right** button to adjust the value.

Phase

Depending on the resolution and scan frequency that you input to the TV Set, you may see a hazy or noisy picture on the screen. In such a case you can use this item to get a clear picture by trial and error method.

- In the **PC Position** menu press the **Down** button until **Phase** is highlighted.
- Press the **Left** or **Right** button to adjust the value.

Configuring Sound Settings

You can configure sound settings of your TV by using Sound Settings menu.

Configuring Sound Settings

Sound settings can be configured according to your personal preferences.

Press **MENU** button and select **Sound** by using **Left** or **Right** button. Press **OK** button to view Sound Settings menu.

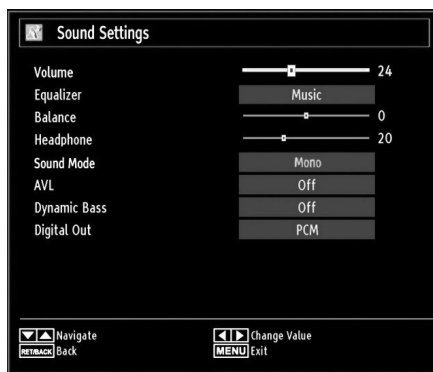

Operating Sound Settings Menu Items

- Press **Up** or **Down** button to highlight a menu item.
- Use **Left** or **Right** button to set an item.
- Press **MENU** button to exit.

Volume

Press **MENU** button and select **Sound** by using **Left** or **Right** button. Press **OK** button to continue.

Select **Volume** using **Up** or **Down** button and then use **Left** or **Right** button to set volume level.

Equalizer (Only for speaker)

You can customize current sound mode settings. Select the appropriate mode in accordance with the installation location of the TV and adjust the equalizer on-screen as desired. Press **OK** button to view equalizer submenu.

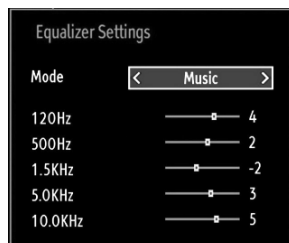

In equalizer menu, the preset can be changed to **Music**, **Movie**, **Speech**, **Flat**, **Classic** and **User**. Press the **MENU** button to return to the previous menu.

Note: Equalizer menu settings can be changed manually only when the **Equalizer Mode** is in **User**.

Balance (Only for speaker)

This setting is used for emphasizing left or right speaker balance.

- Press **Left** or **Right** button to change the level of the balance. Balance level can be adjusted between **-31** and **+31**.

Headphone

This setting is used to set the sound output when headphones are connected.

- Press **Up** or **Down** button to select **Headphone**.
- Press **Left** or **Right** button to select **Volume**. Press **Right** button to increase headphone volume level. Press **Left** button to decrease headphone volume level. Headphone volume level can be adjusted between 0 and 63.

Sound Mode

This setting is used to set the sound mode. Highlight **Sound Mode** by using **Up** or **Down** button. Press **Left** or **Right** button to set.

You can select Mono, Stereo, Dual I or Dual II mode, only if the selected channel supports that mode.

AVL

Sometimes there can be large changes in volume when switching from a DTV 5.1ch to a DTV 2ch, an ATV channel, or an external input. Using the AVL feature reduces these volume differences.

- In the **Sound** menu, press **Up** or **Down** to highlight **AVL**. Press **Left** or **Right** button to set AVL as On or Off.

Dynamic Bass

Dynamic Bass is used to increase bass effect of the TV set. Press **MENU** button and select **Sound** by using **Left** or **Right** button. Press **OK** button to continue. Select **Dynamic Bass** using **Up** or **Down** buttons and press **Left** or **Right** button to set.

Digital Out

This setting enables you to set **Digital Out** preference as **Compressed** or **PCM**. You should set this feature in accordance with the received broadcast's content. Press **MENU** button and select **Sound** by using **Left** or **Right** button. Press **OK** button to continue.

Select **Digital Out** using **Up** or **Down** button and then use **Left** or **Right** button.

Settings Menu Operation, Conditional Access

Configuring Your TV's Settings

Detailed settings can be configured to suit your personal preferences.

Viewing Settings Menu

Press **MENU** button and select **Settings** by using **Left** or **Right** button. Press **OK** button to view Settings menu.

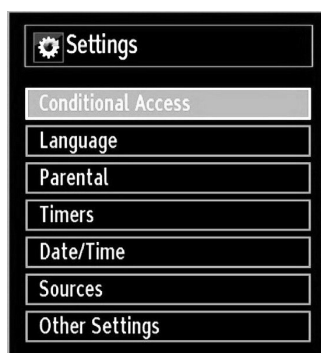

Operating Settings Menu Items

- Press **Up** or **Down** button to highlight a menu item.
- Press **OK** button to select an item.
- Press **MENU** button to exit.

Conditional Access

This setting controls conditional access modules when available. Select **Settings** from the main menu by using **Left** or **Right** button and press **OK** button. Afterwards, use **Up** or **Down** button to set **Conditional Access**. Press **OK** button to continue.

Language

Configures language settings. See page 26.

Parental

Configures parental settings. See page 27.

Timers

Sets timers for selected programmes. See page 34.

Date/Time Settings

You can configure date/time preferences by using this menu screen. See page 34.

Sources

Enables or disables selected source options. See page 35.

Other Settings

Displays other setting options of the TV set.

Using a Conditional Access Module

The *Common Interface Slot*, situated on the side of the television, enables the insertion of a CAM (Conditional Access Module) and card. These are purchased from a service provider and allow additional subscription broadcasts to be viewed. For more information, see a service provider.

IMPORTANT: Insert or remove the CI module only when the TV is SWITCHED OFF.

- In order to watch certain digital channels, a conditional access module (CAM) is necessary. This module must be inserted in the CI slot of your TV.
- Obtain the Conditional Access Module (CAM) and the viewing card by subscribing to a pay channel company, then insert those to the TV using the following procedure.
- Insert the CAM and then the viewing card to the slot that is located in the terminal cover at the rear side of the TV.
- The CAM should be correctly inserted, it is impossible to insert fully if reversed. The CAM or the TV terminal may be damaged if the CAM is forcefully inserted.

Connect the TV to the mains supply, switch on and then wait for few moments until the card is activated.

- When no module is inserted, "**No Common Interface module detected**" message appears on the screen.
- Refer to the module instruction manual for details of the settings.

Viewing Conditional Access Menu (*)

(*) *These menu settings may change depending on the service provider.*

Press **MENU** button and select **Settings** by using **Left** or **Right** button. Press **OK** button to view Settings menu. Use **Up** or **Down** button to highlight **Conditional Access** and press **OK** to view menu items.

Setting Timers, Setting Date/Time

Timers

To view Timers menu, press **MENU** button and select **Settings** by using **Left** or **Right** button. Press **OK** button to view Settings menu. Use **Up** or **Down** button to highlight **Timers** and press **OK** to continue:

Setting Sleep Timer

The television can be set to turn itself Off after a certain length of time.

- Highlight **Sleep Timer** by using **Up** or **Down** button.
- Use **Left** or **Right** button to set. The timer can be programmed between **Off** and **2.00** hours (120 minutes) in steps of 30 minutes.

Setting Programme Timers

This feature will set the television to go to a specific channel at a certain time. It can be used to view a particular programme, or by setting the mode to daily or weekly, can be used to view a series of programmes.

Press **Down** button to set timers on an event. Programme timer function buttons will be displayed on the screen.

Note: That this feature will be available only when a timer has been programmed.

Adding a Timer

- Press **YELLOW** button on the remote control to add a timer. The following menu appears on the screen:

Channel: Changes channel by using **Left** or **Right**.

Timer/Record Type: This feature is unavailable to be set.

Date: Enter a date using the numeric buttons.

Start: Enter a starting time using the numeric buttons.

End: Enter an ending time using the numeric buttons.

Duration: Displays duration between the starting and ending time.

Repeat: Sets a timer to be repeated as Once, Daily or Weekly. Use **Left** or **Right** button to select an option.

Change/Delete: Controls parental settings on timers.

- Press **GREEN** button to save the timer. Press **RED** button to cancel.

Editing a Timer

- Select the timer you want to edit by pressing **Up** or **Down** button.
- When finished with editing, press **GREEN** button to save. You can press **MENU** button to cancel.

Deleting a Timer

- Select the timer you want to delete by pressing **Up** or **Down** button.
- Press **RED** button.
- Select **Yes** by using **Left** or **Right** button to delete the timer. Select **No** to cancel.

Configuring Date/Time Settings

You can configure date/time preferences by using this menu screen.

- Select **Date/Time** in the Settings menu to configure Date/Time settings. Press **OK** button.

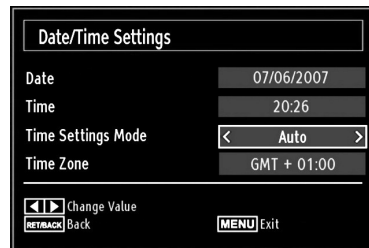

Use **▲** or **▼** button to highlight the Time Settings Mode. Time Settings Mode is set using **◀** or **▶** button. It can be set to AUTO or MANUAL.

When AUTO is selected, Date/Time and Time Zone options will not be available to be set. If MANUAL option is selected as the Time Zone can be altered:

- By pressing **▲** or **▼** button select Time Zone.

Use **◀** or **▶** button to change the Time Zone between GMT-12 or GMT+13. Date/Time on the top of the menu list will then change according to the selected Time Zone.

Note: For countries without Digital channels, only the Date and Time option will be displayed.

Source Settings, Other Controls

Configuring Source Settings

You can enable or disable selected source options. The TV will not switch to the disabled source options when \odot button is pressed.

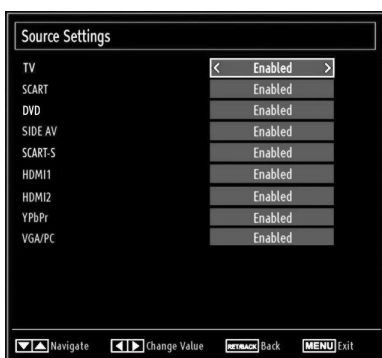

- Select **Sources** in the **Settings** menu and press **OK** button.
- Press **Up** or **Down** buttons to select a source.
- Use **Left** or **Right** button to enable or disable the selected source. Changes are automatically stored.

Input Selection

Use the Input Selection window if the television does not switch over to a connected source automatically.

- Press \odot button on your remote control for directly changing sources. Use the **Up** or **Down** button to highlight an input and press **Right** button to select.

Configuring Other Settings - General

You can configure the settings of your TV. Select **Settings** from main menu and press **OK** to view the **Settings** menu. Press the **MENU** button on the remote control to exit.

To view general configuration preferences, select **Other Settings** in the Settings menu and press **OK** button.

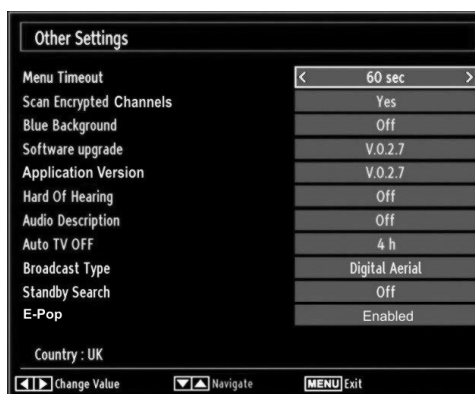

Operation

- Press **Up** or **Down** button to select an item.
- Use **Left** or **Right** button to set an option.
- Press **OK** button to view a sub-menu.

Menu Timeout

To set a specific display timeout for menu screens, set a value for this option.

In the **Other Settings** menu, select **Menu Timeout** and choose **15 sec**, **30 sec** or **60 sec** using **Left** or **Right** button.

Scan Encrypted Channels

When this setting is on, search process will locate the encrypted channels as well. If it is set as OFF manually, encrypted channels will not be located while in automatic search or manual search. Scan Encrypted Channel feature will always be ON after performing first time installation.

- In the **Other Settings** menu, use **Up** or **Down** button to select **Scan Encrypted**.
- Press **Left** or **Right** button to set this function as **Yes** or **No**.

Other Controls - continued

Blue Background

If the signal is weak or absent, the TV will automatically change to a blue screen. To enable this, set **Blue Background** to On.

- In the **Other Settings** menu, select **Blue Background** and choose On or Off using **Left** or **Right** button.

Software Upgrade

This feature helps to keep your TV updated. It works automatically and searches for new information when available. Note that this setting is inactive to be modified.

To ensure that your TV always has the most updated information, you can use this setting. In order for the proper operation, please ensure that the TV is set to standby mode.

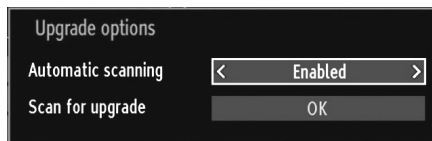

You can enable or disable automatic upgrade by setting **Automatic Scanning** option.

You can manually search for new software by selecting **Scan for upgrade**.

Application Version

Displays the current application version.

Hard of Hearing

If the broadcaster enables any special signal concerning the audio, you can set this setting as On to receive such signals.

- Use **Up** or **Down** button to select **Hard of Hearing** and then press **Left** or **Right** button to set this setting as On or Off.

Audio Description

Audio description refers to an additional narration track for blind and visually impaired viewers of visual media, including television and movies. The description narrator talks through the presentation, describing what is happening on the screen during the natural pauses in the audio (and sometimes during dialogue, if deemed necessary). You can use this feature, only if the broadcaster supports that additional narration track.

- Highlight **Audio Description** by pressing **Up** or **Down** button.
- Press **OK** button to enter Audio Description submenu.
- Use **Up** or **Down** button to select Audio Description setup and then press **Left** or **Right** button to set this setting.

Auto TV Off

You can set the timeout value of auto off feature. After the timeout value is reached and the TV is not operated for selected time, the TV will go off. Press **MENU** button and select **Settings** by using **Left** or **Right** button. Press **OK** button to continue. Use **Up** or **Down** button to select **Other Settings** and then press **OK** button. Select **Auto TV Off** using **Up** or **Down** button.

Broadcast Type

Press **MENU** button and select **Settings** by using **Left** or **Right** button. Press **OK** button to continue. Use **Up** or **Down** button to select **Other Settings** and then press **OK** button. Select **Broadcast Type** using **Up** or **Down** button and use **Left** or **Right** button to set.

When you set the desired broadcast type by using **Left** or **Right** button, the TV will display the selected broadcast type.

Standby Search (*)

(*) This setting is visible only when the **Country** option is set to **Denmark**, **Sweden**, **Norway** or **Finland**.

If the Standby Search is set to On and the TV is in standby mode, the TV will look for any changes in the saved channels. Press **MENU** button and select **Settings** by using **Left** or **Right** button. Press **OK** button to continue. Use **Up** or **Down** button to select **Other Settings** and then press **OK** button. Select **Standby Search** using **Up** or **Down** button and use **Left** or **Right** button to set.

E-Pop

If you set E-Pop to "enabled", your TV's features will be illustrated on the top of the screen.

To deactivate this feature, please set to "disabled".

Teletext language

Use this setting to set a preferred Teletext language. Press **MENU** button and select **Settings** by using **Left** or **Right** button. Press **OK** button to continue. Use **Up** or **Down** button to select **Language** and then press **OK** button. Select **Teletext** language using **Up** or **Down** button and use **Left** or **Right** button to set.

USB Media Browser

This TV allows you to enjoy photo, music or video files stored on a USB memory

Manual Start

- To display Media Browser window, you can press **MENU** button on the remote control and then select **Media Browser** by pressing **Left** or **Right** button.
- You can also select Media Browser from the Quick button menu.
- Press **OK** button to continue. Media Browser menu contents (depending on the contents of your USB memory) will be displayed.

Auto Start

- When you plug a USB memory, the following menu will be displayed.



You can play music, picture and video files from a USB memory.

- To display All files in a list, select Settings tab and change View Style to Folder. Then go back to main media browser screen and you will see that now All tab will be available. Select All tab and press **OK** button.

Note:

Some USB compliant devices may not be supported.

If the USB memory is not recognized after power off/on or First Time Installation, plug the USB memory out and power off/on the TV set. Then plug the USB memory in again.

- Do not use a USB Hub.
- You must obtain any required permission from copyright owners to use copyright content.

Toshiba cannot and does not grant such permission.

- Depending on the file size and amount in your USB memory, it may take some time for loading to view. A message will display on-screen when loading files from the USB memory.

- Only limited types of U3 USB device are supported. Therefore, it is suggested not to use U3 USB for playing Media Player.
- Non-supported characters will be replaced with a square (□).

USB Media Browser - continued

This TV allows you to enjoy photo, music or video files stored on a USB memory

Playing MP3 Files

To play mp3 files from a USB memory, you can use this menu screen.



- **▼/▲** : Navigate menu
- **Play (▶ button)**: Starts the playback.
- **Stop (■ button)** : Stops playback.
- **Pause (⏸ button)** : Pauses the selected playback.
- **RED button**: Sorts files by Title, Artist or Album.
- **Loop/Shuffle (GREEN button)**: Press once to disable Loop. Press again to disable both Loop and Shuffle. Press once more to enable only Shuffle. Press again to enable all. You can follow the disabled functions with the change of the icons.
- **0..9 (Numeric buttons)**: The TV will jump to the file starting with the letter you input via the numeric buttons on your remote control.
- **Play This (OK button)** : Plays the selected file.
- **Previous/Next (Left/Right buttons)** : Jumps to previous or next file to play.
- **Yellow button**: Change viewing style
- **BLUE button**: Changes media options.

Note: If the Viewing Style is set to Folder in Media Browser Settings, Music folder will be displayed as sorted and there is no need to sort files again by pressing RED button.

Viewing JPEG Files

To view photo files from a USB Memory, you can use this menu screen. When you select Photos from the main options, available image files will be filtered and listed on this screen.

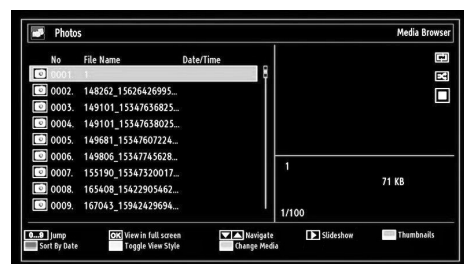

If you select a subtitle file and press **OK** button, you can select or deselect that subtitle file. The following menu will be displayed while playing a video file:

- **Jump (Numeric buttons)**: Jump to selected file using the numeric buttons.
- **OK**: Views the selected picture in full screen.
- **▼/▲** : Navigate menu
- **Slideshow (▶ button)**: Starts the slideshow using all images.
- **GREEN button**: Views images in thumbnails.
- **RED button**: Sorts files by date.
- **YELLOW button**: Change viewing style
- **BLUE button**: Changes media options.



USB Media Browser - continued

This TV allows you to enjoy photo, music or video files stored on a USB memory

English

Slideshow Feature

You can use this feature to display photos on your TV.



- **Pause (|| button)** : Pauses the slideshow.
- **Continue (▶ button)** : Continues the slideshow.
- **Loop/Shuffle (GREEN button)**: Press once to disable Loop. Press again to disable both Loop and Shuffle. Press once more to enable only Shuffle. Press again to enable all. You can follow the disabled functions with the change of the icons.
- **Previous/Next (Left/Right buttons)**: Jumps to previous or next file on slideshow.
- **Rotate (Up/Down buttons)**: Rotates the image using up/down buttons.
- **RETURN (Exit)**: Back to file list.
- **+ button**: Displays help screen.

Video Playback

When you select **Videos** from Media Browser, available video files will be filtered and listed on this screen. You can use **Up** or **Down** button to select a video file and press **OK** button to play a video.

Note: If you set **View Style** from **Media Browser Settings** menu as **'Folder'**, media browser main selection screen will include **All** tab as well.

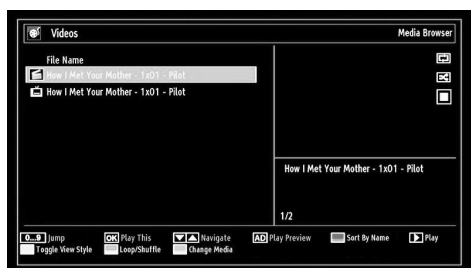

If you select a subtitle file and press **OK** button, you can select or deselect that subtitle file.

Jump (Numeric buttons):The TV will jump to the file starting with the letter you input via the numeric buttons on your remote control.

Play This (OK button) : Plays the selected file.

▼/▲ : Navigate menu

AD (Play Preview): Displays selected file in a small preview screen.

RED: Sorts files by name.

Play (▶ button) : Plays all media files starting with the selected one.

YELLOW Button: Change viewing style

Loop/Shuffle (GREEN button): Press once to disable Loop. Press again to disable both Loop and Shuffle. Press once more to enable only Shuffle. Press again to enable all. You can follow the disabled functions with the change of the icons.

BLUE: Changes media options.

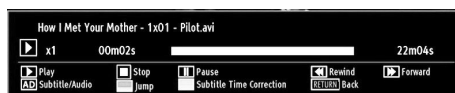

Play (▶ button): Starts the video playback.

Stop (■ button): Stops the video playback.

Pause (|| button): Pause the video playback.

Rewind (◀◀ button): Goes backward.

Forward (▶▶ button): Goes forward.

Subtitle/Audio (AD button): Sets subtitle/Audio.

Yellow: Opens subtitle time correction menu.

Ret/Back: Back to previous menu.



Press **OK** to confirm

Press **BLUE** button for clear

Press ◂/▸ button to switch back to previous menu.

Note:

You can set subtitles by using **OK** button before starting the playback or by using **AD** button during the playback. Selected subtitles may not be displayed correctly in some cases.

In order to display movie subtitles correctly, you should set a "Movie Subtitle" language. See the section, "Movie Subtitle" in "Language Settings" for selecting Movie Subtitle language.

Press **RETURN** button to switch back to previous menu.

English - 39 -





USB Media Browser - continued

This TV allows you to enjoy photo, music or video files stored on a USB memory

English

Media Browser Settings

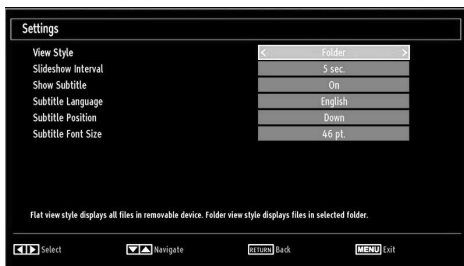

You can set your Media Browser preferences by using the **Settings** dialogue. Press **Up** or **Down** button to highlight an item and use **Left** or **Right** button to set.

View Style: Sets default browsing mode.

Slideshow Interval: Sets slide show interval time.

Show Subtitle: Sets subtitle enabling preference.

Subtitle Language: Sets supported subtitle language.

Subtitle Position: Sets subtitle position as up or down.

Subtitle Font Size: Sets subtitle font size (max. 54pt).

To Close the Media Player

- Press **MENU** button on the remote control.





Analogue Text Services

This television has a multi-page text memory, which takes a few moments to load.

English

Analogue Text Services

Before using the text services, the required language region must be chosen.

- Select **Language** from the **Settings** menu.
- Press the **Left** or **Right** button to choose the required language region.
- After the Teletext language is selected, press **MENU** button to exit.

Using Text Button -TEXT

- To view text services press **TEXT**. Press **TEXT** again to superimpose text over a normal broadcast picture.
- Press **TEXT** again to return to normal viewing.
- Programmes cannot be changed until text is cancelled.
- The first text page shown will be the initial page.
- Any text page can be accessed by entering the 3 digit page number using the numbered buttons, pressing the coloured buttons or pressing to advance to the next page and to go back to the previous page.
- Four coloured titles will appear at the base of the screen. To access one of the four given subjects, press the relevant coloured button on the remote control.
- For further information on your particular text system(s), see the broadcast text index page or, consult your local Toshiba dealer.

Below is a guide to the functions of the remote control text buttons.

Accessing Sub-Pages

If a text page has sub-pages, press and enter the sub-page numbers 01,02,03 etc. which can be selected using Left/ Right buttons at the bottom of the text page under the coloured links.

Revealing Concealed Text

To discover the solutions on quiz and joke pages press the  button.

Holding a Page

At times it is convenient to hold a page of text. Press **OK** and **HOLD** will appear in the top left of the screen. The page will be held on screen until the button is pressed again.

To display an initial page

Press **RETURN** to access an initial page. The one displayed is dependant on the broadcaster.



Appendix A: PC Input Typical Display Modes

The following table is an illustration of some of the typical video display modes. Some, due to the display native resolution, are scaled automatically to enable correct image to be displayed.

Your TV may not support different resolutions. Supported resolution modes are listed below.

If you switch your PC to an unsupported mode, a warning OSD will appear on the screen.

Index	Resolution	Frequency
1	640x350	85 Hz
2	640x400	70 Hz
3	640x480	60Hz-66Hz-72Hz -75Hz-85Hz
4	800x600	56Hz-60Hz-70Hz-72Hz -75Hz-85Hz
5	832x624	75 Hz
6	1024x768	60Hz-66Hz-70Hz-72Hz -75Hz
7	1152x864	60Hz-70Hz-75Hz -85 Hz
8	1280x768	60 HzA
9	1280x768	60 HzB
10	1280x768	75Hz-85Hz
11	1280x960	60Hz-75Hz-85Hz
12	1280x1024	60Hz-75Hz-85Hz
13	1360x768	60 Hz
14	1400x1050	60 HzA
15	1400x1050	60 HzB
16	1400x1050	75Hz-85Hz
17	1400x900	65Hz-75Hz
18	1600x1200	60 Hz
19	1680x1050	60 Hz
20	1920x1080	60 HzA
21	1920x1080	60 HzB
22	1920x1200	60HzA
23	1920x1200	60Hz

Appendix B: AV and HDMI Signal Compatibility (Input Signal Types)

English

Source	Supported Signals	
EXT (SCART)	PAL 50/60	
	NTSC 60	
	RGB 50	
	RGB 60	
Side AV	PAL 50/60	
	NTSC 60	
YPbPr	480i	60Hz
	480p	60Hz
	576i	50Hz
	576p	50Hz
	720p	50Hz
	720p	60Hz
	1080i	50Hz
	1080i	60Hz
	1080p	50Hz
	1080p	60Hz
HDMI1 HDMI2	480i	60Hz
	480p	60Hz
	576i	50Hz
	576p	50Hz
	720p	50Hz
	720p	60Hz
	1080i	50Hz
	1080i	60Hz
	1080p	24Hz
	1080p	25Hz
	1080p	30Hz
	1080p	50Hz
1080p	60Hz	

Note: In some cases a signal on the LCD TV may not be displayed properly. The problem may be an inconsistency with standards from the source equipment (DVD, Set-top box, etc.). If you do experience such a problem please contact your dealer and also the manufacturer of the source equipment.

Appendix C: Supported File Formats for USB Mode

Media	File Extension	Format		Remarks (Maximum resolution/Bit rate etc.)
		Video	Audio	
Movie	.mpg, .mpeg	MPEG1, 2	MPEG Layer 1/2/3	max 1920x1080 @ 30p 20Mbit/sec
	.dat	MPEG1, 2	MPEG2	
	.vob	MPEG2		
	.mkv	H.264, MPEG1,2,4	EAC3 / AC3	
	.mp4	MPEG4, H.264	PCM/MP3	max 1920x1080 @ 30p 20Mbit/sec
	.avi	MPEG2, MPEG4	PCM/MP3	
		H.264	PCM	
Music	.mp3	-	MPEG 1 Layer 1 / 2 (MP3)	32kbps ~ 320kbps(Bit rate) 32kHz ~ 48kHz(Sampling rate)
Photo	.jpg .jpeg	Baseline JPEG		max WxH = 15360x8640 4147200bytes
		Progressive JPEG		max WxH = 1024x768 6291456bytes
	.bmp	-		max WxH = 9600x6400 3840000bytes
Subtitle	.sub	-		-
	.srt	-		

Appendix D: PIN Information

Before connecting any external equipment, turn off all main power switches. If there is no switch, remove the mains plug from the wall socket.

Signal information for Mini D-sub 15 pin connector

Pin No.	Signal name	Pin No.	Signal name	Pin No.	Signal name
1	R	6	Ground	11	NC
2	G	7	Ground	12	NC
3	B	8	Ground	13	H-sync
4	NC*	9	NC	14	V-sync
5	NC	10	Ground	15	NC

* NC = not connected

Specifications and Accessories

Broadcast Systems/Channels

DVB-T, MPEG2, DVB-T, MPEG4 HD
 DVB-C, MPEG2, DVB-C, MPEG4

Video Input PAL, SECAM, NTSC 4.43

Stereo Nicam

External Connections

1-SCART 1	Input	21-pin SCART	RGB, A/V
2-SCART-S (via SCART 1)	Input	21-pin SCART	S-Video
3-YPbPr (via VGA)	Input	Mini D-Sub 15-Pin Analogue	
4-SIDE AV	Input	Side AV Cable input	Video + Audio L + R
5-HDMI 1/2	Input	Type A	
6-PC	Input	Mini D-Sub 15-Pin Analogue	RGB Signal
7-Digital Audio	Output	S/PDIF	(Coaxial)
8-YPbPr	Input	YPbPr Connection Jack	
USB Port		Media Browser Interface version: USB 2.0	

Headphone Socket

Operating Conditions

Supplied Accessories

3.5mm stereo
 Temperature 5°C - 35°C (41°F - 94°F)
 Humidity 20 - 80% (non-condensing)
 Remote control
 2 batteries (AAA,IEC R03 1.5V)
 8 screws
 Side AV connection cable
 YPbPr connection cable
 Stand fixing cover
 P Clip

		26"
Energy Efficiency Class		A
Visible Screen Size (approx.)		66cm / 26"
On Mode Power Consumption (approx.) (*)		29W
Annual Power Consumption (approx.) (**)		42 kWh
Standby Power Consumption (approx.)		< 0.50 W
Screen Resolution (pixels)		1366 x 768
Display		16:9
Sound Output (at 10% distortion)		2 x 6
Power Consumption Model (approx.)		65W
Weight	TV with stand	8 kg
	Gross weight	10.5 kg
	TV without stand	6.9 kg

(*) Tested in accordance with IEC 62087-BD Ed. 2.0:2008 in default settings.

(**) Energy consumption 42 kWh per year, based on the power consumption of the television operating 4 hours per day for 365 days. The actual energy consumption will depend on how the television is used.

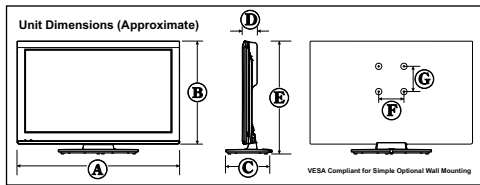

	A (mm)	B (mm)	C (mm)	D (mm)	E (mm)	F (mm)	G (mm)
26DL933B 26DL934B	644.1	407.9	174.9	59.3	447	100	100

License Information

- HDMI, the HDMI logo, and High-Definition Multimedia Interface are trademarks or registered trademarks of HDMI Licensing LLC in the United States and other countries.
- DVB is a registered trademark of the DVB Project.
- [1] EIA/CEA-861-D compliance covers the transmission of uncompressed digital video with high-bandwidth digital content protection, which is being standardized for reception of high-definition video signals. Because this is an evolving technology, it is possible that some devices may not operate properly with the television.

MP3 licence letter

MPEG Layer-3 audio coding technology licensed from Fraunhofer LLS and Thomson.

AVC licence letter

THIS PRODUCT IS LICENSED UNDER THE AVC PATENT PORTFOLIO LICENSE FOR THE PERSONAL AND NON-COMMERCIAL USE OF A CONSUMER TO (I) ENCODE VIDEO IN COMPLIANCE WITH THE AVC STANDARD ("AVC VIDEO") AND/OR (II) DECODE AVC VIDEO THAT WAS ENCODED BY A CONSUMER ENGAGED IN A PERSONAL AND NON-COMMERCIAL ACTIVITY AND/OR WAS OBTAINED FROM A VIDEO PROVIDER LICENSED TO PROVIDE AVC VIDEO. NO LICENSE IS GRANTED OR SHALL BE IMPLIED FOR ANY OTHER USE. ADDITIONAL INFORMATION MAY BE OBTAINED FROM MPEG LA, L.L.C. SEE [HTTP://WWW.MPEGLA.COM](http://www.mpegla.com)



Manufactured under license from Dolby Laboratories. Dolby and the double-D symbol are trademarks of Dolby Laboratories.



Cleaning the screen and cabinet...
Turn off the power, clean the screen and cabinet with a soft, dry cloth. We recommend that you do not use any proprietary polishes or solvents on the screen or cabinet as this may cause damage.

Disposal...

The following information is only for EU-member states:

Disposal of products
The crossed out wheeled dust bin symbol indicates that products must be collected and disposed of separately from household waste. Integrated batteries and accumulators can be disposed of with the product. They will be separated at the recycling centres.
The black bar indicates that the product was placed on the market after August 13, 2005.
By participating in separate collection of products and batteries, you will help to assure the proper disposal of products and batteries and thus help to prevent potential negative consequences for the environment and human health.
For more detailed information about the collection and recycling programmes available in your country, please contact your local city office or the shop where you purchased the product.

Disposal of batteries and/or accumulators
The crossed out wheeled dust bin symbol indicates that batteries and/or accumulators must be collected and disposed of separately from household waste.
If the battery or accumulator contains more than the specified values of lead (Pb), mercury (Hg), and/or cadmium (Cd) defined in the Battery Directive (2006/66/EC), then the chemical symbols for lead (Pb), mercury (Hg) and/or cadmium (Cd) will appear below the crossed out wheeled dust bin symbol.
By participating in separate collection of batteries, you will help to assure the proper disposal of products and batteries and thus help to prevent potential negative consequences for the environment and human health. For more detailed information about the collection and recycling programmes available in your country, please contact your local city office or the shop where you purchased the product.

In conformity with the EEE Regulation.

Questions and Answers

Q *Why is there no sound or picture?*
A Check the TV is not in standby mode.
 Check the mains plug and all mains connections.

Q *Why is there a picture but no sound?*
A Check the volume has not been turned down or that sound mute has not been selected.

Q *What can cause a poor picture?*
A Interference or a weak signal. Try a different TV station.

Q *Why doesn't the video/DVD being played show on screen?*
A Make sure the VCR or DVD player is connected to the TV as illustrated in the beginning chapters, then select the correct input by pressing .

Q *Why is the VCR/DVD picture in black and white?*
A Check the correct **input** has been chosen.

Q *Why is there a good video picture but no sound?*
A Check the SCART lead connection.

Q *Why doesn't the remote control work?*
A Check the batteries aren't dead or inserted incorrectly.

Q *Why doesn't the TV OSD settings saved?*
A Ensure to turn off the power first before attempting to unplug the AC cord. Otherwise, the settings may not be saved.

Q *Why don't the controls of the TV work?*
A Check that **CHILD LOCK** is not selected.

Q *Why is the sound only coming from one speaker when stereo sound is selected?*
A Check that the balance in the **SOUND** menu hasn't been set to one side.

Q *Why are there problems with analogue text service?*
A Good performance of the analogue text depends on a good strong broadcast signal. This normally requires a roof or loft aerial. If the text is unreadable or garbled, check the aerial. Go to the *main index* page of the analogue text service and look for the *User Guide*.

Q *What is DVB-T?*
A Digital Video Broadcast via an aerial/antenna.

Q *How are radio channels selected?*
A You can select them via the Channel List.

Q *What can be done if the PIN number has been forgotten?*
A In case of password is forgotten, Please press 1,2,7,6 or 4,7,2,5 buttons from remote control respectively in order to enter parental setting menu. Define a new pin number in Set PIN section. You will need to enter your new PIN a second time for verification purposes.

Q *Why are there horizontal stripes and/or blurred images on the screen when in PC mode?*
A The Phase may need adjustment. Select PC Settings and highlight Phase and adjust until the picture is clear.

Questions and Answers

Q Why doesn't the Media Browser feature operate?

A Make sure that USB memory is connected correctly. Incorrect behaviour may occur with a USB Hub connection.

Q Why is the digital channel locked?

A Parental control is activated. Check parental settings.

Q Why are some encrypted digital channels unavailable?

A Your subscription needs upgrading. Contact your service provider.

Q Why when digital subtitles have been selected are they not showing on screen?

A Subtitles are not currently being transmitted by the broadcaster.

Q Why is the soundtrack in English when a different audio language has been selected?

A The programme is currently being broadcast with an English soundtrack only.

Q Why does the active standby LED sometimes take longer to go out?

A When put into standby, the TV's active standby will automatically search all available channels for downloads, provided Automatic Download is enabled. The time taken to do this may vary.

EU Conformity Statement



"This product is marked with "CE" and complies therefore with the applicable harmonized European standards listed under the Low Voltage Directive 2006/95/EC and the EMC Directive 2004/108/EC."

Responsible for CE-marking is TOSHIBA EUROPE GMBH
Hammfelddamm 8, D-41460 Neuss, Germany

Contents

Features	49
General Properties.....	49
Safety Information	50
Notes on Discs	50
On handling discs	50
On cleaning.....	50
Notes on moisture condensation.....	51
Licence Notification	51
How to Watch a DVD.....	51
DVD Control Panel Buttons	51
Overview of the Remote Control	52
General Operation.....	53
General Playback	54
Basic Play	54
For your reference	54
Notes on Playback.....	54
Setup Menu Items	54
Video Setup Page.....	54
Tv Type	54
DivX® VOD	54
Language Setup Page.....	54
Osd Lang	54
Audio.....	54
Disc Menu	54
Subtitle	54
Preference Setup Page	55
Default	55
Downmix	55
Parental (Parental Level).....	55
Password (Change Password)	55
Spdif Output.....	55
Troubleshooting	55
The picture quality is poor (DVD).....	55
Disc does not play	55
Wrong OSD language.....	55
The language for the sound or subtitles on a DVD cannot be changed	55
Some functions (Angle, Zoom, etc.) do not work	56
No picture	56
No sound	56
Distorted sound.....	56
No response from remote control	56
If nothing works.....	56
Definition of Terms	56
Disc Types Compatible with This Unit	57
Supported File Formats.....	58
Specifications	58

Features

General Properties

- DVD / CD / CD-R / CD-RW / MP3 / JPEG / MPEG / DivX® playback.
- NTSC/PAL playback (according to disc content)
- LPCM audio via coaxial digital audio output. (optional)
- Multi-Audio (up to 8) support (According to disc content)
- Multi-Subtitle (up to 32) support (According to disc content)
- Multi-Angle (up to 9) support (According to disc content)
- 8 level parental control
- Fast forward and rewind in 5 different speeds. (2x, 4x, 8x, 16x, 32x)
- Slow motion playback in 4 different speeds. (1/2x, 1/4x, 1/8x, 1/16x forward)
- Frame by frame forward playback.
- Search Mode
- Repeat
- Coaxial audio output (optional)
- Copied discs may be incompatible.

Note

- This product may not support some MP3 recordings due to differences in recording formats or disc type.
- Please read the owner's manual about MP3 playback.
- CD-R/CD-RW discs recorded by CD-DA method can be played. Some CD-R/CD-RW discs may be incompatible due to laser pick-up and disc design.
- DVD-R/RW discs recorded by DVD-Video method can be played. Some DVD-R/RW discs may be incompatible due to laser pick-up and disc design.
- Some discs may be incompatible with JPEG Viewer function due to different recording format or condition of the discs.
- For proper operation, only 12 cm discs must be used.

English

Safety Information

CAUTION

DVD Player is a class 1 laser product. However this product uses a visible laser beam which could cause hazardous radiation exposure. Be sure to operate the player correctly as instructed.

**CLASS 1
LASER PRODUCT**

RISK OF ELECTRIC SHOCK

The lightning flash with arrowhead symbol, within an equilateral triangle, is intended to alert the user to the presence of uninsulated "dangerous voltage" within the product's enclosure that may be of sufficient magnitude to constitute a risk of electric shock to people.



The exclamation point within an equilateral triangle is intended to alert the user to the presence of important operating and maintenance (servicing) instructions in the literature accompanying the appliance.



Notes on Discs

On handling discs

- To keep the disc clean, handle the disc by its edge. Do not touch the surface.
- Do not stick paper or tape on the disc.
- If the disc is contaminated with any substance like glue remove before using it.

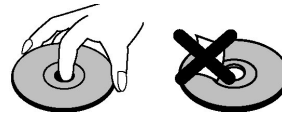

- Do not expose the disc to direct sunlight or heat sources such as hot air ducts, or leave it in a car parked in direct sunlight as the temperature can rise quickly and damage the disc.
- After playing, store the disc in its case.

On cleaning

- Before playing, clean the disc with a cleaning cloth. Wipe the disc from the center out.

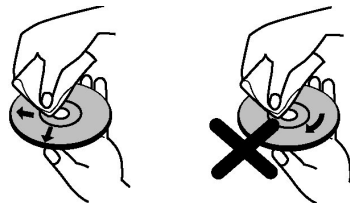

- Do not use solvents such as benzene, thinner, commercially available cleaners or anti-static spray intended for vinyl LPs.



Notes on moisture condensation

Moisture condensation damages the DVD video player. Please read the following carefully.

Moisture condensation occurs, for example, when you pour a cold drink into a glass on a warm day. Drops of water form on the outside of the glass. In the same way, moisture may condense on the optical pick-up lens inside this unit, one of the most crucial internal parts of the DVD video player.

Moisture condensation occurs during the following cases:

- When you bring the unit directly from a cold place to a warm place.
- When you use the unit in a room where you just turned on the heater, or a place where the cold wind from the air conditioner directly hits the unit.
- In summer, when you use the unit in a hot and humid place just after you move the unit from an air conditioned room.
- When you use the unit in a humid place.

Do not use the unit when moisture condensation may occur.

If you use the unit in such a situation, it may damage discs and internal parts. Remove the disc, connect the power cord of the unit to the wall outlet, turn on the unit, and leave it for two or three hours. After two or three hours, the unit will have warmed up and evaporated any moisture. Keep the unit connected to the wall outlet and moisture condensation will seldom occur.

Licence Notification

DivX®, DivX Certified® and associated logos are trademarks of DivX®, Inc. and are used under license.



ABOUT DIVX VIDEO: DivX® is a digital video format created by DivX®, Inc. This is an official DivX Certified® device that plays DivX® video. Visit divx.com for more information and software tools to convert your files into DivX® video.

ABOUT DIVX VIDEO-ON-DEMAND: This DivX Certified® device must be registered in order to play purchased DivX® Video-on-Demand (VOD) movies. To obtain your registration code, locate the DivX® VOD section in your device setup menu. Go to vod.divx.com for more information on how to complete your registration.

This product incorporates copyright protection technology that is protected by U.S. patents and other intellectual property rights. Use of this copyright protection technology must be authorized by Rovi Corporation, and is intended for home and other limited viewing uses only unless otherwise authorized by Rovi Corporation. Reverse engineering and disassembly are prohibited.

English

How to Watch a DVD

When placing a disc into the loader, labelled side of the disc should be on the front:

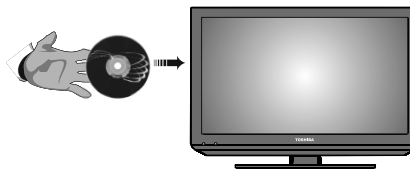

When TV set is turned on, first switch to DVD source by using the button on the remote control. Press on the remote control, or directly press button at the side panel. If there is no disc inside the loader, place a DVD first and then press .

DVD Control Panel Buttons

A. Disc loader

B. /

Plays/pauses the disc. When DVD menu (root menu) is active, this button functions as "button select" (selects the highlighted item in menu) if this is not prohibited by the disc.

C. /

Stops playing disc / Ejects the disc.

Note:

- While playing a file, you should press / button three times to eject.

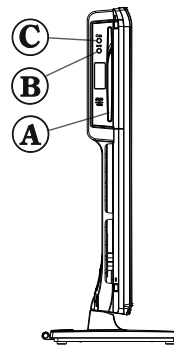

Overview of the Remote Control

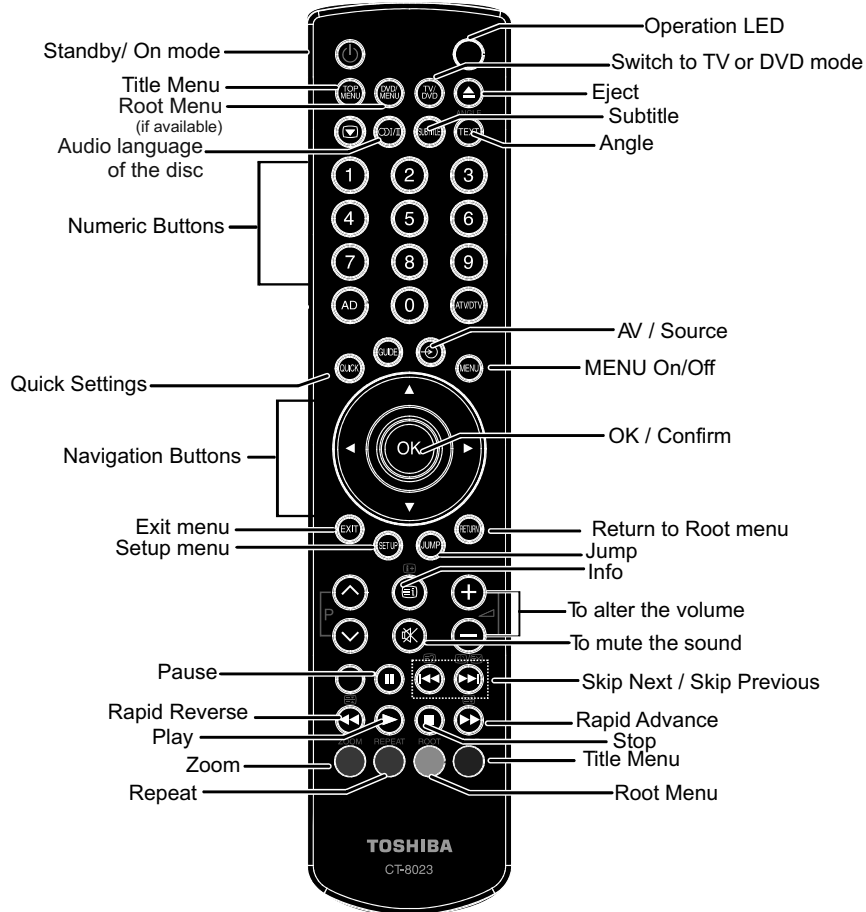

Note: Buttons that are not indicated on the remote control illustration are not functional in DVD mode.



General Operation

You can operate DVD, movie CD, music or picture CD's content by using the proper buttons on your remote control. Below are main functions of commonly used remote control buttons.

English

Buttons on the Remote Control	DVD Playback	Movie Playback	Picture Playback	Music Playback
▶	Play	Play	Play	Play
⏸	Pause	Pause	Pause	Pause
■	Stop	Stop	Stop	Stop
⏮ ⏭	Skip backward/forward	Skip backward/forward	Previous / Next	Previous / Next
◀ / ▶	Highlights a menu item. / Shifts the zoomed picture left or right (if available).			X
▼ / ▲	Highlights a menu item. / Shifts the zoomed picture up or down (if available).			
⏮ / ⏭	Rapid reverse / Rapid advance		X	Rapid reverse / Rapid advance
ANGLE	Views the scene from different angles (if available).	X	X	X
SETUP	Displays disc information / Displays DVD setup menu during stop mode.		X	Displays disc information / Displays DVD setup menu during stop mode.
⏸	Displays disc information.		X	Displays disc information.
⏮ I / II	Audio language	X	X	X
MENU	Displays main menu.			
OK	Enter / View / Play			
REPEAT	Displays repeat options.			
RETURN	Returns back to the previous menu (if available).			
ROOT	Goes back to the root folder (if available).			X
JUMP (*)	Direct selection of scenes, time or file (track) number.			
SUBTITLE	Subtitle on-off. Press repeatedly to switch between subtitle options (if available).		X	X
TITLE	Displays disc menu (if available).		X	X
ZOOM	Zooms picture. Press repeatedly to switch between zoom options.			X

Other Functions – Button Combinations (During playback)	
⏸ + ⏭	Slow forward.
[⏸ + ⏭] + ⏮ ⏭	Sets slow forward speed.
[⏸ + ⏮]	Sets slow reverse.
⏭ + ⏭	Sets rapid advance speed.
⏮ + ⏮	Sets rapid reverse speed.
■ + ■	Confirms stop command.
⏸ + ⏭	Press ⏭ repeatedly to advance manually.

(*) You can switch to title by pressing numeric keys directly. You need to press 0 and then digit key to switch one digit titles (example: to select 5, press 0 and 5).

General Playback

Basic Play

1. Press the  button.
2. Insert a disc to the loader.

The disc will be automatically loaded and play commences if the disc does not have any menus recorded on it.

A menu may appear on the TV screen after a few moments or the film may start immediately after the introduction of the Film Company. This behaviour depends on the disc content and may change.

Note: Steps 3 and 4 are available only when a menu is recorded on the disc.

3. Press navigation buttons or the numeric button(s) to select the preferred title.
4. Press **OK** button.

Play of the selected items now starts. The played item may be a motion picture, a still picture or another submenu depending on the disc.

For your reference:

If an action corresponding to a button is prohibited, the  symbol will appear.

Notes on Playback

1. No sound will be heard during Rapid advance or Rapid reverse.
2. No sound will be heard during Slow motion play.
3. In some cases, the subtitle language is not changed immediately to the selected one.
4. When the preferred language is not selected even after pressing the button several times, it means that the language is not available on the disc.
5. When the player is restarted or the disc is changed, the subtitle selection is automatically changed back to the initial settings.
6. If a language is selected, not supported by the disc, the subtitle language will automatically be set to the disc's priority language.
7. Usually a circulation will happen while switching to another language, that is you can cancel the subtitle by pressing **SUBTITLE** button a number of times until "Subtitle Off" appears on the screen.
8. When the power is turned on or the disc is removed, the language heard is the one selected at the initial settings. If this language is not recorded on the disc, only the available language on the disc will be heard.
9. Some DVDs may not contain root and/or title menus.
10. Reverse stepping is not available.

11. For your convenience:

If you attempt to enter a number greater than the total time of the current title, the time search box disappears and  "Input Invalid" message appears on up-left corner of screen.

12. Slide Show is disabled when the ZOOM mode is on.

Setup Menu Items

Video Setup Page

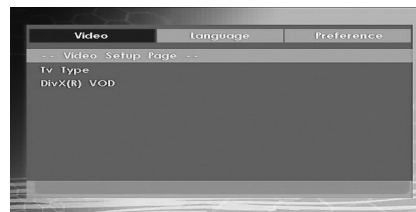

Tv Type

TV Type is only available as 'PAL'. The TV set also supports NTSC signal; however, the signal will be converted to PAL when it appears on the screen.

DivX® VOD

DivX® VOD provides the convenience of streaming video in terms of quality and performance.

Language Setup Page



Osd Lang

You can select the default OSD language of the player menus.

Audio

You can select the default audio language if supported by the DVD disc.

Disc Menu

You can select the DVD's disc menu language among these languages. Disc menu appears in the selected language, if supported by the DVD disc.

Subtitle

You can select the default subtitle language if supported by the DVD disc.

Preference Setup Page



Default

If you choose **Reset** and press **OK** button, the factory-presets are loaded. Parental level and parental password does not change.

Downmix

This mode can be selected when the DIGITAL AUDIO socket of the TV is used.

Surround: Surround sound output.

Stereo: Two channels stereo.

Parental (Parental Level)



Playing some DVDs can be limited depending on the age of users. The "Parental Control" function allows playback limitation level to be set by the parent.

Parental Level can be adjusted to one of the eight levels. Level "8 Adult" adjustment let you watch all of the DVD titles ignoring the DVD disc's parental level. You can watch the DVD discs, which has the same or lower parental level than the player's level only.

Password (Change Password):

Using this item you can change the current password.

To change the password you will be prompted to enter your old password. After you have entered your old password, you can now enter the new 4-digit password. Confirm password operation.

Note: Factory preset of the password is "0000". You have to enter XXXX digital password every time you want to change the parental level. If you forget your password please contact technical service.

Spdif Output



English

You can set **Spdif Output** as **RAW** or **PCM**. If you select **PCM** from **Spdif Output** in DVD menu and play DVD with Dolby audio, you can get audio output with two channels via the speakers and the DIGITAL AUDIO socket. If you select **RAW** from **Spdif Output** in DVD menu and play DVD with Dolby audio, speakers will be muted and you can get 5+1 Dolby audio via the DIGITAL AUDIO socket.

Troubleshooting

The picture quality is poor (DVD)

- Make sure the DVD disc surface is not damaged. (Scratch, fingerprint, etc.)
- Clean the DVD disc and try again.

See instructions described in "Notes on Discs" to clean your disc properly.

- Ensure that the DVD disc is in the loader with the label facing front.
- A damp DVD disc or condensation may effect the equipment. Wait for 1 to 2 hours in Standby to dry the equipment.

Disc does not play

- No disc in the machine.

Place a disc into the loader.

- Disc incorrectly loaded.

Ensure that the DVD disc is in the loader with the label facing front.

- Wrong type of disc. The machine cannot play CD-ROMS etc.
- The region code of the DVD must match the player.

Wrong OSD language

- Select the language in the set-up menu.

The language for the sound or subtitles on a DVD cannot be changed

- Multilingual sound and/or subtitles not recorded on the DVD.
- Try to change the sound or subtitles using DVD's title menu. Some DVD's do not allow the user to change these settings without using the disc's menu.

Some functions (Angle, Zoom, etc.) do not work

- These functions are not available on the DVD.
- Angle can only be changed when the angle symbol is displayed.

No picture

- Have you pressed the correct buttons on the remote control? Try once more.

No sound

- Check the volume is set to an audible level.
- Make sure you have not switched the sound off accidentally.

Distorted sound

- Check that the appropriate listening mode setting is correct.

No response from remote control

- Make sure the remote control is in the correct mode.
- Check batteries are fitted correctly.
- Change the batteries.

If nothing works

If you have tried the above solutions and none seem to work, try switching your TV off and on again. If this does not work, contact your supplier or TV repair technician. Never attempt to repair a defective TV yourself.

Definition of Terms

Angle

Recorded onto some DVD discs are scenes, which have been simultaneously shot from a number of different angles (the same scene is shot from the front, from the left side, from the right side, etc.). With such discs, the ANGLE button can be used to view the scene from different angles.

Chapter Number

These numbers are recorded on DVD discs. A title is subdivided into many sections, each of which are numbered, and specific parts of video presentations can be searched quickly using these numbers.

DVD

This refers to a high-density optical disc on which high-quality pictures and sound have been recorded by means of digital signals. Incorporating a new video compression technology (MPEG2) and high-density recording technology, DVD enables aesthetically pleasing full-motion video to be recorded over long periods of time (for instance, a whole movie can be recorded).

DVD has a structure consisting of two 0.6-mm thin discs, which are adhered to each other. Since the thinner the disc, the higher the density at which the information can be recorded, a DVD disc has a greater capacity than a single 1.2 mm thick disc. Since the two thin discs are adhered to each other, there is the potential to achieve double-sided play sometime in the future for even longer duration play.

Subtitles

These are printed lines appearing at the bottom of the screen, which translate or transcribe the dialogue. They are recorded on the DVD discs.

Time Number

This indicates the playtime, which has elapsed from the start of a disc or a title. It can be used to find a specific scene quickly. (Not all discs permit the time search feature to be used. Availability is determined by the disc's manufacturer.)

Title Number

These numbers are recorded on DVD discs. When a disc contains two or more movies, these movies are numbered as title 1, title 2, etc.

Track Number

These numbers are assigned to the tracks, which are recorded on Audio CDs. They enable specific tracks to be located quickly.

LPCM

LPCM stands for Linear Pulse Code Modulation and is digital audio.

MPEG

Short for Moving Picture Experts Group. This is an international standard for compression of moving images. On some DVDs digital audio has been compressed and recorded in this format.

DivX®

DivX® is a digital video compression technology based on MPEG4 and developed by DivX, Inc.

Disc Types Compatible with This Unit

English

Disc Types (Logos)	Recording Types	Disc Size	Characteristics
DVD 	Audio + Video	12 cm	<ul style="list-style-type: none"> • DVD contains excellent sound and video due to Dolby Digital and MPEG2 System • Various screen and audio functions can be easily selected through the on screen menu.
AUDIO-CD 	Audio	12 cm	<ul style="list-style-type: none"> • An LP is recorded as an analog signal with more distortion. CD is recorded as a Digital Signal with better audio quality, less distortion and less deterioration of audio quality overtime.
MP3-CD 	Audio (xxx.mp3)	12 cm	<ul style="list-style-type: none"> • Mp3 is recorded as a Digital Signal with better audio quality, less distortion and less deterioration of audio quality over time.
PICTURE-CD 	Video (still picture)	12 cm	<ul style="list-style-type: none"> • JPEG is recorded as a Digital Signal with better picture quality over time.
DivX® 	Audio + Video	12 cm	<ul style="list-style-type: none"> • Video & Audio with MPEG4 Compression technology.

Supported File Formats

Media	File Extension	Format		Remarks (Maximum resolution/Bitrate etc.)
		Video	Audio	
Movie (optional)	.mpg/ .dat/ .vob	MPEG1	MPEG Layer 1/2/3	
		MPEG2	MPEG2	
	.avi	MPEG4	PCM/MP3	
		MS ISO MPEG4	PCM/MP3	Support SP and ASP
.divx	MS ISO MPEG4	PCM/MP3	DivX 3.11, 4.x, 5.x, 6.0	
Music	-	-	PCM	Sample Rate: 8k ~ 48kHz
	.mp3	-	MPEG 1/2 Layer 1/2/3 (MP3)	Sample Rate: 8k ~ 48kHz, Bitrate: 64k~320kbps
Photo	.jpg	Baseline JPEG		WxH = 8902x8902 up to 77Mega-pixel Support format: 444/ 440/ 422/ 420/ Grayscale
		Progressive JPEG		Up to 4 Mega-pixel Support format: 444/ 440/ 422/ 420/ Grayscale
External Subtitles (optional)	.srt			Support Text File Format, but do not support Picture File Format This unit can only display a maximum of 14 Subtitles.
	.smi			
	.sub			
	.ssa			
	.ass			

Note: It is not guaranteed that all DivX® formats are supported.

Specifications

Types of Discs Supported	DVD: SS/SL 12cm (DVD-5) SS/DL 12cm (DVD-9) DS/SL 12cm (DVD-10) DS/DL 12cm (DVD-18)	CD-DA CD-R CD-RW MP3/JPEG
Video Type	MPEG2 Video Standard Decoding (MPEG1 supported) Full-Screen Video Display of 720 x 576 (PAL) & 720 x 480 (NTSC) pixels 50 and 60 Hz frame refresh rates (PAL & NTSC) Digital bitstream processing rate up to 108Mbits/sec Line resolution more than 500 lines	
Audio Type	MPEG Multichannel Decoding LPCM	
Audio Output	Analogue Outputs: 24 bit /48, 44.1kHz down-sampling DAC	

If you wish to view the advanced functions but do not have access to a computer or the internet then please contact your nearest owner's manual Helpline number from the numbers shown below.

Country name locally	Contact Number
Österreich	0810 - 144 122 (7,3 ct/min aus dem Festnetz der Telekom Austria, Mobil ggf. abweichend)
Belgique / Belgie	02 391 01 01
България	0294 21141
Hrvatska	01 653 9737
Κύπρος	22 872 111
Česká republika	323 204191
Danmark	80 88 93 38
Eesti Vabariik	69 97 800
Suomen tasavalta	0800 77 35 03
France	09 69 32 64 84
Deutschland	0431 24 89 45 50 (Ortsstarif, abweichender Mobilfunktarif möglich)
Gibraltar	200 76334
Ελληνική	210 9554298
Magyar Köztársaság	23 428 870
Ísland	00 45 80 88 93 38
Yisrā'el	03 953 5900
Italia	039 609 9301
Latvijas	00 372 69 97 800
Lietuvos	00 372 69 97 800
Luxembourg	00 32 2 391 01 01
Moldova	00380 443 511 317
Nederlanden	00 32 2 391 01 01
Norge	800 573 57
Polska	0 71 796 95 05
Portugal	707 265 265
Republic of Ireland	01 246 7780
România	021 3169 393
Россия	8 800 100 05 05
Slovensko	0042 323 204191
España	902 33 22 34
Sverige	0201 70 16 00
Schweiz / Suisse	0900 57 58 58 (CHF 1.49 / Min.)
Türkiye	0 212 340 6080
U.K.	0844 856 0730
Україна	8(044) 351 13 17

Please note the telephone number only applies to advanced owner's manual enquiries and not general operation of the TV.



"Printed on Recycled Paper" "100% Chlorine free"