

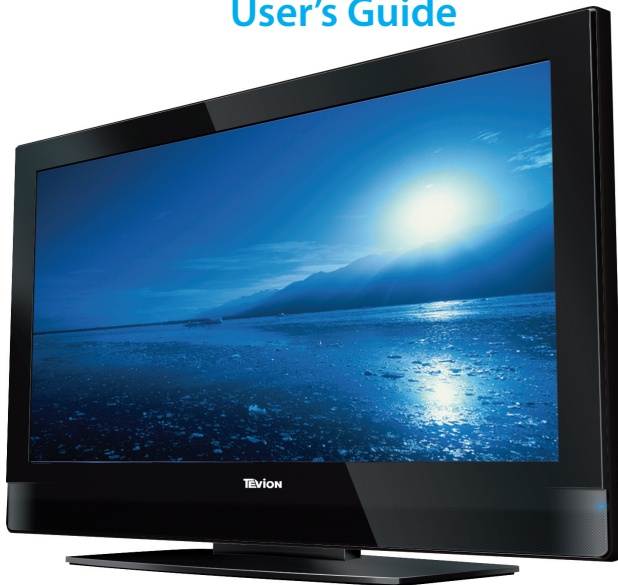

32" WIDESCREEN TV

User's Guide



After Sales Support

Now you have purchased a Tevion® product you can rest assured in the knowledge that as well as your 3 year parts and labour warranty you have the added peace of mind of dedicated helplines and web support:

AFTER SALES SUPPORT

UK / NIRELAND HELPLINE NO 0845 850 41 14

REP. IRELAND HELPLINE NO 0818 332 890

WEB SUPPORT www.tevionservice.co.uk

MODEL NUMBER: T32WLU52HD

Contents

- 03 [Welcome](#)
- 04 [General Information and Safety Instructions](#)
- 08 [Assembly and Parts List](#)
- 09 [Getting Started](#)
- 12 [Features](#)
- 15 [Instructions](#)
- 32 [Troubleshooting](#)
- 33 [Other Useful Information](#)
- 34 [Index](#)
- 36 [Memo](#)
- 39 [Warranty Card](#)

Congratulations on choosing to buy a Tevion® product. By doing so you now have the assurance and peace of mind that comes with purchasing a product made by one of Europe's leading manufacturers.

All products brought to you by Tevion® are manufactured to the highest standards of performance and safety, and, as part of our philosophy of customer service and satisfaction, are backed by our comprehensive 3 Year Warranty.

Please fill in and return the Warranty Card to the address provided. We hope you will enjoy using your purchase for many years to come.

General Information and Safety Instructions

2

LCD panels are produced with state-of-the-art technology. However, there may be missing or lit spots on the screen under certain circumstances. That does not mean that the product is faulty.

Cleaning the screen and cabinet...

After powering off, wipe the screen and the cabinet clean with a soft and dry cloth. We recommend that you do not use patented polishes or solvents on the screen or cabinet since they may cause damage.

Disposing of your TV at the end of service life...

The cold cathode fluorescent lamp found in your LCD screen contains a very small amount of mercury. Once your TV set has completed its physical life, please dispose of it in accordance with local government regulations or leave it at a recycling centre.

Important Safety Instructions



This symbol is used to warn the user about the “dangerous voltage” contained inside the housing of the product that may create a risk of electrical shock.



This symbol is used to remind the user important usage and service instructions supplied with the TV.



1) Please **READ** the operating instructions before using the TV for the first time.

2) Please observe the instructions contained in the Operating Instructions.

3) Please consider all warnings.

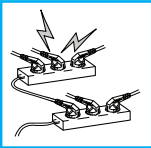

4) MAKE SURE that all power connections (extension cables and the connections between the device components) have been made properly and in accordance with the manufacturer’s instructions. Before making or changing the connections, power off the device and unplug the mains connection plug.

5) If you have any doubts regarding the installation, operation or safety of the TV, please **REFER** to the vendor.

6) BE CAREFUL with glass panels and covers on the TV. The screen glass may break and cause serious injuries if something hits it.

7) To ensure adequate ventilation, please leave a clearance area of at least 10 cm around the television. This clearance prevents the TV from overheating and consequently causing damage.

• Using the TV in dusty environments should also be avoided.

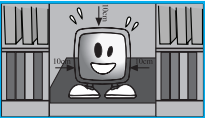

• Never block the slots and openings by placing the TV on a bed, sofa, pillow or other similar surfaces.

• Never install the TV into closed places such as bookcases or cabinets unless adequate ventilation is provided.

8) DO NOT COVER the ventilation openings of the TV with items such as newspapers, tablecloth, curtain, etc. Overheating causes damage and shortens the service life of the TV.



9) Your TV may be damaged if you place it under direct sunshine or close to a heater. Please abstain from using the TV in very hot or humid locations or in places where the temperature is likely to decrease below 5°C (41°F). **DO NOT PLACE** on or near the TV any hot objects or items with open flame such as candles or any night lamps. The high temperature can melt plastic parts and cause a fire.

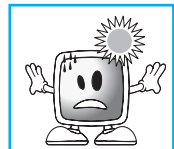

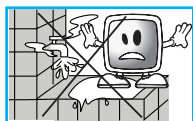

10) Never operate electrical devices close to water. Operating such devices, for example, near a bathtub, washbasin, kitchen washbasin, washing basin, wet basement and swimming pool can cause fire or electric shock.



- Do not allow your TV to get wet. Never pour any liquids onto the TV. Do not operate your TV if any solid or liquid substance enters into it. This can cause electric shock and your TV may be damaged. Have it checked immediately by qualified personnel.

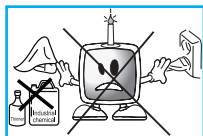

- Keep flammable materials and open flame sources (such as candles) away from TV in order to avoid risk of fire.

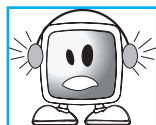

11) DO NOT USE headphones at extremely high volume levels since this may cause permanent loss of hearing.

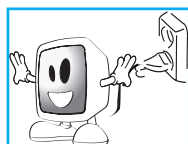

12) Operate your TV only in the 230 V 50Hz voltage range. Use the AC power cable supplied with the product. If your TV is a grounded (Class I) product, then it must certainly be connected to a grounded socket.

- **The socket into which you plug in the AC power cable must be within easy reach.**

- **Unplug the device in order to disconnect it from mains power.**

Note: Do not use defective sockets. Make sure that the plug is firmly inserted into the socket. If the plug remains loose, then it can cause fire due to arcing. Refer to an electrician to have your socket replaced.



13) Make sure that the power cable is not stepped on and that there is no bending at the plug sections, plug heads and TV output point.

14) Use only the add-ons/accessories specified by the manufacturer.



15) Use only together with the carts, bases, tripods, brackets or stands specified by the manufacturer or sold along with the product. When using a cart, pay attention that it won't overturn while carrying the cart/TV combination and cause injuries. The TV must be fixed to the floor or wall as indicated in the installation instructions in order to avoid any possible damage. Place your TV on a level surface.



16) Unplug the power cable during thunderstorms or when you will not use your device for a long period of time



17) Consult authorised service personnel for service requirements. Never attempt to repair the TV yourself. Opening the cabinet can expose you to dangerous voltages or other hazardous situations. Service is required in situations such as damage to the power cable of the TV or its plug, water spills or substances falling into the TV, the

TV is subjected to rain or moisture, it does not operate normally or it is dropped.

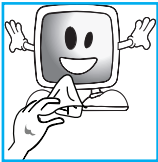

18) Wipe the TV cabinet clean with a soft and dry cloth. Wipe dust from the screen gently with a soft cloth. Stubborn stains can be cleaned with a cloth slightly moistened with soap and lukewarm water. Never use solvents such as thinner or gasoline for cleaning. Unplug the AC power cable from the socket when cleaning the TV. Otherwise, there is the risk of electric shock.

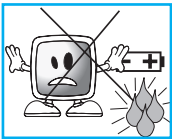

19) Do not dispose of the batteries in fire.

• **Do not short circuit, dismantle or burn the batteries. There is the risk of explosion if the batteries are not replaced correctly. Replace only with the same or equivalent type batteries.**

20) Disposing of the exhausted batteries:



• Dispose of the exhausted batteries in accordance with the local laws and regulations in order to protect our environment.

21) Do not dispose of your TV with regular household waste. Observe local laws and regulations for disposal.

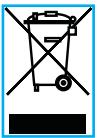

Note 1: This is a Class A product. During operation, the device can cause radio interference. In this case the user may have to remedy this. Please contact your specialist dealer.

Note 2: Electromagnetic fields can cause temporary performance degradation. This can be distinguished as noise in the image.

Assembly and Parts List

3

Remove your television carefully from its box. You can keep the packaging of your television to use in future.

Contents of the box

- 1- Power cable
- 2- Remote control
- 3- 2 batteries
- 4- User Guides
- 5- Cable Tidy (Optional)

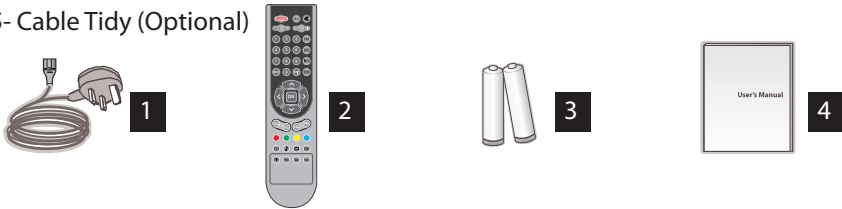

Stand Assembly Guide

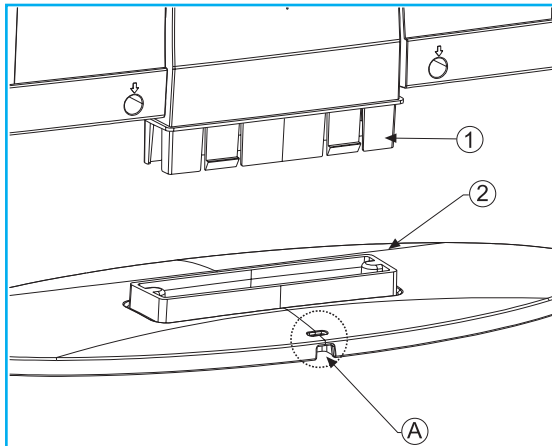

- 1- Insert the tabs of the piece no. 1 which is mounted to your television so that they will snap into the seat on the foot piece no. 2.
 - 2- This procedure must be performed so that the recessed section on the piece no. 2, indicated with an A remains at the rear side of the television.
 - 3- Stand removal is by the reverse procedure to assembly.
- Note: For stand assembly and removal lay on a non-scratch surface.

Getting Started

4

Antenna connection

If you use a 75 Ohm coaxial cable (round cable) as an antenna cable, connect the antenna plug directly to the antenna input located on the TV.

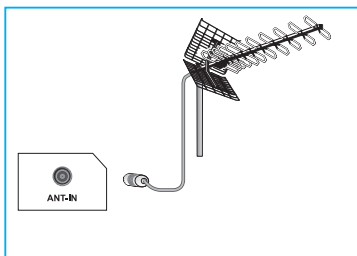

Motorized vehicles, energy lines and telecommunication lines affect your antenna. Therefore, be careful to install your antenna away from these and metal surface in such a way that it shall not swing. Do not make your antenna cable longer than required and do not coil it. Make sure that it is not crimped passing through a window or door. Your antenna and cable might be affected by natural phenomena such as rain, wind, smoke and humidity over time. Periodically check your antenna and equipment.

Batteries

Slide open the lid of the battery compartment and make sure that you have placed the batteries in the correct direction. For this remote control, UM-4, IEC R03 or AAA 1.5 V batteries are suitable. Do not throw your old batteries into the fire, discard them in a dedicated waste area for this purpose. Do not mix used batteries with new ones or different types of batteries together. The performance of the remote control will be reduced at a distance of 8 meters from or at an angle of 30 degrees beyond the centre of the TV.

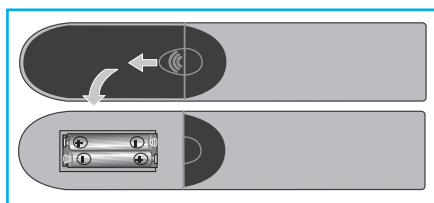

Powering on your TV and the initial use

1. Insert the power cable into the appropriate power supply input located on the back panel of the LCD TV.
2. Insert the plug of the power cable or adaptor, supplied with the TV into the mains socket.
3. Press the power on/off button located on the LCD TV.
4. To power on your television, press any numerical key or **PR+** or **PR-** keys on the remote control. For this process, you can also use the buttons on your TV. The picture will appear on the screen after a short while.

Note 1: Your TV will switch to the **stand-by** mode in five minutes if there is no broadcast signal from antenna.

Temporary on/off (STAND-BY)

When you press the red **STAND-BY** button located on the upper left hand side of your remote control while your television is switched on, the sound and the picture will go off. In the stand-by mode, the power indicator of your television will glow brighter. To switch your television back on, either press any numeric button or **PR+/PR-** buttons.

Caution! If you are not going to use your television for a long time, unplug the power cable from the socket.

Channel Selection

You may select whichever program number you would like by pressing the **PR+/PR-** buttons located on your television and your remote control. To select the programs that are above 9, you can use the Numerical buttons. You may enter the number of the program you would like to select using the numerical buttons. For example, to switch to the program number 12, press respectively the numeric buttons 1 and 2 on your remote control. You can perform the program selection also from the Program Table.

TV and AV Mode Selection

Press the **AV** button on your remote control. **SOURCE** menu will be displayed. Select **TV** or desired **AV** mode from the Source menu with **Up/Down** movement buttons and confirm with **OK** button so that your television will switch to the source you have selected.

Performing the Volume setting

You can adjust the volume of your television by using the **VOL+/VOL-** buttons on your remote control.

Temporary sound mute (MUTE)

To temporarily mute the sound of your television, press the **MUTE** button on your remote control. The **MUTE** symbol will appear on the screen. When you press the same button a second time, the sound will be restored. If you press the **VOL+** button while in the Mute mode, the sound level is increased and the Mute function is aborted.

Returning to Selected Program (SWAP)

Allows you to switch between the current program you watch and the last selected program. For example, if you change the channel to Program 11 while you were watching Program 1, press **SWAP** button to switch back to Program 1. Press **SWAP** button to switch back to Program 11 again.



Main Menu

Press the **MENU** button. The Menu including all the setting menus will appear on the screen. Navigate through the Menu titles with the **Up / Down** movement buttons and press the **OK** button to select the desired menu. If you want to exit the menu in any step, just press the **EXIT** button. Press **BACK** or **MENU** buttons to return to the previous Menu while you are in a sub menu.

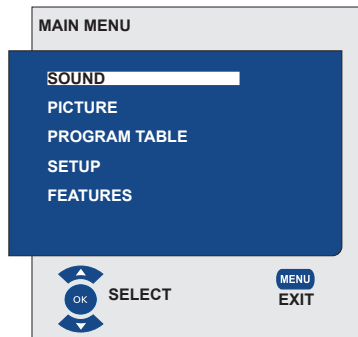

We would like this product, which has been manufactured in modern facilities in accordance with total quality principles, to offer you the best performance. Therefore, we would like you to read this entire manual carefully before you use your product and keep it for future reference.

Special Features

- 2 HDMI connection input
- HD-Ready
- HDCP feature
- Compatible with cable broadcasts
- Wide angle of vision
- Scart and AV connection
- S-VHS and Cinch inputs for S-Video connection
- PC connection
- Low energy consumption
- AVL
- SRS TruSurround sound feature.
- Programmable power on feature
- Programmable power off feature
- 100 pages Teletext
- Fasttext
- Sharpness feature in Color Transitions (CTI)
- Sharpness feature and picture resolution (LTI) in black-white transitions
- A clearer Picture made possible with a Digital Comb Filter
- DNR Noise reduction
- Returning to the last viewed program by single button (SWAP)
- On-screen viewing of all settings, program numbers and all the processes
- Manual Fine Tuning
- 100 Program memory
- Infrared remote control equipped with all functions
- Multilanguage menu option
- Parental Control
- Panel Lock
- Renaming, deleting, skipping and relocating the programs.
- Feature of viewing the NTSC broadcast via Scart input
- Easy performance of the processes with the advanced menu system
- 4:3, 16:9, 14:9, Letterbox, Subtitle and Panorama picture formats

HDMI™ HIGH DEFINITION MULTIMEDIA INTERFACE HDMI, the HDMI logo and High-Definition Multimedia Interface are trademarks or registered trademarks of HDMI Licensing LLC.

SRS TruSurround XT TruSurround is a registered trademark of the SRS Labs. Inc.

TruSurround XT technology is covered under the license of SRS Labs. Inc.

TV Control Panel

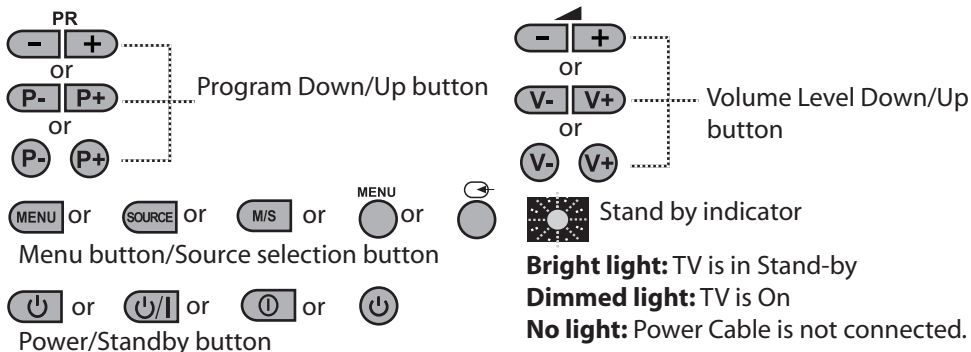

Rear and Side External Connections

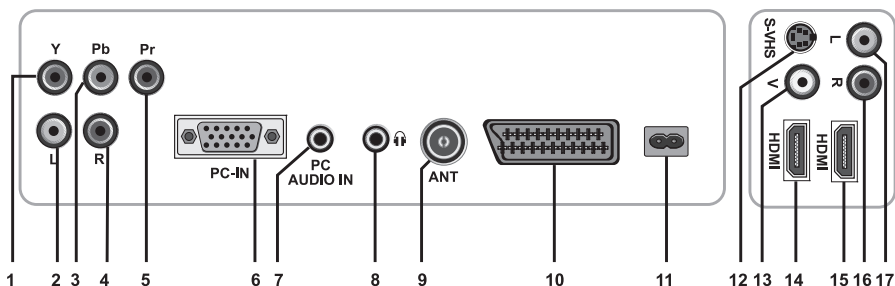

- | | |
|-------------------------------|---|
| 1- Component video input (Y) | 10- AV scart input |
| 2- Component audio input (L) | 11- Power input |
| 3- Component video input (Pb) | 12- S-VHS input |
| 4- Component audio input (R) | 13- Video input CINCH connector |
| 5- Component video input (Pr) | 14- HDMI 1 input |
| 6- VGA (PC connection input) | 15- HDMI 2 input |
| 7- PC audio input | 16- Sound input CINCH connector (Right/R) |
| 8- Headphone input | 17- Sound input CINCH connector (Left/L) |
| 9- Antenna input | |

Note 1: RGB input via Scart offers the best picture quality.



































Note 2: Above drawing for external connections is representational. Their order and places on your TV may be different.

Please see Technical Specifications Table on page 33 for the available external connections on your television.

Remote Control



Note: When no menu is open on the screen, **Up/Down** movement buttons function as program **forward/backward** buttons, and **left/right** movement buttons perform Volume **up/down** functions.

-  Stand-by mode On/Off button
-  Temporary sound mute (Mute) button
-  Source menu button
-  Picture Format selection button
-  ZOOM mode selection button
-  Numeric buttons
-  Page Stop button in Txt mode (Hold)
-  Question/Answer button in Txt mode (Reveal)
-  Information button
-  Index page button in Txt mode
-  MENU button
-  Exit menu button
-  Return to previous menu button
-  Up movement button (Menu)
-  Next page selection button in Txt mode
-  Down movement button (Menu)
-  Previous page selection button in Txt mode
-  Right / Left movement buttons (Menu)
-  Menu selection confirm
-  Volume down button
-  Volume up button
-  Program forward selection button
-  Program backward selection button
-  Red teletext button
-  Green teletext button
-  Yellow teletext button
-  Blue teletext button
-  Teletext/Mix selection button
-  Sound Mode selection button
-  Teletext page enlarge button (Double)
-  Picture Mode selection button
-  Page update button in Txt mode (Update)
-  Last viewed program selection button
-  Sub page button in Txt mode (Sub Page)
-  Time display button

Turning on the TV and Setting the Channels

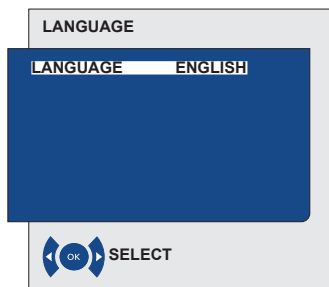

LANGUAGE menu will be displayed on the screen when you turn on your television for the first time. Select the language you would like to use on your television and press **OK** button to continue. **COUNTRY SELECTION** menu will be displayed.

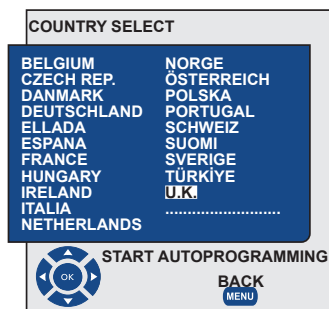

If the antenna connections are made properly, select the country with **Up/Down, Left/Right** movement buttons and press **OK** button to start autoprogramming. At the same moment, the marker indicating the progress of the autoprogramming will be displayed. The Program Table, which will allow you to sort the channels as you wish, will be displayed after the search is complete.

Automatic tuning of channels and storing in the memory

You can either tune the programs Automatically or Manually and store them in your television.

Note: If your television does not receive any antenna broadcast for a period of 5 minutes, it automatically switches to the stand-by position. The countdown OSD is displayed on the screen during the last 1 minute.

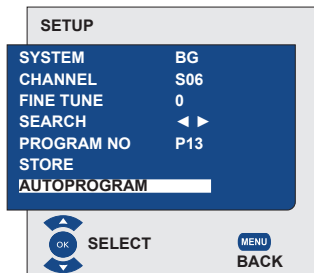

You can tune the programs automatically with the Autoprogram function of your television and then sort the channels as you desire by means of the **Program Table**. Press the **MENU** button on your remote control. Select **SETUP** by pressing the **down** movement button and confirm your selection with **OK** button. Setup menu is displayed.

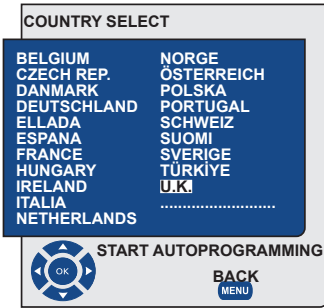

Select **PROGRAM NO** tab by pressing the **Up/Down** movement buttons in Setup menu, enter the channel number to be searched and stored automatically, then select **AUTOPROGRAM** tab by using the **Up/Down** movement buttons and press **OK** button; Country Selection menu will be displayed. In the Country Selection menu, select the country, whose broadcast you would like to watch in priority, by pressing the **Up/Down** and **Right/Left** movement buttons and start autoprogramming by pressing the **OK** button.

The channels will be automatically searched and those found will be stored in memory starting from the program selected in the Setup menu. At the same moment, the marker indicating the progress of the autoprogramming will be displayed. To stop the process at any given time, please press the **MENU** button. The Program Table, which will allow you to sort the channels as you wish, will be displayed after the automatic search is complete.

Manual tuning of channels and storing in the memory

If you already know the channel number

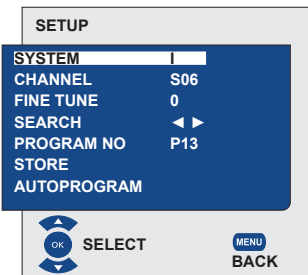

Press the **MENU** button. Move to the **SETUP** menu by pressing the Down movement button in Main Menu and confirm your selection with **OK** button. The Setup menu is displayed. Select the system in which you would like to make the search from the **SYSTEM** tab. Move into **CHANNEL** tab by pressing the down movement button. Press **OK** on your remote control to select “**S**” for cable channels and “**C**” for channels received via the antenna.

Move onto the **PROGRAM NO** tab and using the number buttons enter the channel number in which you would like to have the channel stored. If the broadcast viewed on the screen is of your desired quality, first move onto the **STORE** tab with the down movement button to store in the memory the selection you have made and store the channel by pressing the **Left** or **Right** movement buttons. The prompt **STORED** will be displayed briefly. The channel will be stored according to the program number of your choice. You can tune and store in memory other channels the same way. In the event that you wish to exit the channel settings menu for any reason, simply press the **EXIT** button.

Note: For all UK channels select I in the system tab.

If you do not know the channel number

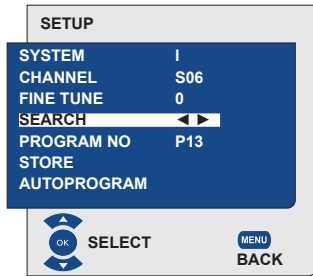

Press the **MENU** button. Move to the **SETUP** menu by pressing the **down** movement button in Main Menu and confirm your selection with **OK** button. The Setup menu is displayed. Select the system in which you would like to make the search from the **SYSTEM** tab. Move into **CHANNEL** tab by pressing the down movement button. Press **OK** on your remote control to select “S” for cable channels and “C” for channels received via the antenna.

Select **SEARCH** tab using the **up/down** movement buttons, and scan the channels in ascending order with **Right** movement button and in descending order with **Left** movement button. If the channel that is found is of your liking, select the **STORE** tab. Then store it in the memory by pressing the **Right** or **Left** movement buttons. Repeat the same procedure for other channels by selecting the program number of your choice from the **PROGRAM NO** tab. If the channel you found is not of the desired quality and requires Fine Tuning or if you would like to rename the channel, refer to the relevant sections.

Note: For all UK channels select I in the system tab.

Fine Tuning

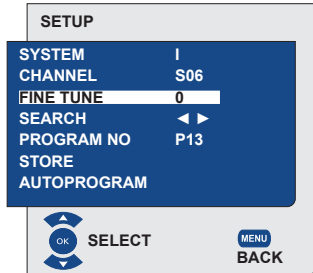

If the channel you found is not of the desired quality and requires **Fine Tuning**, then select the **FINE TUNE** tab by pressing the **Down** movement button in the **SETUP** menu. Using the **Left/Right** movement buttons on your remote control, adjust the broadcast displayed on the screen to your desired quality. Under normal circumstances, you will not require to use the Fine Tune function. The AFC values of your television will automatically adjust and lock themselves to the channel.

However, you might need it in case the television transmitters do not operate according to the standards. To store in the memory, the settings you have made, select the **STORE** tab and press the **Right** or **Left** movement button.

Program Table

Press the **MENU** button. Move to the **PROGRAM TABLE** tab by pressing the **Down** movement button in Main Menu and confirm your selection with the **OK** button. Program Table menu will be displayed.

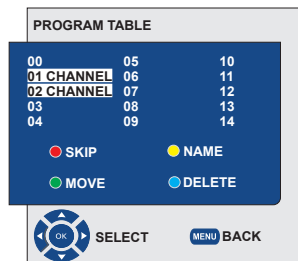

Switching the locations of the stored channels

Select the program you would like to relocate by pressing the **Up/Down** or **Left/Right** movement buttons. Press the **"GREEN"** button. Green will blink. Move to the other program you would like to relocate by pressing the **up/down** or **right/left** movement buttons. Finish the relocation process by pressing the **"GREEN"** colored button. The channel in the first program number you selected has been moved to your second selected program number and the channels between both program numbers have been shifted to the initially selected program number. After setting is complete, press the **EXIT** button to exit the menu.

Deleting a stored channel

Select the program you would like to delete by pressing the **up/down** or **right/left** movement buttons. Press the **"BLUE"** button. The blue button on the menu will blink for approval. You may perform the deletion process by pressing the **"BLUE"** button or you may abort the deletion process by pressing the **MENU** button. Once you press the **"BLUE"** button, the selected program is deleted and the following channels are transferred to after this program number. After setting is complete, press the **EXIT** button to exit the menu.

Skipping a stored channel

In the event that you do not wish to see certain programs while navigating through the channels using the **PR+/PR-** buttons, then you can use this function. Select the program that will be hidden by pressing the **up/down** or **right/left** movement buttons. Press the **"RED"** button. The name of the program to be skipped shall appear in red. You may perform this procedure for more than one program. To view the skipped program, directly enter the program number using the numeric buttons. To cancel the program skipping process, press again the **"RED"** button. After setting is complete, press the **EXIT** button to exit the menu.

To name the channels

You can assign your program or programs of choice the names that have a maximum of five characters. Select the program you would like to name from the Program Table by pressing the **up/down** or **right/left** movement buttons. Press the **"YELLOW"** button. An empty space appears beside the channel for which you would like to specify name information. Here, choose the desired letter, number or sign using the **up/down** movement buttons. For the second character, press the **right** movement button and then select the desired letter, number or sign again with the **up/down** movement buttons. After entering all the characters, store the name you have written in the memory by pressing the **"YELLOW"** button. To write names for any of the other programs, simply repeat the above procedure. If you want to exit the menu, simply press the **EXIT** button. If the program is not named, then the channel number of that program will be displayed automatically.

Performing the Sound Settings

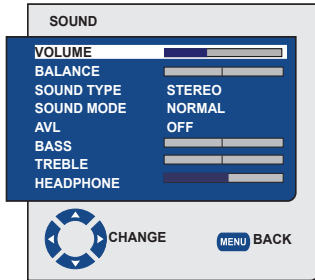

You may perform volume settings by using the **VOL+** or **VOL-** buttons on your television or the **VOL+/VOL-** buttons on your remote control. You can perform other Sound settings by entering the Sound menu. For this, press the **MENU** button on your remote control. Select **SOUND** by pressing the **Up/Down** movement buttons from the main menu and press the **OK** button. The Sound menu is displayed.

You can select the tab which you want to process with the **Down** movement button and set its level with **Left/Right** movement buttons.

Balance

To adjust the sound balance between the right and left loudspeakers to the desired level, select the **BALANCE** tab in the sound menu by using the **Down** movement button. Using the **Left/Right** movement buttons adjust this option to the desired level.

Sound Type

The program you watch may be broadcast in stereo or in two different languages. Using the **Right/Left** movement buttons in this menu, you can perform **Mono/Stereo** or **Dual-I/Dual-II** language selection. (Broadcast Dependant)

Sound Mode

If you want to give depth to the sound of the program you are watching, select **SPATIAL** item by using **Left/Right** movement buttons.

Note: If the sound mode is set to **Spatial**, then **Balance**, **Bass** and **Treble** settings are turned off and these items can not be accessed from the menu.

AVL (Automatic Volume Limiting)

Television transmitters have different sound levels. This can be noticed as high and low volume levels in different channels while switching from one program to another. Using the **Left/Right** movement buttons, select **ON**. The AVL (Automatic Volume Limiting) function maintains the same sound level as you switch from program to program. Select **OFF** to cancel it.

Bass

Select **Bass** option to increase or decrease the deep sounds in the broadcast and set it as you desire by pressing the **right/left** buttons.

Treble

Select **Treble** option to increase or decrease the sharp sounds in the broadcast and set it as you desire by pressing the **right/left** buttons.

Headphone

By connecting headphones to your television you can listen to the program sounds independently from your television. To turn up and down the headphone volume level, select **HEADPHONE** tab from the Sound menu and adjust the volume level by using the **Left/Right** movement buttons. When you want to hear the sound from the headphone only, just press the **MUTE** button on your remote control.

Sound Effects

Using the (↓) button on your remote control, you may select either one of the preset **MUSIC, SPORTS, CINEMA** and **SPEECH** options which enhance the sound effect depending on the feature of the program you are watching or the **USER** option which you can adjust as you desire from the sound menu.

Performing the Picture Settings

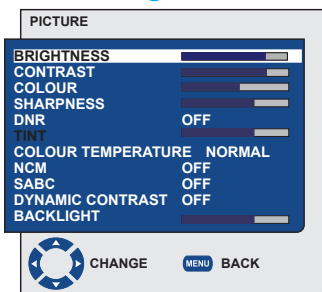

You can perform other picture settings by entering the Picture menu. For this, press the **MENU** button on your remote control. Select **PICTURE** by pressing the **Up/Down** movement buttons from the main menu and press the **OK** button. The Picture menu will be displayed. You can select the desired setting by pressing the **Up/Down** movement buttons and adjust their levels with **Right/Left** movement buttons. You can adjust **BRIGHTNESS, CONTRAST, COLOR**

and **SHARPNESS** levels as you desire. The changes you have made in the picture settings will be stored in the memory without requiring any other operations.

DNR (Noise reduction)

You may reduce interference and noise formed in the picture by using this feature. Select **DNR** tab in the Picture menu with the **Up/Down** movement buttons to activate this feature and select one of the **OFF, LOW, MID** or **HIGH** options with **Left/Right** movement buttons.

Tint

When NTSC video is input via Scart, you may make Hue settings. The tint option is not active in the menu when you have not input this type of a video. When a NTSC video is connected via the Scart, this option becomes active in the menu.

Color Temperature

Color intensity of the picture can be adjusted with this feature. Select **COLOR TEMPERATURE** tab from the Picture menu by pressing the **up/down** buttons to activate this feature and then select one of the **Cool, Normal** or **Warm** options by pressing the **right/left** buttons.

NCM (Natural Color Management)

NCM is performed by increasing the specified colours in a striking manner. Select **NCM** tab in the Picture menu by pressing the **up/down** movement buttons and then select **On** by pressing the **right/left** movement buttons to activate this feature.

SABC (Scene Adaptive Brightness Control)

SABC option allows for the automatic control of the brightness, contrast, color and sharpness according to the scene you are watching. Select **SABC** tab in the Picture menu by pressing the **up/down** movement buttons and then select **On** by pressing the **right/left** movement buttons to activate this feature.

Note: If the **SABC** option is set to **On**, then **Brightness, Contrast, Color** and **Sharpness** settings are turned off and these items can not be accessed from the menu.

Dynamic Contrast

This feature allows making brightness settings according to the picture. A brighter or dimmer picture can be sent to the screen according to the brightness level of the picture. Thus, a wider effect is obtained in terms of contrast. To activate this function, select **Dynamic Contrast** tab in the Picture menu with the **up/down** movement buttons and select **On** option with **right/left** movement buttons.

Note: If the **Dynamic Contrast** option is set to **On**, then **Backlight** feature will be turned off and this item can not be accessed from the menu.

Backlight

With this feature, you can adjust the intensity of light reflected to the LCD Panel. To activate this function, select **Back Light** tab in the Picture menu with the **up/down** movement buttons and adjust the level as you desire with **right/left** movement buttons.

Picture Smart

You can select either one of the three non-adjustable settings in the memory or one of the user options by pressing the () button on your remote control. **SOFT, NATURAL, RICH** are default values; **USER** represents the values you stored in memory.

Picture Format

With this option, you can view the broadcast you watch in a format of your choice. You may view broadcastings in either **AUTO, 16:9, 14:9, 4:3, LETTERBOX, SUBTITLE** or **PANORAMA** formats. Picture format can be selected as **16:9, 4:3** or **14:9** formats in **HDMI, YPBPR** and **PC** modes. In that case, the name of the selected picture format will be displayed in the centre of the screen.

Auto

Some movie channels may broadcast in the 16:9 format. If you would like to see this format automatically, then select **AUTO**. In that case, **AUTO 16:9** appears on your screen.

16:9



Please use this setting for watching wide screen DVDs, wide screen video cassette or 16:9 formatted broadcasts. Since various screen formats such as 16:9, 14:9 and etc. are used, black stripes might be formed on the lower and upper parts of the screen.

14:9



This is a movie format.

4:3



Use this setting to watch the broadcasts in the 4:3 format.

Letterbox



While watching a “16:9 or Cinemascope formatted” film or video cassette, this setting will eliminate or minimize the black stripes on the background by zooming in the picture without diffusing it.

Subtitle



If the subtitles are transmitted in the “16:9 formatted” broadcast, then this setting will push the picture upwards in order to ensure the entire written text to be seen.

Panorama



This setting will enlarge the image to fit the screen by stretching the image horizontally while holding the correct proportions at the centre of the image. Some distortion may occur.

Features Menu Settings

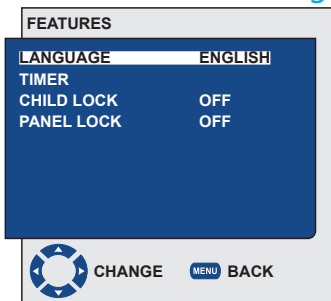

Press the **MENU** button on your remote control. Select **FEATURES** by pressing the **Up/Down** movement buttons from the main menu and press the **OK** button. The Features menu will be displayed. You can select the titles for which you would like to perform an operation in this menu by using the **up/down** movement buttons.

Language

Select the Language tab and press **right/left** movement buttons to select the language of the desired country. All the setting displays of your television will be shown in the language that you selected.

Timer

Your television is equipped with the feature of being able to be turned off and on at periods that you specify. Select **TIMER** by pressing the up/down movement buttons and press the **OK** button in order to have your TV turned off at the end of a desired period. The Timer menu will be displayed.

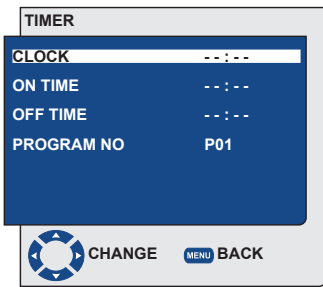

Time data is obtained from Teletext; if no time data is available then select **TIME** with the **up/down** movement buttons and enter the current time with numeric buttons. Select the **ON TIME** and **OFF TIME** in the same manner and specify the time. Enter the program number you desire with the numeric buttons or the external source with the **AV** button into **PROGRAM NO** tab to specify the channel or source from which you would like the TV to be turned-on to. At the end

of the time you specified, your television will automatically switch to stand-by. If the on time for TV is specified in the Menu, the TV will switch to the selected program at that time; if the TV is in standby mode, then it will be turned on with the selected channel.

Note: The time difference between the On Time and Off Time entered in the Timer menu must at least be **2** minutes.

Child Lock

If this feature is turned On, the program currently being watched becomes locked, the image and sound goes off and the locked symbol appears on the upper left corner of the screen. The locked channel is skipped when you channel search with **P+**, **P-** buttons.

Panel Lock

If this feature is turned On, the control buttons on your LCD television will be locked and will not function. They will be active again when the feature is turned Off.

Other Picture Features

Zoom

Press the **ZOOM** button on your remote control while watching a channel to activate this feature. During the zooming process, the image is zoomed in in three stages oriented to the centre.

Note: Zoom mode does not function with **COMP/HDMI/PC** inputs. Zoom mode is aborted when the channel is changed or Teletext is activated.

Teletext

Being one of the most prominent services of broadcasting today, Teletext renders the TV more fruitful. Teletext means in short the transmission of various updated information along with the TV broadcast signal in the form of text and graphics. To be able to receive a quality teletext broadcast, a good antenna system and a broadcast signal that is not weak, with no reflections and interference from other channels are required. Even in a very clear reception, it is normal for some characters or tabs to be lost. Such conditions will automatically be improved in a short time under normal circumstances.

Entering the Teletext Mode

In a channel that does not have the Teletext feature, **NO TEXT** will be displayed when you press the **TXT** button. In order to switch your television to the teletext broadcast, please press the **TXT** button in a program that has a teletext broadcast. To switch back to the television broadcast, press the same button twice. Once you have switched to the teletext broadcast, the initial page that appears will be the index page.

In this page, the titles of the topics in the teletext broadcast and the initial page numbers will appear.

Page Selection

To be able to view the page you would like on the screen, type in the number of that page using the numerical keys. You can see the number you have entered on the left side of the upper title tab. When you would like to turn the pages one by one, you can go to the next page pressing the **up** button and to the previous page pressing the **down** button. Press the **INFO** button to return to the Index page.

Teletext image in the TV picture (MIX)

With this feature, you can watch the teletext information and the TV broadcast together. Thus, you can follow the teletext broadcast of the channel while you watch the TV broadcast. To do this, press **TXT** button in a channel with Teletext broadcast.





Page enlarge button (DOUBLE)

Using () button, you can watch the top half of the teletext page in an enlarged format. To be able to view the bottom half of the enlarged page, press the same button for the second time. Once you press the same button the third time, the page will be restored to its normal size.

Page Stop (HOLD)

Some information is laid out by the broadcasting agency in multiple pages and it is broadcast in an automatic cycle mode. For example, on a text of four pages, the pages are indicated with the figures 01, 02, 03 and 04 on the bottom of the page. To view one of these pages for a longer time, press the () button. When you press the same button again, the cycle continues.

Subpage selection (SUB)

If the page of text you are viewing contains sub pages the page numbers starting from 01 appear on the screen. You can switch to the sub pages with the () button. In which case, the sub page tab is displayed on the bottom line within ""Red -" and "Green +" frames. You can select the subpages by pressing the () and () buttons. You can exit the subpage by pressing the () button again.

Temporary TV Picture (UPDATE)

This button allows you to switch to the television picture while the page you want is being searched in the teletext broadcast eliminating the need to wait during the search. You may switch to the television picture by pressing the () button while Teletext is searching for your desired page. Once the page you want is found, the number of that page appears on the screen.

Question - Answer Button (REVEAL)

Sometimes, a teletext page contains a hidden answer such as a game or a riddle. Press the () button to disclose the hidden answer.

Fastext

The colored buttons on the remote control are for the fastext feature. When you select any page, the titles on various subjects may appear on the screen in four different colors or inside colored frames (red, green, yellow and blue). By pressing the button pertaining to the relevant color on the remote control, you can access the subject of your choice without waiting.

Note: The fastext feature is not available for all teletext broadcasts. It is determined by the broadcasting agency whether it is to be broadcast or not.

External Equipment Connections

Your TV is equipped with 8 inputs including antenna input, which allows for the external device connection. These inputs are:

- Antenna input
- SCART input
- AV input
- S-Video input
- PC input
- HDMI1 input
- HDMI2 input
- YPbPr Component input

You can connect your external device supporting the suitable inputs to your TV via these inputs. By pressing the **AV** button on your remote control, select the external source input to which you connected your device.

Headphone Connection

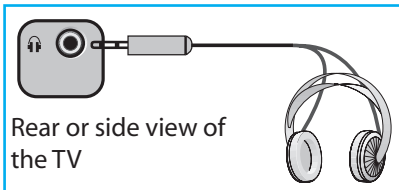

Rear or side view of the TV

The headphones must have impedance between 8 and 32 ohms and have a 3.5 mm stereo jack plug. Plug the headphone jack into the headphone socket of the TV.

Connecting an external device via Scart connection

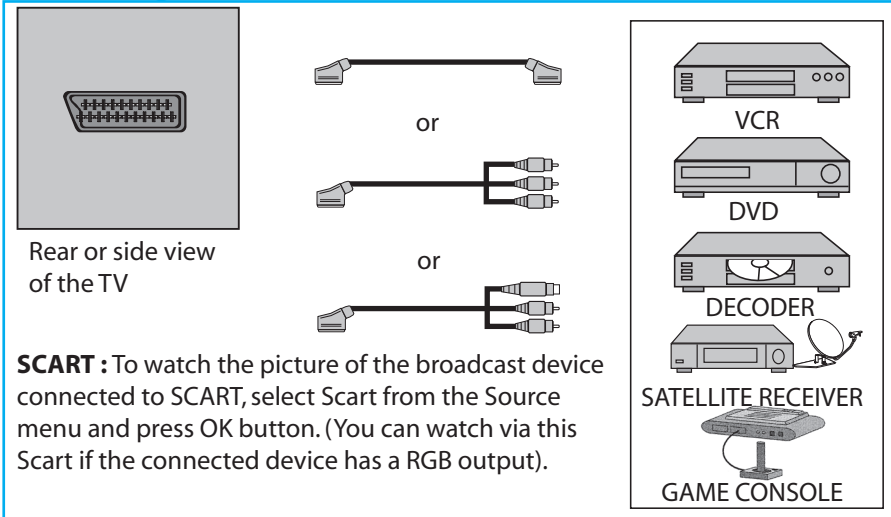

Rear or side view of the TV

SCART : To watch the picture of the broadcast device connected to SCART, select Scart from the Source menu and press OK button. (You can watch via this Scart if the connected device has a RGB output).

VCR

DVD

DECODER

SATELLITE RECEIVER

GAME CONSOLE

Connecting external equipment via AV connection

Side view of the TV

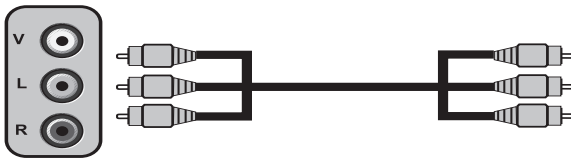

AV : To watch the picture of the broadcast device connected using the RCA (Cinch) input, select AV option from the Source menu and press OK button. Your TV will switch to the selected source.

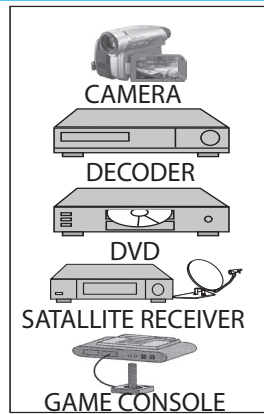

Connecting an external device via S-Video connection

Side view of the TV

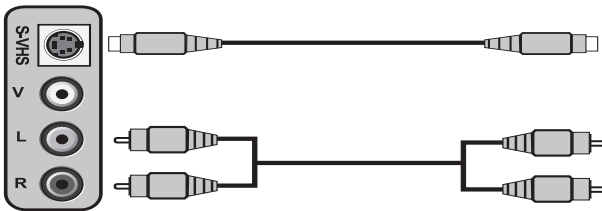

S-Video: To watch the picture of the broadcast device connected using the SVHS input, select S-Video option from the Source menu and press OK button. Your TV will switch to the selected source.

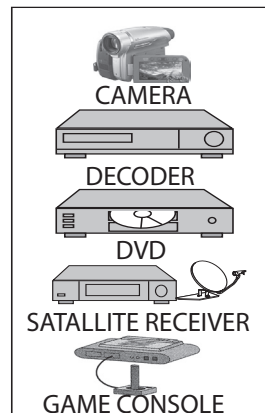

Connecting an external device via YPBPR connection

Rear view of the TV

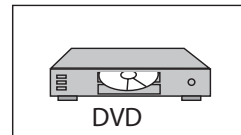
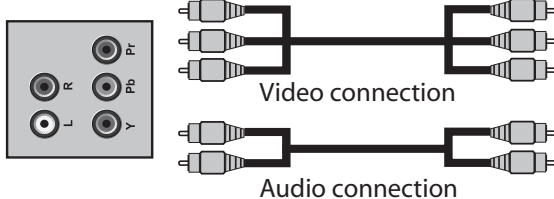

YPBPR (Component Input): When a connection is made via YPBPR socket, select YPBPR option from the Source menu and press the OK button. Your TV will switch to the selected source.

Connecting an external device via HDMI connection

Rear or side view of the TV

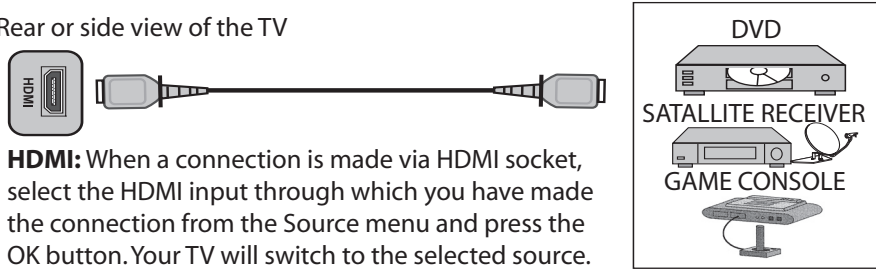

HDMI: When a connection is made via HDMI socket, select the HDMI input through which you have made the connection from the Source menu and press the OK button. Your TV will switch to the selected source.

Connect to the HDMI input at the back of your TV by using the connector located on your PC or your digital video-transmission device with a suitable cable (not supplied with the TV).

Note1: To be able to watch an image in the HDMI mode, your computer must be equipped with a HDMI graphic card.

Note2: Please adjust the video card settings of your PC if the PICTURE does not fit to the screen when you transfer the picture to your television from a PC with a DVI to HDMI or HDMI to HDMI cable.

You may display the resolution information by pressing the **INFO** button.

HDCP (High Definition Copy Protection)

Your TV supports HDCP feature. To use this feature, you must set up a connection to your TV set's HDMI video port and select HDMI by pressing the SOURCE button on your remote control.

NOTE: In HDMI mode; some resolutions are supported when a DVI to HDMI converter cable from a PC is used. Only 16:9, 4:3, 14:9 (some definitions) are supported as picture format.

High Definition - HD-READY



Your television can receive high-definition signals (HDTV). You can connect the input sources (HDTV set-top box or HDTV DVD player) to the (HDMI) socket (digital HDTV signal). This ensures that you can view digital HDTV programs, even if they are copy-protected (HDCP High-Definition Copy Protection).

PC connection

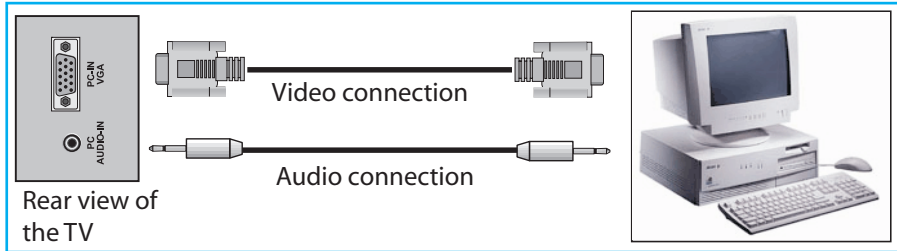

Connect the D-Sub15 connector to the **PC-IN** socket at the back of your television by using an appropriate cable (not supplied with your television). Again, by using an appropriate cable, connect the audio output of your PC to the **PC AUDIO-IN** at the back of your television to listen to sounds from your PC and you can adjust the volume level of your source by using **VOL+/VOL-** buttons.

Transition to the PC mode

For your LCD-TV to switch to the monitor (PC) mode, press the **SOURCE** button on your remote control. **SOURCE** menu will be displayed. Select **PC** by pressing the **Up/Down** movement buttons and press the **OK** button.

PC Access Setting

Enter into the **SETUP** menu from the Main Menu by pressing the **MENU** button in the PC mode. In order to make the necessary settings in this menu, you can select the headings with the **Up/Down** buttons on your remote control to perform the following monitor-related settings.

Auto Position

The most suitable geometric settings in accordance with the entry mode are configured by this function. For this operation, just select the **Autoposition** tab and press **OK** button.

Horizontal Position

Horizontal position setting.

Vertical Position

Vertical position setting.

Size

This is the pixel clock frequency. User can narrow down or enlarge the display by selecting a desired value.

Phase

Using the **Right/Left** movement buttons, you can ensure that the colors and shapes are exactly consolidated on the PC image.

PICTURE FORMAT

You can select the PC image to be displayed in 16:9 or 4:3 formats.

Troubleshooting

7

Failure	Possible cause	Solution
The television does not function	Is the power cord connected to the mains supply?	Check the power cord.
	Is the main power On/Off button on?	Check if the On/Off button is on.
Poor picture quality	Is the antenna cable attached?	Check the antenna cable.
	If you are using a satellite antenna, is it well adjusted?	Have the antenna adjusted.
	Antenna may be affected by two connected external devices.	Try disconnecting one of the devices.
	It may need fine tuning.	Perform fine tuning.
	Picture settings are not correct.	Adjust Brightness, Contrast and Color.
Shadow and reflection in the picture.	Channel setting	Perform automatic, manual channel setting or fine tuning.
	Antenna	Check antenna cable and system
No picture	Is there any damage on the antenna cable?	Check the antenna cable.
	Are you sure you pressed the correct button on your remote control?	Press the PR+ or PR- button to turn on the TV.
No colour.	Color intensity level is at the lowest setting.	Lighten the color.
	Broadcast system setting (if setting choice is available)	Select the broadcast system.
	Problem in channel broadcasting.	Test with another channel.
No or defective teletext	Television channel (no teletext) or antenna system.	Test another channel for fine tuning and shadowy pictures
	Very weak signal	Check the antenna system.
No sound	Temporary sound mute may be on	Try pressing the mute button
	Is the sound turned down?	Turn on the volume with Vol + button.
Remote control does not work	Are the batteries correctly placed?	Place the batteries correctly.
	Are batteries exhausted?	Replace the batteries with new ones.
	Is there any obstacle between the remote control and television?	If yes, remove it.
Picture is not readable after turning on the TV	Child lock is active.	Disable the child lock.

If your television does not work properly even though you tried the above mentioned solutions, try turning it on and off again. If you cannot start your television even though you have applied all noted methods, refer to the dealer or authorised service from where you purchased the product. Never attempt to repair a faulty TV yourself.

Other Useful Information

8

SCREEN SIZE	32"
Panel type	32",16:9 Active matrix TFT
Sound output	2 x 10 W
Power consumption	140 W
Stand by power value	1.1 W
Teletext page	100
Scart 1	Standard
Audio/Video PHONO (Input)	Standard
S-Video socket	Standard
YUV (Video/Sound) Component Input	Standard
HDMI 1 Input	Standard
HDMI 2 Input	Standard
VGA Input	Standard
PC Audio Input	Standard
Headphone socket	Standard

General technical specifications

Power supply AC:	230V 50 Hz
Program memory:	100
RF Aerial input:	75 Ohm (Co-axial)
Loudspeaker impedance:	8 Ohm
Sound systems:	Mono/Stereo/Nicam
Batteries:	2xUM - 4, IEC R03 or AAA 1.5V
Channels received:	VHF (Band I Channel 2-4) VHF (Band III Channel 5-12) UHF (Channel 21-69) Cable TV (S1-S20/S21-S41)
Broadcasting systems received:	PAL BG PAL SECAM BG PAL SECAM BG DK PAL SECAM BG LL' PAL I

Note: Your television has been manufactured in accordance with the system available in your country and this system cannot be changed by the user except as described below: In countries where BG/DK and BG/LL' broadcasts are made (BG or DK / BG and LL'). For further information, see the settings section for your television.

Design and specifications may be changed without prior notification.

The Sky remote code for your Tevion TV is 0065. By following the procedure below you will be able to turn your TV on/off and control the volume by using the Sky remote control.

- 1) Switch on the TV set
- 2) Press the TV button on the Sky Remote
- 3) Hold down the select and red buttons for 2-3 seconds until the LED blinks twice
- 4) Press the TV button on the Sky Remote again
- 5) Enter the 4 digit code for your make of TV
- 6) The LED should blink twice, if not recheck the 4 digit code used and go back to 1
- 7) Press the standby button on the Sky Remote (The TV should go to standby)
- 8) Press select to store this setting.

A

Antenna 9, 27
Automatic Tuning 15
AV 10, 27, 28

B

Backlight 21
Balance 19
Bass 20
Batteries 8, 9

C

Channel 10
Child Lock 24
Color Temperature 21

D

DNR 20
Dynamic Contrast 21

E

External Connections 13

F

Fine Tuning 17

H

HDCP 29
HDMI 13, 27, 29
HD READY 29
Headphone 20, 27
High Definition 29

M

Manual Tuning 16
MENU 11, 13
Mute 11
N
NCM 21

P

Panel Lock 24
PC input 27, 30
Picture Format 22, 31
Power 8, 13
Program 13
Program Table 17

R

Remote Control 8, 14

S

SABC 21
SCART 27
Sound Mode 19
Sound Settings 19
Sound Type 19
Stand Assembly 8
Standby 10, 13
S-Video 27, 28
Swap 11

T

Teletext 25
Timer 23
Tint 21
Treble 20

V

Volume 13

Y

YPBPR 27, 28

Z

Zoom 24

Memo

Memo

Memo

TEVION 32" WIDESCREEN TV

VISION

WARRANTY CARD

Congratulations! You have made an excellent choice with the purchase of this quality product. Our commitment to quality also includes our service. Should you, contrary to expectations, experience defects due to manufacturing faults during private use within 36 months of the date of purchase we shall be liable for warranty in accordance with statutory warranty regulations provided that:

- the device was not put to any use other than the intended
- was not overloaded
- was not used with the wrong accessories
- repairs were not carried out by any other than the authorized workshop

The warranty certificate is only valid in connection with the receipt. Please keep both in a safe place. This warranty does not affect your statutory rights.

This purchase is guaranteed for a period of three years beginning on the day of purchase. Keep your purchase receipt safe as proof of date of purchase. The guarantee can only be extended for the duration of any repair required.

During the warranty period defective TVs can be sent freight prepaid to the service address stated on the back cover of this document. We will, at our discretion, either repair or exchange the device in accordance with warranty legislation.

Please enclose the following when sending your product in for repair:

1. Receipt (proof of purchase)
2. This warranty certificate with the fault report form overleaf complete with your name, contact details and fault description.

If the original receipt is not enclosed the repair will be charged in all cases. After the warranty has expired you can still send defective TVs for repairs freight prepaid to the address stated below. Quotes as well as repairs after the warranty period are to be paid for in all cases.

Ensure that the product is sent well packed as no responsibility can be accepted for items lost or damaged in transit.

This warranty does not affect your statutory rights.



TEVION **32" WIDESCREEN TV**

VISION

FAULT REPORT CARD

Name _____

Address _____

Email _____ Daytime Tel No _____

Model Number _____ **T32WLU52HD** _____

Fault Description _____

In order to deal with your enquiry as quickly and efficiently as possible, we ask you to send your enquiry by e-mail. Do not forget to include your name, address and a daytime telephone number.

Alternatively, you can contact our freephone service hotline on the number below.

36-38 CAXTON WAY WETFORD

HERTFORDSHIRE WD18 8UF

Helpline No. UK/Northern Ireland 0845 850 4114

Rep. Ireland 0818 332 890

Web Support www.tevionservice.co.uk