

DVD Recorder

Operating Instructions

 To find out useful hints, tips and information about Sony products and services please visit: www.sony-europe.com/myproduct

RDR-HXD790/HXD890/HXD990/HXD1090

RDR-HXD795/HXD895/HXD995/HXD1095



WARNING

To reduce the risk of fire or electric shock, do not expose this apparatus to rain or moisture. To avoid electrical shock, do not open the cabinet. Refer servicing to qualified personnel only. The mains lead must be changed only at a qualified service shop. Batteries or batteries installed apparatus shall not be exposed to excessive heat such as sunshine, fire or the like.

CLASS 1 LASER PRODUCT
LASER KLASSE 1
LUOKAN 1 LASERLAITE
KLASS 1 LASERAPPARAT

This appliance is classified as a CLASS 1 LASER product. The CLASS 1 LASER PRODUCT MARKING is located on the rear of the unit.

CAUTION

The use of optical instruments with this product will increase eye hazard. As the laser beam used in this DVD recorder is harmful to eyes, do not attempt to disassemble the cabinet. Refer servicing to qualified personnel only.

CAUTION CLASS 3B VISIBLE AND INVISIBLE LASER RADIATION WHEN OPEN. AVOID DIRECT EXPOSURE TO THE BEAM.
VORSICHT KLASSE 3B BEWIRKT SICH UNTER DRITTBARE LASERSTRALUNG WENN GEÖFFNET. DIREKTEN KONTAKT MIT DEM STRAHLEN VERMEIDEN. SYNYLÖ OCH USYNLIGO LASERSTRÅLNING ÄR KLASS 3B VID ÖPPNING. UNDGÅ DIREKTE UTSÄTTELSE FÖR STRÅLNING NÄR DEKSEL ÖPPNAS.
ADVARSEL SYNYLIG OG USYNYLIG LASERSTRÅLING I KLASSE 3B NÄR DEKSEL ÅPNEES. UNNGÅ DIREKTE EKSPONERING FOR STRÅLEN.
VARNING KLASSE 3B SYNYLIG OCH OSYNYLIG LASERSTRÅLNING NÄR DEKSEL ÖPPNAS. UNNGÅ UNDER ÖPPNING ATT ÖPPRET EXPONERAS FÖR STRÅLNINGEN.
VARO! AVATTUNA LUOKAN 3B NÄKYVÄÄ JA NÄKYVÄTÖNÄ LASERSTRÄÄ. VÄLTÄ SUOPRAA ALTETIJÄMISTÄ SATTELLE.

This label is located on the laser protective housing inside the enclosure.

Notice for customers in the United Kingdom and Republic of Ireland

A molded plug complying with BS1363 is fitted to this equipment for your safety and convenience. Should the fuse in the plug supplied need to be replaced, a 5 AMP fuse approved by ASTA or BSI to BS1362, (i.e., marked with ⚡ or ⚡ mark) must be used. If the plug supplied with this equipment has a detachable fuse cover, be sure to attach the fuse cover after you change the fuse. Never use the plug without the fuse cover. If you should lose the fuse cover, please contact your nearest Sony service station.

Precautions

- This unit operates on 220 – 240 V AC, 50/60 Hz. Check that the unit's operating voltage is identical with your local power supply.
- To prevent fire or shock hazard, do not place objects filled with liquids, such as vases, on the apparatus.
- Install this system so that the mains lead can be unplugged from the wall socket immediately in the event of trouble.

GUIDE Plus+ and G-LINK are (1) registered trademarks or trademarks of, (2) manufactured under license from and (3) subject of various international patents and patent applications owned by, or licensed to, Gemstar-TV Guide International, Inc. and/or its related affiliates.

GEMSTAR-TV GUIDE INTERNATIONAL, INC. AND/OR ITS RELATED AFFILIATES ARE NOT IN ANY WAY LIABLE FOR THE ACCURACY OF THE PROGRAM SCHEDULE INFORMATION PROVIDED BY THE GUIDE PLUS+ SYSTEM. IN NO EVENT SHALL GEMSTAR-TV GUIDE INTERNATIONAL, INC. AND/OR ITS RELATED AFFILIATES BE LIABLE FOR ANY AMOUNTS REPRESENTING LOSS OF PROFITS, LOSS OF BUSINESS, OR INDIRECT, SPECIAL, OR CONSEQUENTIAL DAMAGES IN CONNECTION WITH THE PROVISION OR USE OF ANY INFORMATION, EQUIPMENT, OR SERVICES RELATING TO THE GUIDE PLUS+ SYSTEM.



Disposal of Old Electrical & Electronic Equipment (Applicable in the European Union and other European countries with separate collection systems)

This symbol on the product or on its packaging indicates that this product shall not be treated as household waste. Instead it shall be handed over to the applicable collection point for the recycling of electrical and electronic equipment. By ensuring this product is disposed of correctly, you will help prevent potential negative consequences for the environment and human health, which could otherwise be caused by inappropriate waste handling of this product. The recycling of materials will help to conserve natural resources. For more detailed information about recycling of this product, please contact your local Civic Office, your household waste disposal service or the shop where you purchased the product.

Europe Only



Pb

Disposal of waste batteries (applicable in the European Union and other European countries with separate collection systems)

This symbol on the battery or on the packaging indicates that the battery provided with this product shall not be treated as household waste.

By ensuring these batteries are disposed of correctly, you will help prevent potentially negative consequences for the environment and human health which could otherwise be caused by inappropriate waste handling of the battery. The recycling of the materials will help to conserve natural resources.

In case of products that for safety, performance or data integrity reasons require a permanent connection with an incorporated battery, this battery should be replaced by qualified service staff only.

To ensure that the battery will be treated properly, hand over the product at end-of-life to the applicable collection point for the recycling of electrical and electronic equipment.

For all other batteries, please view the section on how to remove the battery from the product safely. Hand the battery over to the applicable collection point for the recycling of waste batteries.

For more detailed information about recycling of this product or battery, please contact your local Civic Office, your household waste disposal service or the shop where you purchased the product.

The manufacturer of this product is Sony Corporation, 1-7-1 Konan Minato-ku Tokyo, 108-0075 Japan. The Authorized Representative for EMC and product safety is Sony Deutschland GmbH, Hedelfinger Strasse 61, 70327 Stuttgart, Germany. For any service or guarantee matters please refer to the addresses given in separate service or guarantee documents.

Precautions

This equipment has been tested and found to comply with the limits set out in the EMC Directive using a connection cable shorter than 3 metres.

On safety

Should any solid object or liquid fall into the cabinet, unplug the recorder and have it checked by qualified personnel before operating it any further.

About the hard disk drive

The hard disk has a high storage density, which enables long recording durations and quick access to the written data. However, it can easily be damaged by shock, vibration or dust, and should be kept away from magnets. To avoid losing important data, observe the following precautions.

- Do not apply a strong shock to the recorder.
- Do not place the recorder in a location subject to mechanical vibrations or in an unstable location.
- Do not place the recorder on top of a hot surface, such as a VCR or amplifier (receiver).
- Do not use the recorder in a place subject to extreme changes in temperature (temperature gradient less than 10 °C/hour).
- Do not move the recorder with its mains lead connected.
- Do not disconnect the mains lead while the power is on.
- When disconnecting the mains lead, turn off the power and make sure that the hard disk drive is not operating (the clock is displayed in the front panel display for at least 30 seconds and all recording or dubbing has stopped).

- Do not move the recorder for one minute after you have unplugged the mains lead.
- Do not attempt to replace or upgrade the hard disk by yourself, as this may result in malfunction.

If the hard disk drive should malfunction, you cannot recover lost data. The hard disk drive is only a temporary storage space.

About repairing the hard disk drive

- The contents of the hard disk drive may be checked in case of repair or inspection during a malfunction or modification. However, the contents will not be backed up or saved by Sony.
- If the hard disk needs to be formatted or replaced, it will be done at the discretion of Sony. All contents of the hard disk drive will be erased, including contents that violate copyright laws.

On power sources

- The recorder is not disconnected from the AC power source (mains) as long as it is connected to the wall outlet, even if the recorder itself has been turned off.
- If you are not going to use the recorder for a long time, be sure to disconnect the recorder from the wall outlet. To disconnect the AC power cord (mains lead), grasp the plug itself; never pull the cord.

On placement

- Place the recorder in a location with adequate ventilation to prevent heat build-up in the recorder.
- Do not place the recorder on a soft surface such as a rug that might block the ventilation holes.
- Do not place the recorder in a confined space such as a bookshelf or similar unit.
- Do not place the recorder in a location near heat sources, or in a place subject to direct sunlight, excessive dust, or mechanical shock.
- Do not place the recorder in an inclined position. It is designed to be operated in a horizontal position only.
- Keep the recorder and discs away from equipment with strong magnets, such as microwave ovens, or large loudspeakers.
- Do not place heavy objects on the recorder.

On recording

Make trial recordings before making the actual recording.

On compensation for lost recordings

Sony is not liable and will not compensate for any lost recordings or relevant losses, including when recordings are not made due to reasons including recorder failure, or when the contents of a recording are lost or damaged as a result of recorder failure or repair undertaken to the recorder. Sony will not restore, recover, or replicate the recorded contents under any circumstances.

Copyrights

- Television programmes, films, video tapes, discs, and other materials may be copyrighted. Unauthorized recording of such material may be contrary to the provisions of the copyright laws. Also, use of this recorder with cable television transmission may require authorization from the cable television transmitter and/or programme owner.
- This product incorporates copyright protection technology that is protected by U.S. patents and other intellectual property rights. Use of this copyright protection technology must be authorized by Macrovision, and is intended for home and other limited viewing uses only unless otherwise authorized by Macrovision. Reverse engineering or disassembly is prohibited.
- This Product includes FontAvenue® fonts licenced by NEC corporation. FontAvenue is a registered trademark of NEC corporation.
- “” and x-Application are trademarks of Sony Corporation.

Copy guard function

Since the recorder has a copy guard function, programmes received through an external tuner (not supplied) may contain copy protection signals (copy guard function) and as such may not be recordable, depending on the type of signal.

IMPORTANT NOTICE

Caution: This recorder is capable of holding a still video image or on-screen display image on your television screen indefinitely. If you leave the still video image or on-screen display image displayed on your TV for an extended period of time you risk permanent damage to your television screen. Plasma display panels and projection televisions are especially susceptible to this.

If you have any questions or problems concerning your recorder, please consult your nearest Sony dealer.

About this manual

Check your model name

The instructions in this manual are for 8 models: RDR-HXD790, RDR-HXD795, RDR-HXD890, RDR-HXD895, RDR-HXD990, RDR-HXD995, RDR-HXD1090, and RDR-HXD1095. Check your model name by looking at the front panel of the recorder.

- In this manual, the internal hard disk drive is written as “HDD,” and “disc” is used as a general reference for the HDD, DVDs, or CDs unless otherwise specified by the text or illustrations.
- Icons, such as , listed at the top of each explanation indicate what kind of media can be used with the function being explained. For details, see “Recordable and Playable Discs” on page 151.
- Instructions in this manual describe the controls on the remote. You can also use the controls on the recorder if they have the same or similar names as those on the remote.
- The on-screen display illustrations used in this manual may not match the graphics displayed on your TV screen.
- RDR-HXD795/HXD895/HXD995/HXD1095 is used for illustration purposes.
- The explanations regarding DVDs in this manual refer to DVDs created on this recorder. The explanations do not apply to DVDs that are created on other recorders and played back on this recorder.

Table of Contents

WARNING	2
Precautions	4
Guide to Parts and Controls	12

Hookups and Settings	17
Hooking Up the Recorder	17
Checking hookup and setting methods	17
Step 1: Connecting the Aerial Cable and Set Top Box Controller	18
A: Receiving Freeview (For digital broadcasting)	18
B: Receiving Freeview and analogue terrestrial broadcastings	19
C: Receiving cable or satellite (For analogue broadcasting)	20
D: Receiving terrestrial (For analogue broadcasting)	21
Step 2: Connecting the Video Cords/HDMI Cord	22
About the SMARTLINK features (for SCART connections only)	24
About the "Control for HDMI" functions for 'BRAVIA' Sync (for HDMI connections only)	24
Step 3: Connecting the Audio Cords/HDMI Cord	25
Step 4: Inserting a Conditional Access Module (CAM) (RDR-HXD795/HXD895/HXD995/HXD1095 only)	26
Step 5: Connecting the Mains Lead	27
Step 6: Preparing the Remote	27
Controlling TVs with the remote	28
If you have a Sony DVD player or more than one Sony DVD recorder	29
Changing programme positions of the recorder using the remote	29
Step 7: Easy Setup	30
Setting up the GUIDE Plus+ [®] system (For analogue broadcasting/ in areas with GUIDE Plus+ only)	32
Connecting a VCR or Similar Device	34
Connecting to the LINE 1/DECODER jack	34
Connecting to the LINE 2 IN jacks on the front panel	35
Connecting an External Decoder	36
Connecting a decoder	36
Setting external decoder (PAY-TV/Canal Plus analogue decoder) programme positions	37

1. Inserting a Disc	38
2. Recording a Programme	38
Checking the disc status while recording	40
3. Playing the Recorded Programme (Title List)	40
Displaying the playing time and play information	43
4. Changing the Name of a Recorded Programme	44
5. Labelling and Protecting a Disc	45
Labelling a disc	45
Protecting a disc	45
6. Playing the Disc on Other DVD Equipment (Finalise)	46
Unfinalising a disc	48
7. Reformatting a Disc	49

Guide to Digital Services (For Freeview) 50

Viewing the EPG (Electronic Programme Guide) Display	50
Programme Information	51
Displaying the programme information	51
Viewing Teletext (not available in some areas)	51
Viewing a Digital Text Service (models for the UK only)	52
Selecting digital text from dedicated digital teletext channels	52
Selecting digital text from other channels	52

Recording (For Freeview) 53

Timer Recording (EPG/Series/Manual)	53
Recording TV programmes using the EPG	53
Recording programmes using Series Recording (models for the UK only)	55
Setting the timer manually (Manual)	56
Using the Quick Timer function	58
Creating chapters in a title	58
Checking/Changing/Canceling Timer Settings (Timer List)	59
Recording from Connected Equipment	60

GUIDE Plus+ (For analogue broadcasting/in areas with GUIDE Plus+ only)	61
Viewing the GUIDE Plus+ Display	61
Listing Up Your Favourite Programme Information (My TV)	63
Making Changes to the GUIDE Plus+ System	64
Searching for the GUIDE Plus+ host channel (Setup)	64
Changing the GUIDE Plus+ host channel manually (Setup)	64
Checking programme positions (Editor)	65
Disabling programme positions (Editor)	65
Recording (For analogue broadcasting)	66
Timer Recording (GUIDE Plus+/Manual)	66
One Button Recording (GUIDE Plus+ (in areas with GUIDE Plus+ service only))	66
Setting the timer manually (Schedule)	68
Using the Quick Timer function	69
Recording stereo and bilingual programmes	70
Creating chapters in a title	70
Checking/Changing/Canceling Timer Settings (Schedule)	71
Checking/changing timer settings	71
Canceling timer settings	71
Recording from Connected Equipment	72
Playback	73
Playing	73
Playback options	75
Playing a specific portion repeatedly (A-B Repeat)	77
Playing repeatedly (Repeat)	77
Creating your own programme (Programme)	78
Advanced Playback Functions	79
Pausing a TV broadcast (TV Pause/Pause Live TV)	79
Playing from the beginning of the programme you are recording (Chase Play)	79
Playing a previous recording while making another (Simultaneous Rec and Play)	80
Searching for a Time/Title/Chapter/Track, etc.	80

Erasing and Editing	82
Before Editing	82
Erasing and Editing a Title	83
Editing multiple titles (Multi-Mode)	83
Erasing a section of a title (A-B Erase)	84
Dividing a title (Divide)	84
Erasing and Editing a Chapter	85
Dividing a chapter (Divide)	86
Erasing a chapter (Erase)	86
Combining multiple chapters (Combine)	86
Creating and Editing a Playlist	87
Moving a Playlist title (Move)	87
Combining multiple Playlist titles (Combine)	87
Dividing a Playlist title (Divide)	87
Moving a chapter (Move)	88
<hr/>	
Dubbing (HDD ↔ DVD)	89
Before Dubbing	89
HDD/DVD Dubbing	90
Dubbing Using Dubbing List	90
Making a Backup Disc (DVD Backup)	93
<hr/>	
HDD Camcorder Dubbing	94
Before HDD Camcorder Dubbing	94
Preparing for HDD camcorder dubbing	95
One-Touch Dubbing from HDD Camcorder (ONE-TOUCH DUB)	96
Dubbing from HDD Camcorder Using the On-Screen Display (HDD-Cam Dubbing)	96
<hr/>	
DV Camcorder Dubbing	98
Before DV Camcorder Dubbing	98
Preparing for DV camcorder dubbing	98
Dubbing an Entire DV Format Tape (DV One-Touch Dubbing)	100
Dubbing Selected Scenes (DV Manual Dubbing)	100
Playing from a DV Camcorder	101

Music Jukebox	102
About Jukebox	102
Preparing for Using Jukebox	102
Connecting the USB device	102
Copying tracks or albums (USB → HDD)	102
Copying audio tracks (DISC → HDD)	103
Copying tracks or albums on the HDD (HDD ↔ HDD)	103
Playing Audio Tracks Using Jukebox/USB Device	104
Adding audio tracks to a Playlist (HDD only)	105
Playback options	105
Playing repeatedly (Repeat)	105
Creating your own programme (Programme) (USB device only)	106
Managing Audio Tracks on the Music Jukebox (HDD only)	107
Photo Album	108
About the “Photo Album” Function	108
Preparing for Using the “Photo Album” Function	108
Connecting the USB device	108
Copying JPEG image files to the HDD (DISC/USB → HDD)	108
Copying all JPEG image files from the connected USB device (USB → DVD-RW/DVD-R)	109
Copying JPEG image files or albums on the HDD (HDD ↔ HDD)	110
Copying JPEG image albums to a disc (HDD → DVD-RW/DVD-R)	110
Copying JPEG image files to a disc (HDD → DVD-RW/DVD-R)	111
Using the “Photo Album” List	112
Playing a slideshow	114
Creating a Slideshow with Your Favourite Music and Graphic Effects (x-Pict Story) (HDD only)	115
Managing JPEG Image Files on the HDD	117
Printing JPEG Image Files	118

Settings and Adjustments	120
Adjusting Picture Quality	120
Using the Setup Menus	123
Disc Settings (Disc Setup)	123
Recorder Settings (Basic)	124
Aerial Reception Settings (Digital Tuner)	126
Aerial Reception Settings (Analog Tuner)	127
Video Settings (Video In/Out)	130
Audio Input Settings (Audio In)	132
Audio Output Settings (Audio Out)	133
Language Settings (Language)	134
Recording Settings (Recording)	135
Playback Settings (Playback)	137
Limitation Settings (Parental Lock)	138
HDMI Settings (HDMI Output)	139
Other Settings (Options)	141
Other Settings (Options 2)	142

Additional Information	143
Troubleshooting	143
Resetting the Recorder	150
Recordable and Playable Discs	151
Playable Discs	153
About Recording/Dubbing Mode	154
Language Code List	158
Country/Area Code	158
Notes About This Recorder	159
Notes on MP3 Audio Tracks, JPEG Image Files, DivX Video Files, and i.Link	160
Specifications	162
Index	164

Guide to Parts and Controls

For more information, see the pages in parentheses.

Remote

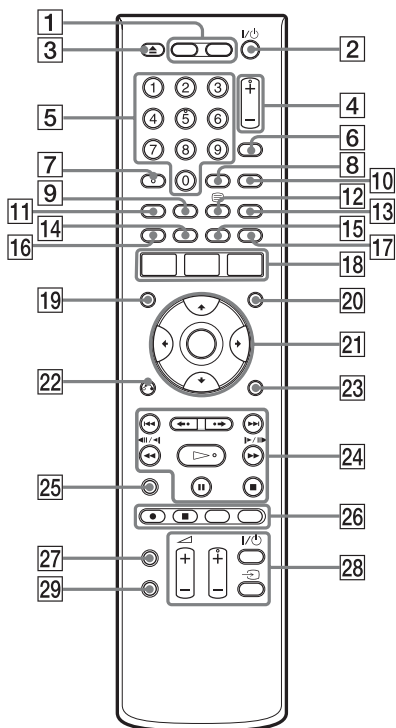

- 1 HDD (38)**
Records to or plays titles on HDD.
- DVD (38)**
Records to or plays titles on DVD.
- 2 I/⏻ (on/standby) (30)**
Turns the recorder on or off.
- 3 ▲ (open/close) (38)**
Opens or closes the disc tray.
- 4 PROG (programme) +/- (38)**
The + button has a tactile dot*.
- 5 Number buttons (80)**
The number 5 button has a tactile dot*.
- 6 INPUT (input select) (60, 72)**
Selects an input source.
- 7 AUDIO (75)**
The AUDIO button has a tactile dot*.
- 8 CLEAR (44, 77, 78)**
- 9 ANGLE (75, 114)**
Changes the angles or rotates an image during slideshow.
- 10 TV/DVD (28)**
Switches between TV mode and DVD mode.
- 11 SUBTITLE (75)**
Selects a subtitle language.
- 12 ☰ (text) (51, 52)**
This button function is not available in some areas.
- 13 MENU (73)**
Displays the disc's menu.
- 14 Green (50, 61)**
- 15 Yellow (50, 61)**
- 16 Red (50, 61)**
- 17 Blue (50, 61)**
- 18 SYSTEM MENU (120)**
TITLE LIST (40, 73, 83)
TOP MENU (73)
GUIDE (50, 61)
Displays EPG or GUIDE Plus+® system screen.
- 19 TIMER (56, 59)**
- 20 INFO (information) (50, 62)**
Displays the programme information.
- 21 ←/↑/↓/→/ENTER (30)**
Selects a desired item.
- 22 ↶ RETURN (30)**
EXIT (126)
Cancels scanning of programme positions.

23 DISPLAY (43)

Displays the playing status or disc information.

24 ◀◀/▶▶ (previous/next) (75, 105)

PAGE +/- (50, 62)

Changes the programme list by page.

◀•/•▶ (instant replay/instant advance) (75)

◀◀◀◀/▶▶▶▶ (search/slow/freeze frame) (75, 105)

DAY +/- (62)

Changes the programme list by day.

▷ (play) (73, 114)

⏸ (pause) (39, 75, 105, 114)

■ (stop) (73, 104, 114)

The ▷ button has a tactile dot*.

25 TV PAUSE (79)

26 ● REC (38)

■ REC STOP (38)

HDD/DVD DUB (90)

Starts dubbing the current playing title or cancels the dubbing.

REC MODE (38)

Selects the recording mode.

27 ZOOM (114)

Zooms an image during a slideshow.

28 TV I/⏻ (on/standby) (28)

TV ↵ (input select) (28)

TV ▲ (volume) +/- (28)

TV PROG (programme) +/- (28)

The + button has a tactile dot*.

29 PLAY MODE (77, 80)

* Use the tactile dot as a reference when operating the recorder.

Front panel

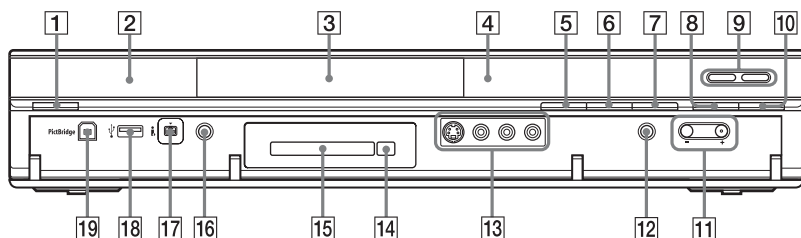

- 1** **I/⏻ (on/standby) (30)**
Turns the recorder on or off.
- 2** **📶 (remote sensor) (27)**
- 3** **Disc tray (38)**
- 4** **Front panel display (15)**
- 5** **⏮ (open/close) (38)**
Opens or closes the disc tray.
- 6** **▶ (play) (73, 114)**
The ▶ button has a tactile dot*.
- 7** **■ (stop) (73, 104, 114)**
- 8** **● REC (38)**
- 9** **HDD (38)**
Records to or plays titles on HDD. The HDD indicator lights up when the HDD is selected.
- DVD (38)**
Records to or plays titles on DVD. The DVD indicator lights up when the DVD is selected.
- 10** **■ REC STOP (38)**
- 11** **PROGRAM +/- (38)**
The + button has a tactile dot*.
- 12** **INPUT (input select) (60, 72)**
Selects an input source.
- 13** **LINE 2 IN (S VIDEO/VIDEO/ L(MONO) AUDIO R) jacks (35)**
Connect a VCR or similar recording device to these jacks.
- 14** **⏮ (eject) (RDR-HXD795/ HXD895/HXD995/HXD1095 only) (26)**
Removes the CAM from the CAM slot.
- 15** **CAM (Conditional Access Module) slot (RDR-HXD795/ HXD895/HXD995/HXD1095 only) (26)**
- 16** **ONE-TOUCH DUB (96, 100)**
Starts dubbing from a connected digital video camera.
- 17** **📹 DV IN jack (98)**
Connect a DV camcorder to this jack.
- 18** **📶 USB jack (type A) (102, 108)**
Connect a USB device to this jack.
- 19** **PictBridge USB jack (type B) (118)**
Connect a PictBridge-compatible printer to this jack.

* Use the tactile dot as a reference when operating the recorder.

To lock the recorder (Child Lock)

You can lock all of the buttons on the recorder so that the settings are not cancelled by mistake.

When the recorder is turned off, hold down **■ (stop)** on the recorder until “LOCKED” appears in the front panel display. The recorder does not work except for timer recordings while the Child Lock is set. To unlock the recorder, hold down **■ (stop)** on the recorder until “UNLOCKED” appears in the front panel display.

Front panel display

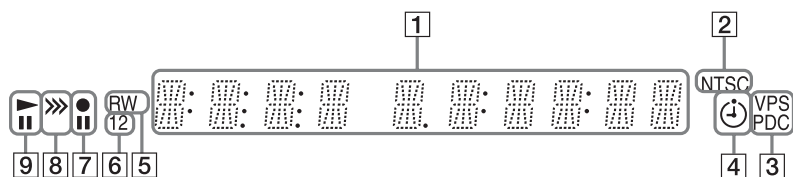

1 Displays the following:

- Playing time
- Current title/chapter/track/index number
- Recording time/recording mode
- Clock
- Programme position
- EPG indication (61)
“EPG” appears when receiving the GUIDE Plus+ data.
- TV Direct Rec. indication (38)
“TV” appears in the right most two digits.
- UPDATE indication
“UPDATE” appears when the recorder is updating the EPG information.

2 NTSC indicator (125, 131)

Lights up when NTSC colour system is selected.

3 VPS/PDC indicator (57, 69)

Lights up when the VPS/PDC function is turned on.

4 Timer indicator (66)

Lights up when the timer for recording is set.

5 Disc type

Lights up when a recordable DVD-R or DVD-RW disc is loaded.

6 Command Mode indicator (141)

Displays the Command Mode of the remote.
When the Command Mode for the recorder is set to “3 (Default setting),” either “1” or “2” does not appear.

7 Recording status

8 Dubbing direction indicator

9 Playing status

Rear panel

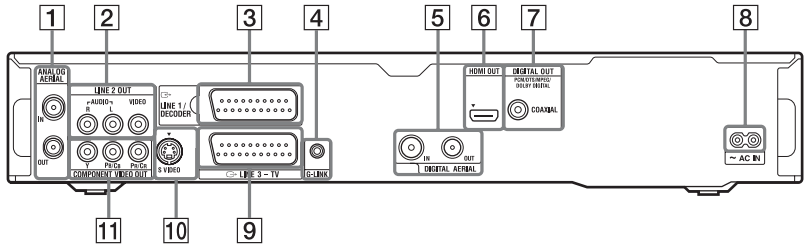

- 1 ANALOG AERIAL IN/OUT jacks (18)**
- 2 LINE 2 OUT (R-AUDIO-L/VIDEO) jacks (22, 25)**
- 3 LINE 1/DECODER jack (34)**
- 4 G-LINK jack (20)**
Connect the set top box controller to this jack.
- 5 DIGITAL AERIAL IN/OUT jacks (18)**
- 6 HDMI OUT (high-definition multimedia interface out) jack (22, 25)**
- 7 DIGITAL OUT (COAXIAL) jack (25)**
- 8 AC IN terminal (27)**
- 9 LINE 3 - TV jack (22)**
- 10 LINE 2 OUT (S VIDEO) jack (22)**
- 11 COMPONENT VIDEO OUT (Y, Pb/Cb, Pr/Cr) jacks (22)**

Hookups and Settings

Hooking Up the Recorder

Follow steps 1 through 7 to hook up and adjust the settings of the recorder. Do not connect the mains lead until you reach “Step 5: Connecting the Mains Lead” on page 27.

Notes

- See “Specifications” (page 162) for a list of supplied accessories.
- Plug in cords securely to prevent unwanted noise.
- Refer to the instructions supplied with the components to be connected.
- You cannot connect this recorder to a TV that does not have a SCART or video input jack.
- Be sure to disconnect the mains lead of each component before connecting.

Checking hookup and setting methods

The recorder incorporates both analogue and digital tuners. The programme guide and timer recording method differ depending on which one you select. Depending on the broadcasts you are receiving and your equipment, select one of the following aerial hookups. Do NOT set “LINE 1 In” to “Decoder” in the “Video In/Out” setup (page 131) when making connection C.

When you receive	Hookup	Programme guide	Timer recording using programme guide
Freeview	A (page 18)	Digital Service (page 50)	See page 53.
Both Freeview and analogue terrestrial broadcasting	B (page 19)	Select Digital Service or GUIDE Plus+ (page 30).	See page 53 when using Digital Service. See page 66 when using GUIDE Plus+.
Satellite, Cable	C (page 20)	GUIDE Plus+ (page 61)	See page 66.
Terrestrial	D (page 21)	GUIDE Plus+ (page 61)	See page 66.

Note

Analogue broadcasts are scheduled to end at different times, depending on the country/area. After analogue broadcasts end in your area, you will not be able to use hookup D to view TV broadcasts. At that time, change to hookup A to view digital broadcasts.

Step 1: Connecting the Aerial Cable and Set Top Box Controller

Notes

- If your aerial is a flat cable (300-ohm twin lead cable), use an external aerial connector (not supplied) to connect the aerial to the recorder.
- If you have separate cables for AERIAL antennas, use an AERIAL UHF/VHF band mixer (not supplied) to connect the aerial to the recorder.
- If you disconnect the recorder's mains lead, you will not be able to view the signals from the connected set top box receiver.

A: Receiving Freeview (For digital broadcasting)

Use this hookup if you can receive Freeview.

With this hookup, you can record any programme position by selecting the programme position on the recorder.

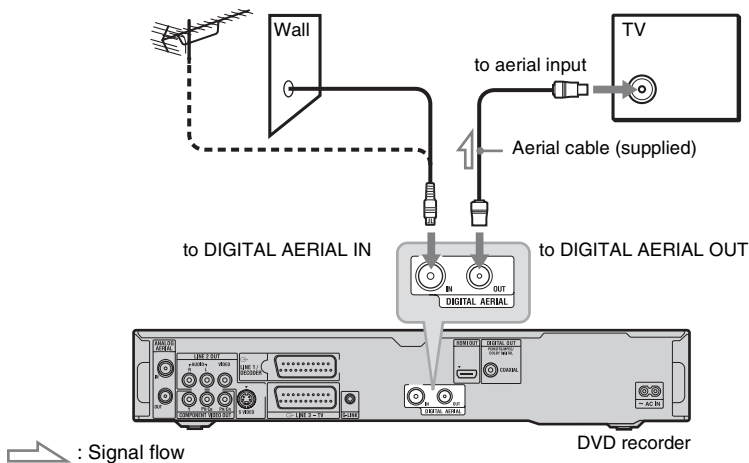

- 1** Disconnect the aerial cable from your TV, and connect it to **DIGITAL AERIAL IN** on the rear panel of the recorder.
- 2** Connect **DIGITAL AERIAL OUT** of the recorder to the aerial input of your TV using the supplied aerial cable.

Hint

For RDR-HXD795/HXD895/HXD995/HXD1095 (except models for the UK) only

When connecting to an indoor aerial, use one with a signal amplifier rated at 5 V, 30 mA. Then set "Aerial Power" to "On" in the "Digital Tuner" setup (page 127).

B: Receiving Freeview and analogue terrestrial broadcastings

This recorder has separate built-in TV tuners for terrestrial digital and terrestrial analogue TV broadcasts. Use this hookup if you want to view both Freeview and analogue terrestrial broadcastings.

With this hookup, you can record any programme position by selecting the programme position on the recorder.

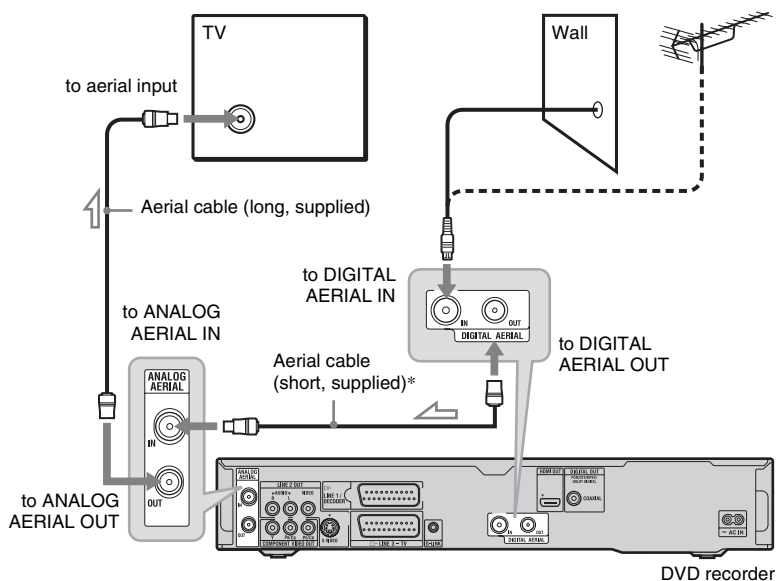

: Signal flow

* Aerial cable is supplied for some models.

- 1** Disconnect the aerial cable from your TV, and connect it to the DIGITAL AERIAL IN jack on the rear panel of the recorder.
- 2** Connect the DIGITAL AERIAL OUT jack and the ANALOG AERIAL IN jack using the supplied short aerial cable.
- 3** Connect the ANALOG AERIAL OUT jack of the recorder to the aerial input of your TV using the supplied long aerial cable.

C: Receiving cable or satellite (For analogue broadcasting)

With this hookup, you can record any programme position on the set top box receiver. To watch cable programmes, you need to match the programme position on the recorder to the aerial output programme position on the set top box receiver.

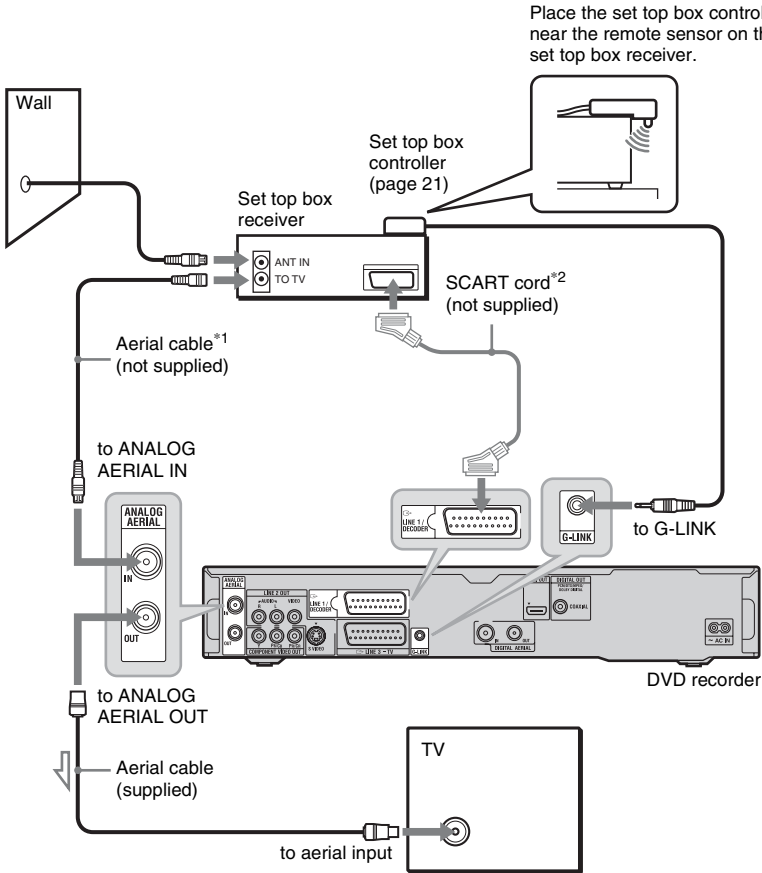

↗ : Signal flow

*¹ If your set top box receiver does not have an aerial output jack, connect the aerial to the recorder's ANALOG AERIAL IN jack.

*² Connect only if your set top box receiver has a SCART connector.

If the set top box receiver can output RGB signals

This recorder accepts RGB signals. If the set top box receiver can output RGB signals, connect the TV SCART connector on the set top box receiver to the LINE 1/DECODER jack, and set "LINE 1 In" to "RGB" in the "Video In/Out" setup (page 131). Refer to the instructions supplied with the set top box receiver.

About the set top box receiver control function (in areas with GUIDE Plus+ only)

You can use the set top box receiver control function with hookup C.

When using the set top box receiver control function:

- The recorder controls the set top box receiver via the supplied set top box controller.
- The recorder controls programme positions on the set top box receiver for timer recording.
- You can use the recorder's remote control to change programme positions on the set top box receiver whenever the set top box receiver and recorder are turned on.

After making hookup C, check that the recorder correctly controls the set top box receiver (page 32).

D: Receiving terrestrial (For analogue broadcasting)

Use this hookup if you watch cable programme positions without a set top box receiver. Also use this hookup if you are only connecting an aerial antenna.

With this hookup, you can record any programme position by selecting the programme position on the recorder.

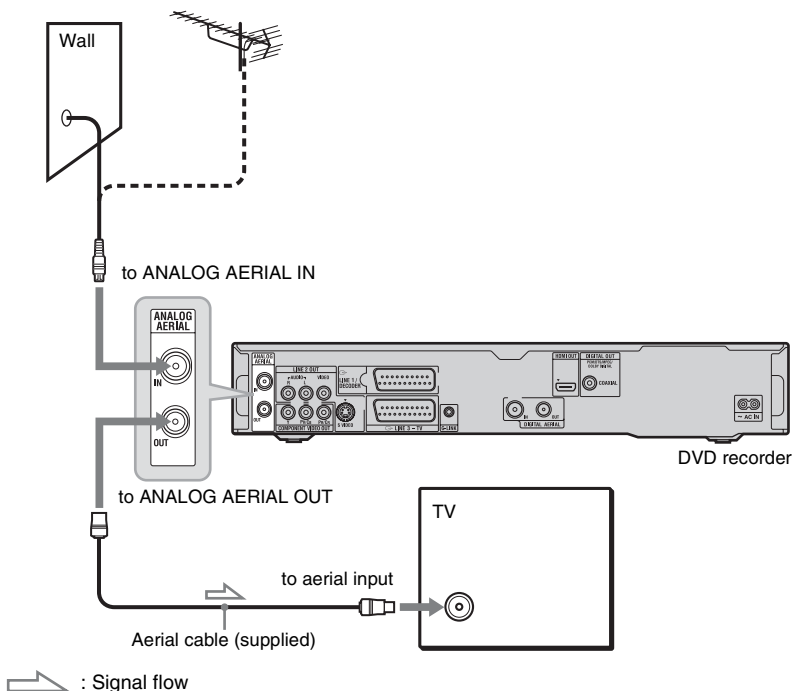

- 1** Disconnect the aerial cable from your TV, and connect it to **ANALOG AERIAL IN** on the rear panel of the recorder.
- 2** Connect **ANALOG AERIAL OUT** of the recorder to the aerial input of your TV using the supplied aerial cable.

Step 2: Connecting the Video Cords/HDMI Cord

Select one of the following patterns, **A** through **E**, according to the input jack on your TV monitor, projector, or audio component such as an AV amplifier (receiver). This will enable you to view pictures.

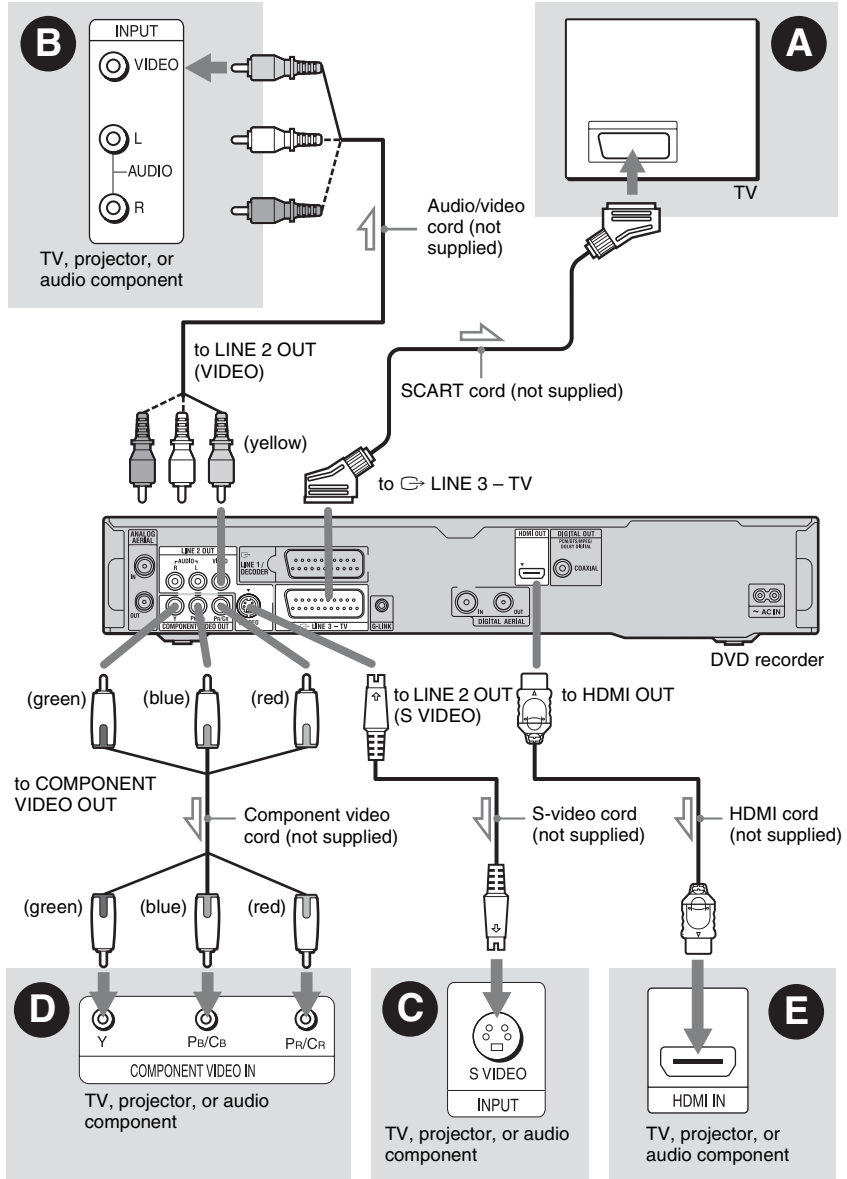

A SCART input jack

When setting “LINE 3 Out” to “S-Video” or “RGB” in the “Video In/Out” setup (page 131), use a SCART cord that conforms to the selected signal.

B Video input jack

You will enjoy standard quality images.

C S VIDEO input jack

You will enjoy high quality images.

D Component video input jacks (Y, Pb/Cb, Pr/Cr)

You will enjoy accurate colour reproduction and high quality images.

If your TV accepts progressive 525p/625p format signals, use this connection and set “Progressive” to “Compatible” in the “Easy Setup” setup (page 30). Then set “Component Video Out” to “Progressive” in the “Video In/Out” setup to send progressive video signals. For details, see “Component Video Out” on page 130.

E HDMI input jack

Use a certified HDMI cord (not supplied) to enjoy high quality digital picture and sound through the HDMI OUT jack.

When connecting a Sony TV that is compatible with the “Control for HDMI” function, see page 24.

To see the signals from the connected set top box receiver when the set top box receiver is connected to the recorder using a SCART cord only, turn the recorder on.

When connecting to the HDMI jack

Follow the steps below. Improper handling may damage the HDMI jack and the connector.

- 1 Carefully align the HDMI jack on the rear of the recorder and the HDMI connector by checking their shapes. Make sure the connector is not upside down or tilted.

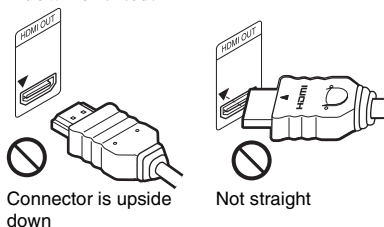

- 2 Insert the HDMI connector straight into the HDMI jack. Do not bend or apply pressure to the HDMI connector.

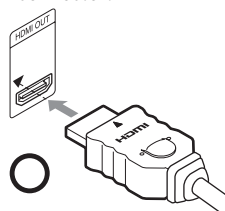

Notes

- Be sure to disconnect the HDMI cord when moving the recorder.
- Do not apply too much pressure to the cabinet wall, if you place the recorder on the cabinet with the HDMI cord connected. It may damage the HDMI jack or the HDMI cord.
- Do not twist the HDMI connector while connecting to or disconnecting from the HDMI jack to avoid damaging the HDMI jack and connector.

When playing “wide screen” images

Some recorded images may not fit your TV screen. To change the picture size, see page 137.

If you are connecting to a VCR

Connect your VCR to the LINE 1/ DECODER jack on the recorder (page 34).

🔌 Notes

- Do not connect more than one type of video cord between the recorder and your TV at the same time.
- Do not make connections **A** and **E** at the same time.
- When you connect the recorder to your TV via the SCART jacks, the TV's input source is set to the recorder automatically when you start playback. If necessary, press the TV  button on the remote to return the input to the TV.
- If you connect the recorder to a TV with SMARTLINK, set "LINE 3 Out" to "Video" in the "Video In/Out" setup.
- You cannot connect the HDMI OUT jack (connection **E**) to DVI jacks that are not HDCP compliant (e.g., DVI jacks on PC displays).
- Component video and RGB signals are not output when using the HDMI connection.

* This DVD recorder incorporates High-Definition Multimedia Interface (HDMI™) technology.

HDMI, the HDMI logo and High-Definition Multimedia Interface are trademarks or registered trademarks of HDMI Licensing LLC.

About the SMARTLINK features (for SCART connections only)

If the connected TV (or other connected equipment such as a set top box receiver) complies with SMARTLINK, NexTVView Link^{*3}, MEGALOGIC^{*1}, EASYLINK^{*2}, CINEMALINK^{*2}, Q-Link^{*3}, EURO VIEW LINK^{*4}, or T-V LINK^{*5}, you can enjoy the following SMARTLINK features.

- TV Direct Rec. (page 39)
- One-Touch Play (page 74)
- Preset Download

You can download the tuner preset data from your TV to this recorder, and tune the recorder according to that data in "Easy Setup."

- NexTVView Download

You can easily set the timer by using the NexTVView Download function on your TV.

To prepare for the SMARTLINK features

Set "LINE 3 Out" to "Video" in the "Video In/Out" setup (page 131) and "SMARTLINK" to "This Recorder Only" in the "Options" setup (page 141).

🔌 Notes

- For correct SMARTLINK connection, you will need a SCART cord that has the full 21 pins. Refer as well to your TV's instruction manual for this connection.
- Not all TVs respond to the functions above.

*1 "MEGALOGIC" is a registered trademark of Grundig Corporation.

*2 "EASYLINK" and "CINEMALINK" are trademarks of Philips Corporation.

*3 "Q-Link" and "NexTVView Link" are trademarks of Panasonic Corporation.

*4 "EURO VIEW LINK" is a trademark of Toshiba Corporation.

*5 "T-V LINK" is a trademark of JVC Corporation.

About the "Control for HDMI" functions for 'BRAVIA' Sync (for HDMI connections only)

By connecting Sony components that are compatible with the "Control for HDMI" function with an HDMI cord (not supplied), operation is simplified as below:

- One-Touch Play (page 74)
- System Power-Off

When you turn the TV off using the power button on the TV's remote, the recorder and components compatible with the "Control for HDMI" function turn off automatically. However, the recorder does not turn off while recording or dubbing even if you turn off the TV.

- 'BRAVIA' Sync display
You can control the recorder by pressing the SYNC MENU button on the TV's remote.

🔌 Notes

- Depending on the connected component, the "Control for HDMI" function may not work. Refer to the operating instructions supplied with the component.
- You can use the 'BRAVIA' Sync display feature only when the connected TV has the SYNC MENU button. For details on 'BRAVIA' Sync, refer to the operating instructions supplied with the TV.
- To use the 'BRAVIA' Sync features, set "Control for HDMI" to "On" (default) in the "HDMI Output" setup (page 140).

Step 3: Connecting the Audio Cords/HDMI Cord

Select one of the following patterns, **A** or **B**, according to the input jack on your TV monitor, projector, or audio component such as an AV amplifier (receiver). This will enable you to listen to sound.

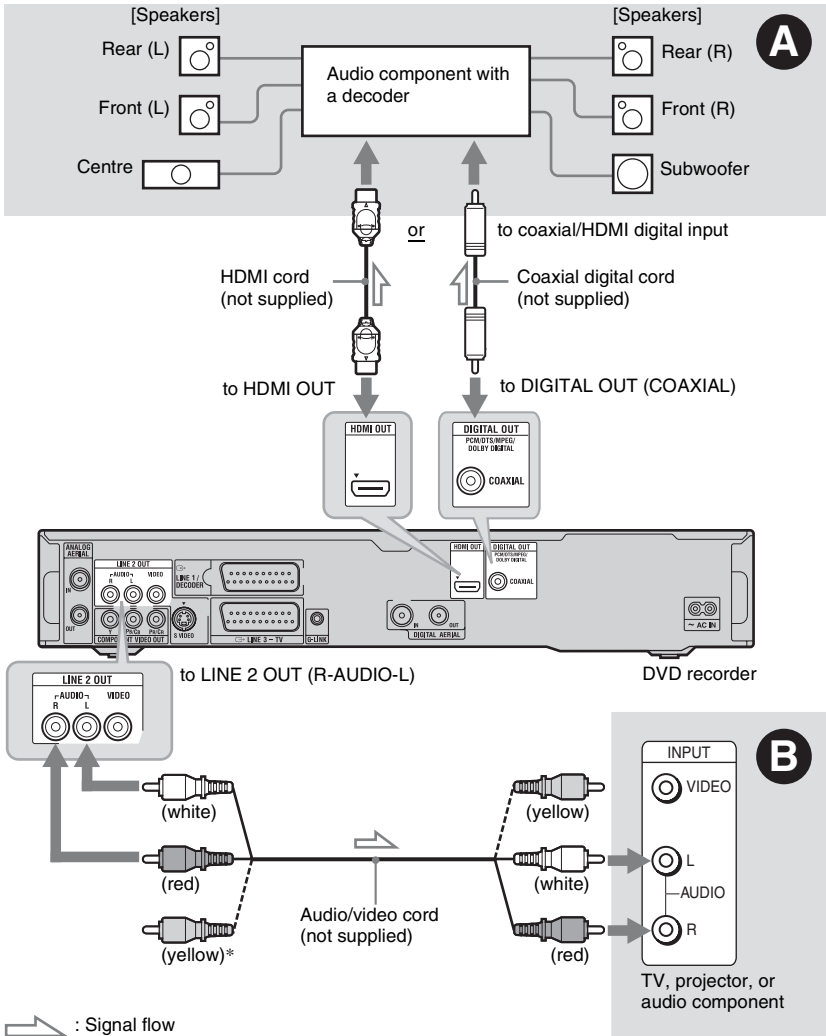

* The yellow plug is used for video signals (page 22).

A Digital audio input jack
 If your audio component has a Dolby[®] Digital, DTS[®], or MPEG audio decoder and a digital input jack, use this connection. You can enjoy Dolby Digital (5.1ch), DTS (5.1ch), and MPEG audio (5.1ch) surround effects.

If you connect a Sony audio component that is compatible with the "Control for HDMI" function, refer to the operating instructions supplied with the audio component.

B Audio L/R (left/right) input jacks

This connection will use your TV's or audio component's two speakers for sound.

Hint

For correct speaker location, refer to the operating instructions supplied with the connected components.

Notes

- Do not connect your TV's audio output jacks to the LINE IN (R-AUDIO-L) jacks at the same time. This will cause unwanted noise to come from your TV's speakers.
- With connection **B**, do not connect the LINE IN (R-AUDIO-L) and LINE 2 OUT (R-AUDIO-L) jacks to your TV's audio output jacks at the same time. This will cause unwanted noise to come from your TV's speakers.
- With connection **A**, after you have completed the connection, make the appropriate settings in the "Audio Out" setup (page 133). Otherwise, no sound or a loud noise will come from your speakers.
- When you connect the recorder to an audio component using an HDMI cord, you will need to do one of the following:
 - Connect the audio component to the TV with the HDMI cord, or
 - Connect the recorder to the TV with a video cord other than HDMI cord (component video cord, S-video cord, or audio/video cord).

*1 Manufactured under license from Dolby Laboratories.
Dolby and the double-D symbol are trademarks of Dolby Laboratories.

*2 Manufactured under license under U.S. Patent #: 5,451,942 & other U.S. and worldwide patents issued & pending. DTS and DTS Digital Out are registered trademarks and the DTS logos and Symbol are trademarks of DTS, Inc. © 1996-2007 DTS, Inc. All Rights Reserved.

Step 4: Inserting a Conditional Access Module (CAM) (RDR-HXD795/HXD895/HXD995/HXD1095 only)

Insert a conditional access module (CAM) provided by your service provider to receive scrambled digital broadcasting. This recorder is designed to work with modules that support the DVB standard. Contact your service provider to obtain the right kind of CAM.

Insert the CAM into the CAM slot as far as it will go.

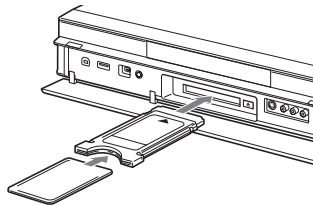

To remove the CAM

Press  located on the right side of the CAM slot.

Notes

- The CAM slot accepts only Type I and Type II PC cards. Do not insert other cards or unacceptable objects into the CAM slot.
- Do not remove or insert the CAM while receiving broadcasts. This will cause the picture not to be displayed.

Step 5: Connecting the Mains Lead

Connect the supplied mains lead to the AC IN terminal of the recorder. Then plug the recorder and TV mains leads (AC power cords) into the mains. After you connect the mains lead, **you must wait for a short while before operating the recorder.** You can operate the recorder once the front panel display lights up and the recorder enters standby mode.

If you connect additional equipment to this recorder (page 34), be sure to connect the mains lead after all connections are complete.

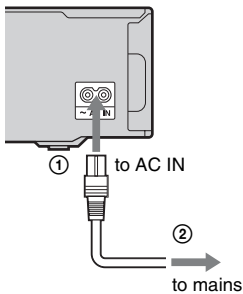

Step 6: Preparing the Remote

You can control the recorder using the supplied remote. Insert two R6 (size AA) batteries by matching the ⊕ and ⊖ ends on the batteries to the markings inside the battery compartment. When using the remote, point it at the remote sensor  on the recorder.

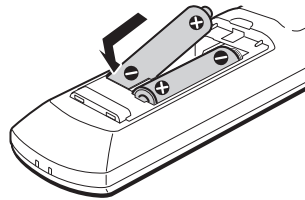

Notes

- If the supplied remote interferes with your other Sony DVD recorder or player, change the command mode number for this recorder (page 29).
- Use the batteries correctly to avoid possible leakage and corrosion. Should leakage occur, do not touch the liquid with bare hands. Observe the following:
 - Do not use a new battery with an old battery, or batteries of different manufacturers.
 - Do not attempt to recharge the batteries.
 - If you do not intend to use the remote for an extended period of time, remove the batteries.
 - If battery leakage occurs, wipe out any liquid inside the battery compartment, and insert new batteries.
- Do not expose the remote sensor (marked  on the front panel) to strong light, such as direct sunlight or a lighting apparatus. The recorder may not respond to the remote.
- When you replace the batteries of the remote, the code number and Command Mode may be reset to the default setting. Set the appropriate code number and Command Mode again.

Controlling TVs with the remote

You can adjust the remote's signal to control your TV.

Notes

- Depending on the connected unit, you may not be able to control your TV with some or all of the buttons below.
- If you enter a new code number, the code number previously entered will be erased.

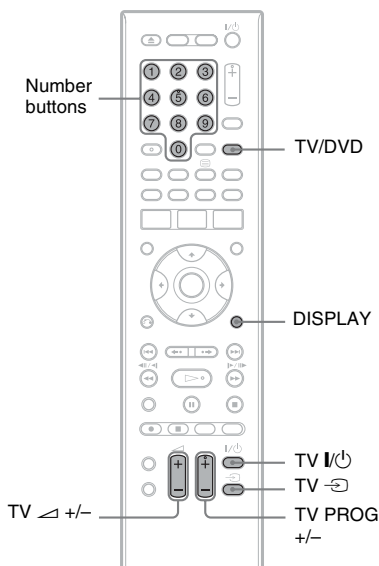

1 Hold down TV I/O located at the bottom of the remote.

Do not press the I/O button at the top of the remote.

2 With TV I/O pressed down, enter the TV's manufacturer code using the number buttons.

For instance, to enter "09," press "0" then "9." After you enter the last number, release the TV I/O button.

Code numbers of controllable TVs

If more than one code number is listed, try entering them one at a time until you find the one that works with your TV.

Manufacturer	Code number
Sony	01 (default)
Grundig	11
Hitachi	24
ITT	15, 16
JVC	33
LG/Goldstar	76
Loewe	45
Nokia	15, 16, 69, 73
Panasonic	17, 49
Philips	06, 07, 08, 72
Saba	12, 13, 74
Samsung	22, 23, 71
Sanyo	25
Sharp	29
Telefunken	36
Thomson	43, 75
Toshiba	38

The remote performs the following:

Buttons	Operations
TV I/O	Turns your TV on or off.
TV \triangleleft (volume) +/-	Adjusts the volume of your TV.
TV PROG +/-	Selects the programme position on your TV.
TV \Rightarrow (input select)	Switches your TV's input source.

To operate the TV/DVD button (for SCART connections only)

The TV/DVD button switches between TV mode and DVD mode. Press the TV/DVD button when in stop mode or no menu appears on the TV screen. Point your remote at the recorder when using this button.

TV mode: switch to this when you use the TV's tuner mainly. When you start playback, the input source for the TV is set to the recorder automatically.

DVD mode: switch to this when you use the recorder's tuner mainly.

To check the current mode, press DISPLAY (page 43).

If you have a Sony DVD player or more than one Sony DVD recorder

If the supplied remote interferes with your other Sony DVD recorder or player, set the command mode number for this recorder and the supplied remote to one that differs from the other Sony DVD recorder or player after you have completed "Step 7: Easy Setup."

The default command mode setting for this recorder and the supplied remote is "3 (Default setting)."

You can check the current Command Mode in the front panel display. For details, see page 141.

The default command mode setting for this recorder and the supplied remote is "3 (Default setting)."

The remote does not function if different command modes are set for the recorder and remote. Set the same command mode.

Changing programme positions of the recorder using the remote

You can change programme positions of the recorder using the number buttons.

Example: for channel 50

Press "5," "0," then press ENTER.

Hint

If the aerial cables are connected to both DIGITAL AERIAL IN and ANALOG AERIAL IN jacks, you can switch between digital broadcasting and analogue broadcasting using the INPUT button.

Step 7: Easy Setup

Make the basic adjustments by following the on-screen instructions in “Easy Setup.” Be careful not to disconnect the cables or exit the “Easy Setup” function during this procedure.

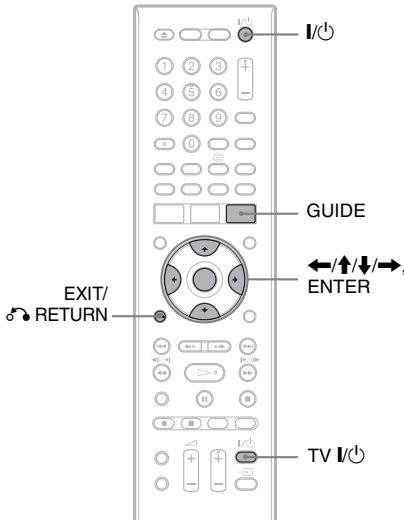

1 Turn on the recorder and your TV. Then switch the input selector on your TV so that the signal from the recorder appears on your TV screen.

The “Language” display appears.

- If the “Language” display does not appear, select “Easy Setup” in the “Basic” setup from “Initial Setup” in the System Menu (page 125).

2 Select a language for the on-screen displays using ←/↑/↓/→, and press ENTER.

The initial settings message appears.

3 Select “Start” using ↑/↓, and press ENTER.

Follow the on-screen instructions to make the following settings.

◆ Aerial Power (for RDR-HXD795/HXD895/HXD995/HXD1095 (except models for the UK) only)

Selects whether to supply the power to the indoor aerial connected to the DIGITAL AERIAL IN jack.

- To supply the power whether the recorder is turned on or in standby, select “On.”
- To supply the power only when the recorder is turned on, select “Auto.”
- Select “Off” to not supply the power.

◆ D.TV Auto Channel Setting

- If the aerial cable is connected to the DIGITAL AERIAL IN jack (hookup A or B), select “Auto Scan.” Then, select your country/region using ←/→, and press ENTER. The recorder will automatically capture and store the available TV and Radio channels.
- If the aerial cable is connected to the ANALOG AERIAL IN jack (hookup C or D) only, select “Do not set.”

For details, see page 18.

◆ A.TV Auto Channel Setting

- If the aerial cable is connected to the ANALOG AERIAL IN jack (except hookup A) and the TV is connected to this recorder not using SMARTLINK, select “Auto Scan.” Then, select your country/region using ←/→, and press ENTER. The programme position order will be set according to the country/region you set.

- If the aerial cable is connected to the ANALOG AERIAL IN jack (except hookup A) and the TV is connected to this recorder with SMARTLINK, select “Download from TV” (For details, refer to the operating instructions supplied with your TV). Then, select your country/region using \leftarrow/\rightarrow , and press ENTER. The tuner preset data will be downloaded from your TV to this recorder.
- If the aerial cable is connected to the DIGITAL AERIAL IN jack (hookup A) only, or to skip this setting, select “Do not set.” Then, select your country/region using \leftarrow/\rightarrow , and press ENTER.
To set the programme positions manually, see page 126.

For details, see page 18.

◆ Clock Setting

The recorder will automatically set the clock when any digital channels have been scanned and stored. If the clock has already been set, this setting is skipped and the “EPG Type Select” setting screen appears.

- Select “Auto” when a programme position in your local area broadcasts a time signal. The “Auto Clock Setting” display appears.
Select a programme position that carries a time signal and then “Start” using $\leftarrow/\rightarrow/\downarrow$, and press ENTER. If a clock signal cannot be found, press \curvearrowright RETURN, and set the clock manually.
- Select “Manual” to set the clock manually. The “Manual Clock Setting” display appears.

- 1 Select the time zone for your area or GMT (Greenwich Mean Time) using \leftarrow/\rightarrow , and press \downarrow .
- 2 Select “On” using \leftarrow/\rightarrow if you are now on summer time, and press ENTER.
- 3 Set the day, month, year, hour and minutes using $\leftarrow/\uparrow/\downarrow/\rightarrow$, and press ENTER to start the clock.

◆ EPG Type Select

Select the EPG (Electronic Programme Guide) type to use.

If no programme positions for digital broadcasts are found after scanning, the “EPG Type Select” display does not appear. The EPG type is automatically set to the country/area you select when setting the programme positions.

- Select “Guide (Digital)” to use the digital electronic programme guide (see page 50).
Select “Guide (Digital)” if you receive only digital broadcasts.

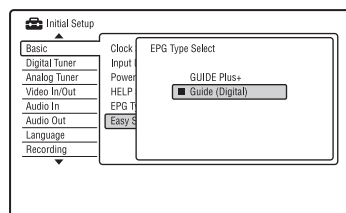

- Select “GUIDE Plus+” to use the Gemstar GUIDE Plus+ electronic programme guide (see page 61).

◆ TV Type (page 137)

- If you have a widescreen TV, select “Wide (16:9).”
- If you have a standard TV, select “Standard (4:3).” This will determine how “widescreen” images are displayed on your TV.

◆ Progressive

When you connect a progressive format TV to this recorder using the COMPONENT VIDEO OUT jacks, select “Compatible.”

◆ HDD caution messages

Read the HDD caution messages, and press ENTER.

4 Select “Finish Setup” using \uparrow/\downarrow , and press ENTER.

“Easy Setup” is completed. Go to “Setting up the GUIDE Plus+® system (For analogue broadcasting/in areas with GUIDE Plus+ only)” (page 32) to use the Gemstar GUIDE Plus+ electronic programme guide.

To return to the previous step

Press \curvearrowright RETURN.

Hint

If you want to run “Easy Setup” again, select “Easy Setup” in the “Basic” setup from “Initial Setup” in the System Menu (page 125).

Setting up the GUIDE Plus+[®] system (For analogue broadcasting/in areas with GUIDE Plus+ only)

Follow the instructions below to set up the GUIDE Plus+ system and use the connected set top box receiver.

1 Press GUIDE.

The GUIDE Plus+ system “Basic Setup” appears.

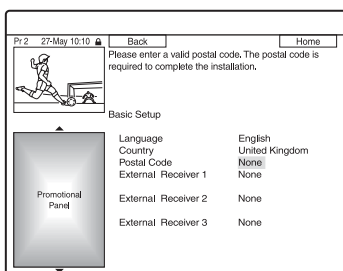

2 Select an item using \uparrow/\downarrow , and press ENTER. Then set each item.

◆ Language

Select a language for the on-screen displays using \uparrow/\downarrow , and press ENTER.

◆ Country

Select a country/area using \uparrow/\downarrow , and press ENTER.

◆ Postal Code

Enter your postal code using $\leftarrow/\uparrow/\downarrow/\rightarrow$, and press ENTER.

If “Country” is set to “Others,” you cannot enter a postal code and the GUIDE Plus+ system will not search for a host channel.

- If you do not need to set up the GUIDE Plus+ system, press SYSTEM MENU to exit.
- Even if you cannot use the GUIDE Plus+ system where you live, you can still set up a manual recording. See “Setting the timer manually (Schedule)” on page 68.

◆ External Receiver 1/External Receiver 2/External Receiver 3 (only when connecting the set top box receiver)

- 1 Press ENTER to select “Continue.”
- 2 Select the set top box receiver type using \uparrow/\downarrow , and press ENTER.
- 3 Select the provider using \uparrow/\downarrow , and press ENTER.
- 4 Select the receiver brand using \uparrow/\downarrow , and press ENTER.

If you select “Other providers,” you can select a receiver brand from a list of all available brands.

If your receiver brand is not on the list, select “???”

The receiver brand list is automatically updated, so your receiver may be available at a later date. Select your brand when it becomes available. Until then, use “???”

- 5 Select the connection you used for your set top box receiver using \uparrow/\downarrow , and press ENTER.
When the set top box receiver is connected to the recorder using hookup C with both an aerial cable and a SCART cord, select either “Line1” or “Antenna.”
The display asks for confirmation.
- 6 Press ENTER to select “Continue.”
The Video Window switches to the specified programme position.
- 7 Select “YES” using \uparrow/\downarrow , and press ENTER.
The display asks for confirmation.
If the Video Window does not switch to the specified programme position, select “NO” and press ENTER until the Video Window switches to the specified programme position.

3 Turn off the recorder to receive GUIDE Plus+ system data.

To receive GUIDE Plus+ system data your recorder must be turned off when not in use. If your recorder is connected to a set top box receiver, be sure to leave the set top box receiver turned on. After initial setup, it may take up to 24 hours to begin receiving TV programme listings.

Note

You cannot set tuner system or “OSD Language” to a country/region or language that is not supported by the GUIDE Plus+ system.

If you cannot get the recorder to control your set top box receiver

Check the connection and position of the set top box controller (page 20).

If your set top box receiver still does not operate with this recorder, refer to the instructions supplied with your set top box receiver and contact your cable or satellite company to see if they can provide you with a compatible set top box receiver.

Notes

- The list of external receivers controllable by the GUIDE Plus+ system is updated constantly and is distributed through GUIDE Plus+ system data signals. Since the time your recorder has been produced and the time you installed your recorder for the first time, new external receiver codes might have been added.
- If the external receiver is still not on the list or is not controlled properly by the recorder, please call Customer Support to report the brand and model of your external receiver.

To fix the set top box controller to your set top box receiver

Once you have confirmed that the set top box controller controls your set top box receiver, fix it in place.

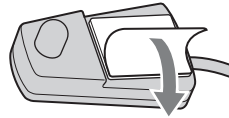

- 1 Remove the backing on the double-sided tape.

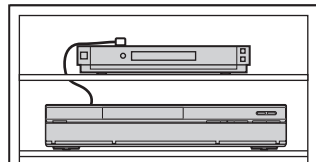

- 2 Attach it so that the set top box controller is directly above the remote control sensor on your set top box receiver.



To change the basic GUIDE Plus+ settings

- 1 Press GUIDE.
- 2 Select “Setup” in the Menu Bar using /, and press ENTER.
- 3 Select “Basic Setup” using , and press ENTER.
- 4 Repeat from step 2 of “Setting up the GUIDE Plus+[®] system (For analogue broadcasting/in areas with GUIDE Plus+ only)” on page 32.

Connecting a VCR or Similar Device

After disconnecting the recorder's mains lead from the mains, connect a VCR or similar recording device to the LINE IN jacks of this recorder.

Use the DV IN jack on the front panel if the equipment has a DV output jack (i.LINK jack) (page 98).

For details, refer to the instruction manual supplied with the connected equipment.

To record on this recorder, see "Recording from Connected Equipment" on page 60.

Connecting to the LINE 1/DECODER jack

Connect a VCR or similar recording device to the LINE 1/DECODER jack of this recorder.

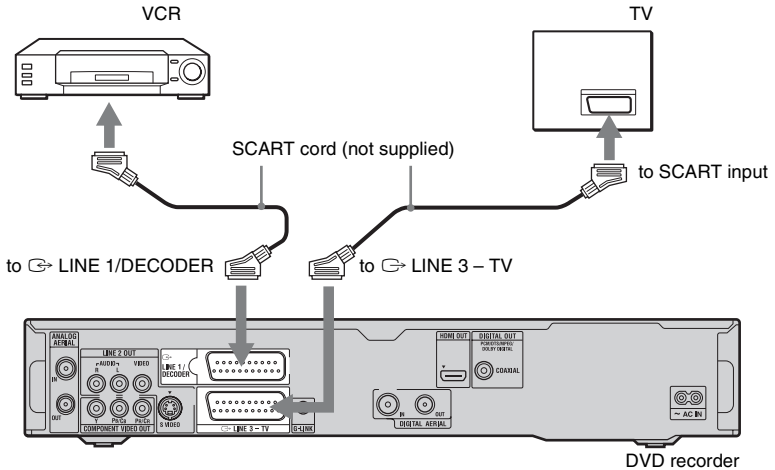

Notes

- Pictures containing copy protection signals that prohibit any copying cannot be recorded.
- If you pass the recorder signals through a VCR, you may not receive a clear image on your TV screen.



Be sure to connect your VCR to the DVD recorder and to your TV in the order shown below. To watch video tapes, watch the tapes through a second line input on your TV.

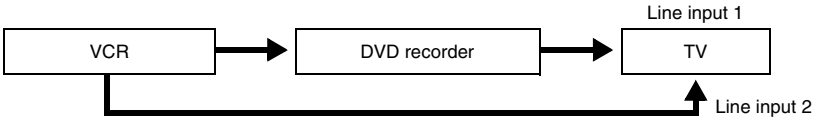

- The SMARTLINK features are not available for devices connected via the DVD recorder's LINE 1/DECODER jack.
- To watch the connected VCR or similar device's pictures through the recorder while the recorder is in standby mode, set "Power Save" to "Off" (default) in the "Basic" setup (page 125).
- When you record to a VCR from this DVD recorder, do not switch the input source to TV by pressing the TV/DVD button on the remote.
- If you disconnect the recorder's mains lead, you will not be able to view the signals from the connected VCR.

Connecting to the LINE 2 IN jacks on the front panel

Connect a VCR or similar recording device to the LINE 2 IN jacks of this recorder. If the equipment has an S-video jack, you can use an S-video cord instead of an audio/video cord.

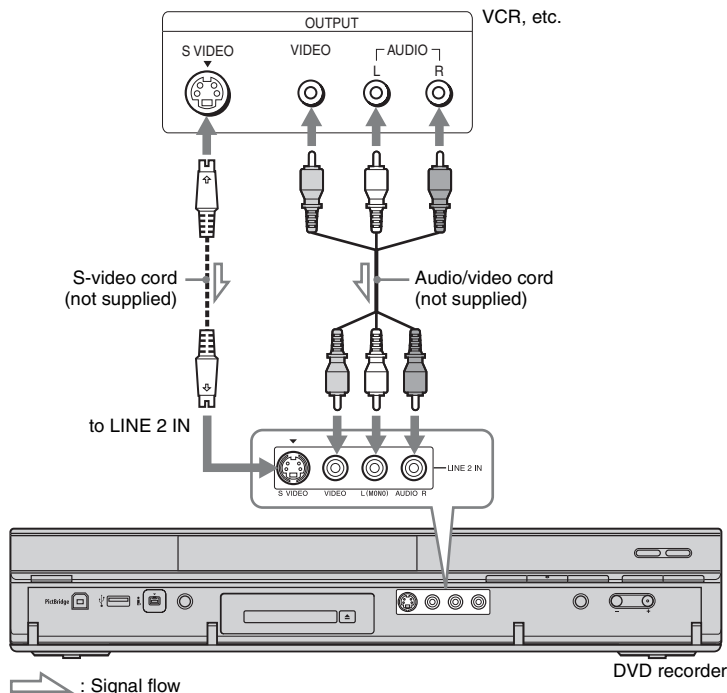

Hint

When the connected equipment outputs only monaural sound, connect to only the L(MONO) and VIDEO input jacks on the front of the recorder. Do not connect the R input jack.

Notes

- Do not connect the yellow LINE IN (VIDEO) jack when using an S-video cord.
- Do not connect the output jack of this recorder to another equipment's input jack with the other equipment's output jack connected to the input jack of this recorder. This may cause noise (feedback).
- Do not connect more than one type of video cord between the recorder and your TV at the same time.

Connecting an External Decoder

You can watch or record external decoder (PAY-TV/Canal Plus analogue decoder) programmes if you connect a decoder (not supplied) to the recorder. Disconnect the recorder's mains lead from the mains when connecting the decoder. Note that when you set "LINE 1 In" to "Decoder" in step 7 of "Setting external decoder (PAY-TV/Canal Plus analogue decoder) programme positions" (page 37), you will not be able to select "L1" because Line 1 will become a dedicated line for the decoder.

Connecting a decoder

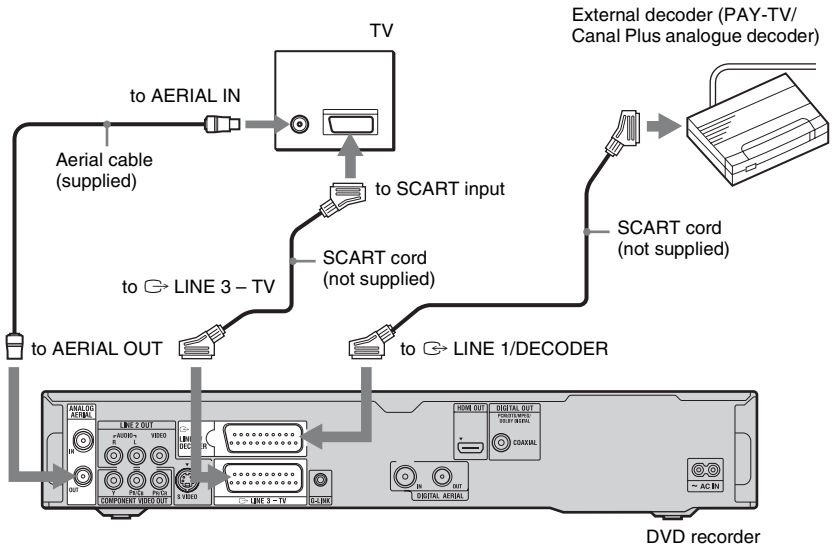

Setting external decoder (PAY-TV/Canal Plus analogue decoder) programme positions

To watch or record PAY-TV/Canal Plus analogue programmes, set your recorder to receive the programme positions using the on-screen display.

In order to set the programme positions correctly, be sure to follow all of the steps below.

- 1** Press **SYSTEM MENU**.
The System Menu appears.
- 2** Select "Initial Setup," and press **ENTER**.
- 3** Select "Video In/Out," and press **ENTER**.
- 4** Select "LINE 3 Out," and press **ENTER**.

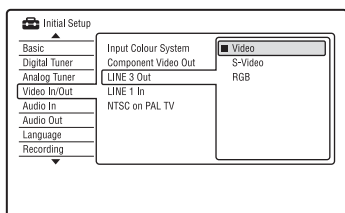

- 5** Press **↑/↓** to select "Video" or "RGB," and press **ENTER**.
- 6** Select "LINE 1 In," and press **ENTER**.
- 7** Press **↑/↓** to select "Decoder," and press **ENTER**.
- 8** Press **↶** RETURN to return the cursor to the left column.
- 9** Select "Analog Tuner," and press **ENTER**.
- 10** Select "Manual CH Setting," and press **ENTER**.
- 11** Select "Next Screen," and press **ENTER**.

- 12** Select your country/region, and press **ENTER**.

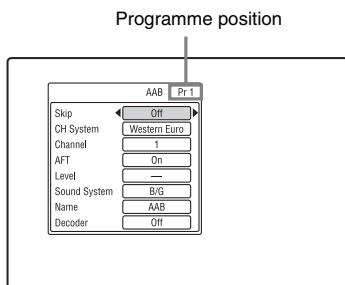

- 13** Select the desired programme position using **PROG +/-** or number buttons.
- 14** Select "Channel" using **↑/↓**, and select the external decoder programme position using **←/→**.
- 15** Select "Sound System" using **↑/↓**, and select an available TV system, B/G, D/K, I, or L using **←/→**.
To receive broadcasts in France, select "L."
- 16** Select "Decoder" using **↑/↓**, and select "On" using **←/→**.
- 17** Press **SYSTEM MENU** to exit the menu.

To return to the previous step
Press **↶** RETURN.

Notes

- If you disconnect the recorder's mains lead, you will not be able to view the signals from the connected decoder.
- To watch the connected external decoder (PAY-TV/Canal Plus analogue decoder) programmes during recording, press the **PROGRAM +** button on the recorder ("SCART THRU" appears on the front panel display). To return to the previous display, press the **PROGRAM -** button on the recorder ("SCART NORM" appears on the front panel display). The recorder automatically switches to the programme tuned by the recorder's tuner after the recording has finished. To watch the connected external decoder (PAY-TV/Canal Plus analogue decoder) programmes while the recorder is in standby mode, set "Power Save" to "Off" (default) in the "Basic" setup (page 125).

1. Inserting a Disc

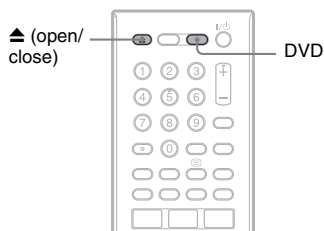

- 1 Press **DVD**.
- 2 Press **▲ (open/close)**, and place a disc on the disc tray.



Recording/playing side facing down

- 3 Press **▲ (open/close)** to close the disc tray.

Wait until "LOAD" disappears from the front panel display.

Unused DVDs are formatted automatically.

- For DVD-RW discs
DVD-RWs are formatted in the recording format (VR mode or Video mode) set by "Format DVD-RW" of "Basic" in the "Disc Setup" setup (page 123).
- For DVD-R discs
DVD-Rs are automatically formatted in Video mode. To format an unused DVD-R in VR mode, format the disc in the "Format" setup (page 49) **before** you make a recording.

If the disc is recordable on this recorder, you can manually re-format the disc to make a blank disc (page 49).

2. Recording a Programme



This section introduces the basic operation to record a current TV programme to the hard disk (HDD) or to a disc (DVD). For an explanation of how to make timer recordings, see page 53 (Digital broadcasting) or page 66 (Analogue broadcasting).

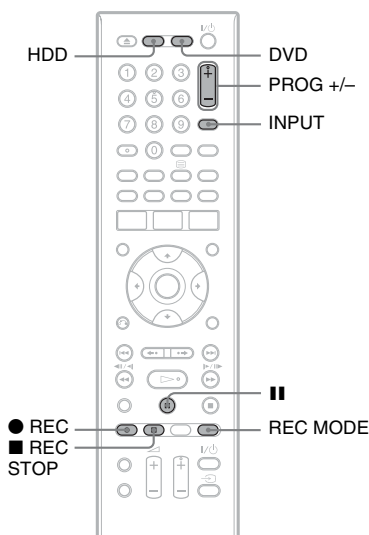

- 1 Press **HDD** or **DVD**.
If you want to record to a DVD, insert a recordable DVD.
- 2 Press **PROG +/-** to select the programme position or input source you want to record.

To switch between digital broadcasting and analogue broadcasting, press **INPUT**. (Available when the aerial cables are connected to both DIGITAL AERIAL IN and ANALOG AERIAL IN jacks only.)

3 Press REC MODE repeatedly to select the recording mode.

Each time you press the button, the display on the TV screen changes as follows:

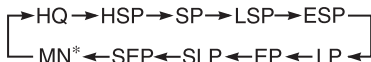

* Available when “Manual Rec. Mode” is set to “On (go to setup)” in the “Recording” setup (page 135).

For more details about the recording mode, see page 154.

4 Press ● REC. Recording starts.

To stop recording

Press ■ REC STOP.

To pause recording

Press ■■.

To resume recording, press ■■ again.

To watch another TV programme while recording

If your TV is connected to the LINE 3 – TV jack, set your TV to the TV input using the TV/DVD button and select the programme you want to watch. If your TV is connected to the LINE 2 OUT or COMPONENT VIDEO OUT jacks, set the TV to TV input using the TV button (page 28).

TV Direct Rec. (for SMARTLINK connections only)

When the TV is turned on and the recorder is turned off, press TV PAUSE. The recorder automatically turns on and starts recording what you are watching on the TV to the HDD.

Set “TV Pause” to “TV’s Tuner” in the “Options 2” setup (page 142).

Notes

- To turn off the TV Direct Rec. function, set “SMARTLINK” to “Pass Through” in the “Options” setup (page 141).
- Some buttons, such as the TITLE LIST button or button, do not work when “TV” appears in the front panel display.
- If you press the button while recording, the recorder stops recording and turns off.
- After pressing the ● REC button, it may take a short while to start recording.
- It may take a short while for recorder to stop or pause recording.
- You cannot change the recording mode while recording.
- Programmes are recorded in the original aspect ratio when recording to the HDD (when “HDD Recording Format” is set to “Video Mode Off” in the “Recording” setup (page 137))/DVD-RWs/DVD-Rs (VR mode).
- When recording to DVD-R DLs (Video mode), the title is divided when the layer switches.
- If there is a power failure, the programme you are recording may be erased.
- You cannot watch a PAY-TV/Canal Plus programme while recording another PAY-TV/Canal Plus programme.
- To use the TV Direct Rec. function, you must first correctly set the recorder’s clock.

Checking the disc status while recording

You can check the recording information such as recording time or disc type.

Press DISPLAY during recording.

The recording information appears.

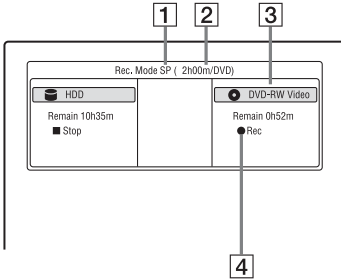

- 1 Recording mode
- 2 Recording time
- 3 Disc type/format
- 4 Recording status

To turn off the display

Press DISPLAY repeatedly.

3. Playing the Recorded Programme (Title List)



To play a recorded title, select the title from the Title List.

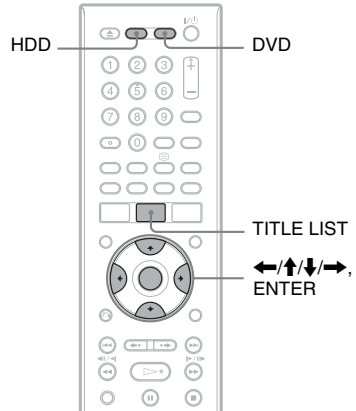

1 Press HDD or DVD.

If you select DVD, insert a DVD (see “1. Inserting a Disc” on page 38).

Playback starts automatically depending on the disc.

2 Press TITLE LIST.

Example: 4-Title List for HDD

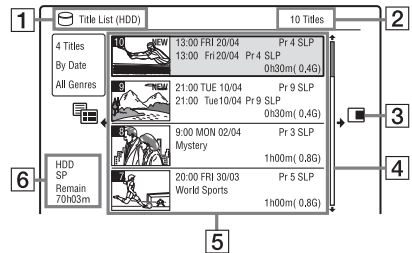

- 1 Disc type:
Displays the media type, HDD or DVD.
- 2 Total number of titles
- 3 Sub-menu:
Press **→** to display the sub-menu.
The sub-menu displays options applicable only to the selected item. The displayed options differ depending upon the model, situation, and disc type.

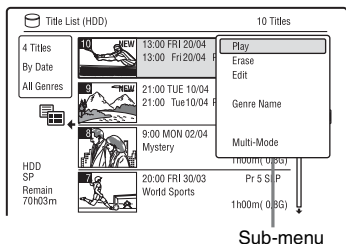

- 4 Scroll bar:
Appears when all of the titles do not fit on the list. To view the hidden titles, press **↑/↓**.
 - 5 Title information:
“Recording”: Indicates that the title is currently being recorded.
🔒: Indicates a protected title.
NEW: Indicates that the title is newly recorded (not played back) (HDD only).
COPY: Press DISPLAY to display “COPY.” “COPY” indicates titles containing “Copy-Once” copy protection signals (HDD only) (page 157).
🔄: Indicates that the title is recorded using the Update function.
Genre icons: Indicates the title’s genre (HDD only).
🗣️: Indicates a bilingual programme (HDD only).
 - 6 Remaining time of the current disc in the current recording mode (example: SP mode)
- 3 Select a title using **↑/↓**, and press ENTER.**
Playback starts from the selected title.

To stop playback

Press **■** (stop).

To scroll the list display by page (Page mode)

Press **◀◀/▶▶** while the Title List is displayed. Each time you press **◀◀/▶▶**, the Title List changes to the previous/next page of titles.

About the Title List for DVD-RWs/DVD-Rs (VR mode)

You can switch the Title List to show Original or Playlist titles.

- 1 Press **←** while the Title List is displayed.
- 2 Select “Play List” using **↑/↓**, and press ENTER.
- 3 Select “Original” or “Play List” using **↑/↓**, and press ENTER.

To change the title order for HDD (Sort Titles)

- 1 Press **←** while the Title List is displayed.
- 2 Select “Sort Titles” using **↑/↓**, and press ENTER.
- 3 Select the item using **↑/↓**, and press ENTER.

Order	Sorted
By Date	In order of when the titles were recorded. The title that is recorded most recently is listed at the top.
Unseen Title	In order of when the titles were recorded. The title that is recorded most recently and has not been played is listed at the top.
By Title	In alphabetical order.
By Number	In order of recorded title number.

To search for a title by genre (HDD only)

- 1 Press **←** while the Title List is displayed.
- 2 Select “Genre” using **↑/↓**, and press ENTER.
- 3 Select a genre using **↑/↓**, and press ENTER.

To change a title thumbnail picture (Thumbnail)

After recording, the first scene of the recording (the title) is automatically set as the thumbnail picture.

You can select a favourite scene for the thumbnail picture shown in the Title List.

- 1 Press TITLE LIST.
For DVD-RWs/DVD-Rs (VR mode), switch the Title List to show Original or Playlist titles, if necessary.
- 2 Select a title using **↑/↓**, and press **→**.
The sub-menu appears.
- 3 Select “Edit” using **↑/↓**, and press ENTER.
- 4 Select “Set Thumbnail” using **↑/↓**, and press ENTER.
The display for setting the thumbnail point appears and the title starts to play.
- 5 While watching the playback picture, press **▷**, **⏏**, **◀◀**, **◀**, **▶**, **▶▶** or PLAY MODE to select the scene you want to set for a thumbnail picture, and press **⏏**.
Playback pauses.
- 6 Select “OK” using **↑/↓**, and press ENTER.
The scene is set for the title’s thumbnail picture.
To return to the Title List, press **↶** RETURN.

To change the thumbnail preview mode (Set Preview) (HDD only)

You can select “Quick Preview” or “Normal” for the thumbnail preview mode in the Title List. Set “Set Preview” in the “Options” setup (page 142).

To switch to the 8 Title List

- 1 Press **←** while the Title List is displayed.
- 2 Select “Title View” using **↑/↓**, and press ENTER.
- 3 Select “8 Titles” using **↑/↓**, and press ENTER.
Detailed information, including the resumption time, for the selected title is shown below the list.

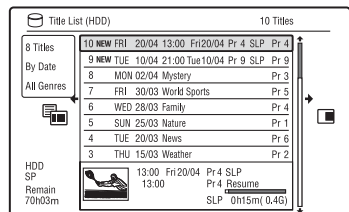

To turn off the Title List

Press TITLE LIST.

Notes

- The title names may not appear for DVDs created on other DVD recorders.
- It may take a few seconds for the thumbnail pictures to be displayed.
- After editing, the title thumbnail picture may change to the first scene of the recording (title).
- After dubbing, the title thumbnail picture set on the source recording is cancelled.
- In some areas, letters or symbols that the recorder cannot record or display are replaced with “*.”

Displaying the playing time and play information

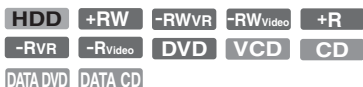

You can check the playing time of the current title, chapter, track, or disc. Also, you can check the disc name recorded on the DVD/CD.

Press DISPLAY repeatedly.

The displays differ depending on the disc type or playing status.

In stop mode

Example: DVD-RW in VR mode

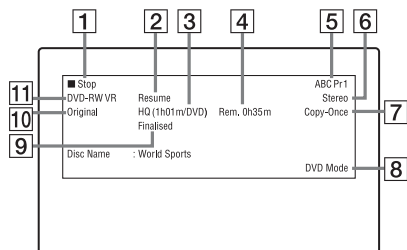

During playback

Example: DVD-R in Video mode

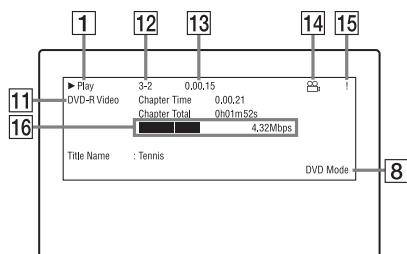

- 1 Playing status
- 2 Shows that the Resume Play is available (page 74).
- 3 Current selected recording mode (maximum DVD recording time) (page 154)
- 4 Remaining time

- 5 Station name and programme position number
- 6 Audio setting for the current programme
- 7 Recording restrictions for the current programme
- 8 TV mode or DVD mode (page 29)
- 9 Disc information
- 10 Title type (Original or Playlist) for DVD-RW/DVD-R in VR mode
- 11 Disc type/format (page 151)
Displays the finalised disc in Video mode as "DVD-VIDEO."
- 12 Title number-Chapter number (page 80)
- 13 Playing time
- 14 Multi-angles indicator (page 75)
- 15 Copy-protected indicator (page 157)
- 16 Data transfer bar and rate

To turn off the display

Press DISPLAY repeatedly.

🔧 Hints

- When "On Screen Display" is set to "On" (default) in the "Options" setup (page 141), information automatically appears on the screen when the recorder is operated.
- To increase disc space, see "To open up disc space" (page 82).

📌 Note

Playing time of MP3 audio tracks may not be displayed correctly.

4. Changing the Name of a Recorded Programme



You can label a DVD, title, or programme by entering characters. You can enter up to 64 characters for a title recorded in the HDD/DVD-RW/DVD-R (VR mode), 40 characters for a title recorded in the DVD+RW/DVD-RW (Video mode)/DVD+R/DVD-R (Video mode), but the actual number of characters displayed in the menus such as the Title List will vary. The steps below explain how to change the name of the recorded programme.

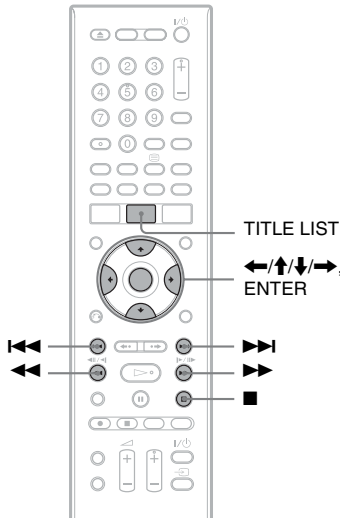

- 1 Press **TITLE LIST**.
- 2 Select a title using **↑/↓**, and press **→**.
The sub-menu appears.
- 3 Select **"Edit"** using **↑/↓**, and press **ENTER**.

- 4 Select **"Title Name"** using **↑/↓**, and press **ENTER**.

The display for entering characters appears.

The current name is displayed at the input row.

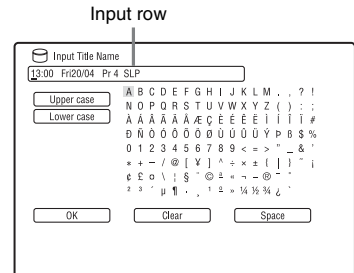

- 5 Move the cursor to the point where you want to insert the character using **←/→**.

To erase all of the characters, press and hold **CLEAR** for 2 seconds or more.

- 6 Select **"Upper case"** or **"Lower case"** using **←/→**.

The characters for the selected type are displayed.

- 7 Press **←/↑/↓/→** to select the character you want to enter, and press **ENTER**.

The selected character appears at the input row.

To insert a space, press **II** (or select **"Space,"** and press **ENTER**).

- 8 Repeat steps 6 and 7 to enter the remaining characters.

To erase a character, move the cursor to the character at the input row, and press **CLEAR** (or select **"Clear,"** and press **ENTER**).

To insert a character, move the cursor to the right of the point where you want to insert the character. Then select the character, and press **ENTER**.

To erase all of the characters, press and hold **CLEAR** for 2 seconds or more.

- 9 Press **■** (or select **"OK,"** and press **ENTER**).

To cancel the setting, press **↶** RETURN.

5. Labelling and Protecting a Disc

You can execute options effective for the entire disc in the “Disc Setup” setup.

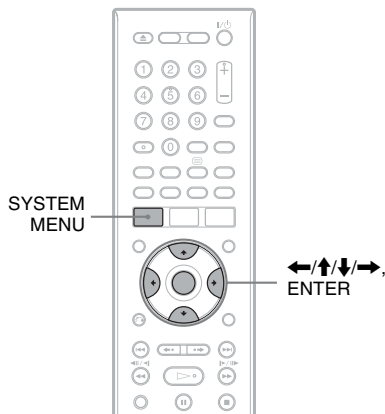

Labelling a disc

- +RW** **-RWVR** **-RWVideo** **+R** **-RVR**
- RVideo**

- 1** Insert a disc.
See “1. Inserting a Disc” on page 38.
- 2** Press **SYSTEM MENU**.
The System Menu appears.
- 3** Select “Disc Setup,” and press **ENTER**.

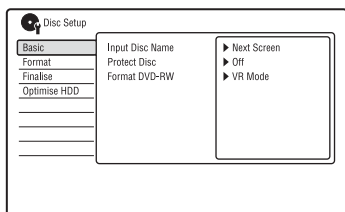

- 4** Select “Basic,” and press **ENTER**.

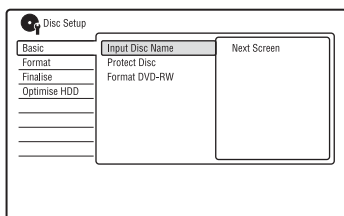

- 5** Select “Input Disc Name,” and press **ENTER**.
- 6** Select “Next Screen,” and press **ENTER**.

Enter the disc name (page 44).
You can enter up to 64 characters for a DVD-RW/DVD-R (VR mode) disc name, and 40 characters for a DVD+RW/DVD-R (Video mode)/DVD+R/DVD-R (Video mode) disc name.

Note

The disc name may not appear when the disc is played on other DVD equipment.

Protecting a disc

- RWVR** **-RVR**

- 1** Insert a disc.
See “1. Inserting a Disc” on page 38.
- 2** Press **SYSTEM MENU**.
The System Menu appears.
- 3** Select “Disc Setup,” and press **ENTER**.

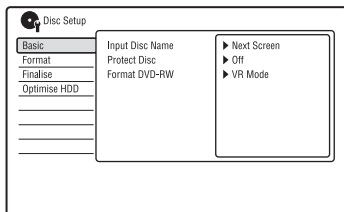

4 Select “Basic,” and press ENTER.

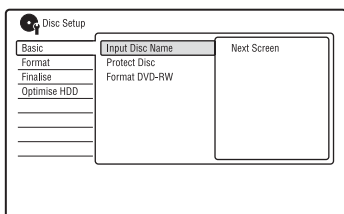

5 Select “Protect Disc,” and press ENTER.

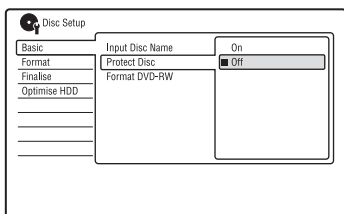

6 Select “On,” and press ENTER.

7 Press SYSTEM MENU to exit.

To cancel the protection

Select “Off” in step 6.

Hint

You can set protection for individual titles (page 83).

6. Playing the Disc on Other DVD Equipment (Finalise)

+RW **-RWVR** **-RWVideo** **+R** **-RVR**
-RVideo

Finalising is necessary when you play discs recorded with this recorder on other DVD equipment.

When you finalise a DVD+RW, DVD-RW (Video mode), DVD+R, or DVD-R (Video mode), a DVD menu will be automatically created, which can be displayed on other DVD equipment.

Before finalising, check the differences between the disc types in the table below.

Differences between disc types

+RW Discs are automatically finalised when removed from the recorder. However, you may need to finalise the disc for certain DVD equipment, or if the recording time is short. You can edit or record on the disc even after finalising.

-RWVR Finalising is unnecessary when playing a disc on VR format compatible equipment. Even if your other DVD equipment is VR format compatible, you may need to finalise the disc, especially if the recording time is short. You can edit or record on the disc even after finalising.

-RWVideo Finalising is necessary when playing on any equipment other than this recorder. After finalising, you cannot edit or record on the disc. If you want to record on it again, unfinalise (page 48) or reformat the disc (page 49). However, if you reformat the disc, all recorded contents will be erased.

-RVR

Finalising is necessary. The disc can be played only on equipment that supports DVD-R in VR mode. You can edit or record on the disc even after finalising (except DVD-R DL in VR mode).

+R**-RVideo**

Finalising is necessary when playing on any equipment other than this recorder. After finalising, you cannot edit or record on the disc.

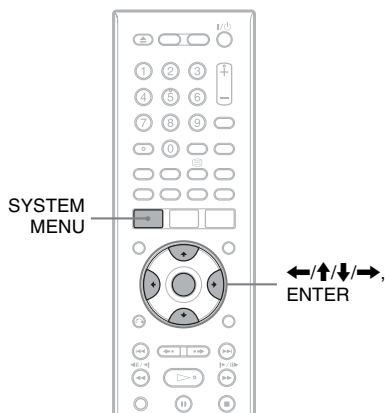

- 1 Insert a disc.**
See “1. Inserting a Disc” on page 38.
- 2 Press SYSTEM MENU.**
The System Menu appears.
- 3 Select “Disc Setup,” and press ENTER.**

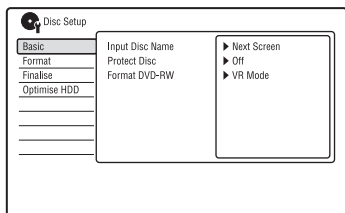

4 Select “Finalise,” and press ENTER.

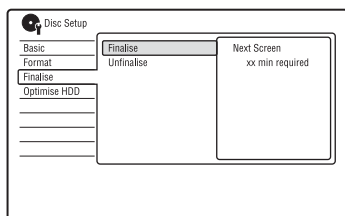

- 5 Select “Finalise,” and press ENTER.**
- 6 Select “Next Screen,” and press ENTER.**

For DVD-RW/DVD-R (VR mode), the recorder starts finalising the disc. Go to step 9.

- 7 (DVD+RW/DVD-RW (Video mode)/DVD+R/DVD-R (Video mode) only) Select a title menu style, and press ENTER.**

The menu appears in the selected title menu style when the “top menu” (or “menu” for a DVD+RW/DVD+R) is selected on the DVD equipment.

- 8 (DVD+RW/DVD-RW (Video mode)/DVD+R/DVD-R (Video mode) only) Select “Yes,” and press ENTER.**

The recorder starts finalising the disc.

- 9 Press SYSTEM MENU to exit.**

Hint

You can check whether the disc has been finalised or not. Press DISPLAY after step 1 (page 43).

Notes

- Depending on the condition of the disc, recording, or the DVD equipment, discs may not play even if the discs are finalised.
- The recorder may not be able to finalise the disc if it was recorded on another recorder.
- Inserting an unfinalised disc into other DVD equipment may damage the recorded contents.
- When using a DVD+RW, you can edit or record on the disc even after finalising. However, the title menu will not be displayed. Finalise the disc again to display the title menu.

Unfinalising a disc

-RWVR -RW_{video}

For DVD-RWs (Video mode)

DVD-RWs (Video mode) that have been finalised to prohibit additional recording or editing can be unfinalised to allow further recording or editing.

For DVD-RWs (VR mode)

If you cannot record or edit on a DVD-RW (VR mode) that has been finalised with other DVD equipment, unfinalise the disc.

Note

The recorder is not able to unfinalise DVD-RWs (Video mode) that have been finalised on another recorder.

1 Insert a disc.

See “1. Inserting a Disc” on page 38.

2 Press SYSTEM MENU.

The System Menu appears.

3 Select “Disc Setup,” and press ENTER.

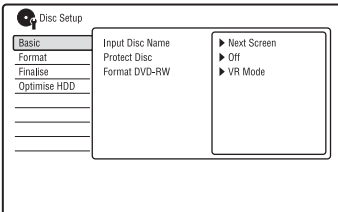

4 Select “Finalise,” and press ENTER.

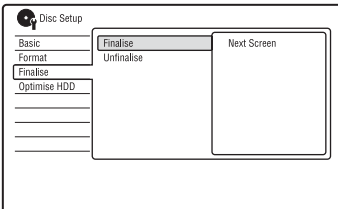

5 Select “Unfinalise,” and press ENTER.

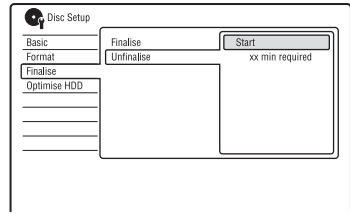

6 Select “Start,” and press ENTER.

The recorder starts unfinalising the disc. Unfinalising may take several minutes.

7. Reformatting a Disc

+RW **-RWVR** **-RWVideo** **-RVR** **-RVideo**

New discs are automatically formatted when inserted. If necessary, you can manually reformat a DVD+RW, DVD-RW, or DVD-R disc to make a blank disc. For DVD-RWs or DVD-Rs, you can select a recording format (VR mode or Video mode) according to your needs.

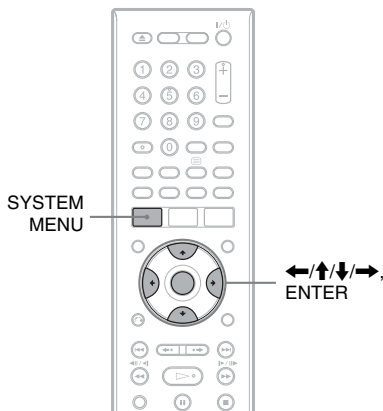

1 Insert a disc.

See “1. Inserting a Disc” on page 38.

2 Press SYSTEM MENU.

The System Menu appears.

3 Select “Disc Setup,” and press ENTER.

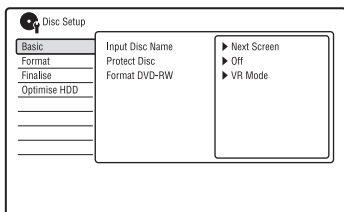

4 Select “Format,” and press ENTER.

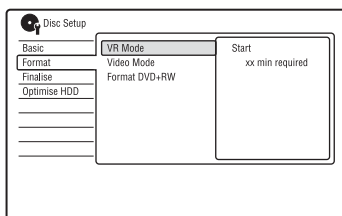

5 Select an item, and press ENTER.

“VR Mode”: Formats DVD-RWs/DVD-Rs in VR mode.

“Video Mode”: Formats DVD-RWs/DVD-Rs in Video mode.

“Format DVD+RW”: Formats DVD+RWs.

6 Select “Start,” and press ENTER.

All contents on the disc are erased.

💡 Hint

By reformatting, you can change the recording format on DVD-RWs, or record again on DVD-RWs that have been finalised.

📌 Note

You cannot reformat recorded DVD-Rs.

Viewing the EPG (Electronic Programme Guide) Display

The Electronic Programme Guide is a guide showing the television programme schedule for a day or more at a time on your television (via the Digital Terrestrial Television tuner included in this recorder).

The EPG provides a quick and easy way to:

- View a complete list of all available channels.
- View a channel list related to a chosen date or genre.
- Set a programme to be recorded (page 53).

Notes

- Digital Services availability and content depend on the broadcaster.
- Digital Services are not instantly available when the recorder is first turned on.
- In some areas, not all programme information is displayed if you display the EPG while recording.

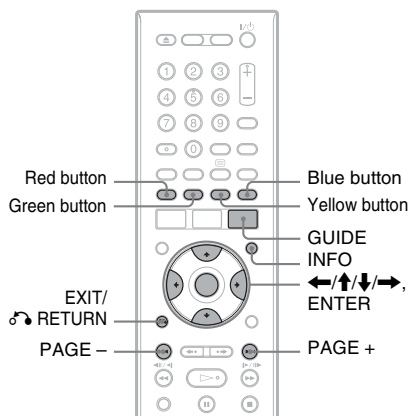

Press GUIDE.

This display consists of an information box and an 8-channel programme list covering a 30-minute period.

Example of EPG Display:

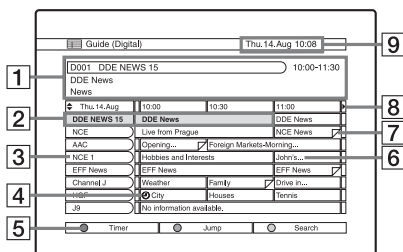

- 1 Indicates the currently selected channel number and station name with the programme title and genre.
- 2 Indicates the currently selected programme and allows you to move around the list. Press ENTER to watch the selected programme.
- 3 Channel name
- 4 Indicates if a timer recording is associated with the programme (page 53).
- 5 Colour buttons
Press the same colour button on the remote ("Timer," "Jump," and "Search").
- 6 Truncated programme title in case the name is too long to be displayed in the cell.
- 7 Indicates that short programmes that are not displayed on the list are scheduled.
- 8 Time slot
- 9 Indicates the current time and date.

Available buttons in the programme list

Buttons	Operations
←/↑/↓/→	Selects the desired item.
PAGE +/-	Displays the previous/next eight channels.
INFO	Displays the detailed information of the programme (page 51).
Colour buttons (red, yellow, green, blue)	Activates the same colour function on the screen.
↵ RETURN	Closes the display.

Programme Information

You can view descriptions of the programmes being broadcast now and next.

Displaying the programme information

1 Select a channel.

2 Press **INFO**.

The Information display appears showing a description of the current programme on view.

Available buttons in the Information display

Buttons	Operations
↑/↓	Toggles the display between description of the current/next programme.
←/→	Displays programme information for other channels.
ENTER	Displays the selected channel.
INFO	Displays the detailed programme information.

Viewing Teletext (not available in some areas)

You can view the Teletext that comes simultaneously with certain programmes.

Press  (**text**).

The Teletext screen appears.

You can also use any of colour buttons.

To exit the Teletext service

Press  (**text**) again.

Viewing a Digital Text Service (models for the UK only)

Many digital TV channels broadcast information via their text service. This digital service includes high-quality digital text and graphics along with advanced navigation options. Additionally, this recorder has access to dedicated text channels transmitted by the broadcasters.

Note

The appearance, content and navigation methods of all digital text services are decided by the broadcaster.

Selecting digital text from dedicated digital teletext channels

1 Select a dedicated channel that is broadcasting digital text.

You can search for a dedicated digital text channel using the “Electronic Programme Guide” (page 50).

The text page is displayed.

2 Once the text page is displayed (this may take some time), follow the on-screen instructions to obtain your required selection.

On some pages the TV programme may also be displayed on the text screen. On-screen instructions will inform you how to change the displayed programme.

If you are instructed to press “OK” or “Select” when viewing the text pages, press ENTER.

Selecting digital text from other channels

Digital text services may also be available on other digital channels. This is sometimes indicated by a small symbol on your TV screen, superimposed on the programme you are watching.



1 Select a channel.

2 Press (text) or the button indicated on screen by the broadcaster.

The text information appears.

3 Access required information using ///, the colour buttons and/or the number buttons.

To exit the text service

Follow the on-screen instructions, or press  (text) or EXIT/ RETURN.

To exit the text service

Follow the on-screen instructions, or press PROG +/-.

Timer Recording (EPG/ Series/Manual)

HDD +RW -RWVR -RWVideo +R
-RVR -RVideo

You can set the timer for a total of 32 programmes, up to 30 days in advance. Methods to set the timer include:

- EPG: Set a programme to be recorded based on the information provided by the EPG (Electronic Programme Guide) (page 53).
- Series Recording (models for the UK only): Automatically sets the recorder to record programmes in a series (page 55).
- Manual: Set the date, time, and programme position of the programme manually.

Before you start recording...

- Check that the disc has enough available space for the recording (page 43). For the HDD, DVD+RWs, and DVD-RWs, you can free up disc space by erasing titles (page 82).
- Adjust the recording picture quality if necessary (page 120).

Note

If digital teletext is operated or subtitles are displayed while recording, they will be recorded on the disc (page 135).

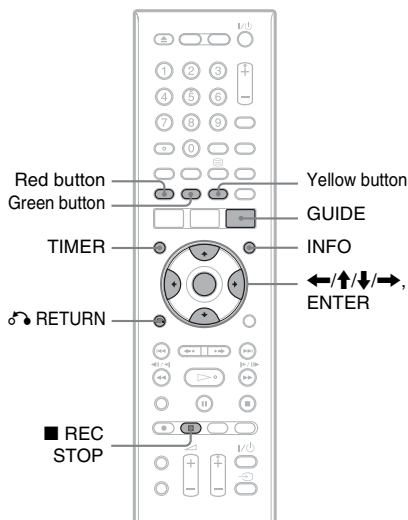

Recording TV programmes using the EPG

The EPG function is a feature that simplifies setting the timer. Just select the programme you want to record in the EPG display. The date, time, and channel of that programme are set automatically.

1 Press GUIDE.

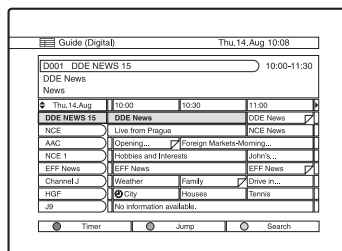

2 Select a programme using ←/↑/↓/→.

3 Press the red button.

The date, start and stop times, programme position, recording mode, etc., settings appear.

Pr/Ch	Date	Start	Stop	Extend	
D.TV 001	SUN 23/11	20:30	21:30	Off	OK

Detailed Settings

Record to	HDD	[Set Details]
Recording Mode	SP	[Set Title Name]
VPS/PDC	-----	[Cancel]
Update	-----	
Genre	No Category	
EPG Link	On	
Series Recording	-----	VPS/PDC 0/8

- If you want to change the setting, follow step 3 of “Setting the timer manually (Manual)” (page 56).
- (Models for the UK only) You can set “EPG Link” (page 56) or “Series Recording” (page 55).

4 Select “OK,” and press ENTER.

“” (red) appears next to the programme which is set for timer recording. Your recorder will automatically begin recording when the programme starts.





Unlike a VCR, there is no need to turn off the recorder before the timer recording starts.

- To modify the timer setting, see page 59.

To search for programmes by date (Jump)

- 1 Press the green button while the programme list is displayed.
- 2 Select a date in the “Date” row.
- 3 Select a time in the “Time” row.
- 4 Select “Jump,” and press ENTER.

To search for programmes by genre (Search)

- 1 Press the yellow button while the programme list is displayed.
- 2 Select a date in the “Date” row.
- 3 Select a time in the “Time” row.
- 4 Select the “Genre” row, and press ENTER.
- 5 Select a genre using ///, and press ENTER.
- 6 Select “OK,” and press ENTER.
- 7 Select “Search,” and press ENTER.

To stop recording during timer recording

Press .

Note that it may take a few seconds for the recorder to stop recording.

On-screen instructions may appear after pressing . In this case, follow the on-screen instructions.

Rec. Mode Adjust

If there is not enough available disc space for the recording, the recorder automatically adjusts the recording mode to enable the entire programme to be recorded. Set “Rec. Mode Adjust” to “On” in the “Recording” setup (page 135).

Hints

- When you select “AUTO” for the recording mode, the recorder automatically maximises the recording quality for the space available on the inserted disc (if recording to DVD), or to fit on to a blank DVD disc (if recording to HDD).
- This recorder is featured with an EPG timer auto extend functionality that allows EPG timer recordings to be made in case of an early start (before the scheduled start time) or late finish (after the scheduled end time).

Recording programmes using Series Recording (models for the UK only)

Series Recording is a feature which allows you to automatically record programmes in a series, using the information from the EPG. You can also search for programmes related to the timer settings.

Notes

- This function cannot be used when the broadcaster does not include series information with the programme data.
- The timer recordings with “Series Recording” set to “On” are recorded to the HDD.

1 After step 2 of “Recording TV programmes using the EPG,” press INFO.

The yellow button (“Series”) in the on-screen display is activated when the selected programme has series information.

2 Press the yellow button (“Series”).

Series programmes of the selected programme are listed.

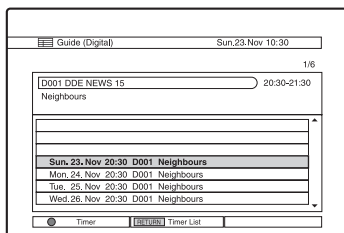

3 Press the red button.

The date, start and stop times, programme position, recording mode, etc., settings appear.

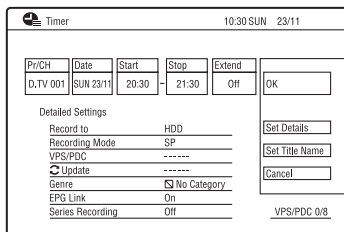

4 Select “Set Details,” and press ENTER.

5 Set “Series Recording” to “On,” and press ⏪ RETURN.

6 Select “OK,” and press ENTER.

The selected programme is set for recording and appears in the Timer List. The other programmes in the series will be set for recording (appear in the Timer List) as each previous recording is completed.

⏻ (red): Indicates that the whole programme is set to be recorded.

⏻ (grey): Indicates that the programme is set to be recorded using Series Recording.

- To modify the timer setting, see page 59.

About Split Programmes

Movies and other programmes that are split into 2 or more parts are called Split Programmes. If you set the timer for one part of a Split Programme, the other parts that start within 3 hours are automatically recorded. For example, if the first half is set to be recorded, the last half will be recorded automatically.

To use this function, set “EPG Link” to “On” (default) in step 4 above.

To search for programmes related to the timer settings (EPG Link)

When you set timer recording for a programme that has series information, you can search for related programmes such as listed below.

To use this function, set “EPG Link” to “On” (default) in step 4 above.

- Repeat programmes: You can search for repeat broadcasts of the programme which is set for timer recording (Alternate Search).
- Programmes in a series: You can search for the next programme in the series of a programme which is set for timer recording (Series Search).
- Recommended programmes: You can search for recommended programmes linked to the programme which is set for timer recording (Recommendation Search).

1 Press **TIMER**.

2 Select the timer setting, and press **→**.

3 When the following options appear in the sub-menu, select an option, and press **ENTER**.

“Alternate Search”: Searches for repeat programmes.

“Series Search”: Searches for programmes in a series.

“Recommendation Search”: Searches for programmes recommended by broadcaster as a link for current series.

To set the programme for recording, follow the instructions for “Recording TV programmes using the EPG” (page 53) from step 2.

◆ About EPG Link

The EPG Link function automatically updates the date, start and stop times of timer settings when the broadcaster changes them and updates the EPG accordingly. For example, if a programme with timer setting starts before or ends after the scheduled time, the timer setting is automatically extended to record the whole programme.

To use the EPG Link function, set “EPG Link” to “On” (default) in step 4 above.

🔔 Notes

- Only the earliest part of the Split Programme is displayed on the Timer List.
- When “EPG Link” is set to “On,” you cannot change the date, start and stop time settings.

Setting the timer manually (Manual)

1 Press **TIMER**.

The “Timer List” display appears.

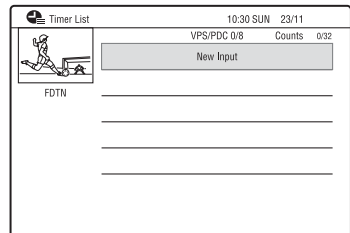

2 Select the “New Input” row, and press **ENTER**.

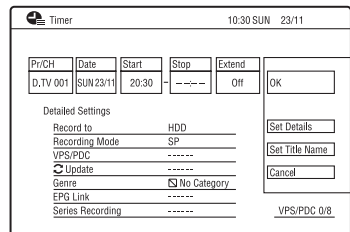

3 Select an item using **←/→** and adjust using **↑/↓**. Then press **ENTER**.

The adjustable items are listed below.
 “Pr/CH”: Sets the programme position.
 An analogue programme can also be selected.

“Date”: Sets the date (up to 30 days later). Select a recording pattern by pressing **↑** repeatedly to set the timer for the same daily or weekly programmes.

“Start”: Sets the start time.

“Stop”: Sets the stop time.

“Extend”: Sets duration when a timer recording is in progress. If the programme set to be recorded daily or weekly is extended, the manually extended time set here will be added to the subsequent timer recording times. Note that when “VPS/PDC” is set to “On,” you cannot make the “Extend” setting.

- If you make a mistake, select the item and change the setting.

4 Select “OK,” and press **ENTER**.

The “Timer List” display appears. The timer recording indicator lights up on the front panel display and the recorder is ready to start recording.

- To record a satellite programme, turn on the satellite tuner and select the satellite programme you want to record. Leave the satellite tuner turned on until the recorder finishes recording.
- To modify the timer setting, see page 59.

To stop recording during timer recording

Press **■ REC STOP**.

Note that it may take a few seconds for the recorder to stop recording.

On-screen instructions may appear after pressing **■ REC STOP**. In this case, follow the on-screen instructions.

To make the detailed settings

1 Select “Set Details” in step 3 above, and press **ENTER**.

2 Select an item using **↑/↓** and set using **←/→**.

“Record to”: Sets the recording destination. If there is not enough available DVD disc space for the recording, the recorder automatically records the programme to the HDD even if you select “DVD” (Recovery Recording).

“Recording Mode”: Sets the recording mode (page 154).

“VPS/PDC”: Sets the VPS/PDC function (For analogue broadcasting only)” below.

“Update”: Sets the recorder automatically replacing the previous timer recording with the new one.

“Genre”: Sets the genre.

- (Models for the UK only) For details about “EPG Link” and “Series Recording,” see “Recording programmes using Series Recording (models for the UK only)” on page 55. You cannot set these items to “On” when setting the timer manually.

To enter a title name

Select “Set Title Name” in step 3 above, and press **ENTER** (page 44).

About the VPS/PDC function (For analogue broadcasting only)

VPS/PDC signals are transmitted with TV programmes in some broadcast systems. These signals ensure that timer recordings are made regardless of any broadcast delays, early starts, or broadcast interruptions.

◆ To use the VPS/PDC function

Set “VPS/PDC” to “On” (see “To make the detailed settings” on page 57).

When you turn on this function, the recorder starts scanning the channels before the timer recording starts.

💡 Hint

You can use the “Rec. Mode Adjust” function (page 54).

🔊 Notes

- If a message indicating that the HDD is full appears on the screen, change the recording destination to “DVD,” or make available space for the recording (page 83).
- Check that the clock is correctly set before setting the timer recording. If not, the timer recording cannot be made.
- Even if the timer is set for the same daily or weekly programme, the timer recording cannot be made if it overlaps with a programme that has priority. “Overlap” will appear next to the overlapped setting in the Timer List. Check the priority order of the settings (page 59).
- Even if the timer is set, timer recordings cannot be made while recording a programme that has priority.
- The beginning of some recordings may not be made when using the VPS/PDC function.
- The “Rec. Mode Adjust” function only works with a timer recording and the VPS/PDC function set to off. It does not function with Quick Timer.
- The recording mode cannot be set to “AUTO” when “VPS/PDC” is set to “On.”

Using the Quick Timer function

You can set the recorder to record in 30-minute increments.

Press ● REC repeatedly to set the duration.

Each press advances the time in 30-minute increments. The maximum duration is six hours.

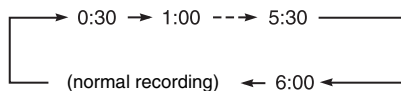

The time counter decreases minute by minute to 0:00, then the recorder stops recording (the power turns off).

To cancel the Quick Timer

Press ● REC repeatedly until “0:00” appears in the front panel display. The recorder returns to normal recording mode. To stop recording, press ■ REC STOP.

🔊 Note

If you turn off the recorder during recording, recording is stopped.

Creating chapters in a title

The recorder can automatically divide a recording (a title) into chapters by inserting chapter marks. To select chapter mark intervals or disable this function, see “Auto Chapter (HDD/VR),” “Auto Chapter (Video),” or “Auto Chapter (DVD+R/+RW)” in the “Recording” setup (page 136). When recording to the HDD, a DVD-R (VR mode) or a DVD-RW (VR mode), you can edit chapter marks (page 85).

Checking/Changing/ Cancelling Timer Settings (Timer List)

HDD +RW -RWVR -RWVideo +R
-RVR -RVideo

You can check, change, or cancel the timer settings using the Timer List.

⚡ Note

(Models for the UK only) To change the EPG timer settings, set "EPG Link" to "Off" in "Set Details."

1 Press TIMER.

The "Timer List" display appears.

When all of the timer settings are not visible on the display, press \uparrow/\downarrow to view the hidden timer settings.

2 Select the timer setting you want to check/change/cancel, and press \rightarrow .

The sub-menu appears.

3 Select an option, and press ENTER.

"Modify":

Changes the timer setting.

Select an item using \leftarrow/\rightarrow and adjust using \uparrow/\downarrow . Select "OK" and press ENTER.

Pr/Ch	Date	Start	Stop	Extend	
D.TV 001	SUN 23/11	20:30	21:30	Off	OK

Detailed Settings		
Record to	HDD	[Set Details]
Recording Mode	SP	[Set Title Name]
VPS/PDC	-----	[Cancel]
Update	-----	
Genre	[X] No Category	
EPG Link	Off	
Series Recording	-----	VPS/PDC 0/8

"Erase":

Erases the timer setting.

Select "Yes" and press ENTER.

"Skip Once":

Cancels the daily or weekly recordings only once. After cancelling the timer setting, "Skip Once" appears next to the timer setting in the Timer List.

"Alternate Search" (models for the UK only) (page 56)

"Series Search" (models for the UK only) (page 56)

"Recommendation Search" (models for the UK only) (page 56)

To change or cancel the setting, repeat steps 2 and 3 above.

When the timer settings overlap

- The programme that starts first has priority and the entire programme is recorded.
- After finishing the previous recording, the other recording starts with several tens-of-second's delay (when the end-time of one recording and the start-time of another are the same).
- When the recordings start at the same time, only one of them will be recorded. Cancel the timer setting for the programme that you are not going to record.

⚡ Hints

- For manual timer settings, you cannot modify the timer setting for the current recording, but you can extend the duration of the recording time while recording (page 57).
For timer settings using the EPG, you can modify the timer setting for the current recording while recording, but you cannot extend the duration of the recording (even when recording is stopped).
(Models for the UK only) For timer settings using the EPG, you can modify the timer setting for the current recording while recording, and extend the duration of the recording only when "EPG Link" is set to "Off."
- You can move to the first row/bottom row of the Timer List using \leftarrow/\rightarrow while the list is displayed.

⚡ Notes

- When "VPS/PDC" is set to "On" for one or more timer recordings, the start times may change in the event of a broadcast delay or early start.
- Even if the timer is set, timer recordings cannot be made while recording a programme that has priority.

Recording from Connected Equipment



You can record from a connected VCR or similar device. To connect a VCR or similar device, see “Connecting a VCR or Similar Device” on page 34.

1 Press HDD or DVD.

If you select DVD, insert a recordable DVD (see “1. Inserting a Disc” on page 38).

2 Press INPUT to select an input source according to the connection you made.

The front panel display changes as follows:

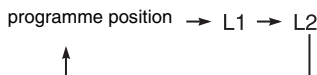

3 Select the desired audio signal when recording a bilingual programme to the HDD or DVD+RWs/DVD+Rs/DVD-RWs/DVD-Rs (Video mode).

Set “External Audio” to “Bilingual” and “Bilingual Recording” to “A/L” or “B/R” in the “Audio In” setup (page 132).

4 Press REC MODE repeatedly to select the recording mode.

For details about the recording mode, see page 154.

5 Insert the source tape into the connected equipment and set to playback pause.

6 Press ● REC.

This recorder starts recording.

7 Press the pause (or play) button on the connected equipment to cancel the playback pause status.

The connected equipment starts playback and the playback image is recorded by this recorder.

To stop recording, press ■ REC STOP on this recorder.

If you connect a DV camcorder with a DV IN jack

See “DV Camcorder Dubbing” on page 98.

If you connect an HDD camcorder with a USB jack

See “HDD Camcorder Dubbing” on page 94.

Notes

- When recording a video game image, the screen may not be clear.
- Any programme that contains a Copy-Never copy guard signal cannot be recorded.
- When “Bilingual Recording” is set to “A/L” or “B/R” in step 3, you cannot select the sound when playing in the following cases.
 - When recording to the HDD (“HDD Recording Format” is set to “Video Mode Off” in the “Recording” setup (page 137))/DVD-RW/DVD-R (VR mode) in PCM mode.
 - When recording to the HDD (“HDD Recording Format” is set to “Video Mode On” in the “Recording” setup (page 137))/DVD+RW/DVD+R/DVD-RW/DVD-R (Video mode).
- You cannot select “L1” in step 2 if “LINE 1 In” is set to “Decoder” in the “Video In/Out” setup (page 131).

Viewing the GUIDE Plus+ Display

The GUIDE Plus+® system is a free interactive programme guide. It displays up to seven days of programme listings, including programme titles, promotions, and broadcast information. GUIDE Plus+ data for the television programme listings are carried by your local broadcast host channel and are received through your aerial, set top box receiver, or direct cable connection from the wall.

Visit www.europe.guideplus.com for a list of all European host channels.

These are just a few of the ways to use the GUIDE Plus+ system.

- Search for programmes by listing them according to category (such as Movies or Sport) or by using the Keyword Search function (page 67).
- Once you have found the programme you are looking for, use the GUIDE Plus+ system to set the timer for recording (page 66).
- You can set the system to display your favourite programmes according to conditions that you set, such as category and keyword (page 63).

Note

The GUIDE Plus+ system cannot be used when “Input Line System” is set to “NTSC” in the “Basic” setup (page 125).

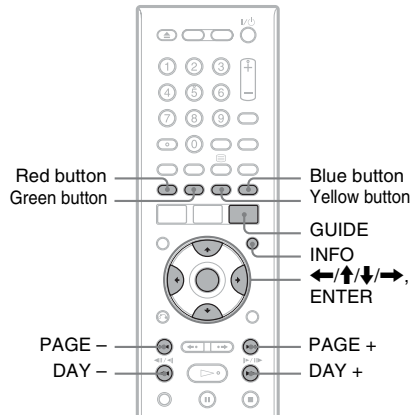

Press GUIDE.

The GUIDE Plus+ system “Home Screen” appears.

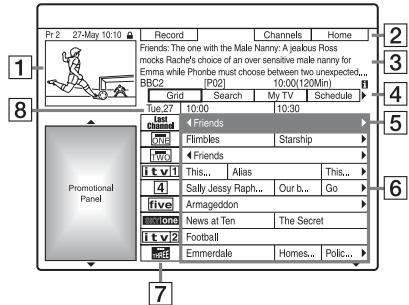

- 1** Video Window: This shows the programme you were watching when you pressed GUIDE.
- 2** Action Bar: When the same colour button on the remote is pressed, the Action Bar functions. The Action Bar function differs according to the screen.
- 3** Information Box: Shows information about the selected programme when the “Home Screen” is displayed. Contents will differ according to the displayed screen.

- 4** Menu Bar: Press the blue button (“Home”), and press **↑** to move the cursor to the Menu Bar. Then select one of the following features using **←/→**, and press ENTER.
- “Grid”: Shows the programmes for the current time slot and next 7 days.
- “Search”: Allows you to search for titles by category or by keyword (page 67). The displayed category depends upon the programme data received by this recorder. Movies, Sport, and Children are examples of possible categories.
- “My TV”: Sets the profile for your favourite programmes (page 63).
- “Schedule”: Displays the list of timer settings (page 71).
- “Info”: Shows information when available.
- “Editor”: Allows you to edit the channel lineup and channel display (page 65).
- “Setup”: Allows you to change the language, country/region, postal code, input source, or host channel.

- 5** “Home” position: When you press the blue button (“Home”), the cursor returns to the last programme position on the “Grid.”

- 6** Tiles: Shows the programme titles and category; green (sports), purple (movies), blue (children’s), teal (others).

Select a programme using **←/↑/↓/→**, and press ENTER to watch the programme.

- 7** Broadcast station Logo: Shows the broadcast station logo.

- 8** Time Slot: Indicates the currently selected time slot. Use **←/→** to select a different time slot.

Available buttons in the GUIDE Plus+ system “Home Screen”

Buttons	Operations
Blue button (“Home”)	Returns to the “Home” position on the “Grid.”
GUIDE	Closes the GUIDE Plus+ system.
PAGE +/-	Changes the programme list by page.
DAY +/-	Changes the programme list by day.
INFO	Shows information about the selected programme.

To unlock the Video Window

The Video Window is locked so that it does not change programme positions when you move the cursor across other titles.

From “Grid,” select the logo of the programme position that is locked, and press the red button (“Unlock”). “**🔒**” changes to “**🔓**” and the Video Window is unlocked. To lock the Video Window, select the logo of the programme position you want to lock and press the red button (“Lock”).

🔔 Notes

- The Video Window is locked during recording and the lock indicator appears in the Video Window. You cannot unlock the Video Window while recording.
- If you are watching programmes through a set top box receiver, the Video Window may not change as fast as you move the cursor. In this case, lock the Video Window (page 62).

Listing Up Your Favourite Programme Information (My TV)

You can set a profile and list up only your favourite programme information.

- 1 Press **GUIDE**.
- 2 Press **↑** to move the cursor to the **Menu Bar**.
- 3 Select **"My TV"** using **←/→**.

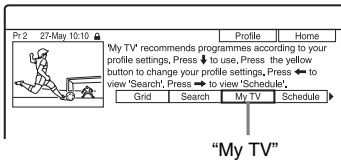

- 4 Press the yellow button ("**Profile**").

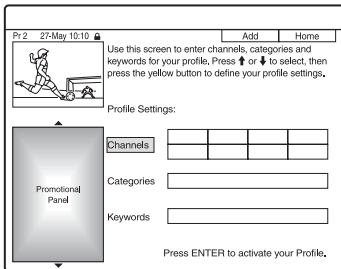

- 5 Select **"Channels," "Categories,"** or **"Keywords,"** and press the yellow button (**"Add"**).

"Channels": Select the programme position using **←/↑/↓/→**, and press **ENTER**. To add more programme positions, press the yellow button (**"Add"**). You can register up to 16 programme positions.

To cancel the registration, select a programme position, and press the red button (**"Delete"**).

"Categories": Select the category using **←/↑/↓/→**, and press **ENTER**. To add more categories, press the yellow button (**"Add"**). You can register up to 4 categories.

To cancel the registration, select a category, and press the red button (**"Delete"**).

"Keywords": Enter a keyword. See "To search for a programme by keyword" on page 67. To add more keywords, press the yellow button (**"Add"**). You can register up to 16 keywords.

To cancel the registration, select a keyword, and press the red button (**"Delete"**).

- 6 Press **ENTER**.

To change the profile settings

Repeat from step 3 above.

To select and watch a programme from "My TV"

- 1 After step 3 above, press **ENTER**. The programmes that match the profile conditions are displayed.
- 2 Select a programme using **←/↑/↓/→**, and press **ENTER**.

Making Changes to the GUIDE Plus+ System

You can customize the GUIDE Plus+ system. If the host channel has been changed or moved, and the programme guide data cannot be received, you can resolve the problem by following the steps below.

Searching for the GUIDE Plus+ host channel (Setup)

The default host channel setting is set to "Automatic," so you should not have to change the host channel setting. However, if the host channel has changed or moved, update the host channel setting. If the set top box receiver is connected to the recorder using a SCART cord only (page 20), see "Changing the GUIDE Plus+ host channel manually (Setup)" on page 64.

- 1 Press **GUIDE**.
- 2 Press **↑** to move the cursor to the **Menu Bar**.
- 3 Select **"Setup"** using **←/→**.

The GUIDE Plus+ setup menu appears.

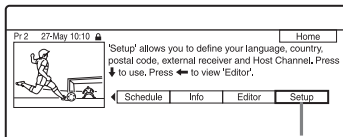

- 4 Select **"Host Channel Setup"** using **↑/↓**, and press **ENTER**.
- 5 Press the yellow button (**"Reset"**).
- 6 Press **I/⏻** to turn off the recorder.

7 Wait for one day until the programme guide data can be received.

If the programme guide data has not been received after waiting for a day, search for the host channel at the following website and set the host channel manually ("Changing the GUIDE Plus+ host channel manually (Setup)" (page 64)).

www.europe.guideplus.com

Changing the GUIDE Plus+ host channel manually (Setup)

If the set top box receiver is connected to the recorder using a SCART cord only and you want to receive the programme guide data from your set top box receiver, search for the host channel on the following website and set it for your area, following the steps below:

www.europe.guideplus.com

- 1 After step 4 of **"Searching for the GUIDE Plus+ host channel (Setup)"**, press the yellow button (**"Change"**) twice.

"Manual" appears.

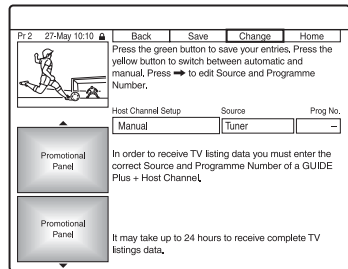

- 2 Select **"Source"** using **→**.
- 3 Press the yellow button (**"Source"**) repeatedly to select the input source.
- 4 Select **"Prog. No."** using **→**.
- 5 Enter the programme position number using the number buttons.
- 6 Press the green button (**"Save"**). The display asks for confirmation.

- 7** Select “Confirm” using \leftarrow/\rightarrow , and press ENTER.
The display returns to the GUIDE Plus+ setup menu.

- 8** Wait one day until the programme guide data can be received.

To cancel the settings

Press the red button (“Back”).

To check the GUIDE Plus+ system information

- 1 Select “Setup” in the Menu Bar, and press ENTER.
- 2 Select “GUIDE Plus+ system Information” using \uparrow/\downarrow , and press ENTER.

Note

The GUIDE Plus+ system is reset when you make changes to the host channel settings.

Checking programme positions (Editor)

Check whether programme position numbers are the same as the programme position numbers set in the “Analog Tuner” setup.

If you want to make adjustments to the channel settings or change the channel name, see “Aerial Reception Settings (Analog Tuner)” (page 127).

- 1 Press GUIDE.
- 2 Press \uparrow to move the cursor to the Menu Bar.
- 3 Select “Editor” using \leftarrow/\rightarrow .

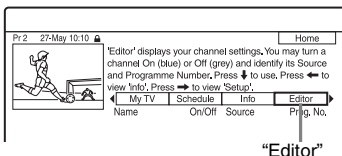

- 4 Press ENTER.
- 5 Press \rightarrow to move the cursor to the right column.

- 6** Select the programme position you want to check using \uparrow/\downarrow .

To change the input source, press the red button (“Source”).

To change the programme position, press the green button (“Prog. No.”), then enter a programme position number using the number buttons, and press ENTER.

Hint

To receive from the recorder a programme position that can be received by either the set top box receiver or the recorder, change the input source in step 6.

Disabling programme positions (Editor)

If any programme positions are unused or contain unwanted channels, you can hide them.

- 1 After step 4 of “Checking programme positions (Editor),” in the left column, select the programme position you want to hide or display using \uparrow/\downarrow .
- 2 Press the red button (“On/Off”).
The disabled positions will turn grey.
To show the disabled positions, press the red button (“On/Off”) again.

Notes

- You cannot record a programme position if it is not set in “Aerial Reception Settings (Analog Tuner)” (page 127) even if it is set to “On” in the “Editor” in the Menu Bar.
- If you are using your set top box receiver to receive programmes (when the set top box receiver is connected to the recorder using a SCART cord only, page 20) and are able to receive the same programme with both the set top box receiver and the recorder, change the “Source” to receive the programme with the recorder’s tuner.

Recording (For analogue broadcasting)

Timer Recording (GUIDE Plus+/Manual)

HDD **+RW** **-RWVR** **-RWVideo** **+R**
-RVR **-RVideo**

You can set the timer for a total of 32 programmes (8 programmes when using the VPS/PDC function), up to 30 days in advance.

Methods to set the timer include:

- One Button Recording (GUIDE Plus+ system)
- Setting the timer manually (GUIDE Plus+ system)

Before you start recording...

- Check that the disc has enough available space for the recording (page 43). For the HDD, DVD+RWs, and DVD-RWs, you can free up disc space by erasing titles (page 82).
- Adjust the recording picture quality if necessary (page 120).
- Turn on the set top box receiver and connect the set top box controller, when the recorder is connected to a set top box receiver and you want to record using the GUIDE Plus+ system.

Note

Do not operate your set top box receiver just before or during a timer recording. This may prevent the accurate recording of a programme.

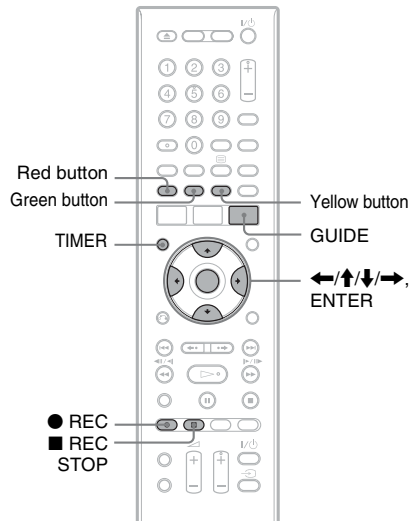

One Button Recording (GUIDE Plus+ (in areas with GUIDE Plus+ service only))

You can use the GUIDE Plus+ system to set the timer to record a programme up to seven days in advance.

1 Press GUIDE.

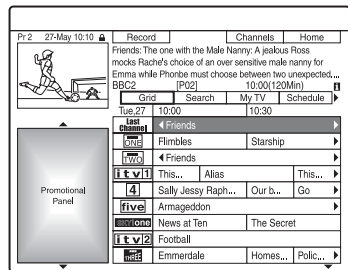

2 Select a programme using ←/↑/↓/→.

- Select the TV broadcast station logo using $\leftarrow/\uparrow/\downarrow/\rightarrow$, and press ENTER. The display returns to "Grid" and the programme currently being broadcast by the selected TV station is selected.
- Select a programme using \leftarrow/\rightarrow , and press ENTER.

To confirm, change, or cancel a timer recording

See "Checking/Changing/Canceling Timer Settings (Schedule)" on page 71.

To stop recording during timer recording

Press \blacksquare REC STOP.

Note that it may take a few seconds for the recorder to stop recording.

On-screen instructions may appear after pressing \blacksquare REC STOP. In this case, follow the on-screen instructions.

Rec. Mode Adjust

If there is not enough available disc space for the recording, the recorder automatically adjusts the recording mode to enable the entire programme to be recorded. Set "Rec. Mode Adjust" to "On" in the "Recording" setup (page 135).

Hint

When you select "AUTO" for the recording mode, the recorder automatically maximises the recording quality for the space available on the inserted disc (if recording to DVD), or to fit on to a blank DVD disc (if recording to HDD).

Notes

- If a message indicating that the HDD is full appears on the screen, change the recording destination to "DVD," or make available space for the recording (page 83).
- The last recording mode you selected manually becomes the default recording mode for timer recordings made from the GUIDE Plus+ system.
- You cannot adjust the recording quality (HDD or DVD) once the recording starts.
- The beginning of some recordings may not be made when using the VPS/PDC function.
- You cannot extend the recording duration time when "VPS/PDC" is selected (page 69).
- The "Rec. Mode Adjust" function only works with a timer recording to DVD, and the VPS/PDC function set to off.
- The recording mode cannot be set to "AUTO" when "VPS/PDC" is set to "On."

Setting the timer manually (Schedule)

- Press **TIMER**.
The schedule list appears.
- Press the green button ("Manual").

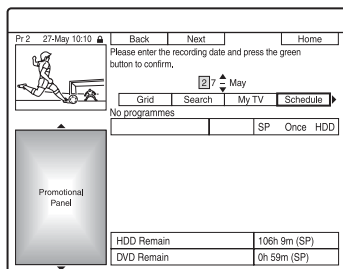

- Set the yellow-highlighted date using the number buttons and $\leftarrow/\uparrow/\downarrow/\rightarrow$. Then press the green button ("Next").

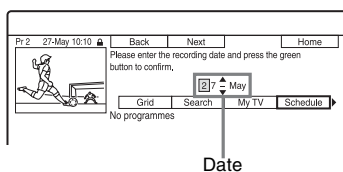

- Set the start time using the number buttons and $\leftarrow/\uparrow/\downarrow/\rightarrow$. Then press the green button ("Next").
- Set the stop time using the number buttons and $\leftarrow/\uparrow/\downarrow/\rightarrow$. Then press the green button ("Next").
- Select the input source using \uparrow/\downarrow , and select the programme position using the number buttons or \uparrow/\downarrow .
- Press the green button ("Next").
The display for entering characters appears. You can change the title name, if necessary.
- Press the green button ("Save").
The date, start and stop times, programme position, etc. settings appear.

9 Press the corresponding colour button repeatedly to set the recording quality, frequency, or destination.

- Yellow button (“Destination”): Sets the recording destination. If there is not enough available DVD disc space for the recording, the recorder automatically records the programme to the HDD even if you select “DVD” (Recovery Recording). When you set a daily or weekly timer, “HDDr” allows you to replace the previous timer recording with the new one automatically (HDD only).
- Green button (“Frequency”): Selects the recording pattern.
- Red button (“Quality”): Selects the recording mode (page 154).

10 Press **→** to display “Timing,” then press the corresponding colour button repeatedly to set the duration or genre.

- Green button (“Timing”): Selects the duration time or to set the VPS/PDC function. See “About the VPS/PDC function” below.
- Yellow button (“Genre”): Selects a particular HDD genre, if necessary.

11 Press **GUIDE** to exit the **GUIDE Plus+** system.

The recorder is ready to start recording.

- To modify the timer setting such as the VPS/PDC function, see page 71.

To stop recording during timer recording

Press **■ REC STOP**.

Note that it may take a few seconds for the recorder to stop recording.

On-screen instructions may appear after pressing **■ REC STOP**. In this case, follow the on-screen instructions.

Hint

You can use the “Rec. Mode Adjust” function (page 68).

Notes

- If a message indicating that the HDD is full appears on the screen, change the recording destination to “DVD,” or make available space for the recording (page 83).
- When you set the recording destination to “HDDr,” the previous timer recording will be replaced with the new one even if you have not watched it.

About the VPS/PDC function

VPS/PDC signals are transmitted with TV programmes in some broadcast systems. These signals ensure that timer recordings are made regardless of any broadcast delays, early starts, or broadcast interruptions.

◆ To use the VPS/PDC function

Select “VPS / PDC” in step 10 above.

When you turn on this function, the recorder starts scanning the channels before the timer recording starts.

Note

If a message indicating that the HDD is full appears on the screen, change the recording destination to “DVD,” or make available space for the recording (page 83).

Using the Quick Timer function

You can set the recorder to record in 30-minute increments.

For details, see page 58.

Recording stereo and bilingual programmes

The recorder automatically receives and records stereo and bilingual programmes based on the ZWEITON system or the NICAM system.

The HDD (when “HDD Recording Format” is set to “Video Mode Off” in the “Recording” setup (page 137)) and a DVD-RW (VR mode) or DVD-R (VR mode) can record both main and sub sounds. You can switch between main and sub when playing the disc.

The HDD (when “HDD Recording Format” is set to “Video Mode On” in the “Recording” setup (page 137)) and a DVD+RW, DVD+R, DVD-RW (Video mode), or DVD-R (Video mode) can record only one sound track (main or sub) at a time.

Before recording starts, set “Bilingual Recording” to “A/L” (default) or “B/R” in the “Audio In” setup (page 132).

About HDD Recording format, see page 137.

ZWEITON (German stereo) system

When a stereo-based programme is received, “Stereo” appears.

When a bilingual ZWEITON-based programme is received, “L,” “R,” or “L+R” appears.

NICAM system

To record a NICAM programme, be sure to set “NICAM Select” to “NICAM” (default) in the “Audio In” setup. If the sound is not clear when listening to NICAM broadcasts, set “NICAM Select” to “Standard” (page 132).

Creating chapters in a title

The recorder can automatically divide a recording (a title) into chapters by inserting chapter marks. To select chapter mark intervals or disable this function, see “Auto Chapter (HDD/VR),” “Auto Chapter (Video),” or “Auto Chapter (DVD+R/+RW)” in the “Recording” setup (page 136). When recording to the HDD, a DVD-R (VR mode) or a DVD-RW (VR mode), you can edit chapter marks (page 85).

Checking/Changing/ Cancelling Timer Settings (Schedule)

HDD +RW -RWVR -RWVideo +R
-RVR -RVideo

You can change or cancel timer settings using the schedule list.

Checking/changing timer settings

1 Press **TIMER**.

The schedule list appears.

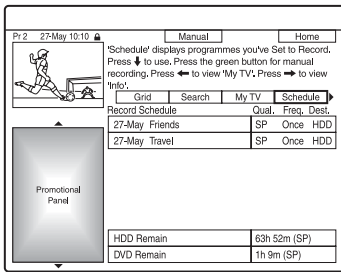

2 Select the timer setting you want to change using **↓**.

You can check the selected timer setting highlighted in pink.

To change the setting, go to step 3.

If not changing the setting, go to step 6.

3 Press the green button ("**Edit**").

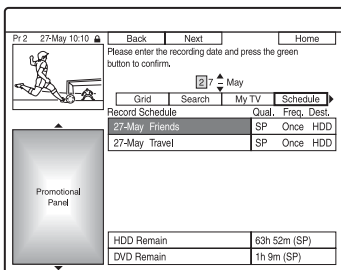

4 In the left column, select an item using the red button ("**Back**") or the green button ("**Next**"), and adjust using the number buttons or **←/↑/↓/→**.

5 Press the corresponding colour button repeatedly to change settings.

- To change the recording destination, press the yellow button ("**Destination**"). If there is not enough available DVD disc space for the recording, the recorder automatically records the programme to the HDD even if you select "DVD" (Recovery Recording). When you set a daily or weekly timer, "HDDr" allows you to replace the previous timer recording with the new one automatically (HDD only).
- To set the recording pattern, press the green button ("**Frequency**").
- To change the recording mode, press the red button ("**Quality**") (page 154).

6 Press **→** to display "**Timing**."

7 Press the green button ("**Timing**") repeatedly to change the duration time or to set the VPS/PDC function.

See "About the VPS/PDC function" on page 69.

- If you want to record to a particular HDD genre, press the yellow button ("**Genre**") repeatedly.

8 Press **GUIDE** to exit the **GUIDE Plus+** system.

The new settings become effective.

Cancelling timer settings

In step 2 of "Checking/changing timer settings," select the timer setting you want to cancel using **↑/↓**, and press the red button ("**Delete**").

To close the schedule list

Press **GUIDE**.

When the timer settings overlap

- The programme that starts first has priority and the entire programme is recorded.
- After finishing the previous recording, the other recording starts with several tens-of-second's delay (when the end-time of one recording and the start-time of another are the same).
- When the recordings start at the same time, only one of them will be recorded. Cancel the timer setting for the programme that you are not going to record.

Note

When "VPS / PDC" is set for one or more timer recordings, the start times may change in the event of a broadcast delay or early start.

Recording from Connected Equipment



You can record from a connected VCR or similar device. To connect a VCR or similar device, see "Connecting a VCR or Similar Device" on page 34.

For details, see page 60.

Playing

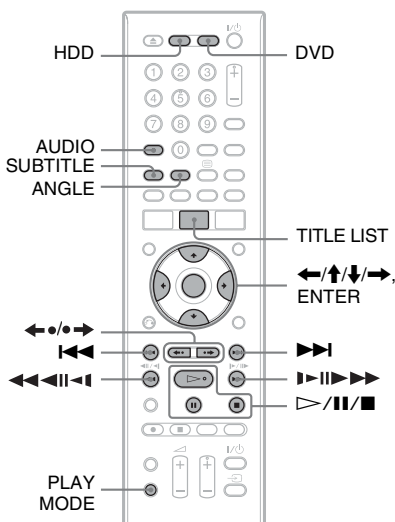
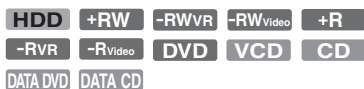

1 Press HDD or DVD.

- If you select DVD, insert a disc (see “1. Inserting a Disc” on page 38).
- If you insert a DVD VIDEO, VIDEO CD, DATA DVD or DATA CD, press \triangleright . Playback starts.

2 Press TITLE LIST.

If the Title List is already displayed, skip this step.
Example: HDD

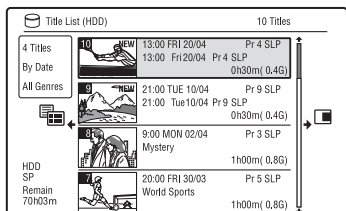

3 Select a title using \uparrow/\downarrow , and press ENTER.

Playback starts from the selected title.

Hint

You can also use the \triangleright button in step 3 to start playback.

Note

When any video titles are recorded on a DATA DVD, the MP3 audio tracks on that DATA DVD cannot be played.

To use the DVD's Menu

When you play a DVD VIDEO, or a finalised DVD+RW, DVD-RW (Video mode), DVD+R, or DVD-R (Video mode), you can display the disc's menu by pressing TOP MENU or MENU.

Note

The \triangleright button is not available in the disc's menu.

To play VIDEO CDs/Super VIDEO CDs with PBC functions

PBC (Playback Control) allows you to play VIDEO CDs/Super VIDEO CDs interactively using the menu on your TV screen.

When you start playing a VIDEO CD/Super VIDEO CD with PBC functions, the menu appears.

Select an item using the number buttons, and press ENTER. Then, follow the instructions in the menu (press \triangleright when “Press SELECT” appears).

Note

Some playback options such as search, repeat play or programme play cannot be played with PBC function. To play with playback options, start playback without PBC functions using the Title List.

To play DivX video files or audio tracks in a disc containing both file types

- 1 Press **←** while the Title List (DVD/CD) is displayed.
- 2 Select "Data Format" using **↑/↓**, and press **ENTER**.
- 3 Select "CD," "MP3" or "DivX" using **↑/↓**, and press **ENTER**.
- 4 Return to the Title List, then select an album, title or track, and press **ENTER** or **▷**.

To stop playback

Press **■**.

To resume playback from the point where you stopped (Resume Play)

When you press **▷** again after you stop playback, the recorder resumes playback from the point where you pressed **■**.

To start from the beginning, press **■** again, and press **▷**. Playback starts from the beginning of the title/track/scene.

Notes

- You cannot resume playback during TV Pause.
- Resume Play is not available for Super VIDEO CDs.
- The point where you stopped playing is cleared from memory when:
 - you open the disc tray (except HDD).
 - you play another title (except HDD).
 - you start playback using the Title List (except HDD).
 - you edit the title after stopping playback.
 - you change the settings on the recorder.
 - you make a recording (except HDD).
 - you disconnect the mains lead.

To play restricted DVDs (Parental Lock)

If you play a restricted DVD, the display for entering your password appears on your TV screen.

Enter your four-digit password using the number buttons, and press **ENTER**. The recorder starts playback.

To register or change the password, see "Limitation Settings (Parental Lock)" on page 138.

One-Touch Play (for SCART/HDMI connections only)

Press **▷**. With one touch of the **▷** button, the recorder and your TV automatically turn on and the TV's input is switched to the recorder. Playback starts automatically.

















Notes

- When using the HDMI connection, there may be a delay, before the playback picture appears on the TV screen, and the beginning portion of the playback picture may not be displayed.
- To use the One-Touch Play function, set "Control for HDMI" to "On" (default) in the "HDMI Output" setup (page 140).

Playback options

To check the position of the buttons below, see the illustration on page 73.

Buttons	Operations
ANGLE 	Changes the angles for a scene when pressed during playback. When the disc has various angles (multi-angles) recorded, “” appears on the screen. To switch the angle mark indicator to off, set “Angle Indicator” to “Off” in the “Playback” setup (page 138).
AUDIO 	Selects one of the audio tracks recorded on the disc when pressed repeatedly in normal playback mode. ^{*1} ^{*1} : Selects the language. : Selects the main or sub sound. ^{*2} ^{*2} : Selects stereo or monaural audio tracks. ^{*1} DivX video file only ^{*2} MP3 audio track only
SUBTITLE [*] [*] * DivX video file only	Selects a subtitle language when pressed repeatedly.
(instant replay/ instant advance) [*] [*] * DivX video file only	Each time you press , replays the scene for the following duration. 5 seconds → 15 seconds → 30 seconds → 1 minute → 2 minutes → 3 minutes → 5 minutes → 10 minutes → 20 minutes → advances the time in 10-minute increments → 2 hours Each time you press , briefly fast forwards the current scene for the following duration. 30 seconds → 1 minute → 1 minute 30 seconds → 2 minutes → 3 minutes → 5 minutes → 10 minutes → 20 minutes → advances the time in 10-minute increments → 2 hours
(previous)/ (next)	Goes to the beginning of the previous/next title/chapter/scene/track when pressed during playback. Goes to the beginning of the first title/track when pressed in stop mode.

Buttons	Operations
 (fast reverse/fast forward)	<p>Fast reverses/fast forwards the disc when pressed during playback.</p> <p>Search speed changes as follows:</p> <p style="text-align: center;"> fast reverse fast forward  FR1^{*1} ← →  FF1^{*2}  FR2 ← ← → →  FF2  FR3^{*3} ← ← ← → → →  FF3^{*3}  FR4^{*3} ← ← ← ← → → → →  FF4^{*3} </p>
	<p>When you press and hold the button, fast forward/fast reverse continues at the selected speed until you release the button.</p>
	<p>^{*1} When you press  once during playback, you can play Reverse play (not available for VIDEO CDs/Super VIDEO CDs/DivX video files/audio tracks).</p>
	<p>^{*2} When you press  once during playback, you can play quickly with sound (Scan Audio) (not available for VIDEO CDs/Super VIDEO CDs).</p>
	<p>^{*3} Not available for VIDEO CDs/Super VIDEO CDs/audio tracks.</p>
	<p>To resume normal playback, press .</p>
 (slow, freeze frame)	<p>Plays in slow motion when pressed for more than one second in pause mode.</p> <p>Plays one frame at a time when pressed briefly in pause mode.</p> <p>To resume normal playback, press .</p>
	
<p>^{*1} Playback direction only ^{*2} DivX video file only</p>	
 (pause)	<p>Pauses playback.</p> <p>To resume normal playback, press .</p>

Notes

- Angles and subtitles cannot be changed with titles recorded on this recorder.
- JPEG image files made with a DVD camcorder can only be played as a slideshow. For video files containing JPEG image files and movies, the recorder can play movie parts only.

Notes on playing DVDs with a DTS sound track

DTS audio signals are output only through the DIGITAL OUT (COAXIAL) jack.

When you play a DVD with DTS sound tracks, set “DTS Output” to “On” in the “Audio Out” setup (page 133).

Notes on playing DTS sound tracks on a CD

- When playing DTS-encoded CDs, excessive noise will be heard from the LINE 3-TV/LINE 1/DECODER/LINE 2 OUT (R-AUDIO-L) jacks. To avoid possible damage to the audio system, the user should take proper precautions when the LINE 3-TV/LINE 1/DECODER/LINE 2 OUT (R-AUDIO-L) jacks of the recorder are connected to an amplification system. To enjoy DTS Digital Surround™ playback, an external DTS decoder must be connected to the DIGITAL OUT jack of the recorder.
- Set the sound to “Stereo” using the AUDIO button when you play DTS sound tracks on a CD (page 75).

Playing a specific portion repeatedly (A-B Repeat)

1 Press PLAY MODE during playback.

For audio tracks on a CD, press **→** while the Title List is displayed, and select “Play Mode.”

The “Play Mode” menu appears.

2 Select “A-B Repeat,” and press ENTER.

“Set point A” is selected.

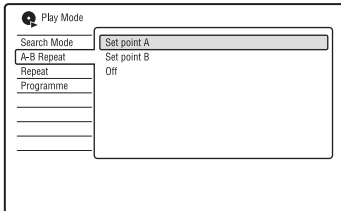

3 While monitoring the sound, press ENTER at the starting point (point A) of the portion to be played repeatedly.

“Set point B” is selected.

4 Continue playing to locate the ending point (point B), and press ENTER.

A-B Repeat starts.

To cancel A-B Repeat

Press CLEAR. Or, set “A-B Repeat” to “Off” in the “Play Mode” menu.

Notes

- When playing an HDD/DVD VIDEO/DVD-RW (Video mode)/DVD-R (Video mode), set the start and stop points within the same title.
- “A-B Repeat” is not available for MP3 audio tracks.

Playing repeatedly (Repeat)

You can repeatedly play all the titles/tracks/files or a single title/chapter/track on the HDD, a disc or an album.

1 Press PLAY MODE during playback.

For audio tracks on a DATA DVD/DATA CD/CD, press **→** while the Title List is displayed, and select “Play Mode.”

The “Play Mode” menu appears.

2 Select “Repeat,” and press ENTER.

3 Select an item to be repeated using **↑/↓**.

“Repeat Title” (for HDD/DVDs/DATA DVDs^{*1}/DATA CDs^{*1}): repeats the current title.

“Repeat Chapter” (for HDD/DVDs): repeats the current chapter.

“Repeat Track” (for VIDEO CDs^{*2}/CDs/DATA DVDs/DATA CDs): repeats the current track.

“Repeat Programme”: repeats the current programme (page 78).

“Repeat Disc” (for VIDEO CDs^{*2}/DVD-RWs/DVD-Rs (VR mode)/CDs/DATA DVDs/DATA CDs): repeats the entire disc.

“Repeat Album” (for DATA DVDs^{*3}/DATA CDs^{*3}): repeats the current album.

^{*1} DivX video file only

^{*2} Available only when playing without PBC functions

^{*3} Audio tracks only

4 Press ENTER.

Repeat play starts.

To cancel Repeat play

Press CLEAR. Or, set “Repeat” to “Repeat Off” in the “Play Mode” menu.

Note

You can select “Repeat Programme” only during Programme play.

Creating your own programme (Programme)



*1 finalised disc only

*2 MP3 audio tracks only

You can play the contents of the HDD or a disc in the order you want by arranging the order of the titles/chapters/albums/tracks on the HDD or disc to create your own programme. You can make a programme of up to 24 chapters/tracks, etc.

1 Press **PLAY MODE** during playback.

For audio tracks on a DATA DVD/ DATA CD/CD, press **→** while the Title List is displayed, and select “Play Mode.”

The “Play Mode” menu appears.

2 Select “Programme,” and press **ENTER**.

3 Select “Input/Edit Programme,” and press **ENTER**.

The “Input/Edit Programme” display differs depending upon the disc type. Example: DVD

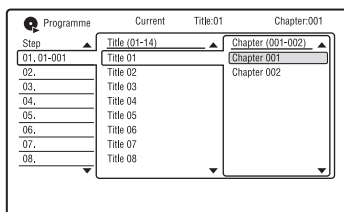

4 Select a title or album (example: Title 01) using **↑/↓**, and press **→**.

5 Select a chapter or track (example: Chapter 001) using **↑/↓**, and press **ENTER**.

The chapter or track is programmed.

If you make a mistake, select the step number (example: 01.) using **←/↑/↓**, and press **CLEAR**.

6 To programme other chapters or tracks, press **←/↑/↓/→** to select a step number, and repeat steps 4 and 5.

7 Press **▷**.

Programme play starts.

To stop Programme play

Press **■** (stop).

To cancel Programme play

Press **CLEAR** during playback. Or, set “Programme” to “Cancel Programme Play” in the “Play Mode” menu.

To erase the programme

Press **CLEAR** in stop mode. Or, set “Programme” to “Erase Programme List” in the “Play Mode” menu.

🔧 Hints

- The programme you made remains after Programme play finishes. To play the same programme again, set “Programme” to “Start Programme Play” in the “Play Mode” menu. However, the programme is cleared after you remove the disc or press **⏏**.
- You can repeat Programme play. During Programme play, set “Repeat” to “Repeat Programme” in the “Play Mode” menu (page 77).

Advanced Playback Functions

Pausing a TV broadcast (TV Pause/Pause Live TV)

HDD

You can pause a current TV broadcast, and record it on the HDD, then continue watching the programme at a later time. This is useful when you receive an unexpected phone call or visitor while watching TV. When connecting the recorder to your TV using the SCART jack, do the following.

- set “SMARTLINK” to “This Recorder Only” in the “Options” setup (page 141).
- set “TV Pause” to “TV’s Tuner” in the “Options 2” setup (page 142).
- preset programme positions by downloading from your TV using “Download from TV” of “Auto Channel Setting” in the “Analog Tuner” setup (page 127).

If you do not make the SCART connection, set “TV Pause” to “Recorder’s Tuner” in the “Options 2” setup (page 142).

1 While viewing a TV broadcast, press TV PAUSE.

The picture pauses, and the recorder starts recording the current TV channel to the HDD.

It may take up to 10 seconds to start recording.

2 Press ▷ to resume watching the programme.

You can fast forward/fast reverse, pause, or stop the programme using ◀◀/▶▶, || and ■ without affecting the recording.

3 Press ■ REC STOP to stop recording.

🔊 Notes

- The picture does not pause and the recorder starts only recording in the following cases.
 - when the programme positions are preset differently between the recorder and the connected TV.
 - when watching the programme from the external equipment connected to your TV.
- The picture tuned by the recorder pauses when “TV Pause” is set to “Recorder’s Tuner” in the “Options 2” setup (page 142).
- You may not be able to use the “TV Pause” function depending on some TVs. For details, refer to the operating instructions supplied with your TV.
- The “TV Pause” function will not work correctly when watching TV via the connected component such as a VCR or digital tuner. The “TV Pause” function works only with the channel selected on the TV.
- You cannot use the “TV Pause” function as a recording feature from the component (VCR, etc.) connected to the LINE 1/DECODER jack.
- The “TV Pause” function will not work if the connected TV does not comply with SMARTLINK. To check whether your TV complies with SMARTLINK, refer to the operating instructions supplied with your TV.

Playing from the beginning of the programme you are recording (Chase Play)

HDD

“Chase Play” allows you to view the recorded part of a programme on the HDD while the recording is being made. You do not need to wait until the recording finishes.

Press ▷ while recording.

Playback starts from the beginning of the programme you are recording.

When you fast forward to the point that you are recording, “Chase Play” returns to normal playback.

Playing a previous recording while making another (Simultaneous Rec and Play)

HDD +RW -RWVR -RWVideo +R
-RVR -RVideo DVD VCD DATA DVD
DATA CD

“Simultaneous Rec and Play” allows you to view a previously recorded programme while recording programmes. Playback continues even if a timer recording starts. Use this function as follows:

- While recording to the HDD:
Play another title on the HDD.
Play a previously recorded programme on a DVD by pressing the DVD button.
- While recording to a DVD:
Play a previously recorded programme on the HDD by pressing the HDD button.

You can also play a DVD VIDEO, VIDEO CD, Super VIDEO CD, DATA DVD, or DATA CD while recording on the HDD.

Example: Play another title on the HDD while recording to the HDD.

- 1 While recording, press TITLE LIST to display the HDD Title List.
- 2 Select the title you want to play, and press ENTER.
Playback starts from the selected title.

Example: Play a DVD while recording to the HDD.

- 1 While recording, press DVD and insert the DVD into the recorder.
- 2 Press TITLE LIST to display the DVD Title List.
- 3 Select the title you want to play, and press ENTER.
Playback starts from the selected title.

Note

You cannot play a DVD, DivX video or VIDEO CD recorded in the NTSC colour system while recording on the HDD in the PAL/SECAM colour system.

Searching for a Time/Title/Chapter/Track, etc.

HDD +RW -RWVR -RWVideo +R
-RVR -RVideo DVD VCD DATA DVD^{*}
DATA CD^{*}

* DivX video file only

You can search a disc by title, chapter, scene or track. As titles and tracks are assigned individual numbers, select the title or track by entering its number. You can also search for a scene using the time code.

- 1 Press **PLAY MODE** during playback. The “Play Mode” menu appears.
- 2 Select “Search Mode,” and press **ENTER**.
- 3 Select a search method, and press **ENTER**.

“Time Search” (for HDD/DVDs/DATA DVDs^{*1}/DATA CDs^{*1}/VIDEO CDs^{*2*3}): Searches for a starting point by entering the time code.

“Title Search” (for HDD/DVDs/DATA DVDs^{*1}/DATA CDs^{*1})

“Chapter Search” (for HDD/DVDs)

“Track Search” (for VIDEO CDs^{*3})

^{*1} DivX video file only

^{*2} Except Super VIDEO CDs

^{*3} Available only when playing without PBC functions

The display for entering the number appears.

- 4 Press the number buttons to select the number of the title, chapter, time code, etc., you want.

For example: Time Search

To find a scene at 2 hours, 10 minutes, and 20 seconds, enter “21020.”

If you make a mistake, select another number.

5 Press ENTER.

Playback starts from the selected number.

Hint

You can search for a title/track/chapter by entering the title/track/chapter number using the number buttons during playback.

Before Editing

This recorder offers various edit options for various disc types.

Notes

- You may lose the edited contents if you remove the disc or a timer recording starts while editing.
- DVD discs created by DVD camcorders cannot be edited on this recorder.
- If a message appears and indicates that the disc's control information is full, erase or edit unnecessary titles.
- The remaining disc space displayed on the screen may differ from the actual remaining disc space.
- When editing a DVD+R or DVD-R, finish all editing before finalising the disc. You cannot edit a finalised disc.

To open up disc space

To open up disc space on a DVD+RW or DVD-RW (Video mode), erase the title with the largest number in the title list.

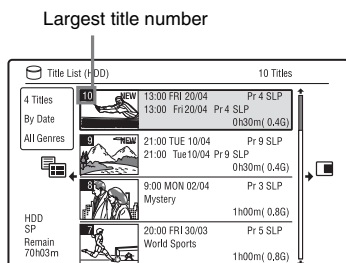

To open up disc space on the HDD or a DVD-RW (VR mode), you can erase any title.

See “Erasing and Editing a Title” on page 83.

For DVD-Rs and DVD+Rs, the available disc space does not increase even if you erase titles.

To switch between the Playlist and Original Title List (DVD-RW/DVD-R in VR mode only)

You can display the Playlist titles in the Title List (Playlist), or the Original titles in the Title List (Original).

- 1 Press **←** while the Title List is displayed.
- 2 Select “Play List” using **↑/↓**, and press **ENTER**.
- 3 Select “Original” or “Play List” using **↑/↓**, and press **ENTER**.

About editing accuracy

When editing the titles recorded on the HDD, you can select the type of editing. “Video Mode Compatible Editing”: Recommended if you are going to dub the titles to DVD-RWs/DVD-Rs (Video mode) or DVD+RWs/DVD+Rs afterward by High-speed dubbing. The editing points and chapter marks may be slightly different from those you selected.

“Frame Accurate Editing”:

Recommended when you want to edit titles precisely. However, the editing points may be slightly different from the point you selected when you dub the titles by High-speed dubbing.

Erasing and Editing a Title



This section explains the basic edit functions. Note that editing is irreversible. To edit DVD-RWs/DVD-Rs (VR mode) without changing the original recordings, create a Playlist title (page 87).

1 Press TITLE LIST.

For DVD-RWs/DVD-Rs in VR mode, switch the Title List (Original or Playlist), if necessary.

2 Select a title, and press →.

The sub-menu appears.

3 Select an option, and press ENTER.

You can make the following edits to the title.

“Erase”: Erases the selected title. Select “Yes” when asked for confirmation.

“Edit”: Allows you to make the following edits.

- “Title Name”: Allows you to enter or re-enter a title name (page 44).
- “Set Thumbnail”: Changes the title’s thumbnail picture that appears in the Title List (page 42).
- “A-B Erase”: Erases a section of the title (page 84).
- “Divide”: Divides a title into two titles (page 84).
- “Chapter Edit”: Edits chapters in a title (page 85).
- “Set Genre”: Assigns a genre to a title.
- “Protect”: Protects the title. “” appears next to the protected title.
- “Move”: Changes the title’s playing order (page 87).
- “Combine”: Combines two titles into one (page 87).

“Genre Name”: Allows you to enter a genre name (up to 12 characters) (page 44).

“Multi-Mode”: Allows you to select and edit multiple titles at one time (page 83).

“Create”: Creates a Playlist (page 87).

“Undo”: Undoes the last edit you made.

Hint

You can label or re-label DVDs (page 45).

Editing multiple titles (Multi-Mode)

HDD

You can select and edit up to 24 titles at one time.

1 Press TITLE LIST.

2 Press →.

The sub-menu appears.

3 Select “Multi-Mode,” and press ENTER.

The display for selecting titles to be edited appears.

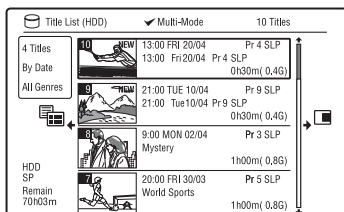

4 Select a title, and press ENTER.

A check mark appears in the check box. To clear the check mark, press ENTER again.

5 Repeat step 4 to select all of the titles you want to edit.

6 When you finish selecting titles, press →.

The sub-menu appears.

7 Select an option, and press ENTER.

“Erase”: Erases the selected titles.

“Protect”: Protects the titles. “” appears next to the protected title.

“Unprotected”: Unprotects the titles.

“Change Genre”: Changes the genre of the titles.

Hint

You can exit “Multi-Mode” by pressing **→** and selecting “Single-Mode” while selecting titles.

Erasing a section of a title (A-B Erase)

HDD **-RWVR** **-RVR**

You can select a section (scene) in a title and erase it. Note that erasing scenes in a title cannot be undone.

1 After step 2 of “Erasing and Editing a Title,” select “Edit,” and press **ENTER**.

2 Select “A-B Erase,” and press **ENTER**.

For the HDD, select a type of editing, and press **ENTER**. For details, see page 82.

The display for setting point A appears. The title starts to play.

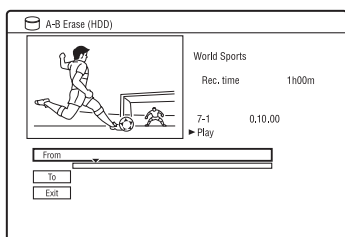

3 Select point A using **◀/▶** or **▷**, and press **II**.

• To return to the beginning of the title, press **II** and then press **◀◀**.

4 Select “From,” and press **ENTER**. The position of point A is displayed.

5 Press **▷**.

6 Select point B using **◀/▶** or **▷**, and press **II**.

7 Select “To,” and press **ENTER**. The position of point B is displayed.

8 Select “Yes,” and press **ENTER**. The scene is erased.

To cancel “A-B Erase”

Press **↶** RETURN. The Title List appears.

Hint

A chapter mark is inserted after the scene is erased. The chapter mark divides the title into separate chapters on either side of the mark.

Notes

- Images or sound may be momentarily interrupted at the point where you erase a section of a title.
- Sections shorter than five seconds may not be erased.

Dividing a title (Divide)

HDD **-RWVR** * **-RVR** *

If you want to dub a long title to a disc but do not want to reduce the picture quality, divide the title into two shorter titles. Note that dividing a title cannot be undone.

* Only playlist titles can be divided for DVD-RWs/DVD-Rs in VR mode.

1 After step 2 of “Erasing and Editing a Title,” select “Edit,” and press **ENTER**.

2 Select “Divide,” and press **ENTER**.

For the HDD, select a type of editing, and press **ENTER**. For details, see page 82.

The display for setting the dividing point appears.

The title starts to play.

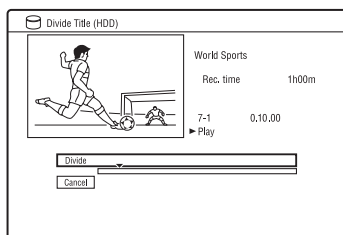

3 Select the dividing point using **◀/▶** or **▷**, and press **II**.

• To return to the beginning of the title, press **II** and then press **◀◀**.

4 Press ENTER.

For the HDD, the display asks for confirmation.

5 Select “Yes,” and press ENTER (HDD only).

The title is divided into two.

Erasing and Editing a Chapter

HDD **-RWVR** **-RVR**

You can edit individual chapters within a title. To edit DVD-RWs/DVD-Rs (VR mode) without changing the original recordings, create a Playlist (page 87).

1 Press TITLE LIST.

For DVD-RWs/DVD-Rs in VR mode, switch the Title List (Original or Playlist), if necessary.

2 Select a title containing the chapter you want to edit, and press →.

The sub-menu appears.

3 Select “Edit,” and press ENTER.

4 Select “Chapter Edit,” and press ENTER.

For the HDD, select a type of editing, and press ENTER. For details, see page 82.

5 Select an option, and press ENTER.

You can make the following edits to the chapter.

“Divide”: Divides a chapter into two (page 86).

“Erase/Move”

- “Erase”: Erases the selected chapter (page 86).
 - “Move” (for Playlist titles on DVD-RWs/DVD-Rs in VR mode): Changes the chapter’s playing order (page 88).
- “Combine”: Combines two chapters into one (page 86).

Dividing a chapter (Divide)

- 1 After step 4 of “Erasing and Editing a Chapter,” select “Divide.”

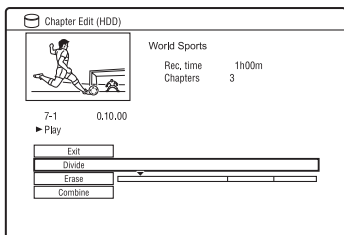

- 2 Select a chapter using \leftarrow/\rightarrow .
- 3 Select the dividing point using \lll/ \ggg or \triangleright , and press **II**.
 - To return to the beginning of the chapter, press **II** and then press \lll .
- 4 Press **ENTER**.
The chapter is divided into two.

Erasing a chapter (Erase)

- 1 After step 4 of “Erasing and Editing a Chapter,” select “Erase.”

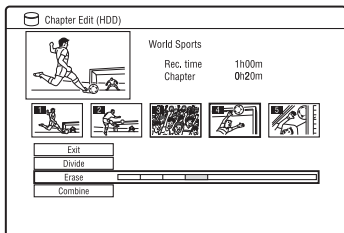

- 2 Select a chapter using \leftarrow/\rightarrow , and press **ENTER**.
- 3 (For a Playlist chapter only)
Select “Erase,” and press **ENTER**.
The display asks for confirmation.
- 4 Select “Yes,” and press **ENTER**.
The chapter is erased.

Combining multiple chapters (Combine)

- 1 After step 4 of “Erasing and Editing a Chapter,” select “Combine.”

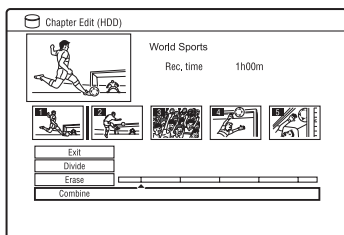

- 2 Move the combining bar using \leftarrow/\rightarrow , and press **ENTER**.
The two adjacent chapters of the combining bar are combined.

Note

Chapters cannot be combined if they are automatically created from an HDD camcorder dubbing.

Creating and Editing a Playlist

-RWVR -RVR

Playlist edit allows you to edit or re-edit without changing the actual recordings. You can create up to 99 Playlist titles.

⚡ Note

Playlist titles containing titles recorded with the “Copy-Once” copy protection signal cannot be dubbed or moved (page 157).

1 Press TITLE LIST, and switch to the Playlist.

For details on switching to the Playlist, see page 82.

2 Press →.

The sub-menu appears.

3 Select “Create,” and press ENTER.

The original titles in the Title List appear.

4 Select an original title to add to the Playlist, and press ENTER.

The selected title is added to the Playlist.

5 Repeat steps 3 and 4 to select all of the titles you want to add to the Playlist.

Moving a Playlist title (Move)

1 Press TITLE LIST, and switch to the Playlist.

For details on switching to the Playlist, see page 82.

2 Select a Playlist title, and press →.

The sub-menu appears.

3 Select “Edit,” and press ENTER.

4 Select “Move,” and press ENTER.

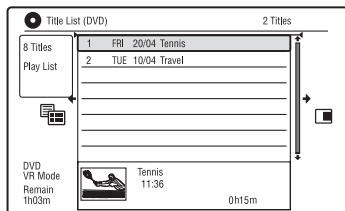

5 Select a new location for the title using ↑/↓, and press ENTER.

The title moves to the new location.

- To move more titles, repeat from step 2.

Combining multiple Playlist titles (Combine)

1 Press TITLE LIST, and switch to the Playlist.

For details on switching to the Playlist, see page 82.

2 Select a Playlist title, and press →.

The sub-menu appears.

3 Select “Edit,” and press ENTER.

4 Select “Combine,” and press ENTER.

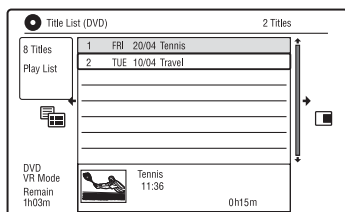

5 Select a title you want to combine, and press ENTER.

6 Select “Yes,” and press ENTER.

The titles are combined.

Dividing a Playlist title (Divide)

You can divide a Playlist title. For instructions, see page 84.

Moving a chapter (Move)

- 1 Press TITLE LIST, and switch to the Playlist.**

For details on switching to the Playlist, see page 82.

- 2 Select a Playlist title containing the chapter you want to edit, and press →.**

The sub-menu appears.

- 3 Select “Edit,” and press ENTER.**

- 4 Select “Chapter Edit,” and press ENTER.**

- 5 Select “Erase/Move.”**

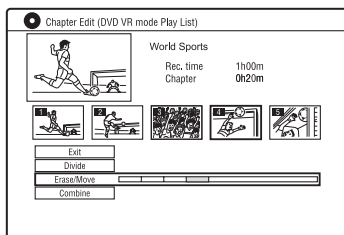

- 6 Select a chapter using ←/→, and press ENTER.**

- 7 Select “Move,” and press ENTER.**

- 8 Select a new location for the chapter using ←/→, and press ENTER.**

The chapter moves to the new location.

Before Dubbing

In this section, “dubbing” refers to “copying a recorded title on the internal hard disk drive (HDD) to another disc, or vice versa.” You can dub a playing title using the HDD/DVD DUB button (see “HDD/DVD Dubbing” on page 90) or you can select to dub multiple titles all at once (see “Dubbing Using Dubbing List” on page 90). You can also dub an entire DVD disc to make a backup copy (see “Making a Backup Disc (DVD Backup)” on page 93). Before you start, read the following precautions, which are common to all dubbing methods.

Before you start...

- You cannot record both the main and sub sound on the HDD (when “HDD Recording Format” is set to “Video Mode On” in the “Recording” setup), DVD+RWs, DVD-RWs (Video mode), DVD+Rs, or DVD-Rs (Video mode). For bilingual programmes, set “Bilingual Recording” to either “A/L” (default) or “B/R” in the “Audio In” setup (page 132). About HDD Recording format, see page 137.
- A title name in the dubbing source is dubbed. However, only up to 40 characters of a title name are dubbed when dubbing from the HDD to a DVD+RW/DVD-RW (Video mode)/DVD+R/DVD-R (Video mode).
- The chapter marks in the dubbing source are dubbed. The position of chapter marks may be slightly changed from the original. However, the chapter marks in the dubbing source are not retained in the dubbed title when dubbing to a DVD-RW/DVD-R (Video mode), DVD+RW, or DVD+R at normal speed. The chapter marks are automatically inserted according to the “Auto Chapter (Video)” and “Auto Chapter (DVD+R/+RW)” settings in the “Recording” setup (page 136).

- The “Set Thumbnail” setting in the dubbing source is dubbed as a thumbnail picture marker (except when dubbing from a DVD+RW/DVD-RW (Video mode)/DVD+R/DVD-R (Video mode)). The position of thumbnail picture markers may be slightly changed from the original.

Hint

When you dub a Playlist title, it is recorded as an Original title.

Notes

- You cannot make a recording while dubbing.
- Before playing a dubbed disc on other DVD equipment, finalise the disc (page 46, 91).
- You cannot dub from DVD VIDEOS to the HDD.
- Titles containing mixed aspect ratios cannot be dubbed to a DVD+RW/DVD+R/DVD-RW/DVD-R (Video mode) using the HDD/DVD DUB button.
- Titles over 8 hours cannot be dubbed to single-layer DVD+RWs/DVD+Rs.
- Low resolution (SEP through LP modes) 16:9 size titles cannot be dubbed to a DVD+RW/DVD+R/DVD-RW/DVD-R (Video mode).
- Titles recorded in Dolby Digital 5.1 ch audio are down-converted to 2-channel audio when dubbed at normal speed (“Real time” dubbing).
- About the “Move” function, see page 157.

HDD/DVD Dubbing



You can dub a single title by pressing the HDD/DVD DUB button during playback. You can also dub from finalised DVD-RWs/DVD-Rs (Video mode) to the HDD.

1 Start playback of a title.

For playing a title, see “Playing” on page 73.

2 Press HDD/DVD DUB.

The recorder starts dubbing the current playing title from the beginning. The recorder turns off automatically when you do not use the recorder for more than 20 minutes after the dubbing has finished.

To cancel dubbing

Press and hold HDD/DVD DUB for more than one second.

When dubbing is stopped partway, no part of the title will be moved to the dubbing target. However, note that this will decrease the free space for DVD+Rs/DVD-Rs.

About dubbing mode

Titles on the HDD are dubbed to a disc at high speed (“High-Speed” dubbing). Titles on a disc are dubbed to the HDD at normal speed (“Real time” dubbing).

For the minimum required time for “High-Speed” dubbing, see page 157.

To convert the recording mode (only when dubbing from a disc to the HDD)

Before step 1, press REC MODE to select the recording mode.

Note

You cannot use the HDD/DVD DUB button in the following cases. Dub the title using Dubbing List (page 90).

- When dubbing the title recorded in MN6 mode or longer duration mode to a DVD+RW/DVD+R.
- When dubbing the title recorded in HQ+ mode to a DVD.

Dubbing Using Dubbing List



You can select the titles you want to dub using Dubbing List. You can also edit titles before dubbing without changing the original titles.

1 Press SYSTEM MENU.

The System Menu appears.

2 Select “Dubbing,” and press ENTER.

3 Select a dubbing direction, and press ENTER.

To dub titles from the HDD to a disc, select “HDD -> DVD.”

To dub titles from a disc to the HDD, select “DVD/CD -> HDD.”

4 Select “Create New Dubbing List,” and press ENTER.

The Dubbing List appears.

- If you have previously saved a Dubbing List and want to resume editing it, select “Use Previous Dubbing List,” and go to step 7.

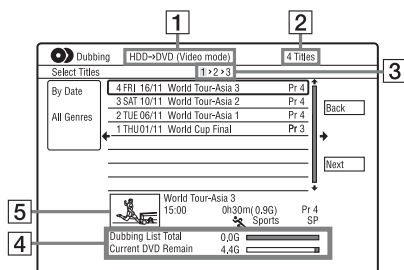

1 Direction of dubbing

2 Total number of titles to be dubbed

- 3** Dubbing step number
 Display 1: Select a title you want to dub (the “Select Titles” display).
 Display 2: Edit a title (the “Title Edit” display).
 Display 3: Confirm the settings and start dubbing (the “Start Dubbing” display).

- 4** Total size of the selected titles and available space on the disc to be dubbed (approximate)

- 5** Selected title’s thumbnail picture

5 Select a title, and press ENTER.

The selected title changes colour. When you select “HDD → DVD” in step 3, you can change the title order or search for a title by genre (see “3. Playing the Recorded Programme (Title List)” on page 40).

6 Repeat step 5 to select all of the titles in the order you want to dub.

7 Select “Next” using →, and press ENTER.

The “Title Edit” display appears. For details about editing, see “To edit titles on the Dubbing List” on page 92.

8 Select “Next” using →, and press ENTER.

The “Start Dubbing” display appears.

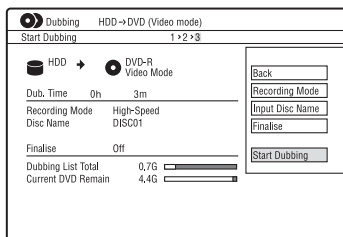

9 Select an option using ↑/↓, and press ENTER.

The options differ depending on the dubbing direction or disc type.

“Recording Mode”: Changes the dubbing mode of all selected titles at a time using ↑/↓ (page 154).

“Input Disc Name”: Changes the disc name (page 44).

“Finalise”: Select “Yes” to finalise a disc automatically after dubbing (DVD-RW/DVD-R (Video mode), or DVD+R).

10 Select “Start Dubbing,” and press ENTER.

When you set “Finalise” to “Yes” in step 9, select the title menu style, and press ENTER.

The recorder turns off automatically when you do not use the recorder for more than 20 minutes after the dubbing has finished.

To cancel dubbing

Press and hold HDD/DVD DUB for more than one second.

When dubbing (Move) is stopped partway, no part of the title will be moved to the dubbing target. However, note that this will decrease the free space for DVD+Rs/DVD-Rs.

About dubbing mode

“” appears next to the title that can be dubbed at high speed (“High-Speed” dubbing) in the “Title Edit” display. The following titles are dubbed at normal speed (“Real time” dubbing).

- Titles containing both main and sub sounds (except DVD-RWs/DVD-Rs (VR mode)).
- Titles recorded in mixed picture size (4:3 and 16:9, etc.) (except for DVD-RWs/DVD-Rs (VR mode)).
- Titles recorded on DVD+RWs/DVD-RWs (Video mode)/DVD+R/DVD-R (Video mode).

For the minimum required time for “High-Speed” dubbing, see page 157.

To edit titles on the Dubbing List

- 1 Follow steps 1 to 7 of “Dubbing Using Dubbing List” on page 90. The “Title Edit” display appears.

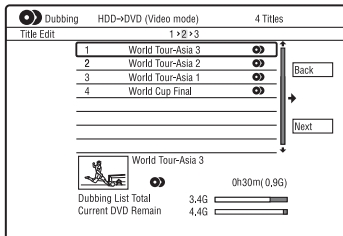

- 2 Select a title you want to edit, and press ENTER. The sub-menu appears.

- 3 Select an option, and press ENTER. The options differ depending on the dubbing direction or disc type.
 - “Erase”: Erases the selected title.
 - “Title Name”: Names or renames a title (page 44).
 - “A-B Erase”: Erases the section of the title (page 84).
 - “Move”: Changes the order of titles (page 87).
 - “Preview”: Allows you to check the content of a title.
 - “Divide”: Divides a title into two titles (page 84).
 - “Combine”: Combines two titles (page 87).
 - “Chapter Edit”: Edits chapters (page 85).
 - “Set Thumbnail”: Changes the title’s thumbnail frame that appears in the Title List (page 42).
 - “Recording Mode”: Sets the picture quality of the dubbing.
 - “Bilingual”: Sets how a bilingual audio programme is dubbed.
 - “Cancel”: Exits the sub-menu.

- 4 Repeat steps 2 and 3 to edit all of the titles.

- 5 Go to step 8 of “Dubbing Using Dubbing List” on page 90 to dub edited titles.

Notes

- The Dubbing List you created remains after dubbing. To edit the existing Dubbing List, select “Use Previous Dubbing List” in step 4. The Dubbing List is cleared when:
 - you change “Input Line System” setting in the “Basic” setup (page 125).
 - you reset the recorder (page 150).
 - you open the disc tray (except when dubbing from the HDD).
 - you edit the titles on a disc (except when dubbing from the HDD).
 - you switch the Title List to Original or Playlist (when dubbing from DVD-RWs/DVD-Rs in VR mode only).
 - you finalise the disc.
- The “seams” that are left over from editing may remain on the disc after dubbing to DVD+RWs/DVD-RWs (Video mode)/DVD+Rs/DVD-Rs (Video mode).
- Finalisation is cancelled if a timer recording starts, even if you set “Finalise” to “Yes” in step 9.

Making a Backup Disc (DVD Backup)

+RW -RWVideo +R -RVideo

You can dub all of the contents on a finalised DVD+RW/DVD+R or finalised DVD-RW/DVD-R (Video mode) to another recordable DVD+RW/DVD-RW or unused DVD+R/DVD-R via the HDD as a backup copy.

Note

Backup discs of unfinalised discs cannot be made.

1 Press SYSTEM MENU.

The System Menu appears.

2 Select “Dubbing,” and press ENTER.

3 Select “DVD Backup,” and press ENTER.

4 Select “Start new DVD Backup,” and press ENTER.

- If you have previously dubbed backup data to the HDD, select “Resume writing data,” and go to step 7.

5 Insert the DVD you are going to make a backup of.

6 Select “Start,” and press ENTER.

The recorder starts dubbing all of the contents on a DVD to the HDD.

7 Press \blacktriangle (open/close), and replace the DVD with a recordable DVD+RW/DVD-RW or an unused DVD+R/DVD-R.

To make a backup disc of DVD+RWs/DVD+Rs, insert a recordable DVD+RW or unused DVD+R.

To make a backup disc of DVD-RWs/DVD-Rs, insert a recordable DVD-RW or unused DVD-R.

8 Select “Start,” and press ENTER.

The recorder starts “High-Speed” dubbing the contents that were dubbed to the HDD in step 6.

9 Select “Cancel,” and press ENTER.

The disc is automatically finalised.

- To make another backup disc, replace discs, select “Start,” and press ENTER.

10 Select “Yes” or “No,” and press ENTER.

To erase the backup data on the HDD, select “Yes.”

To make another backup disc later, select “No.”

The recorder turns off automatically when you do not use the recorder for more than 20 minutes after the dubbing has finished.

To display the dubbing information

Press DISPLAY while dubbing.

To cancel DVD backup during dubbing

Press and hold HDD/DVD DUB for more than one second.

To erase backup data on the HDD

1 Select “Erase back-up data” in step 4, and press ENTER.

The display asks for confirmation.

2 Select “Yes,” and press ENTER.

Notes

- When dubbing to a DVD+R/DVD-R is stopped partway in step 8, you cannot play or record on the disc. However, a DVD+RW/DVD-RW can be used again after it is reformatted.
- You cannot make a backup disc of DVD+R DLs/DVD-R DLs.
- You may not use the “DVD Backup” function depending on the recording quality or physical condition of the disc, or characteristics of the recording device and authoring software.

Before HDD Camcorder Dubbing

You can dub the contents of a Sony HDD camcorder to the hard disk drive of the recorder via the USB jack on the front panel. Methods to dub from the HDD camcorder include:

- One-Touch Dubbing (Incremental Dubbing)
- Dubbing using the on-screen display (Incremental Dubbing/Full Dubbing)

Follow the instructions in “Preparing for HDD camcorder dubbing,” and then move on to the section on dubbing.

Hints

- If you want to dub by way of the LINE IN jacks, see “Recording from Connected Equipment” on page 72.
- If you want to record the contents of the HDD camcorder on a DVD, dub them to the HDD of the recorder first, and then edit the title on the HDD and dub it to a DVD.
- Parts finished dubbing remain on the recorder when the HDD space of the recorder becomes full or you stop dubbing partway.
- Dolby Digital 5.1 ch audio recorded in the HDD camcorder can be dubbed to the recorder in the same format, without down-conversion.

Notes

- No timer recordings or other operations are available when dubbing from the HDD camcorder.
- The supported device is Sony HDD SD (standard definition) camcorder released in or before April 2008.
- The recorder does not support the AVCHD format (HD (high definition) image quality). You can dub MPEG-2 format images (SD (standard definition) images) only.
- When the HDD camcorder contains still images and moving images, only moving images can be dubbed to the recorder.
- Playlist made with the HDD camcorder cannot be dubbed to the recorder.
- You cannot set the recording mode for HDD camcorder dubbing.
- When dubbing from the HDD camcorder, the recorder recognises and uses the shooting date and time information of the HDD camcorder. If the HDD camcorder’s clock is incorrect, the recorder may not dub the contents properly. Set the HDD camcorder’s clock correctly before shooting.
- Images of the HDD camcorder are not displayed when dubbing.
- You cannot record date, time, or the contents of the HDD camcorder memory onto the recorder.
- If you dub the contents recorded in high quality mode in the HDD camcorder to the recorder, it may take longer to finish dubbing than the recording.
- Set the recorder and HDD camcorder to the same colour system.

How titles and chapters are created

In each dubbing operation, the contents dubbed to the recorder are divided into titles by the shooting date. If the date has been changed to the next day during one shooting session, the shot image is included in the title of the date when the shooting session started. The title is divided into chapters. Each shooting session on the HDD camcorder becomes a chapter.

Hint

The title names are automatically labelled as “USB *** (start time of the first shooting session).”

Note

The dubbed contents are divided into titles in the following cases, even if they were all recorded in the same day:

- When the total recording time exceeds 12 hours.
- When the total number of scenes exceeds 99.

Preparing for HDD camcorder dubbing

Connect an HDD camcorder to the USB jack on the recorder.

Refer as well to the instruction manual supplied with the HDD camcorder before connecting.

- 1 Turn on your HDD camcorder and the recorder.
- 2 Connect your HDD camcorder to the USB jack on the front panel.

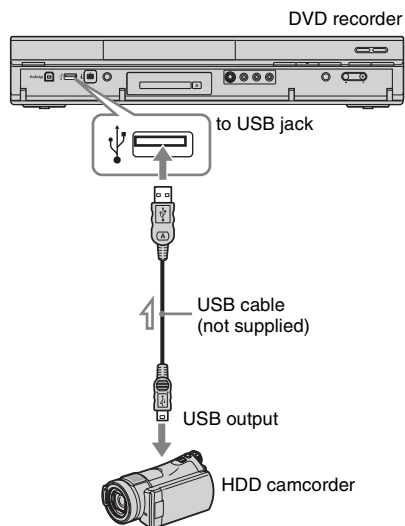

: Signal flow

- 3 Set your HDD camcorder to the USB connection mode (example: “ COMPUTER” or “ USB CONNECT”).

For details, refer to the operating instructions supplied with the HDD camcorder.

Notes

- Connect the HDD camcorder directly to the recorder.
- Do not disconnect the USB cable while dubbing.
- When signal input to the USB jack (type A) on the front panel or recorder operation cannot be performed correctly when using an HDD camcorder, connect the HDD camcorder to the LINE IN jack and follow the instructions of “Recording from Connected Equipment” on page 72.
- The recorder can recognise and store the shooting date and time information of up to 10 HDD camcorders. If you connect 11 or more HDD camcorders, one-touch dubbing and “Incremental Dubbing” cannot be made properly.

To restart the connected USB device

Select “Restart USB Device” of “USB” in the “Options 2” setup (page 142).

One-Touch Dubbing from HDD Camcorder (ONE-TOUCH DUB)

HDD

You can dub contents of your HDD camcorder onto the HDD of the recorder with a single press of the ONE-TOUCH DUB button on the recorder.

When dubbing from the HDD camcorder for the first time, all of the contents are dubbed to the recorder. The next time, only newly shot sessions that have not been dubbed yet are dubbed to the recorder.

Follow steps 1 to 3 of “Preparing for HDD camcorder dubbing” on page 95, and press ONE-TOUCH DUB on the recorder.

The recorder starts dubbing the contents on the HDD camcorder to the HDD Title List of the recorder.

The recorder turns off automatically if you do not use the recorder for more than 20 minutes after the dubbing has finished.

To stop during dubbing

Press ■ REC STOP.

Note that it may take a few seconds for the recorder to stop dubbing.

⚡ Notes

- The one-touch dubbing button on the HDD camcorder does not function with the recorder.
- In One-Touch Dubbing, the contents that have already been dubbed to the recorder cannot be dubbed again, even after you erase them from the recorder. To dub the same contents to the recorder again, dub the entire contents of the HDD camcorder (see “Dubbing from HDD Camcorder Using the On-Screen Display (HDD-Cam Dubbing)” on page 96).
- Data about the dubbed contents are all cleared when you reset the recorder (page 150).
- If the USB jack and the DV IN jack on the recorder are both connected to a compatible digital video camera, One-Touch Dubbing is performed via the USB jack.

Dubbing from HDD Camcorder Using the On-Screen Display (HDD-Cam Dubbing)

HDD

You can dub the contents of your HDD camcorder onto the HDD of the recorder using the on-screen display. Methods to dub from the HDD camcorder include:

- **Incremental Dubbing**
The recorder automatically detects the contents recorded on the connected HDD camcorder, and starts dubbing from the contents following the last dubbed contents if there are contents that have already been dubbed.
- **Full Dubbing**
The recorder dubs all contents of the HDD camcorder, including the contents that have already been dubbed to the recorder.

- 1 Follow steps 1 to 3 of “Preparing for HDD camcorder dubbing” on page 95.**
- 2 Press SYSTEM MENU.**
The System Menu appears.
- 3 Select “HDD-Cam/DV,” and press ENTER.**
- 4 Select “HDD-Cam Dubbing,” and press ENTER.**
- 5 Select “Incremental Dubbing” or “Full Dubbing,” and press ENTER.**
To dub newly shot contents only, select “Incremental Dubbing.”
To dub all contents of the HDD camcorder, select “Full Dubbing.”
The display asks for confirmation.

6 Select “Yes,” and press ENTER.

The recorder starts dubbing the contents on the HDD camcorder to the HDD Title List of the recorder.

The recorder turns off automatically if you do not use the recorder for more than 20 minutes after the dubbing has finished.

To stop dubbing

Press **■** REC STOP. Or, select “Exit” in step 6, and press ENTER.

Note

With “Incremental Dubbing,” the contents that have already been dubbed to the recorder are not dubbed again, even after you erase them from the recorder. You can dub only newly shot contents.

Before DV Camcorder Dubbing

This section explains dubbing with a DV camcorder and playing the contents of a DV camcorder via the DV IN jack on the front panel. If you want to dub by way of the LINE IN jacks, see “Recording from Connected Equipment” on page 72. The DV IN jack on this recorder conforms to the i.LINK standard.

Follow the instructions in “Preparing for DV camcorder dubbing,” and then move on to the section on dubbing. For more information about i.LINK, see “About i.LINK” on page 161.

How chapters are created

The contents dubbed to the HDD or DVD become a single title. This title is divided into chapters. When dubbing to the HDD or a DVD-RW/DVD-R (VR mode) and when “Auto Chapter (HDD/VR)” is set to “On” in the “Recording” setup (page 136), each shooting session on the tape becomes a chapter on the disc. For other discs, the recorder divides the title into chapters according to the “Auto Chapter (Video)” or “Auto Chapter (DVD+R/+RW)” setting in the “Recording” setup (page 136).

Preparing for DV camcorder dubbing

You can connect a DV camcorder to the DV IN jack on the recorder to record or edit from a DV/Digital8 format tape. Operation is straightforward because the recorder will fast forward and rewind the tape for you – you do not need to operate your DV camcorder.

Refer as well to the instruction manual supplied with the DV camcorder before connecting.

Hint

If you plan to do additional editing on a disc after the initial dub, use the DV IN jack and record on a DVD-RW/DVD-R (VR mode) or HDD.

Notes

- You cannot make a recording while DV camcorder dubbing.
- The DV IN jack is for input only. It will not output signals.
- You cannot use the DV IN jack when:
 - signal input to the DV IN jack on the front panel or recorder operation cannot be performed correctly when using a digital video camera (see “About i.LINK” on page 161). Connect the camera to the LINE IN jack and follow the instructions of “Recording from Connected Equipment” on page 72.
 - the input signal is not in DVC-SD format. Do not connect a MICRO MV format digital video camera even if it has an i.LINK jack.
 - the images on the tape contain copy protection signals, which limit recording.
- If you want to play DVDs dubbed from a DV camcorder on other DVD equipment, finalise the disc (page 46).
- Set the recorder and DV camcorder to the same colour system (page 125).

Hookups

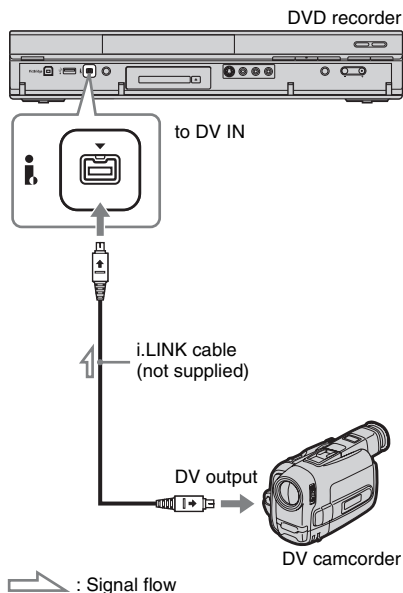

1 Press HDD or DVD to select the recording destination.

If you select DVD, insert a disc (see “1. Inserting a Disc” on page 38).

2 Insert the source DV/Digital8 format tape into your DV camcorder.

For the recorder to record or edit, your DV camcorder must be set to video playback mode.

3 Press REC MODE on the remote repeatedly to select the recording mode.

The recording mode changes as follows:

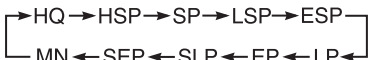

For details about the recording mode, see page 154. Note that you cannot select further manual recording mode options.

4 Set the “External Audio” setting in the “Audio In” setup (page 132).

5 Set the “DV Input” setting in the “Audio In” setup (page 132).

You are ready to start dubbing. Select one of the dubbing methods on the following pages.

To playback DV/Digital8 format tape

You can check the contents of DV/Digital8 format tape before dubbing. For details, see “Playing from a DV Camcorder” on page 101.

Notes

- You cannot connect more than one piece of digital video equipment to the recorder.
- You cannot control the recorder using another device or another recorder of the same model.
- You cannot record date, time, or the contents of the cassette memory onto the disc.
- If you record from a DV/Digital8 format tape that is recorded in multiple sound tracks, such as a tape with multiple sampling frequencies (48 kHz, 44.1 kHz, or 32 kHz), no sound or an unnatural sound will be output when playing back the sampling frequency switch point on the disc.
- In order to use this recorder’s “Auto Chapter” setting (page 98), be sure to correctly set the clock on your DV camcorder before shooting.
- The recorded picture may be momentarily affected or the start and end points of a title may be different from what you have set if the source DV/Digital8 format tape is in any of the following conditions. In this case, connect your digital video camera to the LINE IN jack and follow the instructions of “Recording from Connected Equipment” (page 72).
 - There is a blank space in the recorded portion of the tape.
 - The tape’s time code is not sequential.
 - If the picture size or the recording mode on the tape being dubbed changes.
- A blank or black coloured screen will be dubbed when the recorder is set to a different colour system from the DV tape contents’ system. Set “Input Line System” in the “Basic” setup to the same colour system as the DV tape contents’ system (page 125).

Dubbing an Entire DV Format Tape (DV One-Touch Dubbing)



You can record the entire contents of a DV/Digital8 format tape onto a disc with a single press of the ONE-TOUCH DUB button on the recorder. The recorder controls the DV camcorder for the whole process, and completes the recording.

Follow steps 1 to 5 of “Preparing for DV camcorder dubbing” on page 98, and press ONE-TOUCH DUB on the recorder.

The recorder rewinds the tape and then starts recording the tape contents.

After the recording is finished, the recorder rewinds the tape in the DV camcorder, and finalises the recorded disc (except DVD-RW/DVD-R (VR mode)) automatically.

To stop during recording

Press and hold **■ REC STOP** for more than 3 seconds.

Note that it may take a few seconds for the recorder to stop recording.

⚡ Notes

- When a blank space between the recordings on the tape continues for more than two minutes, DV One-Touch Dubbing ends automatically.
- The recorder will pause recording when there is a blank space or an image containing copy protection signals on the tape. The recorder will resume recording automatically when receiving a recordable signal.
- Finalisation is cancelled if a timer recording starts (except for DVD-RW/DVD-R (VR mode)).
- DV One-Touch Dubbing ends automatically when there are images containing copy protection signals at the beginning of the tape.
- When connecting digital video cameras to both DV IN jack and USB jack, pressing the ONE-TOUCH DUB button starts dubbing from the HDD camcorder. Disconnect the HDD camcorder from the USB jack to dub from the DV camcorder.

Dubbing Selected Scenes (DV Manual Dubbing)



You can select and dub scenes while playing a DV/Digital8 format tape.

- 1 Follow steps 1 to 5 of “Preparing for DV camcorder dubbing” on page 98.**
 - 2 Press SYSTEM MENU.**
The System Menu appears.
 - 3 Select “HDD-Cam/DV,” and press ENTER.**
 - 4 Select “DV Manual Dubbing,” and press ENTER.**
 - 5 Select the recording destination, “Record to Hard Disk Drive” or “Record to DVD,” and press ENTER.**
 - 6 Press \blacktriangle .**
The scene starts to play.
 - 7 Find the point on the DV/Digital8 format tape that you want to start dubbing from using $\blacktriangleleft/\blacktriangleright$ or $\blacktriangleleft/\blacktriangleright$, and press **III**.**
 - 8 Select “Start Rec.,” and press ENTER.**
The recorder starts dubbing.
 - 9 Select “Pause Rec.,” and press ENTER.**
The recorder pauses dubbing.
 - 10 Repeat steps 6 to 9 to dub more scenes.**
 - 11 Select “Stop Rec.,” and press ENTER.**
The selected scenes are dubbed as a single title.
-

To exit “DV Manual Dubbing”

Press SYSTEM MENU.

Hint

You can turn off the dubbing menu by pressing the DISPLAY button during dubbing. Press the DISPLAY button again to display the dubbing menu.

Note

You cannot set a scene to be shorter than one second.

Playing from a DV Camcorder

- 1 Connect your DV camcorder to the DV IN jack on the front panel.**
 - 2 Press SYSTEM MENU.**
The System Menu appears.
 - 3 Select “HDD-Cam/DV,” and press ENTER.**
 - 4 Select “DV Playback,” and press ENTER.**
 - 5 Start playback on the DV camcorder.**
Images from the DV camcorder appear on your TV screen.
-

To cancel playback

Press SYSTEM MENU.

Hint

You can dub the playing tape contents. During playback, press HDD or DVD to select the dubbing destination, and press ● REC. To stop dubbing, press ■ REC STOP.

About Jukebox

There are two methods to use Jukebox: connecting the USB device or copying audio tracks to the HDD.

When using Jukebox, you can do following:

- Store audio tracks on the HDD.
- Play audio tracks using various play modes.
- Label tracks, albums, or artists.
- Create a Playlist.

Notes on copying

- You cannot copy audio tracks on the HDD to discs or USB devices.
- Some audio tracks may not be copied depending on the file size.
- An artist name, album name, and MP3 audio track name are copied, and albums and MP3 tracks are stored in each artist folder. However, albums and MP3 audio tracks are stored in the “Unknown” folder when their artist name cannot be copied.
- Audio tracks from a CD are stored in the artist folder labelled “Unknown.” Names are automatically labelled; “A_*****_F_*****” for album, “A_*****_F_*****_T_*****” for audio tracks.
- When copying is stopped partway, tracks that have finished copying before you stop will remain copied onto the HDD as an album. You can check which albums have been copied in the Music Jukebox list (page 104).
- No other operations are available when copying audio tracks.
- While copying audio tracks, timer recordings are unavailable. If the timer is set during copying, the recorder starts the timer recording after copying is finished.
- Copy-protected CDs cannot be copied to the HDD.

Preparing for Using Jukebox

Connect a USB device to the USB jack on the recorder, or copy audio tracks from the connected USB device or CDs/DATA CDs/DATA DVDs to the HDD.

Connecting the USB device

You can connect a USB device to the USB jack on the recorder to listen to the MP3 audio tracks or copy to the HDD. Refer to the operating instructions supplied with the USB device before connecting.

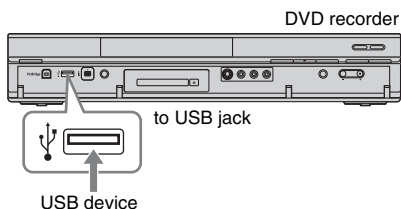

Note

Some USB devices may not work with this recorder.

Copying tracks or albums (USB → HDD)

You can copy up to 99 albums or 999 audio tracks on the USB device to the HDD.

- 1 Connect the USB device to the USB jack on the recorder (page 102).**
- 2 Press SYSTEM MENU.**
The System Menu appears.
- 3 Select “Music Jukebox,” and press ENTER.**
- 4 Select “Listen to Music from USB Device,” and press ENTER.**
The “Music Jukebox (USB)” appears.
- 5 Select an album to copy using ↑/↓, and press →.**
The sub-menu appears.

- 6** Select “Edit” using **↑/↓**, and press **ENTER**.
- 7** Select an item using **↑/↓**, and press **ENTER**.
To copy all albums, select “Copy all to HDD.”
To copy the selected albums, select “Copy to HDD.”
The display asks for confirmation.
- 8** Select “Yes” using **←/→**, and press **ENTER**.

The albums are copied to the HDD.

- To copy more albums, repeat from step 5.

To cancel copying

Press **ENTER**.

Copying audio tracks (DISC → HDD)

- 1** Insert a disc that you are going to copy to the HDD.
- 2** Press **SYSTEM MENU**.
The System Menu appears.
- 3** Select “Dubbing,” and press **ENTER**.
- 4** Select “DVD/CD → HDD” using **↑/↓**, and press **ENTER**.
The copying starts.

To cancel copying

Press **ENTER**.

Note

Before copying, select “CD” or “MP3” under “Data Format” in the Title List (DVD/CD) (page 74).

Copying tracks or albums on the HDD (HDD ↔ HDD)

- 1** Press **SYSTEM MENU**.
The System Menu appears.
- 2** Select “Music Jukebox,” and press **ENTER**.
- 3** Select “Listen to Music / Edit,” and press **ENTER**.
The “Music Jukebox (HDD)” appears.
- 4** Select an artist using **↑/↓**, and press **ENTER**.
- 5** Select an album using **↑/↓**, and press **ENTER**.
If you want to copy the album, press **→** instead of **ENTER**, then go to step 7.
- 6** Select a track to copy using **↑/↓**, and press **→**.
The sub-menu appears.
- 7** Select “Edit” using **↑/↓**, and press **ENTER**.
- 8** Select “Copy Album” or “Copy Track” using **↑/↓**, and press **ENTER**.
- 9** Select a copy destination (an artist or album) using **↑/↓**, and press **ENTER**.
The display asks for confirmation.
- 10** Select “Yes” using **←/→**, and press **ENTER**.
The albums or tracks are copied to the HDD.
 - To copy more tracks or albums, repeat from step 4.

To cancel copying

Press **ENTER**.

Playing Audio Tracks Using Jukebox/USB Device

- 1 Press SYSTEM MENU.**
The System Menu appears.
- 2 Select “Music Jukebox,” and press ENTER.**
- 3 Select “Listen to Music / Edit” or “Listen to Music from USB Device,” and press ENTER.**
To listen to the audio tracks on the HDD, select “Listen to Music / Edit.”
To listen to the MP3 audio tracks from the connected USB device, select “Listen to Music from USB Device.”
The Music Jukebox list appears.

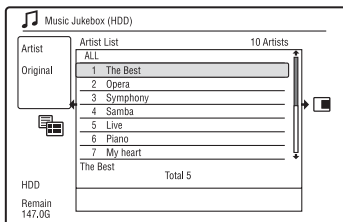

- 4 Select an artist, album, or track, and press \triangleright .**
(HDD only) To display an album list, select an artist using \uparrow/\downarrow , and press ENTER.
To display a track list, select an album using \uparrow/\downarrow , and press ENTER.
Playback starts.

To stop playback

Press \blacksquare (stop).

To return to the previous display

Press \leftarrow RETURN. If you cannot return to the artist list or album list using \leftarrow RETURN, see “To change the display mode (Original list only)” on page 104.

To scroll the list display by page (Page mode)

Press SUBTITLE (previous)/ANGLE (next) while the Music Jukebox list is displayed. Each time you press SUBTITLE (previous)/ANGLE (next), the Music Jukebox list changes to the previous/next page of the list.

To change the play information (HDD only)

Press DISPLAY repeatedly. Each time you press the button, information below the artist/album/track list is changed.

About the Playlist and Original list (HDD only)

You can switch the “Music Jukebox (HDD)” to show tracks in Original list or Playlist.

- Press \leftarrow while the “Music Jukebox (HDD)” is displayed.
- Select “Play List” using \uparrow/\downarrow , and press ENTER.
- Select an item using \uparrow/\downarrow , and press ENTER.

Item	Display
Original	Tracks in the Original list.
Play List 1 Play List 2 Play List 3 Play List 4	Tracks in each Playlist.
Favourites	Tracks in order of playback frequency. The track that is most often played is listed at the top.

To change the display mode (Original list only)

- Press \leftarrow while the “Music Jukebox (HDD)” is displayed.
- Select “Display Mode” using \uparrow/\downarrow , and press ENTER.
- Select an item using \uparrow/\downarrow , and press ENTER.

Item	Display
Artist (HDD only)	Artist list appears.
Album	Album list appears.
Track	Track list appears.

Adding audio tracks to a Playlist (HDD only)

You can add audio tracks on the HDD to the Playlist. You can add up to 25 audio tracks to each Playlist.

- 1 After step 2 of “Playing Audio Tracks Using Jukebox/USB Device,” select “Listen to Music / Edit,” and press ENTER.**
Switch the display to the Original list (page 104).
- 2 Select a track to add to the Playlist, and press →.**
The sub-menu appears.
- 3 Select “Add to Play List,” and press ENTER.**
- 4 Select a Playlist, and press ENTER.**
The track is added to the selected Playlist.
- 5 Repeat steps 2 to 4 to select all of the tracks you want to add to the Playlist.**
 - To check the Playlist tracks, switch to the Playlist.

Playback options

Buttons	Operations
⏪/⏩	Goes to the next or previous track when pressed during playback.
⏮/⏭ (fast reverse/ fast forward)	Fast reverses/fast forwards the disc when pressed during playback. Search speed changes as follows: <div style="margin-left: 20px;"> fast reverse fast forward ⏮FR1 ← → ⏭FF1 ⏮FR2 ← ← → → ⏭FF2 </div> When you press and hold the button, fast forward/fast reverse continues at the selected speed until you release the button. To resume normal playback, press ▷.

Buttons	Operations
⏸ (pause)	Pauses playback. To resume normal playback, press ▷.

Playing repeatedly (Repeat)

You can repeatedly play tracks or a single track.

- 1 Press → during playback.**
If you are playing tracks on the HDD, go to step 3.
- 2 (USB device only) Select “Play Mode” using ↑/↓, and press ENTER.**
The “Play Mode” menu appears.
- 3 Select “Repeat” using ↑/↓, and press ENTER.**
- 4 Select an item using ↑/↓.**
 “Repeat Artist” (HDD only): repeats tracks of the current artist.
 “Repeat Album”: repeats the current album.
 “Repeat Track”: repeats the current track.
 “Repeat Play List” (HDD only): repeats the current Playlist.
 “Repeat Programme” (USB device only): repeats the current programme (page 106).
- 5 Press ENTER.**
Repeat play starts.

To cancel Repeat play

Set “Repeat” to “Repeat Off” in step 4.

Note

You can select “Repeat Programme” only during Programme play.

Creating your own programme (Programme) (USB device only)

You can play the contents of the connected USB device in the order you want by arranging the order of the tracks on the connected USB device to create your own programme. You can make a programme of up to 24 tracks.

- 1 Press **→** while the “Music Jukebox (USB)” is displayed.
- 2 Select “Play Mode” using **↑/↓**, and press **ENTER**.
The “Play Mode” menu appears.
- 3 Select “Programme,” and press **ENTER**.
- 4 Select “Input/Edit Programme,” and press **ENTER**.
- 5 Select an album (example: Album 01) using **↑/↓**, and press **→**.

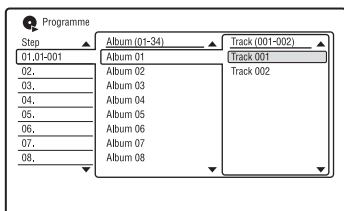

- 6 Select a track (example: Track 001) using **↑/↓**, and press **ENTER**.
The track is programmed.
If you make a mistake, select the step number (example: 01.) using **←/↑/↓**, and press **CLEAR**.
- 7 To programme other tracks, press **←/↑/↓/→** to select a step number, and repeat steps 5 and 6.
- 8 Press **▷**.
Programme play starts.

To cancel Programme play

Set “Programme” to “Cancel Programme Play” in the “Play Mode” menu during playback.

To erase the programme

Set “Programme” to “Erase Programme List” in the “Play Mode” menu.

💡 Hints

- The programme you made remains after Programme play finishes. To play the same programme again, set “Programme” to “Start Programme Play” in the “Play Mode” menu. However, the programme is cleared after you press **I/⏻**.
- You can repeat Programme play. During Programme play, set “Repeat” to “Repeat Programme” in the “Play Mode” menu (page 105).

To stop Programme play

Press **■** (stop).

Managing Audio Tracks on the Music Jukebox (HDD only)

You can erase or label artists/albums/tracks on the HDD.

1 Press SYSTEM MENU.

The System Menu appears.

2 Select “Music Jukebox,” and press ENTER.

3 Select “Listen to Music / Edit,” and press ENTER.

The “Music Jukebox (HDD)” appears.

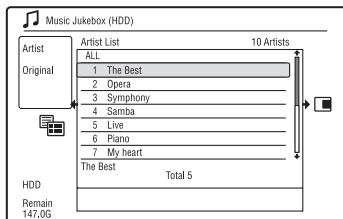

4 Select an artist, album, or track, and press →.

To display an album list, select an artist using ↑/↓, and press ENTER.

To display a track list, select an album using ↑/↓, and press ENTER.

5 Select an option, and press ENTER.

“Erase”: Erases the selected artist/album/track. Select “Yes” when asked for confirmation.

“Edit”: Allows you to make the following edits.

- “Artist Name”: Allows you to enter or re-enter an artist name (page 44).
- “Album Name”: Allows you to enter or re-enter an album name (page 44).
- “Track Name”: Allows you to enter or re-enter a track name (page 44).
- “Copy Album”: Allows you to copy an album (page 103).
- “Copy Track”: Allows you to copy a track (page 103).

“Repeat”: Repeats playback of artist/album/track (page 105).

“Add to Play List”: Allows you to add tracks to a Playlist (page 105).

“Play List Name”: Allows you to enter or re-enter a Playlist name (up to 12 characters) (page 44).

Note

You cannot edit audio tracks on the connected USB device.

About the “Photo Album” Function

The “Photo Album” function enables you to do following.

- Store JPEG image files on the HDD.
- View JPEG image files on the HDD, DATA DVDs (DVD-RWs/DVD-Rs)/ DATA CDs, or connected USB device.
- Edit JPEG image files.
- Print JPEG image files.
- Copy JPEG image files and slideshow to DVD-RWs/DVD-Rs.
- Create a slideshow with your favourite music and graphic effects (x-Pict Story).

Preparing for Using the “Photo Album” Function

Connect a USB device to the USB jack on the recorder, or copy JPEG image files from DATA CDs/DATA DVDs or the connected USB device to the HDD.

Connecting the USB device

You can connect a USB device (digital still camera, Memory card reader, and USB memory) to the USB jack on the recorder to view JPEG image files or copy to the HDD. Refer to the operating instructions supplied with the USB device before connecting.

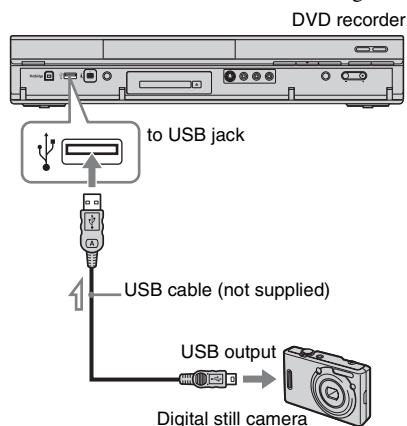

 : Signal flow

Note

Some USB devices may not work with this recorder.

Copying JPEG image files to the HDD (DISC/USB → HDD)

- 1** Insert a disc that you are going to copy to the HDD or connect the USB device to the USB jack on the recorder.
- 2** Press **SYSTEM MENU**.
The System Menu appears.

3 Select “Photo Album,” and press ENTER.

The “Photo Album” menu appears.

4 Select the item, and press ENTER.

To copy from DATA CDs/DATA DVDs (DVD-RWs/DVD-Rs), select “View Photos on a DVD/CD.”

To copy from the connected USB device, select “View Photos on a USB Device.”

The “Photo Album” list appears.

Example: DVD/CD

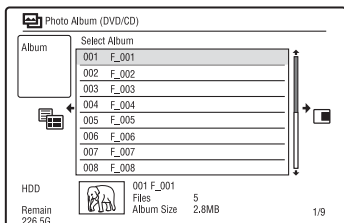

5 Select an album or JPEG image file using ↑/↓, and press →.

The sub-menu appears.

6 Select “Multi-Mode” using ↑/↓, and press ENTER.

- To copy all the albums and JPEG image files, select “Copy all to HDD,” and go to step 11.
- To copy the album or file selected in step 5 only, select “Copy to HDD,” and go to step 11.

7 Select an album or JPEG image file, and press ENTER.

A check mark appears in the check box by the selected item.

- To clear the check mark, press ENTER again.
- To clear all check marks, press → to select “Single-Mode” from the sub-menu.

8 Repeat step 7 to select all of the albums or JPEG image files you want to copy.

9 Press →.

The sub-menu appears.

10 Select “Copy to HDD,” and press ENTER.

The display asks for confirmation.

11 Select “Yes,” and press ENTER.

- To cancel, select “No.”

Copying all JPEG image files from the connected USB device (USB → DVD-RW/DVD-R)

1 Connect the USB device to the USB jack on the recorder.

2 Insert a blank DVD-RW/DVD-R (Video mode).

3 Press SYSTEM MENU.

The System Menu appears.

4 Select “Photo Album,” and press ENTER.

The “Photo Album” menu appears.

5 Select “Copy Photos from a Digital Camera,” and press ENTER.

The display asks for confirmation.

6 Select “Yes,” and press ENTER.

- To cancel, select “No.”

Hint

See “7. Reformatting a Disc” (page 49) to format DVD-RWs/DVD-Rs in Video mode.

Notes

- During copying, other operations cannot be performed.
- While copying JPEG image files, timer recordings are unavailable. If the timer is set during copying, the recorder starts the timer recording after copying is finished.

Copying JPEG image files or albums on the HDD (HDD ↔ HDD)

- 1 Press SYSTEM MENU.**

The System Menu appears.
- 2 Select “Photo Album,” and press ENTER.**

The “Photo Album” menu appears.
- 3 Select “View/Edit Photos on the HDD,” and press ENTER.**

The “Photo Album” list appears.
- 4 Select an album using ↑/↓.**

To copy the selected album, go to step 6.
To copy a JPEG image file, go to step 5.
- 5 Press ENTER, and select a JPEG image file using ↑/↓.**
- 6 Press →.**

The sub-menu appears.
- 7 Select “Multi-Mode” using ↑/↓, and press ENTER.**
 - To copy the selected album, select “Copy Album Contents” in “Album Options,” and go to step 12.
 - To copy the selected files, select “Copy” in “File Options,” and go to step 12.
- 8 Select an album or JPEG image file, and press ENTER.**

A check mark appears in the check box by the selected item.

 - To clear the check mark, press ENTER again.
 - To clear all check marks, press → to select “Single-Mode” from the sub-menu.
- 9 Repeat step 8 to select all of the albums or JPEG image files you want to copy.**
- 10 Press →.**

The sub-menu appears.
- 11 Select “Copy,” and press ENTER.**

- 12 Select the destination album using ↑/↓, and press ENTER.**

The display asks for confirmation.

- 13 Select “Yes,” and press ENTER.**
 - To cancel, select “No.”

Note

Albums or JPEG image files are not copied to the HDD in the following cases.

- when the HDD disc space is insufficient for copying.
- when there are already the maximum number of files and/or albums on the HDD.

Copying JPEG image albums to a disc (HDD → DVD-RW/DVD-R)

You can copy the edited JPEG image albums to a DVD-RW/DVD-R (Video mode). A slideshow is also recorded to the disc as a video file. You can play the slideshow on other DVD equipment that may not be compatible with the playback of JPEG image files.

- 1 Insert a DVD-RW/DVD-R (in Video mode).**
- 2 Press SYSTEM MENU.**

The System Menu appears.
- 3 Select “Photo Album,” and press ENTER.**

The “Photo Album” menu appears.
- 4 Select “View/Edit Photos on the HDD,” and press ENTER.**

The “Photo Album” list appears.
- 5 Select an album using ↑/↓, and press →.**

The sub-menu appears.
- 6 Select “Multi-Mode,” and press ENTER.**

To copy the album selected in step 5 only, go to step 10.

7 Select an album, and press ENTER.

A check mark appears in the check box by the selected item.

- To clear the check mark, press ENTER again.
- To clear all check marks, press → to select “Single-Mode” from the sub-menu.

8 Repeat step 7 to select all of the albums you want to copy.

9 Press →.

The sub-menu appears.

10 Select “Copy to DVD,” and press ENTER.

The display asks for confirmation.

11 Select “Yes,” and press ENTER.

The selected JPEG image albums are copied in the “PICTURE” folder on the disc.

The JPEG image album names are automatically labelled as “***ALBUM.”

If you want to play the disc on other DVD equipment, finalise the disc (page 46).

- To cancel, select “No.”

Hints

- See “7. Reformatting a Disc” (page 49) to format DVD-RWs/DVD-Rs in Video mode.
- See the “Photo Album” list to check which albums have been copied (page 112).

Notes

- You may not be able to play the slideshow depending on DVD equipment.
- You cannot copy JPEG image files to a recordable DVD which has been recorded using other recorders/devices.
- DATA DVDs finalised on this recorder may not be able to play on other equipment.
- You can record up to 99 slideshows to a disc.
- When copying an album containing more than 99 JPEG image files to a disc, slideshows will be created with every 99 JPEG image files and recorded to a disc.
- For DVDs, the available disc space does not increase even if you erase slideshows.

Copying JPEG image files to a disc (HDD → DVD-RW/DVD-R)

You can copy the edited JPEG image files to a DVD-RW/DVD-R (Video mode).

A slideshow is also recorded to the disc as a video file. You can play the slideshow on other DVD equipment that may not be compatible with the playback of JPEG image files.

1 Follow steps 1 to 4 of “Copying JPEG image albums to a disc (HDD → DVD-RW/DVD-R)” on page 110.

The “Photo Album” list appears.

2 Select an album using ↑/↓, and press ENTER.

The photo list appears.

3 Select a JPEG image file using ↑/↓, and press →.

The sub-menu appears.

4 Select “Multi-Mode,” and press ENTER.

To copy the JPEG image file selected in step 3 only, go to step 8.

5 Select a JPEG image file, and press ENTER.

A check mark appears in the check box by the selected item.

- To clear the check mark, press ENTER again.
- To clear all check marks, press → to select “Single-Mode” from the sub-menu.

6 Repeat step 5 to select all of the JPEG image files you want to copy.

7 Press →.

The sub-menu appears.

8 Select “Copy to DVD,” and press ENTER.

The display asks for confirmation.

9 Select “Yes,” and press ENTER.

The selected JPEG image files are copied in the “PICTURE” folder on the disc.

The JPEG image file names are automatically labelled as “PHOT****.”

If you want to play the disc on other DVD equipment, finalise the disc (page 46).

- To cancel, select “No.”

To select a JPEG image file from a different album

- 1 Switch to the album list in step 5.
For instructions, see “To switch between the album list and JPEG image file list” on page 114.
- 2 Select an album using **↑/↓**, and press **←**.
- 3 Switch to the JPEG image file list.
For instructions, see “To switch between the album list and JPEG image file list” on page 114.
- 4 Select a JPEG image file using **↑/↓**, and press ENTER.

Hints

- See “7. Reformatting a Disc” (page 49) to format DVD-RWs/DVD-Rs in Video mode.
- See the “Photo Album” list to check which JPEG image files have been copied (page 112).

Notes

- You may not be able to play the slideshow depending on DVD equipment.
- You cannot copy JPEG image files to a recordable DVD which has been recorded using other recorders/devices.
- DATA DVDs finalised on this recorder may not be able to play on other equipment.
- You can record up to 99 slideshows to a disc.
- For DVDs, the available disc space does not increase even if you erase slideshows.

Using the “Photo Album” List

You can play JPEG image files on the HDD, DATA DVDs/DATA CDs, or connected USB device using the “Photo Album” list.

1 Press SYSTEM MENU.

The System Menu appears.

2 Select “Photo Album,” and press ENTER.

The “Photo Album” menu appears.

3 Select the item, and press ENTER.

To play JPEG image files on the HDD, select “View/Edit Photos on the HDD.”

To play JPEG image files on DATA CDs/DATA DVDs, select “View Photos on a DVD/CD.”

To play JPEG image files on the connected USB device, select “View Photos on a USB Device.”

The “Photo Album” list appears.

4 Select an album using **↑/↓**, and press ENTER.

To show the 4-Photo List or 1-Photo List, press **←** to select “Title View,” and press ENTER, then select “4 Photos” or “1 Photo” using **↑/↓**, and press ENTER.

12-Photo List (Example: HDD)

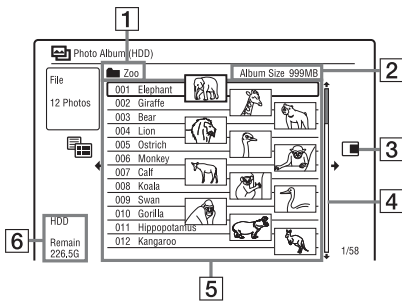

4-Photo List

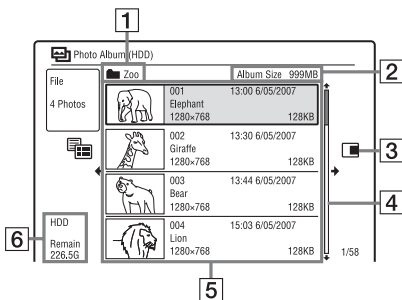

1-Photo List

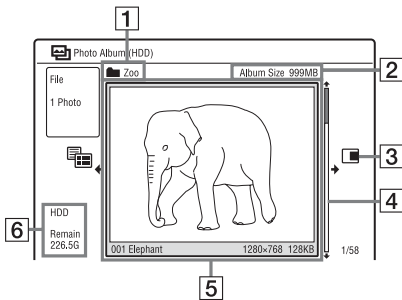

1 Album name

2 Album size

3 Sub-menu:

Press **→** to display the sub-menu.

The sub-menu displays options applicable only to the selected item. The displayed options differ depending upon the model, situation, and disc type.

For details about the sub-menu options, see "Managing JPEG Image Files on the HDD" on page 117.

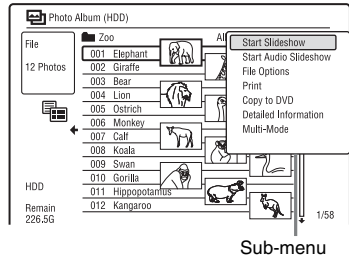

4 Scroll bar:

Appears when all of the JPEG image files do not fit on the list. To view the hidden JPEG image files, press **↑/↓**.

5 Album and JPEG image file information:

Displays the image, JPEG image file number, recording date and time, JPEG image file name, and JPEG image file size. "⏏" appears for protected JPEG image files.

6 Remaining space on the HDD

To scroll the list display by page (Page mode)

Press **⏪/⏩** while the "Photo Album" list is displayed. Each time you press **⏪/⏩**, the "Photo Album" list changes to the previous/next page of albums/JPEG image files.

To switch between the album list and JPEG image file list

- 1 Press **←** while the “Photo Album” list is displayed.
- 2 Select “Display Mode” using **↑/↓**, and press ENTER.
- 3 Select “File” or “Album” using **↑/↓**, and press ENTER.

Hints

- You can switch the thumbnail picture on the album list among the JPEG image files in the selected album by pressing **◀▶**.
- You can switch to the previous or next album by pressing **◀▶** on the JPEG image file list.

To turn off the “Photo Album” list

Press SYSTEM MENU.

To display the detailed information

- 1 Select a JPEG image file, and press **→**.
- 2 Select “Detailed Information,” and press ENTER.
The detailed information for the selected JPEG image file appears.

To reload the files or folders

When a disc or the connected USB device contains 1,000 or more files and/or 100 or more folders, select “Read next” in the “Photo Album” list, and press ENTER to view unloaded files or folders.

It may take a few minutes to load files or folders.

Note

The thumbnail for a file that cannot be playable on the recorder is displayed as “.”

Playing a slideshow

- 1 Follow steps 1 to 4 of “Using the “Photo Album” List.”
The “Photo Album” list appears.
Switch between the album list and JPEG image file list, if necessary.
- 2 Select an album or JPEG image file using **↑/↓**, and press **▷**.
The slideshow starts.

Hint

You can start a slideshow by selecting “Start Slideshow” from the sub-menu.

Notes

- Depending on the aspect ratio, some pictures may be displayed with black bands at top and bottom, or left and right.
- Large picture files may take a few seconds to display. This is not a malfunction.

To stop a slideshow

Press **■** (stop) or **↶** RETURN.

To pause a slideshow

Press **⏸** (pause).

To view the previous/next image during a slideshow

Press **◀▶**.

To zoom an image

Press ZOOM repeatedly during a slideshow. Each time you press ZOOM, the magnification changes as shown below.
2× → 4× → normal magnification
You can move the area you want to zoom using **←/↑/↓/→**.

To rotate an image

Press ANGLE repeatedly during a slideshow.

Each time you press ANGLE, the image turns clockwise by 90°.

To play a slideshow with the sound (HDD only)

You can enjoy a slideshow while listening to the sound stored in the HDD. First prepare Music Playlists by adding audio tracks using Jukebox (see “Adding audio tracks to a Playlist (HDD only)” on page 105).

- 1 Select “View/Edit Photos on the HDD” in step 3 of “Using the “Photo Album” List” on page 112.
The “Photo Album” list appears.
Switch between the album list and JPEG image file list, if necessary.
- 2 Select an album or JPEG image file using **↑/↓**, and press **→**.
- 3 Select “Start Audio Slideshow,” and press ENTER.
- 4 Select the desired Music Playlist or “Favourites” using **←/→**.
- 5 Select “Start,” and press ENTER.
The slideshow and the playback from the first track of the selected Music Playlist start.

Notes

- While playing a slideshow with the sound, you cannot do the following:
 - Zoom, rotate, skip or pause an image.
 - Display information on the screen by pressing DISPLAY.
- If there is no audio track in the selected Music Playlist, the slideshow is played back with no sound.

Creating a Slideshow with Your Favourite Music and Graphic Effects (x-Pict Story) (HDD only)

You can easily create and play your own slideshow with your favourite music in Music Playlist and graphic effects using the JPEG image files on the HDD (x-Pict Story). First prepare Music Playlists by adding audio tracks using Jukebox (see “Adding audio tracks to a Playlist (HDD only)” on page 105). The created x-Pict Story is automatically stored in the Title List (HDD) and you can copy it onto a recordable disc.

- 1 **Press SYSTEM MENU.**
The System Menu appears.
- 2 **Select “Photo Album,” and press ENTER.**
The “Photo Album” menu appears.
- 3 **Select “View/Edit Photos on the HDD,” and press ENTER.**
The “Photo Album (HDD)” list appears.
- 4 **Select an album, and press →.**
The sub-menu appears.
- 5 **Select “Create x-Pict Story” using ↑/↓, and press ENTER.**

6 Select a graphic effect and a Music Playlist using ←/↑/↓/→.

- “Theme”: Select a theme. The recorder adds graphic effects according to the theme you set from the following:
 - “Happy moments (1)”: with simple graphic effects
 - “Happy moments (2)”: with simple graphic effects rapidly changing
 - “Nostalgic memories”: in monochrome
 - “Sweetest recollections”: with moving graphic effects
 - “Blissful life”: with moving graphic effects rapidly changing
 - “Normal”: no graphic effects
- “Play List”: Select the desired Music Playlist or “Favourites.” For an explanation of how to make a Music Playlist, see “Adding audio tracks to a Playlist (HDD only)” on page 105.

7 Select “Next,” and press ENTER.

The copyright message appears on the screen.

8 Select “Yes” using ←/→, and press ENTER.

The x-Pict Story is saved as a video file in the Title List on the HDD.

The title names are automatically labelled as “x-Pict_Story ***” using the name of the selected album folder.

To stop creating x-Pict Story

Press and hold ■ REC STOP for more than 3 seconds.

🔔 Hints

- The order of audio tracks in the created x-Pict Story is followed by that of Music Playlist. If you want to change its order, change the order of Music Playlist before creating an x-Pict Story.
- If the selected folder has no name, the title names are automatically labelled with the date when the x-Pict Story was created.
- An x-Pict Story is created in the HQ mode.
- To edit x-Pict Story titles, see “Erasing and Editing” on page 82.

🔔 Notes

- You cannot make a recording while creating an x-Pict Story.
- If there is no JPEG image file in the selected folder, you cannot create an x-Pict Story.
- If there is no audio track in the selected Music Playlist, the x-Pict Story is created with no sound.
- The selected Music Playlist may not be played back to the end depending on the number of JPEG image files.
- If the HDD is full, a warning message appears and you cannot create an x-Pict Story.
- While creating an x-Pict Story, you cannot do the following:
 - Zoom, rotate, skip or pause an image.
 - Display information on the screen by pressing DISPLAY.
- The order of graphic effects changes at random every time you create an x-Pict Story in the same theme.
- Do not disconnect (remove) or connect (insert) the USB cable, i.LINK cable or CAM while creating an x-Pict Story. This may cause the x-Pict Story to be created incorrectly.
- The graphic effect may not show a smooth motion or not appear correctly on the created x-Pict Story depending on conditions, such as size of the image files.

To play an x-Pict Story

You can play a created x-Pict Story from the Title List on the HDD.

For details, see “3. Playing the Recorded Programme (Title List)” on page 40.

To dub an x-Pict Story

You can dub a created x-Pict Story to DVDs. For details, see “Dubbing (HDD ↔ DVD)” on page 89. If you want to play the disc on other DVD equipment, finalise the disc (page 46).

Managing JPEG Image Files on the HDD

1 Press SYSTEM MENU.

The System Menu appears.

2 Select “Photo Album,” and press ENTER.

The “Photo Album” menu appears.

3 Select “View/Edit Photos on the HDD,” and press ENTER.

The “Photo Album (HDD)” list appears.

4 Select an album or JPEG image file, and press →.

The sub-menu appears.

5 Select an option, and press ENTER.

You can make the following edits to the album/JPEG image file.

“Start Slideshow”: Starts a slideshow (page 114).

“Start Audio Slideshow” (HDD only): Starts a slideshow with the sound (page 115).

“Create x-Pict Story”: Creates a new x-Pict Story (page 115).

“New Album”: Creates a new album.

“Album Options”

- “Erase Album”: Erases the selected album.
- “Copy Album Contents”: Copies all JPEG image files in the selected album to the HDD (page 110).
- “Rename Album”: Changes the selected album name (page 44).
- “Protect Album Contents”: Protects all JPEG image files in the selected album.
- “Cancel Protection”: Cancels protection of all JPEG image files in the selected album.

“Copy to DVD”: Copies the selected album or JPEG image file to a DVD (page 110).

“Multi-Mode”: Selects multiple albums or JPEG image files to edit.

“Copy all to HDD”: Copies all the albums and JPEG image files to the HDD (page 108).

“Copy to HDD”: Copies the selected album or JPEG image file to the HDD (page 108).

“File Options”

- “Erase”: Erases the selected JPEG image file.
- “Copy”: Copies the selected JPEG image file (page 110).
- “Rename File”: Changes the selected JPEG image file name (page 44).
- “Protect”: Protects the selected JPEG image file. Select again to cancel the protection.

“Print”: Prints the selected JPEG image file (page 118).

“Detailed Information”: Displays the detailed information for the selected JPEG image file (page 114).

“Single-Mode”: Cancels “Multi-Mode.”

Printing JPEG Image Files

You can print JPEG image files on the HDD, DATA DVDs/DATA CDs, or connected USB device by connecting a PictBridge-compatible printer to the USB jack on the recorder.

Refer to the instructions supplied with the printer.

1 Connect a PictBridge-compatible printer to the USB jack on the recorder.

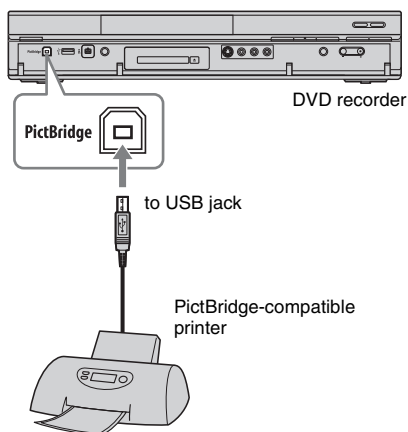

2 Connect the USB device to the USB jack on the recorder.

When printing JPEG image files on the HDD or DATA DVDs/DATA CDs, skip this step.

3 Press SYSTEM MENU.

The System Menu appears.

4 Select "Photo Album," and press ENTER.

The "Photo Album" menu appears.

5 Select the item, and press ENTER.

To print JPEG image files on the HDD, select "View/Edit Photos on the HDD." To print JPEG image files on a DATA DVD/DATA CD, select "View Photos on a DVD/CD."

To print JPEG image files from the connected USB device, select "View Photos on a USB Device."

The "Photo Album" list appears.

6 Select an album, and press ENTER.

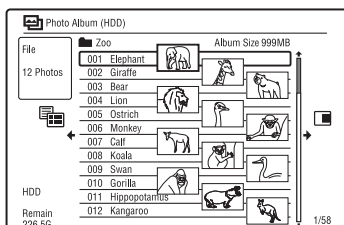

7 Select a file using ↑/↓, and press →.

The sub-menu appears.

8 Select the item, and press ENTER.

To print two or more files, select "Multi-Mode."

To print the file selected in step 7 only, go to step 12.

9 Select a file, and press ENTER.

A check mark appears in the check box by the selected item.

- To clear the check mark, press ENTER again.
- To clear all check marks, select "Single-Mode."

10 Repeat step 9 to select all files you want to print.

11 Press →.

The sub-menu appears.

12 Select "Print," and press ENTER.

The display asks for confirmation.

13 Select "Start," and press ENTER.

You can set the paper size and layout. Refer to the operating instructions supplied with the printer.

To cancel printing

Press ENTER.

To display the connected printer

Select “Confirm Printer” of “USB” in the “Options 2” setup (page 142).

To restart the connected USB device

Select “Restart USB Device” of “USB” in the “Options 2” setup (page 142).

 **Hint**

Printing options, such as paper size or layout, differ depending on the printer. For details, refer to the instructions supplied with the printer.

Adjusting Picture Quality



* DivX video file only

You can adjust the picture quality from the connected equipment, such as a TV or VCR, and also the picture quality of broadcasts that the recorder can receive by selecting a preset setting. You can also adjust the picture quality by changing detailed settings, and store up to three settings in the memory.

1 Press SYSTEM MENU in stop mode.

For adjusting playback picture quality, press SYSTEM MENU during playback.

The System Menu appears.

2 Select "Picture Adjustment," and press ENTER.

3 Select a preset setting using ←/→, and press ENTER.

For recording

Tuner	TV broadcast
VCR	Video cassettes
DTV	Digital broadcast
Memory1/ Memory2/ Memory3	Your own settings. To create your own settings, see "To create your own setting" on page 120.

For playback

Dynamic	Produces a bold dynamic picture by increasing the picture contrast and the colour intensity.
Standard	Displays a standard picture.
Professional	Displays an original picture.
Memory1/ Memory2/ Memory3	Your own settings. To create your own settings, see "To create your own setting" on page 120.

To check the detailed settings for the selected preset, press DISPLAY.

4 Press SYSTEM MENU to exit.

To create your own setting

1 Select "Memory1," "Memory2," or "Memory3" in step 3.

2 Select "Detailed Settings," and press ENTER.

The display for adjusting detailed settings appears.

3 Select an item using ↑/↓, and adjust settings using ←/→.

For explanation of each setting, see the tables below.

4 Press SYSTEM MENU to exit.

The setting is automatically stored as the setting you selected in step 1.

◆ Setting options for recording picture quality

For details about each setting, see the explanation of the display.

Prog. Motion	Adjusts the progressive video signal when “Component Video Out” is set to “Progressive” (page 130) or when using the HDMI connection. Select “Motion” for a picture, including subjects that move dynamically. Select “Still” for a picture with little movement.
Cinema	Converts the progressive video signal to match the type of DVD software that you are watching when “Component Video Out” is set to “Progressive” (page 130) or when using the HDMI connection. Select “Auto” to detect the software type (Film-based or Video-based) automatically and select the appropriate conversion mode. Normally select this position. Select “Off” to fix the conversion mode to the mode for Video-based software.
3-D Y/C*	Adjusts the brightness/colour separation for the video signals. Select “Motion” for a picture, including subjects that move dynamically. Select “Still” for a picture with little movement.
YNR* (luminance noise reduction)	Reduces noise contained in the luminance element of the video signal.
CNR* (chroma noise reduction)	Reduces noise contained in the chroma element of the video signal.
Detail*	Adjusts the sharpness of images outlines.
White AGC*	Turn on for automatic white level adjustment.

White Enhancer*	Adjusts the intensity of white.
Black Enhancer*	Adjusts the intensity of black.
Black Level*	Selects the black level (setup level) for the NTSC video signals. Select “ON” to set the black level of the input signals to the standard level. Normally, select “OFF” position.
Hue*	Adjusts the colour balance.
Chroma Level*	Makes the colours deeper or lighter.

* For analogue broadcasting only

◆ Setting options for playback picture quality

For details about each setting, see the explanation of the display.

Prog. Motion	Adjusts the progressive video signal when “Component Video Out” is set to “Progressive” (page 130) or when “Screen Resolution” is set to other than “720 x 576i” (or “720 x 480i”) (page 139). Select “Motion” for a picture, including subjects that move dynamically. Select “Still” for a picture with little movement.
Cinema	Converts the progressive video signal to match the type of DVD software that you are watching when “Component Video Out” is set to “Progressive” (page 130) or when “Screen Resolution” is set to other than “720 x 576i” (or “720 x 480i”) (page 139). Select “Auto1” to automatically detect the software type (Film-based or Video-based) and select the appropriate conversion mode. Normally select this position. If the picture appears unnatural, select “Auto2,” “On,” or “Off.”

YNR (luminance noise reduction)	Reduces noise contained in the luminance element of the video signal.
BNR (block noise reduction)	Reduces "block noise" or mosaic-like patterns in the picture.
MNR (mosquito noise reduction)	Reduces the faint noise appearing around the outlines of the images. The noise reduction effects are automatically adjusted within each setting range according to the video bit rate and other factors.
Sharpness	Sharpens the outlines of the images.
Detail	Adjusts the sharpness of images outlines.
White Enhancer	Adjusts the intensity of white.
Black Enhancer	Adjusts the intensity of black.
Black Level	Selects the black level (setup level) for the video signals. Select "ON" to raise the black level. Select this when the picture appears too dark. Select "OFF" to set the black level of the input signals to the standard level. Normally, select this position.
Gamma Correction	Adjusts how dark areas look.
Hue	Adjusts the colour balance.
Chroma Level	Makes the colours deeper or lighter.

🔊 Notes

- If the outlines of the images on your screen become blurred, set "BNR" and/or "MNR" to "Off."
- Depending on the disc or the scene being played, the above BNR or MNR effects may be hard to discern. Also, these functions may not work with some screen sizes.
- The following settings are not available for the signals output from the HDMI jack.
 - "Sharpness"
 - "White Enhancer"
 - "Black Enhancer"
 - "Black Level"
 - "Gamma Correction"
 - "Hue"
 - "Chroma Level"

Using the Setup Menus

You can change the settings of the recorder, such as picture quality settings, audio settings, etc.

- 1 Press SYSTEM MENU while the recorder is in stop mode.**
- 2 Select “Disc Setup” or “Initial Setup” using \uparrow/\downarrow , and press ENTER.**
- 3 Select the desired setup item using \uparrow/\downarrow , then press ENTER.**

See the explanations in the following sections.

The default settings are underlined.

Disc Settings (Disc Setup)

You can adjust DVD related settings.

Basic

Input Disc Name

You can label a disc.

For details, see page 45.

Protect Disc

You can protect a disc against erasure.

For details, see page 45.

Format DVD-RW (DVD-RW only)

The recorder automatically starts formatting in VR mode or Video mode, whichever is selected below, when a new, unformatted DVD-RW is inserted.

<u>VR Mode</u>	Automatically formats the disc in VR mode.
Video Mode	Automatically formats the disc in Video mode.

Format

You can manually re-format a DVD+RW, DVD-RW, or DVD-R disc to make a blank disc.

For details, see page 49.

Finalise

Finalises a disc to play it on other DVD equipment.

For details, see page 46.

Optimise HDD

As you record, erase and edit recordings repeatedly, the HDD file system gradually becomes fragmented. To 'clean up' all the fragmented files, optimise the HDD periodically. When the HDD needs optimising, a message recommending optimisation will appear automatically. To cancel optimisation, press ENTER. The HDD will be partly optimised.

Notes

- It will take about eight hours to optimise the HDD. During optimisation, other operations, such as recording or playback, cannot be performed.
- You cannot optimise the HDD when the HDD disc space is insufficient for optimising. Erase titles to open up disc space (page 83).

Format HDD.

You can format the HDD and resolve the problem when the hard disk error occurred. "Format HDD." can be selected only when the hard disk needs formatting. Note that all of the recorded content on the HDD will be erased.

Recorder Settings (Basic)

You can make clock and other recorder-related settings.

Clock Setting

The recorder will automatically set the clock when any digital channels have been scanned and stored.

Auto (Auto Clock Set)

Turns on the Auto Clock Set function when a programme position in your local area broadcasts a time signal.

- 1 Press **←/→** repeatedly until the programme position of the station that carries a time signal appears.
- 2 Press **↓** to select "Start," and press ENTER.
 - If the recorder does not receive a time signal from any station, press **↶** RETURN and set the clock manually.
 - If the Auto Clock Set function did not set the clock correctly for your local area, try another station for the Auto Clock Set function or set the clock manually.

Manual (Manual Clock Set)

Set the clock manually.

- 1 Press **←/→** to select the time zone for your area or GMT (Greenwich Mean Time), and press **↓**.
- 2 Select "On" using **←/→** if you are now on summer time, and press ENTER.
- 3 Set the day, month, year, hour, and minutes using **←/↑/↓/→**, and press ENTER to start the clock.

To change the numbers, press **←** to return to the item to be changed, and press **↑/↓**.

Input Line System

Selects the colour system when recording from the connected equipment. This setting is effective only when recording from an external input.

NTSC	Records in NTSC or PAL-60 colour system.
<u>PAL/SECAM</u>	Records in PAL or SECAM colour system.

Notes

- When picture noise appears after you change the “Input Line System” setting, change the “Input Colour System” setting (page 130). If picture noise still appears, hold down  (stop) on the recorder, and press INPUT on the recorder.
- When you change the “Input Line System” setting, the Dubbing List is erased.

Power Save

Selects whether this recorder is in power save mode when the power is turned off (standby).

Mode 1	Only aerial input signals are output to the connected TV when the recorder is in standby.
Mode 2	No input signals are output when the recorder is in standby.
<u>Off</u>	Does not set to power save mode. Normally, select this setting.

Note

Power Save mode does not function in the following cases, even when “Power Save” is set to “Mode 1” or “Mode 2.”

- There is a timer setting with “VPS / PDC” in the schedule list or Timer List.
- The SMARTLINK features are not available when “Power Save” is set to “Mode 1” or “Mode 2.”

HELP Setting

<u>On</u>	Displays Help information for GUI displays.
Off	Does not set to HELP setting mode.

EPG Type Select

Selects the EPG (Electronic Programme Guide) type to use.

The default setting varies depending on the country/region.

GUIDE Plus+	Select this to use the Gemstar GUIDE Plus+ electronic programme guide (page 61).
Guide (Digital)	Select this to use the digital electronic programme guide (page 50).

Easy Setup (Resetting the Recorder)

Select this to run the “Easy Setup” programme.



Follow the instructions for “Easy Setup” (page 30) from step 2.

Aerial Reception Settings (Digital Tuner)

You can make digital tuner and programme position settings for the recorder.

Replace Channels

Scans available digital channels, and replaces all the channels already stored in the channel list with the scanned results.

Select your country/region using  , and press ENTER.

The recorder scans available digital channels and stores them.

To cancel the scan, press SYSTEM MENU or EXIT.

If any programme positions are unused or contain unwanted channels, you can disable them (page 126).

Note







The timer settings for the replaced channels are deleted.

Add New Channels

Scans digital channels and adds found channels to the channel list.





Channel Sort

After the programme positions have been set, you can change the order of each programme position in the displayed list.

- 1 Press / to select a programme position you want to move, and press ENTER.
 - To display other pages, press / repeatedly.
- 2 Press / to select the programme position number to swap for the one selected in step 1, and press ENTER. The programme position numbers are swapped.
 - To move other programme positions, repeat from step 1.

Channel Options

You can skip or lock certain channels.

- 1 Enter your four-digit password using the number buttons, and press ENTER. To set a password, see page 138.
- 2 Select the programme position you want to skip or lock using /, and press ENTER.
- 3 Select an option, and press ENTER.
 - To skip the programme position, select .
 - To lock the programme position, select .A check mark appears in the check box next to the selected programme position.

Auto Skip

Selects whether to skip radio or data channels.

Off	No channels are skipped.
Radio	Radio channels are skipped.
Data	Data channels are skipped.
Radio & Data	Radio and data channels are skipped when selecting channels.

Signal Check

You can check the signal strength and quality of the channel.

To scan a digital channel, select a channel using **←/→**, and select “Add New Channels,” then press ENTER.

Aerial Power (RDR-HXD795/ HXD895/HXD995/HXD1095 (except models for the UK only)

Selects whether to supply the power to the aerial connected to the DIGITAL AERIAL IN jack.

On	The power is always supplied to the aerial connected to the DIGITAL AERIAL IN jack.
Auto	The power is supplied to the aerial connected to the DIGITAL AERIAL IN jack when the recorder is turned on.
Off	The power is not supplied to the aerial connected to the DIGITAL AERIAL IN jack.

Note

If the setting keeps reverting to “Off” even when “On” or “Auto” is selected or broadcast signals cannot be received properly, check the connections and try to reset the setting.

D.TV Language

Selects main and sub audio/subtitle languages or teletext language for bilingual programmes.

Aerial Reception Settings (Analog Tuner)

You can make analogue tuner and programme position settings for the recorder.

Auto Channel Setting

Auto Scan

If you connect a TV to this recorder not using SMARTLINK, you can preset programme positions automatically using “Auto Scan.”

Select your country/region using **←/→**, and press ENTER.

The programme position order will be set according to the country/region you set. If any programme positions are unused or contain unwanted channels, you can disable them (page 128).

Download from TV

If you connect a TV to this recorder with SMARTLINK, you can preset programme positions by downloading from your TV. For details, refer to the operating instructions supplied with your TV.

Select your country/region using **←/→**, and press ENTER.

The tuner preset data will be downloaded from your TV to this recorder.

If any programme positions are unused or contain unwanted channels, you can disable them (page 128).

Manual CH Setting

Presets programme positions manually. If some programme positions could not be set using the "Easy Setup" function, you can set them manually.

If there is no sound or if the picture is distorted, the wrong tuner system may have been preset during "Easy Setup." Set the correct tuner system manually in the steps below.

- 1 Select your country/region using \leftarrow/\rightarrow , and press ENTER.

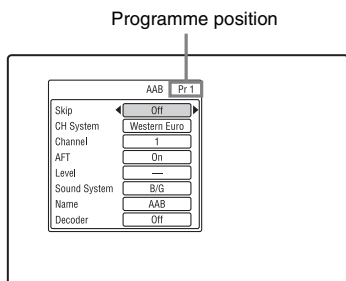

- 2 Press PROG +/- to select the programme position.
- 3 Select the item you want to change using \uparrow/\downarrow , and change the settings using \leftarrow/\rightarrow , then press ENTER.
 - To preset another programme position, repeat from step 2.

Skip

On	Select this when the programme position is unused or contains unwanted programme positions. The selected position will be skipped when you press PROG +/-.
Off	Does not skip the selected programme position.

CH System

Select the region to get the best broadcast reception.

FR	Select this when in France.
Western Euro	Select this when in West European countries.
UK & IE	Select this when in Great Britain/Ireland.
Eastern Euro	Select this when in East European countries.

Channel

Press \leftarrow/\rightarrow repeatedly until the programme position you want is displayed.

- To select a cable or satellite programme position, press \leftarrow/\rightarrow until the programme position you want is displayed.

◆ Receivable channels

TV system	Channel coverage
BG (West European Countries, except those listed below)	E2 – E12 VHF
	Italian A – H VHF
	E21 – E69 UHF
	S1 – S20 CATV
	S21 – S41 HYPER
DK (East European Countries)	S01 – S05 CATV
	R1 – R12 VHF
	R21 – R69 UHF
	S1 – S20 CATV
	S21 – S41 HYPER
I (Great Britain/Ireland)	S01 – S05 CATV
	Ireland A – J VHF
	South Africa 4 – 11, 13 VHF
	B21 – B69 UHF
	S1 – S20 CATV
L* (France)	S21 – S41 HYPER
	S01 – S05 CATV
	F2 – F10 VHF
	F21 – F69 UHF
	B – Q CATV
	S21 – S41 HYPER

* To receive broadcasts in France, select "L."

◆ Tuning the French CATV channels

This recorder can scan the CATV channels B to Q and the HYPER frequency channels S21 to S41. On the Channel Set menu, the channels are indicated as CC1 to CC44. For example, channel B is indicated by Channel Set number CC1, and channel Q is indicated by Channel Set number CC23 (see the table below). If the CATV channel you want to preset is indicated by its frequency (for example, 152.75 MHz), refer to the table below to find the corresponding channel number.

Corresponding channel	Channel Set number	Receivable Frequency range (MHz)
B	CC1	116.75–124.75
C	CC2	124.75–132.75
D	CC3	132.75–140.75
D	CC4	140.75–148.75
E	CC5	148.75–156.75
F	CC6	156.75–164.75
F	CC7	164.75–172.75
G	CC8	172.75–180.75
H	CC9	180.75–188.75
H	CC10	188.75–196.75
I	CC11	196.75–204.75
J	CC12	204.75–212.75
J	CC13	212.75–220.75
K	CC14	220.75–228.75
L	CC15	228.75–236.75
L	CC16	236.75–244.75
M	CC17	244.75–252.75
N	CC18	252.75–260.75
N	CC19	260.75–268.75
O	CC20	268.75–276.75
P	CC21	276.75–284.75
P	CC22	284.75–292.75
Q	CC23	292.75–300.75
S21	CC24	299.25–307.25
S22	CC25	307.25–315.25
S23	CC26	315.25–323.25
S24	CC27	323.25–331.25

Corresponding channel	Channel Set number	Receivable Frequency range (MHz)
S25	CC28	331.25–339.25
S26	CC29	339.25–347.25
S27	CC30	347.25–355.25
S28	CC31	355.25–363.25
S29	CC32	363.25–371.25
S30	CC33	371.25–379.25
S31	CC34	379.25–387.25
S32	CC35	387.25–395.25
S33	CC36	395.25–403.25
S34	CC37	403.25–411.25
S35	CC38	411.25–419.25
S36	CC39	419.25–427.25
S37	CC40	427.25–435.25
S38	CC41	435.25–443.25
S39	CC42	443.25–451.25
S40	CC43	451.25–459.25
S41	CC44	459.25–467.25

AFT

On	Turns on the Auto Fine Tuning function. Normally select this position.
Off	Allows you to adjust the picture manually.

- If the Auto Fine Tuning function does not work effectively, select “Off” and press **↓**. Press **←/→** to obtain a clearer picture, and press **ENTER**.

Sound System

Select an available TV system (page 128).

B/G	Select this when in West European countries, except those listed in “Receivable channels” on page 128.
D/K	Select this when in East European countries.
I	Select this when in Great Britain/Ireland.
L	Select this when in France.

Name

Changes or enters a new station name (up to 5 characters). The recorder must receive programme position information (e.g., SMARTLINK information) for station names to appear automatically.

Press **→**, then press **←/→** repeatedly to select a character.

To change the characters, press **↑/↓** to move the cursor, and press **←/→**.

Decoder

Sets the external decoder (PAY-TV/Canal Plus analogue decoder) channels.

For details, see page 37.

Channel Swapping

After the programme positions have been set, you can change the order of each programme position in the display list.

1 Press **↑/↓** to select the programme position number you want to swap, and press **→**.

- To display other pages, press **◀◀/▶▶** repeatedly.

2 Press **↑/↓** to select the programme position number to swap for the one selected in step 1, and press **ENTER**. The programme position numbers are swapped.

- To swap the programme position number of another station, repeat from step 1.

Video Settings (Video In/Out)

You can adjust items related to the image, such as size and colour, according to the type of TV, tuner, or decoder connected to the recorder.

Input Colour System

Selects the colour system when picture noise appears after you change the “Input Line System” setting (page 125).

Auto	Recorder automatically detects signals of colour systems and selects the appropriate colour system.
PAL	Selects the PAL colour system when “Input Line System” is set to “PAL/SECAM.”
SECAM	Selects the SECAM colour system when “Input Line System” is set to “PAL/SECAM.”

Hint

When “Input Line System” is set to “NTSC,” you can select “Auto,” “3.58NTSC,” or “PAL-60.”

Note

“Input Colour System” cannot be set when viewing digital broadcasts.

Component Video Out

Selects the signal format in which the recorder outputs video signals: interlace or progressive, from the COMPONENT VIDEO OUT jacks.

Normal(Interlace)	Outputs signals in the interlace format.
Progressive	Outputs signals in the progressive format. Select this when you want to view progressive signals.

🔌 Notes

- When you set “LINE 3 Out” to “RGB,” you cannot set “Component Video Out.”
- When you connect the recorder to a monitor or projector via only the COMPONENT VIDEO OUT jacks, do not set “LINE 3 Out” to “RGB.” If you set “LINE 3 Out” to “RGB,” in this case, the picture may not appear.
- When picture noise appears after you set the recorder to progressive format, hold down **■** (stop) on the recorder, and press **▲** (open/close) on the recorder.
- No video signals are output when using the HDMI connection.

LINE 3 Out

Selects a method of outputting video signals for the LINE 3 – TV jack.

<u>Video</u>	Outputs video signals.
S-Video	Outputs S-video signals.
RGB	Outputs RGB signals.

🔌 Notes

- If your TV does not accept S-video or RGB signals, the image will not be displayed in the selected method on the TV screen even if you select “S-Video” or “RGB.” Refer to the instructions supplied with your TV.
- SMARTLINK is available only when “Video” is selected.
- RGB signals are not output when using the HDMI connection.

LINE 1 In

Selects a method of inputting video signals for the LINE 1/DECODER jack. The picture will not be clear if this setting does not match the type of video input signal.

<u>Video</u>	Inputs video signals.
S-Video	Inputs S-video signals.
RGB	Inputs RGB signals.
Decoder	Select this when connecting to an external decoder (PAY-TV/Canal Plus analogue decoder). If you connect to a cable box/satellite receiver such as CanalSat, do not select this option.

NTSC on PAL TV

Sets the recorder to convert signals of the NTSC colour system to the PAL colour system to play NTSC discs on PAL-only TVs. Refer to the operating instructions supplied with your TV.

On	Plays NTSC discs on PAL-only TVs.
<u>Off</u>	Select this if the connected TV is a multi-system (NTSC-compatible) TV.

Audio Input Settings (Audio In)

You can adjust the sound according to the playback and connection conditions.

NICAM Select

For details on NICAM system, see page 70.

<u>NICAM</u>	Normally select this position.
Standard	Select this if the sound from NICAM broadcasts is not clear.

Analog Tuner Level

If the playback sound is distorted, set this item to "Compression." The recorder reduces the audio output level.

This function affects the output of the following jacks:

- LINE 2 OUT R-AUDIO-L jacks
- LINE 3 - TV jack
- LINE 1/DECODER jack

<u>Normal</u>	Normally select this position.
Compression	Select this when the playback sound from the speakers is distorted.

External Audio

<u>Stereo</u>	Select this when receiving stereo programmes from connected equipment.
Bilingual	Select this when receiving bilingual programmes from connected equipment.

Note

When receiving audio input signals from the DV input jack, the recorder automatically selects "Stereo" or "Bilingual" regardless of the "External Audio" setting.

Bilingual Recording

Selects the sound to be recorded.

<u>A/L</u>	Records the main sound for the bilingual programme.
B/R	Records the sub sound for the bilingual programme.

Notes

- When recording a bilingual audio signal to the HDD (when "HDD Recording Format" is set to "Video Mode Off" (page 137) (except in PCM mode)) or a DVD-RW/DVD-R in VR mode (except in PCM mode), both audio channels are recorded and you can select the sound when playing.
- Bilingual audio streams cannot be recorded simultaneously from digital broadcasts.

DV Input

Select the setting for the audio input when DV camcorder dubbing.

Select "Mix (Stereo 1: 75 %)" / "Mix (Stereo 1: 50 %)" / "Mix (Stereo 1: 25 %)" or "Stereo 2" only if you have added a second audio when recording with your digital video camera.

<u>Stereo 1</u>	Records original sound only. Normally select this when dubbing a DV format tape.
Stereo 2	Records additional audio only.
Mix (Stereo 1: 75 %)	Records both stereo 1 and 2.
Mix (Stereo 1: 50 %)	
Mix (Stereo 1: 25 %)	

Audio Output Settings (Audio Out)

You can switch the method of outputting audio signals when you connect a component such as an amplifier (receiver) with a digital input jack.

Note

If you connect a component that does not accept the selected audio signal, a loud noise (or no sound) will come from the speakers, and may affect your ears or cause speaker damage.

Dolby Digital Output (HDD/DVDs only)

Selects the type of Dolby Digital signal.

Dolby Digital	Select this when the recorder is connected to an audio component with a built-in Dolby Digital decoder.
Dolby Digital -> PCM	Select this when the recorder is connected to an audio component lacking a built-in Dolby Digital decoder.

Note

If the HDMI OUT jack is connected to equipment not compatible with Dolby Digital signals, the PCM signals will be automatically output even when you select "Dolby Digital."

DTS Output (DVD VIDEOS only)

Selects whether or not to output DTS signals.

On	Select this when the recorder is connected to an audio component with a built-in DTS decoder.
Off	Select this when the recorder is connected to an audio component without a built-in DTS decoder.

Note

When HDMI output is performed to equipment not compatible with DTS signals, the signals will not be output regardless of the "DTS Output" setting.

96 kHz PCM Output (DVD VIDEOS only)

Selects the sampling frequency of the audio signal.

<u>96 kHz -> 48 kHz</u>	The audio signals of DVD VIDEOS are converted to 48 kHz and output.
96 kHz	All signals containing 96 kHz are output without conversion. However, the signals are output at 48 kHz if copyright-protected signals are contained.

Notes

- "96 kHz PCM Output" setting has no effect when audio signals are output from the LINE 2 OUT (R-AUDIO-L) jacks or LINE 3 - TV/LINE 1/DECODER jack. If the sampling frequency is 96 kHz, signals are simply converted to analogue signals and output.
- If the HDMI OUT jack is connected to equipment not compatible with 96 kHz signals, 48 kHz PCM will be automatically output even when you select "96 kHz."

MPEG Output (DVD VIDEOS only)

Selects the type of MPEG audio signal.

MPEG	Select this when the recorder is connected to an audio component with a built-in MPEG decoder.
<u>MPEG -> PCM</u>	Select this when the recorder is connected to an audio component without a built-in MPEG decoder. If you play MPEG audio sound tracks, the recorder outputs stereo signals via the DIGITAL OUT (COAXIAL) jack.

Note

If the HDMI OUT jack is connected to equipment not compatible with MPEG audio signals, the PCM signals will be automatically output even when you select “MPEG.”

Audio DRC (Dynamic Range Control) (DVDs only)

Selects the dynamic range (difference between soft and loud sounds) setting when playing a DVD that conforms to “Audio DRC.” This affects the output from the following jacks:

- LINE 2 OUT R-AUDIO-L jacks
- LINE 3 – TV jack
- LINE 1/DECODER jack
- DIGITAL OUT (COAXIAL)/HDMI OUT jack only when “Dolby Digital Output” is set to “Dolby Digital -> PCM” (page 133).

On	Makes low sounds clear even if you turn the volume down.
<u>Off</u>	Normally select this position.

Language Settings (Language)

You can make language settings.

OSD Language

Switches the display language on the screen.

Audio Language (DVD VIDEO only)

Switches the language of the sound track.

Subtitle Language (DVD VIDEO only)

Switches the language of the subtitles recorded on the disc.

Auto Language

The “Auto Language” function is available when “Audio Language” and “Subtitle Language” are set to the same language, and “Subtitle Display” is set to “On.”

<u>On</u>	For DVD VIDEOS whose main audio track is the language you set in “Audio Language” and “Subtitle Language,” the recorder plays the main audio track without subtitles. For DVD VIDEOS whose main audio track is not the language you set in “Audio Language” and “Subtitle Language,” the recorder plays the main audio track with subtitles in the language you set.
Off	Turns off the function.

DVD Menu Language (DVD VIDEO only)

Switches the language for the DVD menu. Select “w/Subtitle Language” to set the same language as the language you set in “Subtitle Language.”

Subtitle Display

<u>On</u>	Displays subtitles.
Off	Does not display subtitles.
Assist Subtitle	Displays special assistive subtitles, where available.

Hint

If you select “Others” in “Audio Language,” “Subtitle Language,” or “DVD Menu Language,” press **↓**, and enter a language code from “Language Code List” on page 158.

Note

If you select a language in “DVD Menu Language,” “Subtitle Language,” or “Audio Language” that is not recorded on the DVD VIDEO, one of the recorded languages will be automatically selected.

Recording Settings (Recording)

You can adjust recording settings.

Manual Rec. Mode

You can select further options for recording mode (manual recording mode). The default setting is “Off” (standard recording mode). You can check the approximate recording times for the HDD and the different DVD types in each recording mode on page 155.

- 1 Select “On (go to setup)” using **↑/↓**, and press ENTER.
- 2 Select a recording mode using **←/→**, and press ENTER.

To easily select a manual recording mode, press REC MODE repeatedly to display “MN,” and select a manual recording mode using **←/→**.

Rec. Mode Adjust

On	Automatically adjusts the recording mode to enable the entire programme to be recorded (page 68).
<u>Off</u>	Turns off the function.

Subtitle Recording

On	Records digital broadcast subtitles.
<u>Off</u>	No digital broadcast subtitles are recorded.

Set Thumbnail

Selects a scene for the thumbnail picture shown in the Title List.

<u>0 seconds</u>	The first frame of the title is set for the thumbnail picture.
30 seconds	The frame at 30 seconds from the first frame is set for the thumbnail picture.
3 minutes	The frame at 3 minutes from the first frame is set for the thumbnail picture.

Auto Chapter (HDD/VR) (HDD/DVD-RW/DVD-R in VR mode only)

<u>On</u>	The recorder detects changes in the picture and sound and automatically inserts chapter marks (up to 99 chapters for one title recorded on the HDD).
Off	No chapter mark is inserted.

Notes

- The actual chapter mark interval may vary depending on the amount of information contained in the video to be recorded.
- Chapter marks are automatically inserted, where the date or time information changes on the tape, when "Auto Chapter (HDD/VR)" is set to "On" during DV dubbing to the HDD or a DVD-RW/DVD-R (VR mode).

Auto Chapter (Video) (DVD-RW/DVD-R in Video mode only)

No Separation	No chapter mark is inserted.
<u>10 minutes</u>	Inserts chapter marks at approximately 10-minute intervals.
15 minutes	Inserts chapter marks at approximately 15-minute intervals.

Auto Chapter (DVD+R/+RW) (DVD+RW/DVD+R only)

No Separation	No chapter mark is inserted.
<u>10 minutes</u>	Inserts chapter marks at approximately 10-minute intervals.
15 minutes	Inserts chapter marks at approximately 15-minute intervals.

HDD Recording Format

Selects the HDD recording format.

Video Mode Off	Records to the HDD in VR mode. When recording stereo and bilingual programmes, both main and sub sounds can be recorded.
Video Mode On	Records to the HDD in Video mode. When recording stereo and bilingual programmes, only one sound track (main or sub) can be recorded. Set "Bilingual Recording" to "A/L" (default) or "B/R" in the "Audio In" setup (page 132).

Hint

The HDD contents recorded in Video mode can be dubbed to a disc at high speed (page 89).

Note

Bilingual audio streams cannot be recorded simultaneously from digital broadcasts.

Playback Settings (Playback)

You can adjust playback settings.

TV Type

Select the playback picture size according to the type of connected TV (widescreen/wide mode TV or conventional 4:3 screen TV).

4:3 Letter Box	Select this when connecting to a 4:3 screen TV. Displays a wide picture with bands on the upper and lower portions of the screen.
4:3 Pan Scan	Select this when connecting to a 4:3 screen TV. Automatically displays a wide picture on the entire screen and cuts off the portions that do not fit.
16:9	Select this when connecting to a widescreen TV or TV with a wide mode function.

4:3 Letter Box



4:3 Pan Scan

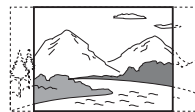

16:9



Note

Depending on the disc, "4:3 Letter Box" may be selected automatically instead of "4:3 Pan Scan" or vice-versa.

Pause Mode

Selects the picture quality in pause mode.

Field	Outputs a stable, generally shake-free image.
Frame	Outputs a sharp image, but may be prone to shake.
<u>Auto</u>	Outputs a generally less sharp but more stable still image.

Seamless Playback (HDD/DVD-RW/DVD-R in VR mode only)

On	Playback is smooth, but with a trade-off against the accuracy of the edit points.
<u>Off</u>	You may notice momentary interruption at edited points during playback of a VR mode Playlist.

Angle Indicator (DVD VIDEOS only)

<u>On</u>	Displays “  <h2>Limitation Settings (Parental Lock)</h2>
-----------	--

You can set the password and limit the operations.

Set Password/Change Password

You can set or change password that gives access to the “Channel Options” settings in the “Digital Tuner” setup and the “Parental Lock” settings.

Enter your four-digit password using the number buttons, and press ENTER.

To change the password, enter your four-digit password in the “Current Password” row using the number buttons, and press ENTER. Then enter a new password in the “New Password” row using the number buttons.

The password setting/password changing setting is completed.

Note

If you forgot your password, reset the recorder (page 150).

DVD Playback (DVD VIDEO only)

Playback of some DVD VIDEOS can be limited according to a predetermined level, such as the age of the users. Scenes may be blocked or replaced with different scenes.

- 1 Select “Standard,” and press ENTER.

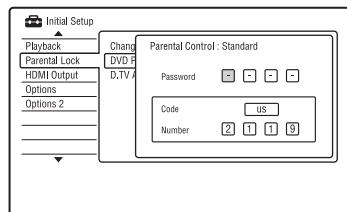

- 2 Enter your four-digit password using the number buttons, and press ENTER.

- 3 Select "Code" (geographic area) as the playback limitation level, and press ENTER.
The area is selected.
 - When you select "Number," press the number buttons to select and enter a country/area code in the table (page 158), and press ENTER.
- 4 Select "Change Level," and press ENTER.
- 5 Enter your four-digit password using the number buttons, and press ENTER.
- 6 Select the level.
The lower the value, the stricter the limitation.
Discs rated higher than the selected level will be restricted.
- 7 Press ENTER.
The DVD Playback setting is completed.
To cancel the DVD Playback setting for the disc, select "Off" in step 6.

D.TV Age Limit

Viewing of some digital TV programmes can be limited according to the age limit you set. To watch programmes that exceed the age limit you set, your password is required. When recording a locked programme, the "D.TV Age Limit" setting is automatically cancelled and the programme can be viewed. In addition, you can watch the recorded title without having to enter a password. (for customers in France/Denmark/Finland, or Sweden only)

- 1 Enter your four-digit password using the number buttons, and press ENTER.
- 2 Select an age as limitation level, and press ENTER.
The setting is completed.
To cancel the setting, select "Off."

HDMI Settings (HDMI Output)

You can adjust items related to the HDMI connection.

Note

You can select "HDMI Output" only when connecting equipment to the HDMI OUT jack.

Screen Resolution

Selects the type of video signals output from the HDMI OUT jack. If the picture is not clear, natural or to your satisfaction, try another option that suits the disc and your TV/projector, etc. For details, refer also to the instruction manual supplied with the TV/projector, etc.

1920 x 1080p	Sends 1920x1080p video signals.
1920 x 1080i	Sends 1920x1080i video signals.
1280 x 720p	Sends 1280x720p video signals.
720 x 576p ^{*1}	Sends 720x576p video signals.
720 x 480p ^{*2}	Sends 720x480p video signals.
720 x 576i ^{*1}	Sends 720x576i video signals.
720 x 480i ^{*2}	Sends 720x480i video signals.

^{*1} Can be selected only when "Input Line System" is set to "PAL/SECAM" in the "Basic" setup (page 125).

^{*2} Can be selected only when "Input Line System" is set to "NTSC" in the "Basic" setup (page 125).

Notes

- When picture noise appears after you change the “Screen Resolution” setting, hold down **■** (stop) on the recorder, and press **▲** (open/close) on the recorder.
- When “Colour” is set to “YCbCr 4:2:2” in the “HDMI Output” setup, you cannot select “720 x 576i” (or “720 x 480i”).

4:3 Video Output

This setting is effective only when you set “TV Type” to “16:9” in the “Playback” setup.

Adjust this setting to watch 4:3 aspect ratio signals. If you can change the aspect ratio on your TV, change the setting on your TV, not this recorder.

Note that this setting is effective only for HDMI connection.

Full	Select this when you can change the aspect ratio on your TV.
Normal	Select this when you cannot change the aspect ratio on your TV. Shows a 4:3 size video with the aspect ratio as it is.

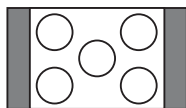

16:9 aspect ratio TV

Colour

Selects the method of outputting video signals for the HDMI jack.

RGB (0-255)	Outputs RGB (0-255) signals. Select this when connecting to an RGB (0-255) device.
RGB (16-235)	Outputs RGB (16-235) signals. Select this if colours appear overly rich and the black appears too deep.

YCbCr 4:2:2	Outputs 10-bit YCbCr 4:2:2 component signals.
YCbCr 4:4:4	Outputs 8-bit YCbCr 4:4:4 component signals.

Notes

- Some settings may not be available depending on the connected device.
- When a DVI device is connected, you cannot select “YCbCr 4:2:2” or “YCbCr 4:4:4.”
- When “Screen Resolution” is set to “720 x 576i” (or “720 x 480i”) in the “HDMI Output” setup, you cannot select “YCbCr 4:2:2.”

Audio Output

Selects the type of audio signal output from the HDMI OUT jack.

Auto	Outputs Dolby Digital, MPEG and DTS audio signals as a bitstream signal. Normally select this position.
PCM	Converts all audio signals except for DTS signals to PCM.
Bitstream Priority	Select this if the connected device is compatible with bitstream audio.

Notes

- The PCM signals may not be output even when you select “Auto” depending on the “Audio Out” settings, number of audio channels, and the HDMI-connected device.
- The “Audio Output” function is not available when a DVI device is connected.

Control for HDMI

On	Allows you to use the “Control for HDMI” function (page 24).
Off	Turns off the function.

Other Settings (Options)

You can make other operation settings.

On Screen Display

On	Automatically displays information on the screen when the recorder is turned on, etc.
Off	Displays information only when DISPLAY is pressed.

Front Panel Display

Adjusts the lighting of the front panel display.

On	Bright lighting.
Off	Turns off the lighting and saves power consumption when the power is off.

Command Mode

Changes the Command Mode of the recorder to avoid interference with your other Sony DVD recorder or player.

- 1 Select a Command Mode (“1,” “2,” or “3 (Default setting)”), and press ENTER.

Note

The default command mode setting for this recorder and the supplied remote is “3 (Default setting).”

The remote does not function if different command modes are set for the recorder and remote. Set the same command mode.

- 2 Set the Command Mode for the remote so it matches the Command Mode for the recorder you set above. Follow the steps below to set the Command Mode on the remote.
 - ① Hold down ENTER.
 - ② While holding down ENTER, enter the Command Mode code number using the number buttons.
 - ③ Hold down both the number and ENTER buttons at the same time for more than three seconds.

Hint

You can check the Command Mode for the recorder in the front panel display (page 15). When the Command Mode is set to “3 (Default setting),” “1” or “2” does not appear.

SMARTLINK

This Recorder Only	Allows you to use the SMARTLINK function with the recorder when the recorder is in standby mode.
Pass Through	Allows you to use the SMARTLINK function with the connected equipment when the recorder is in standby mode.

Note

Set “Power Save” to “Off” in the “Basic” setup (page 125) to set “SMARTLINK” to “Pass Through.”

DivX

Registration Code

Displays the registration code of DivX video files for this recorder.

For more information, go to <http://www.divx.com/vod> on the Internet.

Set Preview (HDD only)

Selects the thumbnail type shown in the Title List.

<u>Quick Preview</u>	Plays short excerpts from throughout the selected title.
Normal	Plays the selected title from the beginning.

CI Information (RDR-HXD795/HXD895/HXD995/HXD1095 only)

You can see the CI information. The displayed information differs depending on the CI module.

Software Update

You can check the current software version of the built-in digital tuner and keep it up to date with the latest software.

Manual Update

Updates the software manually.

To cancel, press SYSTEM MENU.

The new software will be available next time the recorder is turned on.

Auto Update

<u>On</u>	Updates the software automatically. Normally, select this position.
Off	Does not update the software automatically.

Technical Info.

You can check the current hardware and software versions of the digital tuner.

Other Settings (Options 2)

You can make other operation settings.

USB

Restart USB Device

Restarts the connected USB device if it does not respond to the recorder. If the connected USB device still does not work properly, try following:

- Turn the connected USB device off and on again.
- Disconnect and then connect the USB cable.

Confirm Printer

Displays the manufacturer and model name of the printer connected to the recorder. Note that this function may not work depending on the printer.

TV Pause

Selects the tuner for the TV Pause (page 79).

TV's Tuner	Selects this when connecting the recorder to your TV using the SCART jack.
<u>Recorder's Tuner</u>	Selects this when connecting the recorder to your TV not using the SCART jack.

Additional Information

Troubleshooting

If you experience any of the following difficulties while using the recorder, use this troubleshooting guide to help remedy the problem before requesting repairs. Should any problem persist, consult your nearest Sony dealer.

Power

The power does not turn on.

- ➔ Check that the mains lead is connected securely.

The power of the recorder turns off at the same time as the TV is turned off.

- ➔ This is caused by the 'BRAVIA' Sync features. Set "Control for HDMI" to "Off" in the "HDMI Output" setup to cancel this function (page 140).

Tuner

The channel is not found or stored or missed.

- ➔ Make sure that your aerial is properly connected to the recorder.
- ➔ Confirm with your dealer that you are in an area that can receive a digital signal.
- ➔ Check your aerial installation.

Picture

There is no picture.

- ➔ Re-connect all connecting cords securely.
- ➔ The connecting cords are damaged.
- ➔ Check the connection to your TV (page 18).
- ➔ Switch the input selector on your TV (such as to "VCR" and "AV 1") so that the signal from the recorder appears on the TV screen.
- ➔ Check that the "Video In/Out" setup is set to the appropriate item that conforms to your system (page 130).

- ➔ If you connect the recorder to your TV via only the COMPONENT VIDEO OUT jacks, set "Component Video Out" in the "Video In/Out" setup to "Progressive" (page 130).
- ➔ (For RDR-HXD790/HXD890/HXD990/HXD1090) A scrambled channel is selected.
- ➔ (For RDR-HXD795/HXD895/HXD995/HXD1095) A scrambled channel is selected. Insert the proper CAM (page 26).
- ➔ A HD (High Definition) programme is selected.
- ➔ A radio channel is selected.
- ➔ When playing a double-layer DVD, the video and audio may be momentarily interrupted at the point where the layers switch.

Picture noise appears.

- ➔ If the picture output signal from your recorder passes through your VCR to get to your TV, or if you are connected to a combination TV/VIDEO player, the copy-protection signal applied to some DVD programmes could affect picture quality. If you still experience this problem even when you connect your recorder directly to your TV, try connecting your recorder to your TV's S VIDEO input.
- ➔ You have set the recorder to progressive format even though your TV cannot accept the progressive signal. In this case, hold down ■ (stop) on the recorder, and press ▲ (open/close) on the recorder.
- ➔ Even if your TV is compatible with progressive format (525p/625p) signals, the image may be affected when you set the recorder to progressive format. In this case, hold down ■ (stop) on the recorder, and press ▲ (open/close) on the unit and the recorder is set to normal (interlace) format.
- ➔ You are playing a title recorded in a colour system that is different from your TV.
- ➔ Noise may appear in the pictures recorded on the HDD, which is due to the characteristics of HDD, and is not a malfunction.
- ➔ When playing a double-layer DVD, the video and audio may be momentarily interrupted at the point where the layers switch.

There is no picture or picture noise appears when connected to the DV IN jack.

- ➔ Try the following: ①Turn the recorder off and on again. ②Turn the connected equipment off and on again. ③Disconnect and then connect the i.LINK cable again.

There is no picture or picture noise appears when connected to the HDMI OUT jack.

- ➔ Try the following: ①Turn the recorder off and on again. ②Turn the connected equipment off and on again. ③Disconnect and then connect the HDMI cord again.
- ➔ If the HDMI OUT jack is used for video output, changing the “Screen Resolution” setting in the “HDMI Output” setup may solve the problem (page 139). Connect the TV and the recorder using a video jack other than HDMI OUT, and switch the TV’s input to the connected video input so that you can see the on-screen displays. Change the “Screen Resolution” setting in the “HDMI Output” setup, and switch the TV’s input back to HDMI. If the picture still does not appear, repeat the steps and try other options.
- ➔ The recorder is connected to an input device that is not HDCP compliant (page 22).
- ➔ When picture noise appears after you change the “Screen Resolution” setting, hold down ■ (stop) on the recorder, and press ▲ (open/close) on the recorder.

TV programme reception does not fill the screen.

- ➔ Set the channel manually in “Manual CH Setting” in the “Analog Tuner” setup (page 128).
- ➔ Select the correct source using the INPUT button, or select a channel of any TV programme using the PROG +/- buttons.

The picture is breaking up.

- ➔ The signal strength is low.
- ➔ Check aerial installation.

TV programme pictures are distorted.

- ➔ Reorient the TV aerial.
- ➔ Adjust the picture (refer to the TV’s instruction manual).

- ➔ Place the recorder and TV farther apart.
- ➔ Place the TV and any bunched aerial cables farther apart.
- ➔ The aerial cable is connected to the AERIAL OUT jack on the recorder. Connect the cable to the AERIAL IN jack.
- ➔ The recorder’s colour system is different from your TV. Hold down ■ (stop) on the recorder, and press INPUT on the recorder to change the recorder’s colour system.

TV channels cannot be changed.

- ➔ A timer recording started, which changed the channels.
- ➔ The channel is skipped (page 128).
- ➔ The Parental Lock is activated (page 138).

The picture from equipment connected to the recorder’s input jack does not appear on the screen.

- ➔ If the equipment is connected to the LINE 1/DECODER jack, select “L1” in the front panel display by pressing INPUT. If the equipment is connected to the LINE 2 IN jacks, select “L2” in the front panel display by pressing INPUT.

The playback picture or TV programme from the equipment connected through the recorder is distorted.

- ➔ If the playback picture output from a DVD player, VCR, or tuner goes through your recorder before reaching your TV, the copy-protection signal applied to some programmes could affect picture quality. Disconnect the playback equipment in question and connect it directly to your TV.

The picture does not fill the screen.

- ➔ Set “TV Type” in the “Playback” setup in accordance with the screen size of your TV (page 137).

The picture does not fill the screen, even though the picture size is set in “TV Type” in the “Playback” setup.

- ➔ The picture size of the title is fixed.

The picture is black and white.

- ➔ Check that “LINE 3 Out” in the “Video In/Out” setup is set to the appropriate item that conforms to your system (page 131).
- ➔ If you are using a SCART cord, be sure to use one that is fully wired (21 pins).

GUIDE Plus+ system (in areas with GUIDE Plus+ only)

GUIDE Plus+ system does not appear.

- ➔ ①Even if you complete “Easy Setup,” TV programme listings do not appear until the recorder receives the GUIDE Plus+ data.
- ➔ ②Turn off the recorder, but do not unplug it.
- ➔ ③Wait for 24 hours. It may take several days for the recorder to receive the GUIDE Plus+ data for all programme positions. If the recorder does not receive the GUIDE Plus+ data after 24 hours, set the host channel manually (page 64).
- ➔ The host channel is disabled. Show and enable the host channel (page 65).
- ➔ The timer is set. Cancel the timer setting.
- ➔ The clock is incorrect. Set the clock manually (page 124).
- ➔ The country/region or postal code is incorrect. Correctly set your country/region and postal code (page 30).
- ➔ When the recorder is connected to a set top box receiver, the set top box receiver must be turned on to download the GUIDE Plus+ data.
- ➔ If the set top box receiver is connected to the recorder using a SCART cord only, try the following: ①Turn on your set top box receiver. ②Connect the set top box controller. ③Follow the steps in “Changing the GUIDE Plus+ host channel manually (Setup)” (page 64) to set the host channel manually. Be sure to set your set top box receiver (tuner) as the source.
- ➔ Area numbers that cannot be received using GUIDE Plus+ are set. Select “Easy Setup” in the “Basic” setup from “Initial Setup” in the System Menu, and follow the on-screen instructions to make the settings again (page 30).
- ➔ The “Time Lock” function on your cable box is activated. Set this function to off.

- ➔ If the host channel has changed or moved, the programme guide data cannot be received. In this case, follow the steps in “Searching for the GUIDE Plus+ host channel (Setup)” (page 64) to update the host channel setting. If the problem persists after waiting for one day, search for the host channel at the following website and set the host channel manually (page 64).
www.europe.guideplus.com

The programme position number in the programme listing does not match the broadcast station.

- ➔ There may be more than one channel lineup for your area. To change the channel lineup, select “Editor” in the Menu Bar of the GUIDE Plus+ system (page 65).

Programme listings for some programme positions are missing.

- ➔ The programme guide data may not be updated. Turn off the recorder and let the recorder receive the programme guide data.
- ➔ Some broadcast stations support only two days of data. For details, refer to the following website:
www.europe.guideplus.com
- ➔ All of the GUIDE Plus+ data could not be received because the reception is poor.

The programme listing is not up to date.

- ➔ The recorder was in use during the time that the GUIDE Plus+ data was scheduled to be downloaded.
- ➔ All of the GUIDE Plus+ data could not be received because the reception is poor.

Sound

There is no sound.

- ➔ Re-connect all connections securely.
- ➔ The connecting cord is damaged.
- ➔ The input source setting on the audio component or the connection to the audio component is incorrect.
- ➔ The recorder is in reverse play, fast-forward, slow motion, or pause mode.

- ➔ If the audio signal does not come through the DIGITAL OUT (COAXIAL)/HDMI OUT jacks, check the “Audio Out” setup (page 133).
- ➔ The recorder supports only MP3 audio, Dolby Digital and MPEG audio for DivX video files. Press AUDIO and select MP3 audio or MPEG audio.

No sound is output from the HDMI OUT jack.

- ➔ Try the following: ①Turn the recorder off and on again. ②Turn the connected equipment off and on again. ③Disconnect and then connect the HDMI cord again.
- ➔ The HDMI OUT jack is connected to a DVI device (DVI jacks do not accept audio signals).
- ➔ The equipment connected to the HDMI OUT jack does not conform to the audio signal format. In this case, set “Audio Output” to “PCM” in the “HDMI Output” setup (page 140).

Sound distortion occurs.

- ➔ Set “Analog Tuner Level” in the “Audio In” setup to “Compression” (page 132).

Sound is noisy.

- ➔ When playing a CD with DTS sound tracks, noise will come from the LINE 2 OUT R-AUDIO-L jacks, LINE 3 – TV jack, or LINE 1/DECODER jack (page 76).

The sound volume is low.

- ➔ The sound volume is low on some DVDs. The sound volume may improve if you set “Audio DRC” in the “Audio Out” setup to “On” (page 134).
- ➔ Set “Analog Tuner Level” in the “Audio In” setup to “Normal” (page 132).

An alternate audio track cannot be recorded or played.

- ➔ When recording from connected equipment, set “External Audio” to “Bilingual” in the “Audio In” setup (page 132).

- ➔ Multilingual tracks (main and sub) cannot be recorded on the HDD (when Video Mode On), DVD+RWs, DVD-RWs (Video mode), DVD+Rs, or DVD-Rs (Video mode). To record the language, set “Bilingual Recording” in the “Audio In” setup to “A/L” or “B/R” before recording (page 132). To record both the main and sub sounds on a disc, record on DVD-RWs/DVD-Rs (VR mode). To record on the HDD, set “HDD Recording Format” to “Video Mode Off” in the “Recording” setup (page 137).
- ➔ If you have connected an audio component to the DIGITAL OUT (COAXIAL) jack and want to change the audio track for the HDD (when “HDD Recording Format” is set to “Video Mode Off” in the “Recording” setup (page 137))/DVD-RWs/DVD-Rs (VR mode) during playback, set “Dolby Digital Output” in the “Audio Out” setup to “Dolby Digital -> PCM” (page 133).
- ➔ Bilingual audio streams cannot be recorded simultaneously from digital broadcasts.

The sound is breaking up.

- ➔ The signal strength is low.
- ➔ Check aerial installation.

Recording/Timer recording/ Editing

The programme position cannot be changed from the programme position you are recording.

- ➔ Set the TV’s input source to “TV.”

Recording does not start immediately after you press ● REC.

- ➔ Operate the recorder only after “LOAD,” “FORMAT,” or “INFO WRITE” disappears from the front panel display.

Nothing was recorded even though you set the timer setting correctly.

- ➔ There was a power failure during recording.

- ➔ The recorder's internal clock stopped due to a power failure that lasted for more than 1 hour. Reset the clock (page 124).
- ➔ The channel was disabled after the timer recording was set. See "Manual CH Setting" on page 128.
- ➔ The programme position was hidden after the timer recording was set. (See "Disabling programme positions (Editor)" on page 65.)
- ➔ Disconnect the mains lead from the mains, and connect it again.
- ➔ The programme contains copy protection signals that restrict copying.
- ➔ Another timer setting overlapped the timer setting (page 59, 72).
- ➔ There is no DVD inside the recorder.
- ➔ There is not enough disc space for the recording.
- ➔ The set top box receiver was turned off.
- ➔ The set top box controller was incorrectly connected (page 18).
- ➔ The settings in "Setup" in the Menu bar have been changed (page 64).
- ➔ The recorder was in the process of dubbing.
- ➔ A scrambled channel is selected.

Recording does not stop immediately after you press ■ REC STOP.

- ➔ It will take a few seconds for the recorder to input disc data before recording can stop.
On-screen instructions may appear after pressing ■ REC STOP. In this case, follow the on-screen instructions.

Recording does not stop after you press ■.

- ➔ Press ■ REC STOP.

Timer recording is not complete or did not start from the beginning.

- ➔ There was a power failure during recording. If the power recovers when there is a timer recording, the recorder resumes recording.
Should the power failure continue for more than 1 hour, reset the clock (page 124).
- ➔ Another timer setting overlapped the timer setting (page 59, 72).
- ➔ Disc space was not sufficient.
- ➔ The VPS/PDC function is working.

Contents previously recorded were erased.

- ➔ Data that is not playable on this recorder but was recorded on a DVD with a PC will be erased from the disc when the disc is inserted.

The VPS/PDC function does not operate.

- ➔ Check that the clock and date are set correctly.
- ➔ Check that the VPS/PDC time you set is correct (there might be a mistake in the TV programme guide). If the broadcast you wanted to record did not send the correct VPS/PDC information, the recorder will not start recording.
- ➔ If the reception is poor, the VPS/PDC signal might be altered and the recorder might not start recording.
- ➔ The VPS/PDC function may not work if the GUIDE Plus+ host channel setup is not complete.
- ➔ The VPS/PDC function does not work when the GUIDE Plus+ data is being downloaded.

Playback

The recorder does not play any type of disc (except HDD).

- ➔ The disc is upside down. Insert the disc with the labelled side facing up.
- ➔ The disc is not correctly inserted.
- ➔ Moisture has condensed inside the recorder. In this case, if the recorder is on, leave it on (if it is off, leave it off) for about an hour until the moisture evaporates.
- ➔ If the disc was recorded on another recorder and was not finalised (page 46), the recorder cannot play the disc.

The recorder does not start playback from the beginning.

- ➔ Resume play was activated (page 74).
- ➔ You have inserted a DVD whose Title menu or DVD menu automatically appears on the TV screen when it is first inserted. Use the menu to start playback.

The recorder starts playing automatically.

- ➔ The DVD VIDEO features an auto playback function.

Playback stops automatically.

- ➔ If the DVD has an auto pause signal, the recorder stops playback at the auto pause signal.

Some functions such as Stop, Search, or Slow-motion Play cannot be performed.

- ➔ Depending on the DVD, you may not be able to do some of the operations above. Refer to the instruction manual supplied with the disc.

The language for the sound track cannot be changed.

- ➔ Multilingual tracks are not recorded on the DVD being played.
- ➔ The DVD VIDEO prohibits the changing of the language for the sound track.
- ➔ Try changing the language using the DVD VIDEO's menu.

The subtitle language cannot be changed or turned off.

- ➔ Multilingual subtitles are not recorded on the DVD VIDEO.
- ➔ The DVD VIDEO prohibits changing of the subtitles.
- ➔ Try changing the subtitle using the DVD VIDEO's menu.
- ➔ The subtitles cannot be changed for the titles recorded on this recorder.

The angles cannot be changed.

- ➔ Multi-angles are not recorded on the DVD VIDEO being played.
- ➔ You are trying to change the angles when "⏮" does not appear on the TV screen (page 75). To display "⏮" if various angles (multi-angles) for a scene are recorded on the disc, set "Angle Indicator" to "On" in the "Playback" setup (page 138).
- ➔ The DVD VIDEO prohibits changing angles.
- ➔ Try changing the angle using the DVD VIDEO's menu.

- ➔ The angles cannot be changed for the titles recorded on this recorder.
- ➔ The angles cannot be changed during slow motion playback or when playback is paused.

The DivX video files do not play.

- ➔ The file is not created in DivX format.
- ➔ The file has an extension other than ".avi" or ".divx."
- ➔ The DATA CD (DivX video)/DATA DVD (DivX video) is not created in a DivX format that conforms to ISO9660 Level 1/Level 2, Romeo, Joliet, or UDF (Universal Disk Format) 1.02, 1.50, 2.00, or 2.01.
- ➔ The DivX video file format is larger than 720 (width) × 576 (height).

The MP3 audio tracks do not play.

- ➔ The MP3 audio tracks are not recorded in a format that the recorder can play (page 160).

The JPEG image files do not play.

- ➔ The JPEG image files are not recorded in a format that the recorder can play (page 160).
- ➔ Progressive JPEG images cannot be played.

TV Pause does not work.

- ➔ You are recording to the HDD or the HDD is full.

Dubbing

You dubbed a title, but the title did not appear in the HDD Title List.

- ➔ The title contained a copy protection signal, so it was moved (page 157).

High-speed dubbing is not possible.

- ➔ The title cannot be dubbed at high speed (page 91). Even if A-B erasure is performed so that a title does not contain mixed picture sizes, it is still treated as a title with mixed picture sizes.

HDD/DVD Dubbing is not possible.

- ➔ The title cannot be dubbed (page 90).

HDD camcorder dubbing is not possible.

- ➔ An HDD camcorder which is not supported by this recorder is connected (page 94).
- ➔ The HDD camcorder is not set to the USB connection mode (page 95).
- ➔ The HDD camcorder contains only the contents that have already been dubbed to the recorder when you are dubbing using the ONE-TOUCH DUB button or “Incremental Dubbing.”

Display

The clock has stopped.

- ➔ Set the clock again (page 124).

The clock is wrong.

- ➔ Set the clock again (page 124). If you cannot set the clock, wait until the clock data is received and the clock is automatically adjusted.

The timer indicator is flashing.

- ➔ The disc does not have enough space.
- ➔ Insert a recordable disc into the recorder.
- ➔ The inserted DVD is protected (page 45).

The clock does not appear in the front panel display when the recorder is turned off.

- ➔ “Front Panel Display” is set to “Off” in the “Options” setup (page 141).

The title or station name is not correctly displayed.

- ➔ In some areas, letters or symbols that the recorder cannot record or display are replaced with “*.”

Remote control

The remote does not function.

- ➔ Different command modes are set for the recorder and remote. Set the same command mode (page 141). The default command mode setting for this recorder and the supplied remote is “**3 (Default setting)**.” You can check the current command mode in the front panel display (page 141).
- ➔ The batteries are weak.
- ➔ The remote is too far from the recorder.
- ➔ The remote’s manufacturer code returned to the default setting when you replaced the batteries. Reset the code (page 28).
- ➔ The remote is not pointed at the remote sensor on the recorder.

Others

The recorder does not detect a USB device connected to the recorder.

- ➔ Make sure that the USB device is securely connected to the recorder (page 142).
- ➔ Check if the USB device or a cable is damaged.
- ➔ Check if the USB device is on.
- ➔ The USB device is connected via a USB hub. Connect the USB device directly to the recorder.

Display language on the screen switches automatically.

- ➔ When “Control for HDMI” is set to “On” (default) in the “HDMI Output” setup (page 140), the display language on the screen automatically switches, according to the language setting of the connected TV, if you change the language settings on your TV, etc.

The ‘BRAVIA’ Sync features do not operate.

- ➔ Your TV is not compatible with the ‘BRAVIA’ Sync features.
- ➔ “Control for HDMI” is set to “Off” in the “HDMI Output” setup (page 140).
- ➔ The recorder is connected to the TV via an amplifier. Connect the recorder directly to the TV.

The recorder does not operate properly.

- ➔ Press down **I/⏻** on the recorder for more than five seconds until the recorder turns off. Then, press **I/⏻** again to turn on the recorder.
- ➔ When static electricity, etc., causes the recorder to operate abnormally, turn off the recorder and wait until the clock appears in the front panel display. Then, unplug the recorder and after leaving it off for a while, plug it in again.

The disc tray does not open after you press **▲ (open/close).**

- ➔ It may take a few seconds for the disc tray to open after you have recorded or edited a DVD. This is because the recorder is adding disc data to the disc.

Any buttons do not function and “LOCKED” appears in the front panel display.

- ➔ The recorder is locked. Cancel the Child Lock (page 14).

The disc tray does not open and “TRAYLOCKED” appears in the front panel display.

- ➔ Contact your Sony dealer or local authorized Sony service facility.

“REPAIR” appears in the front panel display.

- ➔ The recorder's repair function is activated to repair the hard disk drive or disc. Leave the recorder on until “REPAIR” disappears from the front panel display. Some data may be lost even if the repair function is activated.

“E01” appears in the front panel display.

- ➔ There is a problem in the HDD. Contact your nearest Sony dealer. Note that contents on the HDD may be erased when servicing this unit.

“E02” appears in the front panel display.

- ➔ The HDD information is incorrect. You cannot make a new recording to the HDD. Format the HDD following the instructions of “Format HDD.” (page 124). Note that all of the recorded contents on the HDD will be erased. If this does not fix the problem, contact your nearest Sony dealer.

“UPDATE” appears in the front panel display.

- ➔ The recorder is updating the EPG and other information.

The Parental Lock does not work.

- ➔ Check the “D.TV Age Limit” setting in the “Parental Lock” setup (page 139).

Mechanical sounds are heard when the recorder is off.

















- ➔ While the recorder is updating the EPG information, operational noises (such as the internal fan) may be heard, even when the power is off. This is not a malfunction.
- ➔ While the recorder is adjusting the clock for the Auto Clock Set function or updating the EPG information, operational noises may be heard, even when the power is off. This is not a malfunction.

Resetting the Recorder

You can reset the recorder to all its factory settings.

- 1 Make sure that the recorder is turned on and remove the disc.**
- 2 Hold down **■** (stop) on the recorder and press **I/⏻** on the recorder.**
All settings are reset and the recorder turns off.

Recordable and Playable Discs

Type		Disc Logo	Icon used in this manual	Formatting (new discs)	Compatibility with other DVD players (finalising)
Hard disk drive (internal)	VR mode			Select "Video Mode Off" in "HDD Recording Format" (page 137)	Dub HDD contents to a DVD (VR mode) to play on other DVD players
	Video mode			Select "Video Mode On" (default) in "HDD Recording Format" (page 137)	Dub HDD contents to a DVD (Video mode) to play on other DVD players
DVD+RW		 DVD+ReWritable  DVD+ReWritable High Speed		Automatically formatted in +VR mode (DVD+RW VIDEO)	Playable on DVD+RW compatible players (automatically finalised)
DVD-RW	VR mode			Format in VR mode (page 38)	Playable only on VR mode compatible players (finalisation unnecessary)
	Video mode	 		Format in Video mode (page 38)	Playable on most DVD players (finalisation necessary) (page 46)
DVD+R		 DVD+R  DVD+R DL		Automatically formatted in +VR mode (DVD+R VIDEO)	Playable on most DVD players (finalisation necessary) (page 46)
DVD-R	VR mode			Format in VR mode (page 38) ^{*1} Formatting is performed in the "Format" setup (page 49).	Playable only on DVD-R in VR mode compatible players (finalisation necessary) (page 46)
DVD-R DL	Video mode	 R DL 4X/2X		Automatically formatted in Video mode	Playable on most DVD players (finalisation necessary) (page 46)

Usable disc versions (as of April 2008)

- 8x-speed or slower DVD+RWs
- 6x-speed or slower DVD-RWs (Ver.1.1, Ver.1.2 with CPRM^{*2})
- 16x-speed or slower DVD+Rs
- 8x-speed or slower DVD-Rs (Ver.2.0, Ver.2.1 with CPRM^{*2})
- 8x-speed or slower DVD+R DL (Double Layer) discs
- 8x-speed or slower DVD-R DL (Dual Layer) discs (Ver.3.0 with CPRM^{*2})

“DVD+RW,” “DVD-RW,” “DVD+R,” “DVD+R DL,” “DVD-R,” and “DVD-R DL” are trademarks.

^{*1} When an unformatted DVD-R is inserted into this recorder, it is automatically formatted in Video mode. To format a new DVD-R in VR mode, format in the “Format” setup (page 49).

^{*2} CPRM (Content Protection for Recordable Media) is a coding technology that protects copyrights for images.

Discs that cannot be recorded on

- DVD-RAMs

Maximum recordable number of titles









Disc	Number of titles
HDD*	999
DVD-RW/DVD-R	99
DVD+RW/DVD+R	49
DVD+R DL	49
DVD-R DL	99

* The maximum length for one title is 12 hours.

Notes

- You cannot mix VR mode and Video mode on the same DVD-RW. To change the disc’s format, reformat the disc (page 49). Note that the disc’s contents will be erased after reformatting.
- You cannot shorten the time required for recording even with high-speed discs.
- It is recommended that you use discs with “For Video” printed on their packaging.
- You cannot add new recordings to DVD+Rs, DVD-Rs, or DVD-RWs (Video mode) that contain recordings made on other DVD equipment.
- In some cases, you may not be able to add new recordings to DVD+RWs that contain recordings made on other DVD equipment. If you do add a new recording, note that this recorder will rewrite the DVD menu.
- You cannot edit recordings on DVD+RWs, DVD-RWs (Video mode), DVD+Rs, or DVD-Rs that are made on other DVD equipment.
- If the disc contains PC data unrecognisable by this recorder, the data may be erased.
- You may not be able to record, edit, or dub on some recordable discs, depending on the disc.
- Do not insert any discs that cannot be recorded or played on this recorder. This may cause the recorder to malfunction.

Playable Discs

Type	Disc Logo	Icon used in this manual	Characteristics
DVD VIDEO			Discs such as movies that can be purchased or rented This recorder also recognises DVD-RAMs* as DVD Video compatible discs.
VIDEO CD			VIDEO CDs or CD-Rs/CD-RWs in VIDEO CD/Super VIDEO CD format
CD			Music CDs or CD-Rs/CD-RWs in music CD format
DATA DVD	—		DVD+RWs/DVD+Rs/DVD-RAMs* containing MP3 audio tracks or DivX video files DVD-RWs/DVD-Rs/DVD-ROMs containing MP3 audio tracks, JPEG image files or DivX video files
DATA CD	—		CD-ROMs/CD-Rs/CD-RWs containing either MP3 audio tracks, JPEG image files or DivX video files

“DVD VIDEO” and “CD” are trademarks.

DivX, DivX Certified, and associated logos are trademarks of DivX, Inc. and are used under license.

DivX[®] is a video file compression technology, developed by DivX, Inc.

* If the DVD-RAM has a removable cartridge, remove the cartridge before playback.

Discs that cannot be played

- PHOTO CDs
- CD-ROMs/CD-Rs/CD-RWs that are recorded in a format different from the formats mentioned in the table above.
- Data part of CD-Extras
- BDs (Blu-ray Discs)
- HD DVDs
- Discs recorded with an AVCHD-compatible DVD video camera

- DVD-ROMs/DVD+RWs/DVD-RWs/DVD+Rs/DVD-Rs that do not contain DVD Video, DivX video, JPEG image files, or MP3 audio tracks.
- DVD Audio discs
- Cartridge-only type DVD-RAMs.
- HD layer on Super Audio CDs
- DVD VIDEOS with a different region code (page 154).
- DVDs that were recorded on a different recorder and not correctly finalised.

Note on playback operations of DVD VIDEOS/VIDEO CDs

Some playback operations of DVD VIDEOS/VIDEO CDs may be intentionally set by software producers. Since this recorder plays DVD VIDEOS/VIDEO CDs according to the disc contents the software producers designed, some playback features may not be available. Refer to the instructions supplied with the DVD VIDEOS/VIDEO CDs.

Region code (DVD VIDEO only)

Your recorder has a region code printed on the rear of the unit and will only play DVD VIDEOS (playback only) labelled with identical region codes. This system is used to protect copyrights.

DVD VIDEOS labelled  will also play on this recorder.

If you try to play any other DVD VIDEO, the message "Playback prohibited by region code." will appear on the TV screen.

Depending on the DVD VIDEO, no region code indication may be labelled even though playing the DVD VIDEO is prohibited by area restrictions.

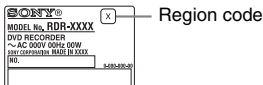

Music discs encoded with copyright protection technologies

This product is designed to play back discs that conform to the Compact Disc (CD) standard.

Various music discs encoded with copyright protection technologies are being marketed by some record companies. Please be aware that among those discs, there are some that do not conform to the CD standard and may not be playable by this product.

Note on DualDiscs

A DualDisc is a two sided disc product which mates DVD recorded material on one side with digital audio material on the other side.

However, since the audio material side does not conform to the Compact Disc (CD) standard, playback on this product is not guaranteed.

Notes

- Some DVD+RWs/DVD+Rs, DVD-RWs/DVD-Rs, DVD-RAMs, or CD-RWs/CD-Rs cannot be played on this recorder due to the recording quality or physical condition of the disc, or the characteristics of the recording device and authoring software. The disc will not play if it has not been correctly finalised. For more information, refer to the operating instructions for the recording device.
- If the disc contains PC data unrecognisable by this recorder, the data may be erased.
- Do not insert any discs that cannot be recorded or played on this recorder. This may cause the recorder to malfunction.

About Recording/ Dubbing Mode



Like the standard ×3 recording modes of video tapes, you can select the desired recording mode using the REC MODE button.

Recording modes with higher quality provide a more beautiful recording, but the large data volume also results in a shorter recording time.

Conversely, a longer duration provides a longer recording time, but the lower data volume results in a coarser picture quality.

To select further options for recording mode (manual recording mode), set "Manual Rec. Mode" to "On (go to setup)" in the "Recording" setup (page 135). To record pictures in higher quality than HQ mode on the HDD, set "Manual Rec. Mode" to "On (go to setup)," and then select "HQ+." The table on the following pages shows the approximate recording times for the HDD and the different DVD types in each manual recording mode, as well as the standard recording mode equivalents.

Hint

To easily select a manual recording mode, press REC MODE repeatedly to display "MN," and select a manual recording mode using / .

Recording time in each recording mode

Bold lines indicate noticeable level differences in recording picture quality.

Recording mode	Approx. recording time (hours)						
	HDD				DVD+RW/ DVD-RW/ DVD+R/ DVD-R	DVD+R DL/ DVD-R DL	
	RDR- HXD790/ HXD795	RDR- HXD890/ HXD895	RDR- HXD990/ HXD995	RDR- HXD1090/ HXD1095			
HQ+ ^{*1}	17	23	36	73	–	–	
PCM ^{*2}	25	34	53	105	1 hr. 1 min.	1 hr. 51 min.	
HQ	MN32	25	34	53	105	1 hr. 1 min.	1 hr. 51 min.
	MN31	27	36	57	115	1 hr. 5 min.	1 hr. 57 min.
	MN30	29	39	61	120	1 hr. 10 min.	2 hr. 6 min.
	MN29	31	42	66	130	1 hr. 15 min.	2 hr. 15 min.
	MN28	33	45	70	140	1 hr. 20 min.	2 hr. 24 min.
	MN27	36	48	75	150	1 hr. 25 min.	2 hr. 33 min.
HSP	MN26	37	50	79	155	1 hr. 30 min.	2 hr. 41 min.
	MN25	39	53	84	165	1 hr. 35 min.	2 hr. 50 min.
	MN24	42	56	88	175	1 hr. 40 min.	2 hr. 59 min.
	MN23	44	59	92	185	1 hr. 45 min.	3 hr. 8 min.
	MN22	46	62	97	195	1 hr. 50 min.	3 hr. 17 min.
SP	MN21	51	68	105	210	2	3 hr. 35 min.
	MN20	54	73	115	230	2 hr. 10 min.	3 hr. 53 min.
	MN19	59	79	120	245	2 hr. 20 min.	4 hr. 11 min.
LSP	MN18	63	84	130	265	2 hr. 30 min.	4 hr. 29 min.
	MN17	67	90	140	280	2 hr. 40 min.	4 hr. 47 min.
	MN16	72	96	150	300	2 hr. 50 min.	5 hr. 5 min.
ESP	MN15	75	100	155	315	3	5 hr. 23 min.
	MN14	78	105	165	335	3 hr. 10 min.	5 hr. 41 min.
	MN13	82	110	175	350	3 hr. 20 min.	5 hr. 59 min.
	MN12	86	115	185	370	3 hr. 30 min.	6 hr. 17 min.
	MN11	90	120	190	390	3 hr. 40 min.	6 hr. 35 min.
	MN10	93	125	200	405	3 hr. 50 min.	6 hr. 53 min.
LP	MN9	100	135	210	420	4	7 hr. 11 min.
	MN8	110	150	235	475	4 hr. 30 min.	8 hr. 4 min.
	MN7	120	165	265	530	5	8 hr. 58 min.
EP	MN6 ^{*3}	150	200	315	635	6	10 hr. 46 min.
	MN5 ^{*3}	175	235	370	745	7	12 hr. 34 min.

Recording mode	Approx. recording time (hours)					
	HDD				DVD+RW/ DVD-RW/ DVD+R/ DVD-R	DVD+R DL/ DVD-R DL
	RDR- HXD790/ HXD795	RDR- HXD890/ HXD895	RDR- HXD990/ HXD995	RDR- HXD1090/ HXD1095		
SLP MN4 ^{*3}	200	270	425	850	8	14 hr. 21 min.
SEP MN3 ^{*3*4}	255	340	530	1060	10	17 hr. 57 min.
MN2 ^{*3*4}	300	405	635	1275	12	21 hr. 32 min.
MN1 ^{*3*4}	340	455	710	1420	13 hr. 22 min.	24

*1 Records in higher quality (15 Mbps).

When recording to the HDD in HQ+ mode, recordings are made in “Video Mode Off” format regardless of the “HDD Recording Format” setting (page 137).

HQ+ mode is not available for DVDs. When recording to DVDs, the recording mode automatically switches to HQ mode even if you set to HQ+ mode.

*2 Audio signals are recorded in 48 kHz PCM format, and video signals are recorded in HQ mode. When recording a bilingual programme, select the sound to be recorded (page 132).

*3 Titles recorded in MN6 or lower mode cannot be dubbed to DVD+RWs/DVD+Rs at high speed.

*4 SEP, MN1, MN2, or MN3 mode is not available for DVD+RWs/DVD+Rs/DVD+R DLs. When recording to DVD+RWs/DVD+Rs, the recording mode automatically switches to SLP mode even if you set to SEP, MN1, MN2, or MN3 mode.

Resolution

The first figure refers to when “Input Line System” is set to “NTSC”; the second when set to “PAL/SECAM” in the “Basic” setup (page 125).

◆ For the HDD (“HDD Recording Format” is set to “Video Mode Off”)/DVD-RW (VR mode)/DVD-R (VR mode)

HQ+, PCM, MN32 to MN16: 720 × 480 / 720 × 576

MN15 to MN12: 544 × 480 / 544 × 576

MN11 to MN9: 480 × 480 / 544 × 576

MN8 and MN7: 352 × 480 / 352 × 576

MN6 to MN1: 352 × 240 / 352 × 288

◆ For the HDD (“HDD Recording Format” is set to “Video Mode On”)/DVD+RW/DVD-RW (Video mode)/DVD+R/DVD-R (Video mode)

PCM, MN32 to MN9: 720 × 480 / 720 × 576

MN8 and MN7: 352 × 480 / 352 × 576

MN6 to MN1: 352 × 240 / 352 × 288

💡 Hint

Audio signals are recorded in Dolby Digital 2 ch format (except for PCM mode).

📌 Notes

- The maximum continuous recording time to the HDD is 12 hours for a single title. A title longer than 12 hours is divided.
- Situations below may cause slight inaccuracies with the recording time.
 - Recording a programme with poor reception, or a programme or video source of low picture quality.
 - Recording on a disc that has already been edited.
 - Recording only a still picture or just sound.

About “High-Speed” dubbing

Required times (approximate) for “High-Speed” dubbing from HDD to DVD (for 60-minute programme)^{*1}

Speed ^{*2}	6x	2.4x	2x
Rec. mode	High-speed DVD+RW/ DVD-RW/ DVD+R/ DVD-R	DVD+R (Double Layer)	DVD-R (Dual Layer)
HQ	Approx. 10 min.	Approx. 25 min.	Approx. 30 min.
HSP	Approx. 6 min. 40 sec.	Approx. 16 min. 40 sec.	Approx. 20 min.
SP	Approx. 5 min.	Approx. 12 min. 30 sec.	Approx. 15 min.
LSP	Approx. 4 min.	Approx. 10 min.	Approx. 12 min.
ESP	Approx. 3 min. 20 sec.	Approx. 8 min. 20 sec.	Approx. 10 min.
LP	Approx. 2 min. 30 sec.	Approx. 6 min. 15 sec.	Approx. 7 min. 30 sec.
EP	Approx. 1 min. 40 sec. ^{*3}	Approx. 60 min. ^{*3}	Approx. 5 min.
SLP	Approx. 1 min. 15 sec. ^{*3}	Approx. 60 min. ^{*3}	Approx. 3 min. 45 sec.
SEP	Approx. 1 min. ^{*3}	Approx. 60 min. ^{*3}	Approx. 3 min. ^{*3}

^{*1} The values in the above table are for reference only. Actual times for dubbing also require time for creating disc’s control information and other data.

^{*2} This is the maximum recording speed of this recorder. The recording speed cannot exceed the value indicated in the above table even when using discs that support higher recording speeds. In addition, depending on the disc condition, the recorder may be unable to record at the maximum recording speed indicated in the table.

^{*3} “High-Speed” dubbing is not available when dubbing titles recorded in SEP, SLP, or EP mode to DVD+RWs and DVD+Rs.



About Copy Protection

Pictures with copy protection cannot be recorded on this recorder.

Dubbing restriction

You cannot dub movies and other DVD VIDEOS to the HDD. Also, when dubbing from a DVD to the HDD, scenes that contain a copy protection signal cannot be recorded. Titles containing “Copy-Once” copy protection signals can be moved only from the HDD to a DVD-RW/DVD-R (VR mode)* (after the title is moved, the original title in the HDD is erased). The “Move” function is performed using Dubbing List. Titles containing “Copy-Once” copy protection signals are indicated with .

Discs that can be used for protected signals

Copy protection signals	Usable discs
Copy-Free (No copy protection signal)	
Copy-Once	
Copy-Never	None

* CPRM-compatible DVD-RWs/DVD-Rs (VR mode) only.

The recorded disc can be played only on CPRM compatible equipment (page 152).

CPRM (Content Protection for Recordable Media) is a coding technology that protects copyrights for images.

Notes

- Protected titles in the HDD cannot be moved.
- The “Move” function is not available for HDD/DVD DUB dubbing.
- Even if you erase a scene that contains a copy protection signal, the recording restrictions on that title are retained.

Language Code List

For details, see page 134.

The language spellings conform to the ISO 639: 1988 (E/F) standard.

Number, Language (Code)

0101, Afar (aa)	0701, Irish (ga)	1307, Malagasy (mg)	1912, Slovenian (sl)
0102, Abkhazian (ab)	0704, Scots Gaelic (gd)	1309, Maori (mi)	1913, Samoan (sm)
0106, Afrikaans (af)	0712, Galician (gl)	1311, Macedonian (mk)	1914, Shona (sn)
0113, Amharic (am)	0714, Guarani (gn)	1312, Malayalam (ml)	1915, Somali (so)
0118, Arabic (ar)	0721, Gujarati (gu)	1314, Mongolian (mn)	1917, Albanian (sq)
0119, Assamese (as)	0801, Hausa (ha)	1315, Moldavian (mo)	1918, Serbian (sr)
0125, Aymara (ay)	0809, Hindi (hi)	1318, Marathi (mr)	1919, Siswati (ss)
0126, Azerbaijani (az)	0818, Croatian (hr)	1319, Malay (ms)	1920, Sesotho (st)
0201, Bashkir (ba)	0821, Hungarian (hu)	1320, Maltese (mt)	1921, Sundanese (su)
0205, Byelorussian (be)	0825, Armenian (hy)	1325, Burmese (my)	1922, Swedish (sv)
0207, Bulgarian (bg)	0901, Interlingua (ia)	1401, Nauru (na)	1923, Swahili (sw)
0208, Bihari (bh)	0905, Interlingue (ie)	1405, Nepali (ne)	2001, Tamil (ta)
0209, Bislama (bi)	0911, Inupiak (ik)	1412, Dutch (nl)	2005, Telugu (te)
0214, Bengali (bn)	0914, Indonesian (in)	1415, Norwegian (no)	2007, Tajik (tg)
0215, Tibetan (bo)	0919, Icelandic (is)	1503, Occitan (oc)	2008, Thai (th)
0218, Breton (br)	0920, Italian (it)	1513 (Afan)Oromo (om)	2009, Tigrinya (ti)
0301, Catalan (ca)	0923, Hebrew (iw)	1518, Oriya (or)	2011, Turkmen (tk)
0315, Corsican (co)	1001, Japanese (ja)	1601, Panjabi (pa)	2012, Tagalog (tl)
0319, Czech (cs)	1009, Yiddish (ji)	1612, Polish (pl)	2014, Setswana (tn)
0325, Welsh (cy)	1023, Javanese (jw)	1619, Pashto (ps); Push-to (ps)	2015, Tonga (to)
0401, Danish (da)	1101, Georgian (ka)	1620, Portuguese (pt)	2018, Turkish (tr)
0405, German (de)	1111, Kazakh (kk)	1721, Quechua (qu)	2019, Tsonga (ts)
0426, Bhutani (dz)	1112, Greenlandic (kl)	1813, Rhaeto-Romance (rm)	2020, Tatar (tt)
0512, Greek (el)	1113, Cambodian (km)	1814, Kirundi (rn)	2023, Twi (tw)
0514, English (en)	1114, Kannada (kn)	1815, Romanian (ro)	2111, Ukrainian (uk)
0515, Esperanto (eo)	1115, Korean (ko)	1821, Russian (ru)	2118, Urdu (ur)
0519, Spanish (es)	1119, Kashmiri (ks)	1823, Kinyarwanda (rw)	2126, Uzbek (uz)
0520, Estonian (et)	1121, Kurdish (ku)	1901, Sanskrit (sa)	2209, Vietnamese (vi)
0521, Basque (eu)	1125, Kirghiz (ky)	1904, Sindhi (sd)	2215, Volapük (vo)
0601, Persian (fa)	1201, Latin (la)	1907, Sangha (sg)	2315, Wolof (wo)
0609, Finnish (fi)	1214, Lingala (ln)	1908, Serbo-Croatian (sh)	2408, Xhosa (xh)
0610, Fiji (fj)	1215, Laotian (lo)	1909, Singalese (si)	2515, Yoruba (yo)
0615, Faroese (fo)	1220, Lithuanian (lt)	1911, Slovak (sk)	2608, Chinese (zh)
0618, French (fr)	1222, Latvian (lv); Lettish		2621, Zulu (zu)

Country/Area Code

For details, see page 138.

Number, Area (Code)

0118, Argentina (ar)	0609, Finland (fi)	1325, Malaysia (my)	1907, Singapore (sg)
0121, Australia (au)	0618, France (fr)	1324, Mexico (mx)	0519, Spain (es)
0120, Austria (at)	0405, Germany (de)	1412, Netherlands (nl)	1905, Sweden (se)
0205, Belgium (be)	0811, Hong Kong (hk)	1426, New Zealand (nz)	0308, Switzerland (ch)
0218, Brazil (br)	0914, India (in)	1415, Norway (no)	2023, Taiwan (tw)
0301, Canada (ca)	0904, Indonesia (id)	1611, Pakistan (pk)	2008, Thailand (th)
0312, Chile (cl)	0920, Italy (it)	1608, Philippines (ph)	0702, United Kingdom (gb)
0314, China (cn)	1016, Japan (jp)	1620, Portugal (pt)	2119, USA (us)
0411, Denmark (dk)	1118, Korea (kr)	1821, Russia (ru)	

Notes About This Recorder

On operation

- If the recorder is brought directly from a cold to a warm location, or is placed in a very damp room, moisture may condense on the lenses inside the recorder. Should this occur, the recorder may not operate properly. In this case, if the recorder is on, leave it on (if it is off, leave it off) for about an hour until the moisture evaporates.
- When you move the recorder, take out any discs and do not apply shock or vibration to the hard disk drive to avoid damaging the disc or hard disk drive (page 4).

On adjusting volume

Do not turn up the volume while listening to a section with very low level inputs or no audio signals. If you do, the speakers may be damaged when a peak level section is played.

On cleaning

Clean the cabinet, panel, and controls with a soft cloth slightly moistened with a mild detergent solution. Do not use any type of abrasive pad, scouring powder or solvent such as alcohol or benzene.

On cleaning discs, disc/lens cleaners

Do not use cleaning discs or disc/lens cleaners (including wet or spray types). These may cause the recorder to malfunction.

Notes about the discs

- To keep the disc clean, handle the disc by its edge. Do not touch the surface. Dust, fingerprints, or scratches on the disc may cause it to malfunction.



- Do not expose the disc to direct sunlight or heat sources such as hot air ducts, or leave it in a car parked in direct sunlight as the temperature may rise considerably inside the car.
- After playing, store the disc in its case.
- Clean the disc with a cleaning cloth. Wipe the disc from the centre out.



- Do not use solvents such as benzene, thinner, commercially available cleaners, or anti-static spray intended for vinyl LPs.
- Do not use the following discs.
 - A disc that has a non-standard shape (e.g., card, heart).
 - A disc with a label or sticker on it.
 - A disc that has cellophane tape or sticker adhesive on it.

On replacement of parts

In the event that this unit is repaired, repaired parts may be collected for reuse or recycling purposes.

About Copyright

ANY USE OF THIS PRODUCT OTHER THAN CONSUMER PERSONAL USE IN ANY MANNER THAT COMPLIES WITH THE MPEG-2 STANDARD FOR ENCODING VIDEO INFORMATION FOR PACKAGED MEDIA IS EXPRESSLY PROHIBITED WITHOUT A LICENSE UNDER APPLICABLE PATENTS IN THE MPEG-2 PATENT PORTFOLIO, WHICH LICENSE IS AVAILABLE FROM MPEG LA, L.L.C., 250 STEELE STREET, SUITE 300, DENVER, COLORADO 80206.

Notes on MP3 Audio Tracks, JPEG Image Files, DivX Video Files, and i.Link

About MP3 audio tracks, JPEG image files, and DivX video files

MP3 is an audio compression technology that satisfies certain ISO/MPEG regulations. JPEG is an image compression technology. You can play MP3 (MPEG1 Audio Layer 3) format audio tracks on the HDD, DATA CDs (CD-ROMs/CD-Rs/CD-RWs) or DATA DVDs (DVD-ROMs/DVD-RWs/DVD-Rs/DVD+RWs/DVD+Rs/DVD-RAMs) or play JPEG image files on the HDD, DATA CDs (CD-ROMs/CD-Rs/CD-RWs) or DATA DVDs (DVD-ROMs/DVD-RWs/DVD-Rs).

DivX[®] is a video file compression technology, developed by DivX, Inc. This product is an official DivX[®] Certified product. You can play DATA CDs (CD-ROMs/CD-Rs/CD-RWs) and DATA DVDs (DVD-ROMs/DVD+RWs/DVD+Rs/DVD-RWs/DVD-Rs/DVD-RAMs) that contain DivX video files.

DATA DVDs must be recorded according to ISO9660 Level 1, Level 2, Romeo, Joliet, or UDF (Universal Disk Format) 1.02, 1.50, 2.00*, or 2.01 format for the recorder to recognise the MP3 tracks, JPEG image files, and DivX video files.

DATA CDs must be recorded according to ISO9660 Level 1, Level 2, Romeo, or Joliet format for the recorder to recognise the MP3 tracks, JPEG image files, and DivX video files.

You can also play discs recorded in MultiSession/Border.

Refer to the instructions supplied with the disc drives and the recording software (not supplied) for details on the recording format.

* Not available for MP3 audio tracks.

Note on MultiSession/Border discs

If audio tracks and images in Music CD format or Video CD format are recorded in the first session/border, only the first session/border will be played back.

MP3 audio tracks, JPEG image files, or DivX video files that the recorder can play

The recorder can play the following tracks and files:

- MP3 audio tracks with the extension “.mp3.”
- JPEG image files with the extension “.jpeg” or “.jpg.”
- Baseline JPEG image files that conform to the Exif 2.2* image files format, and Y:C:B:Cr is 4:4:4, 4:2:2, or 4:2:0.
- DivX video files with the extension “.avi” or “.divx.”

* “Exchangeable Image File Format”: The file format used by digital still cameras.

Hint

Since a disc with many trees takes longer to start playback, it is recommended that you create albums with no more than two trees.

Notes

- The recorder will play any data with the extension “.mp3,” “.jpeg,” “.jpg,” “.avi,” or “.divx” even if they are not in MP3, JPEG, or DivX format. Playing these data may generate a loud noise which could damage your speaker system.
- Depending on the disc, normal playback may not be possible. For example, the picture may be unclear, playback may not appear smooth, the sound may skip, and so on.
- Depending on the disc, playback may take some time to start.
- Some files cannot be played.
- For MP3 audio tracks and DivX video files, the recorder can play up to 99 albums each on a DATA CD or DATA DVD. Up to 99 tracks and files under an album can be played.
- For JPEG image files, the recorder can load up to 99 albums and/or up to 999 files under an album on a DATA CD/DATA DVD or the connected USB device at a time. To view unloaded albums, reload them.

- Proceeding to the next or another album may take some time.
- The image size that can be displayed is limited. The following image sizes can be displayed: width 160–5,120 pixels by height 120–3,840 pixels.
- This recorder supports MP3 audio tracks recorded with a sampling frequency of 32 kHz, 44.1 kHz, and 48 kHz.
- No more than a 1 GB MP3 audio track can be played.
- The recorder does not conform to audio tracks in mp3PRO format.
- The recorder cannot play a DivX video file of a size larger than 720 (width) × 576 (height)/4 GB.
- The recorder may not play a DivX video file when the file has been combined from two or more DivX video files.

Notes on copying JPEG image files/MP3 audio tracks

- You cannot copy JPEG image files/MP3 audio tracks to the HDD if:
 - The total number of JPEG image albums on the HDD exceeds 999.
 - The total number of JPEG image files/MP3 audio tracks under an album exceeds 999.
 - The MP3 audio tracks are 1 GB or larger.
- Note that the size of JPEG image files copied to the HDD may be automatically increased to fit the TV screen.
- You cannot copy JPEG image files onto a DATA DVD finalised on other recorders or devices.
- If a warning message indicating that the HDD is full appears, erase several albums or files to make space. For details on erasing tracks or files, see page 107 or 117.

About i.LINK

The DV IN jack on this recorder is i.LINK-compliant for digital video cameras.

i.LINK is a more familiar term for IEEE 1394 data transport bus proposed by SONY, and is a trademark approved by many corporations.

IEEE 1394 is an international standard standardized by the Institute of Electrical and Electronics Engineers.

For details on how to dub when this recorder is connected to other video equipment having DV jacks, see page 98.

The DV IN jack on this recorder can only input DVC-SD signals. It cannot output signals. The DV IN jack will not accept MICRO MV signals from equipment such as a MICRO MV digital video camera with an i.LINK jack.

For further precautions, see the notes on page 98.

For details on precautions when connecting this recorder, also refer to the instruction manuals for the equipment to be connected.

Note

Normally, only one piece of equipment can be connected to this recorder by the i.LINK cable (DV connecting cable). When connecting this recorder to i.LINK-compatible equipment having two or more i.LINK jacks (DV jacks), refer to the instruction manual of the equipment to be connected.

i.LINK and  are trademarks.

Specifications

System

Laser: Semiconductor laser

Transmission standards (Digital broadcasting): DVB-T

Channel coverage (Digital broadcasting):

VHF: 170 MHz to 230 MHz

UHF: 470 MHz to 862 MHz

Channel coverage (Analogue broadcasting):

PAL (B/G, D/K, I)/SECAM (L)

VHF: E2 to E12, R1 to R12, F2 to F10, Italian A to H, Ireland A to J, South Africa 4 to 11, 13

UHF: E21 to E69, R21 to R69, B21 to B69, F21 to F69

CATV: S01 to S05, S1 to S20, France B to Q

HYPER: S21 to S41

The above channel coverage merely ensures the channel reception within these ranges. It does not guarantee the ability to receive signals in all circumstances. The channels that can be received differ depending on the country/region.

Video reception: Frequency synthesizer system

Audio reception: Split carrier system

Aerial out: 75-ohm asymmetrical aerial socket

Timer: Clock: Quartz locked/Timer indication: 24-hour cycle (digital)

Video recording format: MPEG-2, MPEG-1

Audio recording format/applicable

bit rate: Dolby Digital 2 ch

256 kbps/128 kbps (in EP, SLP, and SEP mode), PCM

Inputs and outputs

LINE 2 OUT

(AUDIO): Phono jack/2 Vrms/10 kilohms

(VIDEO): Phono jack/1.0 Vp-p

(S VIDEO): 4-pin mini DIN/Y: 1.0 Vp-p, C: 0.3 Vp-p (PAL)

LINE 2 IN

(AUDIO): Phono jack/2 Vrms/more than 22 kilohms

(VIDEO): Phono jack/1.0 Vp-p

(S VIDEO): 4-pin mini DIN/Y: 1.0 Vp-p, C: 0.3 Vp-p (PAL)

LINE 3 – TV: 21-pin

CVBS OUT

S-Video/RGB OUT (upstream)

LINE 1/DECODER: 21-pin

CVBS IN/OUT

S-Video/RGB IN

Decoder

DV IN: 4-pin/i.LINK S100

DIGITAL OUT (COAXIAL): Phono jack/0.5 Vp-p/75 ohms

COMPONENT VIDEO OUT

(Y, P_B/C_B, P_R/C_R):

Phono jack/Y: 1.0 Vp-p,

P_B/C_B: 0.7 Vp-p, P_R/C_R: 0.7 Vp-p

G-LINK: mini jack

HDMI OUT: HDMI™ Connector

USB:

USB jack Type A (For connecting digital still camera, Memory card reader, USB memory and HDD camcorder)

USB jack Type B (For connecting PictBridge-compatible printers)

Conditional access module (RDR-

HXD795/HXD895/HXD995/

HXD1095 only): CAM (Conditional Access Module) slot

General

Power requirements: 220-240 V AC,
50/60 Hz

Power consumption:

RDR-HXD790/HXD890/HXD990/
HXD1090: 47 W
RDR-HXD795/HXD895/HXD995/
HXD1095: 49 W

Dimensions (approx.):

430 × 76.5 × 288 mm (width/height/
depth) incl. projecting parts

Hard disk drive capacity:

RDR-HXD790/HXD795: 120 GB
RDR-HXD890/HXD895: 160 GB
RDR-HXD990/HXD995: 250 GB
RDR-HXD1090/HXD1095: 500 GB

Mass (approx.): 4.7 kg

Operating temperature: 5°C to 35°C

Operating humidity: 25% to 80%

Supplied accessories:

Mains lead (1)
Aerial cable (1)*
Remote commander (remote) (1)
Set top box controller (1)
R6 (size AA) batteries (2)

* Two aerial cables are supplied for some models.

Specifications and design are subject to
change without notice.

Index

Words in quotations appear in the on-screen displays.

Numerics

“96 kHz PCM Output”
133

A

“A.TV Auto Channel Setting” 30
“A-B Erase” 84
“A-B Repeat” 77
“Add New Channels” 126
“Add to Play List” 105
Adjusting
 playback picture 120
 recording picture 120
Aerial 18
“Aerial Power” 30, 127
“AFT” 129
“Album Name” 107
“Alternate Search” 56
“Analog Tuner” 127
“Analog Tuner Level”
132
ANGLE 75, 114
“Angle Indicator” 75, 138
“Artist Name” 107
AUDIO 75
Audio cord 25
“Audio DRC” 134
“Audio In” 132
Audio input 26
“Audio Language” 134
“Audio Out” 133
“Auto” 124
“Auto Channel Setting”
127
“Auto Chapter (DVD+R/
+RW)” 136
“Auto Chapter (HDD/
VR)” 136
“Auto Chapter (Video)”
136

Auto Clock Set 31, 124
“Auto Language” 134
“Auto Scan” 127
“Auto Skip” 126

B

“Basic” 123, 124
Batteries 27
“Bilingual Recording”
132
Bilingual recording 70
‘BRAVIA’ Sync 24

C

CAM 26
Canal Plus 36
“Cancel Protection” 117
CD 153
“CH System” 128
“Change Genre” 83
“Change Password” 138
“Channel” 128
“Channel Options” 126
“Channel Sort” 126
“Channel Swapping” 130
Chapter 43, 58, 70
“Chapter Edit” 85
Chapter number 43
“Chapter Search” 80
“Chase Play” 79
Checking/changing/
cancelling timer settings
59, 71
Child Lock 14
“CI Information” 142
“Clock Setting” 31, 124
“Combine” 86, 87
“Command Mode” 29,
141
COMPONENT VIDEO
OUT 23
“Component Video Out”
130
Conditional Access
Module 26
“Confirm Printer” 142

Connecting

a printer 118
the aerial cable 18
the audio cords 25
the HDMI cord 22,
25
the set top box
 controller 18
the USB device 102,
108
the video cords 22
Controlling TVs with the
remote 28
“Copy” 110
“Copy Album” 103
“Copy Album Contents”
110
“Copy all to HDD” 108
“Copy Photos from a
Digital Camera” 109
Copy protection signals
157
“Copy to DVD” 110, 111
“Copy to HDD” 108
“Copy Track” 103
Copy-Free 157
Copying
 albums 102
 audio tracks 102
 JPEG image files 108
Copy-Never 157
Copy-Once 157
Country/Area code 158
CPRM 152
“Create x-Pict Story” 115
Creating a Playlist 87

D

“D.TV Age Limit” 139
“D.TV Auto Channel
Setting” 30
“D.TV Language” 127
DATA CD 153
DATA DVD 153
“Decoder” 37, 130
DIGITAL OUT
(COAXIAL) 25

Digital Services
 Digital Text viewing
 52
 EPG 50
 Programme
 information 51
“Digital Tuner” 126
Disc settings 45, 46, 49,
123
“Disc Setup” 45, 46, 49,
123
Disc space 82
Disc types 151, 153
“Divide” 84, 86, 87
DivX
 “Registration Code”
 141
DivX video files 73
Dolby Digital 25, 133
“Download from TV” 127
DTS 25, 133
Dubbing
 Dubbing List 90
 HDD/DVD DUB 90
 “High-Speed” 157
 Move 157
DV camcorder 98
DV camcorder dubbing 98
 “DV Manual
 Dubbing” 100
 “DV One-Touch
 Dubbing” 100
 “DV Playback” 101
DV IN 98
“DV Input” 99, 132
“DV Manual Dubbing”
100
“DV One-Touch
Dubbing” 100
“DV Playback” 101
“DVD Backup” 93
“DVD Menu Language”
135
“DVD Playback” 138

DVD VIDEO 153
DVD+R 151
DVD+RW 151
DVD-R 151
DVD-RAM 153
DVD-RW 151

E

Easy Setup 30, 125
“Edit” 83, 107
Editing 82
 chapters 85
 Playlist 87
 titles 83
“Editor” 62
Enter characters 44
EPG
 Viewing a list of
 available
 channels 50
“EPG Type Select” 31,
125
“Erase” 59, 83, 86, 107,
117
“Erase Album” 117
“External Audio” 132

F

“Finalise” 46
Finalising 46
“Format” 49
“Format DVD-RW” 123
“Format HDD.” 124
Formatting 49
“Frame Accurate Editing”
82
Freeze Frame 76
Front panel 14
“Front Panel Display” 141
Front panel display 15
“Full Dubbing” 96

G

“Genre Name” 83
“Grid” 62
GUIDE 61, 66
GUIDE Plus+ system 61,
66

H

Handling discs 159
HDD camcorder 94
HDD camcorder dubbing
94
 “Full Dubbing” 96
 “HDD-Cam
 Dubbing” 96
 One-Touch Dubbing
 96
“HDD Recording Format”
137
“HDD-Cam Dubbing” 96
HDMI
 “4:3 Video Output”
 140
 “Audio Output” 140
 “Colour” 140
 “Control for HDMI”
 140
 “Screen Resolution”
 139
HDMI cord 22, 25
HDMI OUT 23, 25
“HDMI Output” 139
“HELP Setting” 125

I

i.LINK 161
“Info” 62
INPUT 60
“Input Colour System”
130
“Input Line System” 125

J

Jukebox 102

L

Labelling 45
“Language” 134
“LINE 1 In” 131
LINE 1/DECODER 34
LINE 2 IN 35
“LINE 3 Out” 131

M

Main sound 70, 132
Mains lead 27
Making a backup disc 93
Managing
 audio tracks on the
 Music Jukebox
 107
 JPEG image files 117
“Manual” 124
“Manual CH Setting” 128
Manual Clock Set 31, 124
“Manual Rec. Mode” 135
Manual recording mode
135
MENU 73
Menu
 DVD’s Menu 73
 Top menu 73
“Modify” 59
“Move” 87, 88
MP3 audio tracks 73
MPEG 25, 133
“Multi-Mode” 83, 117
“Music Jukebox” 102
“My TV” 62

N

“Name” 130
“New Album” 117
NICAM 70
“NICAM Select” 132
“NTSC on PAL TV” 131
Number buttons 80

O

“On Screen Display” 141
ONE-TOUCH DUB 96,
100
One-Touch Play 24, 74

“Optimise HDD” 124
“Options” 141
“Options 2” 142
“Original” 41, 82, 104
“OSD Language” 134

P

Page mode 41, 104, 113
“Parental Lock” 74, 138
Parts and controls 12
Pause Live TV 79
“Pause Mode” 138
PAY-TV 36
PBC 73
PDC 57, 69
“Photo Album” 108, 112
“Picture Adjustment” 120
Picture quality 120
“Play List Name” 107
PLAY MODE 77, 78
Play mode
 “A-B Repeat” 77
 “Programme” 78,
 106
 “Repeat” 77
Playable discs 151, 153
“Playback” 137
Playback 73, 104, 112,
151, 153
 “A-B Repeat” 77
 DivX video files 73
 DV camcorder 101
 fast forward 76, 105
 fast reverse 76, 105
 freeze frame 76
 instant advance 75
 instant replay 75
 JPEG image files 112
 Jukebox 104
 MP3 audio tracks 73
 “Programme” 78,
 106
 “Repeat” 77, 105
 resume play 74
 rotate 114
 scan audio 76
 slow-motion play 76
 zoom 114

Playlist 41, 82, 104
“Power Save” 125
Printing JPEG image files
118
“Programme” 78, 106
Programme information
51
“Progressive” 31
“Protect” 83, 117
“Protect Album Contents”
117
“Protect Disc” 45
Protection
 album 117
 disc 45
 JPEG image file 117
 title 83

Q

Quick Timer 58, 69

R

Rear panel 16
REC 38
REC MODE 154
REC STOP 38, 96, 100
“Rec. Mode Adjust” 54,
68, 135
“Recommendation
Search” 56
Recordable discs 151
“Recording” 135
Recording 53, 66
 picture adjustment
 120
 recording format 151
 recording mode 40,
 154
 recording time 40,
 154
 Series Recording 55
 while watching
 another
 programme 39
Recording mode 40, 154
Recording time 40, 154
Recovery Recording 57,
71

Region code 154
Remaining time 43
Remote 12, 27
“Rename Album” 117
“Rename File” 117
“Repeat” 77, 105
“Repeat Album” 77, 105
“Repeat Artist” 105
“Repeat Chapter” 77
“Repeat Disc” 77
“Repeat Play List” 105
“Repeat Programme” 77, 105
“Repeat Title” 77
“Repeat Track” 77, 105
“Replace Channels” 126
Resetting the recorder
125, 150
“Restart USB Device”
142
Resume Play 74
Rotate 114

S

S VIDEO 23
Scan Audio 76
“Schedule” 62
“Seamless Playback” 138
“Search” 62
Searching
 audio track 105
 by genre 42
 fast reverse/fast
 forward 76, 105
 JPEG image file 114
 locating the
 beginning of the
 title/chapter/
 track 75, 105
 scan audio 76
“Series Recording” 55
“Series Search” 56
“Set Genre” 83
“Set Password” 138
“Set Preview” 142
“Set Thumbnail” 83, 136
Set top box controller 18,
33
Set top box receiver 20

Setting up the GUIDE
Plus+ system 32
“Setup” 62
“Signal Check” 127
Simultaneous Rec and
Play 80
“Skip” 128
“Skip Once” 59
Slideshow 114
 x-Pict Story 115
Slow-motion play 76
SMARTLINK 24, 141
“Software Update” 142
“Sort Titles” 41
“Sound System” 130
Split Programmes 55
Sub sound 70, 132
SUBTITLE 75
“Subtitle Display” 135
“Subtitle Language” 134
“Subtitle Recording” 135
Super VIDEO CD 153

T

Thumbnail picture 42
 preview mode 42,
 142
“Time Search” 80
TIMER 56
Timer List 59
Timer recording
 check/change/cancel
 59, 71
 EPG timer setting 53
GUIDE Plus+ system
 66
 manual setting 56,
 68
“Rec. Mode Adjust”
 54, 68
“Timing” 71
Title 43
Title List 40
 “Genre” 42
 “Sort Titles” 41
 thumbnail 42
“Title Name” 83
Title number 43
“Title Search” 80

TOP MENU 73
“Track Name” 107
“Track Search” 80
Troubleshooting 143
TV Direct Rec. 24, 39
TV PAUSE 79
“TV Pause” 79, 142
TV system 130
TV  28, 39
“TV Type” 31, 137
TV/DVD 29, 39

U

“Undo” 83
“Unfinalise” 48
Unfinalising 48
“Unprotected” 83
Usable discs 151, 153
USB 95
Using the setup menus
123

V

VIDEO CD 153
Video cord 22
“Video In/Out” 130
Video input 23
Video mode 151
“Video Mode Compatible
Editing” 82
VPS 57, 69
VR mode 151

X

x-Pict Story 115
 “Play List” 116
 “Theme” 116

Z

Zoom 114
ZWEITON 70



Printed on 70% or more recycled paper.



1-329508012

3-295-080-12(1)