

SONY®

LCD Colour TV

Operating Instructions

KLV-37S550A

KLV-32S550A

KLV-32S530A

KLV-26S550A

BRAVIA

Introduction

Thank you for choosing this Sony product.
Before operating the TV, please read this manual thoroughly and retain it for future reference.

The illustrations used in this manual are of the KLV-32S550A unless otherwise stated.

Trademark information

- HDMI, the HDMI logo and High-Definition Multimedia Interface are trademarks or registered trademarks of HDMI Licensing LLC.
- “BRAVIA” and BRAVIA are trademarks of Sony Corporation.



Notes for Australia and New Zealand model

This product is ENERGY RATING qualified in the “Home” mode. ENERGY RATING is a programme designed to promote energy efficient products and practices.

- When the TV is initially set up, it is designed to meet ENERGY RATING requirements while maintaining optimum picture quality.
- Changes to certain features, settings and functionalities of this TV (e.g. Picture/Sound and Eco settings) can slightly change the power consumption.

Depending upon such changed settings, the power consumption may vary which possibly could exceed the stated energy rating. To reset the TV to ENERGY RATING qualified settings, select “Home” mode from the initial set-up procedure in “Factory Settings” under the “Set-up” menu.

Table of Contents

Start-up Guide

Checking the accessories	4
1: Attaching the stand.....	4
2: Connecting an antenna/cable/VCR	4
3: Preventing the TV from toppling over	5
4: Bundling the cables	5
5: Performing the initial set-up.....	5
Selecting the language, country/region and location	5
Auto-tuning the TV.....	6
Watching TV	6
Detaching the Table-Top Stand from the TV.....	6
Safety information	7
Precautions	8
Overview of the remote	9
Using the Tools menu.....	10
Overview of the TV buttons and indicators.....	11

Using Optional Equipment

Connecting optional equipment.....	12
Viewing pictures from the connected equipment.....	13
Viewing Twin Picture	14
Viewing PIP (Picture in Picture).....	14

Using MENU Functions

Navigating through menus	15
Listening to the FM Radio	15
Using the Favourite List.....	16
Settings adjustment.....	17
Picture menu	17
Sound menu	18
Screen menu	19
Set-up menu	19
PC Settings menu.....	20
Channel Set-up menu.....	21
Eco menu	23

Additional Information

Installing the Accessories (Wall-Mount Bracket).....	24
TV installation dimensions table.....	25
Screw and Hook locations diagram/table	26
Troubleshooting	27
Specifications	Back cover

Before operating the TV, please read "Safety information" (page 7). Retain this manual for future reference.

Start-up Guide

Checking the accessories

Stand (1) and screws (4)

Remote RM-GA016 (1)

Size AA batteries (R6 type) (2)

To insert batteries into the remote

Push and lift the cover to open.

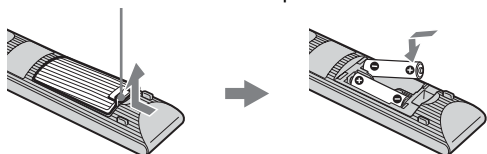

1: Attaching the stand

► KLV-37S550A

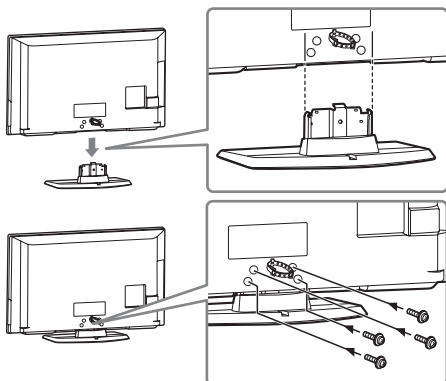

► KLV-32S550A/KLV-32S530A/KLV-26S550A

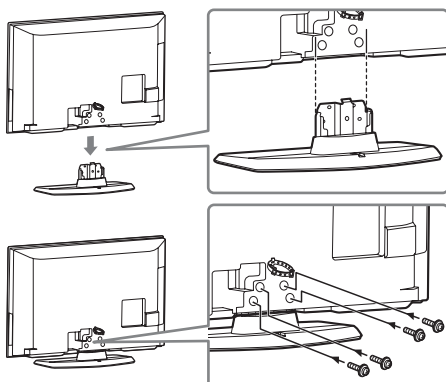

- This TV is very heavy, so two or more people should place the TV onto the stand.
- If using an electric screwdriver, set the tightening torque at approximately 1.5N·m (15kgf·cm).
- Ensure the AC power cord is away from screw holes during stand installation to avoid damage to the AC power cord.

2: Connecting an antenna/cable/VCR

Connecting an antenna/cable

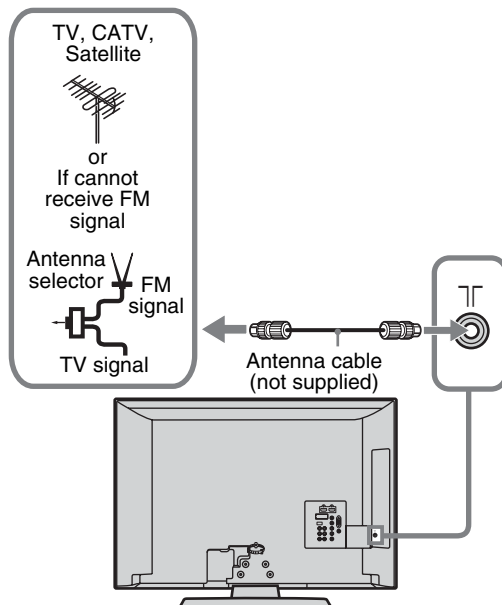

Connecting an antenna/cable and VCR

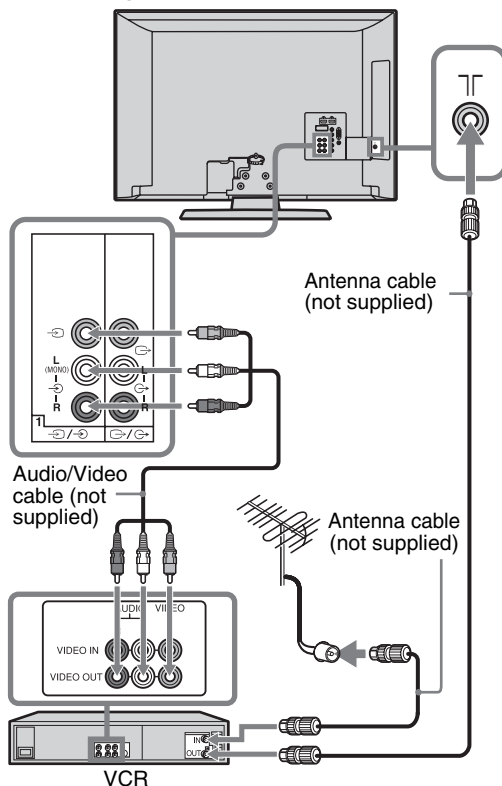

3: Preventing the TV from toppling over

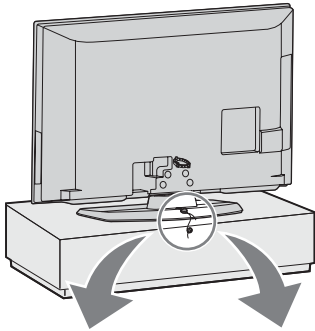

For KLV-37S550A:

For KLV-32S550A/
KLV-32S530A/
KLV-26S550A:

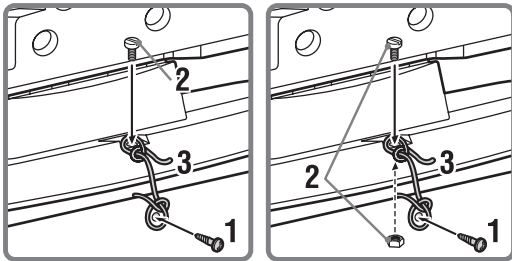

1 Install a wood screw (4 mm in diameter, not supplied) in the TV stand.

2 Install a machine screw (M4 × 14, not supplied) into the screw hole of the TV.

For KLV-32S550A/KLV-32S530A/
KLV-26S550A:

Attach a nut (M4, not supplied) from the bottom of the Table-Top Stand to the screw securely.

3 Tie the wood screw and the machine screw with a strong cord.

• An optional Sony support belt kit is used to secure the TV. Contact your nearest Sony Service Centre to purchase a kit. Have your TV model name ready for reference.

4: Bundling the cables

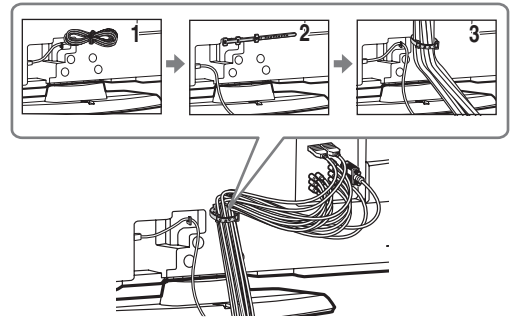

• Do not bundle the AC power cord together with other cables.

5: Performing the initial set-up

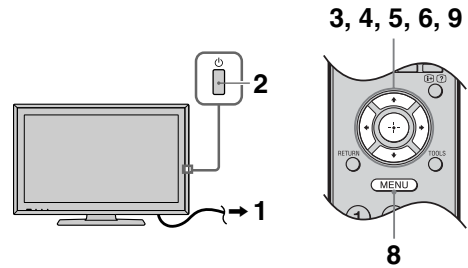

1 Connect the TV to your AC power outlet (110-240 V AC, 50/60 Hz) (New Zealand and Tunisia only: 220-240 V AC, 50/60 Hz).

2 Press on the TV.
When the TV is in standby mode (the (standby) indicator on the TV front panel is red), press on the remote to turn on the TV.
When you turn on the TV for the first time, the “Language” menu appears on the screen.

Selecting the language, country/region and location

Follow the instructions on the screen.

3 Press to select the language displayed on the menu screens, then press .

4 Press to select the country/region, then press .

5 Press to select “Home”, then press .

Continued

Auto-tuning the TV

- 6 Press \leftarrow/\rightarrow to select “OK”, then press \oplus .
The TV starts searching for all available channels.
If a message appears for you to confirm the antenna connection

No programmes found. Please connect antenna (aerial) and select “Confirm” to start auto-tuning again. If 200 channels are found, auto-tuning is stopped.

- 7 When the “Programme Sorting” menu appears on the screen, follow the steps of “Programme Sorting” (page 21).

If you do not want to change the order in which the channels are stored on the TV, go to step 8.

- 8 Press MENU to exit.

The TV has now tuned in all the available channels.

- 9 Press \leftarrow/\rightarrow to select the desired setting in “Display this menu next time?” dialogue, then press \oplus to exit.

 • If “Yes” is selected and the TV is turned off by pressing ⏻ on the TV, or is disconnected from the AC power outlet, the initial set-up procedure restarts the next time the TV is turned on.

Watching TV

- 1 Press ⏻ on the TV to turn on the TV.
- 2 Press the number buttons or PROG +/- to select a TV channel.
- 3 Press \triangleleft +/- to adjust the volume.

Detaching the Table-Top Stand from the TV

-  • Do not remove the Table-Top Stand for any reason other than to wall-mount the TV.

► KLV-37S550A

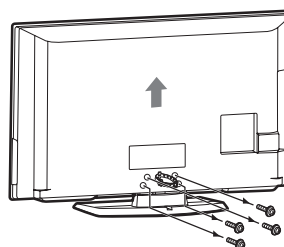

► KLV-32S550A/KLV-32S530A/KLV-26S550A

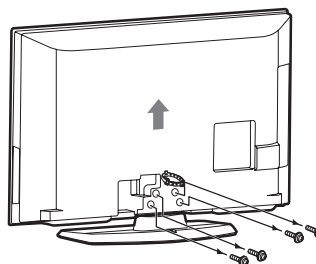

Safety information

Installation/Set-up

Install and use the TV set in accordance with the instructions below in order to avoid any risk of fire, electrical shock or damage and/or injuries.

Installation

- The TV set should be installed near an easily accessible AC power outlet.
- Place the TV set on a stable, level surface to avoid it from falling down and cause personal injury or damage to the TV.
- Only qualified service personnel should carry out wall installations.
- For safety reasons, it is strongly recommended that you use Sony accessories, including:
 - KLV-37S550A/KLV-32S550A/
KLV-32S530A:
Wall-mount bracket SU-WL500 or SU-WL50B
 - KLV-26S550A:
Wall-mount bracket SU-WL100
- Be sure to use the screws supplied with the Wall-mount bracket when attaching the mounting hooks to the TV set. The supplied screws are designed so that they are 8 mm to 12 mm in length when measured from the attaching surface of the mounting hook. The diameter and length of the screws differ depending on the Wall-mount bracket model. Use of screws other than those supplied may result in internal damage to the TV set or cause it to fall, etc.

8mm - 12mm

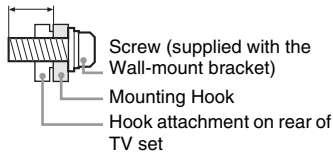

Transporting

- Before transporting the TV set, disconnect all cables.
- Two or more people are needed to transport a large TV set.
- When transporting the TV set by hand, hold it as shown below. Do not put stress on the LCD panel.

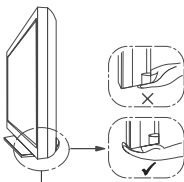
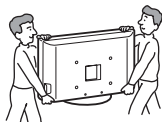

Be sure to hold the bottom of the panel, not the front part.

- When lifting or moving the TV set, hold it firmly from the bottom.
- When transporting the TV set, do not subject it to jolts or excessive vibration.
- When transporting the TV set for repairs or when moving, pack it using the original carton and packing material.

Ventilation

- Never cover the ventilation holes or insert anything in the cabinet.
- Leave space around the TV set as shown below.
- It is strongly recommended that you use a Sony wall-mount bracket in order to provide adequate air-circulation.

Installed on the wall

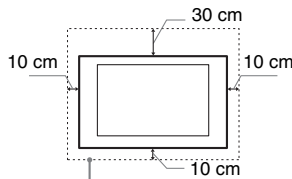

Leave at least this space around the set.

Installed with stand

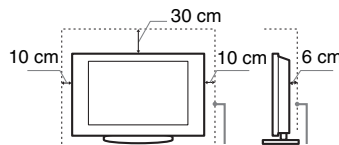

Leave at least this space around the set.

- To ensure proper ventilation and prevent the collection of dirt or dust:
 - Do not lay the TV set flat, install upside down, backwards, or sideways.
 - Do not place the TV set on a shelf, rug, bed or in a closet.
 - Do not cover the TV set with a cloth, such as curtains, or items such as newspapers, etc.
 - Do not install the TV set as shown below.

Air circulation is blocked.

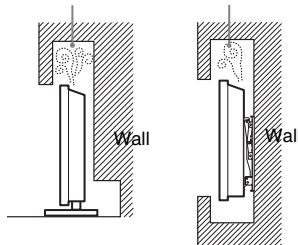

AC power cord

- Handle the AC power cord and outlet as follows in order to avoid any risk of fire, electrical shock or damage and/or injuries:
- Use only Sony supplied AC power cords, not those of other brands.
 - Insert the plug fully into the AC power outlet.
 - Operate the TV set on a 110-240 V AC supply only (New Zealand and Tunisia only: 220-240 V AC).
 - When wiring cables, be sure to unplug the AC power cord for your safety and take care not to catch your feet on the cables.
 - Disconnect the AC power cord from the AC power outlet before working on or moving the TV set.
 - Keep the AC power cord away from heat sources.
 - Unplug the AC power plug and clean it regularly. If the plug is covered with dust and it picks up moisture, its insulation may deteriorate, which could result in a fire.

Notes

- Do not use the supplied AC power cord on any other equipment.
- Do not pinch, bend, or twist the AC power cord excessively. The core conductors may be exposed or broken.
- Do not modify the AC power cord.
- Do not put anything heavy on the AC power cord.
- Do not pull on the AC power cord itself when disconnecting the AC power cord.
- Do not connect too many appliances to the same AC power outlet.
- Do not use a poor fitting AC power outlet.

Prohibited Usage

Do not install/use the TV set in locations, environments or situations such as those listed below, or the TV set may malfunction and cause a fire, electrical shock, damage and/or injuries.

Location:

Outdoors (in direct sunlight), at the seashore, on a ship or other vessel, inside a vehicle, in medical institutions, unstable locations, near water, rain, moisture or smoke.

Environment:

Places that are hot, humid, or excessively dusty; where insects may enter; where it might be exposed to mechanical vibration, near flammable objects (candles, etc). The TV set shall not be exposed to dripping or splashing and no objects filled with liquids, such as vases, shall be placed on the TV.

Situation:

Do not use when your hands are wet, with the cabinet removed, or with attachments not recommended by the manufacturer. Disconnect the TV set from AC power outlet and antenna during lightning storms.

Continued

Broken pieces:

- Do not throw anything at the TV set. The screen glass may break by the impact and cause serious injury.
- If the surface of the TV set cracks, do not touch it until you have unplugged the AC power cord. Otherwise electric shock may result.

When not in use

- If you will not be using the TV set for several days, the TV set should be disconnected from the AC power for environmental and safety reasons.
- As the TV set is not disconnected from the AC power when the TV set is just turned off, pull the plug from the AC power outlet to disconnect the TV set completely.
- However, some TV sets may have features that require the TV set to be left in standby to work correctly.

For children

- Do not allow children to climb on the TV set.
- Keep small accessories out of the reach of children, so that they are not mistakenly swallowed.

If the following problems occur...

Turn off the TV set and unplug the AC power cord immediately if any of the following problems occur.

Ask your dealer or Sony service centre to have it checked by qualified service personnel.

When:

- AC power cord is damaged.
- Poor fitting of AC power outlet.
- TV set is damaged by being dropped, hit or having something thrown at it.
- Any liquid or solid object falls through openings in the cabinet.

Precautions

Viewing the TV

- View the TV in moderate light, as viewing the TV in poor light or during long period of time, strains your eyes.
- When using headphones, adjust the volume so as to avoid excessive levels, as hearing damage may result.

LCD Screen

- Although the LCD screen is made with high-precision technology and 99.99% or more of the pixels are effective, black dots may appear or bright points of light (red, blue, or green) may appear constantly on the LCD screen. This is a structural property of the LCD screen and is not a malfunction.
- Do not push or scratch the front filter, or place objects on top of this TV set. The image may be uneven or the LCD screen may be damaged.
- If this TV set is used in a cold place, a smear may occur in the picture or the picture may become dark. This does not indicate a failure. These phenomena disappear as the temperature rises.
- Ghosting may occur when still pictures are displayed continuously. It may disappear after a few moments.
- The screen and cabinet get warm when this TV set is in use. This is not a malfunction.
- The LCD screen contains a small amount of liquid crystal. Mercury is sometimes contained depending on the kind of fluorescent tubes. Follow your local ordinances and regulations for disposal.

Handling and cleaning the screen surface/cabinet of the TV set

Be sure to unplug the AC power cord connected to the TV set from AC power outlet before cleaning.

To avoid material degradation or screen coating degradation, observe the following precautions.

- To remove dust from the screen surface/cabinet, wipe gently with a soft cloth. If dust is persistent, wipe with a soft cloth slightly moistened with a diluted mild detergent solution.
- Never use any type of abrasive pad, alkaline/acid cleaner, scouring powder, or volatile solvent, such as alcohol, benzene, thinner or insecticide. Using such materials or maintaining prolonged contact with rubber or vinyl materials may result in damage to the screen surface and cabinet material.
- Periodic vacuuming of the ventilation openings is recommended to ensure to proper ventilation.
- When adjusting the angle of the TV set, move it slowly so as to prevent the TV set from moving or slipping off from its table stand.

Optional Equipment

Keep optional components or any equipment emitting electromagnetic radiation away from the TV set. Otherwise picture distortion and/or noisy sound may occur.

Batteries

- Observe the correct polarity when inserting batteries.
- Do not use different types of batteries together or mix old and new batteries.
- Dispose of batteries in an environmentally friendly way. Certain regions may regulate the disposal of batteries. Please consult your local authority.
- Handle the remote with care. Do not drop or step on it, or spill liquid of any kind onto it.
- Do not place the remote in a location near a heat source, a place subject to direct sunlight, or a damp room.

IMPORTANT INFORMATION

If a television is not positioned in a sufficiently stable location, it can be potentially hazardous due to falling. Many injuries, particularly to children, can be avoided by taking simple precautions such as:

- Using cabinets or stands recommended by the manufacturer of the television.
- Only using furniture that can safely support the television.
- Ensuring the television is not overhanging the edge of the supporting furniture.
- Not placing the television on tall furniture (for example, cupboards or bookcases) without anchoring both the furniture and the television to a suitable support.
- Not standing the televisions on cloth or other materials placed between the television and supporting furniture.
- Educating children about the dangers of climbing on furniture to reach the television or its controls.

Disposal of Old Electrical & Electronic Equipment (Applicable in the European Union and other European countries with separate collection systems)

This symbol is on the remote control.



Overview of the remote

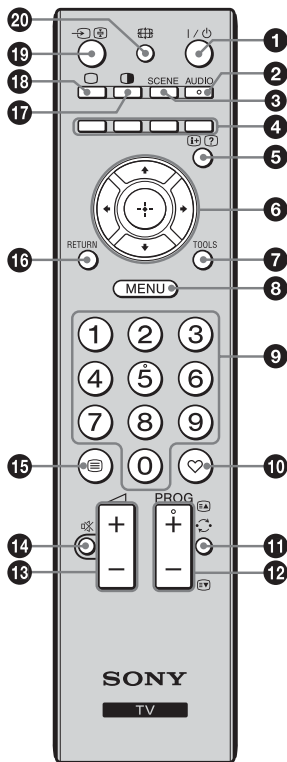

☀ • The number 5, PROG + and AUDIO buttons have tactile dots. Use the tactile dots as references when operating the TV.

- 1 I/⏻ – TV standby**
Press to turn the TV on or to switch to standby mode.
- 2 AUDIO – Dual Sound (page 18)**
- 3 SCENE – Scene Select mode**
Press to display the “Scene Select” menu. When you select the desired scene option, the optimum sound and picture quality for selected scene are automatically set.
Sports: Delivers picture scenes that let you experience realistic picture and sound like those in a stadium.
Game: Delivers picture scenes that let you enjoy your game-playing experience to the fullest with superb picture and sound quality.
Cinema: Delivers picture scenes just like those in a theatre-like atmosphere with dynamic sound.
Music: Delivers sound effects that let you experience dynamic and clear sound like that at a concert.
General: Current user settings.
- 4 Coloured buttons**
In Text mode: Accesses the corresponding coloured Fastext menu quickly and easily. The Fastext feature can be used only when the Fastext broadcast is available.
- 5 [F] / [Q] – Info / Text reveal**
 - Displays information. Press once to display current channel number, scene mode and screen mode. Press again to remove the display from the screen.
 - In Text mode: Reveals hidden information (e.g. answers to a quiz).
- 6 [↑/↓/←/→] / [OK] – Item select / OK**
 - Selects or adjusts items.
 - Confirms selected items.
- 7 TOOLS (page 10)**
- 8 MENU**
Displays or cancels the menu.
- 9 Number buttons**
 - Selects channels. For channel numbers 10 and above, enter the next digit quickly (page 21).
 - In Text mode: Enters the three digit page number to select the page.
- 10 [♥] – Favourite list**
Display the Favourite list that you have specified (page 16).
- 11 [↶] – Previous channel**
Returns to the previous channel watched (for more than five seconds).
- 12 PROG +/- / [EA] / [EV]**
 - Selects the next (+) or previous (-) channel.
 - In Text mode: Selects the next ([EA]) or previous ([EV]) page.
- 13 [Δ] +/- – Volume**
Adjusts volume.
- 14 [M] – Mute**
Press to mute the sound. Press again to restore the sound.
☀ • In standby mode, if you want to turn on the TV without sound, press this button.
- 15 [≡] – Text**
In Text mode: Displays Text broadcast.
Each time you press [≡], the display changes cyclically as follows:
Text → Text over the TV picture (mix mode) → No Text (exit the Text service)
- 16 RETURN**
Returns to the previous screen of any displayed menu.
- 17 [P] – Twin Picture / PIP (page 14)**
- 18 [□] – TV mode**
Exit Text mode, or switches to a TV display when displaying external input.
- 19 [→] / [←] – Input select / Text hold**
 - Displays the connected equipment list and selects the input source (page 13).
 - In Text mode: Holds the current page.
- 20 [⊞] – Wide Mode**
Changes the picture size. Press repeatedly to select the desired wide mode.

Continued

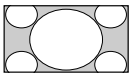
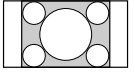
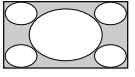
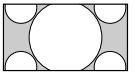

For TV, Video, Component or HDMI (except PC input)

Wide Zoom* 	Enlarges the centre portion of the picture. The left and right edges of the picture are stretched to fill the 16:9 screen.
Normal 	Displays the 4:3 picture in its original size. Side bars are shown to fill the 16:9 screen.
Full 	Stretches the 4:3 picture horizontally to fill the 16:9 screen.
Zoom* 	Displays cinemascope (letter box format) broadcasts in the correct proportions.

* Parts of the top and bottom of the picture may be cut off.

• You cannot select "Normal" for HD signal source pictures.

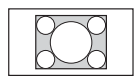
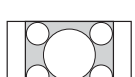
For PC Input

Normal 	Displays the picture in its original pixel size. Bars are shown at the top, bottom, and both sides for small picture.
Full 1 	Stretches the original picture to fill the screen vertically.
Full 2 	Stretches the Full 1 picture horizontally to fill the 16:9 screen.

• Some options may not be available depending on the PC input signal.

Using the Tools menu

Press TOOLS enables you to access various options and change/make adjustments according to the source and screen mode. The options displayed vary depending on the input source.

Viewing TV programme

Options	Description
Picture Mode	See page 17.
Sound Mode	See page 18.
Intelligent Picture	See page 22.
MPEG Noise Reduction	See page 17.
Speaker	See page 19.
Add to Favourites	You can add the current channel to the favourite list.
Sleep Timer	See page 20.
Wake Up Timer	See page 20.
Power Saving	See page 23.

Listening FM Radio

Options	Description
Sound Mode	See page 18.
Speaker	See page 19.
Sleep Timer	See page 20.
Wake Up Timer	See page 20.
Power Saving	See page 23.
FM Radio Set-up	See page 23.

Viewing connected equipment

Options	Description
Picture Mode (except PC input mode)	See page 17.
Display Mode (in PC input mode only)	See page 17.
Sound Mode	See page 18.
MPEG Noise Reduction (except PC input mode)	See page 17.
Speaker	See page 19.
Twin Picture (except PC input mode)	See page 14.
PIP (in PC input mode only)	See page 14.
Single Picture (in Twin Picture and PIP mode only)	See page 14.
Audio Swap (in PIP mode only)	See page 14.
Auto Adjustment (in PC input mode only)	See page 20.
Horizontal Shift (in PC input mode only)	See page 20.
Sleep Timer (except PC input mode)	See page 20.
Wake Up Timer (except PC input mode)	See page 20.
Power Saving	See page 23.

Overview of the TV buttons and indicators

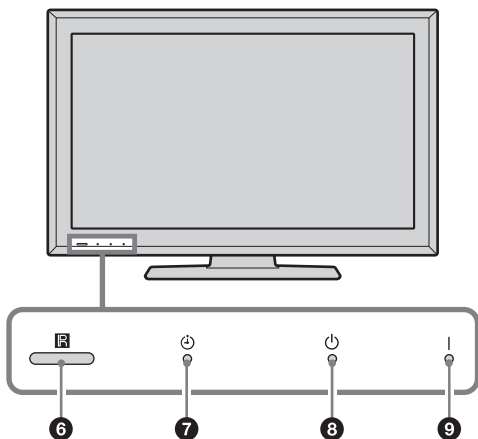
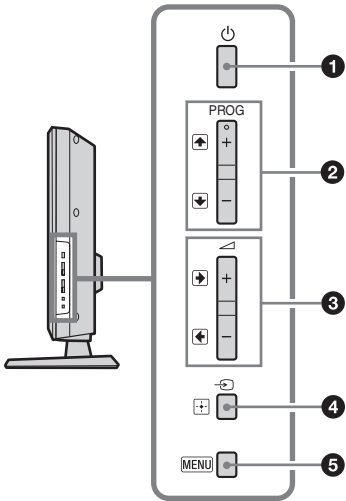

- 1** – **Power**
 Turns the TV on or off.
 - To disconnect the TV from the AC power completely, pull the plug from the AC power outlet.
- 2** **PROG**
 - Selects the next (+) or previous (-) channel.
 - In TV menu: Moves through the options up () or down ()
- 3** **+/-/**
 - Increases (+) or decreases (-) the volume.
 - In TV menu: Moves through the options right () or left ()
- 4** – **Input select / OK**
 - Displays the connected equipment list and selects the input source (page 13).
 - In TV menu: Selects the menu or option, and confirms the setting.
- 5** **MENU**
 Displays or cancels the menu.
- 6** – **Remote sensor**
 Receives IR signals from the remote.
- 7** – **Timer indicator**
 Lights up in amber when the timer is set (page 20).
- 8** – **Standby indicator**
 Lights up in red when the TV is in standby mode.
- 9** – **Power indicator**
 - Lights up in green when the TV is turned on.
 - Flashes while the remote is being operated.

Using Optional Equipment

Connecting optional equipment

You can connect a wide range of optional equipment to your TV.

 • The below terminals vary depending on TV models.

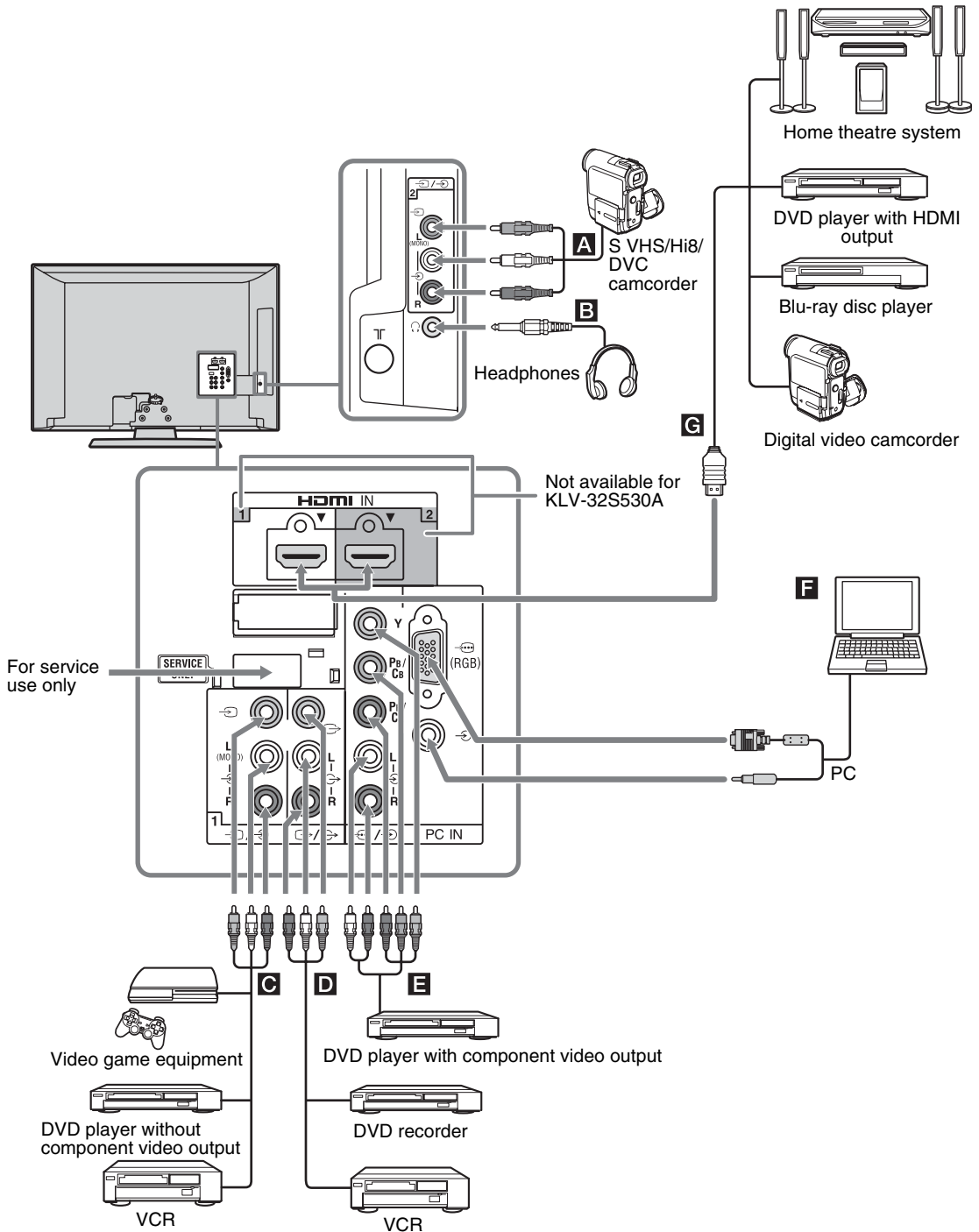

Viewing pictures from the connected equipment

Turn on the connected equipment, then press / to display the connected equipment list. Press / to select the desired input source, then press . (The highlighted item is selected if 2 seconds pass without any operation after pressing /.) When the input source is set to "Skip" in the "Video Labels" under the "AV Set-up" menu (page 19), that input does not appear in the list.

- Press / on the TV to display the connected equipment list and select the desired input source. You can also press / to select the desired input source. Then wait for 2 seconds to display the selected input source.

Jacks/ Input symbol on screen	Description
A 2, and 2 Video 2	Connect to the video jack 2, and the audio jacks 2. If you connect mono equipment, connect to the L(MONO) jack 2.
B	Connect to the jack to listen to sound from the TV on headphones.
C 1, and 1 Video 1	Connect to the video jack 1, and the audio jacks 1. If you connect mono equipment, connect to the L(MONO) jack 1.
D /	Connect to the video output jack to record the image from the TV. Connect to the audio output jacks to record the sound from the TV on DVD recorder or VCR. To turn off the sound of the TV speakers, set "Speaker" to "Audio System" (page 19). If you connect mono equipment, connect to the L jack . • The monitor output jacks cannot support Component, HDMI and PC signals source pictures, also digital audio signal for sound.
E / Component	Connect to the component jacks and the audio jacks /. For better picture quality, component connection is recommended if your DVD player has a component video output.
F PC IN (RGB)/ PC	Connect to the PC IN (RGB) jack and the audio jack . It is recommended to use a PC cable with ferrite core.
G HDMI IN HDMI (For KLV-32S530A) HDMI 1 or HDMI 2 (For KLV-37S550A/ KLV-32S550A/ KLV-26S550A)	Connect to the HDMI IN (KLV-32S530A), HDMI IN 1 or 2 (KLV-37S550A/ KLV-32S550A/KLV-26S550A) jack if the equipment has an HDMI jack. The digital video and audio signals are input from the equipment. • The HDMI jacks only support the following video inputs: 480i, 480p, 576i, 576p, 720p (50/60 Hz), 1080i (50/60 Hz) and 1080p (50/60 Hz). • Be sure to use only an HDMI cable that bears the HDMI logo (recommended Sony HDMI cable). • To connect a PC, use the PC IN jack.

Viewing Twin Picture

You can view two pictures (external input and TV programme) on the screen simultaneously. Connect the optional equipment (page 12), and make sure that images from the equipment appear on the screen (page 13).

1 Press **□**.

Two pictures are displayed simultaneously.



Twin Picture Availability

In Left Window	In Right Window
Video 1 Video 2	No picture and no sound
Component	
*HDMI (except PC input mode)	
**HDMI 1 (except PC input mode)	TV programme
**HDMI 2 (except PC input mode)	

* For KLV-32S530A

** For KLV-37S550A/KLV-32S550A/KLV-26S550A

2 Press **↔** to select active picture.

3 Press number buttons or PROG +/- to select the TV channel.

To return to single picture mode

Press **⊕**, **□** or RETURN.

- ✎ • You cannot change the size of the pictures.
- The picture and sound from the monitor output jacks **Ⓜ** (refer **D** in page 12) will follow the left picture (Video 1 or Video 2 only).
- In Twin Picture mode, as picture size reduced, this may decrease picture smoothness.
- 💡 • The highlighted picture is audible. You can switch the audible picture by pressing **↔**.
- You can also use the Twin Picture feature by selecting "Twin Picture" from the Tools menu (page 10).

Viewing PIP (Picture in Picture)

You can view two pictures (PC input and TV programme) on the screen simultaneously. Connect a PC (page 12), and make sure that images from a PC appear on the screen (page 13).

1 Press **□**.

Two pictures are displayed simultaneously.



PIP Availability

In Main Window	In Sub Window
PC	TV programme

2 Press number buttons or PROG +/- to select the TV channel.

To return to single picture mode

Press **□** or RETURN.

- ✎ • You cannot display resolutions higher than WXGA (1360 × 768 pixels).
- In PIP mode, as picture size reduced, this may decrease picture smoothness.
- 💡 • You can switch the audible picture by selecting "Audio Swap" from the Tools menu (page 10).
- You can also use the PIP feature by selecting "PIP" from the Tools menu (page 10).

Using MENU Functions

Navigating through menus

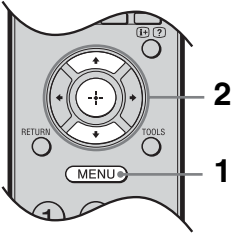

“MENU” allows you to enjoy various convenient features of this TV. You can easily select channels or inputs sources, preset FM radio stations and change the settings for your TV.

- 1 Press MENU.
- 2 Press \uparrow/\downarrow to select an option, then press \oplus . To exit the menu, press MENU.

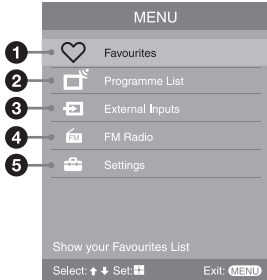

Menu	Descriptions
1 Favourites	Displays the favourite list (page 16). <ul style="list-style-type: none"> • To watch the desired channel, select the favourite channel number, then press \oplus. • To add the current channel to the favourite list, select “Add to Favourites”. When the favourite list is full, select “Edit Favourites” to remove any channel from your list and try again (page 16).
2 Programme List	Displays available TV channels. <ul style="list-style-type: none"> • To watch the desired channel, select the channel, then press \oplus. • To assign a label to a channel, select “Edit Programme Labels”, then see page 21.
3 External Inputs	Selects equipment connected to your TV. <ul style="list-style-type: none"> • To watch the desired external input, select the input source, then press \oplus. • To assign a label to an external input, select “Edit Video Labels”, then see page 19.
4 FM Radio	Listens to the FM Radio (page 15).
5 Settings	Displays the “Settings” menu where most of the advanced settings and adjustments are performed. For details about settings, see page 17 to 23.

Listening to the FM Radio

You are able to listen to the FM radio stations using your TV by connecting an antenna (page 4). FM Radio tuning range is from 87.5-108.0 MHz.

To	Do this
Access to FM Radio mode	Press MENU and select “FM Radio”.
Exit from FM Radio mode	Press MENU, select the desired items: “Programme List” or “External Inputs”, then press \oplus . Select the desired TV channels or external inputs and press \oplus .
Listen to preset stations	<ol style="list-style-type: none"> 1 Access to FM Radio mode. 2 Press MENU and select “Settings”. Preset the desired FM radio stations and its labels in “FM Radio Set-up” from “Channel Set-up” menu (page 23). <ul style="list-style-type: none"> \hookrightarrow • You can also access to “FM Radio Set-up” by selecting “FM Radio Set-up” from the Tools menu in FM Radio mode (page 10). 3 Exit from “Channel Set-up” menu by pressing MENU. The selected preset FM radio station number and label will appear on the screen. To select the desired preset FM radio station, press PROG +/-. \hookrightarrow • You can also use the 1-9 buttons on the remote to directly select the desired preset FM radio station.

Continued

To	Do this
Listen to non-preset stations	<ol style="list-style-type: none"> 1 Access to FM Radio mode. 2 Press \uparrow/\downarrow to automatically search for the desired FM radio station. <ul style="list-style-type: none"> • You can also manually search for the desired FM radio station by pressing \leftarrow/\rightarrow. The available radio frequency is only for temporary listening pleasure and cannot be stored in the memory. • If the message “Please set-up FM Radio.” appears, display the “Channel Set-up” menu and select “FM Radio Set-up” to preset the desired FM radio stations (page 23).
	<ul style="list-style-type: none"> • If the station has a noisy sound, you may be able to improve the sound quality by pressing \leftarrow/\rightarrow. • When a FM stereo programme has static noise, press AUDIO until “Mono” appears. There will be no stereo effect, but the noise will be reduced.

Using the Favourite List

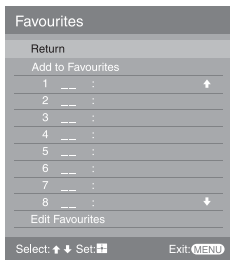

Favourite List

The Favourite feature lets you select programmes from a list of up to 16 favourite channels that you specify.

- 1 Press MENU.
- 2 Press \uparrow/\downarrow to select “Favourites”, then press \oplus .
- 3 Perform the desired operation as shown in the following table or displayed on the screen.

To	Do this
Watch a channel	Press \uparrow/\downarrow to select the channel number, then press \oplus .
Turn off the Favourite list	Press RETURN to return to the previous screen. Press MENU or \heartsuit to exit the menu.
Add a current channel to the Favourite list	Press \uparrow/\downarrow to select “Add to Favourites”, then press \oplus .
Remove a channel from the Favourite list	Press \uparrow/\downarrow to select “Edit Favourites”, then press \oplus . The “Favourite Set-up” screen appears. For details, see “Favourite Set-up” on page 21.

Settings adjustment

You are able to change the settings of your TV from “Settings” menu.

- 1 Press MENU. Press \uparrow/\downarrow to select “Settings”, then press \oplus .
- 2 Press \uparrow/\downarrow to select a menu icon, then press \oplus .
- 3 Press $\uparrow/\downarrow/\leftarrow/\rightarrow$ to select an option or adjust a setting, then press \oplus .

ⓧ • The options you can adjust vary depending on the situation. Unavailable options are greyed out or not displayed.







Picture menu

Picture Mode	Selects the picture mode except for PC input source. “ Vivid ”: For enhanced picture contrast and sharpness. “ Standard ”: For standard picture. Recommended for home entertainment. “ Cinema ”: For optimum picture quality of film videos.
Display Mode (only in PC mode)	Selects the display mode for PC input source. “ Video ”: For video images. “ Text ”: For text, charts or tables.
Reset	Resets all the “Picture” settings except “Picture Mode” and “Display Mode” to the factory settings.
Backlight	Adjusts the brightness of the backlight.
Picture	Increases or decreases picture contrast.
Brightness	Brightens or darkens the picture.
Colour	Increases or decreases colour intensity.
Hue	Increases or decreases the green tones and red tones. ⓧ • “Hue” can only be adjusted for an NTSC colour system (e.g. U.S.A. video tapes).
Colour Temperature	Adjusts the whiteness of the picture. “ Cool ”: Gives the white colours a blue tint. “ Neutral ”: Gives the white colours a neutral tint. “ Warm 1 ”/“ Warm 2 ”: Gives the white colours a red tint. “Warm 2” gives a redder tint than “Warm 1”. ⓧ • “Warm 1” and “Warm 2” are not available when “Picture Mode” is set to “Vivid”.
Sharpness	Sharpens or softens the picture.
Noise Reduction	Reduces the picture noise (snowy picture) in a weak broadcast signal. “ High ”/“ Medium ”/“ Low ”: Modifies the effect of the noise reduction. “ Off ”: Turns off the “Noise Reduction” feature.
MPEG Noise Reduction	Reduces the picture noise in MPEG-compressed video. Choose either “High”, “Medium”, “Low” or “Off”.
Advanced Settings	Customises the “Picture” function in more detail. When you set “Picture Mode” to “Standard” or “Cinema”, you can set/change these settings. “ Reset ”: Resets all the advanced settings to the factory settings. “ Adv. Contrast Enhancer ”: Automatically adjusts “Backlight” and “Picture” to the most suitable settings judging from the brightness of the screen. This setting is especially effective for dark images scenes. It will increase the contrast distinction of the darker picture scenes. “ Gamma ”: Adjusts the balance between bright and dark areas of the picture. “ Clear White ”: Emphasises white colours. “ Live Colour ”: Makes colours more vivid.







Sound menu

Sound Mode	<p>“Dynamic”: Enhances treble and bass. Recommended for home entertainment.</p> <p>“Standard”: For standard sound.</p> <p>“Clear Voice”: Makes voice sound clearer.</p>												
Reset	Resets all the “Sound” settings except “Sound Mode” and “Dual Sound” to the factory settings.												
5 Band Equalizer	<p>Adjusts sound frequency settings.</p> <p>1 Make sure that “Adjust” is selected, then press ⊕.</p> <p>Selecting “Reset” will set your TV to the factory settings.</p> <p>2 Press ⇄ to select the desired sound frequency, then press ⇄ to adjust the setting and press ⊕. The adjusted settings will be received when you select “Sound Mode” options.</p> <p>⚠ • Adjusting higher frequency will affect higher pitched sound and adjusting lower frequency will affect lower pitched sound.</p>												
Balance	Emphasises left or right speaker balance.												
Intelligent Volume	Minimizes the difference in volume level between all programmes and adverts (e.g. adverts tend to be louder than programmes).												
Volume Offset	Adjusts the volume level of the current input relative to other inputs.												
Surround	Choose either “On” (surround), “Simulated Stereo” (stereo-like monaural sound) or “Off”.												
Dual Sound	<p>Selects the sound from the speaker for a stereo or bilingual broadcast.</p> <p>The selection varies, depending on the Broadcasting.</p> <table border="1"> <thead> <tr> <th>Broadcasting</th> <th>Selection</th> </tr> </thead> <tbody> <tr> <td>NICAM stereo</td> <td>Stereo (stereo sound)/Mono (regular sound)</td> </tr> <tr> <td>NICAM bilingual</td> <td>Main (main sound)/Sub (sub sound)/Mono (regular sound)</td> </tr> <tr> <td>NICAM monaural</td> <td>Main (main sound)/Mono (regular sound)</td> </tr> <tr> <td>A2 (German) stereo</td> <td>Stereo (stereo sound)/Mono (regular sound)</td> </tr> <tr> <td>A2 (German) bilingual</td> <td>Main (main sound)/Sub (sub sound)</td> </tr> </tbody> </table> <p>⚠ • If the signal is very weak, the sound becomes monaural automatically.</p> <p>• If the stereo sound is noisy when receiving a NICAM programme, select “Mono”. The sound becomes monaural, but the noise is reduced.</p> <p>• The “Dual Sound” setting is memorised for each programme position.</p> <p>• You cannot receive a stereo broadcast signal when “Mono” is selected for the programme position.</p> <p>💡 • If you select other equipment connected to the TV, set “Dual Sound” to “Stereo”, “Main” or “Sub”. However, when the external equipment connected to the HDMI jack is selected, this is fixed to “Stereo”.</p> <p>• If you access to FM Radio mode, set “Dual Sound” to “Stereo” or “Mono”.</p>	Broadcasting	Selection	NICAM stereo	Stereo (stereo sound)/Mono (regular sound)	NICAM bilingual	Main (main sound)/Sub (sub sound)/Mono (regular sound)	NICAM monaural	Main (main sound)/Mono (regular sound)	A2 (German) stereo	Stereo (stereo sound)/Mono (regular sound)	A2 (German) bilingual	Main (main sound)/Sub (sub sound)
Broadcasting	Selection												
NICAM stereo	Stereo (stereo sound)/Mono (regular sound)												
NICAM bilingual	Main (main sound)/Sub (sub sound)/Mono (regular sound)												
NICAM monaural	Main (main sound)/Mono (regular sound)												
A2 (German) stereo	Stereo (stereo sound)/Mono (regular sound)												
A2 (German) bilingual	Main (main sound)/Sub (sub sound)												

Screen menu

Wide Mode	For details about wide mode, see page 10.
Auto Wide	Automatically changes the wide mode according to the input signal from an external equipment. To keep your setting, select “Off”.  • “Auto Wide” is only available when watching programmes from video input, HDMI and component input in format 480i or 576i.  • Even if “Auto Wide” is set to “On” or “Off”, you can always modify the format of the screen by pressing  repeatedly.
4:3 Default	Specifies the default screen mode for use with 4:3 broadcasts. “Wide Zoom” : Displays conventional 4:3 broadcasts with an imitation wide screen effect. “Normal” : Displays conventional 4:3 broadcasts in the correct proportions. “Off” : Keeps the current “Wide Mode” setting when the channel or input is changed.  • “4:3 Default” is available only if “Auto Wide” is set to “On”.
Display Area	Adjusts the screen area for displaying the picture. “Normal” : Displays the picture in the original size. “-1”/“-2” : Enlarges the picture to hide the edge of the picture.
Horizontal Shift	Adjusts the horizontal position of the picture.
Vertical Shift	Adjusts the vertical position of the picture when “Wide Mode” is set to “Zoom”.
Vertical Size	Adjusts the vertical size of the picture when “Wide Mode” is set to “Wide Zoom” or “Zoom”.

Set-up menu

Auto Start-up	Starts the initial set-up procedure. Usually, you do not need to do this operation because it was done when the TV was first installed (page 5). However, this option allows you to repeat the process (e.g. to retune the TV after moving house, or to search for new channels that have been launched by broadcasters).
Language	Selects the language in which the menus are displayed.
AV Set-up	Video Labels Assigns a name to any equipment connected to the side and rear jacks. The name will be displayed briefly on the screen when the equipment is selected. You can skip input signals from connected equipment that you do not want displayed on the screen. 1 Press  /  to select the desired input source, then press  . 2 Press  /  to select the desired option below, then press  . Equipment labels : Uses one of the preset labels to assign a name to connected equipment. “Edit” : Creates your own label. Follow steps 2 to 4 of “Programme Labels” (page 21). “Skip” : Skips an unnecessary input source. Speaker Turns on/off the TV’s internal speakers. “TV Speaker” : The TV speakers are turned on in order to listen to the TV’s sound through the TV speakers. “Audio System” : The TV speakers are turned off in order to listen to the TV’s sound only through your external audio equipment connected to the audio output jacks.  • All items in “Sound” menu except “Dual Sound” are not available when “Speaker” is set to “Audio System”.

Colour System

Selects the colour system (“Auto”, “PAL”, “SECAM”, “NTSC3.58”, “NTSC4.43” or “PAL60”) according to the composite video signal from the input source.

Timer Settings

Sets the timer to turn on/off the TV.

Sleep Timer

Sets the TV to automatically switch to standby mode after a certain amount of time.

- If you turn off the TV and turn it on again, “Sleep Timer” is reset to “Off”.
- A notification message appears on the screen one minute before the TV switches to standby mode.

Wake Up Timer

Sets the desired period of time to turn on the TV from standby mode.

“**Time**”: Sets the desired period of time to turn on the TV.

“**Duration**”: Sets how long you want the TV to stay on before switching to standby mode again.

- When the “Sleep Timer” or “Wake Up Timer” is activated, the ⏰ (Timer) indicator on the TV front panel lights up in amber.

Product Information

Displays your TV’s product information.

Factory Settings

Resets all settings to factory settings other than “Programme Block”, programme preset data and the FM Radio preset data. After completing this process, the initial set-up screen is displayed the next time you turn on the TV. Completing auto tuning in initial set-up will reset these settings. To keep them, select “Cancel” in the auto tuning confirmation dialogue.

- Be sure not to turn the TV off during this period (it takes about 30 seconds) or press any buttons.



PC Settings menu

Wide Mode

Selects a screen mode for displaying input from your PC, see page 10.

“**Normal**”: Displays the picture in its original size.

“**Full 1**”: Enlarges the picture to fill the display area, keeping its original horizontal-to-vertical aspect ratio.

“**Full 2**”: Enlarges the picture to fill the display area.

Reset

Resets all the “PC Settings” except “Wide Mode” to the factory settings.

Auto Adjustment

Automatically adjusts the display position and phase of the picture when the TV receives an input signal from the connected PC.

- “Auto Adjustment” may not work well with certain input signals. In such cases, manually adjust “Phase” and “Horizontal Shift”.

Phase

Adjusts the phase when the screen flickers.

Pitch

Adjusts the pitch when the picture has unwanted vertical stripes.

Horizontal Shift





















Adjusts the horizontal position of the picture.

PC Input Signal Reference Chart for supported signals and “Resolution:” value displayed

Signals	Horizontal (Pixel)	Vertical (Line)	Horizontal frequency (kHz)	Vertical frequency (Hz)	Standard
VGA	640	480	31.5	60	VGA
	640	480	37.5	75	VESA
	720	400	31.5	70	VGA-T
SVGA	800	600	37.9	60	VESA Guidelines
	800	600	46.9	75	VESA
XGA	1024	768	48.4	60	VESA Guidelines
	1024	768	56.5	70	VESA
	1024	768	60	75	VESA
WXGA	1280	768	47.4	60	VESA
	1280	768	47.8	60	VESA
	1360	768	47.7	60	VESA

- This TV's PC input does not support Sync on Green or Composite Sync.
- This TV's PC input does not support interlaced signals.
- If input signal is not shown in above chart, then this signal may not be displayed properly or cannot be displayed according to your settings.
- For the best picture quality, it is recommended to use the signals (boldfaced) in the above chart with a 60 Hz vertical frequency from a personal computer. In plug and play, signals with a 60 Hz vertical frequency will be selected automatically.

Channel Set-up menu

1 Digit Direct	<p>When “1 Digit Direct” is set to “On”, you can select a channel using one preset number button (0 - 9) on the remote.</p> <ul style="list-style-type: none"> • When “1 Digit Direct” is set to “On”, you cannot select channel numbers 10 and above entering next digit using the remote.
Favourite Set-up	<p>Allows you to set your favourite channels by assigning the desired channel numbers.</p> <ol style="list-style-type: none"> 1 Press  to select your favourite channel number, then press . 2 Press  to select your desired channel, then press . <p>To reset the Favourite channels</p> <p>Select “_ _”, then press .</p> <p>Repeat the procedure above to set other favourite channels.</p>
Auto Tuning	<p>Tunes in all the available channels. This option allows you to retune the TV after moving house, or to search for new channels that have been launched by broadcasters.</p>
Programme Sorting	<p>Changes the order in which the channels are stored on the TV.</p> <ol style="list-style-type: none"> 1 Press  to select the channel you want to move to a new position, then press . 2 Press  to select the new position for your channel, then press .
Programme Labels	<p>Assigns a channel name of your choice up to five letters or numbers. The name will be displayed briefly on the screen when the channel is selected.</p> <ol style="list-style-type: none"> 1 Press  to select the channel you want to name, then press . 2 Press  to select the desired letter or number (“_” for a blank space), then press . <p>If you input a wrong character</p> <p>Press  to select the wrong character. Then, press  to select the correct character.</p> <p>To delete all the characters</p> <p>Select “Reset”, then press .</p> <ol style="list-style-type: none"> 3 Repeat the procedure in step 2 until the name is completed. 4 Select “OK”, then press .
Programme Block	<p>Blocks an individual channel from being watched.</p> <ol style="list-style-type: none"> 1 Press  to select the channel you want to block, then press . 2 Press  to select “Block”, then press . To watch the channel, select “Allow”.

Continued

Intelligent Picture

“On with Indicator”: Automatically reduces the picture noise. The signal level bar is displayed when the channel is changed or the display is changed from an input screen to a TV programme.

“On”: Automatically reduces the picture noise.

“Off”: Turns off the “Intelligent Picture” feature.

Manual Programme Preset

Before selecting “Label”/“AFT”/“Skip”/“Colour System”/“Signal Booster”, press PROG +/- to select the programme number with the channel. You cannot select a programme number that is set to “Skip” (page 22).

Programme/TV System/VHF or UHF

Presets programme channels manually.

- 1 Select “Programme”, then press ⊕.
- 2 Press ⬆/⬇ to select the programme number you want to manually tune (if tuning a VCR, select channel 000), then press RETURN.
- 3 Press ⬆/⬇ to select “TV System”, then press ⊕.
- 4 Press ⬆/⬇ to select your TV broadcast systems, then press ⊕.
- 5 Press ⬆/⬇ to go to the frequency range indication (“VHF Low”, “VHF High” or “UHF”), then press ⊕.
- 6 Tune the channels as follows:
Press ⬅/➡ to search for the next available channel. When a channel has been found, the search will stop. To continue searching, press ⬅/➡.
Repeat the procedure above to preset other channels manually.

Label

Assigns a name of your choice, up to five letters or numbers, to the selected channel. This name will be displayed briefly on the screen when the channel is selected. To input characters, follow steps 2 to 4 of “Programme Labels” (page 21).

AFT

Allows you to fine-tune the selected programme number manually if you feel that a slight tuning adjustment will improve the picture quality. You can adjust the fine tuning over a range of -15 to +15. When “On” is selected, the fine tuning is performed automatically.

Skip

Skips unused channels when you press PROG +/- to select channels. (You can still select a skipped channel using the number buttons.)

Colour System

Selects the colour system (“Auto”, “PAL”, “SECAM”, “NTSC3.58”, “NTSC4.43” or “PAL60”) according to the channel.

Signal Booster (Intelligent Signal Booster)

Improves the picture quality if the TV signal is too strong or weak.

Press ⬆/⬇ to select either “Off” if the signal is too strong (picture distorted; picture with lines; signal interference) or “Auto” if the signal is weak (snowy picture), then press ⊕.

Signal Level

Displays the signal level for programme currently being watched.

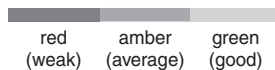

**FM Radio Set-up
(only in FM Radio
mode)**

Preset up to nine FM radio stations. You can manually preset each FM radio station that can be received in your area and then store the radio frequency of the desired FM radio stations.

- 1 Press \uparrow/\downarrow to select the desired FM radio station position, then press \oplus .
 - 2 Press \uparrow/\downarrow to search the FM radio stations. Searching stops automatically when a station is tuned in. If the station has a noisy sound, you may be able to improve the sound quality by pressing \leftarrow/\rightarrow . Press \oplus twice to store the FM radio station.
 - 3 You may edit the FM radio station label. Press \uparrow/\downarrow to select alphanumeric characters for the label, then press \oplus .
 - 4 Repeat steps 1 to 3 to preset other FM radio stations.
-  • To enable this feature, access to FM Radio mode by using MENU (page 15), then preset your desired FM radio stations according to the steps mentioned above.
-

**Eco menu**

Power Saving

Selects the power saving mode to reduce the power consumption of the TV. Choose either “Standard Power” or “Reduced Power”.

Idle TV Standby

Selects the time (“1h”, “2h” or “3h”) to set the TV into standby mode automatically, if you do not operate the TV for the specified period of time.

Installing the Accessories (Wall-Mount Bracket)

To Customers:

For product protection and safety reasons, Sony strongly recommends that installing of your TV be performed by Sony dealers or licensed contractors. Do not attempt to install it yourself.

To Sony Dealers and Contractors:

Provide full attention to safety during the installation, periodic maintenance and examination of this product.

Your TV can be installed using the Wall-Mount Bracket SU-WL500, SU-WL50B or SU-WL100 (sold separately).

- Refer to the Instructions supplied with the Wall-Mount Bracket to properly carry out the installation.
- Refer to “Detaching the Table-Top Stand from the TV” (page 6).
- Refer to “TV installation dimensions table” (page 25).
- Refer to “Screw and Hook locations diagram/table” (page 26).

 • Place the TV on the Table-Top Stand, when securing the Mounting Hook.

SU-WL500:

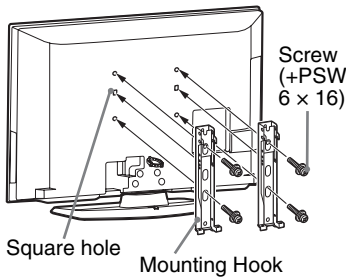

SU-WL50B:

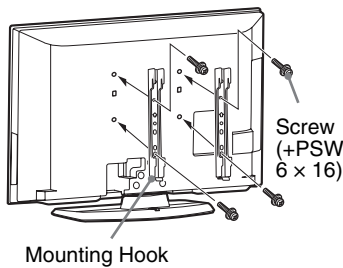

SU-WL100:

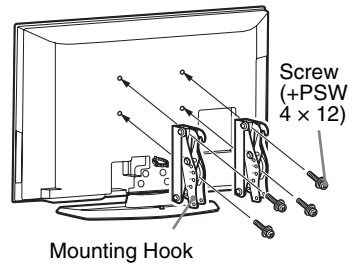

Sufficient expertise is required for installing these products, especially to determine the strength of the wall for withstanding the TV's weight. Be sure to entrust the attachment of these products to the wall to Sony dealers or licensed contractors and pay adequate attention to safety during the installation. Sony is not liable for any damage or injury caused by mishandling or improper installation.

TV installation dimensions table

SU-WL500:

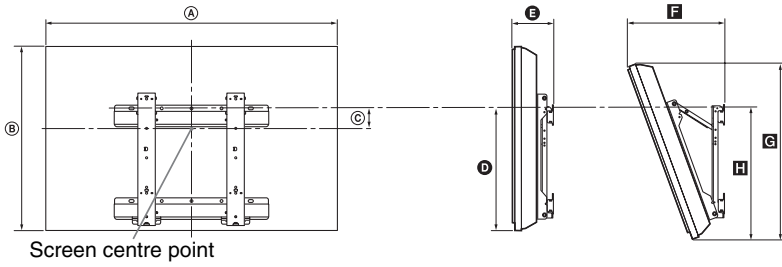

Screen centre point

SU-WL50B:

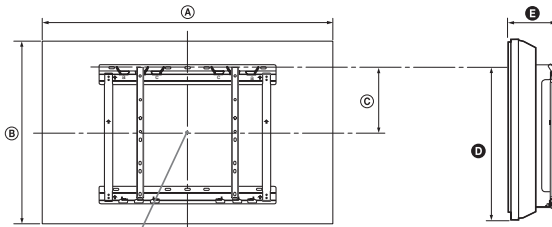

Screen centre point

Unit: mm

Model Name	Display dimensions		Screen centre dimension		Length for each mounting angle						
	A	B	C		Angle (0°)				Angle (20°)		
			SU-WL500	SU-WL50B	D	E	F	G	H		
KLV-37S550A	927	574	140	193	432	484	156	157	324	542	468
KLV-32S550A/ KLV-32S530A	807	508	172	200	430	458	154	155	300	485	466

SU-WL100:

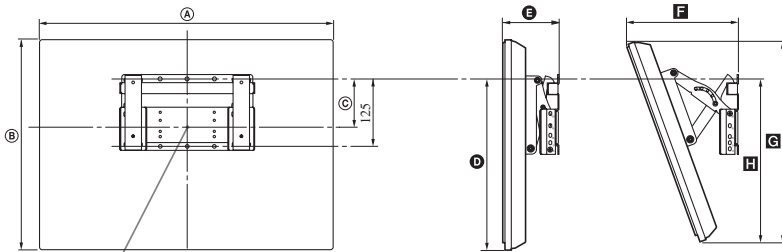

Screen centre point

Unit: mm

Model Name	Display dimensions		Screen centre dimension		Length for each mounting angle						
	A	B	C		Angle (0°)				Angle (20°)		
			D	E	F	G	H				
KLV-26S550A	679	435	98		318	154	258	411	323		

Figures in the above table may differ slightly depending on the installation.

WARNING

The wall that the TV will be installed on should be capable of supporting a weight of at least four times that of the TV. Refer to “Specifications” for its weight.

Continued

Additional Information

Screw and Hook locations diagram/table

Screw location - When installing the Mounting Hook on the TV.

SU-WL500

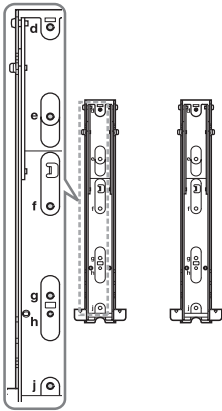

SU-WL50B

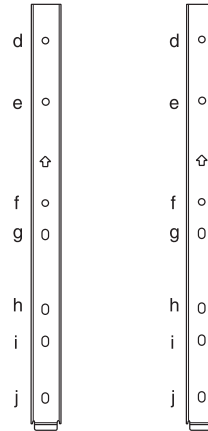

Hook location - When installing the TV onto the Base Bracket.

SU-WL500

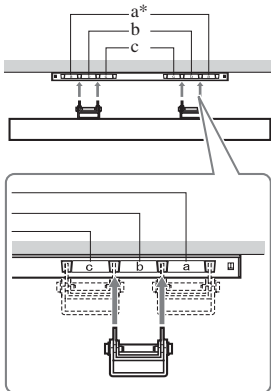

SU-WL50B

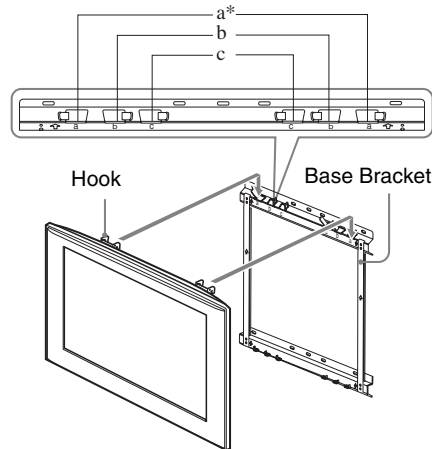

SU-WL100

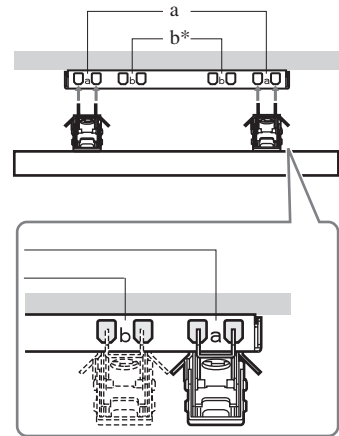

* Hook location "a" cannot be used for the models in the table below.

* Hook location "a" cannot be used for the models in the table below.

* Hook location "b" cannot be used for the models in the table below.

Model Name	Screw location		Hook location	
	SU-WL500	SU-WL50B	SU-WL500	SU-WL50B
KLV-37S550A	d, g	d, i	b	
KLV-32S550A/KLV-32S530A	e, g	e, h	c	
			SU-WL100	
KLV-26S550A			a	

Troubleshooting

Check whether the  (standby) indicator is flashing in red.

When it is flashing

The self-diagnosis function is activated.

- 1 Count how many times the  (standby) indicator flashes between each two second break.

For example, the indicator flashes three times, then there is a two second break, followed by another three flashes, etc.



- 2 Press  on the TV to turn it off, disconnect the AC power cord, and inform your dealer or Sony service centre of how the indicator flashes (number of flashes).

When it is not flashing



- 1 Check the items listed below.
- 2 If the problem still persists, have your TV serviced by qualified service personnel.

Picture

No picture (screen is dark) and no sound

- Check the antenna/cable connection.
- Connect the TV to the AC power outlet, and press  on the TV.
- If the  (standby) indicator lights up in red, press .

No picture or no menu information from equipment connected to the video input jack appears on the screen

- Press / to display the connected equipment list, then select the desired input.
- Check the connection between the optional equipment and the TV.

Double images or ghosting

- Check the antenna/cable connection.
- Check the antenna/cable location and direction.

Only snow and noise appear on the screen

- Check if the antenna is broken or bent.
- Check if the antenna has reached the end of its serviceable life (three to five years in normal use, one to two years at the seaside).

Distorted picture (dotted lines or stripes)

- Keep the TV away from electrical noise sources such as cars, motorcycles, hair-dryers or optional equipment.
- When installing optional equipment, leave some space between the optional equipment and the TV.
- Check the antenna/cable connection.
- Keep the antenna cable away from other connecting cables.

Picture or sound noise when viewing a TV channel

- Adjust “AFT” (Automatic Fine Tuning) to obtain better picture reception (page 22).

Some tiny black points and/or bright points appear on the screen

- The picture of a display unit is composed of pixels. Tiny black points and/or bright points (pixels) on the screen do not indicate a malfunction.

No colour on programmes



- Select “Reset” (page 17).

No colour or irregular colour when viewing a signal from the Y, P_B/C_B, P_R/C_R jacks of

- Check the connection of the Y, P_B/C_B, P_R/C_R jacks of  and check if each jacks are firmly seated in their respective jacks.

Sound

No sound, but good picture

- Press  +/- or  (Mute).
- Check if the “Speaker” is set to “TV Speaker” (page 19).

General

The TV turns off automatically (the TV enters standby mode)

- Check if the “Sleep Timer” is activated, or confirm the “Duration” setting of “Wake Up Timer” (page 20).
- Check if the “Idle TV Standby” is activated (page 23).

The TV turns on automatically

- Check if the “Wake Up Timer” is activated (page 20).









Some input sources cannot be selected

- Select “Video Labels” and cancel “Skip” of the input source (page 19).

The remote does not function

- Replace the batteries.

Specifications

Model name	KLV-37S550A	KLV-32S550A	KLV-32S530A	KLV-26S550A	
System					
Panel System	LCD (Liquid Crystal Display) Panel				
TV System	B/G, I, D/K, M				
Colour System	PAL, PAL60, SECAM, NTSC4.43, NTSC3.58				
Channel Coverage	B/G: VHF: E2 to E12/ UHF: E21 to E69/ CATV: S01 to S03, S1 to S41 VHF: 1 to 11/UHF: 21 to 69/ CATV: S01 to S03, S1 to S41 (New Zealand only) I: UHF: B21 to B69/ CATV: S01 to S03, S1 to S41 D/K: VHF: C1 to C12, R1 to R12/ UHF: C13 to C57, R21 to R60/ CATV: S01 to S03, S1 to S41, Z1 to Z39 M: VHF: A2 to A13/ UHF: A14 to A79/ CATV: A-8 to A-2, A to W+4, W+6 to W+84				
Sound Output	10 W + 10 W			8 W + 8 W	
Input/Output jacks					
Antenna	75 ohm external terminal				
 1, 2	Video input (phono jack)				
 1, 2	Audio input (phono jacks): 500 mVrms, Impedance: 47 kilohms				
	Supported formats: 1080p (50/60 Hz), 1080i (50/60 Hz), 720p (50/60 Hz), 576p, 576i, 480p, 480i Y: 1 Vp-p, 75 ohms, 0.3V sync negative/Pb/Cb: 0.7 Vp-p, 75 ohms/Pr/Cr: 0.7 Vp-p, 75 ohms				
	Audio input (phono jacks): 500 mVrms, Impedance: 47 kilohms				
	Video output (phono jack)				
	Audio output (phono jacks)				
HDMI IN (KLV-32S530A) HDMI IN 1, 2 (KLV-37S550A/ KLV-32S550A/KLV-26S550A)	Video: 1080p (50/60 Hz), 1080i (50/60 Hz), 720p (50/60 Hz), 576p, 576i, 480p, 480i				
PC IN  (RGB)	PC Input (D-sub 15-pin) (see page 21) G: 0.7 Vp-p, 75 ohms, non Sync on Green/B: 0.7 Vp-p, 75 ohms/ R: 0.7 Vp-p, 75 ohms/HD: 1-5 Vp-p/VD: 1-5 Vp-p				
PC IN 	PC audio input (minijack)				
	Headphones jack				
Power and others					
Power Requirements	110–240 V AC, 50/60 Hz 220–240 V AC, 50/60 Hz (New Zealand and Tunisia only)				
Screen Size (inches)	37	32		26	
Display Resolution	1,366 pixels (horizontal) × 768 lines (vertical)				
Power Consumption	Indicated on the rear of the TV.				
Dimensions (w × h × d)*	with stand (mm)	927 × 627 × 259	807 × 557 × 222	807 × 557 × 222	679 × 485 × 222
	without stand (mm)	927 × 574 × 103	807 × 508 × 102	807 × 508 × 102	679 × 435 × 101
Mass*	with stand (kg)	16.1	13.1	13.1	10.0
	without stand (kg)	14.3	12.0	12.0	8.7
Optional Accessories	Wall-Mount bracket	SU-WL500 or SU-WL50B		SU-WL100	

* Dimensions and mass are approximate values.

Design and specifications are subject to change without notice.

Instructions on “Installing the Wall-Mount Bracket” are not supplied in the form of a separate leaflet with this TV. These installation instructions are included within this TV’s instructions manual.



Customer support

<http://www.sony-asia.com/support>

Printed on 70% or more recycled paper using VOC (Volatile Organic Compound)-free vegetable oil based ink.



* 4 1 3 0 9 8 5 1 3 * (1)

<http://www.sony.net/>

Printed in Malaysia

Downloaded From TV-Manual.com Manuals