

# SANYO

VIDEO CASSETTE RECORDER

VHR 789E

VIDEO *Plus*

VHS  
PAL NTSC4.43

Hi-Fi

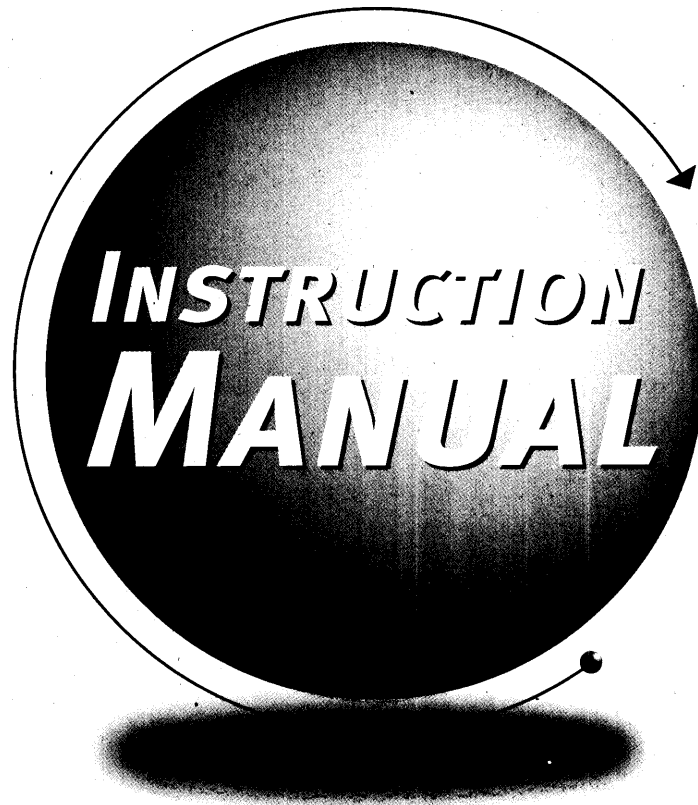

Please read carefully to ensure you get the best from this product.

# ! PRECAUTIONS

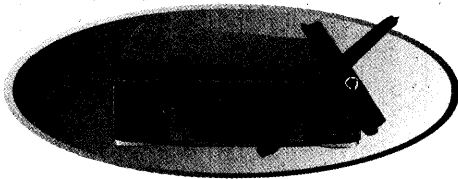

## **DANGER:**

This VCR contains live parts.  
Do not remove the cabinet.

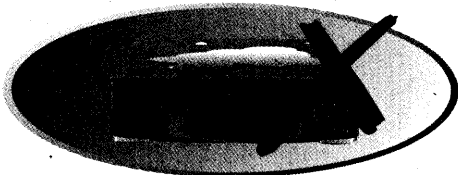

## **WARNING:**

To prevent fire or shock hazard, do not expose this product to rain or moisture.

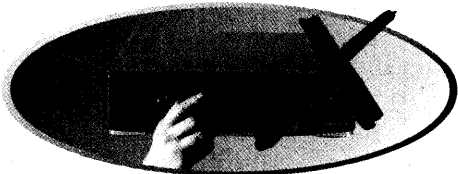

## **CAUTION:**

Do not put your hand or other objects in the cassette loading slot because of the risk of injury or an accident.  
Keep small children away from the VCR.

## **DEW/CONDENSATION CAUTION**

Condensation can form inside the VCR when it is suddenly moved from a cold place to a warm or humid environment.

In any such circumstance do not use this VCR for 1½ to 2 hours allowing complete elimination of any condensation.

## **OPERATING PRECAUTIONS**

- Place the VCR on a flat, stable, level surface. Never subject it to violent shaking or any other shock or impact.
- Do not expose the unit to high temperatures. Excessive heat (heat sources such as heaters, ovens, closed car on hot days, etc.) may damage the unit.
- This VCR should only be used within a temperature range of 5°C to 40°C (41°F to 105°F) and at less than 80% humidity.
- Do not use the unit under the following conditions:
  - in locations with high humidity
  - in presence of excessive dirt or dust
  - in areas subject to strong vibrations
  - near strong magnetic fields (e.g. transmitting antennas, motors, fluorescent lights, etc.)
- Do not stack anything on top of your VCR, or block the air vents, to prevent overheating or damage.
- Do not place anything, except VHS video cassette tapes, in the unit.
- Do not allow rain, steam, dew, salt water, sand, oily smoke, metal objects, etc. to enter the unit.
- Clean with a dry and soft cloth, or soft cloth slightly moistened with a mild detergent solution.
- Do not use any type of solvent, such as alcohol or benzene.

## **POWER ON/STANDBY MODE**

Power is switched on/off by pressing the  $\odot$ /I button.

VCR display:	Standby mode	Power on mode

"Standby mode" is the condition in which only the time is displayed.

- Do not forget that even in the power off state there is an electrical voltage inside the VCR as long as it is connected to a wall socket.
- Disconnect the mains lead from the wall socket if the VCR is not to be used for a long time.

Note: Only video cassette tapes marked **VHS** can be used with this VCR.

Note: If the unit does not operate properly, switch it off, refer to "TROUBLE SHOOTING" (see page 34) or contact your Sanyo authorised service agent.

# CONTENTS

● <b>CONTROLS</b>	1 - 2
● <b>PLUG &amp; PLAY - CONNECTIONS</b>	3 - 4
● <b>PLUG &amp; PLAY - AUTO SETUP</b>	5 - 8
A-USING SCART CONNECTIONS	
B-USING AERIAL OUTPUT CABLE CONNECTIONS	
● <b>RF OUTPUT CHANNEL ADJUSTMENT</b>	9
● <b>ADDITIONAL TUNING</b>	10 - 11
SORTING TV STATIONS & FINE TUNING	
MANUAL TUNING & SKIP FUNCTION	
● <b>VCR PRESETTING</b>	12
AUTO & MANUAL CLOCK ADJUSTMENT	
● <b>FUNCTION SETUP</b>	13
CHILDLOCK	
● <b>PLAYBACK</b>	14 - 18
VARIABLE PLAYBACK MODES	
NTSC TAPE PLAYBACK	
PICTURE ADJUSTMENTS	
ENDLESS PLAY & REMAINING TAPE DURATION FUNCTION	
RETURN TO ZERO & INDEX SEARCH	
● <b>RECORDING TV PROGRAMMES</b>	19 - 20
SETTING THE RECORDING TYPE	
QUICK START RECORDING	
● <b>TIMER RECORDING USING VIDEO PLUS+</b>	21 - 22
● <b>MANUAL ON-SCREEN TIMER RECORDING</b>	23 - 24
● <b>TIMER RECORDING WITHOUT THE REMOTE</b>	25
● <b>RECORDING FUNCTIONS</b>	26
JUST REC. & PDC FUNCTION	
● <b>TAPE LIBRARY DELUXE SYSTEM</b>	27 - 31
TIMER RECORDING & AUTOMATIC PLAYBACK	
● <b>TAPE COPYING</b>	32
● <b>ERROR MESSAGES GUIDE</b>	33
● <b>TROUBLE SHOOTING</b>	34
● <b>RF OUTPUT DEACTIVATION</b>	35
● <b>SPECIFICATIONS</b>	36

## ACCESSORIES



Aerial output cable



Mains lead



Remote control



2 AA (IEC R6) size,  
1.5-volt batteries

## INSERTING THE BATTERIES



1

## CONTROLS

### VCR FRONT PANEL

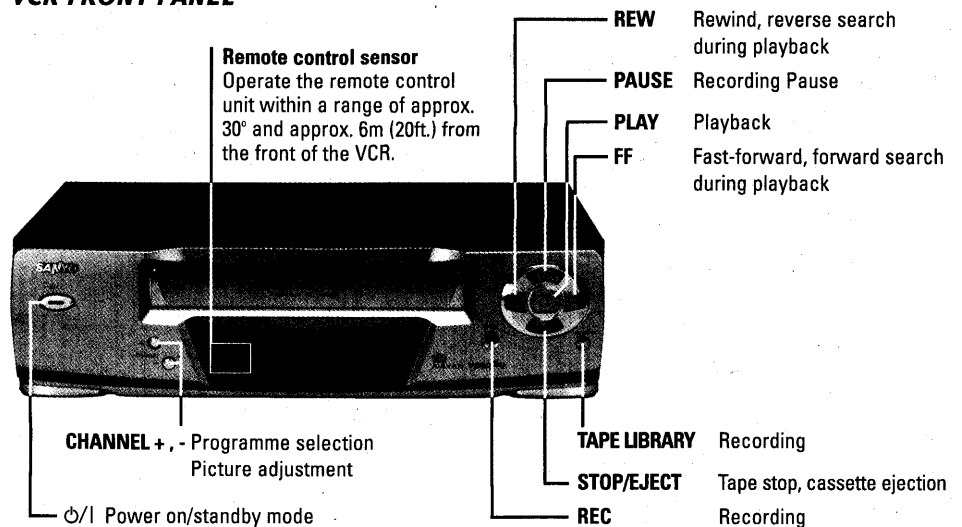

### BUTTON ILLUMINATION MODE

The VCR function buttons, indicated here, will illuminate in stop mode (Cassette in). Individual or combinations of these buttons will illuminate when pressed.

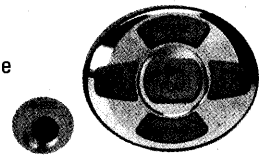

### ENERGY SAVING ECO MODE

The ECO mode reduces the electricity consumption by turning off the VCR display and other components while the VCR is in standby mode.

#### To set the ECO mode:

1. Press the ⏻/⏷ button to switch the VCR to standby mode.
2. Press and hold the ⏻/⏷ button for more than 3 seconds.
  - The ECO mode indicator will light up.
  - The VCR display will be blank.
  - ECO mode is cancelled when the VCR is turned on.

#### NOTES:

- When a timer recording is programmed the ECO mode cannot be set.
- When watching TV, do not set the ECO mode. If the ECO mode is set, the aerial output from the VCR will deteriorate giving very poor TV reception.

## REMOTE CONTROL

<b>VIDEO Plus+</b>	VIDEO Plus+ programme timer setting
<b>SLOW</b>	Slow motion
<b>x2</b>	Double speed playback
<b>MENU/TV</b>	On-screen menu operation
<b>TYPE</b>	Recording type setting
<b>DISPLAY</b>	Programme position, day/time display
<b>SP/LP</b>	Recording tape speed selection
<b>REMAIN</b>	Tape remaining time
<b>RESET</b>	Counter reset
<b>→0←</b>	Counter zero ("0:00:00") return
<b>PDC/DPC Plus</b>	Programme Delivery Control on/off Digital Picture Control on/off
<b>AUDIO</b>	Sound track selection

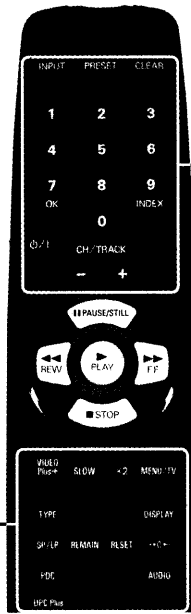

<b>INPUT</b>	External input mode selection
<b>PRESET</b>	Tuner preset
<b>CLEAR</b>	Clears data
<b>0 - 9</b>	Direct programme selection, various input
<b>OK</b>	Data/settings entry
<b>INDEX</b>	Index search
<b>⏻/⏷</b>	Power on/standby mode
<b>CH/TRACK +, -</b>	Tuning, programme selection, tracking adjustment
<b>REC</b>	Recording

### VCR DISPLAY



DISPLAY	MODE
	CASSETTE IN
	PLAYBACK, X2 PLAYBACK
	FORWARD SEARCH, SLOW MOTION
	FAST-FORWARD
	REWIND
	REVERSE SEARCH
	STILL PICTURE
<b>REC</b>	RECORD
<b>REC II</b>	RECORD PAUSE
	TIMER ON
<b>1-88</b>	PROGRAMME POSITION NUMBER
<b>L1</b>	EXTERNAL INPUT (EURO-AV1)
<b>L2</b>	EXTERNAL INPUT (EURO-AV2)
<b>LP, EP</b>	TAPE SPEED

### TV SCREEN DISPLAY

When pressing the buttons shown below, the mode is displayed on-screen for 2 seconds.

#### TAPE MODE

	PLAYBACK
	FAST-FORWARD
	REWIND
	RECORDING
	RECORDING PAUSE
<b>▶▶ 0:00:00 ◀◀</b>	RETURN TO ZERO DISPLAYED IN CENTRE OF SCREEN

#### PROGRAMME POSITION MODE

<b>01-88</b>	PROGRAMME POSITION NUMBER
<b>L1</b>	EXTERNAL INPUT (EURO-AV1)
<b>L2</b>	EXTERNAL INPUT (EURO-AV2)

#### ERROR MESSAGE

If you make an error when controlling the VCR, warning messages indicating the problem are displayed for about 3 seconds. See page 33 for details.

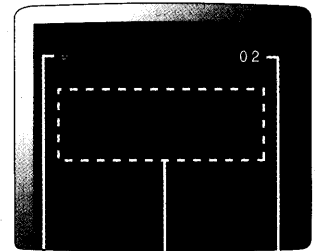

Error message

Tape mode

Programme position mode



# PLUG & PLAY - CONNECTIONS

Connect all your equipment together according to the illustrations shown in this section. Be sure you have all leads and remote control batteries correctly installed before proceeding to the next section.

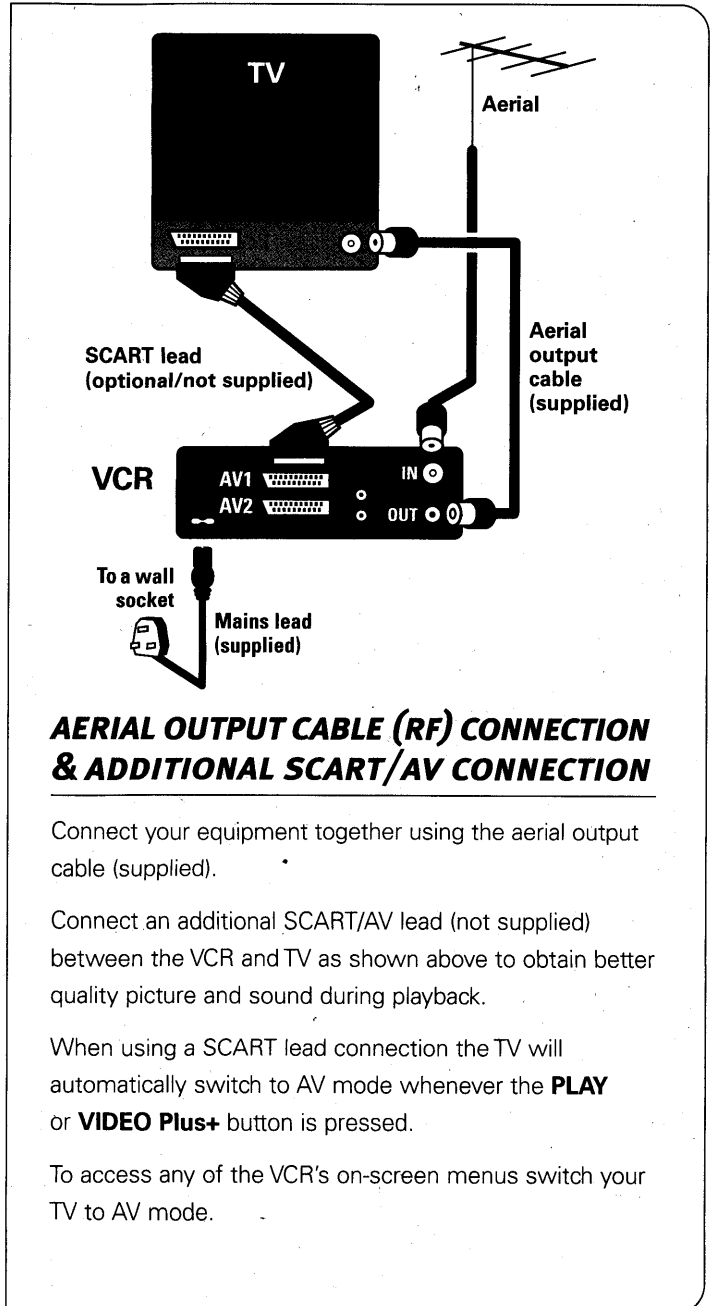

## MAINS LEAD CONNECTIONS

- If the plug supplied with this appliance is not suitable for the wall socket in your home, it should be cut off and the correct type fitted.

The wires in the mains lead are coloured according to the following code:

**Blue: Neutral**                      **Brown: Live**

If the colours of the wires do not correspond with the colour markings identifying the terminals in your plug, proceed as follows.

- The wire which is coloured blue must be connected to the terminal which is marked with the letter **N** or coloured **blue** or **black**.
- The wire which is coloured brown must be connected to the terminal which is marked with the letter **L** or coloured **brown** or **red**.

## DISPOSAL OF PLUG

If the non rewirable plug is to be cut off, the removed plug should be disposed of carefully as there is a shock hazard should the plug be inserted into a live socket.

## REPLACING THE FUSE

The detachable fuse cover must be replaced after changing the fuse. Only a 3A fuse should be used, it should comply with BS1362, and should carry the ASTA mark.

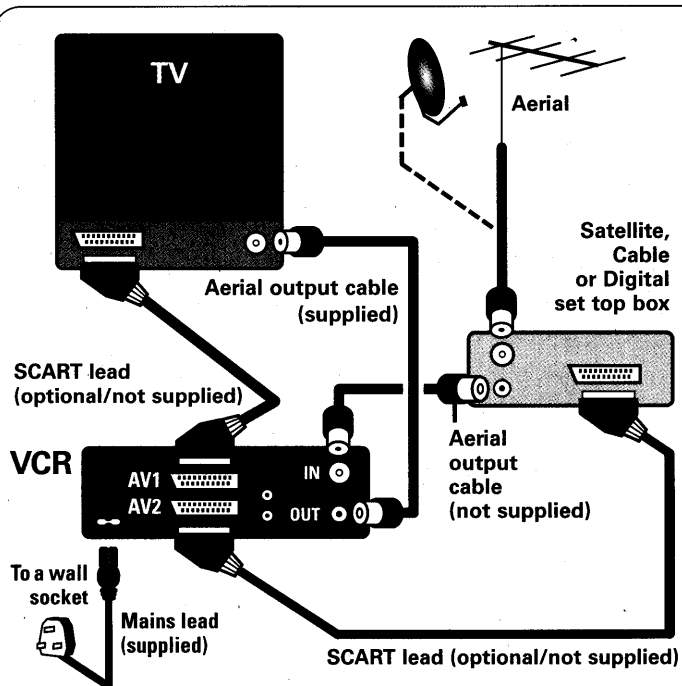

### **SATELLITE, CABLE OR DIGITAL SET TOP BOX CONNECTION**

Connect your satellite, cable or digital set top box receiver as shown above.

If you have connected a standard satellite or cable box, switch the unit on and select SKY1. The programme will then be stored in programme position number 6 during the Auto Setup procedure.

Due to the digital broadcast signal being different to terrestrial analogue broadcast signals, the VCR will not be able to store the signal from your set top box during the Auto setup process.

Please refer to your satellite/cable/digital instructions for detailed information on connection.

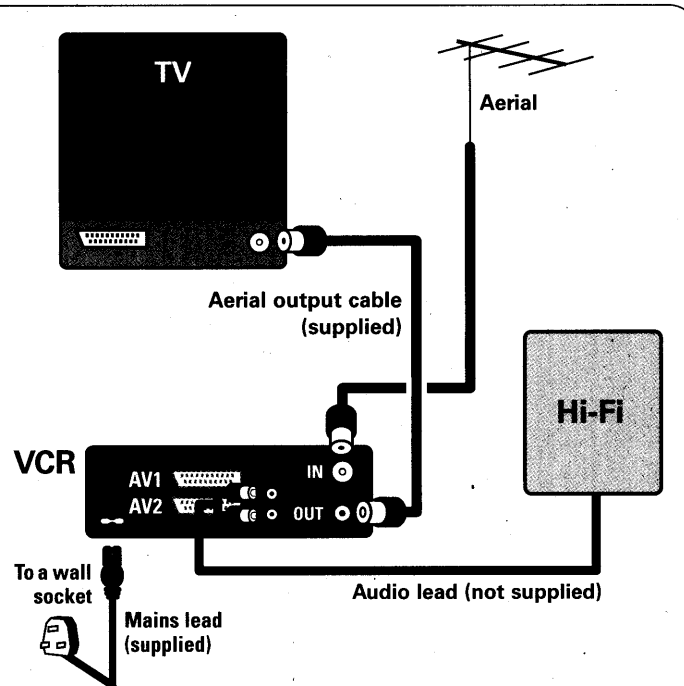

### **HI-FI CONNECTION**

Connecting your Hi-Fi to the VCR as shown above you can obtain a dynamic sound output when you playback a tape recorded in Hi-Fi stereo on this VCR.

Please refer to your Hi-Fi instructions for connection lead details.

# PLUG & PLAY - AUTO SETUP

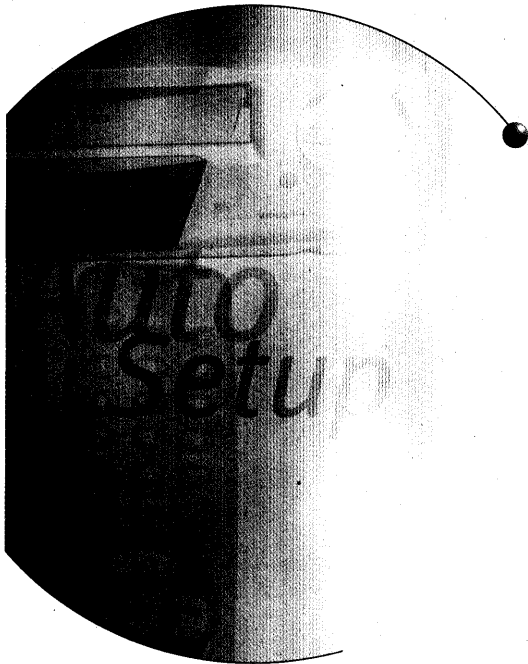

This VCR is equipped with a Plug & Play function, which automatically enters necessary settings before the VCR is used for the first time. The following settings will be set:

## **AUTO TUNING**

The VCR will automatically search and preset all available TV stations in the area of use to programme position numbers (1 to 88).

## **AUTO SORTING OF THE TV STATIONS**

The TV stations available in your area will be automatically sorted and placed in order starting from programme position number "1" to programme position number "6", as follows:

Programme Position	1	2	3	4	5	6
TV Station	BBC1	BBC2	ITV	C4	*CH5	*1 or *SKY1

\*CH5, if available in your area.

\*1, for areas where there is a satellite broadcasting service, the TV station with the lowest frequency will be preset to this programme position. (select SKY1 on the Satellite/Cable box).

\*SKY1, to ensure that your satellite receiver is preset to programme position number 6 during AUTO SETUP, make sure it is switched on and that SKY1 is selected.

## **AUTO RF OUTPUT/VIDEO CHANNEL SETTING**

The VCR will automatically search for an available channel location between (21 - 69) to set the video output channel for RF connection.

## **AUTO CLOCK SETTING**

The date and time on the VCR will be set automatically.

Every Sunday at 3am or 6am the clock is checked and adjusted, therefore the manual setting of summer/standard time is not necessary.

### **NOTES ON AUTO SETUP:**

- Do not press any buttons or controls during the AUTO SETUP process.
- The process is not possible if the VCR is set to external input mode.
- The skip function will automatically be set for all programme position numbers where no TV station has been preset.
- Due to possible changes made by broadcasts, TV stations may not always be sorted in the correct order (e.g. BBC1 may be set to programme position 7 or higher).



# A AUTO SETUP

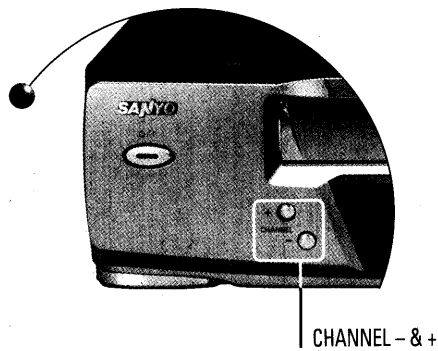
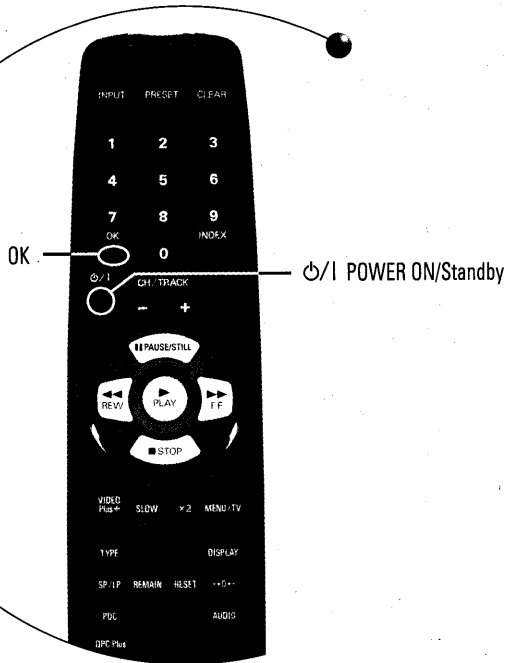

## SCART CONNECTIONS:

The TV will automatically switch to show a VCR tape picture in playback mode. To access any of the VCR's on-screen menus switch the TV to AV mode.

## SCART CONNECTOR USERS ONLY

If you have connected your equipment using only the supplied aerial output cable, please go to **AUTO SETUP B** (page 7).

**1** Turn on the TV and set it to AV mode.

**2** Press the  $\odot$ /I button.

The message screen is displayed for about 5 seconds.

- If this does not appear, or "NO SIGNAL" appears press both **CHANNEL (+, -)** buttons **on the VCR** for at least 3 seconds.

- The **AUTO SETUP** process will start automatically and may take a few minutes. Please be patient.

- When the **AUTO SETUP** process is complete, press the **OK** button.

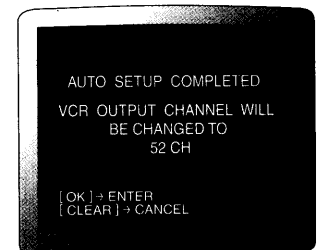
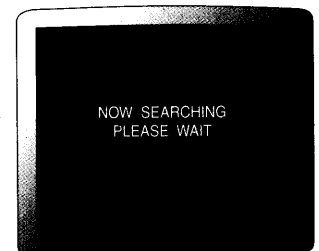

This completes the initial setup of your VCR. You do not need to complete Auto setup B on pages 7 & 8.

Please read carefully through the rest of this manual to find out about the features and functions that this VCR incorporates.

# B AUTO SETUP

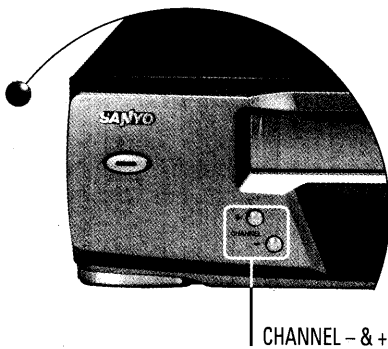
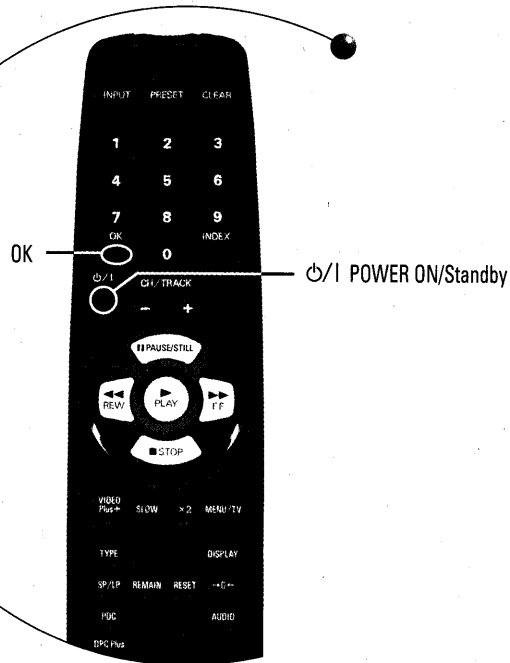

## NOTE:

The RF output numbers you see on your VCR display may differ from those shown, depending on the area you live in.

## AERIAL OUTPUT CABLE (RF) CONNECTIONS

Proceed through this section if you have connected your TV to the VCR using just the supplied aerial output cable (RF connection).

Switch off your TV as you will only be using the VCR display for the moment.

- 1 Press the  $\phi$ /I button.  
**AUTO SETUP** will start automatically.  
The VCR display will show...



If this does not appear, press both **CHANNEL (+ and -)** buttons on the **VCR** for at least 3 seconds.

**The Auto setup process will take a few minutes, please be patient.**

- 2 When the **AUTO SETUP** is complete,  
**OK** will flash in the VCR display...



Press the **OK** button.

To complete the initial setup of your VCR you now need to tune your TV to the VCR in order that you can view a video tape in playback. You may use either method illustrated on the opposite page.

# B TUNING THE TV TO THE VCR

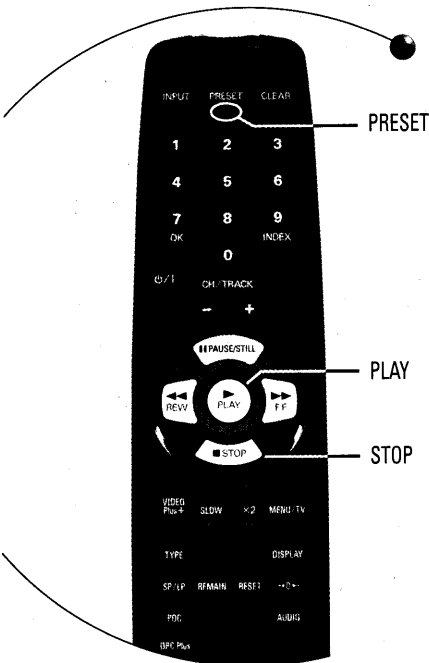

## TUNING THE TV USING THE TEST PATTERN

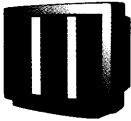
- 1** Turn on your TV.  
Select a spare programme position not currently used, or a specific VCR programme position, (on modern TVs it is normally 0, on older ones 8).
- 2** Make sure the VCR is in standby mode, using the  $\odot$ /I button.
- 3** Press and hold the **PRESET** button for at least 3 seconds.  
The video output channel number (e.g.52) will show in the VCR display...  

- 4** **Tune the TV** until you see the **test screen**, which in this instance is channel 52.  
Refer to your TV instructions for tuning.  

- 5** **STORE** this programme position on your TV.  
Set the TV to this programme position whenever you want to playback a tape.
- 6** Press the **PRESET** button when you have finished.  
The VCR will return to standby mode.

### TEST PATTERN TUNING NOTES:

TV programmes are broadcast in a similar way to that of radio programmes. To receive a radio station you need to tune the radio to a particular frequency.

For the TV to receive the signal from the VCR you need to tune the TV to a particular output channel. Auto Setup automatically selects a free output channel between 21 & 69.

When tuning, you are searching on the TV tuner for the output channel signal from the VCR. In this example it is channel 52.

### TV TUNER EXAMPLE

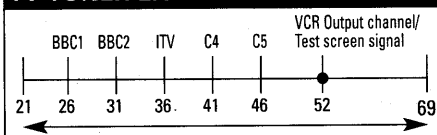

## TUNING THE TV TO THE VCR USING A TAPE

- 1** Turn on your TV.  
Select a spare programme position not currently used, or a specific VCR programme position, (on modern TVs it is normally 0, on older ones 8).
- 2** Insert a prerecorded video cassette and press **PLAY** to playback the tape.
- 3** **Tune the TV** until you see the **picture from the video tape**.  
Refer to your TV instructions for tuning.  

- 4** **STORE** this programme position on your TV.  
Set the TV to this programme position whenever you want to playback a tape.
- 5** Press **STOP** when you have finished.

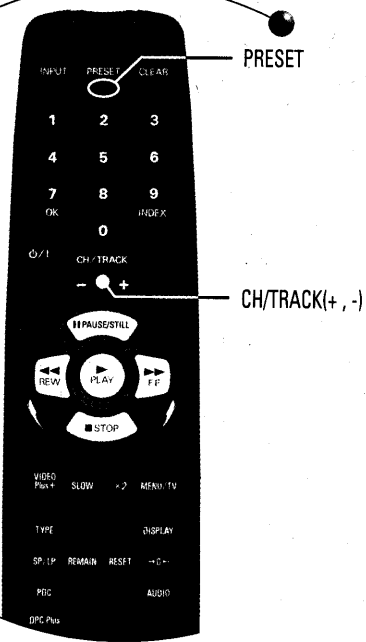
# RF OUTPUT CHANNEL ADJUSTMENT



Proceed through this section if you are having trouble tuning the TV to the VCR. This may be due to the area you live, whereby the Auto Setup has selected an available output channel but a TV station output channel is clashing with it.

To change the RF output channel follow the steps below:

- 1 Switch the VCR to standby mode.
- 2 Press and hold the **PRESET** button for at least 3 seconds. The VCR display will show the current RF output channel number. e.g...
 

LR  
21 RF
- 3 Enter a new number between 21 & 69 using the **NUMBER BUTTONS** or use the **CH/TRACK (+, -)** button to change the current number, e.g...
 

LR  
52 RF
- 4 Turn on your TV and select a spare programme position not currently used, or a specific VCR programme position, (on modern TVs it is normally 0, on older ones 8).
- 5 **Tune the TV** until you see the **test screen**.
 

Refer to your TV instructions for tuning.
- 6 **STORE** this programme position on your TV. Set the TV to this programme position whenever you want to playback a tape.
- 7 Press the **PRESET** button to return the VCR to standby mode.

# ADDITIONAL TUNING

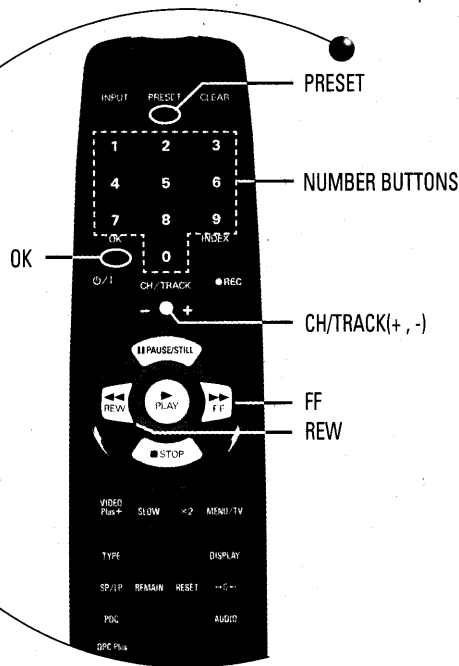

## **SORTING TV STATIONS NOTE:**

During this process the VCR display will show your selections and entry of new settings.

## **SORTING THE TV STATIONS**

This section shows you how to sort the TV stations into an order you desire.

EXAMPLE: You wish to change BBC1 from programme position 7 to programme position 1.

Programme position	1	2	3	4	5	6	7
<b>Before</b>	--	BBC2	ITV	C4	C5	SKY	BBC1
<b>After</b>	BBC1	BBC2	ITV	C4	C5	SKY	--

- 1** Turn on the TV and select the video programme position or switch to AV mode if you are using scart connections.
- 2** Press the **PRESET** button.
- 3** Using the **CH/TRACK(+, -)** button select the TV station you wish to move. In this instance BBC1, which is currently at programme position 7.
- 4** Using the **NUMBER BUTTONS** enter the target programme position. In this example, number 01 is entered.
- 5** Press the **OK** button to activate the change.  
If you wish to sort another TV station, repeat from step 3.
- 6** Press the **PRESET** button when you have finished.

## **FINE TUNING THE PICTURE**

If the tuning is not optimum, it can be improved by manual fine tuning.

- 1** Press the **PRESET** button.
- 2** Use the **FF** or **REW** buttons to obtain the best possible picture and sound.
- 3** Press the **OK** button when you are satisfied.
- 4** Press the **PRESET** button when you have finished.

# ADDITIONAL TUNING

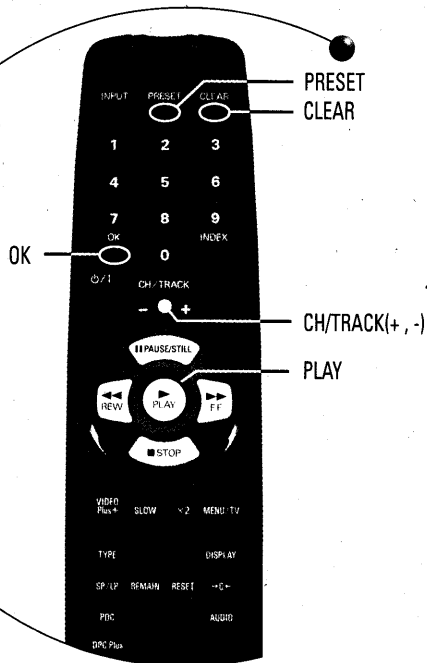

## MANUAL TUNING

This section shows you how to manually preset TV stations.

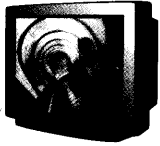
- 1** Press the **PRESET** button.
- 2** Using the **CH/TRACK(+, -)** button select the desired programme position number you wish to tune a TV station to.
- 3** Press the **PLAY** button to start the tuning process. If the search stops on a broadcast other than the one desired, press the **PLAY** button again until the desired broadcast appears on the TV screen. 
- 4** Press the **OK** button to set the TV station to the programme position. If you wish to tune another TV station, repeat steps **2** to **4**.
- 5** Press the **PRESET** button when you have finished.

## SKIP FUNCTION

This function enables you to skip programme position numbers which have been preset so that they do not appear when pressing the **CH(+, -)** button.

- 1** Press the **PRESET** button.
- 2** Using the **CH/TRACK(+, -)** button, select the desired programme position number you wish to skip.
- 3** Press the **CLEAR** button to activate the skip function. The "5" indicator will light. To cancel the skip function, press the **CLEAR** button again to erase the "5" indicator. 
- 4** Press the **OK** button.  
Repeat steps **2** to **4** for every programme position number you wish to skip.
- 5** Press the **PRESET** button when you have finished.

# VCR PRESETTING

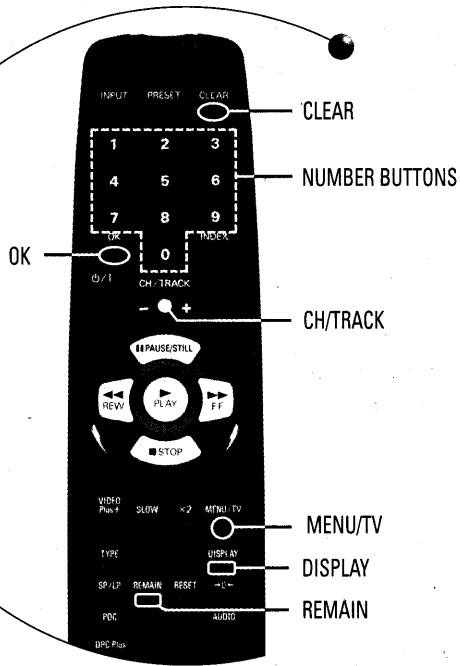

## NOTES ON THE YEAR DISPLAY:

- The year is displayed on screen in full, however, to set the year you only need to enter the last two digits.
- The year 2000 is set by entering "00".
- For a single digit number, first press the "0" NUMBER BUTTON, then the desired number.

## CLOCK ADJUSTMENT NOTES:

- When the ECO mode is set, the Auto clock adjustment will not operate.

## AUTO CLOCK ADJUSTMENT SETTING

- 1 Press the **MENU/TV** button.  
Select **CLOCK SET** using the **CH/TRACK(+, -)** button.  
Press the **OK** button.

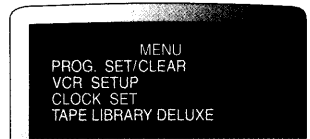

- 2 Press the **DISPLAY** button to select the desired setting, then press the **OK** button.  
The mode is set when the symbol "•" is to the left of the selected setting.

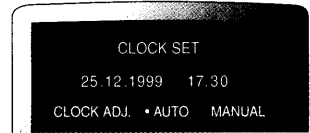

**AUTO:** The clock is adjusted automatically every Sunday at 3am or 6am.

The setting of summer/standard time is not required.

**MANUAL:** The clock is not adjusted automatically.

## MANUAL CLOCK ADJUSTMENT

- 1 Follow step 1 above to display the **CLOCK SET** menu.
- 2 Press the **DISPLAY** button to select **MANUAL**.
- 3 **Adjusting the clock**  
Press the **CLEAR** button to delete incorrect numbers.  
Enter the new settings using the **NUMBER BUTTONS**.
- 4 **Adjusting Summer/Standard time settings.**  
Pressing the **CH/TRACK(+, -)** button will advance or decrease the clock by one hour.
- 5 Press the **OK** button when you have finished.
  - The seconds will start counting from "00" as you press **OK**.
  - The normal TV broadcast will return.

# FUNCTION SETUP

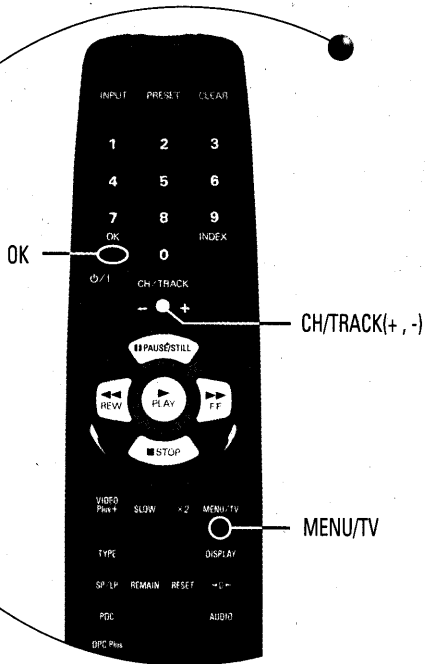

- 1 Press the **MENU/TV** button.  
Select VCR SETUP using the **CH/TRACK(+, -)** button.

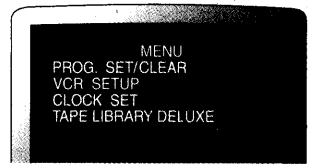

Press the **OK** button to enter menu.

- 2 Press the **CH/TRACK(+, -)** button, to select the desired function to set.

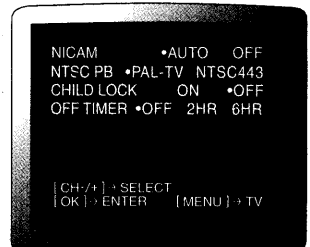

Use the **OK** button to activate the required setting.

### NICAM Broadcasts settings

**AUTO:** To record NICAM stereo broadcasts and bilingual broadcasts.

**OFF:** To record the normal FM mono sound only.

### NTSC playback system

**PAL TV:** When using a PAL(I) system TV.

**NTSC443:** When using an NTSC4.43 system TV. Please use the EURO-AV terminal.

### Child lock function

**ON:** "BLOCKED" is displayed on the TV screen and sound is muted.

**OFF:** Function is not engaged.

### Off timer

Auto power off setting. The VCR will be turned off automatically if it is not used for a programmed period time. (The auto power off delay is timed after any VCR action or operation).

**OFF:** Not active.

**2HR:** The VCR will go off after 2 hours.

**6HR:** The VCR will go off after 6 hours.

- 3 Press the **MENU/TV** button when you have finished.

### POWER INTERRUPTION:

If the power to the VCR has failed or been disconnected for more than one hour, the date, time, function setup memory and any other timer recording data entered should be reset.

The Auto clock setting function will reset the date and time when the power is restored to the VCR.

The tuner preset memory will not be erased, so retuning TV stations is not necessary.



# PLAYBACK

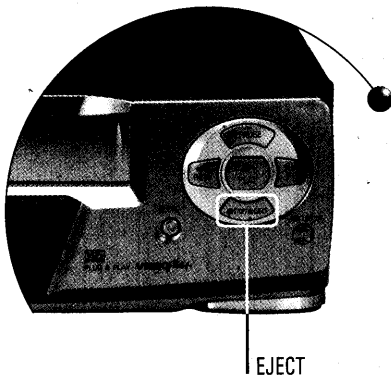
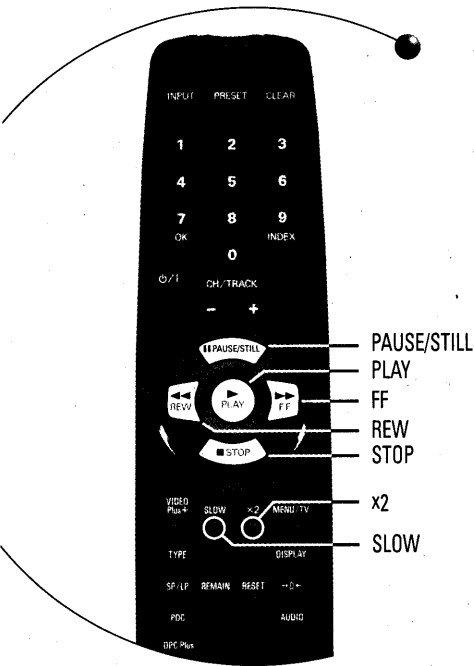

**1** Turn on your TV and select the video programme position.  
If you are using **SCART** connections the TV will automatically switch to show a VCR tape picture during playback mode.

**2** Insert a recorded video cassette.  
Gently push the centre of the cassette until it loads automatically.

**▶ PLAY**  
Press the **PLAY** button.

**■ STOP**  
Press the **STOP** button.

**▲ EJECT**  
Press the **EJECT** button on the VCR.

**◀◀ REWIND**  
Press the **REW** button during **Stop** or **Reverse Search** mode.

**▶▶ FAST-FORWARD**  
Press the **FF** button during **Stop** or **Forward Search** mode.

## VARIABLE PLAYBACK MODES

**x2 DOUBLE SPEED PLAYBACK**  
Press the **X2** during normal playback.

**▶▶ FORWARD SEARCH**  
Press the **FF** button during playback or fast-forward mode.

**◀◀ REVERSE SEARCH**  
Press the **REW** button during playback or rewind mode.

**|| STILL PICTURE**  
Press the **PAUSE/STILL** button during normal playback.

**|| FRAME ADVANCE**  
Press the **PAUSE/STILL** button during still picture.

**SLOW SLOW MOTION**  
Press the **SLOW** button during normal playback or during still picture.  
The tape speed can be set at 1/5 or 1/30 of normal speed.



# PLAYBACK



ERASURE PREVENTION TAB.  
BREAK TAB TO PREVENT  
ACCIDENTAL ERASURE.  
COVER WITH VINYL TAPE IF  
YOU WISH TO RECORD OVER.

### NTSC TAPE NOTES:

- A NTSC tape cannot be copied normally.
- When a NTSC Hi-Fi tape is played back, only monaural sound will be heard.

## VIDEO CASSETTE TAPE FUNCTIONS

This section details the various functions and operations regarding cassette tapes. Please note that only video cassette tapes marked **VHS** can be used with this VCR.

### AUTO POWER ON

The power is automatically switched on as a cassette is inserted while the VCR is in standby mode.

### AUTO PLAY

The VCR will automatically playback a tape when inserted, whose erasure prevention tab has been removed.

### AUTO EJECT

When a tape without an erasure prevention tab is played to the end it will be rewound and ejected.

### POWER OFF EJECT

A video cassette can still be ejected even when the unit is in standby mode.

## PLAYBACK OF A NTSC TAPE

This VCR can playback a NTSC tape on a PAL (I) or NTSC 4.43 system TV. For NTSC system setting, refer to "FUNCTION SETUP" on page 13.

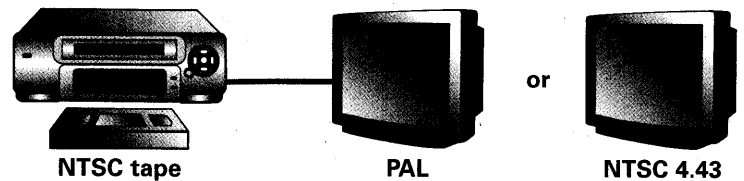

### When playing back a NTSC tape on a PAL TV:

- If the image is unstable, rolling vertically, use the TV vertical hold button to stabilize the image.
- The image may shrink vertically and a black band may appear at the top and bottom of the screen.

# PLAYBACK

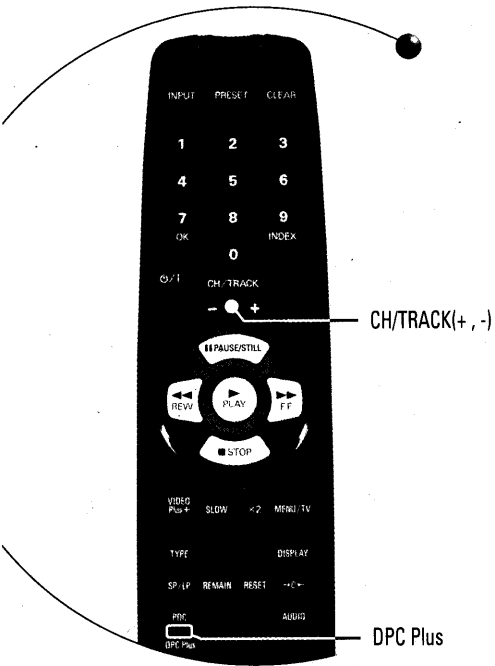

## NOTES:

- During variable playback modes some noise or vibration may occur and cannot be corrected. This is not a malfunction.
- If still picture or slow motion playback is continued for about 5 minutes, the VCR will auto-matically go into stop mode in order to prevent damage to the tape.

## DPC (DIGITAL PICTURE CONTROL) FUNCTION

This function sets the sharpness automatically to give the best possible picture during playback.

- 1 Press the **PDC/DPC Plus** button to activate or deactivate the function.

The DPC Plus mode selected will be displayed on screen for about 3 seconds.

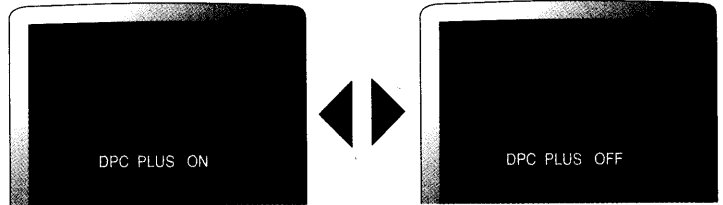

- The DPC Plus mode does not function in variable playback modes.

## PICTURE ADJUSTMENTS

This VCR is equipped with an auto tracking function. During playback of a video tape this function will automatically adjust the tracking to obtain the best possible picture.

- **If there is any noise or interference in the picture during playback:**  
Use the **CH/TRACK(+, -)** button to obtain a clearer picture.
- When the tracking is adjusted manually using the **CH/TRACK(+, -)** button the auto tracking mode is cancelled.  
**To return to auto tracking mode:**  
Eject the cassette (press **EJECT** on the VCR), then reload it again.
- If the **CHANNEL +, -** buttons on the VCR are pressed simultaneously in playback mode, the tracking adjustment will move to a centred position and the auto tracking mode will be cancelled.
- **If the still picture moves up and down:**  
Use the **CH/TRACK(+, -)** button to correct the picture.
- Any picture adjustments made manually to a particular cassette will be cancelled when the cassette is ejected.

# PLAYBACK



## REMAINING TAPE DURATION NOTES:

- This function will only give accurate duration times using E-180 or E-240 cassette tapes.
- The remaining tape duration calculations are cancelled when the tape is ejected.

## HI-FI STEREO/BILINGUAL SOUND SELECTION

- Using the **AUDIO** button, select the desired sound setup.
  - When a stereo or bilingual broadcast is received, ST or BIL will appear in the VCR display.

VCR DISPLAY	SELECTED SOUND	
	STEREO	BILINGUAL
LR	Left & Right tracks	Main & sub
L	Left track	Main
R	Right track	Sub
No indicator	Monaural	Main

## REMAINING TAPE DURATION FUNCTION

When the **REMAIN** button is pressed, the remaining tape duration from the current position to the end of the tape can be displayed. The tape duration is displayed in hours and minutes. Press the **REMAIN** button again to exit the function.



On-screen display



VCR display

The VCR display will return to the counter display indication.

## DISPLAY FUNCTION

Pressing the **DISPLAY** button will show on-screen the current programme position number, date and time. When a cassette is loaded the remaining tape duration can also be displayed.

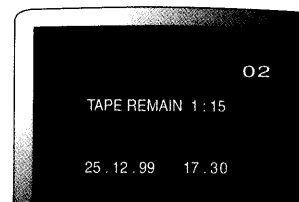

Press the **DISPLAY** button again to exit the on screen display.

# PLAYBACK

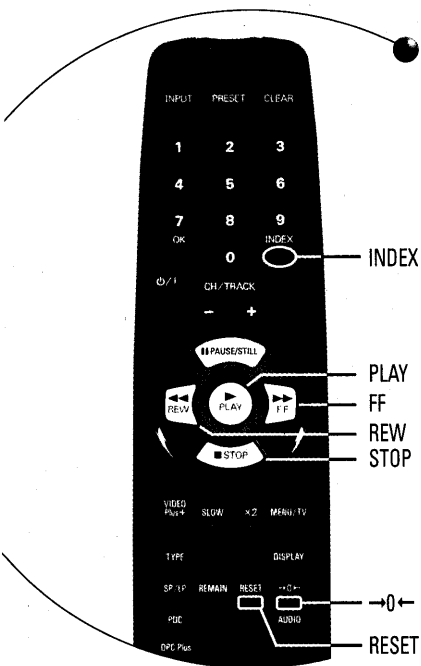

## RETURN TO ZERO

The counter zero position is memorised and can be used to return to that position on the tape.

- 1 Press the **RESET** button at the position you wish to return to. The counter reading in the VCR display is reset to "0:00:00".
- 2 To return to the zero position after a recording or playback, press the **→0←** button. The tape will be rewound or forwarded and stop at or near to the counter zero position.

## INDEX SEARCH

An index signal is automatically placed at the beginning of each recording made on this VCR. This index can be used to search for the next (or present) recording.

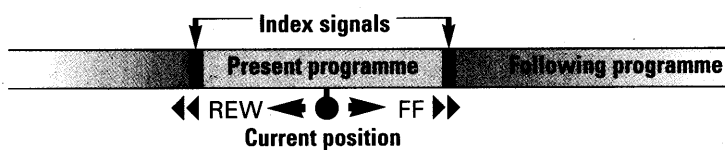

- 1 Press the **INDEX** button while in stop or playback mode. To cancel the Index search mode, press the **INDEX** button again.
- 2 Press the **FF** or **REW** button to start searching. To stop the search function, press the **STOP** button. Playback will start automatically when an index is found.



### RETURN TO ZERO NOTES:

- Return to zero is possible from the playback or stop mode.
- The **RESET** button cannot be used while the tape is being returned to zero.
- Whenever you load a cassette tape, the counter is reset to "0:00:00".
- If you playback a blank tape or a blank portion of tape, the counter will not operate.

### INDEX SEARCH NOTES:

- Make sure that any indexes are at least 5 minutes apart from each other.
- Index signals are not recorded after a recording pause.

## ENDLESS PLAY

This function will playback a tape to the end, rewind it then replay it again, and again until you wish to stop it.

- 1 In the stop or playback mode using the buttons on the VCR, press the **PLAY** button and then while holding it down press the **REW** button.
- 2 Press the **STOP** button to cancel endless play.
  - During endless play, do not press **FF**, **REW**, or **PAUSE/STILL** buttons because this will cancel the feature.

# RECORDING TV PROGRAMMES

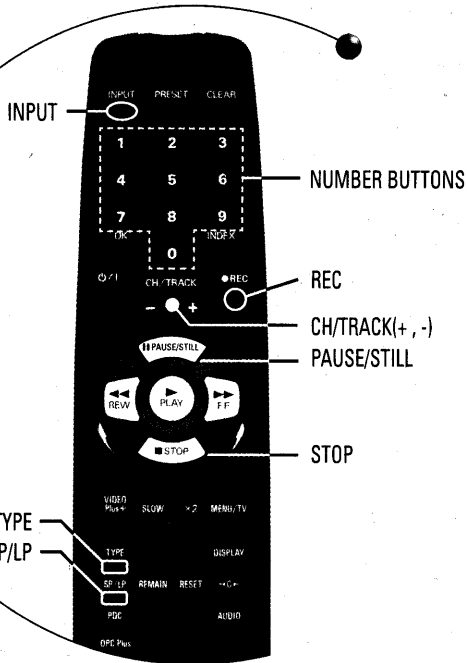

- 1** Turn on the TV and select the video programme position or switch to AV mode if you are using **SCART** connections.
- 2** Insert a blank video cassette.
- 3** Press the **NUMBER BUTTONS**, or the **CH/TRACK(+, -)** button, to select the TV station to be recorded.
- 4** To select the tape speed, press the **SP/LP** button.
- 5** If necessary, press the **TYPE** button to set the recording type.

## SETTING THE RECORDING TYPE

If a recording type is selected and you use the "TAPE LIBRARY DELUXE" function (page 27) it will be displayed and make selection of programmes to playback easier when the tapes recording data is listed.

- Press the **TYPE** button repeatedly until the desired type is displayed.

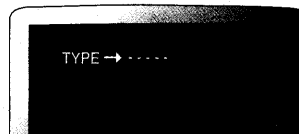

On screen display



VCR display

FILM	F:	Film
SPORT	S:	Sports
DRAMA	D:	Drama
MUSIC	M:	Music
NEWS	n:	News
ANIMA	A:	Animation
EDUC.	E:	Educational
GAME	g:	Game
THRIL	t:	Thriller
COMED	c:	Comedy

### TO RECORD FROM AN EXTERNAL SOURCE:

At step 3, Press the **INPUT** button to select the **SCART/EURO-AV** socket. The VCR display will show the selected source as "L1" or "L2".

**EURO-AV1** socket: select "L1"

**EURO-AV2** socket: select "L2"

Ensure the external source e.g. satellite receiver is switched on and the correct programme has been selected.

- 6** When the desired type has been selected, press the **OK** button.
- 7** Press the **REC** button.
- 8** To stop the recording, press the **STOP** button.

## QUICK START RECORDING TIMER

You can start a recording instantly and then simply programme when you want the VCR to automatically stop recording.

- 1 Press the **REC** button twice.
- 2 Set the recording end time using the **REC** and **CH/TRACK(+, -)** buttons.  
**REC** Units of 30 minutes  
**CH/TRACK(+ or -)** Units of 1 minute  
The timer indicator (□) will light in the VCR display after the recording end time is set.  
■ To stop the recording at any time, press the **STOP** button.

## CHECKING/CHANGING

When the **REC** button is pressed during Quick Start Recording, the recording end time will blink.

The recording end time can be changed by pressing the **REC** and **CH/TRACK(+, -)** buttons.

## AVOIDING RECORDING UNWANTED MATERIAL

- 1 Press the **PAUSE/STILL** button during recording.
- 2 To continue recording, press the **PAUSE/STILL** button or **REC** button.

## WATCHING TV WHILE RECORDING

- 1 Start recording the desired programme selected on the VCR.
- 2 On your TV, select the required programme you want to watch. If you are using **SCART** connections, set the TV to the TV mode.

## NOTES:

### RECORDING TYPE:

The selected recording type is cancelled if the VCR is switched to Standby mode or if the cassette tape is ejected.

### AUTO EJECT:

The cassette will automatically be ejected if recording is attempted on a video cassette without an erasure-prevention tab.

### AUTO REWIND:

The VCR automatically rewinds the tape when it reaches the end. This function does not operate with timer recording or Quick Start Recording timer.

### PAUSE MODE:

If the record pause mode continues for about five minutes, the VCR will automatically go into stop mode in order to prevent damage to the tape.

### TAPE SPEED:

**SP:** Best image and sound quality. (No display)  
**LP:** Recording or playback times are double the SP mode.

# TIMER RECORDING USING VIDEO Plus+

## PROGRAMMING ON-SCREEN

You can programme a VIDEO Plus+ timer recording using the on-screen display method.

Turn on the TV and select the video programme position.

- 1 Press the **VIDEO Plus+** button.



- 2 Enter the Plus Code programming number for the programme (e.g. 489135) using the **NUMBER BUTTONS**. Use the **CLEAR** button to delete any wrong numbers.

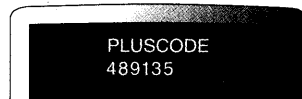

- 3 Press the **OK** button.  
If the programme position number PR displays "--" Enter the programme position number the TV station has been preset to, e.g 01 = BBC1.

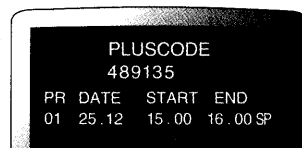

That setting will be memorised and set automatically the next time the station is selected.

To make **additional settings** to your timer recording, see far right.

- 4 When all the settings are as desired, press the **OK** button again.

You can programme another recording by repeating from step 2.

Insert a blank video cassette that is longer than the total recording time.

- 5 Press the **VIDEO Plus+** button.

The VCR must be in **STANDBY** mode to activate the timer. The timer indicator (☐) will light on the VCR display.

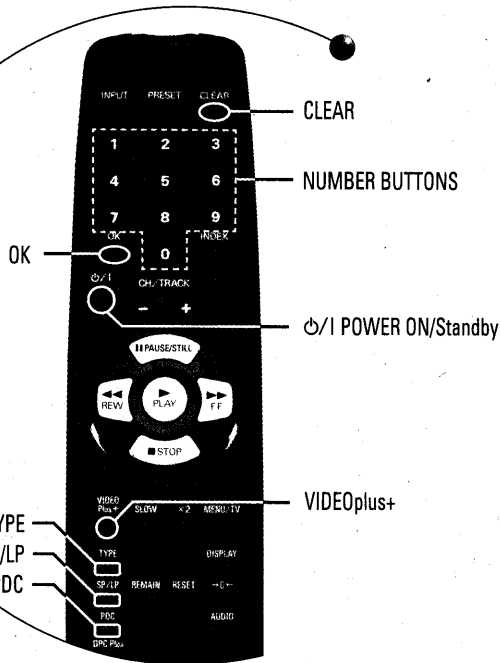

### NOTE:

VIDEO Plus Code programming numbers can be found in Newspaper or TV guides.

16.30 NATURES WAY(S) (236586)  
17.00 PEOPLE TODAY(S) (236586)  
18.00 NEWS:WEATHER  
18.30 QUESTION QUIZ (S) (489135)



### Plus Code programming numbers

**VIDEO Plus+** and **PlusCode** are registered trademarks of Gemstar Development Corporation.  
**VIDEO Plus+** system is manufactured under license from Gemstar Development Corporation.

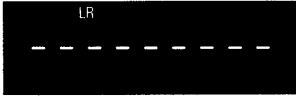

## PROGRAMMING USING THE VCR DISPLAY

You can programme a VIDEO Plus+ timer recording on the VCR display even if the TV is turned off.

- 1** Press the **VIDEO Plus+** button.  

- 2** Enter the Plus Code programming number for the programme (e.g. 489135) using the **NUMBER BUTTONS**. Use the **CLEAR** button to delete any wrong numbers.  

- 3** Press the **OK** button.  
If the programme position number PR displays "--" enter the programme position number the TV station has been preset to, e.g 01 = BBC1. That setting will be memorised and set automatically the next time the station is selected.  

To make **additional settings** to your timer recording, see right.
- 4** When all the settings are as desired, press the **OK** button again.  
You can programme another recording by repeating from step **2**.  
Insert a blank video cassette that is longer than the total recording time.
- 5** Press the **VIDEO Plus+** button.  
The VCR must be in STANDBY mode to activate the timer.  
The timer indicator (☐) will light on the VCR display.

## ADDITIONAL SETTINGS

After pressing **OK** at step **3**.

### RECORDING TAPE SPEED:

Press the **SP/LP** button repeatedly to display the desired tape speed.

### JUST REC. SETTING:

Press the **SP/LP** button repeatedly until "**AUTO**" is displayed.  
See page 26 for details about JUST REC.

### DAILY/WEEKLY RECORDING:

Press the **MENU/TV** button repeatedly to display the required recording mode.  
M-F: Record daily, Monday through Friday.  
WK: Record the same programme every week.

### RECORDING TYPE:

Press the **TYPE** button repeatedly until the desired type is displayed.

### CHANGING THE OFF TIME:

Each press of the **CH(+, -)** button will change the recording off time by units of 10 minutes.

### PDC FUNCTION:

Press the **PDC/DPC Plus** button repeatedly. When the "PDC" indicator appears, the PDC function is set.  
See page 26 for more information on PDC.

# MANUAL ON-SCREEN TIMER RECORDING

## PROGRAMMING THE TIMER

Example: Programme position	Date	Start time	End time
02	25 Dec	21.30	23.15

**1** Turn on the TV and select the video programme position or switch to AV mode if you are using **SCART** connections.

**2** Press the **MENU/TV** button.

Press the **OK** button to access the **PROG. SET/CLEAR** mode.

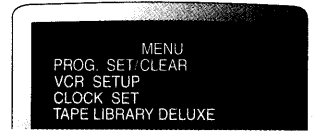

**3** Enter the programme position number, (e.g. 02) and the date, (e.g. 25 12) using the **NUMBER BUTTONS**.

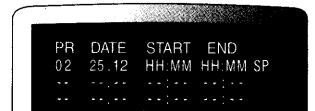

Use the **CLEAR** button to delete any wrong numbers.

**4** To select daily or weekly recording press **CH/TRACK (+)** to display the desired mode. **M-F**: Monday to Friday. **WK**: Weekly.



Press the **PDC** button to activate PDC (Programme Delivery Control). For more info about PDC see page 26.



**5** Set the recording start and end times (e.g. 21:30, 23:15).

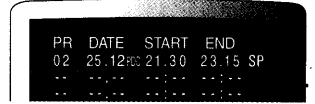

**6** Press the **SP/LP** button to select the desired tape speed, or until A (Auto) appears for **JUST REC.** mode. For more info about **JUST REC** see page 26.

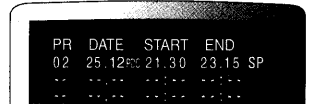

Press the **TYPE** button repeatedly until the desired type is displayed.

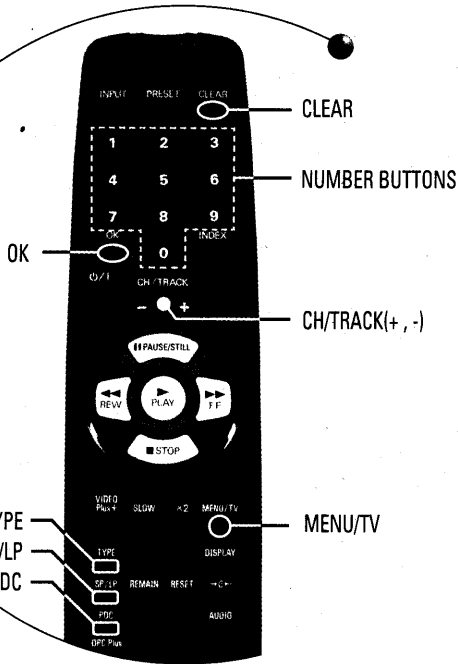
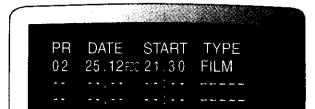

**7** When all the settings are as desired, press the **OK** button.

You can programme another recording by repeating steps **3** to **8**.

Insert a blank video cassette that is longer than the total recording time.

**8** Press the  $\phi$ /I button.

The VCR must be in standby mode to activate the timer.

The timer indicator (E) will light on the VCR display.

**CONFIRMATION/CANCELLING A PROGRAMMED TIMER RECORDING**

**1** Press the **MENU/TV** button.

Using the **CH/TRACK(+ , -)** button, select **PROG. SET/CLEAR**.

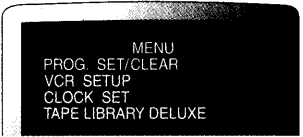

**2** Press the **OK** button.

Programmed timer recordings are listed.

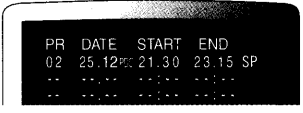

**3** To confirm recording type setting press the **TYPE** button. The type will be displayed in place of the "END" time.

Press the **TYPE** button again to reveal the "END" time column display.

**4** If all settings are correct press the **MENU/TV** button to exit the menu.

If you need to correct or cancel any settings please continue.

**5** Using the **CH/TRACK(+ , -)** button, select the programme setting to cancel.

**6** Press the **CLEAR** button.

The message is displayed.

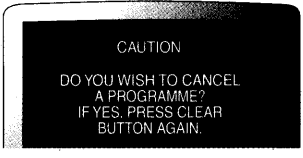

**7** Press the **CLEAR** button again to cancel the selected setting.

If you do not wish to erase the setting, press the **OK** button.

Press the **MENU/TV** button when you have finished.

**NOTES ON TIMER RECORDING:**

- The timer indicator (E) will flash if no video cassette is loaded when going into timer standby mode.
- The timer indicator (E) will flash and the video cassette is ejected if a video cassette with no erasure-prevention tab is loaded.
- Daily recording starting on a Saturday or Sunday is not possible.
- Daily or weekly recording using the PDC function is not possible.
- Even if a timer recording has been preset, the VCR can be used as usual up to the programmed start time. Make sure that you return the VCR to standby mode if you do use the VCR before a preset recording.

**Programme priority**

- When timer recordings overlap, the first programme will be recorded entirely, therefore the beginning of second programme will not be recorded.
- Recordings programmed with PDC always have priority.
- If two PDC-programmed recordings overlap, the recording that starts first will have priority.

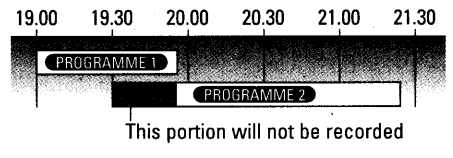

# TIMER RECORDING WITHOUT USING THE REMOTE CONTROL

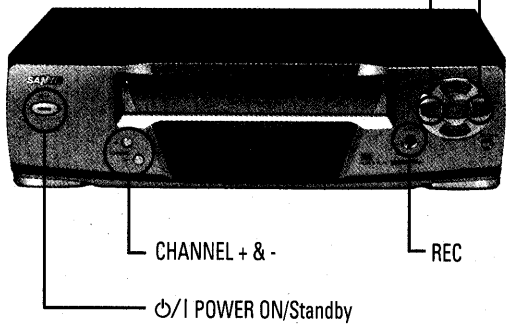

If the remote control batteries are dead or the handset is not available a timer recording can still be programmed using the buttons on the VCR. This method does not allow the setting of the recording type, daily or weekly recording.

**1** Turn on the TV and select the video programme position or switch to AV mode if you are using **SCART** connections.

**2** Ensure that there is **NOT** a cassette tape in the VCR during programming.

**3** Press the **REC** button for about 5 seconds, until the programming screen is displayed.



**4 Example: Programme position      Date      Start time      End time**  
02                                  12 Oct                  15.30                  17.30

Enter the required settings using the **CHANNEL - , +** buttons. Press the **FF** button to move to the next entry space. Press the **REW** button to delete wrong settings.

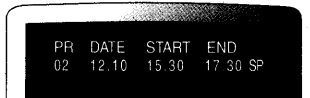

**5** When the required tape speed setting is entered by pressing the **FF** button, the timer recording is set. To make further timer recordings, proceed entering the required settings.

**6** When you have finished, press the **REC** button. The on-screen message, NO CASSETTE can be ignored as this special process requires no tape be present during programming.

**7** Now load a cassette tape that is longer than the total recording time.

**8** Press the **P/O** button to turn the VCR power off. The VCR will automatically enter the timer standby mode. The timer indicator (⏻) will light on the VCR display.

### NOTES:

- If the **REC** button is pressed before all settings are complete, the timer record setup mode will be cancelled.
- Once a programme timer recording is set, it cannot be confirmed or erased using the buttons on the VCR. It is only possible using the remote control.

### SETTING TIP:

- To record from an external input, press the **CHANNEL (-)** button to display "L1" or "L2" under "PR"  
"L1": EURO-AV1  
"L2": EURO-AV2

# RECORDING FUNCTIONS

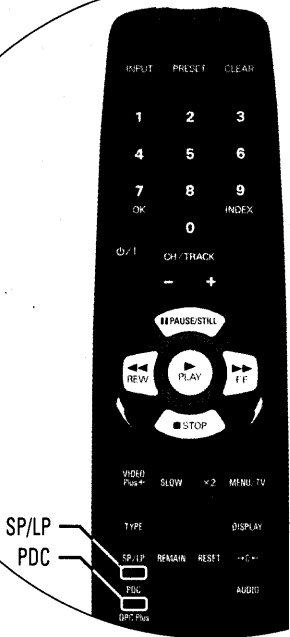

## JUST REC. FUNCTION

During a timer recording, the VCR will automatically calculate the remaining tape duration and, if necessary switch the recording speed from SP (standard play) to LP (long play), so that the entire programme can be recorded.

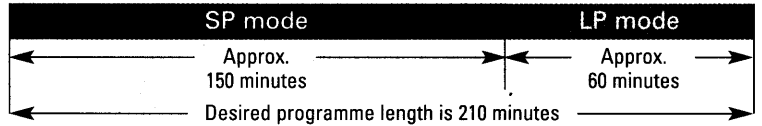

- This function is not available during Quick Start Recording.
- JUST REC. will not work properly on tapes longer than E-240 or shorter than E-180.
- If two or more timer recordings are set, all the programmes may not fit on a single tape. If that is the case do not select JUST REC. mode, select the tape recording speed manually.
- This function will not work if the PDC function is set on a timer recording.
- Some interference may occur in the image where the speed has been changed.

## PDC FUNCTION

The PDC (Programme Delivery Control) function ensures that if any changes are made to the on and off times of a programme by the TV station, the timer recording will be adjusted automatically. Also, if for example the programme is interrupted by a news flash the recording will pause and resume when finished.

- If the recording start time and date is not set exactly as advertised and there is a change to the broadcast, the PDC function will not work.
- Not all TV stations transmit PDC signals. Check in your region for details.
- If the station does not transmit PDC signals or if the function is not set, the recording will be done at the programmed times.
- When programming with the PDC function, the recording can be done anytime in the standby period if the start (on) time differs from the scheduled one. The PDC standby period is from 20:00 (the previous day) to 4:00 (the following day).

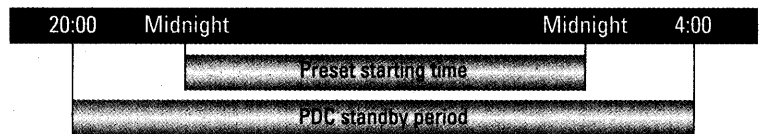

### PDC NOTES:

PDC will light in the VCR display to indicate that the TV station is transmitting a PDC signal. It does not indicate that the function is on, only that should you wish to make a timer recording the PDC function will work when activated.

VCR display



# TAPE LIBRARY DELUXE SYSTEM

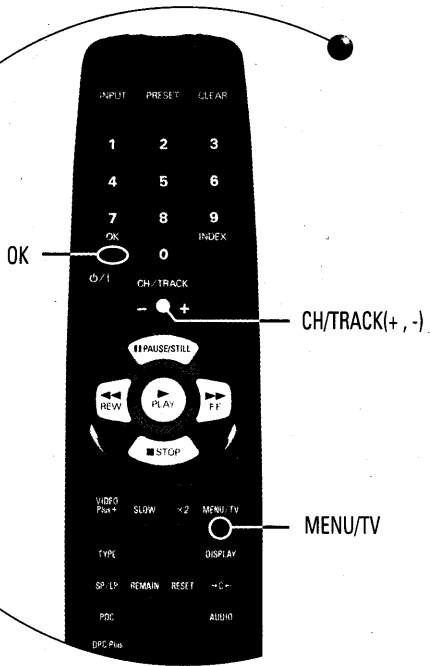

This function memorizes the settings (Programme position, time, date and type) of previous timer recordings made on this VCR and stores the data in a Tape Library. You can reuse previous timer recording data to programme new recordings, as well as search, select and automatically playback a recording from the contents list of recording data.

- 1** Insert a video cassette.
- 2** Press the **MENU/TV** button, select TAPE LIBRARY DELUXE using the **CH/TRACK(+, -)** button, then press the **OK** button.



Depending upon the cassette loaded you will see one of the following screens. To proceed, go to the section labelled with the corresponding letter.

## NOTES:

- Only E-180 & E-240 tapes can be used for TAPE LIBRARY DELUXE timer recording. Remaining tape duration times may be inaccurate if other types are used.
- TAPE LIBRARY DELUXE timer recordings are only possible on new tapes or tapes containing TAPE LIBRARY DELUXE timer recording data.
- We recommend that you keep tapes used for TAPE LIBRARY DELUXE timer recording separate from other types of tapes. Other types of recording data other than TAPE LIBRARY DELUXE timer recording data will mean the tape contents list will not be displayed properly.

**A**



**B**

+

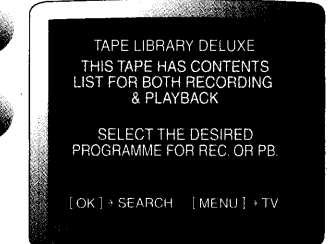

**C**

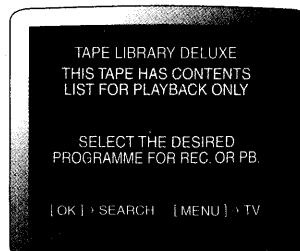

The tape does not contain any type of recording data.

# A NEW RECORDING PROGRAMMING

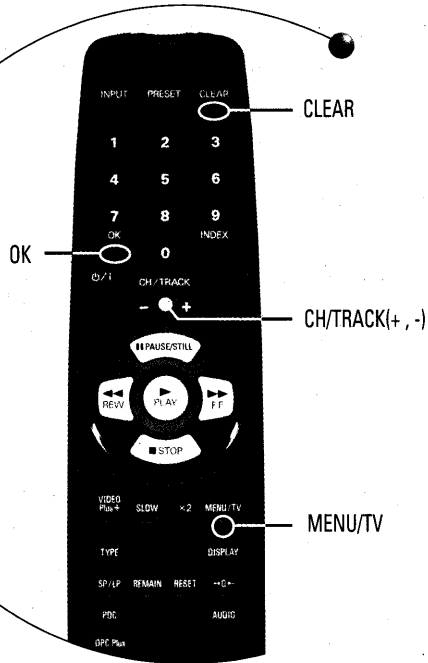

## NOTES:

- Only one recording can be programmed.
- To record from an external input, press the **CH/TRACK(-)** button to display "L1" or "L2" under "PR".  
"L1": EURO-AV1 or "L2": EURO-AV2
- The START and or END time of a timer recording can be modified in 15 minute units, by pressing the **CH/TRACK(+, -)** button.

### TIMER STANDBY PERIOD:

- Do not eject the cassette or turn the VCR on during the timer standby period or the programmed timer recording will be cancelled.
- Other timer recordings are not possible until the TAPE LIBRARY DELUXE timer recording is over.

**1** Insert a video cassette.

- 2** Press the **MENU/TV** button.  
Select TAPE LIBRARY DELUXE using the **CH/TRACK(+, -)** button, then press the **OK** button.



This screen will appear if you have loaded a blank or new cassette. You can now make a new TAPE LIBRARY DELUXE timer recording.



- 3** Press the **OK** button.

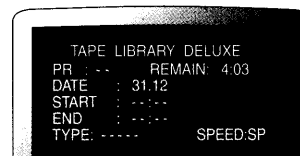

<b>4</b> Example: Programme position	<b>Date</b>	<b>Start time</b>	<b>End time</b>
02	12 Oct	15:30	17:30

Enter the required settings using the **CH/TRACK(+, -)** buttons. Press the **OK** button to move to the next entry space.  
Press the **CLEAR** button to delete wrong settings.

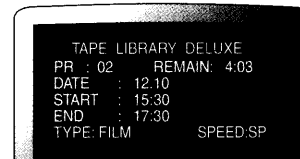

- 5** When the required tape speed (SPEED) setting is entered by pressing the **OK** button, the timer recording is set.

The VCR will automatically enter the timer standby mode.  
The timer indicator (□) will light on the VCR display.

# B RECORDING PROGRAMMING USING THE TAPE LIBRARY DELUXE DATA

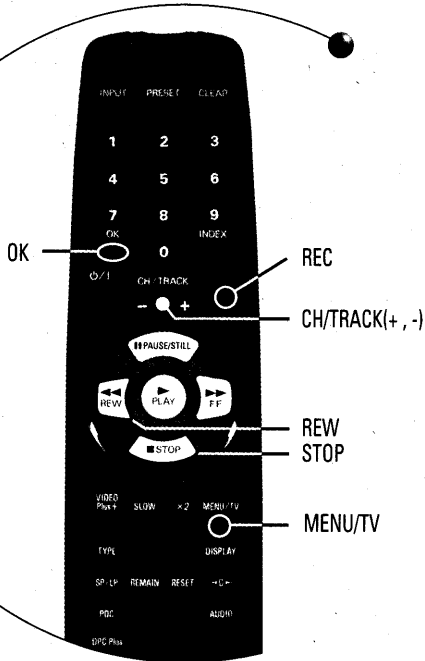

**1** Insert a video cassette.

**2** Press the **MENU/TV** button. Select **TAPE LIBRARY DELUXE** using the **CH/TRACK(+, -)** button, then press the **OK** button.



This screen will appear if you have loaded a cassette which contains **TAPE LIBRARY DELUXE** timer recording data. You can choose to reuse any such data or playback a desired recording.

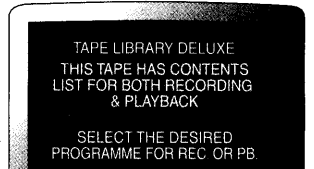

**3** Press the **OK** button.

- The recording data is read, then the tape contents list is displayed. If the tape data has already been read it will be displayed immediately.
- When the desired recording data to use is displayed, press the **STOP** button. If you wish to enter a new recording to be made on the blank portion of the tape, wait until the tape stops.

**To reuse recording data follow from step 4.**

**To make a new recording on the blank portion of the tape continue on the next page.**

**4** Using the **CH/TRACK(+, -)** button, select the desired recording data to reuse.

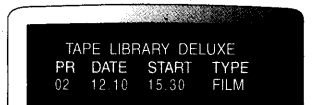

**5** Press the **REC** button.

- Only the date is updated to the following programme occurrence on the same day of the week.

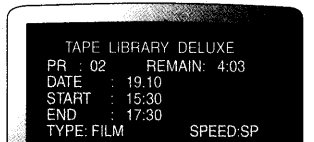

- To return to the contents list, press the **REW** button.

**6** Confirm the programming settings, then press the **OK** button. The tape will be advanced (rewound) to the beginning of the selected programme. The VCR will automatically enter the timer standby mode. The timer indicator (□) will light on the VCR display.

## NOTES:

- Data of recordings shorter than 5 minutes may not be displayed.
- If the tape is unloaded or rerecorded, the data will be cancelled.
- If a recordings data cannot be read, "--" will be displayed.

## START/END TIME ADJUSTMENT:

- The Start and or End time of a **TAPE LIBRARY DELUXE** timer recording can be modified in 15 minute units by pressing the **CH/TRACK(+, -)** button.



# B MAKING A NEW RECORDING ON THE BLANK PORTION OF THE TAPE

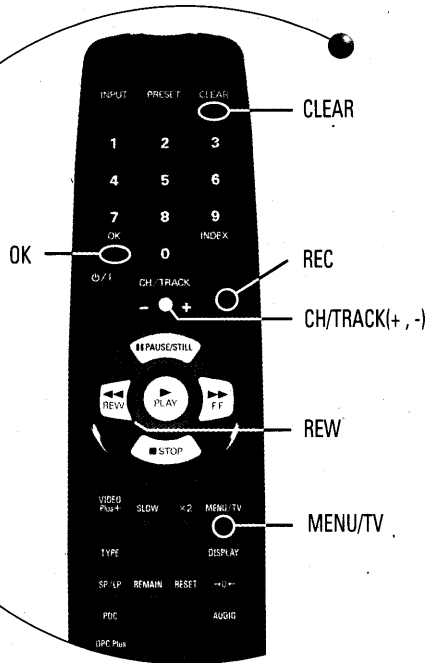

## CONTINUED FROM STEP 3 (OPPOSITE)

**4** Using the **CH/TRACK(+, -)** button, select the REMAIN FOR REC line to enter a new recording to be made on the blank portion of the tape.



**5** Press the **REC** button.

To return to the contents list, press the **REW** button.

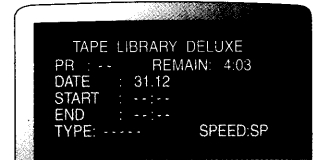

**6 Example: Programme position**

Programme position	Date	Start time	End time
02	12 Oct	15.30	17.30

Enter the required settings using the **CH/TRACK(+, -)** buttons. Press the **OK** button to move to the next entry space. Press the **CLEAR** button to delete wrong settings.

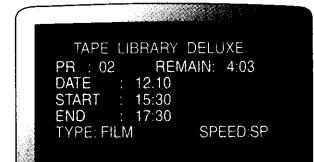

**7** When the required tape speed (SPEED) setting is entered by pressing the **OK** button, the timer recording is set.

The VCR will automatically enter the timer standby mode. The timer indicator (E) will light on the VCR display.

### NOTES:

- If a programmed recording duration is longer than the available remaining tape length the error message, "**THERE IS NOT ENOUGH TAPE LENGTH TO RECORD THE ENTIRE PROGRAMME**" will be displayed on-screen for about 3 seconds. The programme screen will be displayed again.

### SOLUTION:

- Change the tape speed from **SP** to **LP** mode.
- Use a different cassette tape. In such a case, programming will start from the beginning.

# **AUTOMATIC PLAYBACK**

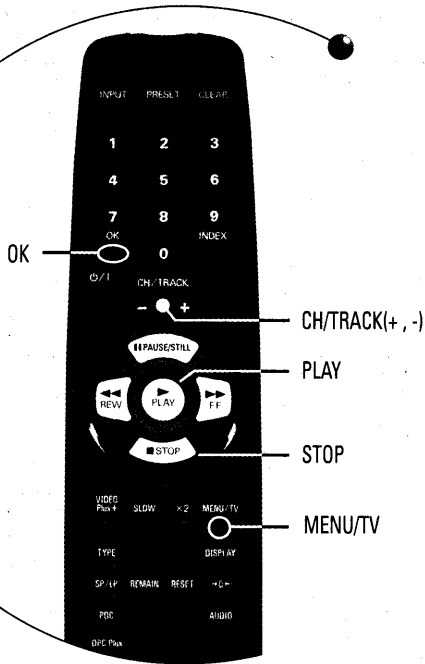

### **CONTENTS LIST DISPLAY NOTE:**

- The contents list displayed on the TV screen will show the recording data for a maximum of 6 programmes recorded using the standard method or 4 programmes recorded using the TAPE LIBRARY DELUXE method. After the maximum number of programmes recorded is displayed, the next recording data is located and displayed.

**1** Insert a video cassette.

**2** Press the **MENU/TV** button. Select **TAPE LIBRARY DELUXE** using the **CH/TRACK(+, -)** button, then press the **OK** button.

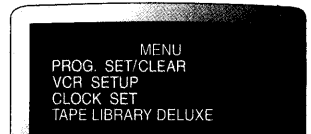

One of these screens will appear if you have loaded a cassette which contains **TAPE LIBRARY DELUXE** normal recording or normal timer recording data.

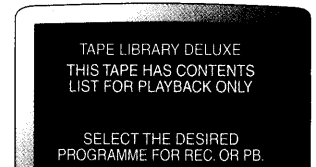

**3** Press the **OK** button.

- The recording data is read, then the tape contents list is displayed. If the tape data has already been read it will be displayed immediately.
- When the desired recording is listed, press the **STOP** button.

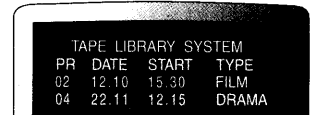

**4** Using the **CH/TRACK(+, -)** button select the desired programme, then press the **PLAY** button.

**5** This screen message is displayed while the beginning of the desired programme is located. Playback will then start automatically.



To cancel the operation, press the **STOP** button.

# TAPE COPYING

Copying or (dubbing) a tape is achievable by connecting either another VCR or a camcorder.

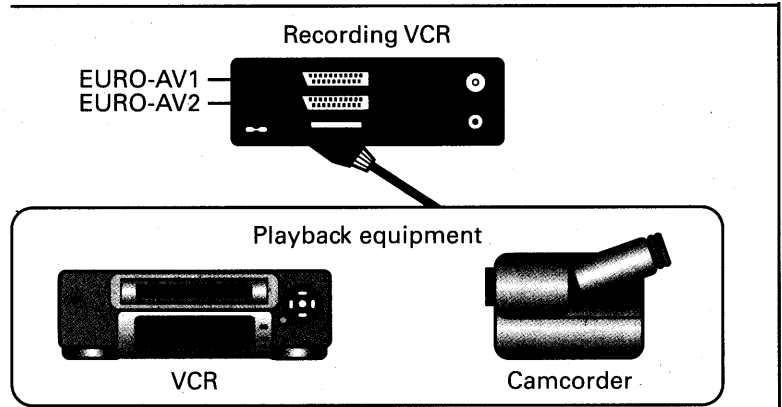
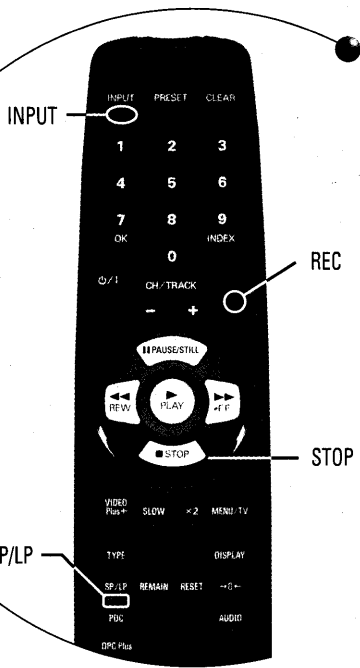

## RECORDING VCR

- 1 Insert a blank video cassette.
- 2 Press the **INPUT** button to select the terminal used.  
"L1" or "L2" will show on the VCR display.  
L1: EURO AV1  
L2: EURO AV2 (recommended)
- 3 Press the **SP/LP** button to select the desired recording tape speed.



## PLAYBACK EQUIPMENT

- 4 Insert the recorded video cassette.
- 5 Start playback.

## RECORDING VCR

- 6 Press the **REC** button to start copying.
- 7 When complete press the **STOP** button on the recording VCR then on the playback equipment.

### CAUTION:

The unauthorised recording of television programmes, video tapes, films and other such material may infringe upon copyright or rights of third parties.

# ERROR MESSAGES GUIDE

<b>ERROR MESSAGE</b>	<b>CAUSE</b>	<b>REMEDY</b>
<b>NO SIGNAL</b>	<ul style="list-style-type: none"> <li>▶ The antenna is not properly connected.</li> <li>▶ A programme position where no station has been preset is selected.</li> <li>▶ Trying to playback a blank tape.</li> </ul>	<ul style="list-style-type: none"> <li>▶ Check &amp; correct connection</li> <li>▶ Select a different programme position or adjust the preset programme position.</li> <li>▶ Insert a recorded cassette.</li> </ul>
<b>NO CASSETTE</b>	<ul style="list-style-type: none"> <li>▶ A button for playback, fast-forward, rewind, recording etc. has been pressed, but no tape is loaded in the VCR.</li> <li>▶ A timer recording is preset, but no tape is loaded in the VCR.</li> </ul>	<ul style="list-style-type: none"> <li>▶ Load a cassette tape.</li> </ul>
<b>TIMER MEMORY FULL</b>	<ul style="list-style-type: none"> <li>▶ Trying to programme a timer recording when the VCR timer memory is full (Maximum 6 programmes).</li> </ul>	<ul style="list-style-type: none"> <li>▶ First erase one of the 6 programmes already entered.</li> </ul>
<b>WRITE-PROTECTED CASSETTE</b>	<ul style="list-style-type: none"> <li>▶ When the VCR tries to go into recording standby mode but the loaded cassette does not have an erasure prevention tab (The cassette is ejected automatically).</li> </ul>	<ul style="list-style-type: none"> <li>▶ Load a blank tape or a tape that can be recorded on with an erasure prevention tab.</li> </ul>
<b>TIMER RECORDING</b>	<ul style="list-style-type: none"> <li>▶ When a timer recording is set, if the VCR power is on less than 5 minutes before the recording start time, this will indicate that the timer recording is about to start.</li> </ul>	<ul style="list-style-type: none"> <li>▶ Set the VCR to recording standby mode.</li> </ul>
<b>YOUR VCR WILL BE OFF SHORTLY</b>	<ul style="list-style-type: none"> <li>▶ When the off timer function is set. Approximately 5 minutes before the power is turned off automatically, the message is displayed on-screen for about 10 seconds to warn the user before turning the power off.</li> </ul>	<ul style="list-style-type: none"> <li>▶ If the VCR is not being used, turn the power off.</li> </ul>
<b>THERE IS NOT ENOUGH TAPE LENGTH TO RECORD THE ENTIRE PROGRAMME</b>	<ul style="list-style-type: none"> <li>▶ The programmed recording is longer than the remaining blank portion of the tape.</li> </ul>	<ul style="list-style-type: none"> <li>▶ Change the tape speed from SP to LP mode.</li> <li>▶ Use a different tape. In such a case, programming will be restarted from the beginning.</li> </ul>

Note: When a timer recording is programmed using the buttons on the VCR, without using the remote control, the message "NO CASSETTE" is displayed. This special method requires that no tape be loaded in the VCR when the **REC** button is pressed.



# TROUBLE SHOOTING

<b>SYMPTOM</b>	<b>CHECK POINTS</b>
<b>POWER TROUBLE</b>	
No power.	<ul style="list-style-type: none"> <li>▶ The mains lead is disconnected.</li> </ul>
The remote control unit doesn't operate.	<ul style="list-style-type: none"> <li>▶ The batteries are low.</li> </ul>
<b>RECEIVER TROUBLE</b>	
No TV programmes received.	<ul style="list-style-type: none"> <li>▶ Are the connections between your VCR and TV correct?</li> <li>▶ Was tuning correctly preset?</li> </ul>
Reception is poor when TV is on video channel.	<ul style="list-style-type: none"> <li>▶ The video channel setting of the TV does not correspond to the video channel presetting of the VCR.</li> </ul>
Poor image quality when watching TV.	<ul style="list-style-type: none"> <li>▶ When ECO mode is set, the aerial output from the VCR will deteriorate. When watching TV do not set the ECO mode.</li> </ul>
<b>PLAYBACK TROUBLE</b>	
Playback picture does not appear.	<ul style="list-style-type: none"> <li>▶ The video channel setting of the TV does not correspond to the video channel presetting of the VCR.</li> </ul>
Interference in playback picture.	<ul style="list-style-type: none"> <li>▶ Adjust the tracking control.</li> <li>▶ Dust or dirt on video heads.</li> <li>▶ Contact your Sanyo authorised service agent.</li> </ul>
<b>RECORDING TROUBLE</b>	
No recording.	<ul style="list-style-type: none"> <li>▶ The erasure-prevention tab on the cassette has been removed.</li> </ul>
Timer recording is not possible.	<ul style="list-style-type: none"> <li>▶ The starting day and time has not been set correctly.</li> <li>▶ There has been a power interruption of more than one hour.</li> </ul>
<b>HI-FI TROUBLE</b>	
Sound of a Hi-Fi recorded tape drops out	<ul style="list-style-type: none"> <li>▶ The tape may be defective. Use a new cassette tape.</li> </ul>
<b>TV STATION/VCR OUTPUT INTERFERENCE</b>	<ul style="list-style-type: none"> <li>▶ Turn off the RF output (page 35) "RF OUTPUT DEACTIVATION".</li> </ul>

## REPAIRS

This VCR is a precision instrument and, if treated with care, will provide years of satisfactory performance. However, in the event of difficulty, the owner is advised not to attempt to make any repairs or open the cabinet. Servicing should always be referred to your Sanyo authorised service agent.

# RF OUTPUT DEACTIVATION

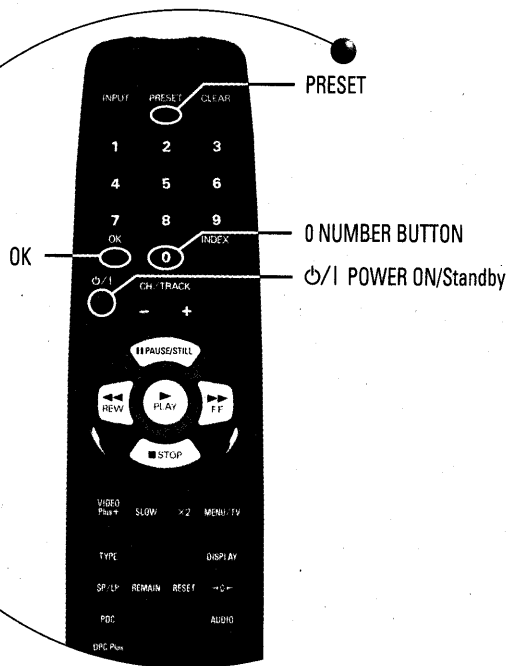

## NOTE:

When the RF output is turned off the VCR can only be used to playback tapes or watch a TV station programme tuned on the VCR using a **SCART** lead connection.

In extreme cases there may be interference between the VCR output and TV stations that cannot be solved by following the "RF OUTPUT CHANNEL ADJUSTMENT" procedure on page 9.

To overcome this you can turn off the RF output as follows:

- 1 Switch the VCR off using the  $\phi$ /I button.
- 2 Press and hold the **PRESET** button for at least 3 seconds.

The VCR display will show the current RF output channel number. e.g...



Make a note of this number should you wish to turn the RF output back on.

- 3 Press the **0 NUMBER BUTTON** twice.
- 4 Press the **PRESET** button.

Repeat the procedure if necessary.

## TO REACTIVATE RF OUTPUT

Follow the same procedure as above but at step 3 enter the RF number you noted.



# SPECIFICATIONS

## GENERAL

Video format:	VHS PAL/NTSC 4.43	
Television system:	CCIR: 625 lines, PAL colour signals	
TV channel storage capacity:	88 positions	
Video heads:	4 heads	
Tape speed:	▶ PAL SP: 23.39 mm/sec LP: 11.70 mm/sec	▶ NTSC (Playback only) SP: 33.35 mm/sec LP: 16.67 mm/sec EP: 11.12 mm/sec
RF converter:	Built-in UHF converter	
Converter output:	On channel 21-69	
Timer indication:	24-hour indication	
Power failure backup:	Approx. one hour	
Timer recording:	1 year 6 programmes with daily (Monday to Friday) and weekly recording function	
Power requirement:	220-240 V AC, 50Hz	
Dimensions (W x H x D):	360 x 97 x 277 mm	
Weight:	Approx. 3.3 kg	
Power consumption:	19 W (in operation) less than 2W (ECO mode)	

## ELECTRICAL CHARACTERISTICS

Video input:	0.5 - 2.0Vp-p, 75 ± 5 ohms
Video output:	1.0 ± 0.2Vp-p, 75 ± 5 ohms
Audio input:	-3.8 dBs, more than 10 kohms
Audio output:	-3.8 dBs, less than 1 kohm
Video S/N:	More than 43 dB
Horizontal resolution:	More than 240 lines

## HI-FI AUDIO

Audio recording system:	VHS Hi-Fi system (2 tracks), (Normal audio track is monoaural)
Frequency response:	20 Hz - 200,000 Hz
Dynamic range:	More than 90dB
Wow and flutter:	Less than 0.005% (WRMS)
Channel separation:	More than 60 dB

**Appearance and specification are subject to change without notice.**

# **CUSTOMER GUARANTEE**

Sanyo U.K. Sales Ltd. (the Company) guarantees to the initial retail purchaser that if this equipment is or becomes defective and that, in the opinion of the Company, the defect is due to faulty material or workmanship the Company will, for a period of 12 calendar months from the date of sale to the original purchaser repair or replace, at its sole option, free of charge, any such defective component part of the equipment, always provided that:-

- The equipment has at all times been used in accordance with the operating instructions issued by the Company, and has not been connected to an electrical mains supply for which it has not been adjusted.
- Accidental damage, or damage caused by negligence or misuse by the user, including leakage from exhausted batteries, is specifically excluded.
- Unauthorised repairs, or any modification to the equipment which has not been expressly approved by the Company, shall render this guarantee null and void.
- Failure due to fair wear and tear of any item, such as batteries, record playing styli, and tape recording, playback and erase heads and head cleaning is specifically excluded.

This guarantee is not transferable and is only applicable within the United Kingdom (and the Republic of Ireland). Nothing in this express guarantee affects the statutory rights available to the purchaser of this equipment.

## ***Dear Customer***

Thank you for buying Sanyo. This equipment should give you many years of pleasure and faithful service but in the event that a fault occurs, the following notes for your guidance may be helpful:

- PLEASE RETAIN YOUR PURCHASE RECEIPT WHICH WILL BE REQUIRED FOR SERVICE DURING GUARANTEE.
- If your Sanyo equipment proves faulty during the period of guarantee, take it or send it back to the dealer who originally supplied it together with this guarantee and the proof of purchase. We have made arrangements with our approved dealers under which they will carry out in guarantee service repairs on our behalf. In this way, we hope to reduce to a minimum the amount of time you will be without your equipment.
- If for some reason it is impossible to return the equipment to the original supplier, please contact our Service Administration Department at the address below for further advice.
- Should the equipment require servicing after the expiry of the guarantee period, take or send it to the original supplier or any other Sanyo dealer. He will be pleased to give you a quotation for the repair. If you are in any doubt about what to do, write to us at the address below or telephone:

Sanyo U.K. Sales Ltd.  
Sanyo House, Otterspool Way, Watford, Hertfordshire WD2 8JX Tel: (01923) 246363

**SANYO**