

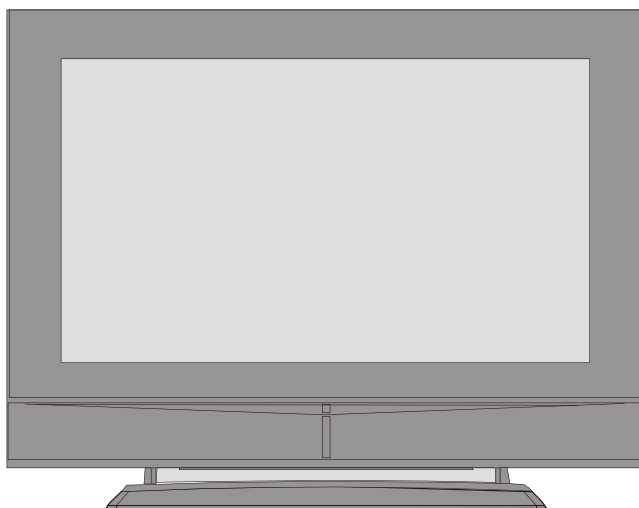

INSTRUCTION MANUAL

CES26WSD7-B

Colour television



**Please read this Instruction book before using your television.
We wish you many hours of pleasure from your new television.**

Problems with set-up?

Call 0870 240 7475

Contents

Remote Control Buttons	2
LCD TV	2
Preparation	3
Safety Precautions	3
Before Switching On Your TV	5
Switching The TV ON/OFF	5
Navigating the Menu System	5
Initial Settings	6
Basic Operations	7
Everyday Operation	7
IDTV Menu System	9
Analogue TV Menu System	15
PC Mode	20
Other Features	20
Teletext	22
Connect Peripheral Equipment	23
Tips	24
Specifications	24
Appendix A: PC Input Typical Display Modes	25
Appendix B: Aerial Connection	25
Appendix C: Connect Peripheral Equipment	25
Peripheral Equipment Connections	26
Important Instruction	27

Remote Control Buttons

① = Stand By
 ② = Cursor Up
 ③ = Cursor Right
 ④ = Info
 ⑤ 0-9 = Direct Programme
 ⑥ = No function
 ⑦ = Programme Up
 ⑧ = Volume Up
 ⑨ = TV / DTV
 ⑩ /SOURCE= External Source
 ⑪ Yellow button = Feature Menu
 ⑫ Blue button = Installation Menu
 ⑬ / = Hold / No function/
 subtitle on/off in the digital mode
 ⑭ = Update, = No function
 ⑮ = Index Page
GUIDE= Electronic Programme Guide (EPG)
 ⑯ =Reveal / Switch from TV to PC
 ⑰ = Expand,
/WIDE = Image size
 ⑱ = Mix, = No function
 ⑲ = Teletext
 ⑳ = Time
 ㉑ /Red button = Page Down /
 Sound Menu
 ㉒ / Green button = Page Up /
 Picture Menu
 ㉓ =Previous Programme
 ㉔ = Mono/Stereo - Dual I-II
 ㉕ = Programme Down
 ㉖ = Volume Down
 ㉗ = Picture Mode Selection
 ㉘ = Okay (Store)
 ㉙ = Cursor Down
 ㉚ = Cursor Left
 ㉛ = Menu
 ㉜ = Mute

LCD TV

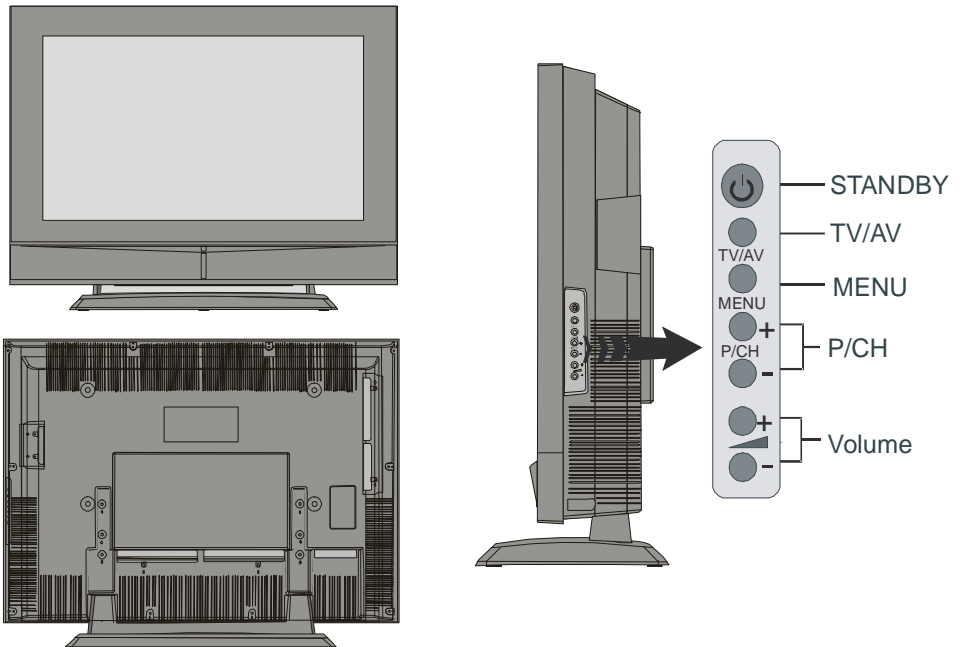

Preparation

For ventilation, leave a space of at least 10 cm free all around the set. To prevent any fault and unsafe situations, please do not place any objects on top of the set.

Use this apparatus in moderate climates.

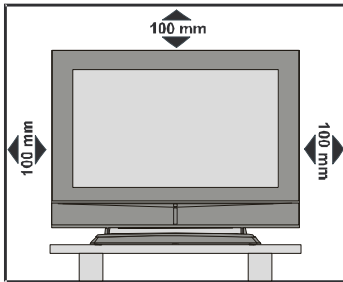

Features

- Remote controlled colour LCD TV.
- **Fully integrated Digital TV (DVB-T)**
- 100 programmes from VHF, UHF bands or cable channels can be preset.
- It can tune cable channels.
- Controlling the TV is very easy by its menu driven system.
- It has 2 Scart sockets for external devices (such as video, video games, audio set, etc.)
- Stereo sound system (German+Nicam).
- Full function Teletext (500 pages).
- Fastext, TOP text.
- Headphone connection.
- A.P.S. (Automatic Programming System).
- All programmes can be named.
- Forward or backward automatic tuning.
- Sleep timer.
- Child Lock.
- Automatic sound mute when no transmission.
- NTSC Playback.
- AV in and S-VHS in are available.
- It has VGA connector for external devices such as computer.
- **It has two HDMI connectors** for Digital Video and Audio. This connection is also designed to accept High Definition signals.
- AVL (Automatic Volume Limiting)
- When no valid signal is detected, after 5 minutes the TV switches itself automatically to stand-by mode.
- PLL (Frequency Search)

- PC Input
- Plug&Play for Windows 9X, ME, 2000, XP
- Audio Line Out

Safety Precautions

Please read the following recommended safety precautions carefully for your safety

1. Power Source

The set should be operated only from a 220-240V AC, 50 Hz. outlet. Ensure you select the correct voltage setting for your convenience.

2. Power Cord

Do not place the set, a piece of furniture, etc. on the power cord (mains lead) or pinch the cord. Handle the power cord by the plug. Do not pull out the plug by tugging the cord and never touch the power cord when your hands are wet as this could cause a short circuit or electric shock. Never make a knot in the cord or tie it with other cord. The power cord should be placed in such a way that they are not likely to be stepped on.

A damaged power cord can cause fire or give you an electric shock. When it is damaged and need to be changed, it should be done by qualified personnel.

3. Moisture and Water

Do not use this equipment in a humid and damp place (avoid the bathroom, the sink in the kitchen, and near the washing machine). Do not expose this equipment to rain or water, as this may be dangerous and do not place objects filled with liquids, such as flower vases on top of the set. Avoid from dripping or splashing.

If any solid object or liquid falls into the cabinet, unplug the set and have it checked by qualified personnel before operating it any further

4. Cleaning

Before cleaning, unplug the set from the wall outlet. Do not use liquid or aerosol cleaners. Use soft and dry cloth.

5. Ventilation

The slots and openings on the back cover are intended for ventilation and to ensure reliable operation. To prevent overheating, these openings must not be blocked or covered in anyway.

6. Heat and Flames

The set should not be placed near to naked flames and sources of intense heat, such as an electric heater. Ensure that no naked flame sources, such as lighted candles, are placed on top of the set

7. Lightning

In case of storm and lightning or when going on holiday, disconnect the power cord from the wall outlet.

8. Replacement Part

When replacement parts are required, be sure the service technician has used replacement parts which are specified by the manufacturer or have the same specifications as the original one. Unauthorised substitutions may result in fire, electrical shock, or other hazards.

9. Servicing

Please refer all servicing to qualified personnel. Do not remove the cover yourself as this may result in an electric shock.

WARNING: *When the device is not in use for a long time, disconnect from power.*

Instructions for waste disposal:

- *Packaging and packaging aids are recyclable and should principally be recycled. Packaging materials, such as foil bag, must be kept away from children.*
- *Battery, including those which is heavy metal-free, should not be disposed of with household waste. Please dispose of used battery in an environmentally sound manner. Find out about the legal regulations which apply in your area.*
- *Cold cathode fluorescent lamp in LCD PANEL contains a small amount of mercury, please follow local ordinances or regulations for disposal.*
- *The mains plug is used to disconnect the TV from the mains and therefore it shall remain readily operable.*

Warning: To prevent injury, this device must be securely attached to the floor/wall in accordance with the installation instructions.

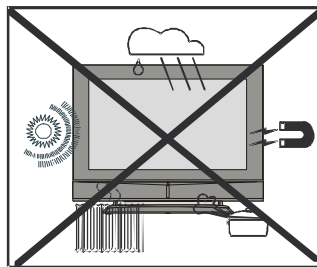

"The LCD panel is very high technology product with about a million thin film transistors, giving you fine picture details. Occasionally, a few non-active pixels may appear on the screen as a fixed point of blue, green or red. Please note that this does not affect the performance of your product."

"DO NOT LEAVE YOUR TV AT STAND-BY OR OPERATING WHEN YOU LEAVE YOUR HOUSE"

Be sure to ground the connection properly.

Connect the ground terminal of TV with the ground terminal provided at the power outlet using the enclosed power cord. If the provided plug does not fit your outlet, consult an electrician for replacement of the obsolete outlet.



Surely connect
the ground wire.

Before Switching On Your TV

Power Connection

IMPORTANT: The TV set is designed to operate on **220-240V AC, 50 Hz.**

- After unpacking, allow the TV set to reach the ambient room temperature before you connect the set to the mains.

Connections To The Aerial Input Socket

- Connect the aerial or cable TV plug to the Aerial input socket located at the rear of the TV and connect the cable plug coming out from the TV out socket located on the devices (VCR, DVB etc.) to this socket as well.

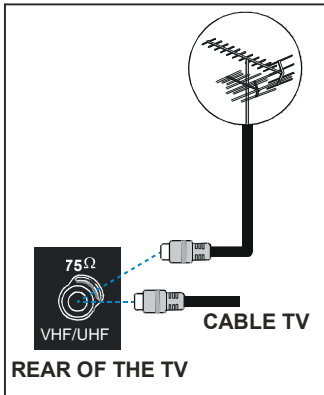

Inserting Batteries In The Remote Control Handset

WARNING : Remote control is battery included. A plastic protector is used to disconnect the batteries in order to prevent the battery life from reducing. Please remove the plastic protector before the first use.

- Remove the battery cover located on the back of the handset by gently pulling backwards from the indicated part.
- Insert two **AAA/R03** or equivalent type batteries inside. Place the batteries in the right directions and replace the battery cover.



Note: Remove the battery from remote control handset when it is not to be used for a long period. Otherwise it can be damaged due to any leakage of battery.

Switching The TV ON/OFF

To switch the TV on:

Your TV will switch on in two steps:

- 1- Connect the power supply cord to the system. Press Power On/Off button. Then the TV switches itself to stand-by mode (Optional).
- 2- To switch on the TV from stand-by mode either: Press a digit button on the remote control so that a programme number is selected, or Press the **"-P/CH"** or **"P/CH+"** button on the TV or press the **"P+"** or **"P-"** button on the remote control, so that last mode switched off is selected.

By either method the TV will switch on.

To switch the TV off:

- Press the **"⏻ (stand-by)"** button on the remote control or On/Off switch on the TV, so the TV will switch to stand-by mode.

To power down the TV completely, press Power On/Off button or unplug the power cord from the mains socket.

Navigating the Menu System

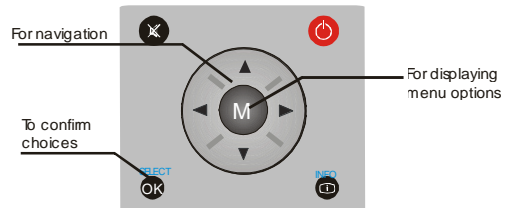

- 1- Press **"M"** to display the menu.
- 2- Press **"▼"** or **"▲"** button to select an icon. Press **"▶"** for more options.
- 3- Use **"▼"** or **"▲"** button to highlight.
- 4- Press **"◀"** or **"▶"** buttons to change the settings. Press **OK** to set as default.
- 5- To exit the menu or return from sub-menu screen, press **"M"**.

These explanations are available for the navigation of the whole Menu System. To select options that are explained in the following parts, refer to "Navigating The Menu System".

Initial Settings

When the TV is turned on for the first time, it is in the digital mode.

Because this is the first time the TV is used, there are no channels stored in the memory and the following message appears on the screen.

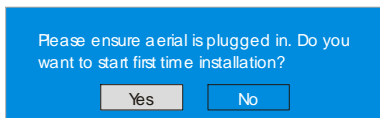

• To start installation process, select **“Yes”**, to cancel select **“No”**.

• To select an option **“Yes or No”**, highlight the item by using **◀** or **▶** buttons and press the **“SELECT”** button.

The IDTV will automatically tune to the UHF transmission channels 21 to 68 looking for digital terrestrial TV broadcasts and displaying the names of channels found. This process will take about five minutes. To cancel searching, you can press the **“M”** button at any time during the process.

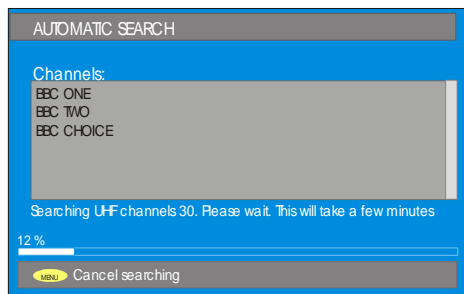

After **Automatic Search** process is completed, the following message asking for analogue channel search appears on the screen. TV switches to the analogue TV mode.

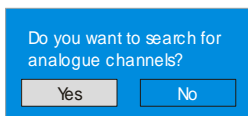

To search for analogue channels, select **“Yes”**. The menu below is displayed to search for analogue channels.

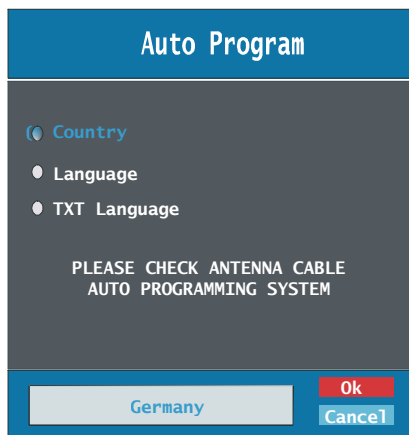

By pressing **“◀”** or **“▶”** button, adjust the **Country** item and press **“▼”** to highlight **“Language”** item. Use **“◀”** or **“▶”** button to set **“Language”**. Use **“◀”** or **“▶”** buttons to select **“TXT Language”** and set it by using **“◀”** or **“▶”** buttons. Press **“OK”** button to continue:

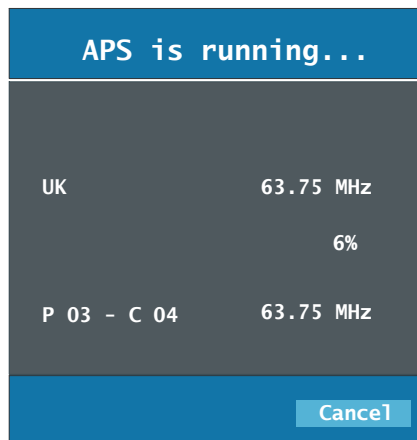

After **APS** is finalized, a programme list will appear on the screen. In the programme list you will see the programme numbers and names assigned to the programmes.

If you do not accept the locations and / or the programme names of programmes, you can change them in **Install Menu**. For details see **“Install Menu”** section.

To display channel list in IDTV, switch to the IDTV via pressing the **“TV/DTV”** button. Then press the **“M”** button to enter main menu, **Channel List** will be highlighted. Press the **“SELECT”** button to enter the menu.

Basic Operations

You can operate your TV using both the remote control and onset buttons.

Operation with the buttons on the TV

Volume Setting

- Press “▲-” button to decrease volume or “▲+” button to increase volume, so a volume level scale (slider) will be displayed at the middle of the bottom on the screen.

Programme Selection

- Press “P/CH+” button to select the next programme or “P/CH-” button to select the previous programme.

Entering Main Menu

- Press the “MENU” button to enter Main menu. In the Main menu select sub-menu using “P/CH-” or “P/CH+” buttons and enter the sub-menu using “▲-” or “▲+” buttons. To learn the usage of the menus, refer to the Menu System sections.

AV Mode

Press the “TV/AV” button at the control panel on the the TV to switch your TV to AV modes.

Operation with Remote Control

The remote control of your TV is designed to control all the functions of the model you selected. The functions will be described in accordance with the menu system of your TV.

Functions of the menu system are described in the following sections.

Volume Setting

Press “V+” button to increase volume. Press “V-” button to decrease volume. A volume level scale (slider) will be displayed in the middle at the bottom of the screen.

Programme Selection (Previous or next programme)

- Press “P-” button to select the previous programme.
- Press “P+” button to select the next programme.

Programme Selection (direct access):

Press digit buttons on the remote control to select programmes between 0 and 9. TV will switch to the selected programme. To select programmes between 10 - 999 (for IDTV) or 10-99 (for analogue), press the digit buttons consecutively which programme you want to select (eg. for programme 27, first press 2 and then 7). When it is late to press second digit button only the first digit programme will be displayed. The limit of the delay time is 3 seconds.

Press directly the programme number to reselect single digit programmes.

Everyday Operation

Pressing the “TV/DTV” button at any time while watching television programmes will switch the TV set between displaying the digital terrestrial television broadcasting and its normal analogue broadcasting.

Information Banner

Whenever you change channel, using the “P-” / “P+” button or the digit buttons, TV displays the channel picture along with an information banner at the bottom of the screen. This will remain on the screen for approximately three seconds. The information banner can also be displayed at any time while watching TV by pressing the “INFO” button on the remote control.

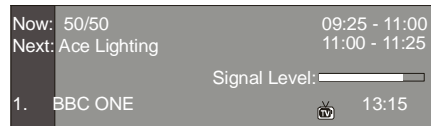

The information banner gives a number of facts on the channel selected and the programmes on it. The name of the channel is displayed, along with its channel list number and an indication of the strength of the signal received on this tuning channel.

Hint

Not all channels broadcast the programme data. If the name and times of the programmes not available then “No Information Available” are displayed in the information banner.

Icons are also displayed in the information banner and if this channel is a favourite channel:

Favourite channel icon .

If the selected channel is locked, you must enter the correct four digit code to view the channel.

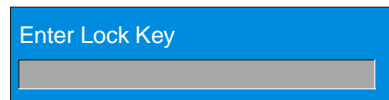

Electronic Programme Guide (EPG)

Some, but not all, channels send information about the current and next events. Please note that event information is updated automatically. If there is no event information data available in channels, only channel names with “No Information Available” banner is displayed.

- Press “GUIDE” button to view the EPG menu.
- In EPG Menu, you can easily see the extended help information by pressing “INFO” button and by pressing this button again you can close this window.



• In the EPG Menu all channels are displayed. Current channel is highlighted. Use ▲ or ▼ buttons to change channels. Also press ▲ or ▼ buttons to make page up/down scroll for the channels.

• If you highlight an event, short event description, extended event description, start and finish times of event are displayed on the screen.

• When the current programme is highlighted, the box is switched to the highlighted channel by pressing the “SELECT” button.

• If you press the “SELECT” button when a next event is highlighted, a reminder is set for the highlighted programme and a clock appears across the highlighted channel line.

Programme reminders can be set to signal that a programme is about to start when you are watching another channel. If you set reminder to a programme, then you will be asked for switching to that channel when the reminder time is reached.

- Press the “M” button to view the 7 day EPG.
- Press ▲ or ▼ button to navigate in Channels or Programmes.
- Press ◀ or ▶ button to navigate through the channel and programme list.



• With “RED/GREEN” buttons you can change schedule time. By pressing “YELLOW/BLUE” you can advance the schedule backward / forward of a day.

• If you press “INFO” button you can see the detailed help information easily. And by pressing “INFO” button again you can exit Help menu.

• The starting time for EPG is the current time. You can see the event information for the next two hours. By pressing ▲ or ▼ button, you can go to the next/previous hours while Programmes list is highlighted.

• If you press the “SELECT” button when a next event is highlighted, a reminder is set for the highlighted programme and a clock appears on the screen. Programme reminders can be set to signal that a programme is about to start when you are watching another channel. If you set reminder to a programme, then you will be asked for switching to that channel when the reminder time is reached.

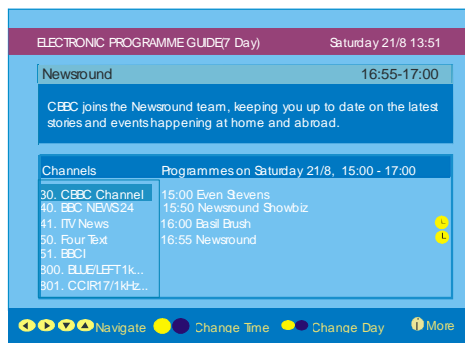

Displaying The Subtitles

With Digital terrestrial broadcasting (DVB-T), some programmes are broadcast with subtitles. Subtitles can be displayed when watching these programmes.

Press the “M” button to display the Main menu, highlight the Configuration line using ▲ or ▼ button and press the “SELECT” button to display the Configuration menu.

Highlight the “Subtitle” item in Configuration menu and use ◀ or ▶ button to set Subtitle to off or a language. If “Subtitle” is on via selecting one language option, pressing the  button causes the following warning message display on the screen.

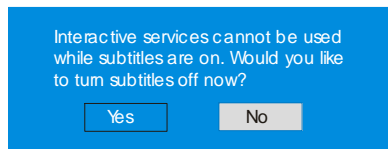

Digital Teletext

With Digital terrestrial broadcasting (DVB-T), in addition to pictures and sound, you can also watch digital teletext.

Digital teletext is sometimes broadcast at the same time as normal broadcasting.

1. Press the button.

The digital teletext information appears.

2. Operate it with the coloured buttons, buttons and OK button.

The operation method may differ depending on the contents of the digital teletext.

Follow the instructions displayed on digital teletext screen.

- When "Press SELECT" button or similar message appears on the screen, press the "SELECT" button.

- When the  (Text) button is pressed, the TV returns to television broadcasting.

- With Digital terrestrial broadcasting (DVB-T), in addition to digital teletext broadcasting at the same time as normal broadcasting, there are also channels with just digital teletext broadcasting.

- The aspect ratio when watching a channel with just digital teletext broadcasting is the same as the aspect ratio of the picture watched previously.

- When you press the  (Text) button again, the digital teletext screen is displayed.

Over Air Download

To ensure that your IDTV always has the most up-to-date information, please ensure that after use it is set to its standby mode. At 3AM each day, the IDTV automatically searches for any new information which may be broadcast and will download this to your IDTV automatically. This operation will normally take approximately 30 seconds.

If you want to do this, you need to set Automatic Download to "Enabled" in Receiver Upgrade setting. For details see [page 13](#).



Widescreen

Depending on the type of broadcast being transmitted, programmes can be viewed in a number of formats. Press the "WIDE" button repeatedly to select between **Auto** or **16:9**.

When **Auto** is selected, the format being displayed is determined by the picture being broadcast.

Please Note: Menu size changes depending on the chosen image size.



IDTV Menu System

The IDTV menu can only be shown when watching Digital terrestrial broadcasting. Press the "/

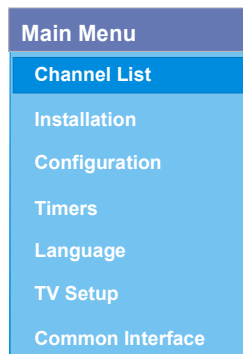
button to turn IDTV on while TV is in analogue mode. Press the "M" button. The menu below appears on the screen:



Channel List

Using the  or  button on the remote control in Main menu, make sure that the first item, Channel List, is highlighted and press the "SELECT" button to display the **Channel List**.



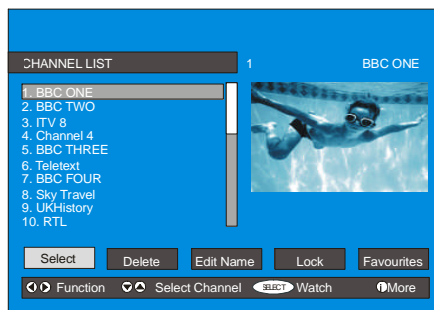

The following operations can be performed in this menu:

1. Navigating the whole list of channels
2. Deleting channels
3. Renaming channels
4. Adding locks to channels
5. Setting favourites

Channel List is the place where the channels are managed.



Navigating the whole channel list

Press  or  button for selecting the previous or next channel. You can press  or  button to move page up or page down.

To watch a specific channel, highlight it using ▲ or ▼ button and then press **“SELECT”** button, while the **“Select”** item on Channel List menu is highlighted by using ◀ or ▶ button.

Then the name and number of the selected channel will be displayed in the top-left and top-right of the channel display at the top-right of the screen, respectively.

Deleting the channels in the channel list

Press ▲ or ▼ button to select the channel that will be deleted.

Press ◀ or ▶ button to select the **“Delete”** item on Channel List menu. As seen on Channel List menu, **SELECT** is written next to **Delete** item at the bottom of the screen to indicate that press the **“SELECT”** button to delete the highlighted channel in the channel list.

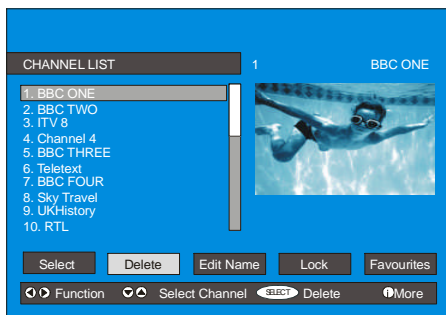

Press the **“SELECT”** button to delete the highlighted channel in the channel list. Then the message below appears on the screen.

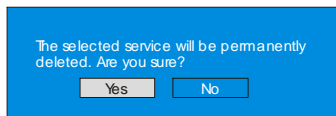

Press ◀ or ▶ button to highlight the desired option. If **“SELECT”** button is pressed while **“Yes”** is highlighted, the highlighted channel is deleted. Selecting **“No”** cancels the delete operation.

Renaming channels

To rename a specific channel, the channel must be highlighted via pressing ▲ or ▼ button and then highlight the **Edit Name** item by pressing ◀ or ▶ button. Press the **“SELECT”** to activate rename feature.



Now pressing ◀ or ▶ button moves to the previous/next character. Pressing ▲ or ▼ button toggles the current character, i.e., **‘b’** character becomes **‘a’** by ▼ and **‘c’** by ▲. Pressing the numeric buttons **‘0...9’** replaces the highlighted character with the characters printed above the button one by one as the button is pressed.

Press the **“M”** button to cancel the editing or **“SELECT”** button to save the new name.

Adding locks to channels

Channel Locking provides a password-protected access to channels selected by parents. In order to lock a channel you should know the Parental Lock password (default value is set to 0000 in the factory and can only be changed from the **Configuration Menu**).

Select the channel to be locked by highlighting it and select the **“Lock”** option by pressing ◀ or ▶ button. When the **“SELECT”** button is pressed, a password box is displayed.

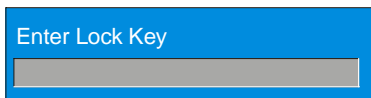
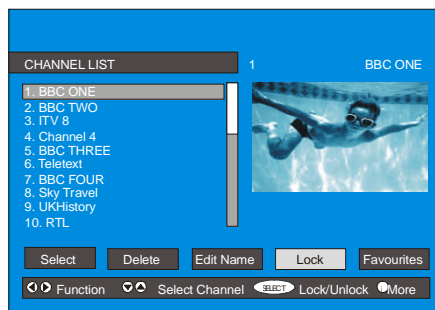

Enter the password using the digit buttons on the remote control. The Lock icon  will now be displayed next to the selected channel. Repeat the same operation to cancel the Lock.

Setting Favourites

You can set various channels as favourites so that only the favourite channels are navigated. To set a favourite you should highlight the **"Favourites"** item at bottom of the Channel List menu.

Use the ◀ or ▶ button to highlight the **"Favourites"** item at the base of the screen and then, in turn, highlight each channel you want to add to the favourites list, using the ▲ and ▼ buttons (or ▲/ ▼ buttons), and press the **"SELECT"** button.

A channel selected as a favourite appears in the main channel list with a favourites icon (😊) against the channel name.

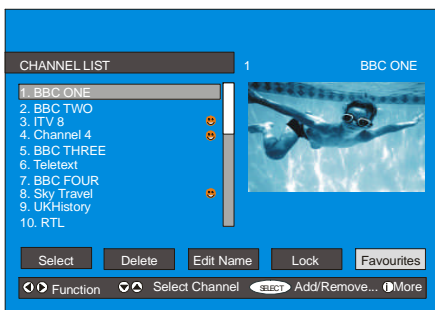

On Screen Help Pressing INFO Button

For all menus press the "INFO" button to display the help information about the menu functions. For **Channel List** menu the following message is displayed on the screen.

Press the SELECT button on your remote control to tune to the highlighted channel.
Press MENU to exit this screen.

Installation

The Installation menu mainly intends to help you for building a **Channel Table** in the most efficient way.

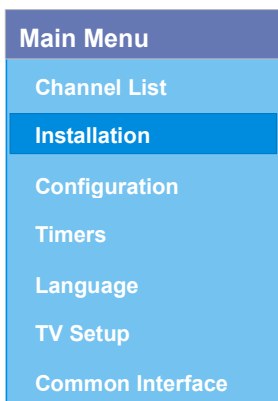

This menu includes the following items:

1. Add New Channels
2. First Time Installation.

ADD NEW CHANNELS:

This tuning menu consists of two parts:

- Automatic Search
- Manual Search



Automatic Search:

Automatic search is started by pressing the **"OK"** button in the auto-search pop up menu. All the services are searched and a channel table is created automatically.

All channels found are stored in a sorted form with respect to their channel numbers. Some services may not appear with the correct channel number. At the time of printing, not all broadcasters are sending their channel number information.

Manual Search:

In manual search, the number of the multiplex is entered manually and only that multiplex is searched for the channels. For every valid channel number, signal level, signal quality and network name are shown at the bottom of the screen.

In both manual and auto search any existing channel in the database is not re-stored to avoid redundant duplicates of that channel.

FIRST TIME INSTALLATION

The user can use this item to load default settings, which had been loaded to the receiver at the factory.

To install factory settings, highlight **"First Time Installation"** menu and press the **"OK"** button, then you will be asked to confirm for deleting all channels and settings.

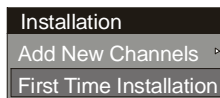

Your previous digital channel list will be destroyed.
Are you sure you want to delete all digital channels and settings for first time installation?

Yes No

By selecting YES and pressing the **"OK"** button, the existing channel table will be deleted.

After factory settings is loaded, **"First Time Installation"** menu will be displayed.

Please ensure aerial is plugged in. Do you want to start first time installation?

Yes No

Press the "OK" button to start installation. After search is completed for digital channels, a message asking search for analogue channels appears on the screen.

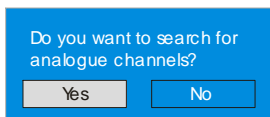

Press the "OK" button to search for analogue channels. The following menu appears on the screen for analogue channel search.

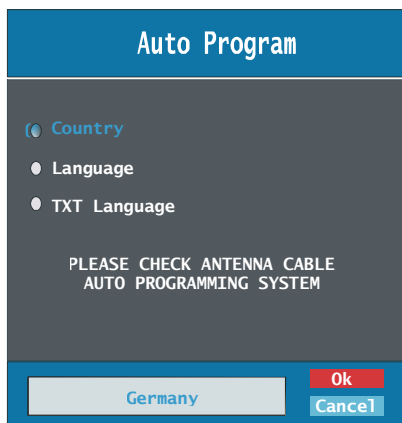

First of all choose Language, Country and TXT Language by using ▲ / ▼ and ◀ / ▶ buttons. This will affect the sort process in APS. To start APS press "OK" button:

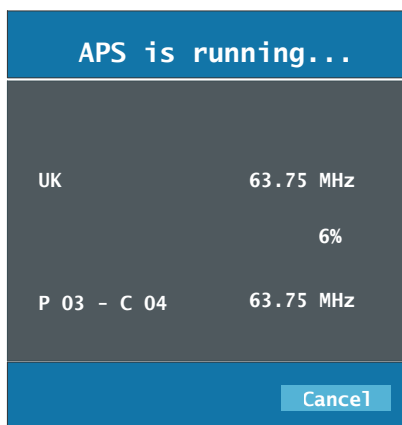

After APS is finalized, the programme table will appear on the screen. In the programme table you will see the programme numbers and names assigned to the programmes.

If you do not accept the locations and / or the programme names, you can change them in the Program menu.

Configuration

Press the "M" button to display the Main Menu and the ▼ button twice to highlight Configuration, then press the "SELECT" button to display the Configuration menu. Press the "M" button to leave the menu.

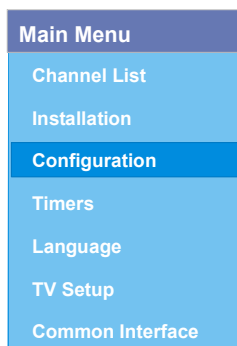

The various configuration functions are displayed in a list, along with a quarter-screen image of the currently selected channel. You can select a function by highlighting the corresponding menu line using the ▲ or ▼ button.

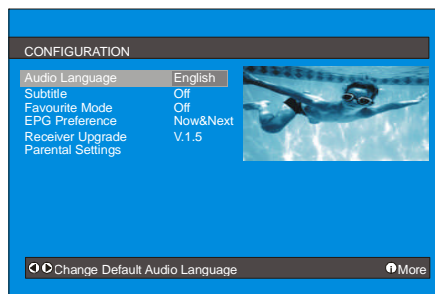

Audio Language

Digital terrestrial television channels can broadcast simultaneous soundtracks in more than one language. This function selects which language soundtrack you will hear when switching to a channel broadcasting with the multiple soundtracks.

Highlight the **Audio Language** line in the Configuration menu and use the ◀ or ▶ button to cycle through the language options.

Subtitle

Digital terrestrial television channels can broadcast subtitles displayed on-screen for the hard-of-hearing. This function selects the desired subtitle language and enables the automatic display of subtitles whenever subtitle information is broadcast.

Highlight the Subtitle line in the Configuration menu and use the ◀ or ▶ button to cycle through "Off" and language options.

Favourite mode

This function enables or disables the favourite channel list mode. See Channel List menu Favourites on page 13.

Use ◀ or ▶ button to turn on/off favourite mode. If the “**Favourite Mode**” is on, in normal operating mode pressing “**P+**” and “**P-**” buttons will only navigate through the channels that were previously defined as favourites in Channel List.

EPG Preference

Digital terrestrial television channels can broadcast simultaneous Next&Now and 7-Day electronic programme.

Highlight the EPG Preference line in the Configuration menu and use the ◀ or ▶ button to select **Next&Now** or **7-Day**.

Receiver Upgrade

The IDTV can be upgraded via the configuration menu, entered from the main menu.

In the Configuration menu, highlight the “**Receiver Upgrade**” item by pressing ▲ or ▼ button and press the “**SELECT**” button to start upgrade process.

There are two possibilities for Receiver software to be upgraded: **automatic** and **manual**.

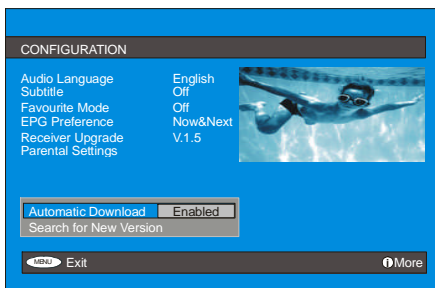

Automatic Download (Automatic upgrade)

Automatic Download can be enabled or disabled by pressing ◀ or ▶ button. If it is enabled, then there are two ways for automatic upgrade. The first one is checking the existence of a new software every time the IDTV goes to standby. The second one is waking up at 03:00 a.m. every night, provided that the IDTV is left in standby mode. Both automatic upgrade methods result in standby mode either upgraded or not.

If the automatic upgrade is set to “**Disabled**” then this function will not work.

Search For New Version (Manual upgrade)

Manual upgrade starts if the “**Search for New Version**” item is highlighted by using ▲ or ▼ button and activated via pressing the “**SELECT**” button.

After “**Search for New Version**” is activated, the IDTV

tunes to each frequency that have been stored in its database and looks for the new software.

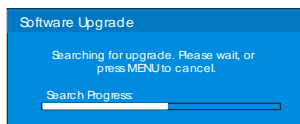

Parental Settings

Some channels broadcast material which you do not want younger members of the family to watch. Any channel can be ‘locked’ so that it cannot be selected for viewing without first a four-digit PIN code being entered. In this way any channel not suitable for younger viewers can be protected.

This function enables or disables the menu protection system and allows the PIN code to be changed.

Use ▲ or ▼ button to go to Parental Settings option. Press the “**SELECT**” button to enter Parental Settings Menu. A box asking for the lock key is displayed.

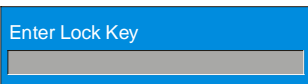

There is only one key which is set to “0000” initially. Enter lock key. If wrong Lock key is entered, the following message is displayed on the screen and it is returned back.



If it is correct, the Parental Settings Menu including following items is displayed:

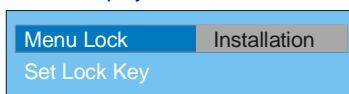

There you can set/reset locking for the Main Menu, or the Installation Menu to restrict access. If the menu lock is disabled, there will be free access to the menu system. Also in this menu you can change the lock key and set/change parental lock mode.

Disabled: All menus are unlocked.

Main Menu: Main menu is accessible only with the correct lock key. So the user cannot add, delete, rename, move channels, cannot set timers.

Installation: Installation menu is locked, so the user cannot add channels.

Changes will be updated after exiting Configuration Menu.

Timers

You can set a timer to switch the TV to any channel without your intervention. This is also for making video recordings of programmes when you are out.

Display the Main Menu by pressing the "M" button. Highlight the **Timers** line by pressing ▲ or ▼ button and press the "SELECT" button to display the Timer menu.

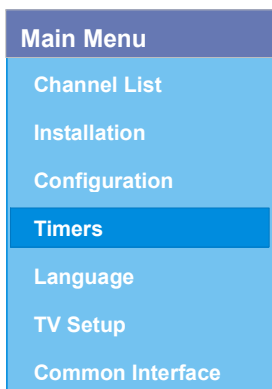

Up to five separate timer events can be set and each is displayed in the Timer screen, showing the event number, the channel to be selected, the start time, end time, date and the mode - whether that event is active (and will be acted on) or not.

TIMER MENU					
No	Channel Name	Start	End	Date	Mode
1.	ITV 1	20:00	21:00	12/05/2005	Active
2.	BBC ONE	00:00	00:00	01/01/2005	Inactive
3.	BBC ONE	00:00	00:00	01/01/2005	Inactive
4.	BBC ONE	00:00	00:00	01/01/2005	Inactive
5.	BBC ONE	00:00	00:00	01/01/2005	Inactive
6.	BBC ONE	00:00	00:00	01/01/2005	Inactive

⏪ Toggle Mode ⏩ Exit ⏪ Edit Timer ⏩ More

• To set an event, highlight its mode button using the ▲ or ▼ button and press the "SELECT" button to display the timer entry window.

Name: 3. ITV 1
 Start: 00:00
 End: 00:00
 Date: 03/06/2005
 Mode: Once

• Here the five settings of channel name, start time, end time, date and frequency mode can be set. You can move freely between each setting using the ▲ or ▼ buttons.

• The channel name is set using the ◀ or ▶ button to display the channel which broadcasts the programme.

• The start time, end time and date are each set with the digit buttons on the remote control in 24-hour format.

• The frequency mode determines how often the receiver operates this event and is set with the ◀ or ▶ button to be either **Once**, **Daily**, or **Weekly**.

If an invalid number for the start or end times or the date is entered, "Entered time is not valid" message appears on the menu.

If timer action occurs while the TV is watched, the TV switches to the selected channel. When timer expires, the TV switches to the channel which it is switched from.

Selected digital channel will be output via Scart-2. You should connect your VCR to Scart-2 for recording digital broadcast.

Language

Some programmes are broadcast in two or more languages simultaneously. The language heard can be selected from the Language Menu.

• Press the "M" button to display the Main Menu and use ▲ or ▼ button to highlight the Language line and press the "SELECT" button.

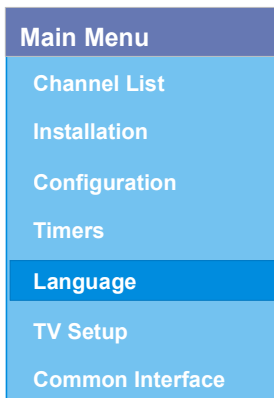

• Use the ▲ or ▼ button to highlight the soundtrack language required and press the "SELECT" button. Normal viewing, with the required language soundtrack, can be resumed by pressing the "M" button.



TV Setup

To be able to go through TV functions, you can use this item.

The digital TV Setup menu screen is accessed from the main menu. Press the "M" button to display the main menu and use ▲ or ▼ button to highlight "TV Setup", press the "SELECT" button to display TV Setup menu screen.

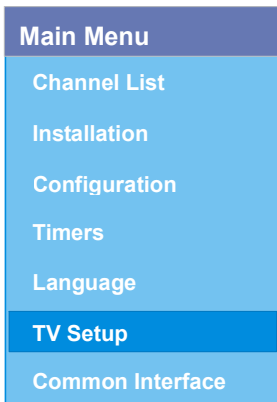

Detailed information about Sound, Picture and Feature menus are in AnalogueTV Menu System section on page 19.

Common Interface

- Press the "M" button to display the Main Menu and use the ▲ or ▼ button to highlight the "Common Interface" line and press the "SELECT" button.

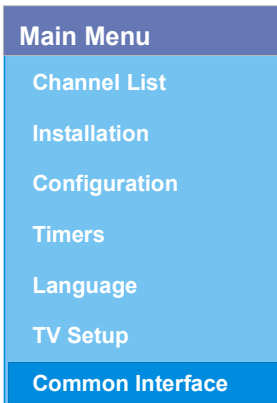

It is required to subscribe to a pay channel company to view the pay channels of the Digital Terrestrial broadcasting.

Obtain the Conditional Access Module (CAM) and the Viewing card by subscribing to a pay channel company, then insert those to the Television using the following procedure.

1. Switch off the TV and unplug from the mains.

2. Insert the CAM, then Viewing Card to the slot that is located in the terminal cover at the left-hand side of the TV (from front view).

- The CAM should be correctly inserted, it is impossible to insert fully if reversed. The CAM or the TV terminal may be damaged if the CAM is forcefully inserted.

3. Connect the TV to the mains supply, switch on and then wait for few moments until the card is activated.

- Some CAMs may require the following set up. Please set the CAM by entering the IDTV menu, Common Interface then pressing the "SELECT" button. (CAM set up menu is not displayed when it is not required.)

- To see the viewing contract information:

Enter IDTV; press the "M" button, then highlight **Common Interface** and press the "SELECT" button.

- When no module is inserted, "**No Common Interface module detected**" message appears on the screen.

- Refer to the module instruction manual for details of the settings.

Analogue TV Menu System

Picture Menu

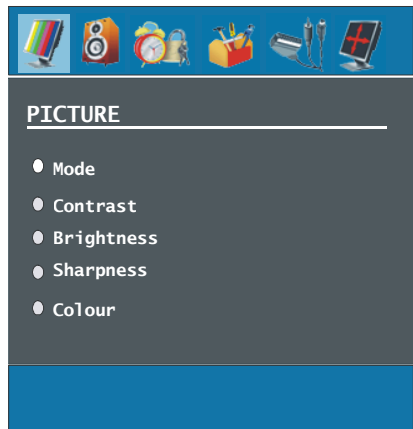

In picture menu if PC, YPbPr or HDMI modes are selected, resolution information is displayed at the bottom of the menu OSD.

Mode

By pressing ▲ / ▼ button, select **Mode**. Press ◀ / ▶ button to choose from one of these options: **Cinema**, **Dynamic** and **Natural**.

Contrast/Brightness/Sharpness/Colour/Hue

By pressing ▲ / ▼ button, select the desired Option.

Press ◀ / ▶ button to set the level.

Hint: Hue is displayed in picture menu when the TV receives an NTSC signal.

Colour Temp

- By pressing ▲ / ▼ button select **Colour Temp**.
- Press ◀ / ▶ to choose from one of these options: **Cool**, **Normal** and **Warm**.

Noise Reduction

By pressing ▲ / ▼ button select **Noise Reduction**. Press ◀ / ▶ to choose from one of these options: **Low, Medium, High** or **Off**.

Film Mode

Films are recorded at a different number offrames per second to normal television programmes.

By pressing ▲ / ▼ button, select Film Mode.

Press ◀ / ▶ button to set this feature On or Off. Turn this feature on when you are watching films to see the fast motion scenes clearly.

Picture Zoom

By pressing ▲ / ▼ button select **Picture Zoom**. Use ◀ / ▶ buttons, to change picture zoom to **Auto, 16:9, 4:3, Panoramic, 14:9 Zoom, Cinema, Subtitle** or **Zoom**.

Reset

By pressing ▲ / ▼ button, select **Reset**. Press ▶ or "OK" button to reset the picture modes to factory default settings.

Store

- By pressing ▲ / ▼ button select **Store**.
- Press ▶ or "OK" button to store the adjustments. "Stored" will be displayed on the screen.

Sound Menu

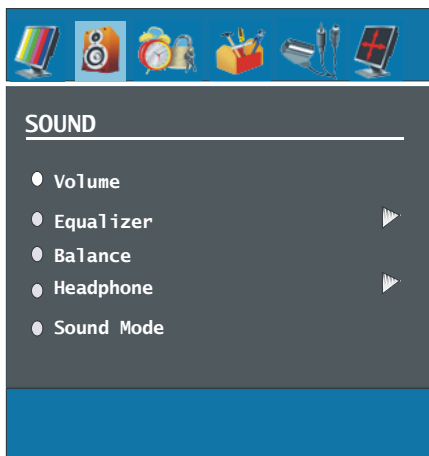

Volume

By pressing ▲ / ▼ select **Volume**. Press ◀ / ▶ button to change the level of the Volume.

Equalizer

By pressing ▲ / ▼ select **Equalizer**. Press ◀ / ▶ button to change the Equalizer setting. In equalizer

menu, the mode can be changed to **Pop, Rock, Jazz, Flat, Classic** or **User**. Select the desired frequency by ▲ / ▼ button and increase or decrease the frequency gain by pressing ◀ / ▶ button.

***Note:** Equalizer menu settings can be altered only when the Equalizer Mode is in User.*

Balance

By pressing ▲ / ▼ select **Balance**. Press ◀ / ▶ button to change the level of the balance. Balance level can be adjusted between -32 and 32.

Headphone

By pressing ▲ / ▼ button, select Headphone. Press ▶ button to enter headphone menu.

volume

By pressing ▲ / ▼ button, select Volume. Press ▶ button to increase hp volume level. Press ◀ button to decrease hp volume level. Headphone volume level can be adjusted between 0 and 63.

sound mode

By pressing ▲ / ▼ button, select Sound Mode. Press ◀ / ▶ button to change sound mode.

Sound mode is used to identify sound mode of the headphone and can be set to mono, stereo, dual I or dual II according to the transmission.

balance

By pressing ▲ / ▼ button, select Balance. Press ▶ button to increase balance to the right. Press ◀ button to decrease balance to the left. Balance level can be adjusted between -32 and +31.

Press the "M" button to return to the previous menu.

Sound Mode

By pressing ▲ / ▼ select **Sound Mode**. Press ◀ / ▶ button, you can select Mono, Stereo, Dual I or Dual II mode, only if the selected channel supports that mode.

AVL

By pressing ▲ / ▼ select **AVL**. Press ◀ / ▶ button to set the AVL as on or off.

Effect

By pressing ▲ / ▼ select **Effect**. Press ◀ / ▶ button to set Effect as on or off.

Dynamic Bass

Dynamic Bass is used to increase bass effect of the TV set.

By pressing ▲ / ▼ button, select Dynamic Bass. By pressing ◀ / ▶ button set Dynamic bass to Low, High or Off. It is not recommended to select High if listening at high volume levels.

Store

- By pressing ▲ / ▼ button select **Store**.
- Press ► or "OK" button to store the adjustments. "Stored" will be displayed on the screen.

Features Menu

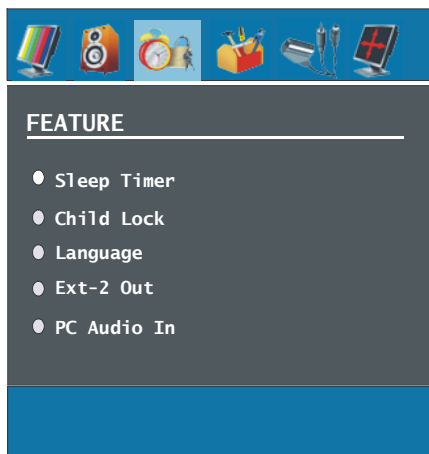

Sleep Timer

By pressing ▲ / ▼ select "Sleep Timer". Press ◀ / ▶ button to set the Sleep Timer.

The timer can be programmed between Off and 120 minutes in steps of 10 minutes.

Child Lock

By pressing ▲ / ▼ select **Child Lock**.

Press ◀ / ▶ button to set the Child Lock on or off. When on is selected, the TV can only be controlled by the remote control handset. In this case the control panel buttons will not work. Hence, if one of these buttons is pressed, "Child Lock On" will be displayed on the screen when the Menu screen is not visible.

Language

By pressing ▲ / ▼ button, select **Language**. Use ◀ / ▶ button to select the language.

EXT2 Out

By pressing ▲ / ▼ select **EXT2 Output**. Use ◀ / ▶ button, to set Ext-2 Out to **TV/DTV, EXT1, FAV, Audio YPbPr or Audio PC**.

Note:

- When TV Source is set to HDMI, HDMI Audio setting will be available among EXT-2 Out options.
- If currently watched source is analogue TV, a connected device displays analogue TV source as well. If this source is set to digital mode, connected device displays digital source. In order to avail this function, EXT-2 Output should be set to TV/DTV.

PC Audio In

By pressing ▲ / ▼ select **Pc Audio In**. By pressing "◀" / "▶" button, you can change the PC Audio In to **TV/DTV, EXT-1, EXT-2, FAV, YPbPr Audio, PC Audio or FAV**.

Blue Background

You can set the TV to automatically change to a blue screen if the signal is weak or absent, or when there is no input from an external device.

The Blue Background feature can be turned on or off by pressing "◀" / "▶" button.

Menu Background

By pressing "▲" / "▼" button, select Menu Background. Transparency level is adjusted by pressing "◀" / "▶" button.

Menu Timeout

By pressing "▲" / "▼" button, select Menu Timeout. Press ◀ / "▶" button to change menu timeout to 15 sec, 30 sec or 60 sec.

Teletext Language

By pressing "▲" / "▼" button, select Teletext Language. Press "◀" / "▶" button to change Teletext Language to West, East, Turk/Gre, Cyrillic, or Arabic.

Default Zoom

By pressing "▲" / "▼" button, select Default Zoom. You can set Default Zoom to Panoramic, 4:3, 14:9 Zoom or 16:9 by pressing "◀" / "▶" button.

Install Menu

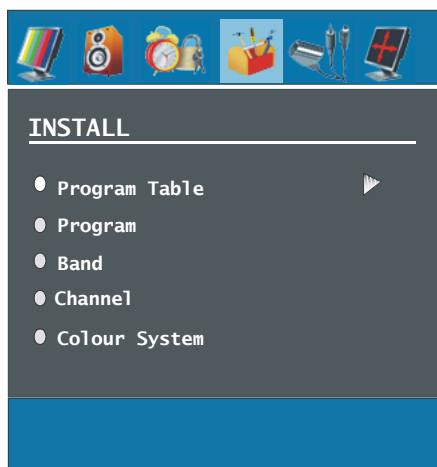

Program Table

By pressing ▲ / ▼ button, select Program Table. Press "▶" to display Program Table.

Program Table			
P01	BBC 1	P11	S 18
P02	C 04	P12	S 29
P03	C 05	P13	S 31
P04	BBC 1	P14	S 33
P05	CH 4	P15	S 34
P06	BBC 2	P16	S 35
P07	C 04	P17	S 36
P08	C 07	P18	S 37
P09	C 12	P19	S 40
P10	C 15	P20	C 21

Name	Insert
Delete	APS

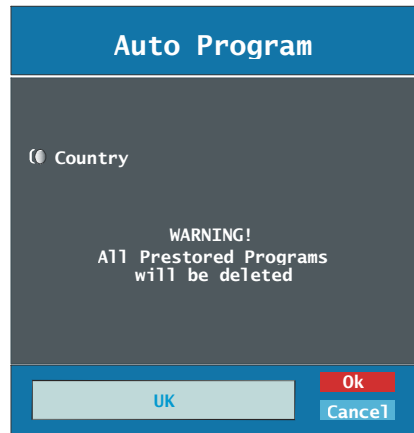

A.P.S. (Auto Programming System) Country

Press ◀ / ▶ button to select your country. If you want to exit from A.P.S. function, press the "BLUE" button.

When you press OK or RED button for starting APS, all stored programs will be erased and the following screen will be displayed:

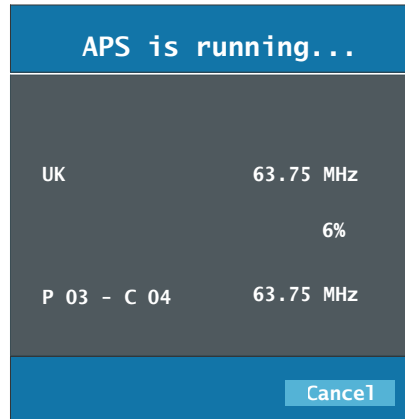

Whenever you press the "BLUE" button, A.P.S. function stops and Program Table appears on the screen.

If you wait until the end of A.P.S., Program Table is displayed with the programmes found and located.

Program

By pressing ▲ / ▼ button, select Program. Press "◀" / "▶" button to select the program number. You can also enter a number via digit buttons on the remote control. There are 100 program storage between 0 and 99.

By moving the cursor in four directions you can reach 20 programmes in the same page. You can scroll the pages up or down by pressing the navigation buttons to see all the programmes in TV mode (except the AV mode). By cursor action, programme selection is done automatically.

Name:

To change the name of a decided programme, select the programme and press the RED button.

The first letter of the selected name will be highlighted. Press ▲ / ▼ button to change that letter and "◀" / "▶" button to select the other letters. By pressing the RED button, you can store the name.

Insert:

Select the programme which you want to insert by navigation buttons. Press the GREEN button. By navigation buttons move the selected programme to the decided programme space and press the GREEN button again.

Delete:

To delete a programme, press the YELLOW button. Pressing the YELLOW button again erases the selected programme from the programme list, and the programmes below shift one up.

APS (Auto Programming System)

When you press the BLUE button for APS, Auto Programming System Menu will appear on the Screen.

Band

Band can be selected either "C" or "S" by press "◀" / "▶" button.

Channel

Channel can be changed by "◀" / "▶" button or Digit Buttons.

Colour System

By pressing ▲ / ▼ button, select Colour System. Press "◀" / "▶" button to change the colour system to PAL, SECAM, PAL60 or AUTO.

If Sound System is set to I, SECAM is not available for the Colour System.

Note: In EXT mode, you can choose NTSC 3.58 and NTSC 4.43 as well.

Sound System

By pressing ▲ / ▼ button, select Sound System. Press "◀" / "▶" button to change the sound system to BG, I, L, L', DK.

Fine Tune

By pressing ▲ / ▼ button, select Fine Tune. Press "◀" / "▶" button to adjust the tuning.

Search

By pressing ▲ / ▼ button, select Search. Press "◀" / "▶" button to start program searching. You can also enter the desired frequency via digit buttons when search item is highlighted.

Store

By pressing ▲ / ▼ button, select Store. Press "▶" or "OK" button to store the adjustments. "Stored..." will be displayed on the screen.

Install menu in AV modes

The following screen appears in the install menu:

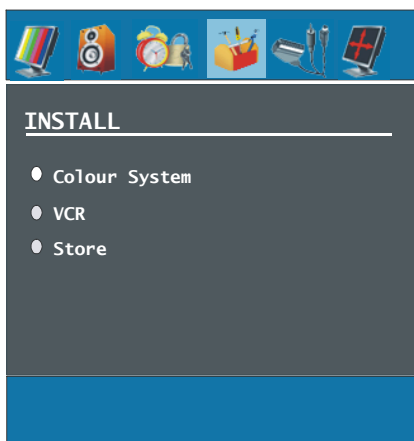

Colour System

By pressing ▲ / ▼ select **Colour System**. By pressing "◀" / "▶" button, you can change the colour system to **PAL, SECAM, PAL 60, NTSC 4,43, NTSC 3,58 or AUTO**.

VCR

By pressing ▲ / ▼ select **VCR**. By pressing "◀" / "▶" button, you can set the VCR to ON or OFF.

Store

By pressing ▲ / ▼ button, select Store. Press "▶" or "OK" button to store the adjustments. "Stored..." will be displayed on the screen.

Source menu

By pressing "◀" / "▶" button, select the fifth icon. Source menu appears on the screen.



In source menu, highlight a source by pressing ▲ / ▼ button and switch to that mode by pressing "▶" or "OK" button. Source options are; TV, DTV, EXT-1, EXT-2, EXT-2 S, FAV, S-VIDEO, **HDMI-1, HDMI-2**, YPBPR and PC.

Note: You can mark desired source options by pressing OK button. Therefore, when (AV) button is pressed, only the marked source options will be available.

PC Mode

Installation

- Power off both Computer and Display before making any connections.
- Set your PC's resolution correctly before connecting to the TV. See the table on Appendix page.
- Use 15-pin display cable to connect a PC to the LCD TV.

Menu System in PC mode

Sound Menu/Feature Menu

The items in these menus are described at **Sound & Feature Menu** explained in "Menu System".

PC Picture Menu

By pressing **▲ / ▼** button, select the second icon. PC Picture menu appears on the screen.

Brightness, Contrast and Colour Temperature adjustments in this menu are identical to adjustments defined in TV picture menu in "MENU SYSTEM".

PC POSITION Menu

By pressing **▲ / ▼** button, select the sixth icon. PC POSITION menu appears on the screen.

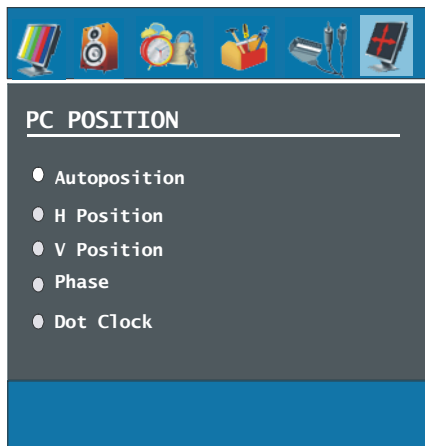

Autoposition

If you shift the picture horizontally or vertically to an unwanted position, use this item to put the picture into correct place automatically.

- Select Autoposition item by using **▲ / ▼** buttons. Press or "OK" button.

Warning: Auto position adjustment recommended to be done with the full screen image for the proper adjustment.

H (Horizontal) Position

This item shifts the image horizontally to right hand side or left hand side of the screen.

- Select H Position item by using **▲ / ▼** button.
- Use "**◀**" / "**▶**" button to adjust the value.

V (Vertical) Position

This item shifts the image vertically towards the top or bottom of the screen.

- Select V Position item by using **▲ / ▼** button.
- Use "**◀**" / "**▶**" button to adjust the value.

Phase

Depending on the resolution and scan frequency that you input to the TV Set, you may see a hazy or noisy picture on the screen. In such a case you can use this item to get a clear picture by trial and error method.

- Use "**◀**" / "**▶**" button to adjust the value.

Dot Clock

Dot Clock adjustments correct interference that appear as vertical banding in dot intensive presentations like spreadsheets or paragraphs or text in smaller fonts.

- Use "**◀**" / "**▶**" button to adjust the value.

Sound in PC mode

- Connect the PC's Audio output to the TV's **PC Audio In** socket with an audio cable.

Other Features

TV Status

Programme Number, **Programme Name**, **Sound Indicator** and **Zoom Mode** are displayed on the screen when a new programme is entered.

Mute Indicator

It is placed in the upper side of the screen when enabled.

Mute

To cancel mute, there are two alternatives; the first one is pressing the **⏮** button and the second one is increasing the volume level.

AV Modes

By pressing the **(AV)** button you can switch your TV to AV modes (except being in teletext). Pressing this button consecutively will switch the TV in one of the optional AV modes: **TV**, **DTV**, **EXT1**, **EXT2**, **EXT2 S**, **FAV**, **S-VIDEO**, **HDMI-1**, **HDMI-2**, **YPBPR** or **PC**.

Personal Preference

By pressing PP button, you may change Picture Mode settings.

Zoom Modes

Zoom mode can be changed by pressing the **WIDE** button. You can change the screen size according to the picture aspect ratio. Select the optimum one from the following **ZOOM** modes.

Note:

- In YBPPr, **HDMI-1 and HDMI-2** modes, while in 720p-1080i resolutions, only FULL mode is available.
- In PC mode, only 4:3 and 16:9 modes are available.

Auto:

When a **WSS (Wide Screen Signalling)** signal, which shows the aspect ratio of the picture, is included in the broadcast signal or the signal from an external device, the TV automatically changes the **ZOOM** mode according to the **WSS** signal.

- When the **AUTO** mode does not function correctly due to poor **WSS** signal quality or when you want to change the **ZOOM** mode, change to another **ZOOM** mode manually.

Zoom:

This uniformly stretches the left and right sides of a normal picture (4:3 aspect ratio) to fill the wide TV screen.

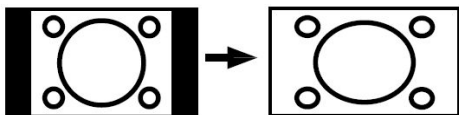

- For 16:9 aspect ratio pictures that have been squeezed into a normal picture (4:3 aspect ratio), use the **Full** mode to restore the picture to its original shape.

Cinema:

This zooms up the wide picture (16:9 aspect ratio) to the full screen.

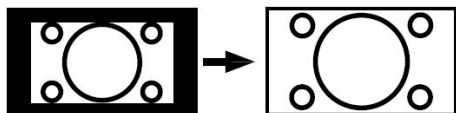

16:9 Zoom:

This zooms up the wide picture (16:9 aspect ratio) to the full screen.

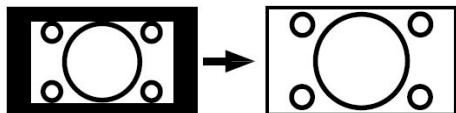

Subtitle:

This zooms up the wide picture (16:9 aspect ratio) with subtitles to the full screen.

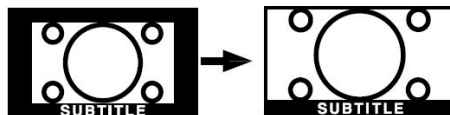

4:3

Use to view a normal picture (4:3 aspect ratio) as this is its original shape.

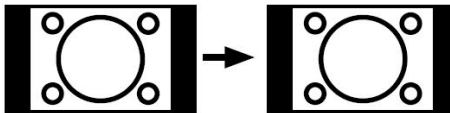

14:9 Zoom:

This zooms up the wide picture (14:9 aspect ratio) to the upper and lower limits of the screen.

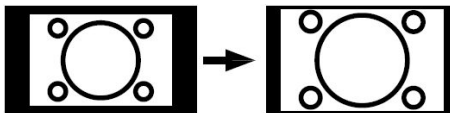

Panoramic:

This stretches the left and right sides of a normal picture (4:3 aspect ratio) to fill the screen, without making the picture appear unnatural.

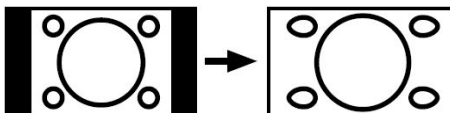

The top and bottom of the picture are slightly cut off.

Freeze Picture

You can freeze the picture on the screen by pressing the "OK" button.

*Note: This feature will be unavailable to be used while watching PC, YBPPr, **HDMI-1 and HDMI-2** sources.*

Teletext













You can display Teletext information on your TV. Each channel which broadcasts teletext, transmits a page with information on how to use its teletext system (usually page 100). Depending on the TV channel, teletext is transmitted in different systems. The colours used in the options line correspond with the colour buttons of your remote control.

- Ensure that the TV is receiving a good signal, or some text errors may occur.
- When four coloured items appear at the bottom of the text page, Fasttext is available. Fasttext allows you to access pages quickly and easily. Press the corresponding coloured button to access the page.

Special Teletext Functions

 To Display a page of text.



The view text services press . To return normal viewing press again. Programmes cannot be changed until text is cancelled.

- To select a page, press the number buttons or program buttons (P+, P-).
- To select index page, press  button.
- To select superimposed over the programme on the screen, press .
- Press  once to enlarge top half of the page, press again to enlarge the bottom half of the page. Press again to revert normal size.
- To discover solutions on quiz and games press .
- At times it is convenient to hold a page of text. Press  to hold a page. The page will be held on screen until the button pressed again.
- To select subcode pages press . Subcode pages are subsections of long Teletext pages that can only be displayed on the screen one section at a time.
- Time information will be displayed on screen after pressing  button. If the programme does not have teletext transmission, no information will be displayed.
- When  button is pressed while in teletext mode, the screen will be splitted into two windows, one displaying the teletext and the other displaying the current channel. Press the  button or  /  button to exit from teletext.
- To exit text press .

Note: If the signal becomes insufficient, the teletext mode will be quitted.

Fastext

Your TV supports the 500 page Teletext system. When the page number of any of the 500 pages in memory is entered, the system will not search for the requested page; instead it will display the page automatically. If the requested page is not in memory, the system will search for the requested page number and save the 500 pages including the requested page into memory after finding it.

- Press the  button to move the Teletext screen forward one page at a time.
- Press the  button to move the Teletext screen backward one page at a time.

For Fastext

The subject-heading for the information may have a particular colour.

- Press an appropriate **RED**, **GREEN**, **YELLOW** or **BLUE** button in order to reach the relevant page quickly.

TOP text

TOP text mode of operation will be activated automatically according to the transmission.

- If TOP text transmission is present, colour coded buttons will appear in status row.
- If TOP text transmission is not present, status row will not appear.

The subject-heading for information may be located in colored box.

In Top mode the **"P+"** or **"P-"** commands will request the next or previous page respectively. If TOP text transmission is not available, in case of operation of these commands, wraparound occurs. For example page 100 appears to be one greater than page 199.

Connect Peripheral Equipment

High Definition

Your LCD Television is capable of displaying High Definition pictures from devices such as a High Definition Satellite Receiver or DVD Player. These devices must be connected via the **HDMI-1**, **HDMI-2** socket or Component Socket. These sockets can accept either 720p or 1080i signals.

Note: When it is desired to watch **HDMI-1** and **HDMI-2** source with a DVI to HDMI cable; in order to enable audio, Audio Input (which is located at the left side of the antenna input) is to be used to get DVI device's audio signals.

Via The Scart

The TV has 2 Scart sockets. If you want to connect peripherals (e.g. video, decoder, etc.) which have Scart sockets to the TV, you can use SCART socket of the TV.

Note: If an external device is connected via the Scart sockets, the TV will automatically switch to AV mode. If both sockets are employed at the same time, SCART 1 becomes the preferential.

Via Aerial Input

If the device you want to connect does not have a Scart socket, you should connect it to the Aerial input of the TV.

If the VCR is connected via Aerial input, it is suggested to use Programme 0.

Decoder

If you are subscribed to cable TV offers, the organisation will supply you a corresponding decoder unit to allow the programmes to be unscrambled.

For further information consult your dealer.

Connect a decoder with an aerial socket to the TV

- Connect the aerial cable.

Connect a decoder without an aerial socket to the TV

- Connect the decoder to the EXTERNAL socket of TV with a RCA cable. Through the SCART/RCA socket of the decoder, you may attain a better display resolution.

TV And Video Recorder

- Connect the aerial cables.

Better picture quality can be obtained if you also connect a Scart cable to **SCART** sockets.

Playback NTSC

- Connect NTSC VCR player to a Scart socket of the TV.

Then, press the “**AV**” button to select EXT1 or EXT2.

Copy Facility

Source selection for **VCR** recording.

- Select **Feature** menu.
- Select **SCART 2 Out** by pressing ◀ / ▶ button.
- For copying the picture that comes from the tuner, select SCART 1.

Camera And Camcorder

To Connect To AV Input

Connect your camera or camcorder to AV input of the TV.

- Connect your equipment to the TV via **VIDEO** (yellow), **AUDIO R** (red) and **AUDIO L** (white) inputs. You must connect the jacks into the input with the same colour.

To Connect To S-VHS Input

Connect your camera or camcorder S-VHS input of the TV.

- Connect your equipment to the TV via S-VHS input and audio inputs of AV inputs by using S-VHS cables.

Connect The Decoder To The Video Recorder

Some video recorders have a special Scart socket for decoder.

- Connect a Scart cable to the Scart socket of your decoder and to the special Scart socket of your video recorder. Refer to the booklet of your video recorder.

Connecting Headphones (optional)

Use the stereo headphone socket of the TV, to connect headphones.

Note: If you want to connect more equipment to your TV, consult your dealer.)

Audio Lineout

To connect the external speakers to your TV, use the Headphone Line Out of the TV. Additionally, turn “Line out” setting on in the “Sound Menu”.

Note: While watching PC or YPbPr sources, Lineout selection could only be the current source.

Tips

Care Of The Screen

Clean the screen with a slightly damp, soft cloth. Do not use abrasive solvents as they may damage the TV screen coating layer.

Poor Picture

Have you selected the correct TV system? Is your TV set or house aerial located too close to non-earthed audio equipment or neon lights, etc.?

Mountains or high buildings can cause double pictures or ghost images. Sometimes you can improve the picture quality by changing the direction of the aerial.

Is the picture or Teletext unrecognisable? Check if you have entered the correct frequency.

The picture quality may degrade when two peripherals are connected to the TV at the same time. In such a case, disconnect one of the peripherals.

No Picture

Is the aerial connected properly? Are the plugs connected tightly to the aerial socket? Is the aerial cable damaged? Are suitable plugs used to connect the aerial? If you are in doubt, consult your dealer.

No Picture means that your TV is not receiving a transmission. Have you selected the correct button on the remote control? Try once more.

Sound

You can not hear any sound. Did you perhaps interrupt the sound, pressing the  button?

Sound is coming from only one of the speakers. Is the balance set to one extreme? See **Sound** menu.

Remote Control

Your TV no longer responds to the remote control. Perhaps the batteries are exhausted. If so you can still use the local buttons at the bottom of the TV.

Specifications

TV BROADCASTING

PAL/SECAM B/G D/K K' I/I' L/L'

RECEIVING CHANNELS

VHF (BAND I/III)

UHF (BAND U)

HYPERBAND

CABLE TV (S1-S20/ S21-S41)

NUMBER OF PRESET CHANNELS

100

CHANNEL INDICATOR

On Screen Display

RF AERIAL INPUT

75 Ohm (unbalanced)

OPERATING VOLTAGE

220-240V AC, 50Hz

AUDIO

German+Nicam Stereo

AUDIO OUTPUT POWER (W_{RMS}) (%10 THD)

2 x 8

POWER CONSUMPTION (W)

160 W (max)

2,7 W (Stand-by)

PANEL

16:9 display, 26" Screen Size

DIMENSIONS (mm)

DIMENSIONS (mm)				
D	L	H	Weight (kg)	
210	699	546	11,5	With stand
126	699	499	10,0	Without stand

Appendix A: PC Input Typical Display Modes

The display has a maximum resolution of 1360 x 768, frequency range of 56-75 Hz. The following table is an illustration of some of the typical video display modes.

Mode	Resolution		Frequency	
	Horizontal	Vertical	Hor. (kHz)	Ver. (Hz)
1	640	480	31,5	60
2	640	480	37,9	72
3	640	480	37,5	75
4	800	600	35,2	56
5	800	600	37,9	60
6	800	600	48,1	72
7	800	600	46,9	75
8	1024	768	48,4	60
9	1024	768	56,5	70
10	1024	768	60	75
11	1280	1024	64	60
12	1280	768	47,8	60
13	1360	768	47,7	60

Appendix B: Aerial Connection

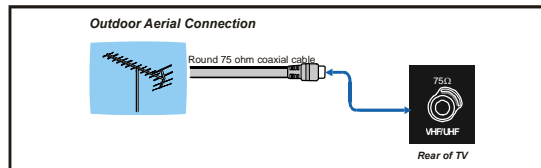

Appendix C: Connect Peripheral Equipment

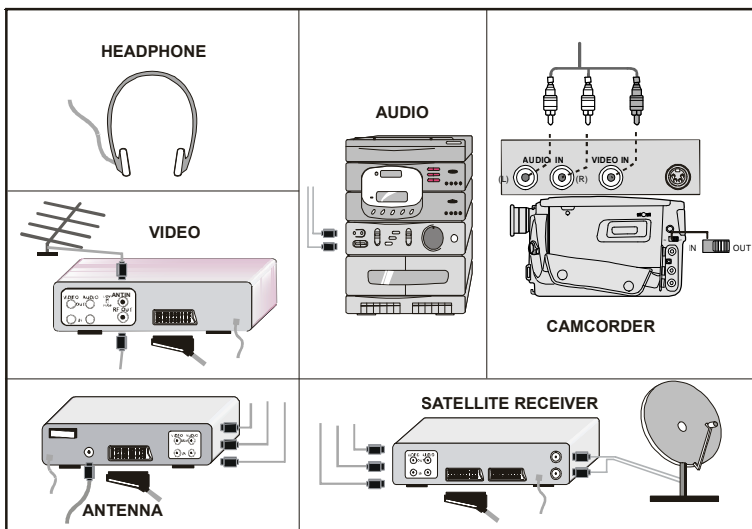

Peripheral Equipment Connections

- Ⓐ S-VHS Input
- Ⓑ Video Input
- Ⓒ Audio Inputs
- Ⓓ Headphone
- Ⓔ Audio Line Outs
- Ⓕ Spdif Coaxial Output
- Ⓖ Power Cord Input
- Ⓗ Power On/Off Switch
- Ⓘ HDMI Input 2
- Ⓝ HDMI Input 1
- Ⓚ For Service Use Only
- Ⓛ SCART 2
- Ⓜ SCART 1
- Ⓝ Component Audio Inputs
- Ⓞ Component Video Inputs (YBPbr)
- Ⓟ RF
- Ⓡ PC Audio Input
- Ⓢ PC Input

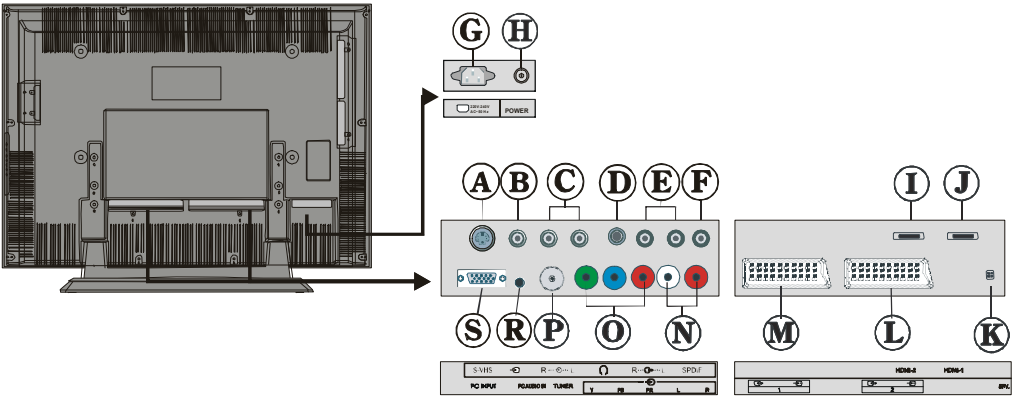

Note: Because FAV CVBS and SVHS Y are connected parallelly, the picture may blend if the two peripherals are used at the same time. Likewise, because SVHS C and SCART II R are connected parallelly, the picture may blend if the two peripherals are used at the same time. Thus these two are not to be used at the same time.

Information for users applicable in European Union countries



This symbol on the product or on its packaging means that your electrical and electronic equipment should be disposed at the end of life separately from your household wastes. There are separate collection systems for recycling in EU. For more information, please contact the local authority or the dealer where you purchased the product.

Important Instruction

For your own safety read following instruction carefully before attempting to connect this unit to the mains supply.

MAINS (AC) OPERATION

The wires in the mains lead are coloured in accordance with the following code :

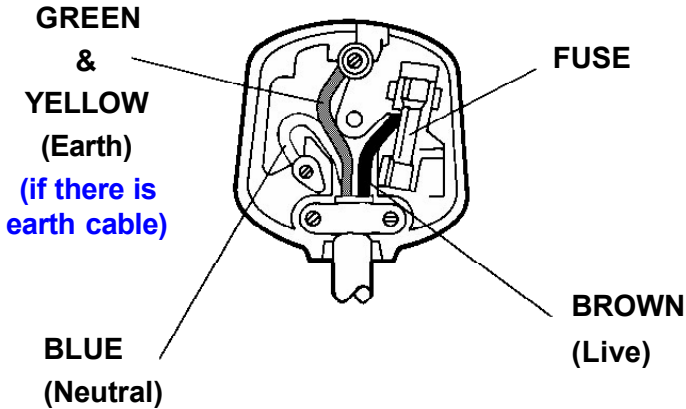

IMPORTANT

As the colours of the wires in the mains lead of this appliance may not correspond with the coloured markings identifying the terminals in your plug, proceed as follows:

The wire which is coloured green and yellow must be connected to the terminal which is marked with the letter E, or by the earth symbol, or coloured green or green and yellow.

The wire which is coloured blue or black must be connected to the terminal which is marked with the letter N or coloured Black.

The wire which is coloured brown or red must be connected to the terminal which is marked with the letter L or coloured Red.

For continued protection against risk of fire, replace only with same type and rating of fuse (ASTA approved 5A 250VAC fuse).

CAUTION

TO PREVENT ELECTRIC SHOCK DISCONNECT FROM THE MAINS BEFORE REMOVING COVER. NO USER SERVICEABLE PARTS INSIDE. REFER SERVICING TO QUALIFIED SERVICE PERSONNEL.

SAFETY PRECAUTION

THIS EQUIPMENT MUST BE DISCONNECTED FROM THE MAINS WHEN NOT IN USE. DO NOT ALLOW THIS UNIT TO BE EXPOSED TO RAIN OR MOISTURE.

THE GUARANTEE

The seller of this equipment (the vendor) warrants to the initial retail purchaser that if the equipment becomes defective, and the defect is shown to be due to faulty materials or workmanship within a period of 12 Months from the date of sale to the original purchaser it will be repaired (or at the vendors sole option) replaced free of charge, always providing that: The equipment has at all times been used in accordance with the operating instructions issued by the manufacturer, and has not been connected to an electrical supply for which it has not been properly adjusted.

Unauthorised repairs or modifications, which have not been expressly approved by the manufacturer, shall render this guarantee null and void.

This guarantee is not transferable and is only applicable in the UK.

Nothing in this express warranty affects the statutory rights available to the purchaser of this equipment

EXCLUSIONS

SANYO shall not be liable for any removal or installation or re-installation of the equipment.

The warranty does not cover Failure due to fair wear and tear of any item.

Cosmetic items, remote controls or parts and consumable items such as lamps, filters, batteries, tapes, cables or connectors.

Accidental damage or damage caused by negligence or misuse by the user.

Failure caused by lightning strike, storage or operation outside the specified environment, incorrect installation, lack of routine maintenance outlined in the operating instructions supplied with the unit, incorrect fitting of lamps, filters, batteries or other consumables or parts.

Units not originally supplied by SANYO Europe Ltd through a UK Reseller.

Dear Customer.

Thank you for buying SANYO. This equipment should give you many years of pleasure and faithful service but in the event that a fault occurs, the following notes for your guidance may be helpful:-

- 1: PLEASE RETAIN YOUR PURCHASE RECEIPT WHICH WILL BE REQUIRED FOR SERVICE DURING WARRANTY.
- 2: If your SANYO equipment proves faulty during the period of guarantee, take it or send it back to the dealer who originally supplied it together with this guarantee and the proof of purchase. We have made arrangements with our approved dealers under which they will carry out in guarantee service repairs on our behalf. In this way, we hope to reduce to a minimum the amount of time you will be without your equipment.
- 3: If for some reason it is impossible to return the equipment to the original supplier, please contact our Customer Relations Department at the address below for further advice.
- 4: Should the equipment require servicing after the expiry of the guarantee period, take or send it to the original supplier or any other Sanyo dealer. He will be pleased to give you a quotation for the repair.

Customer Relations Department,
SANYO Europe Ltd.
SANYO House,
18, COLONIAL WAY,
Watford, Hertfordshire, WD24 4PT.
Tel: 01923 246363

SANYO

SANYO Electric Co., Ltd.



50105006

