

# SANYO

**INSTRUCTION MANUAL**

**CE42FD33-B**

**Colour television**

ENGLISH  
1 - 47

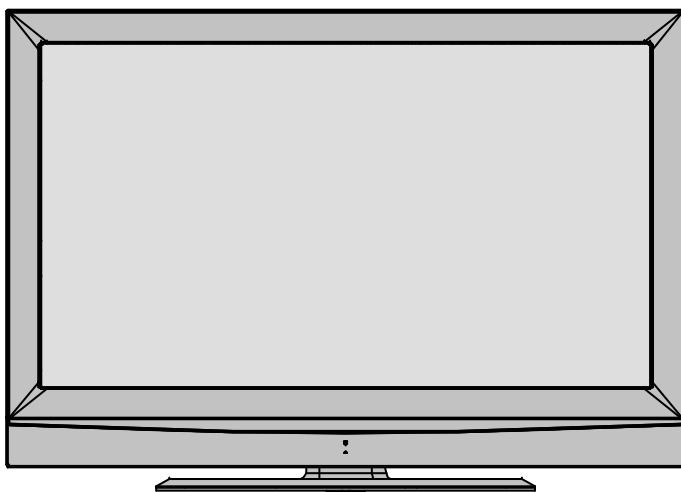

**Please read this Instruction book before using your television.  
We wish you many hours of pleasure from your new television.**

**Problems with set-up?**

**Call 0870 240 7475**

# Contents

Features .....	3	Navigating the Entire Channel List .....	21
Accessories .....	3	Deleting the Channels in the Channel List ...	21
Introduction .....	4	Renaming Channels .....	22
Preparation .....	4	Adding Locks to Channels .....	22
Safety Precautions .....	4	Setting Favourites .....	22
Power Source .....	4	On Screen Help .....	23
Power Cord .....	4	Installation .....	23
Moisture and Water .....	4	Add New Channels .....	23
Cleaning .....	4	Automatic Search .....	23
Ventilation .....	5	Manual Search .....	23
Heat and Flames .....	5	Configuration .....	24
Lightning .....	5	Audio Language .....	25
Replacement Parts .....	5	Subtitle .....	25
Servicing .....	5	Favourite Mode .....	25
Waste Disposal .....	5	EPG Preference .....	25
Disconnecting the Device .....	6	Receiver Upgrade .....	25
Headphone Volume .....	6	Automatic Download (Automatic	
Installation .....	6	Upgrade) .....	26
LCD Screen .....	6	Search for New Version (Manual	
Warning .....	6	Upgrade) .....	26
Overview of the Remote Control .....	7	Parental Settings .....	26
LCD TV and Operating Buttons .....	8	Timers .....	27
Viewing the Connections .....	9	Language .....	27
Power Connection .....	11	TV Setup .....	28
Aerial Connection .....	12	Common Interface .....	28
Connecting the LCD TV to a PC .....	13	Menu System .....	29
Connecting to a DVD Player .....	14	Picture Menu .....	29
Inserting Batteries in the Remote Control		Pixellence Demo .....	29
Handset .....	15	Mode .....	29
Operating Range for the Remote Control .....	15	Contrast/Brightness/Sharpness/Colour/Hue .....	29
Switching the TV On/Off .....	16	Colour Temp .....	29
To Switch the TV On .....	16	Noise Reduction .....	30
To Switch the TV Off .....	16	Film Mode .....	30
Navigating the Menu System .....	16	Store .....	30
Initial Settings .....	16	Reset .....	30
Basic Operations .....	17	Sound Menu .....	30
Operation with the Buttons on the TV .....	17	Volume .....	30
Volume Setting .....	17	Equalizer .....	30
Programme Selection .....	17	Balance .....	30
Entering Main Menu .....	17	Headphone .....	31
AV Mode .....	17	Volume .....	31
Operation with the Remote Control .....	17	Balance .....	31
Volume Setting .....	18	Sound Mode .....	31
Programme Selection (Previous or Next		AVL .....	31
Programme) .....	18	Effect .....	31
Programme Selection (Direct Access) .....	18	Dynamic Bass .....	31
Everyday Operation .....	18	3D Panorama .....	31
Information Banner .....	18	Subwoofer .....	31
Electronic Programme Guide (EPG) .....	18	Store .....	31
Displaying the Subtitles .....	19	Feature Menu .....	32
Digital Teletext .....	20	Sleep Timer .....	32
Over Air Download .....	20	Child Lock .....	32
Widescreen .....	20	Language .....	32
IDTV Menu System .....	21	EXT-2 Out .....	32
Channel List .....	21	Default Zoom .....	32

Blue Background .....	32	Teletext .....	40
Menu Background .....	32	Appendix A: PC Input Typical Display Modes .....	41
Menu Timeout .....	33	Appendix B: DVI Typical Display Modes .....	42
Teletext Language .....	33	Appendix C: Main and PIP-PAP Picture Combinations .....	43
Install Menu .....	33	Appendix D: AV and HDMI Signal Compatibility ...	44
Program .....	33	Appendix D: Pin Specifications .....	45
Band .....	33	Appendix E: Important Instruction .....	46
Channel .....	33	Specifications .....	47
Colour System .....	33		
Sound System .....	33		
Fine Tune .....	34		
Search .....	34		
VCR .....	34		
Store Program .....	34		
Program Menu .....	34		
Name .....	34		
Insert .....	34		
Delete .....	34		
APS (Auto Programming System) .....	35		
Country .....	35		
Install Menu in AV Modes .....	35		
Colour System .....	35		
VCR .....	35		
Store Program .....	35		
Source Menu .....	35		
PC Mode Menu System .....	36		
Sound Menu .....	36		
Feature Menu .....	36		
PC Picture Menu .....	36		
PC Picture Position Menu .....	36		
Autoposition .....	37		
H (Horizontal) Position .....	37		
V (Vertical) Position .....	37		
Dot Clock .....	37		
Phase .....	37		
Displaying TV Information .....	38		
Mute Function .....	38		
PIP (Picture-in-Picture) and PAP (Picture-and- Picture) Modes .....	38		
Picture Mode Selection .....	38		
Freezing Picture .....	38		
Zoom Modes .....	38		
Auto .....	38		
Full .....	39		
4:3 .....	39		
Panoramic .....	39		
14:9 Zoom .....	39		
Cinema .....	39		
16:9 Subtitle .....	39		

## Features

- Remote controlled colour LCD TV.
- Fully integrated digital TV (DVB-T).
- It has three HDMI connectors for digital video and audio. This connection is also designed to accept high definition signals.
- Full HD (1920x1080).
- 100 programmes from VHF, UHF bands or cable channels can be preset.
- It can tune cable channels.
- OSD menu system.
- It has 2 scart sockets for external devices (such as video, video games, audio set, etc.).
- AV in and S-Video in are available.
- Stereo sound system (3D Panorama).
- Teletext, fasttext, TOP text.
- Headphone connection.
- Automatic programming system.
- Forward or backward automatic tuning.
- Sleep timer.
- Child lock.
- Automatic sound mute when no transmission.
- NTSC playback.
- PIP / PAP functions.
- AVL (Automatic Volume Limiting).
- When no valid signal is detected, after 5 minutes the TV switches itself automatically to standby mode.
- PLL (Frequency Search).
- PC input.
- Plug&Play for Windows 98, ME, 2000, XP, Vista.
- Audio line out.

## Accessories



Remote Controller

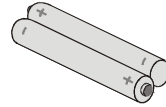

Batteries  
2 XAAA

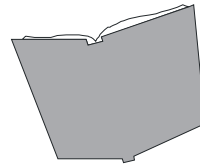

Instruction Book

## Introduction



Thank you for choosing this product. This manual will guide you for the proper operation of your TV. Before operating the TV,

please read this manual thoroughly.

Please do keep this manual in a safe place for future references.

## Preparation

For ventilation, leave a free space of at least 10 cm all around the set. To prevent any fault and unsafe situations, please do not place any objects on top of the set.

Use this device in moderate climates.

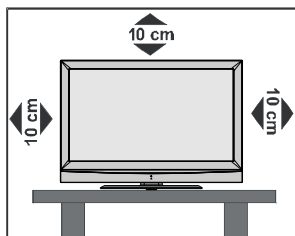

## Safety Precautions

Please read the following recommended safety precautions carefully for your safety.

### Power Source

The TV set should be operated only from a 220-240 V AC, 50 Hz outlet. Ensure that you select the correct voltage setting for your convenience.

## Power Cord

Do not place the set, a piece of furniture, etc. on the power cord (mains lead) or pinch the cord. Handle the power cord by the plug. Do not unplug the appliance by pulling from the power cord and never touch the power cord with wet hands as this could cause a short circuit or electric shock. Never make a knot in the cord or tie it with other cords. The power cords should be placed in such a way that they are not likely to be stepped on. A damaged power cord can cause fire or give you an electric shock. When it is damaged and needs to be replaced, it should be done by qualified personnel.

## Moisture and Water

Do not use this device in a humid and damp place (avoid the bathroom, the sink in the kitchen, and near the washing machine). Do not expose this device to



rain or water, as this may be dangerous and do not place objects filled with liquids, such as flower vases, on top. Avoid from dripping or splashing.

If any solid object or liquid falls into the cabinet, unplug the TV and have it checked by qualified personnel before operating it any further.

## Cleaning

Before cleaning, unplug the TV set from the wall outlet. Do not use liquid or aerosol cleaners. Use soft and dry cloth.

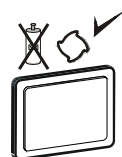

## Ventilation

The slots and openings on the TV set are intended for ventilation and to ensure reliable operation. To prevent overheating, these openings must not be blocked or covered in anyway.

## Heat and Flames

The set should not be placed near to open flames and sources of intense heat such as an electric heater. Ensure that no open flame sources, such as lighted candles, are placed on top of the TV. Batteries should not be exposed to excessive heat such as sunshine, fire or the like.



## Lightning

In case of storm and lightning or when going on holiday, disconnect the power cord from the wall outlet.



## Replacement Parts

When replacement parts are required, make sure that the service technician has used replacement parts, which are specified by the manufacturer or have the same specifications as the original one. Unauthorized substitutions may result in fire, electrical shock or other hazards.

## Servicing

Please refer all servicing to qualified personnel. Do not remove the cover yourself as this may result in an electric shock.



## Waste Disposal

Instructions for waste disposal:

- Packaging and packaging aids are recyclable and should principally be recycled. Packaging materials, such as foil bag, must be kept away from children.
- Batteries, including those which are heavy metal-free, should not be disposed of with household waste. Please dispose of used battery in an environment friendly manner. Find out about the legal regulations which apply in your area.
- Cold cathode fluorescent lamp in LCD PANEL contains a small amount of mercury; please follow the local laws or regulations for disposal.

## **Disconnecting the Device**

The mains plug is used to disconnect TV set from the mains and therefore it must remain readily operable.

## **Headphone Volume**

Excessive sound pressure from earphones and headphones can cause hearing loss.



## **Installation**

To prevent injury, this device must be securely attached to the wall in accordance with the installation instructions when mounted to the wall (if the option is available).

## **LCD Screen**

The LCD panel is a very high technology product with about a million thin film transistors, giving you fine picture details. Occasionally, a few non-active pixels may appear on the screen as a fixed blue, green or red point. Please note that this does not affect the performance of your product.

## **Warning**

Do not leave your TV in standby or operating mode when you leave your house.

# Overview of the Remote Control

- 1 Stand By
- 2 Cursor Up
- 3 Cursor Right
- 4 Info
- 5 Direct Programme
- 6 No function
- 7 Programme Up
- 8 Volume Up
- 9 TV / DTV
- 10 External Source
- 11 Feature Menu /Audio Language On/Off in DTV
- 12 Installation Menu
- 13 Hold / PIP position
- 14 Update, PAP Mode
- 15 Index Page / Electronic Programme Guide (EPG)
- 16 Reveal / Switch from TV to PC
- 17 Expand / Image size
- 18 Mix / PIP mode
- 19 Teletext
- 20 Time
- 21 Page Up
- 22 Page Down/  
Picture subtitle on/off in the digital mode
- 23 Previous Programme
- 24 Mono/Stereo - Dual I-II
- 25 Programme Down
- 26 Volume Down
- 27 Picture Mode Selection
- 28 Okay (Store)
- 29 Cursor Down
- 30 Cursor Left
- 31 Menu
- 32 Mute

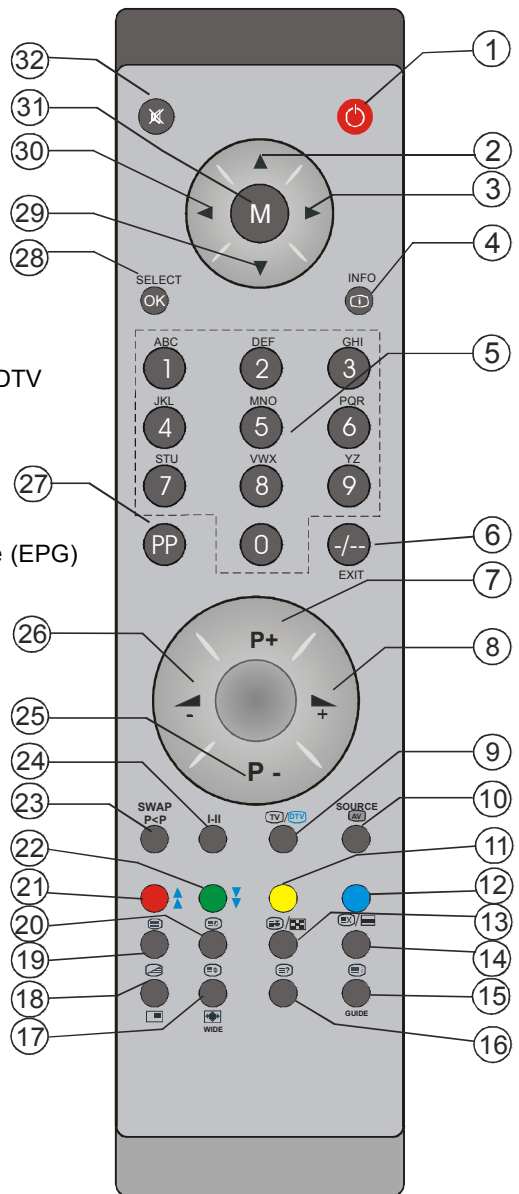



# LCD TV and Operating Buttons

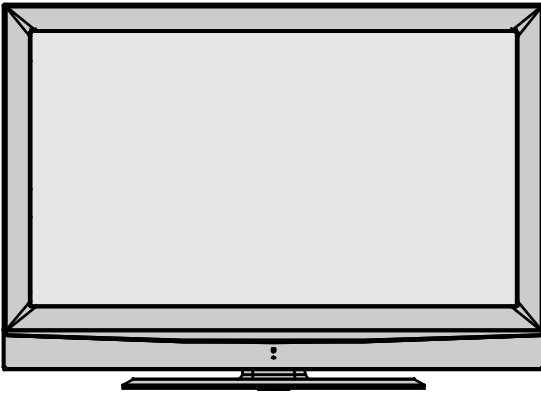

FRONT VIEW

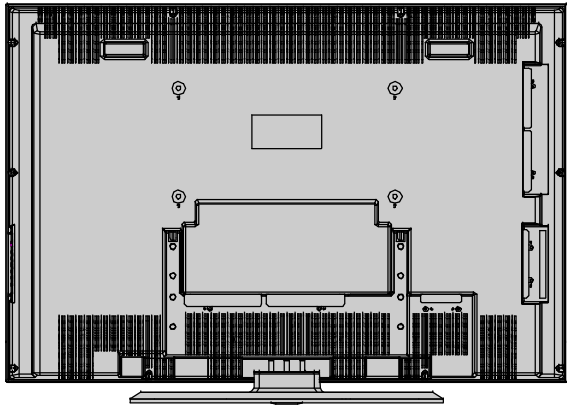
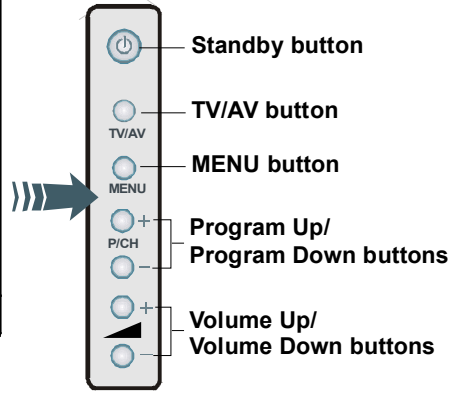

REAR VIEW

## Viewing the Connections

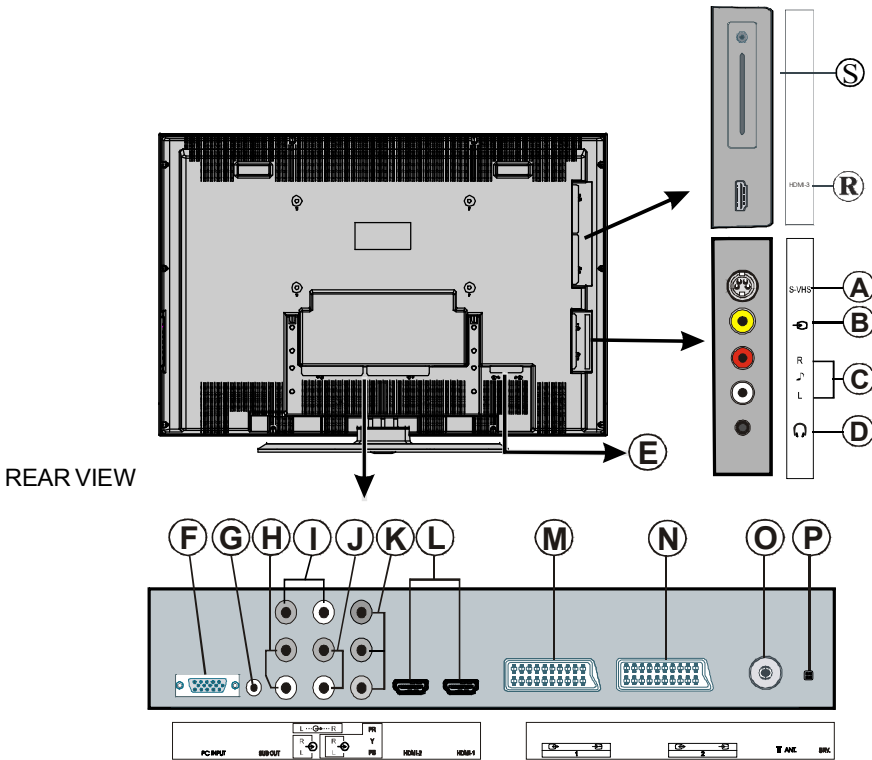

- A S-Video** Input is used for connecting an **S-Video** signal (e.g. from a camcorder or VCR).  
*For using S-VIDEO input; connect the video cable between the S-VIDEO input on the TV and the S-Video output on your device. Connect the audio cable between the **AUDIO INPUTS** (indicated with letter C in the illustration) on the TV and the audio jacks on your device.*
- B Video Input** is used for connecting video signals of external devices.  
*Connect the video cable between the **VIDEO IN** socket on the TV and the **VIDEO OUT** jack on your device.*
- C Audio Inputs** are used for connecting audio signals of external devices.  
*Connect the audio cable between the **AUDIO INPUTS** on the TV and the **AUDIO OUTPUT** jacks on your device.*
- D Headphone** jack is used for connecting an external headphone to the system.  
*Connect to the **HEADPHONE** jack to listen to the TV from headphones (optional).*
- E Power Cable**
- F PC Input** is for connecting a personal computer to the TV set.  
*Connect the PC cable between the **PC INPUT** on the TV and the PC output on your PC.*

Ⓒ **Subwoofer Out** is for connecting an external, active subwoofer to the set to give a much deeper bass effect.

*Use an appropriate RCA cable to connect the set to a subwoofer unit.*

Ⓓ **PC Audio Inputs** connects to audio jacks of your PC to enable PC audio.

*Connect the PC audio cable between the **PC AUDIO INPUTS** on the TV and audio output of your PC.*

Ⓔ **Audio Line Outs** output audio signals to an external device such as an optional sound system.

*To connect the external speakers to your TV, use **AUDIO LINE OUTS** of the TV with an audio cable.*

Ⓕ **Component Audio Inputs** are used for connecting component audio.

*Connect the audio cable between **COMPONENT AUDIO INPUTS** on the TV and audio outputs of your device.*

Ⓖ **Component Video Inputs (YPbPr)** are used for connecting component video.

*You can connect the component video and audio sockets with a device that has component output. Connect the component video cables between the **COMPONENT VIDEO INPUTS** on the TV and the component video outputs of your device. While connecting, be sure that the letters on your TV, “Y”, “Pb”, “Pr” correspond with your device’s connectors.*

Ⓗ **HDMI Inputs** are for connecting a device that has an **HDMI** socket.

*Your LCD Television is capable of displaying High Definition pictures from devices such as a High Definition Satellite Receiver or DVD Player. These devices must be connected via the HDMI sockets or Component Socket. These sockets can accept either 720p or 1080i signals. Also, only HDMI modes accept 1080p signals. No sound connection is needed for an HDMI to HDMI connection.*

Note: When it is desired to watch HDMI-1, HDMI-2 or Side HDMI(Optional) source with a DVI to HDMI cable, in order to enable audio, there are some options that can be used:

- When you want to connect DVI and HDMI 1, the audio signal line must be connected to audio input in the component terminal (YPbPr).

- When you want to connect DVI and HDMI 2, the audio signal line must be connected to PC audio input.

-If there is an optional third HDMI(side) socket on your TV, the audio signal line must be connected to audio input in the component terminal (YPbPr).

Ⓜ **SCART 1** inputs or outputs for external devices.

Connect the **SCART** cable between **SCART** sockets on TV and **SCART** socket on your external device (such as a decoder, a VCR or a DVD player).

**Note:** *If an external device is connected via the **SCART** sockets, the TV will automatically switch to AV mode. If both sockets are employed at the same time, **SCART 1** becomes the preferential.*

Ⓝ **SCART 2** inputs or outputs for external devices.

Ⓞ **RF Input** connects to an antenna or a cable.

Note that if you use a decoder or a media recorder, you should connect the aerial cable through the device to the television with an appropriate antenna cable, as shown in the illustration below.

Ⓟ This connector is for service use only.

Ⓡ Side HDMI Input supports signals up to 1080i.

Ⓢ CI Slot and **SPDIF** Out. CI Slot is used for inserting a CI card. A CI card allows you to view all the channels that you subscribe to. For more information, see “Common Interface” section.

**S/PDIF** Out is used for transferring digital audio signals. Use an RCA cable to transfer audio signals to a device that has **S/PDIF** input.

## Power Connection

**IMPORTANT:** *The TV set is designed to operate on 220-240V AC, 50 Hz.*

- ***After unpacking, allow the TV set to reach the ambient room temperature before you connect the set to the mains.***
- Plug the power cable to the mains socket outlet.

## Aerial Connection

- Connect the aerial or cable TV plug to the **AERIAL INPUT** socket located at the rear of the TV.

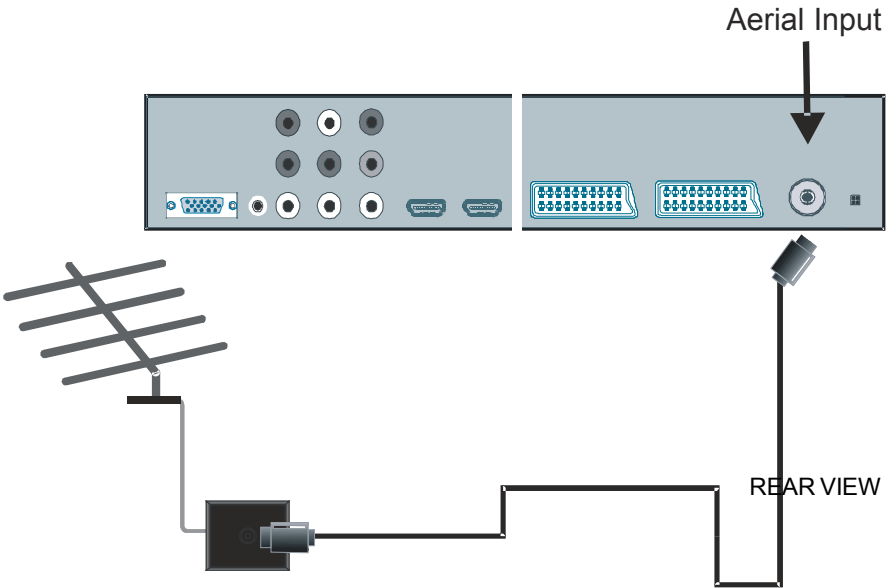

## Connecting the LCD TV to a PC

For displaying your computer's screen image on your LCD TV, you can connect your computer to the TV set.

- Power off both computer and display before making any connections.
- Use 15-pin D-sub display cable to connect a PC to the LCD TV.
- When done, switch to PC source. See, "**Input selection**" section.
- Set the resolution that suits your viewing requirements.

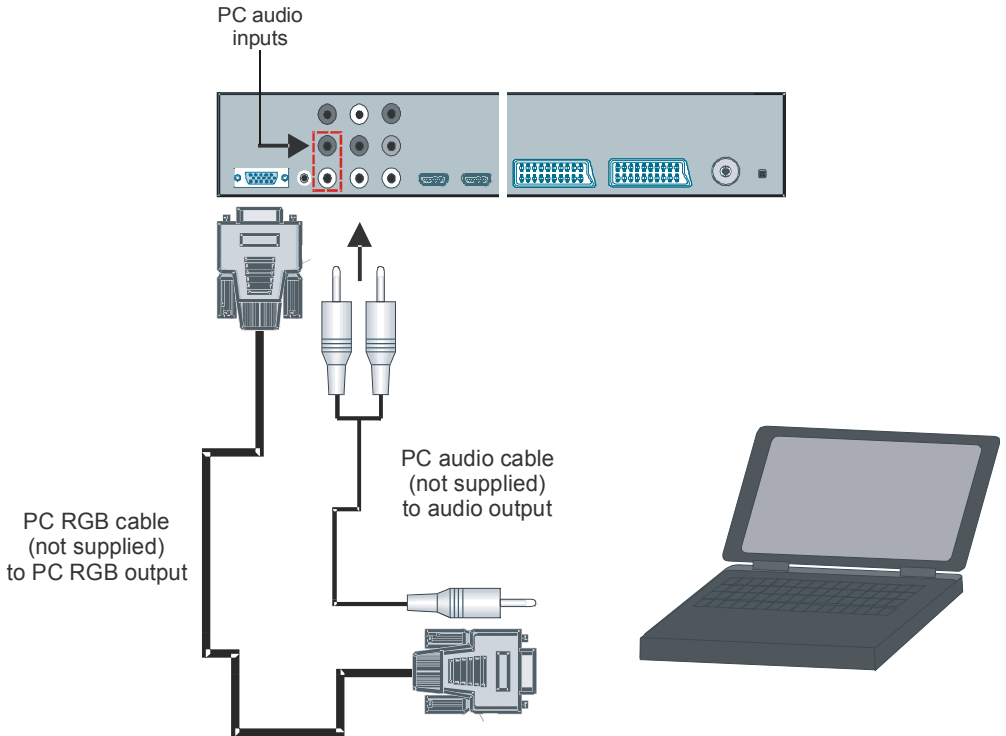

## Connecting to a DVD Player

If you want to connect a DVD player to your LCD TV, you can use connectors of the TV set. DVD players may have different connectors. Please refer to your DVD player's instruction book for additional information. Power off both the TV and the device before making any connections.

**Note:** Cables shown in the illustration are not supplied.

- If your DVD player has an **HDMI** socket, you can connect via **HDMI**. When you connect to DVD player as illustrated below, switch to HDMI source. See, "**Source menu**" section.
- Most DVD players are connected through **COMPONENT SOCKETS**. Use a component video cable to connect video input. For enabling audio, use a component audio cable as illustrated below. When done, switch to **YPbPr** source. See, "**Input selection**" section.
- You may also connect through the **SCART 1** or **SCART 2**. Use a **SCART** cable as shown below.

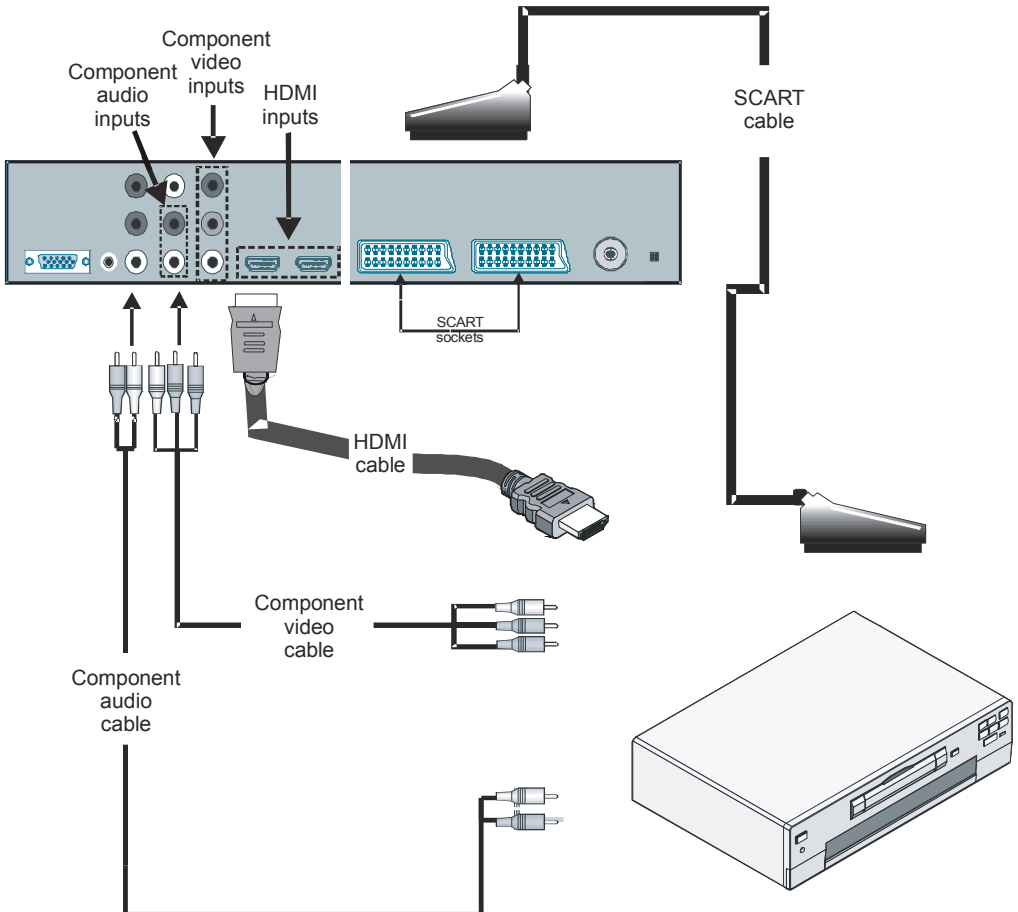

## Inserting Batteries in the Remote Control Handset

**WARNING:** Remote control is battery included. A plastic protector is used to disconnect the batteries in order to prevent the battery life from reducing. Please remove the plastic protector before the first use.

- Remove the battery cover located on the back of the handset by gently pulling backwards from the indicated part.
- Insert two **AAA/R03** or equivalent type batteries inside. Place the batteries in the right directions and replace the battery cover.



**Note:** Remove the battery from remote control handset when it is not to be used for a long period. Otherwise it can be damaged due to any leakage of batteries.

## Operating Range for the Remote Control

- Point the top of the remote control toward the LCD TV's remote sensor LED while pressing a button.

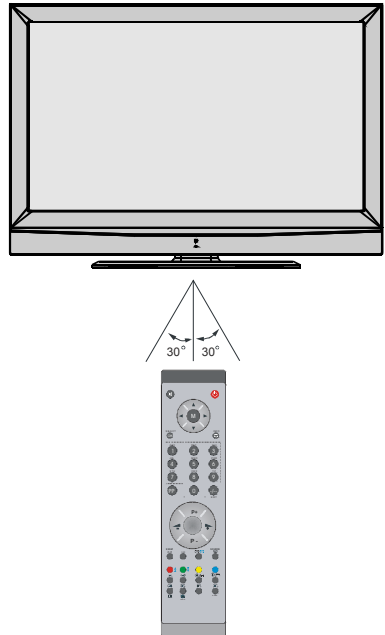

Remote range is approximately 7m/23ft.



## Switching the TV On/Off

### To Switch the TV On

- Connect the power cord to the 220-240V AC.
- Press **STANDBY** button. Then the standby LED lights up.
- To switch on the TV from standby mode either:
  - Press the  button, **P+ / P-** or a numeric button on the remote control.
  - Press the **-P/CH** or **P/CH+** button on the TV. The TV will then switch on.

**Note:** If you switch on your TV via **PROGRAM UP/DOWN** buttons on the remote control or on the TV set, the programme that you were watching last will be reselected.

### To Switch the TV Off

- Press the  button on the remote control or **STANDBY** button on the TV, so the TV will switch to standby mode.
- To power down the TV completely, unplug the power cord from the mains socket.

## Navigating the Menu System

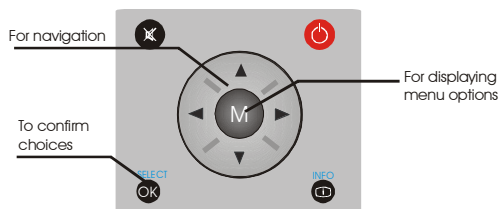

- Press **M** to display the main menu.
- Press **▲** or **▼** button to select an icon. Press **▶** or **OK** button for more options.
- Use **▲** or **▼** button to highlight.
- Press **◀** or **▶** buttons to change the settings. Press **OK** to set as default.
- To exit the menu or return from sub-menu screen, press **M**.

**Note:** These explanations are valid for the navigation of the whole menu system. To select options that are explained in the following parts, refer to “Navigating the Menu System”.

## Initial Settings

When the TV set is operated for the first time, the IDTV turns on first.

Because this is the first time the TV is used, there are no channels stored in the memory and the following message appears on the screen:

Please ensure aerial is plugged in. Do you want to start first time installation?

Yes

No

- To start installation process, select “**Yes**”, to cancel select “**No**”.
- To select the “**Yes**” or “**No**” option, highlight the item by using **◀** or **▶** buttons and press the **OK** button.

The IDTV will automatically tune to the UHF transmission channels 21 to 68, searching for digital terrestrial TV broadcasts and displaying the names of channels found. This process will take about five minutes. To cancel searching, you can press the **M** button at any time during the process.

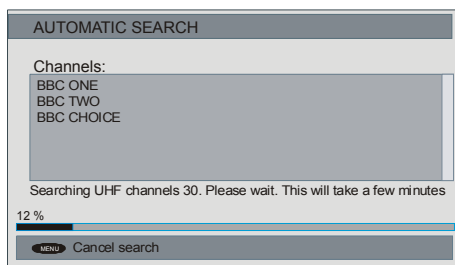

After **Automatic Search** is completed, the following message asking for analogue channel search appears on the screen:

Do you want to search for analogue channels?

Yes

No

To search for analogue channels, select “Yes”. TV switches to the analogue TV mode. The menu below is displayed to search for analogue channels:



Select your **Language**, **Country** and **Text language** by using ▲ or ▼ and ◀/▶ buttons. Press **OK** button to continue. To cancel, press the **BLUE** button.

For more information on this process, see “Install Menu” section.

**NOTE:** For proper functioning of digital teletext in DTV mode, you should set **country** as UK in analogue AUTO PROGRAM.

## Basic Operations

*You can operate your TV using both the remote control and onset buttons.*

### Operation with the Buttons on the TV Volume Setting

- Press ◀ - button to decrease volume or ▶ + button to increase volume, so a volume level scale (slider) will be displayed on the screen.

### Programme Selection

- Press **P/CH +** button to select the next programme or **P/CH -** button to select the previous programme.

### Entering Main Menu

- Press the **MENU** button to enter main menu. In the Main menu select sub-menu using **P/CH -** or **P/CH +** buttons and enter the sub-menu using ◀ - or ▶ + buttons. To learn the usage of the menus, refer to the menu system sections.

### AV Mode

- Press the **TV/AV** button at the control panel on the the TV to switch your TV to AV modes.

### Operation with the Remote Control

- The remote control of your TV is designed to control all the functions of the model you selected. The functions will be described in accordance with the menu system of your TV.
- Functions of the menu system are described in the following sections.

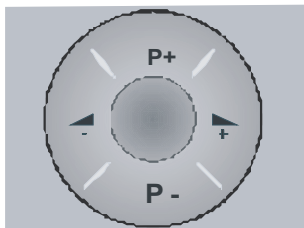

## Volume Setting

Press **V +** button to increase the volume. Press **V -** button to decrease the volume. A volume level scale (slider) will be displayed on the screen.

## Programme Selection (Previous or Next Programme)

- Press **P -** button to select the previous programme.
- Press **P +** button to select the next programme.

## Programme Selection (Direct Access)

- Press numeric buttons on the remote control to select programmes between 0 and 9. The TV will switch to the selected programme. To select programmes between 10 - 999 (for IDTV) or 10-99 (for analogue), press the numeric buttons consecutively (eg. for programme 27, first press 2 and then 7). When the pressing time is due for the second numeric button, only the first digit programme will be displayed. The limit of the delay time is 3 seconds.
- Press directly the programme number to reselect single digit programmes.

## Everyday Operation

Pressing the **TV** / **DTV** button at any time while watching television programmes will switch the TV set between the digital terrestrial television broadcasting and its normal analogue broadcasting.

## Information Banner

- Whenever you change channel, using the **P-** / **P+** button or the numeric buttons, the TV displays the broadcast picture along with an information banner at the bottom of the screen. This will remain on the screen for approximately three seconds.

- The information banner can also be displayed at any time while watching TV by pressing the **i** button on the remote control:

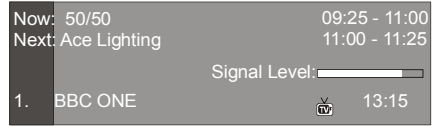

- The information banner gives information on the channel selected and the programmes on it. The name of the channel is displayed, along with its channel list number and an indication of the strength of the signal received.

***Hint:** Not all channels broadcast the programme data. If the name and time of the programme are not available, then “**No Information Available**” will be displayed in the information banner.*

- Icons are also displayed in the information banner and if this channel is a favourite channel, favourite channel icon “” will also be displayed.

If the selected channel is locked, you must enter the correct four numeric code to view the channel. “**Enter Lock Key**” will be displayed on the screen in such a case:

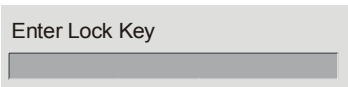

## Electronic Programme Guide (EPG)

- Some, but not all, channels send information about the current and next events.
- Please note that event information is updated automatically. If there is no event information data available in channels, only channel names with “**No Information Available**” banner is displayed.

- Press **GUIDE** button to view the **EPG** menu.
- In EPG menu, you can easily see the extended help information by pressing **i** button.
- Press this button again to close this window.
- In the EPG menu, all channels are displayed. Current channel is highlighted. Use **▲** or **▼** buttons to change channels. Also press **GREEN/RED** buttons to scroll up/down the pages for the channels.
- If you highlight an event, short event description, extended event description, start and end times of the event will be displayed on the screen.
- If you press the **OK** button when a next event is highlighted, a reminder is set for the highlighted programme and a clock appears across the highlighted channel line.

Programme reminders can be set to signal that a programme is about to start when you are watching another channel. If you set reminder for a programme, then you will be asked for switching to that channel when the reminder time is reached.

- Press the **M** button to view the 7 day EPG.
- Press **▲** or **▼** button to navigate in Channels or Programmes.
- Press **◀** or **▶** button to navigate through the channel and programme list.

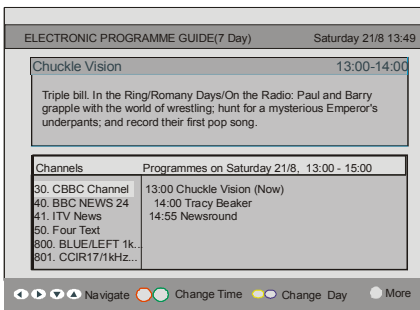

- With **RED/GREEN** buttons, you can change the schedule time. By pressing **YELLOW/**

**BLUE** you can advance the schedule backward/forward of a day.

- If you press **i** button you can see the detailed help information easily. Press **i** button again to exit help menu.
- The starting time for **EPG** is the current time. You can see the event information for the next two hours. By pressing **▲** or **▼** button, you can go to the next/previous hours while Programmes list is highlighted.
- If you press the **OK** button when a next event is highlighted, a reminder is set for the highlighted programme and a clock appears on the screen.
- Programme reminders can be set to signal that a programme is about to start when you are watching another channel. If you set reminder for a programme, then you will be asked for switching to that channel when the reminder time is due.

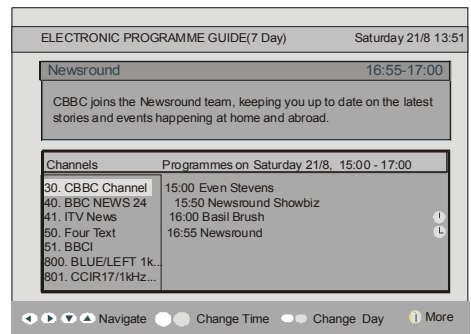

## Displaying the Subtitles

With digital terrestrial broadcasting (DVB-T), some programmes are broadcast with subtitles. Subtitles can be displayed while watching these programmes.

Press the **M** button to display the main menu, highlight the **Configuration** line using **▲** or **▼**

button and press the **OK** button to display the configuration menu.

Highlight the “**Subtitle**” item in configuration menu and use ◀ or ▶ button to set Subtitle to Off or a language.

If “**Subtitle**” is on and a language option is set, pressing the  button causes the following warning message display on the screen:

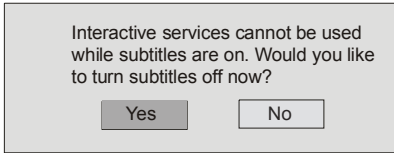

## Digital Teletext

With digital terrestrial broadcasting (DVB-T), in addition to pictures and sound, you can also view digital teletext.

Digital teletext is sometimes broadcast at the same time with the normal broadcasting.

- Press the  button.
- The digital teletext information appears.
- Operate it with the coloured buttons, ◀/▶/▼/▲ buttons and **OK** button.

The operation method may differ depending on the contents of the digital teletext.

Follow the instructions displayed on digital teletext screen.

- When “**Press SELECT**” button or similar message appears on the screen, press the **OK** button.
- When the  (Text) button is pressed, the TV returns to television broadcasting.
- With digital terrestrial broadcasting (DVB-T), in addition to digital teletext broadcasting together with the normal broadcasting, there are also channels with just digital teletext broadcasting.

- The aspect ratio when watching a channel with just digital teletext broadcasting is the same as the aspect ratio of the picture viewed previously.
- When you press the  (Text) button again, the digital teletext screen will be displayed.

## Over Air Download

To ensure that your IDTV always has the most up-to-date information, please ensure that, after use, it is set to standby mode. At 3 A.M. each day, the IDTV automatically searches for any updates which may be broadcast and will download this to your IDTV automatically. This operation will normally take approximately 30 seconds.

If you want to perform this, you need to set Automatic Download to “**Enabled**” in Receiver Upgrade setting.

## Widescreen

Depending on the type of the broadcast being transmitted, programmes can be viewed in a number of formats. Press the **WIDE** button repeatedly to select between **Auto**, **Full**, **4:3**, **Panoramic**, **14:9 Zoom**, **Cinema** or **16:9 Subtitle**.

When **Auto** is selected, the format being displayed is determined by the picture being broadcast.

**PLEASE NOTE:** *Menu size changes depending on the chosen image size.*

## IDTV Menu System

The IDTV menu can only be viewed when watching digital terrestrial broadcasting. Press the **TV**/**DTV** button to turn IDTV on while the TV is in analogue mode.

Press the **M** button. The menu below appears on the screen:

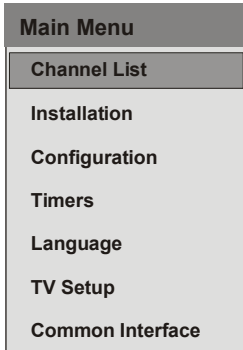

### Channel List

Using the **▲** or **▼** button on the remote control, make sure that the first item, Channel List, is highlighted and press the **OK** button to display the **Channel List**.

The following operations can be performed in this menu:

- Navigating the entire list of channels
- Deleting channels
- Renaming channels
- Adding locks to channels
- Setting favourites

Channel List is the place where the channels are managed.

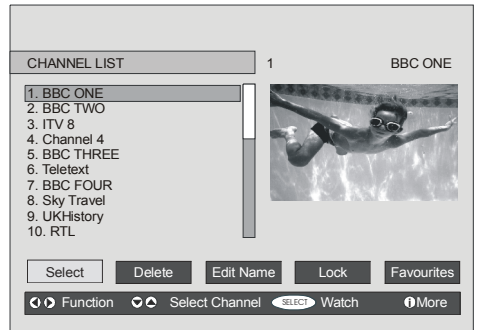

### Navigating the Entire Channel List

Press **▲** or **▼** button for selecting the previous or next channel. You can press **RED** or **GREEN** button to move page up or page down.

To watch a specific channel, highlight it using **▲** or **▼** button and then press **OK** button, while the **"Select"** item on Channel List menu is highlighted by using **◀** or **▶** button.

Then the name and number of the selected channel will be displayed in the top-left and top-right of the channel display at the top-right of the screen, respectively.

### Deleting the Channels in the Channel List

Press **▲** or **▼** button to select the channel that will be deleted.

Press **◀** or **▶** button to select the **"Delete"** item on Channel List menu. As seen on Channel List menu, **SELECT** is displayed next to **Delete** item at the bottom of the screen to indicate that you must press the **OK** button to delete the highlighted channel in the channel list.

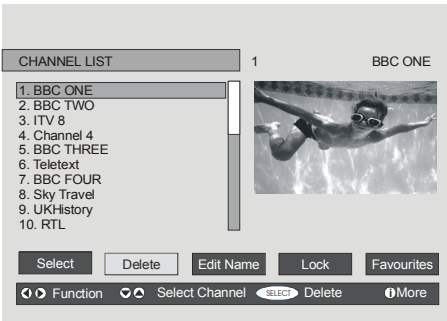

Press the **OK** button to delete the highlighted channel in the channel list. Then the message below appears on the screen:

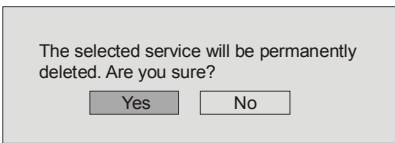

Press **◀** or **▶** button to highlight the desired option. If **OK** button is pressed while “**Yes**” is highlighted, the highlighted channel is deleted. Selecting “**No**” cancels the deletion.

### Renaming Channels

To rename a specific channel, the channel must be highlighted by pressing **▲** or **▼** button. Then highlight the **Edit Name** item by pressing **◀** or **▶** button as illustrated below. Press the **OK** button to activate the rename feature.

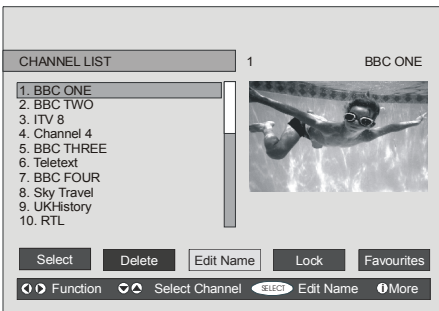

Now pressing **◀** or **▶** button moves to the previous/next character. Pressing **▲** or **▼** button toggles the current character, i.e., ‘b’

character becomes ‘a’ by **▼** and ‘c’ by **▲**. Pressing the numeric buttons ‘0...9’ replaces the highlighted character with the characters printed above the button one by one as the button is pressed.

Press the **M** button to cancel the editing or **OK** button to save the new name.

### Adding Locks to Channels

Channel locking provides a password-protected access to channels selected by parents. In order to lock a channel you should know the parental lock password (default value is set to 0000 in the factory and can only be changed from the **Configuration** menu).

Select the channel to be locked by highlighting it and select the **Lock** option by pressing **◀** or **▶** button. When the **OK** button is pressed, a dialog OSD asking for the password will be displayed.

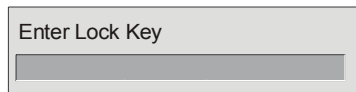
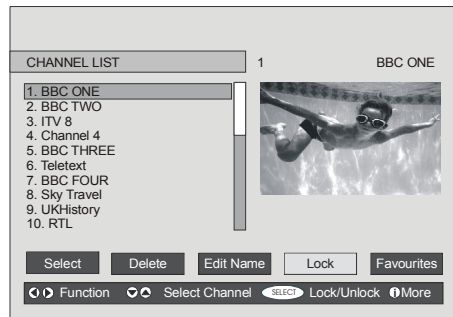

Enter the password by using the numeric buttons on the remote control. The lock icon “**🔒**” will now be displayed next to the selected channel. Repeat the same operation to cancel the lock.

### Setting Favourites

You can set various channels as favourites so that only the favourite channels are

navigated. To set a favourite you should highlight the **Favourites** item at the bottom of the Channel List menu.

Use the ◀ or ▶ button to highlight the **“Favourites”** item at the bottom of the screen and then, in turn, highlight each channel you want to add to the favourites list, using the ▲ and ▼ buttons (or red/green buttons), and press the **OK** button.

A channel selected as a favourite appears in the main channel list with a favourites icon (😊) against the channel name as illustrated below:

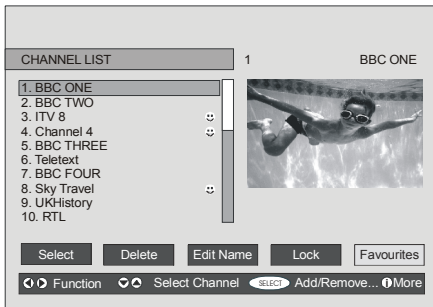

## On Screen Help

For all menus, press the ⓘ button to display the help information about the menu functions.

For **Channel List** menu the following message is displayed on the screen:

Press the SELECT button on your remote control to tune to the highlighted channel.  
Press MENU to exit this screen.

## Installation

The Installation menu is mainly intended to help you for creating a **Channel Table** in the most efficient way.

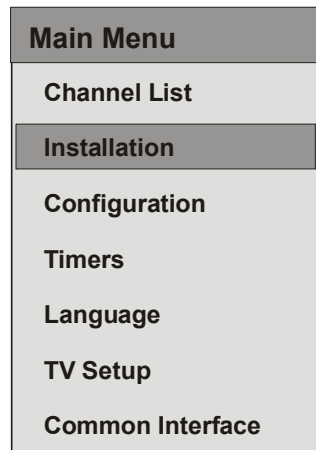

This menu includes the following items:

- Add New Channels.
- First Time Installation.

## Add New Channels

This tuning menu consists of two parts:

- Automatic Search
- Manual Search



## Automatic Search

Automatic search is started by pressing the **OK** button in the auto-search pop up menu. All the services will be searched and a channel table will be created automatically.

All channels found are stored in a sorted form with respect to their channel numbers. Some services may not appear with the correct channel number. This may occur due to missing information when the broadcaster does not transmit any channel information.

## Manual Search

In manual search, the number of the multiplex is entered manually and only that multiplex is searched for the channels. For every valid channel number, signal level, signal quality



and network name are shown at the bottom of the screen.

In both manual and auto search, any existing channel in the database is not re-stored to avoid redundant duplicates of that channel.

### First Time Installation

The user can use this item to load default settings, which were loaded to the receiver at the factory.

To install factory settings, highlight “**First Time Installation**” menu and press the **OK** button.

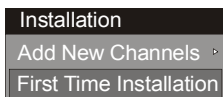

Then you will be asked to confirm for deleting all channels and settings:

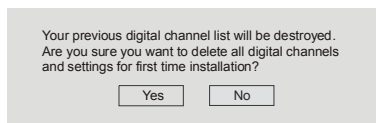

By selecting **Yes** and pressing the **OK** button, the existing channel table will be deleted.

After factory settings are loaded, “**First Time Installation**” menu will be displayed:

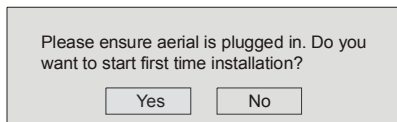

Press the **OK** button to start installation. After search is completed for digital channels, a message asking whether to search for analogue channels appears on the screen:

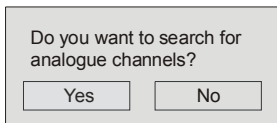

Press the **OK** button to search for analogue channels. The following menu appears on the screen for analogue channel search:



Select your **Language**, **Country** and **Text language** by using **▲** or **▼** and **◀/▶** buttons. Press **OK** button to continue. To cancel, press **BLUE** button. The following menu will be displayed during the APS process:

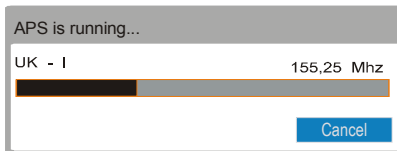

After APS is finalized, the programme table will appear on the screen. In the programme table you will see the programme numbers and names assigned to the programmes.

If you do not accept the locations and/or the programme names, you can change them in the program table.

### Configuration

Press the **M** button to display the main menu and press the **▼** button twice to highlight Configuration. Then press the **OK** button to display the configuration menu. Press the **M** button to leave the menu screen.

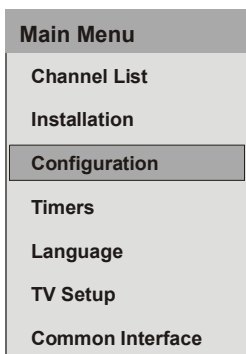

The various configuration functions are displayed in a list, along with a quarter-screen image of the currently selected channel. You can select a function by highlighting the corresponding menu line using the ▲ or ▼ button. Configuration menu will look like this:

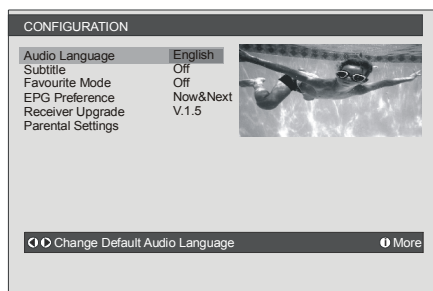

## Audio Language

Digital terrestrial television channels can broadcast simultaneous soundtracks in more than one language. This function selects which language soundtrack you will hear when switching to a channel broadcasting with the multiple soundtracks.

Highlight the **Audio Language** line in the **Configuration** menu and use the ◀ or ▶ button to cycle through the language options.

## Subtitle

Digital terrestrial television channels can broadcast subtitles displayed on the screen for hard-of-hearing people. This function selects the desired subtitle language and

enables the automatic display of subtitles whenever subtitle information is broadcast.

Highlight the **Subtitle** line in the Configuration menu and use the ◀ or ▶ button to cycle through “Off” and language options.

## Favourite Mode

This function enables or disables the favourite channel list mode.

Use ◀ or ▶ button to turn on/off favourite mode. If the “**Favourite Mode**” is on; while in normal operating mode, pressing **P+** and **P-** buttons will only navigate through the channels that were previously defined as favourites in the channel list.

## EPG Preference

Digital terrestrial television channels can broadcast simultaneous Next&Now and 7-Day electronic programme.

Highlight the **EPG Preference** line in the **Configuration** menu and use the ◀ or ▶ button to select **Next&Now** or **7-Day**.

## Receiver Upgrade

The IDTV can be upgraded via the configuration menu, entered from the main menu.

In the configuration menu, highlight the “**Receiver Upgrade**” item by pressing ▲ or ▼ button and press the **OK** button to start upgrade process.

There are two options for receiver software to be upgraded: **automatic** and **manual**.



### Automatic Download (Automatic Upgrade)

Automatic Download can be enabled or disabled by pressing ◀ or ▶ button. If it is enabled, then there are two ways for automatic upgrade:

- The first one is checking the existence of a new software every time the IDTV goes to standby.
- The second one is being activated at 03:00 A.M. every night, provided that the IDTV is left in standby mode.
- Both automatic upgrade methods result in standby mode either the upgraded or not.

If the automatic upgrade is set to “**Disabled**” then this function will not work.

### Search for New Version (Manual Upgrade)

Manual upgrade starts if the “**Search for New Version**” item is highlighted by using ▲ or ▼ button and activated by pressing the **OK** button.

After “**Search for New Version**” is activated, the IDTV tunes to each frequency that have been stored in its database and looks for the new software. During this process, the following OSD is displayed:

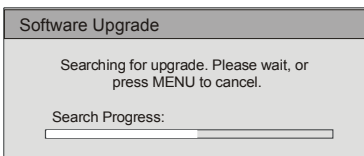

## Parental Settings

Some channels broadcast material which you do not want younger members of the family to watch. Any channel can be ‘locked’ so that it cannot be selected for viewing unless a four-digit PIN code is entered. In this way, any channel not suitable for younger viewers can be prohibited.

This function enables or disables the menu protection system and allows the PIN code to be changed.

Use ▲ or ▼ button to highlight **Parental Settings** option. Press the **OK** button to enter Parental Settings menu. A dialog box asking for the lock key is displayed:

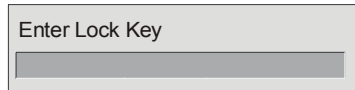

There is only one key which is set to “**0000**” initially. Enter lock key. If wrong lock key is entered, the following message is displayed and the TV then returns to the previous menu:

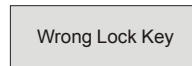

If it is correct, the **Parental Settings** menu will be displayed including the following items:

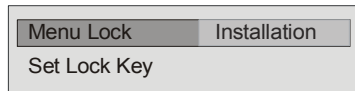

Here, you can set/reset locking for the main menu or the installation menu to restrict access. If the menu lock is disabled, there will be free access to the menu system. Also in this menu you can change the lock key and set/change parental lock mode.

**Disabled:** All menus are unlocked.

**Main Menu:** Main menu is accessible only with the correct lock key. So the user cannot add, delete, rename, or move the channels and cannot set the timers.

**Installation:** Installation menu is locked, so the user cannot add channels.

**Note:** Changes will be updated after exiting configuration menu.

## Timers

You can set a timer to switch the TV to any channel without your intervention. This is also useful for recording the programmes when you are out.

Display the main menu by pressing the **M** button. Highlight the **Timers** line by pressing **▲** or **▼** button and press the **OK** button to display the Timer menu:

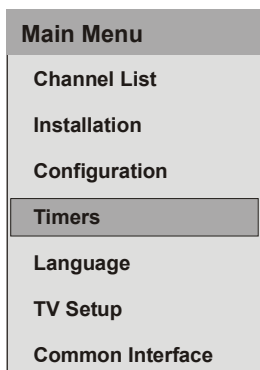

Up to five separate timer events can be set and each is displayed in the Timer screen, showing the event number, the channel to be selected, the start time, end time, date and the mode - whether that event is active (and will be acted on) or not.

The image shows a table titled "TIMER MENU" with the following data:

No	Channel Name	Start	End	Date	Mode
1.	ITV 1	20:00	21:00	12/05/2005	Active
2.	BBC ONE	00:00	00:00	01/01/2005	Inactive
3.	BBC ONE	00:00	00:00	01/01/2005	Inactive
4.	BBC ONE	00:00	00:00	01/01/2005	Inactive
5.	BBC ONE	00:00	00:00	01/01/2005	Inactive
6.	BBC ONE	00:00	00:00	01/01/2005	Inactive

At the bottom of the screen, there are navigation options: Toggle Mode, Exit, Edit Timer, and More.

- To set an event, highlight its mode button using the **▲** or **▼** button and press the **OK** button to display the timer entry window.

The image shows a form for setting timer event 3. The fields are: Name: 3. ITV 1, Start: 00:00, End: 00:00, Date: 03/06/2005, and Mode: Once.

- Here the five settings consisting of the channel name, start time, end time, date and frequency mode can be set. You can move freely between each setting using the **▲** or **▼** buttons.
- The channel name is set using the **◀** or **▶** button to display the channel which broadcasts the programme.
- The start time, end time and date are each set with the numeric buttons on the remote control in 24-hour format.
- The frequency mode determines how often the receiver operates this event and is set with the **◀** or **▶** button to be either **Once**, **Daily**, or **Weekly**.

If an invalid number for the start or end times or the date is entered, "**Entered time is not valid**" message appears on the menu screen.

If timer action occurs while the TV is being watched, the TV switches to the selected channel. When timer expires, the TV switches back to the channel which it is switched from.

Selected digital channel will be output via Scart-2. You should connect your VCR to Scart-2 for recording digital broadcasts.

## Language

Some programmes are broadcast in two or more languages simultaneously. The language thus can be selected from the Language menu.

- Press the **M** button to display the main menu and use **▲** or **▼** button to highlight the Language line and press the **OK** button:

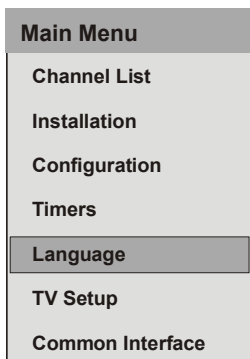

- Use the **▲** or **▼** button to highlight the soundtrack language required and press the **OK** button. Normal viewing, with the required language soundtrack, can be resumed by pressing the **M** button.

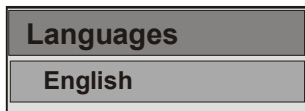

## TV Setup

You can use this item to display the TV functions.

The digital TV Setup menu screen is accessed from the main menu. Press the **M** button to display the main menu and use **▲** or **▼** button to highlight “**TV Setup**”, press the **OK** button to display TV Setup menu screen.



You can find detailed information for all menu items in “Analogue TV Menu System” section.

## Common Interface

- Press the **M** button to display the main menu and use the **▲** or **▼** button to highlight the “**Common Interface**” line and press the **OK** button:

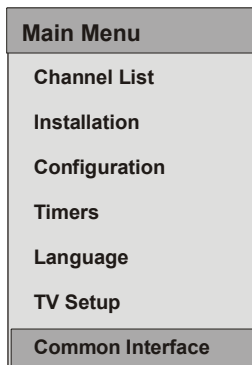

It is required to subscribe to a pay channel company to view the pay channels of the digital terrestrial broadcasting.

Obtain the Conditional Access Module (CAM) and the viewing card by subscribing to a pay channel company, then insert those to the TV using the following procedure.

- Switch off the TV and unplug from the mains.
- Insert the CAM and then the viewing card to the slot that is located in the terminal cover at the left-hand side of the TV (from front view).
- The CAM should be correctly inserted, it is impossible to insert fully if reversed. The CAM or the TV terminal may be damaged if the CAM is forcefully inserted.
- Connect the TV to the mains supply, switch on and then wait for few moments until the card is activated.
- Some CAMs may require the following set up. Please set the CAM by entering the IDTV

menu, Common Interface then pressing the **OK** button. (CAM set up menu is not displayed when it is not required.)

- To see the viewing contract information: enter IDTV; press the **M** button, then highlight **Common Interface** and press the **OK** button.
- When no module is inserted, “**No Common Interface module detected**” message appears on the screen.
- Refer to the module instruction manual for details of the settings.

## Menu System

### Picture Menu



### Pixellence Demo

This item is active when the Picture Mode is Pixellence in the picture menu (always inactive when pip-pap is on). When user presses OK key on this item, Pixellence Demo starts. By activating PIXELLENCE, you can optimize the TV's video settings and acquire a better quality. PIXELLENCE mode thus includes contrast, colour enhancement and skin tone correction along with the skin tone detection.

Demo mode occurs in two parts. Firstly, PIXELLENCE will be repeatedly activated and then deactivated automatically to display the

difference. When PIXELLENCE logo  appears on the screen, PIXELLENCE is activated and when logo disappears, PIXELLENCE mode becomes deactivated. Then, the second part begins and a vertical bar starts to move along the screen, stressing the PIXELLENCE active area.

User can exit from this menu with MENU and BLUE buttons.

### Note

PIXELLENCE activation is recommended for HD (High Definition) or SD (Standard Definition) contents having low amount of noise. The optimization of PIXELLENCE will be much more evident while viewing such contents.

### Mode

By pressing ▲ / ▼ button, select Mode. Press ◀ / ▶ button to choose from one of these options: Cinema, Pixellence, Dynamic and Natural.

### Contrast/Brightness/Sharpness/Colour/Hue

Press ▲ or ▼ button to select the desired option. Press ◀ / ▶ button to set the level.

**Note:** *Hue option can only be visible when the TV receives an NTSC signal.*

### Colour Temp

Press ▲ or ▼ button to select **Colour Temp.** Press ◀ / ▶ to choose from one of these options: **Cool**, **Normal** and **Warm**.

### Note:

- Setting **Cool** option gives white colours a slight blue stress.
- Setting **Warm** option gives white colours a slight red stress.
- For normal colours, select **Normal** option.

## Noise Reduction

If the broadcast signal is weak and the picture is noisy, use **Noise Reduction** setting to reduce the noise amount.

Press **▲** or **▼** button to select **Noise Reduction**. Press **◀/▶** to choose from one of these options: **Low, Medium, High** or **Off**.

## Film Mode

Films are recorded at a different number of frames per second to normal television programmes.

Press **▲** or **▼** button to select **Film Mode**. Press **◀/▶** button to set this feature **On** or **Off**. Turn this feature on when you are watching films to see the fast motion scenes clearly.

## Store

Press **▲** or **▼** button to select **Store**. Press **▶** or **OK** button to store the settings. "**Stored**" will be displayed on the screen.

## Reset

Press **▲** or **▼** button to select **Reset**. Press **◀/▶** or **OK** button to reset the picture modes to factory default settings.

## Sound Menu



### Volume

Press **▲** or **▼** button to select **Volume**. Press **◀/▶** button to change the level of the Volume.

### Equalizer

Press **▲** or **▼** button to select **Equalizer**. Press **◀/▶** or **OK** button to enter equalizer menu.

In equalizer menu the sound mode can be changed to **User, Music, Movie, Speech, Flat** and **Concert** by pressing **◀/▶** button. Select the desired frequency by **▲** or **▼** button and increase or decrease the frequency gain by pressing **◀/▶** button.

Press the **M** button to return to the previous menu.

**Note:** *Equalizer menu settings can be changed only when the **Equalizer Mode** is in **User**.*

### Balance

This setting is used for emphasizing left or right speaker balance.

Press **▲** or **▼** button to select **Balance**. Press **◀/▶** button to change the level of the balance. Balance level can be adjusted between **-32** and **+ 32**.

## Headphone

Press ▲ or ▼ button to select **Headphone**. Press ► button to view the headphone menu.

Headphone sub-menu options are described below:

### Volume

Press ▲ or ▼ button to select **Volume**. Press ► button to increase headphone volume level. Press ◀ button to decrease headphone volume level. Headphone volume level can be adjusted between 0 and 63.

### Balance

Press ▲ or ▼ button to select **Balance**. Press ► button to increase balance to the right. Press ◀ button to decrease balance to the left. Balance level can be adjusted between -32 and +32.

Press the **M** button to return to the previous menu.

### Sound Mode

Press ▲ or ▼ button to select **Sound Mode**. Using ◀ / ► button, you can select **Mono**, **Stereo**, **Dual I** or **Dual II** mode, only if the selected channel supports that mode.

### AVL

Automatic Volume Limiting (AVL) function adjusts the sound to obtain fixed output level between programmes (For instance, volume level of advertisements tend to be louder than programmes).

Press ▲ or ▼ button to select **AVL**. Press ◀ / ► button to set the AVL as On or Off.

### Effect

If you are watching a mono broadcast, set **Effect** on to obtain a better sound effect which will be more stereo-like. If the current sound system is stereo, switching this effect on will give a more spatial effect.

Press ▲ or ▼ button to select **Effect**. Press ◀ / ► button to set **Effect** as On or Off.

## Dynamic Bass

Dynamic Bass is used to increase bass effect of the TV set.

Press ▲ or ▼ button to select **Dynamic Bass**. Use ◀ / ► button set Dynamic bass to **Low**, **High** or **Off**. It is not recommended to select **High** while listening at high volume levels.

## 3D Panorama

This feature is used to create the impression that sound is coming from around the room instead of from the speakers of the TV set.

Press ▲ or ▼ button to select **3D Panorama**. Use ◀ / ► button to set 3D Panorama as On or Off.

## Subwoofer

It is possible to connect an external, active subwoofer to the TV set to give a much deeper bass effect.

Press ▲ or ▼ button to select **Subwoofer**. Subwoofer can be set to **On** or **Off**.

Dynamic Bass is not available if **Subwoofer** is set to **On**.

Set **Subwoofer** to **On** when you connect an external subwoofer to the set.

## Store

Press ▲ or ▼ button to select **Store**.

Press ► or **OK** button to store the settings. "**Stored**" will be displayed on the screen.



## Feature Menu



### Sleep Timer

Press **▲** or **▼** button to select **Sleep Timer**. Use **◀ / ▶** button to set the **Sleep Timer**.

The timer can be programmed between **Off** and **120** minutes in steps of 10 minutes.

If **Sleep Timer** is activated, at the end of the selected time, the TV goes automatically to standby mode.

### Child Lock

Press **▲** or **▼** button to select **Child Lock**.

Use **◀ / ▶** button to set the Child Lock **On** or **Off**. When **On** is selected, the TV can only be controlled by the remote control handset. In this case the control panel buttons (except for the **STANDBY** button) will not work.

Hence, if one of those buttons is pressed, “**Child Lock On**” will be displayed on the screen when the menu screen is not visible.

### Language

Press **▲** or **▼** button to select **Language**. Use **◀ / ▶** button to select the **Language**.

## EXT-2 Out

Use this setting to define **Ext-2** signal output.

Press **▲** or **▼** button to select **Ext-2 Out**. Use **◀ / ▶** button to set **Ext-2 Out** to **TV/DTV**, **EXT1**, **EXT3**, **EXT4**, **EXT6**, **EXT7**, **EXT8** or **PC**.

### Note:

- *Only audio output is available for **EXT-3**, **EXT-6**, **EXT-7** and **EXT-8**. The other options have both audio and video outputs.*
- If you connect a device to **EXT-1**, when you switch to a different source or activate PIP/PAP functions while in DTV mode, there will be no output from **EXT-1 Out**.
- *For copying from a DVD or VCR device, you should set desired option for **EXT-2** output. If you plug your device to **EXT-1**, you will copy the picture that comes from the tuner.*

### Default Zoom

While zoom mode is set as **AUTO**, the TV will set the zoom mode in accordance with the signal of the broadcast. If there is no WSS or aspect ratio information, the TV will then use this setting to adopt.

Press **▲** or **▼** button to select **Default Zoom**.

You can set **Default Zoom** to **Full**, **Panoramic**, **4:3** or **14:9 Zoom** by pressing **◀ / ▶** button.

### Blue Background

If the signal is weak or absent, the TV will automatically change to a blue screen. To enable this, set **Blue Background** to **On**.

By pressing **▲** or **▼** button, select **Blue Background**. Press **◀ / ▶** button to set **Blue Background** as **On** or **Off**.

### Menu Background

Press **▲** or **▼** button to select **Menu Background**. You can change menu background to **Translucent** or **Opaque** by pressing **◀ / ▶** button.

## Menu Timeout

To set a specific display timeout for menu screens, set a value for this option.

Press **▲** or **▼** button to select **Menu Timeout**. Use **◀ / ▶** button to change menu timeout to **15 sec, 30 sec** or **60 sec**.

## Teletext Language

Press **▲** or **▼** button to select **Teletext Language**. Use **◀ / ▶** button to change **Teletext Language** to **West, East, Turk/Gre, Cyrillic** or **Arabic**. Text language combinations are given below.

TEXT LANGUAGE	LANGUAGE	TEXT LANGUAGE	LANGUAGE
West	ENGLISH	Turk/Gre	ENGLISH
	FRENCH		FRENCH
	SWEDISH		SWEDISH
	FINNISH		FINNISH
	DANISH		DANISH
	CZECH		GERMAN
	SLOVAK		DUTCH
	GERMAN		SPANISH
	DUTCH		PORTUGUESE
	SPANISH		ITALIAN
	PORTUGUESE		HUNGARIAN
ITALIAN	TURKISH		
HUNGARIAN	GREEK		
ICELANDIC	ICELANDIC		
East	FRENCH	Cyrillic	ENGLISH
	SWEDISH		CZECH
	FINNISH		SLOVAKYA
	FINNISH		GERMAN
	DANISH		DUTCH
	CZECH		RUSSIAN
	SLOVAK		LITHUANIAN
	GERMAN		LETTISH
	DUTCH		UKRANIAN
	ITALIAN		ESTONIAN
	HUNGARIAN	ENGLISH	
	POLISH	FRENCH	
	SLOVENIAN	ARABIC	
	CROATIAN	HEBREW	
ROMANIAN			

## Install Menu



### Program

Press **▲** or **▼** button to select **Program**. Use **◀ / ▶** button to select the program number. You can also enter a number using the numeric buttons on the remote control. There are 100 program storage between 0 and 99.

### Band

Band can be selected either **C** or **S**. Press **◀ / ▶** button to select **Band**.

### Channel

Channel can be changed by **◀ / ▶** button or numeric buttons.

### Colour System

Press **▲** or **▼** button to select **Colour System**. Use **◀ / ▶** button to change the colour system to **PAL, SECAM** or **AUTO**.

If sound system is set to **I**, SECAM will not be available for the colour system settings.

**Note:** In AV modes, you can choose **NTSC 3.58, NTSC 4.43** or **PAL60** as well.

### Sound System

Press **▲** or **▼** button to select **Sound System**. Press **◀ / ▶** button to change the sound system to **BG, I, DK, L** or **LP**.

## Fine Tune

Press ▲ or ▼ button to select **Fine Tune**. Press ◀ / ▶ button to adjust the tuning.

## Search

Press ▲ or ▼ button to select **Search**. Use ◀ / ▶ button to start program searching. You can also enter the desired frequency using the numeric buttons while Search item is highlighted.

## VCR

This item can be seen in all modes except for **PC**, **YPbPr** and **HDMI**.

If you want to watch a **VCR** source from one of these modes, then it will be better to set **VCR** mode **On**. To do this, while the item is highlighted, press the ◀ / ▶ buttons to set it **On**.

If you want to watch a **DVD**, then you must set this item as **Off**.

## Store Program

Press ▲ or ▼ button to select **Store Program**. Press ▶ or **OK** button to store the settings. "**Program Stored**" will be displayed on the screen.

## Program Menu

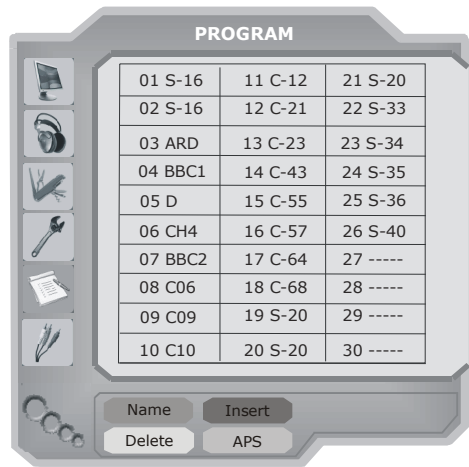

By moving the cursor in four directions you can reach 20 programmes in the same page. You can scroll the pages up or down by pressing the navigation buttons to see all the programmes in TV mode (except for the AV modes). By cursor action, programme selection is done automatically.

### Name

To change the name of a programme, select the programme and press the **RED** button.

The first letter of the selected name will be highlighted. Press ▲ or ▼ button to change that letter and ◀ / ▶ button to select the other letters. By pressing the **RED** button, you can store the name.

### Insert

Select the programme which you want to insert by navigation buttons. Press the **GREEN** button. By navigation buttons move the selected programme to the decided programme space and press the **GREEN** button again.

### Delete

To delete a programme, press the **YELLOW** button. Pressing the **YELLOW** button again

erases the selected programme from the programme list, and the following programmes shift one line up.

### APS (Auto Programming System)

When you press the **BLUE** button for starting automatic tuning, **Auto Programming System** menu will appear on the screen:



### Country

Press **▲** or **▼** button to select your country. If you want to exit from A.P.S. function, press the **BLUE** button.

When you press **OK** or **RED** button for starting automatic tuning, all stored programmes will be erased and the TV will search for available channels. During the search, the following OSD will be displayed:

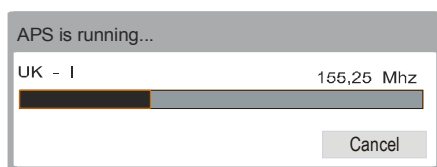

Whenever you press the **BLUE** button, APS function stops and **Program Table** appears on the screen.

If you wait until the end of APS, Program Table will be displayed with the programmes found and located.

### Install Menu in AV Modes

The following screen appears in the install menu when the TV is in AV modes. Note that limited options will be available. Switch to TV mode for viewing complete version of the **Install** menu.



### Colour System

Press **▲** or **▼** button to select **Colour System**. Use **◀** / **▶** button to change the colour system to **PAL**, **SECAM**, **PAL 60**, **NTSC 4,43**, **NTSC 3,58** or **AUTO**.

### VCR

Press **▲** or **▼** button to select **VCR**. Use **◀** / **▶** button to set the **VCR** as On or Off.

### Store Program

Press **▲** or **▼** button to select **Store Program**. Press **▶** or **OK** button to store the settings. "**Program Stored**" will be displayed on the screen.

### Source Menu

Press **▲** or **▼** button and select the sixth icon. Then press **▶** or **OK** button. Source menu appears on the screen:

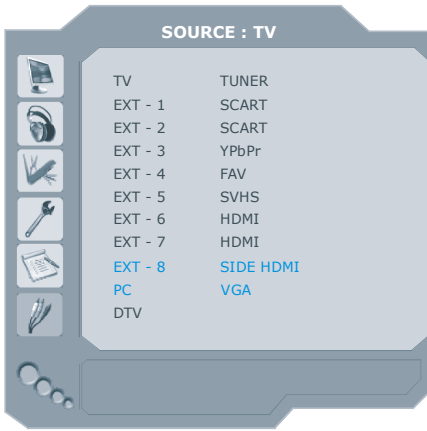

In source menu, highlight a source by pressing ▲ or ▼ button and switch to that mode by pressing ► or OK button. Source options are; **TV, EXT-1, EXT-2, EXT-3, EXT-4, EXT-5, EXT-6, EXT-7, EXT-8, PC** or **DTV**.

**Note:** *Once you have connected optional equipment systems to your TV, you should select the required input to view pictures from that source.*

## PC Mode Menu System

See “**Connecting the LCD TV to a PC**” section for connecting a PC to the TV set.

For switching to **PC** source, press **AV** button on your remote control and select **PC** input. You can also use “**Source**” menu to switch to **PC** mode.

Note that PC mode menu settings are available only while the TV is in PC source.

### Sound Menu

The items in this menu are described at “**Sound Menu**” section explained in “Analogue TV Menu System”.

### Feature Menu

Feature menu settings are identical to the settings explained in “**Feature Menu**” section in “Analogue TV Menu System”.

### PC Picture Menu

For adjusting PC picture items, do the following:

Press ▲ or ▼ button to select the **second icon**. PC Picture menu appears on the screen.

**Brightness, Contrast** and **Colour Temperature** settings in this menu are identical to settings defined in TV picture menu under “Analogue TV Menu System”.

### PC Picture Position Menu

Select the first icon by pressing ▲ or ▼ button. Press then ► or OK button. **PC Picture Position** menu appears on the screen:

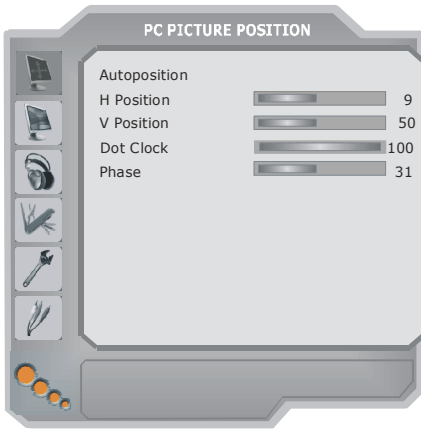

## Autoposition

If you shift the picture horizontally or vertically to an unwanted position, use this item to put the picture into correct place automatically. This setting therefore automatically optimizes the display.

Select Autoposition item by using ▲ or ▼ buttons. Press **OK** button.

**Warning:** Auto position adjustment recommended to be done with the full screen image for the proper adjustment.

## H (Horizontal) Position

This item shifts the image horizontally to right hand side or left hand side of the screen.

Select **H Position** item by using ▲ or ▼ button. Use ◀ / ▶ button to adjust the value.

## V (Vertical) Position

This item shifts the image vertically towards the top or bottom of the screen.

Select **V Position** item by using ▲ or ▼ button. Use ◀ / ▶ button to adjust the value.

## Dot Clock

Dot Clock adjustments correct the interference that appear as vertical banding in dot intensive presentations like spreadsheets or paragraphs or text in smaller fonts.

Select **Dot Clock** item by using ▲ or ▼ buttons. Use ◀ / ▶ button to adjust the value.

## Phase

Depending on the resolution and scan frequency that you input to the TV set, you may see a hazy or noisy picture on the screen. In such a case you can use this item to get a clear picture by trial and error method.



Select **Phase** item by using ▲ or ▼ buttons. Use ◀ / ▶ button to adjust the value.

Note: In case of picture shifting while making connections to computers, picture adjustments can be made by using V Position, H Position, Dot Clock and Phase settings.

## Displaying TV Information

**Programme Number**, **Programme Name**, **Sound Indicator** and **Zoom Mode** information is displayed on the screen when a new programme is entered or  button is pressed.

## Mute Function

Press  button to disable sound. Mute indicator  will be displayed in the upper side of the screen.





To cancel mute, there are two alternatives; the first one is pressing the  button and the second one is increasing the volume level.

## PIP (Picture-in-Picture) and PAP (Picture-and-Picture) Modes

Press the  button to switch to PIP mode.

At PIP Mode, a small picture (PIP picture) is displayed on the main picture. There are 1 size and 4 positions (upper left, upper right, bottom left and bottom right) available for the PIP window. You can use  button to change the PIP position. Aspect Ratio of the PIP window is fixed and 4:3.

When PIP Mode is entered, the default active window is the PIP window and the active window is indicated by a white frame around it. The active window can be changed by pressing  button. The status info OSD belongs to active window. The place of the status OSDs are same for both windows.

Press the  button again to exit the PIP mode.

Press the  button to switch to PAP mode.

At PAP Mode, two pictures with equal sizes are displayed on the screen. Aspect Ratios of the windows are fixed.

When you switch to PAP Mode, Main window in PIP Mode is displayed on the right side of the screen. The active window can be changed by pressing  button.

Press the  button again to exit the PAP mode.

Source restrictions of PAP Mode are same as in PIP Mode. It is not possible to show 2 different channels from the TV tuner at the same time.

**NOTE:** In all HDMI modes, PIP and PAP are not visible. In YPbPr 1080i, PIP is not visible.

**NOTE:** See Appendix B for all PIP/PAT modes.

## Picture Mode Selection

By pressing **PP** button, you can change **Picture Mode** settings in accordance with your viewing requirements.

## Freezing Picture

You can freeze the picture on the screen. Press the **OK** button to freeze picture. Press again to quit freeze mode.

## Zoom Modes

You can change the aspect ratio of the TV for viewing the picture in different zoom modes.

Press  button to directly change the zoom mode.

Available zoom modes are listed below.

**Note:** In **YPBPR** and **HDMI** modes, while in 720 and 1080 resolutions, **Full 1** and **Full 2** modes will also be visible.

## Auto

When a **WSS (Wide Screen Signalling)** signal, which shows the aspect ratio of the picture, is included in the broadcast signal or the signal from an external device, the TV automatically changes the **Zoom** mode according to the **WSS** signal.

- When the **AUTO** mode does not function correctly due to poor **WSS** signal quality or when you want to change the **ZOOM** mode, change to another **ZOOM** mode manually.

### Full

This uniformly stretches the left and right sides of a normal picture (4:3 aspect ratio) to fill the wide TV screen.

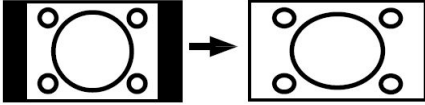

- For 16:9 aspect ratio pictures that have been squeezed into a normal picture (4:3 aspect ratio), use the **Full** mode to restore the picture to its original shape.

### 4:3

Use to view a normal picture (4:3 aspect ratio) as this is its original size.

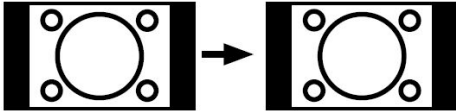

### Panoramic

This stretches the left and right sides of a normal picture (4:3 aspect ratio) to fill the screen, without making the picture appear unnatural.

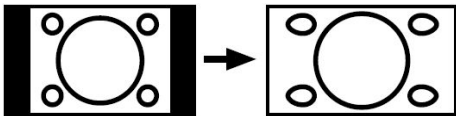

The top and bottom of the picture are slightly cut off.

### 14:9 Zoom

This zooms up the wide picture (14:9 aspect ratio) to the upper and lower limits of the screen.

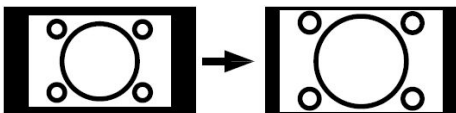

### Cinema

This zooms up the wide picture (16:9 aspect ratio) to the full screen.

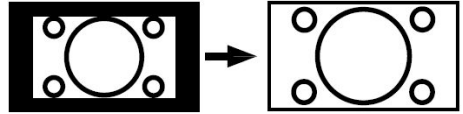

### 16:9 Subtitle

This zooms up the wide picture (16:9 aspect ratio) with subtitles to the full screen.

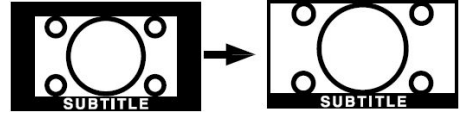



## Teletext

Teletext system transmits information such as news, sports and weather on your TV. Note that if the signal becomes insufficient, some text errors may occur or the teletext mode may be quitted.

*Teletext function buttons are listed below:*

### **Teletext On/Off / PAT mode**

Activates teletext mode when pressed once. Pressing this button again will split the screen into two windows, one displaying the teletext and the other displaying the current channel. Pressing again will quit the teletext mode.

### **Index**

Selects the teletext index page.

### **Mix**

Places the teletext screen over the programme.

### **Expand**

Press once to enlarge top half of the page, press again to enlarge the bottom half of the page. Press again to revert back to normal size.

### **Reveal**

Shows hidden information (e.g. solutions of games).

### **Hold**

Holds a text page when convenient. Press again to resume.

### **Subcode Pages / Time**

Selects subcode pages if available when the teletext is activated. When the teletext is not activated, displays time info if the programme has teletext transmission.

### **P+ / P- and numbers (0-9)**

Press to select a page.

*Note: Most TV stations use code **100** for their index pages.*

## Coloured Buttons

### **(RED/GREEN/YELLOW/BLUE)**

Your TV supports both **FASTTEXT** and **TOP text** systems. When these systems are available, the pages are divided into groups or topics.

When **FASTTEXT** system is available, sections in a teletext page will become colour-coded and can be selected by pressing the coloured buttons. Press a coloured button that corresponds to with your needs.

The coloured writings will appear, showing you which coloured buttons to use when **TOP text** transmission is present. Pressing **P -** or **P +** commands will request the next or previous page respectively.

## Appendix A: PC Input Typical Display Modes

The display has a maximum PC resolution of 1360 x 768, frequency range of 56-85 Hz.

The following table is an illustration of some of the typical video display modes.

Your TV may not support different resolutions. Supported resolution modes are listed below.

If you switch your PC to an unsupported mode, a warning OSD will appear on the screen.

Mode	Resolution		Frequency	
	Horizontal	Vertical	Hor.(kHz)	Ver.(Hz)
1	640	480	31,5	60
2	640	480	37,9	72
3	640	480	37,5	75
4	800	600	35,2	56
5	800	600	37,9	60
6	800	600	48,1	72
7	800	600	46,9	75
8	800	600	53,7	85
9	1024	768	48,4	60
10	1024	768	56,5	70
11	1024	768	60	75
12	1280	1024	64	60
13	1280	768	47,8	60
14	1360	768	47,7	60

Note : Your PC may not work correctly with some resolution modes which are listed above because of unexpected causes. When you confront with such a problem, please try switching your PC to different resolution modes.

## Appendix B: DVI Typical Display Modes

Mode	Resolution		Frequency
	Horizontal	Vertical	Ver.(Hz)
1	640	480	60
2	800	600	56
3	800	600	60
4	800	600	72
5	800	600	75
6	800	600	85
7	1024	768	60
8	1024	768	70
9	1024	768	75
10	1024	768	85
11	1152	864	75
12	1280	768	60
13	1280	1024	60
14	1360	768	60

# Appendix C: Main and PIP-PAP Picture Combinations

## Main and PIP, PAP picture combinations

MAIN	TUNER	DTV	EXT-1 CVBS	EXT-1 RGB	EXT-2 CVBS	EXT-2 RGB	EXT-3 YPBPR	EXT-4 CVBS	EXT-5 S-VHS	EXT-6 HDMI-1	EXT-7 HDMI-2	EXT-8 SIDE HDMI	PC
PIP,PAP ↓													
TUNER	0	X	0	0	0	0	0	0	0				0
DTV	X	0	0	0	0	0	0	0	0				0
EXT-1 CVBS	0	0	X	0	0	0	0	0	0				0
EXT-1 RGB	0	0	X	0	0	0	0	0	0				0
EXT-2 CVBS	0	0	0	0	0	X	0	0	0				0
EXT-2 RGB	0	0	0	0	X	0	0	0	0				0
EXT-3 YPBPR	X	X	X	X	X	X	X	X	X				X
EXT-4 CVBS	0	0	0	0	0	0	0	0	0				0
EXT-5 S-VHS	0	0	0	0	0	0	0	0	0				0
EXT-6 HDMI-1													
EXT-7 HDMI-2													
EXT-8 SIDE HDMI													
PC	X	X	X	X	X	X	X	X	X				X

(X: Not available, O : Available)

Note: While watching analogue TV, you can view digital TV in PIP window or vice versa.

Note:

In case of PIP/PAP at main analog ch and sub analog ch , same analog ch is only permitted.

In case of PIP/PAP at main digital ch and sub digital ch , same digital ch is only permitted.

## Appendix D: AV and HDMI Signal Compatibility

Source	Supported Signals		Available
<b>EXT-1 (SCART 1)</b>	PAL 50/60		<b>O</b>
	NTSC 60		<b>O</b>
	RGB 50		<b>O</b>
	RGB 60		<b>O</b>
<b>EXT-2 (SCART-2)</b>	PAL 50/60		<b>O</b>
	NTSC 60		<b>O</b>
	S-VHS 50		<b>X</b>
	S-VHS 60		<b>X</b>
<b>EXT-3 (YPbPr) Side HDMI</b>	480I	60Hz	<b>O</b>
	480P	60Hz	<b>O</b>
	576I	50Hz	<b>O</b>
	576P	50Hz	<b>O</b>
	720P	50Hz	<b>O</b>
	720P	60Hz	<b>O</b>
	1080I	50Hz	<b>O</b>
	1080I	60Hz	<b>O</b>
<b>EXT-4 (FAV)</b>	PAL 50/60		<b>O</b>
	NTSC 60		<b>O</b>
<b>EXT-5 (S-Video)</b>	PAL 50/60		<b>O</b>
	NTSC 60		<b>O</b>
<b>HDMI1 HDMI2</b>	480I	60Hz	<b>O</b>
	480P	60Hz	<b>O</b>
	576I	50Hz	<b>O</b>
	576P	50Hz	<b>O</b>
	720P	60Hz	<b>O</b>
	720P	50Hz	<b>O</b>
	1080I	60Hz	<b>O</b>
	1080I	60Hz	<b>O</b>
	1080P	50Hz	<b>O</b>
	1080P	60Hz	<b>O</b>
	1080P	24 HZ	<b>O</b>

**(X: Not Available, O: Available)**

**Note:** In some cases a signal on the LCD TV may not be displayed properly. The problem may be an inconsistency with standards from the source equipment (DVD, Set-top box, etc...) If you do experience such a problem please contact your dealer and also the manufacturer of the source equipment.

## Appendix D: Pin Specifications

### Signal Input

#### PC RGB Terminal (D-sub 15-pin connector)

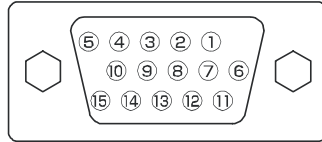

Pin	Input signal
1	R
2	G or sync on green
3	B
4	No connection
5	No connection
6	R.GND
7	G.GND
8	B.GND
9	No connection
10	GND
11	No connection
12	[SDA]
13	H.sync or H/V composite sync
14	V.sync. [V.CLK]
15	[SCL]

- When different kinds of input signals are simultaneously input to the monitor via a graphics board or the like, the monitor will automatically select the signals in the following priority order:

Sync signal type	Priority
H/V separate sync.	1
H/V composite sync.	2
sync.on Green *	3

- Even in the case of the recommended signals shown on the following page, there may be instances when correct display is not possible. In this case, use H/V separate sync, H/V composite sync.

#### S-input connector pin specifications

Pin	Input signal
1	Y
2	Y-GND
3	C
4	C-GND
Frame	GND

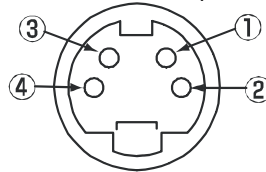

#### HDMI connector pin specifications

Pin	Input signal	Pin	Input signal
1	TMDS Data2+	11	TMDS Clock Shield
2	TMDS Data2 Shield	12	TMDS Clock-
3	TMDS Data 2-	13	CEC
4	TMDS Data 1+	14	Reserved (N.C. on device)
5	TMDS Data1 Shield	15	SCL
6	TMDS Data1-	16	SDA
7	TMDS Data0+	17	DDC/CED Ground
8	TMDS Data0 Shield	18	+5V Power
9	TMDS Data0-	19	Hot Plug Detect
10	TMDS Clock+		

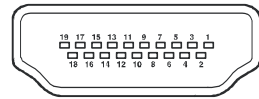

#### SCART connector pin specifications

Pin	Input signal	Pin	Input signal
1	AUDIO OUT (RIGHT)	12	Not used
2	AUDIO IN (RIGHT)	13	RGB-R GND
3	AUDIO OUT (LEFT/MONO)	14	GND
4	AUDIO IN (LEFT/MONO)	15	RGB-R / S.VHS CHROMINANCE IN
5	RGB-B GND	16	BLANKING SIGNAL
6	AUDIO IN (LEFT/MONO)	17	COMPOSITE VIDEO GND
7	RGB-B IN	18	BLANKING SIGNAL GND
8	AUDIO / RGB SWITCH / 16:9	19	COMPOSITE VIDEO OUT
9	RGB-G GND	20	COMPOSITE VIDEO / S.VHS LUMINANCE IN
10	Not used	21	GND / SHIELD (CHASSIS)
11	RGB-G IN		

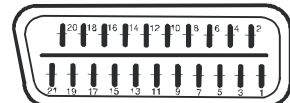

## Appendix E: Important Instruction

For your own safety read following instruction carefully before attempting to connect this unit to the mains supply.

### MAINS (AC) OPERATION

The wires in the mains lead are coloured in accordance with the following code :

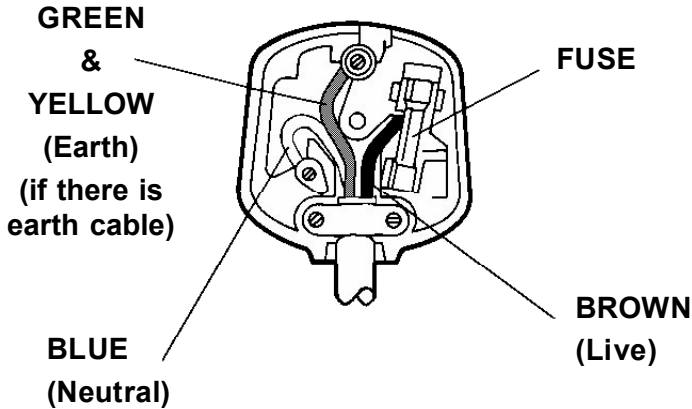

### IMPORTANT

As the colours of the wires in the mains lead of this appliance may not correspond with the coloured markings identifying the terminals in your plug, proceed as follows:

The Green and Yellow coloured wire must be connected to the terminal which is marked with the letter E, or by the earth symbol, or with Green or Green and Yellow colors.

The Blue or Black coloured wire must be connected to the terminal which is marked with the letter N or black colour.

The Brown or Red coloured wire must be connected to the terminal which is marked with the letter L or Red colour.

For continued protection against risk of fire, replace only with a fuse with the same type and rating. (ASTA approved 5A 250VAC fuse).

### CAUTION

TO PREVENT ELECTRIC SHOCK DISCONNECT FROM THE MAINS BEFORE REMOVING COVER. NO USER SERVICEABLE PARTS INSIDE. REFER SERVICING TO QUALIFIED SERVICE PERSONNEL.

### SAFETY PRECAUTION

THIS DEVICE MUST BE DISCONNECTED FROM THE MAINS WHEN NOT IN USE. DO NOT ALLOW THIS UNIT TO BE EXPOSED TO RAIN OR MOISTURE.

## Specifications

### TV BROADCASTING

PAL/SECAM B/G D/K K' I/I' L/L'

### RECEIVING CHANNELS

VHF (BAND I/III)

UHF (BAND U)

HYPERBAND

CABLE TV (S1-S20/ S21-S41)

### NUMBER OF PRESET CHANNELS

100

### CHANNEL INDICATOR

On Screen Display

### RF AERIAL INPUT

75 Ohm (unbalanced)

### OPERATING VOLTAGE

220-240V AC 50Hz

### AUDIO

3D Panorama

### AUDIO OUTPUT POWER ( $W_{RMS}$ ) (10% THD)

2 x 8

### POWER CONSUMPTION (W)

270 W

<1 W (Stand-by)

### PANEL

16:9 display, 42" Screen Size

### DIMENSIONS (mm)

DIMENSIONS (mm)				
D	L	H	Weight (kg)	
284	1037	737	24,8	With stand
122	1037	698	20,7	Without stand

Your SANYO product is designed and manufactured with high quality materials and components which can be recycled and reused.

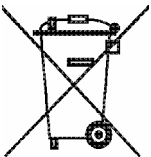

This symbol means that electrical and electronic equipment, at their end-of-life, should be disposed of separately from your household waste. Please dispose of this equipment at your local community waste collection/recycling centre.



In the European Union there are separate collection systems for used electrical and electronic products.

Please help us to conserve the environment we live in!





## THE GUARANTEE

---

The seller of this equipment (the vendor) warrants to the initial retail purchaser that if the equipment becomes defective, and the defect is shown to be due to faulty materials or workmanship within a period of 12 Months from the date of sale to the original purchaser it will be repaired (or at the vendors sole option) replaced free of charge, always providing that: The equipment has at all times been used in accordance with the operating instructions issued by the manufacturer, and has not been connected to an electrical supply for which it has not been properly adjusted.

Unauthorised repairs or modifications, which have not been expressly approved by the manufacturer, shall render this guarantee null and void.

---

This guarantee is not transferable and is only applicable in the UK.

Nothing in this express warranty affects the statutory rights available to the purchaser of this equipment

### EXCLUSIONS

---

SANYO shall not be liable for any removal or installation or re-installation of the equipment.

The warranty does not cover Failure due to fair wear and tear of any item.

Cosmetic items, remote controls or parts and consumable items such as lamps, filters, batteries, tapes, cables or connectors.

Accidental damage or damage caused by negligence or misuse by the user.

Failure caused by lightning strike, storage or operation outside the specified environment, incorrect installation, lack of routine maintenance outlined in the operating instructions supplied with the unit, incorrect fitting of lamps, filters, batteries or other consumables or parts.

Units not originally supplied by SANYO Europe Ltd through a UK Reseller.

*Dear Customer.*

Thank you for buying SANYO. This equipment should give you many years of pleasure and faithful service but in the event that a fault occurs, the following notes for your guidance may be helpful:-

- 1: PLEASE RETAIN YOUR PURCHASE RECEIPT WHICH WILL BE REQUIRED FOR SERVICE DURING WARRANTY.
- 2: If your SANYO equipment proves faulty during the period of guarantee, take it or send it back to the dealer who originally supplied it together with this guarantee and the proof of purchase. We have made arrangements with our approved dealers under which they will carry out in guarantee service repairs on our behalf. In this way, we hope to reduce to a minimum the amount of time you will be without your equipment.
- 3: If for some reason it is impossible to return the equipment to the original supplier, please contact our Customer Relations Department at the address below for further advice.
- 4: Should the equipment require servicing after the expiry of the guarantee period, take or send it to the original supplier or any other Sanyo dealer. He will be pleased to give you a quotation for the repair.

---

Customer Relations Department,  
SANYO Europe Ltd.  
SANYO House,  
18, COLONIAL WAY,  
Watford, Hertfordshire, WD24 4PT.  
Tel: 01923 246363

### Manufacturer and Address

SANYO Electric Co., Ltd.

5-5, Keihan-hondori, 2-chome, Moriguchi City, Osaka, Japan

### Authorized Representative and Address

SANYO FISHER Sales (Europe) GmbH

Stahlgruberring 4, D-81829 Munich, Germany



50130052

