

SANYO

INSTRUCTION MANUAL

**CE28FWN2-B
CE32FWN2-B**

Colour Television

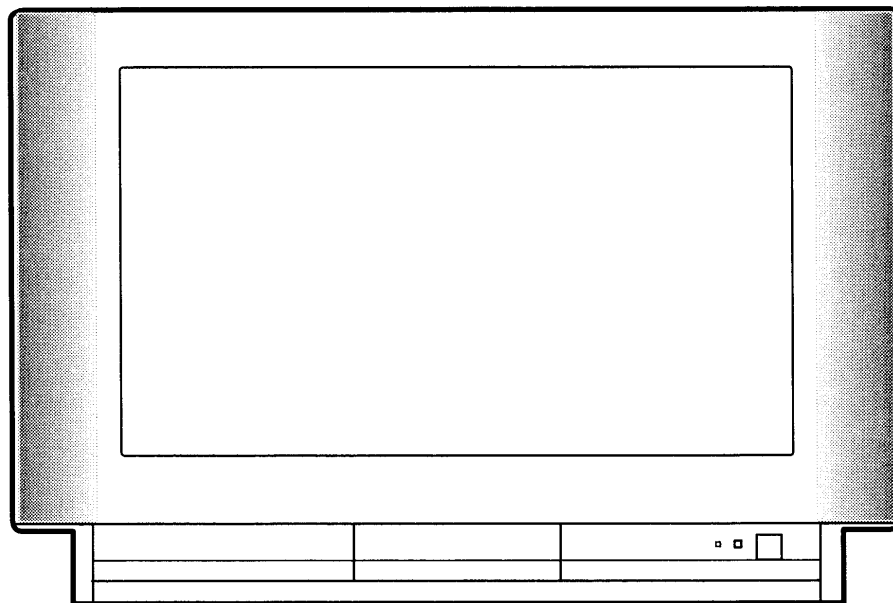

TABLE OF CONTENTS

SAFETY PRECAUTIONS

Installation	3
Use	3

INSTALLATION

STEP 1: Battery Installation	4
STEP 2: Aerial Installation	4
STEP 3: AC cord connection	4
STEP 4: Automatic setting up Channels	5

CONTROLS

Controls	6
----------------	---

GENERAL OPERATION

Switching-on/Off with mains switch	7
Switching into/from standby mode	7
Programme Selection	7
Channel Selection	7
Sound & Picture Settings	8
Picture mode selection and personal preferences setting	9

ADDITIONAL FUNCTIONS

Child Lock	9
Programme Information Display	9
Previous Programme Selection	9
Time Display	9

SCREEN OPTIONS

Selection of Picture Sizes	10
----------------------------------	----

SOUND OPTIONS

Selection of surround mode	11
BBE On/Off	11
MaxxBass-Virtual Subwoofer	12
Stereo Bilingual Reception	12

USING AV EQUIPMENT

Selection of AV mode	13
Setting of AV2 input mode	13
Use of front AV3 terminal	13
Selection of sound track from the equipment	13
Selection of colour system	13
VCR use	13
Connections	14

TIMER

Off Timer Setting	15
On-Timer Setting	15
Alarm Timer Setting	16

PRESETTING

Automatic Tuning/Sorting	16
Semi-automatic tuning	17
Channel Swapping	17

TELETEXT	18-19
-----------------------	-------

OTHERS

Specifications	20
Option setting	20
Servicing	21
Helpful Hints	21
Warranty to customer	22

SAFETY PRECAUTIONS

CAUTION: Please read and retain for your safety. This unit has been engineered and manufactured to assure your personal safety. But improper use can result in potential electric shock or fire hazards. In order not to defeat the safeguards incorporated in this receiver observe the following basic rules for its installation, use and servicing.

Installation

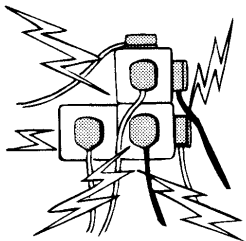

Do not allow anything to rest on the power cord. **Do not** locate this television receiver where the cord will be damaged by people walking on it.

Do not overload wall outlets and extension cords as this can result in fire or electric shock.

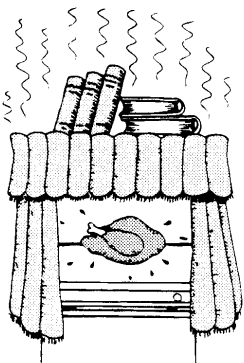

Slots and openings in the cabinet and in the back or bottom are provided for ventilation to ensure reliable operation and to protect it from overheating.

These openings **must not** be blocked or covered. The opening **should never** be covered with a cloth or other material, and the bottom openings **should not** be blocked by placing the television receiver on a bed, sofa, rug, or other similar surface. This television receiver **should never** be placed near or over a radiator or heater.

This television receiver **should not** be placed in a built-in installation such as a bookcase unless proper ventilation is provided.

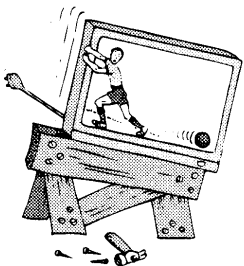

Do not place your television receiver on an unstable stand, shelf or table. Serious injury to an individual, and damage to the television may result if it should fall. Your sales person can recommend approved stands or shelf and wall mounting instructions.

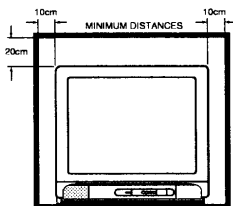

If the television is built into a unit, or enclosed, the minimum distances for ventilation must be maintained. Heat build up can reduce the life of your television, and can be dangerous.

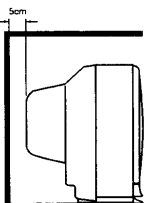

Use

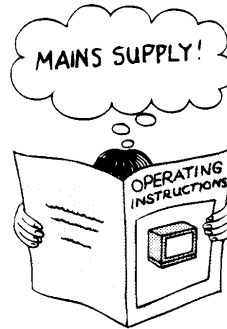

This television receiver should be operated only from the type of power source indicated on the television or as indicated in the Operating Instructions. If you are not sure of the type of power supply in your home, consult your sales person or your local power company.



Never add accessories that have not been specifically designed for this television.

Do not drop or push objects into the television cabinet slots or openings. Some internal parts carry hazardous voltages and contact may result in an electric shock hazard. **Never** spill liquids of any kind on the television receiver.

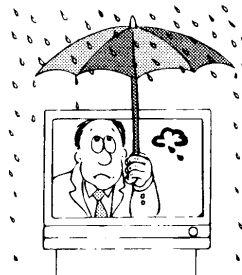

Do not expose the television receiver to rain or use near water. For example, near a bathtub, kitchen sink, in a wet basement, etc. Before cleaning, unplug the television receiver from the wall socket.

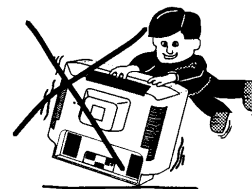

Never stand on, lean on or push suddenly the television or its stand. You should pay special attention to children. Serious injury may result if it should fall.

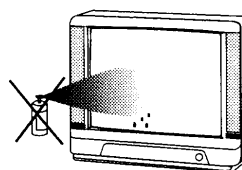

Do not apply liquid cleaners or aerosol cleaners directly onto the television receiver. Use a damp cloth for cleaning.

INSTALLATION

Step 1 : Battery Installation

1. Remove the battery cover by sliding it in direction of the arrow.
 2. Install two "AA" 1.5 volt batteries so that the "+" and "-" marks on the batteries match the "+" and "-" marks inside the unit.
 3. Close the battery cover.
- ☞ Replace the batteries when the TV set is showing the following symptoms: Operation is unsteady or erratic, sometimes the TV does not work with the transmitter. Discharged batteries may leak and damage the unit. The normal life of batteries should be from nine to ten months.

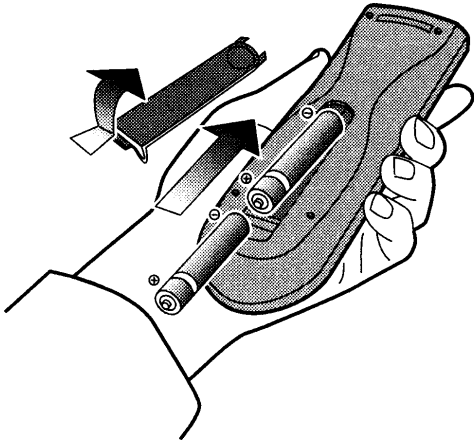

Step 2 : Aerial Connection

- Insert an aerial plug tightly into the aerial socket on the back of the TV set.
- ☞ For all aerial problems please consult your local dealer.
- ☞ The connection to the peripheral AV equipment, refer to section "USING AV EQUIPMENT" on pages 13 & 14.

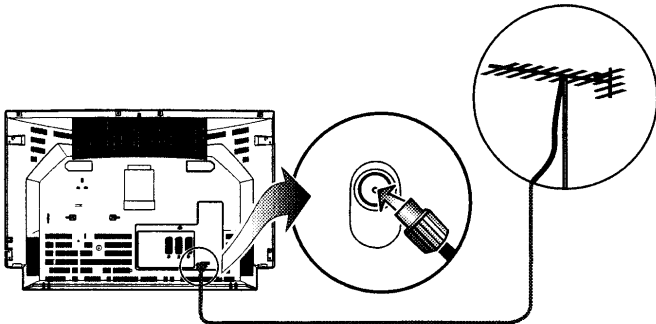

Step 3 : AC Cord Connection

Connect the power cord of the TV set to a wall outlet.

- ☞ The TV set is prepared for a mains voltage AC220~240V, 50Hz. When the TV set is not to be used for an extended period of time, it is advisable to disconnect the power cord from the power outlet.



WARNING!

High voltages are used in the operation of this set. Refer service to qualified service personnel.

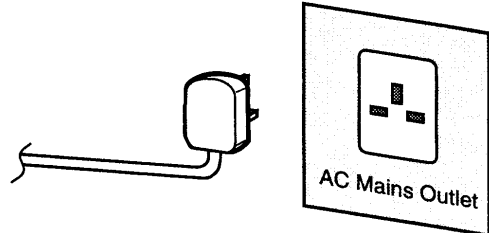

Important:

This equipment is fitted with an approved non rewirable UK mains plug. To change a fuse in this type of plug proceed as follows:

1. Remove the fuse cover and fuse.
2. Fit a new fuse which should be a BS1362 5Amp A.S.T.A. or BSI approved type.
3. Ensure that the fuse cover is correctly refitted.

If the fuse cover is lost or damaged the plug must **NOT** be used but replaced with a serviceable plug. If the fitted plug is not suitable for your socket outlets, it should be cut off and an appropriate plug fitted in its place. If the mains plug contains a fuse, this should have a rating of 5Amp, ensure the fuse cover is correctly fitted. If a plug without a fuse is used, the fuse at the distribution board should not be greater than 5Amp.

Note: The severed plug must be destroyed to avoid a possible shock hazard should it be inserted into a 13Amp socket elsewhere.

The wires in this mains lead are coloured in accordance with the following code:

Blue -----> Neutral
Brown ----> Live

1. The Blue wire must be connected to the terminal which is marked with the letter "N" or coloured BLACK.
2. The Brown wire must be connected to the terminal with the letter "L" or coloured RED.
3. **Do not** connect either wire to the earth terminal in the plug which is marked with the letter "E" or by the earth symbol or coloured GREEN or GREEN and YELLOW.

Before replacing the plug cover, make certain that the cord grip is clamped over the sheath of the lead - not simply over the wires.

INSTALLATION

Step 4 : Automatic Channel Set up

This TV set provides a self-automatic tuning and sorting function called "Plug & Play". The first time you switch on this TV set, it will automatically begin to search and store all available channels.

■ Let's start !

Press the **Mains ON/OFF** switch on the front of the TV.

If no picture appears but the power indicator is on, press the **⏻**, **▶**, **▶** or **0-9** button as the TV set is in the standby mode.

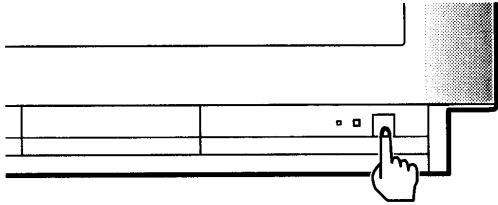

The power indicator illuminates red to show the power is on.

- ☞ Please make sure that the aerial cable is connected to the aerial socket of the TV set before switching-on.
- ☞ To receive a satellite broadcast, a satellite tuner is required. Before carrying out the automatic setting up procedure, the satellite receiver should be correctly tuned in.
- A self-automatic tuning and sorting system will be started as follows;

The tuning status and welcome messages will appear on the screen.

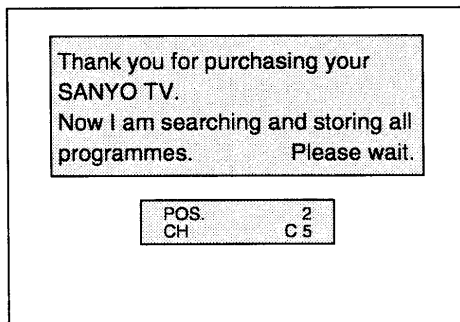

After completing this procedure, the ending message will appear on the screen.

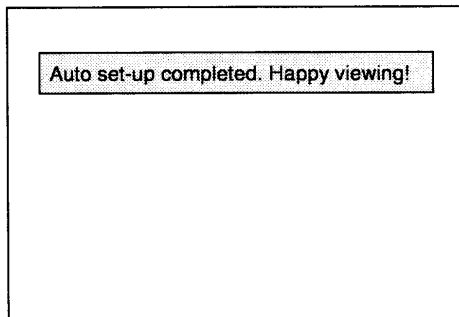

To make this message disappear, press any of the control buttons.

Now the installation is completed !

■ Channel Sorting

The channels are stored in consecutive programme positions starting at programme position "7". After all receivable channels have been found and stored, the TV set automatically allocates the following major stations in the UK into the programme positions 1 to 6.

BBC1	BBC2	ITV	CH4
CH5	SKY	BBC-W	BBC-P

CH4 : Channel 4 or S4C
SKY : SKY GOLD, SKY SPORTS.etc
BBC-W : BBC World, BBC Worldwide feature 1
BBC-P : BBC Prime

Programme position 1 : BBC1
Programme position 2 : BBC2
Programme position 3 : ITV
Programme position 4 : CH4 or S4C
Programme position 5 : CH5
Programme position 6 : SKY, BBC-W or BBC-P

- ☞ If any of them are not available in your reception area, some programme positions from 1 to 6 will not have a stored station. The remaining stations will be stored from programme position 7 in sequence as found.
- ☞ The "Plug & Play" only appears the first time you switch on.
- ☞ If additional channels become available (you move to another city or cable is installed), please follow the description "PRESETTING". (on pages 16 & 17).

CONTROLS

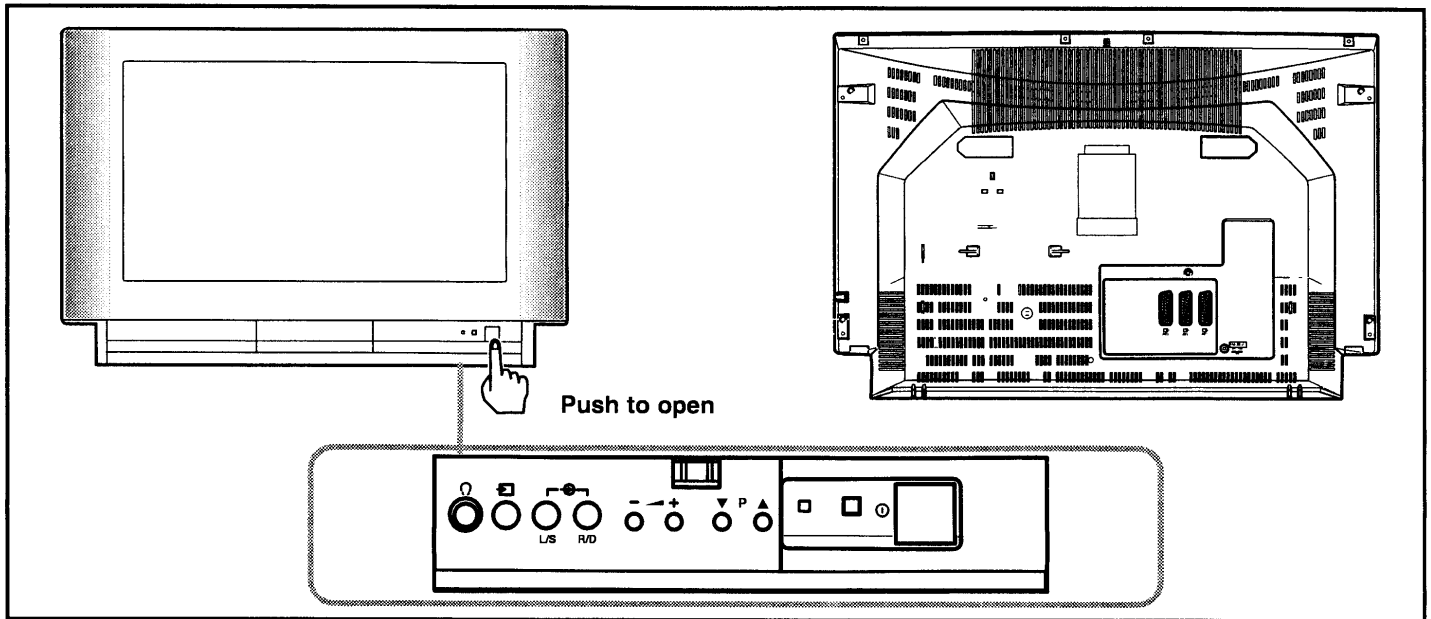

Controls and Terminals on TV

Symbol	Function
	Mains On/Off switch
	Programme Down/Up
	Level Down/Up
	Video input AV3
	Audio input L R AV3
	Headphone socket

Controls on the Remote Control Handset

Symbol	Function
	Pointer Up/Down operates as the Programme Down/Up button
	Pointer Left/Right operates as the Level Down/Up button
	Programme Down/Up
	Level Down/Up
	TV/AV selector
	Sound attenuation
	Power on/Standby
MENU	Menu function call
SURROUND	Active 3D surround mode selector
	Picture setting recall
	Programme status call
	Time display
BASS	Bass
0-9	0-9 Numeric buttons
-/-	Digit
CS	Channel Selection mode selector
F.../OK	Function or OK
	Timer setting
VA-B	Nicam/Bilingual selector
P=P	Previous programme selector
WIDE	Screen Mode selector

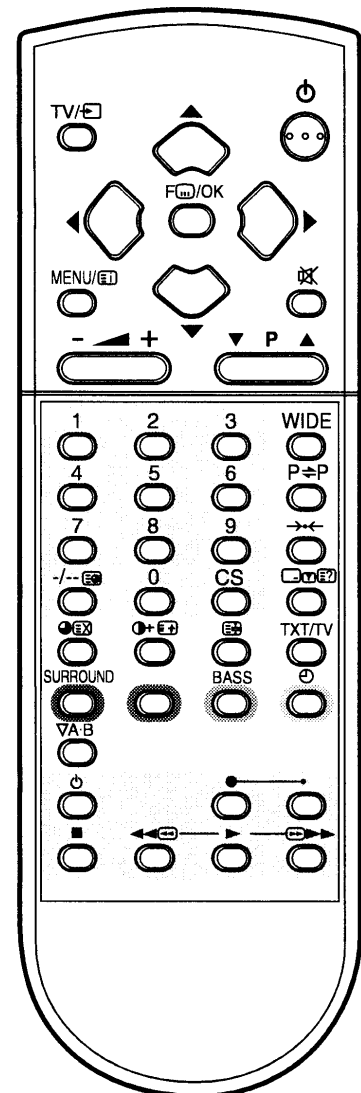

GENERAL OPERATION

Switching-on/off with mains switch

- To turn the TV set ON, press the **Mains ON/OFF switch** on the front of the TV.

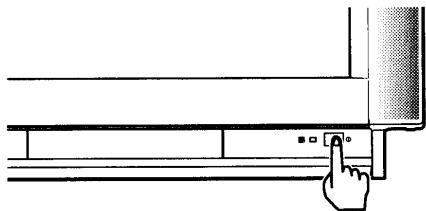

The power indicator illuminates to show the power is on.

- To turn the TV set OFF, press it again.

If no picture appears but the power indicator is on, press the **⏻ button, P▲, P▼ or 0-9 button** as the TV set is in the Standby mode.

Switching into/from standby mode

- To turn the TV set into standby mode, press the **⏻ button**.

The power indicator illuminates more brightly.

- To turn the TV set ON from standby mode, press any of the following buttons: **⏻, P▲, P▼ or 0-9 buttons**.

- ☞ The **Mains ON/OFF switch** must be in the ON position before using the remote control handset.
- ☞ Standby mode is used for switching the TV set off for short periods of time. In standby mode the TV is switched off but is still receiving mains power.



If you find the power indicator flashing, please turn the TV set off completely with the **Mains ON/OFF switch** and contact our service desk.



This warning is a sign to let you know that the power protection function of this TV set is now operating.

Auto Shut Off

This TV set will automatically switch into the standby mode, 10 minutes after a signal is no longer received. The time until the set will switch off is displayed on the screen.

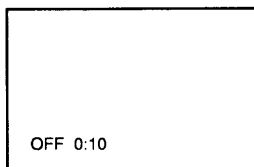

- ☞ If the aerial is removed the TV set will automatically switch into the standby mode after 10 minutes.
- ☞ When the TV set is switched on by using the On-timer function with no signal being received, the auto-shut off function will be ignored.

Programme Selection

Up/Down Programme Selection

Press the **P▲ button** to increase the programme position.
Press the **P▼ button** to decrease the programme position.

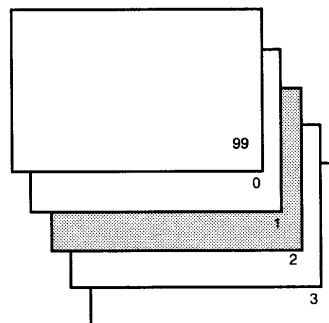

Direct Programme Selection

For selection of programme position 0 to 9, press the corresponding **numeric button (0-9)** on the remote control. For selection of programme position 10-99, for example 23, first press the **-/- button** and enter 2 then 3.

Channel Selection

If you know the channel number of the station

1. Press the **CS button** on the remote control handset. The current channel number, programme position and channel ID if available will be displayed on the screen.

2. Enter the channel number using the **0-9 numeric buttons**.

For example: To enter channel number 2 enter **0** and **2**.
To enter channel number 35 enter **3** and **5**.

3. While the screen display is still on the screen, press the **F \square /OK button** on the remote control handset to store into the memory.

The programme and channel number will momentarily flash.

If you do not know the channel number of the station

1. Press the **CS button** on the remote control handset. The current channel number, programme position and channel ID if available will be displayed on the screen.

2. Press the **P▲ or P▼ button** to start channel searching. When a station is found searching stops automatically.

If this is not the desired station repeat until the desired station is found.

3. While the screen display is still on the screen, press the **F \square /OK button** on the remote control handset to store into the memory.

The programme and channel number will momentarily flash.

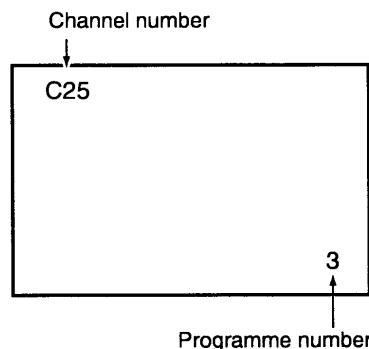

GENERAL OPERATION

Sound & Picture Settings

■ Sound volume control

To adjust the sound volume, press the + / - button.

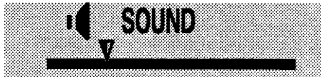

■ Sound Attenuation

This function has two sound mute stages. Press the button once, the sound from the speakers will be reduced, press it again and it will be muted completely.

Press the button again to switch the sound back on.

When the + / - button is pressed, the sound attenuation is cancelled.

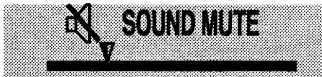

■ Control selection and adjustment

For picture setting adjustment, press the / button repeatedly to select your desired control and then press the + or - button.

● Picture Controls

CONTRAST : To adjust the picture contrast.

BRIGHTNESS : To adjust the picture brightness.

COLOUR : To adjust the picture colour.

TINT: To adjust the colour phase (appears when receiving a NTSC signal only).

SHARPNESS : To adjust the picture sharpness.

TEXT BRIGHTNESS : To select the teletext brightness level of the teletext mode.

FINE TUNING : To make fine adjustments to tuning. (appears in TV mode only)

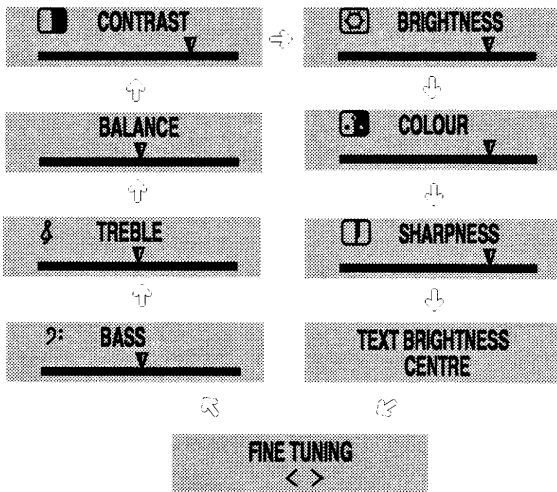

● Sound Controls

BASS : To adjust low frequency sounds.

TREBLE : To adjust high frequency sounds.

BALANCE : To equalise the output from the left and right speakers.

■ Picture adjustment using the menu function

1. Press the **MENU** button to display the main menu. Use the or button to highlight the **PICTURE** menu.

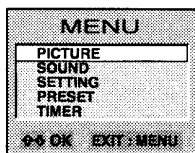

2. Press the / button

3. Use the or button to highlight the desired control from the menu eg. **BRIGHTNESS**.

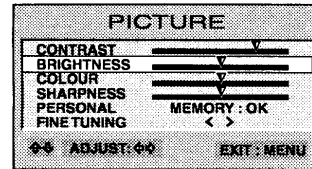

4. When pressing the or button once, the screen display will change for selected control mode, press and hold button to change desired picture control level. The mode returns to control selecting mode in 2 seconds if no key is pressed.



Repeat steps 3-4 for setting the proper picture levels.

To return to the TV mode, press the **MENU** button.

■ Sound adjustment using the menu function

1. Press the **MENU** button to display the main menu. Use the or button to highlight the **SOUND** menu.

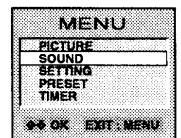

2. Press the / button on the remote control handset or the **OK** button on the TV front panel.

3. Use the or button to highlight the desired control from the menu eg. **BASS**.

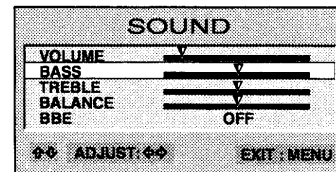

4. Press the or button to adjust the selected control level up or down.

To return to the TV mode, press the **MENU** button.

GENERAL OPERATION-ADDITIONAL FUNCTIONS

Picture mode selection and personal preference setting

This TV provides three predefined picture modes and one adjustable personal picture preference mode. You can choose your preferred picture mode by pressing the **→←** button repeatedly.

PERSONAL : Personal preference mode.

STANDARD : Normal viewing mode.

ECO : Low contrast, brightness and colour picture setting (Suitable for dimly lit rooms and gives a cinema-like effect when the lights are switched off, or Economical mode).

DYNAMIC : High contrast, brightness and colour picture setting (Suitable for brightly lit rooms).

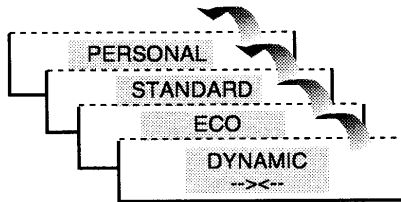

■ To store your personal preference into "PERSONAL" mode

1. Press the **MENU** button to display the main menu. Use the **▲** or **▼** button to highlight the **PICTURE** menu and press the **F** button/OK button.

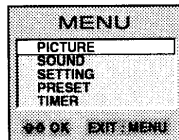

2. Adjust picture controls to your preferred control level by using the **▲**, **▼** or **◀**, **▶** buttons.

3. Use the **▲** or **▼** button to highlight the **PERSONAL** menu and press the **F** button/OK button. The control window will momentarily blink to show the memorisation.

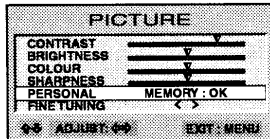

To return to the TV mode, press the **MENU** button.

The fine tuning control level will not be memorised into the "PERSONAL" mode.

■ Child Lock

This TV has a child lock function which inhibits the use of the buttons on the front of the TV set. With this you can prevent small children unexpectedly pressing buttons.

● SETTING

1. Press the **MENU** button to display the main menu. Use the **▲** or **▼** button to highlight the **SETTING** menu.

2. Press the **F** button/OK button.

3. Use the **▲** or **▼** button to highlight the **CHILD LOCK** menu. Select "ON" or "OFF" by pressing the **◀** or **▶** button.

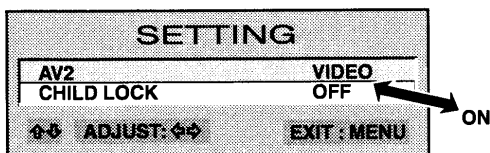

To return to the TV mode, press the **MENU** button.

To cancel the child lock mode, follow the above procedure and you should select "OFF" in step 3 or switching off the TV set with the **Mains ON/OFF** switch.

■ Programme Information Display

Press the **□** button once, the programme information such as current programme number, stereo status, remaining timer if set and colour system.

■ Previous Programme Selection

Press the **P=P** button and the TV set will alternately select the current programme position and the previous programme position viewed.

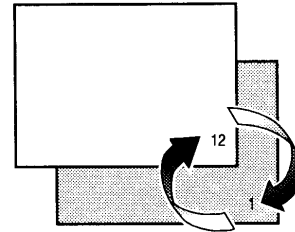

■ Time Display

In the TV mode, if the receiving programme has a teletext service when the **⊖** button is pressed, the present time will be displayed on the screen for 5 seconds.

GENERAL OPERATION - SCREEN OPTIONS

SCREEN OPTIONS

WSS (Wide-Screen-Signaling)

This function is to be automatically set to the optimum screen mode for the wide screen television according to the aspect ratio bits of the picture format (16:9, 14:9, 4:3, etc.) on the teletext broadcast. To use this function, the picture mode should be selected to the "AUTO" mode and the picture format information is available on the teletext service.

Selection of Picture Sizes

The size of the picture image can be selected in many modes, the resultant picture will depend upon the transmission format. Currently pictures are transmitted in a variety of aspect ratios, eg. 4:3, 16:9, 14:9 or video formats such as letterbox. To select the picture modes press the **WIDE button**, each time it is pressed the mode changes as follows.

■ AUTO

4:3: This will automatically switch to the NATURAL WIDE mode.

14:9: This will automatically switch to the NATURAL WIDE mode.

16:9: This will automatically switch to the NATURAL WIDE mode.

LETTERBOX: Automatically detects the black bands at the top and bottom of the screen and switches to ZOOM 16:9 mode.

■ NATURAL WIDE

4:3: Stretches the picture horizontally and fills the screen, the picture is more stretched at the sides.

14:9: Height is expanded to fill screen.

16:9: Fills the whole screen with the correctly proportioned picture.

LETTERBOX: The black bars top and bottom remain and the height is compressed to fit into the picture area.

■ ZOOM (14:9)

4:3: The correct picture width is maintained but the top and bottom of the picture are cropped.

14:9: Zooms in slightly cropping the top and bottom.

16:9: Zooms in slightly cropping the top and bottom.

LETTERBOX: The black bars top and bottom are smaller and the pictures height is compressed slightly.

■ TITLE IN (14:9)

4:3: Zoom as zoom 14:9 but the bottom half of the picture is compressed to show more image to include sub titles.

14:9: The bottom half of the picture is compressed to show sub titles.

16:9: The bottom half of the picture is compressed to show sub titles.

LETTERBOX: The bottom half of the picture is compressed to show more image to include sub titles. A small black bar becomes visible.

■ ZOOM (16:9)

4:3: The correct picture width is maintained but the top and bottom of the picture are cropped more than in zoom 14:9.

14:9: Zooms in slightly cropping the top and bottom more than in zoom 14:9.

16:9: Zooms in slightly cropping the top and bottom more than in zoom 14:9.

LETTERBOX: Fills the screen with the correct proportions with no black bars.

■ TITLE IN (16:9)

As Zoom 14:9 TITLE-IN but the picture is compressed more at the bottom.

■ FULL

4:3: The whole screen is filled stretching the width.

14:9: The whole screen is filled with the height slightly expanded at the edges.

16:9: The whole screen is filled with the correct aspect ratio.

LETTERBOX: A black bar is present top and bottom with the picture compressed to fit the height.

■ NORMAL

4:3: The correct ratio is maintained giving black bars left and right.

14:9: Black bars left and right the height is stretched to fill the height.

16:9: Black bars left and right the height is stretched to fill the height.

LETTERBOX: Black bars left and right and top and bottom.

RECEPTION→	4:3	14:9	16:9	Letterbox Video
MODE				
AUTO				
NATURAL WIDE				
ZOOM (14:9)				
TITLE-IN (14:9)				
ZOOM (16:9)				
TITLE-IN (16:9)				
FULL				
NORMAL				

GENERAL OPERATION - SOUND OPTIONS

SOUND OPTIONS

Selection of Surround Mode

Press the **SURROUND** button repeatedly, the surround mode changes as follows;

VIRTUAL DOLBY SURROUND -> **ACTIVE 3D SURROUND** -> **SURROUND OFF** ->

■ VIRTUAL DOLBY SURROUND

This mode is recommended to watch a movie or programme which is encoded with Dolby Surround. It is marked with  **Dolby Surround**. You can obtain the Dolby Surround effect through the left and right front speakers.

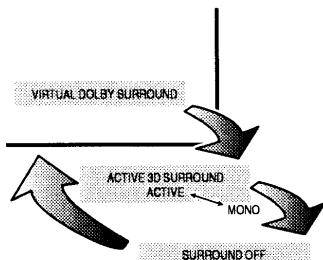

What is Virtual Dolby Surround ?

Home theatre surround systems normally use five speakers: three across the front (L, C, R) and two surround speakers on the sides. A virtual surround system attempts to create the same surround effect produced by a multichannel system using the left and right speakers.



Manufactured under license from Dolby Laboratories. "Dolby" and the double-D symbol are trademarks of Dolby Laboratories.



The QSound Trademarks are registered in the United States, Canada and numerous foreign countries. QSurround™ is a trademark of QSound Labs, Inc.

■ ACTIVE 3D SURROUND

This mode is recommended when you wish to add the surround sound to a programme not encoded with Dolby Surround or movie. This TV provides an active 3D surround processor which can create a 3 dimensional sound effect when receiving a standard stereo signal, bilingual signal or monaural signal.

You can choose the following 3D surround modes by pressing the **◀** or **▶** button while the active 3D surround display is still on the screen.

ACTIVE : Normal 3D surround sound, set to give the optimum 3D surround effect.

MONO : This mode is specially prepared for Nicam-mono broadcasting. Select this mode, when you can not get the 3D surround effects even if the status is Nicam stereo. You may feel 3D surround effect.

■ SURROUND OFF

This mode reproduces only the left and right front sound signals. The rear and centre speakers are not active.

What is Active 3D surround?

In traditional stereo sound, left and right channels combine to create a stereo image. Better speakers can create a larger perceived sound stage, so sound seems to emanate from a few feet behind the monitor. Sound can have a much wider presence with Active 3D surround technologies. Music and sound effects appear to come from points in the room far from the speakers. Objects (such as jets) seem to move towards and then past the listener, whilst the important channel sound still appears to come from the centre of the screen.



QXpander™ is a trademark of QSound Labs, Inc.

■ Guidance for the best enjoyment of active 3D surround and Virtual Dolby Surround

Optimum positioning

- Sit at a distance of approximately 2 to 4 meters from the TV set.
- Listen facing the centre of the TV set.
- Remove any obstructions between you and the TV set.

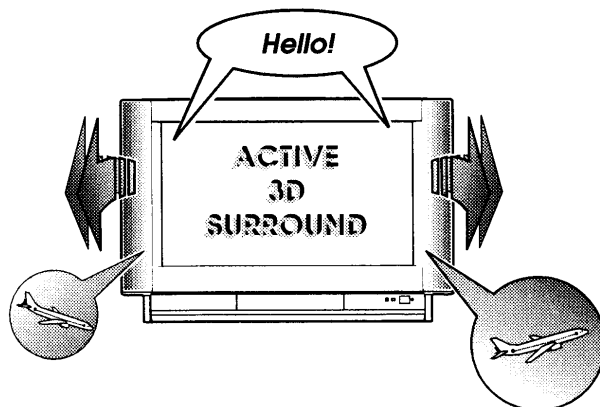
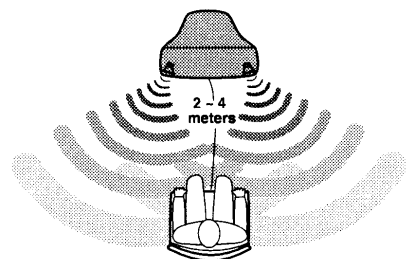

BBE™ ON/OFF

1. Press the **MENU** button to display the main menu. Use the **▲** or **▼** button to highlight the **SOUND** menu.
2. Press the **F** / **OK** button on the remote control handset.
3. Use the **▲** or **▼** button to highlight the **BBE** menu.

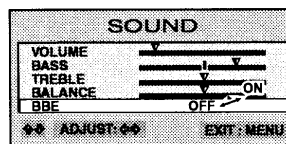
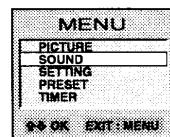

4. Press the **◀** or **▶** button to switch the mode ON or OFF.
- To return to the TV mode, press the **MENU** button.

What is BBE ?

By correcting the phase delay and distortion naturally generated by speaker systems, BBE ensures that the sound that reaches your ears is as natural as the original sound. Human voices are clearer and music is well-defined.



Licensed by BBE SOUND, Inc. under USP4638258 and 4482866. BBE and BBE symbol are trademarks of BBE Sound.

GENERAL OPERATION - SOUND OPTIONS

MaxxBass: Virtual Subwoofer™



This television includes MaxxBass, the most advanced signal processing available for enhanced bass audio response. This patented digital technology transforms your television speaker system into a Virtual Subwoofer™, thereby producing a richer, psychoacoustically-pleasing bass sound usually associated with high-end audiophile systems. You can choose your preferred level of MaxxBass response from the following menu options:

You can choose your preferred bass mode by pressing the **BASS button** repeatedly.

VIRTUAL SUBWOOFER ON: CINEMA
VIRTUAL SUBWOOFER ON: STUDIO
VIRTUAL SUBWOOFER OFF

VIRTUAL SUBWOOFER
ON : CINEMA

VIRTUAL SUBWOOFER
ON : STUDIO

VIRTUAL SUBWOOFER
OFF

Stereo Bilingual Reception

■ Nicam sound reception

If the TV receives nicam programs, it automatically switches to nicam sound reception. The word "NICAM" appears on the screen briefly.

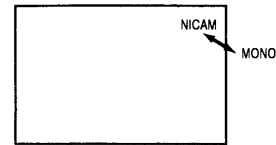

■ Bilingual reception

If the TV receives bilingual programs, the TV initially selects language A and displays "A" on the screen briefly. If you want to switch to language B or Mono, press the **∇A•B button**.

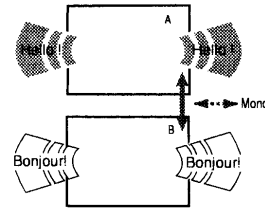

If the nicam sound reception is poor in quality, you can switch to "MONO" sound reception by pressing the **∇A•B button**.

GENERAL OPERATION-USING AV EQUIPMENT

USING AV EQUIPMENT

You can connect a VCR, S-VHS VCR, Satellite Tuner, PAY TV Decoder or Camcorder, to this TV via the SCART terminals and the front AV terminals.

■ Selection of AV mode

Most AV equipment will automatically switch to the AV mode (because of the pin 8 function signal) by pressing the PLAY button on your AV equipment. If not, press the TV/□ button to select the desired AV mode manually.

■ Setting of AV2 input mode

If you want to use a VCR which is equipped with the S-VHS capability, to obtain the best performance, you should connect to the AV2 terminal and select the S-Video mode in the AV2 mode.

● SETTING

1. Press the **MENU** button to display the main menu. Use the ▲ or ▼ button to highlight the **SETTING** menu.

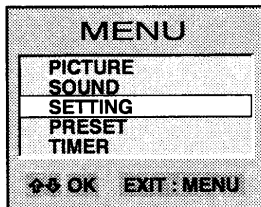

2. Press the **F** /OK button on the remote control handset.

3. Use the ▲ or ▼ button to highlight the **AV2** menu. Select "S-VIDEO" or "VIDEO" by pressing the ◀ or ▶ button.

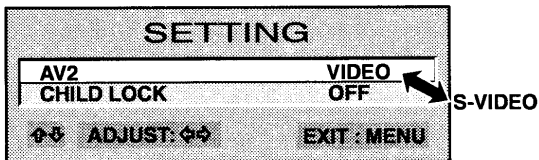

To return to the TV mode, press the **MENU** button.

■ Use of front AV3 terminal

This TV provides one pair of AV input terminal on the front panel. It is very convenient for use as a game or camcorder connection.

Press the TV/□ button to select the AV3 mode.

AV equipment can be connected to either the rear AV3 scart socket or to the front AV3 RCA sockets. If equipment is connected to the front AV3 terminals this will override equipment connected to the rear AV3 scart socket. To use the rear AV3 scart socket please ensure that no equipment is connected to the front AV3 terminals.

■ Selection of the sound track from the equipment

By pressing the ▽A•B button repeatedly, you can select the sound track L (left), R (right) or L/R from the equipment connected to the scart terminals or the front AV terminal.

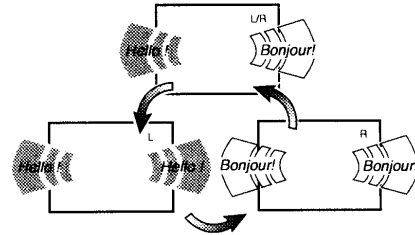

■ Selection of colour system

By pressing the □Y button repeatedly in the AV mode, the colour system mode will be changed as follows;

AUTO -> PAL -> NTSC4.43 -> NTSC3.58 ->

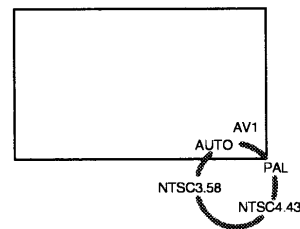

■ VCR Use

This remote control transmitter has been designed to be used in conjunction with selected SANYO VCR's. Some SANYO VCR's may have their own functions, so please refer to the individual instruction booklet when using this remote control to ensure compatibility.

⏻ POWER On/Off :

Use to turn VCR power on and off.

▶ PLAY :

Use to playback the tape.

■ STOP :

Use to stop the movement of the tape.

▶▶ FAST/CUE :

Use to advance the tape at fast speed, or in order to playback the tape at fast speed.

◀◀ REWIND/REVIEW :

Use to rewind the tape or in order to playback the tape in reverse at fast speed.

●—● RECORD :

Use to record on the tape. Press both of the buttons at the same time.

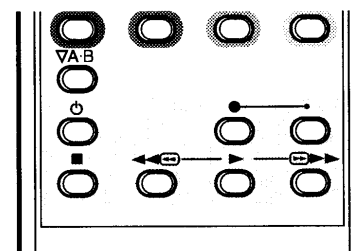

GENERAL OPERATION - USING AV EQUIPMENT

Connections

The following is our recommended standard connection for AV equipment. There are various types of connections depending on the equipment which you have or its particular use. For further information please consult your local dealer. If you have a S-VHS type VCR, to obtain the best performance it should be connected to the AV2 terminal which has been specially designed for S-VHS.

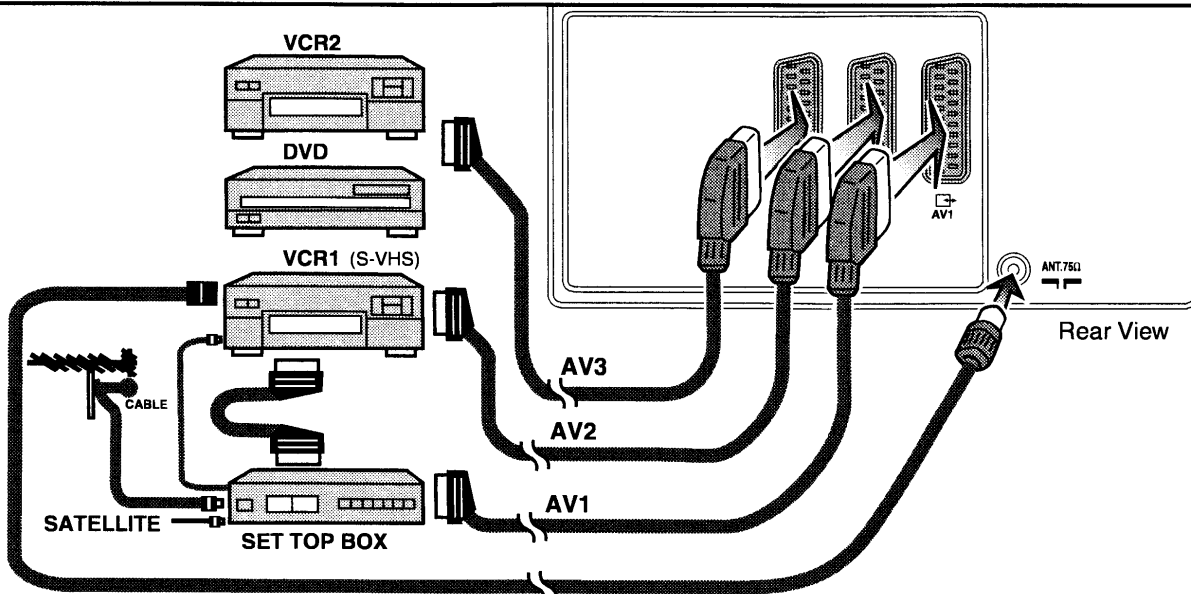

☞ If you do not have a 21 pin Scart cable, you can connect your VCR or other AV equipment via the aerial socket. The VCR should be tuned to programme position 0, this has been especially designed for VCR use.

■ Use of Camcorder or Game Equipment

Connection

✓ Connect an RCA cable from the front AV terminal (AV3) to a camcorder or to game equipment.

☞ For monaural units, connect the sound cable to the L-socket.

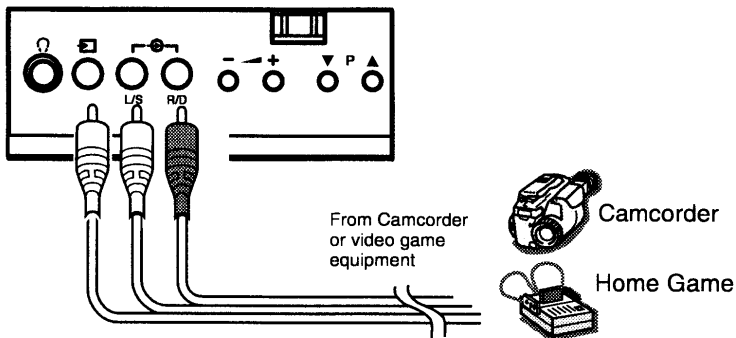

■ Use of Headphones

The 3.5mm mini-stereo jack socket (👁) located behind the door of the TV can be used for headphones. When the headphones are inserted the sound from the TV speakers is muted.

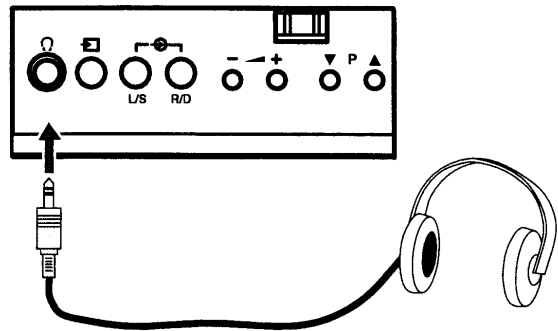

TIMER

This TV has three timer functions and you can select the following modes by pressing the **●** button repeatedly or by using the menu function.

- **Off timer setting** The Off timer will switch into the standby mode when the set time is up.
 - **On-timer setting** The On-timer will switch on from the standby mode when the set time is up.
 - **Alarm timer setting** The Alarm timer will display the time up sign on the screen and beeps when the set time is up.
- ☞ If the TV set is switched off by the Mains ON/OFF switch or a power failure occurs, the timer settings will be cancelled.

Function	Maximum time periods	Step
Off Timer	120 minutes	30 minutes
On-Timer	24:00 Hours	15 minutes
Alarm Timer	3:00 Hours	5 minutes

Off Timer Setting

[Timer Button Selection]

1. Press the **●** button once, the word "OFF TIMER" will appear on the screen.
2. Set the time period by pressing the **◀** or **▶** button. The display changes in 30 minute steps.

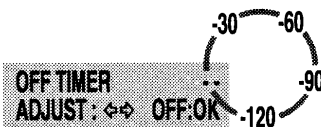

To cancel the off timer, select timer "--" by pressing the **F** button/OK button while the screen display is still on.

[MENU Selection]

1. Press the **MENU** button to display the main menu. Use the **▲** or **▼** button to highlight the **TIMER** menu.
 2. Press the **F** button/OK button.
 3. Use the **▲** or **▼** button to highlight the **OFF TIMER** menu.
 4. Highlight the time setting column by using the **◀** or **▶** button and using the **▲** or **▼** button to select a time period. The display changes in 30 minute steps and the maximum time period is 120 minutes.
- ☞ To change to another timer mode, first select timer selection mode (highlight a row) using the **◀** or **▶** button and then change desired timer mode by using the **▲** or **▼** button.

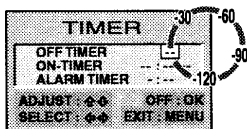
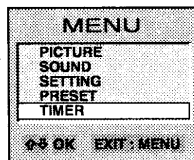

To return to the TV mode, press the **MENU** button.

If you have set a time, then one minute before the TV switches off the remaining minute (-1) automatically appears on the screen.

To cancel the off timer, select timer "--" by using the **▲** or **▼** button in step 4.

On-Timer Setting

[Timer Button Selection]

1. Press the **●** button twice. The word "ON-TIMER" will appear on the screen.

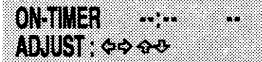

2. Set the time period by pressing the **◀** or **▶** button. The display changes in 15 minutes steps. The maximum time period is 24:00 hours. The colour of the power indicator will change to yellow to show the on-timer has been set.

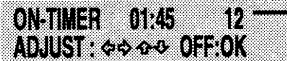

Start up programme position

3. Set the start up programme position by using the **▲** or **▼** button.
4. Press the **⏻** button to switch into the standby mode.

To cancel the on-timer, select timer "--:--" by pressing the **F** button/OK button while the screen display is still on.

[MENU Selection]

1. Press the **MENU** button to display the main menu. Use the **▲** or **▼** button to highlight the **TIMER** menu.
 2. Press the **F** button/OK button.
 3. Use the **▲** or **▼** button to highlight the **ON-TIMER** menu.
 4. Highlight the time setting column or start up programme setting column by using the **◀** or **▶** button and using the **▲** or **▼** button to set a time period or programme position. The display changes in 15 minute steps and the maximum time period is 24:00 hours. The colour of the power indicator will change to yellow to show the on-timer has been set.
- ☞ To change to another timer mode, first select timer selection mode (highlight a row) using the **◀** or **▶** button and then change desired timer mode by using the **▲** or **▼** button.

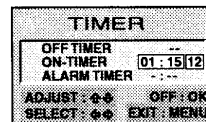
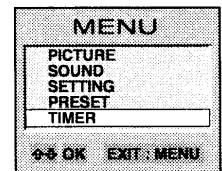

Start up programme position

5. Return to the TV mode by pressing the **MENU** button, and press the **⏻** button to switch into the standby mode.

When the set timer is up, the TV set will switch on and select the start up programme automatically.

To cancel the on-timer, select timer "--:--" by using the **◀** or **▶** button in step 4.

Advance

When it reaches the set on-time and the TV set is kept on, the TV set changes automatically to the programme position which you have set the start-up programme in the on-timer function.

- ☞ When the TV set is switched on by using the on-timer function, the TV set will automatically switch into the standby mode in 3 hours if no key control is input.

TIMER/PRESETTING

Alarm Timer Setting

This function can display the time up sign on the screen as illustrated to let you know that the time has come when the set alarm time is reached. This only happens when the TV is on. This may remind you to do something.

[Timer Button Selection]

1. Press the **●** button three times, the word "ALARM TIMER" will appear on the screen.
2. Set the time period by pressing the **◀** or **▶** button. The display changes in 5 minutes steps. The maximum time period is 3:00 hours.



To cancel the Alarm timer, select timer "--:--" by pressing the **F** button/OK button while the screen display is still on.

[MENU Selection]

1. Press the **MENU** button to display the main menu. Use the **▲** or **▼** button to highlight the **TIMER** menu.

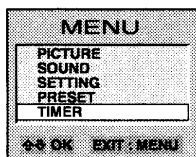

2. Press the **F** button/OK button.

3. Use the **▲** or **▼** button to highlight the **ALARM TIMER** menu.

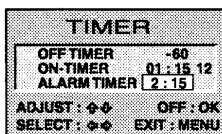

4. Highlight the time setting column by using the **◀** or **▶** button and using the **▲** or **▼** button to select a time period. The display changes in 5 minute steps and the maximum time period is 3:00 hours.

To change to another timer mode, first select timer selection mode (highlight a row) using the **◀** or **▶** button and then change desired timer mode by using the **▲** or **▼** button.

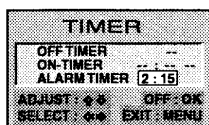

When the time period is up, the time up signal will appear on the screen and the alarm will sound for 15 seconds.

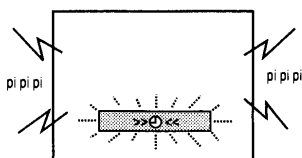

To cancel the Alarm timer, select timer "--:--" by using the **▲** or **▼** button in step 4.

To stop the beep and the alarm display, press any of the control buttons.

Presetting

Up to 100 broadcast stations in your reception area can be stored in the electronic memory.

There are two modes of pre-setting channels as follows:

■ **Automatic tuning and sorting (AUTO TUNE/SORT)**
All receivable channels are automatically tuned in and stored as specified programme position as follows.

■ **Manual tuning (PRG. PRESET)**

Used to preset a receivable channel in any desired programme position.

Automatic Tuning/Sorting (AUTO TUNE/SORT)

1. Press the **MENU** button to display the main menu. Use the **▲** or **▼** button to highlight the **PRESET** menu.
2. Press the **F** button/OK button.
3. Use the **▲** or **▼** button to highlight the **AUTO TUNE/SORT** menu.

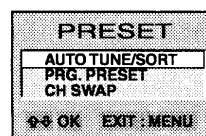
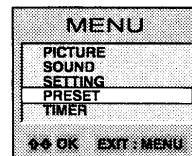

4. Press the **F** button/OK button on the remote control handset to begin automatic tuning and sorting.

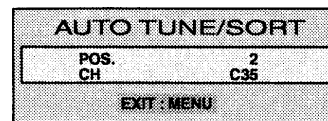

● A self-automatic tuning and sorting system will be started.

☞ The automatic tuning operation can be cancelled at any time by pressing the **MENU** button.

After completing this procedure, the TV set returns to normal TV mode and selects programme position 1.

Channel Sorting

The channels are stored in consecutive programme positions starting at programme position "7". After all receivable channels have been found and stored, the TV set automatically allocates following major stations in the UK into the programme positions 1 to 6.

BBC1	BBC2	ITV	CH4
CH5	SKY	BBC-W	BBC-P

CH4: Channel 4 or S4C

SKY: SKY GOLD, SKY SPORTS.etc

BBC-W: BBC World, BBC Worldwide feature 1

BBC-P: BBC Prime

- Programme position 1 : BBC1
- Programme position 2 : BBC2
- Programme position 3 : ITV
- Programme position 4 : CH4 or S4C
- Programme position 5 : CH5
- Programme position 6 : SKY, BBC-W or BBC-P

☞ You can change the order of station, use the channel swapping-function, refer to page 17.

PRESETTING

Semi-automatic tuning (PRG.PRESET)

1. Press the **MENU** button to display the main menu. Use the **▲** or **▼** button to highlight the **PRESET** menu.

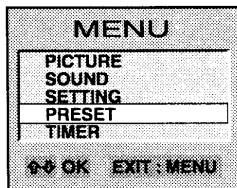

2. Press the **F_□/OK** button on the remote control handset.
3. Use the **▲** or **▼** button to highlight the **PRG.PRESET** menu, then press the **F_□/OK** button on the remote control handset

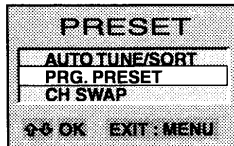

4. Use the **▲** or **▼** button to highlight the **POS.** menu. Select a programme position where you wish the station to be stored by using the **0** to **9**, **-/-**, **◀** or **▶** button.
5. Use the **▲** or **▼** button to highlight the **CH** menu then press the **◀** or **▶** button to start channel searching until your desired station is found. If you know the channel number of the station, enter the channel number by using the **0** to **9** button

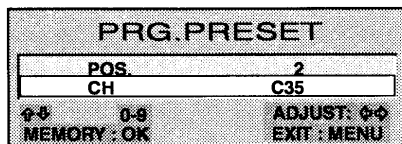

6. Press the **F_□/OK** button to store a station into a memory. The preset window will blink momentarily.

Repeat steps 4 to 5 for other desired channels.

*To exit the presetting mode, press the **MENU** button once.*

Channel Swapping

Use this channel swapping feature to swap the channels between two stored programme positions. This feature is particularly useful after automatic presetting.

1. Select one of TV channels you wish to swap by using the **▲**, **▼** or using the **(0-9)** numeric buttons.
2. Press the **MENU** button to display the main menu. Use the **▲** or **▼** button to highlight the **PRESET** menu.

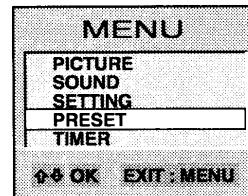

3. Press the **F_□/OK** button.
4. Use the **▲** or **▼** button to highlight the **CH SWAP** menu, then press the **F_□/OK** button.

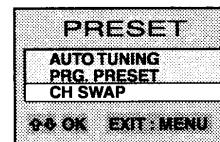

5. Use the **▲** or **▼** button to select the target programme position for swap channels then press the **F_□/OK** button. The preset window will blink momentarily.

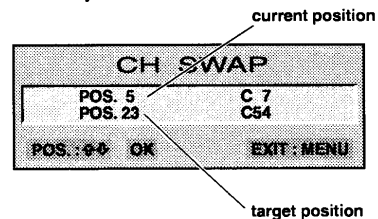

The two TV channels will now have changed places.

Repeat steps 1 to 5 for all the other TV channels you want to swap.

*To return to the normal TV mode, press the **MENU** button.*

TELETEXT

■ Teletext Controls

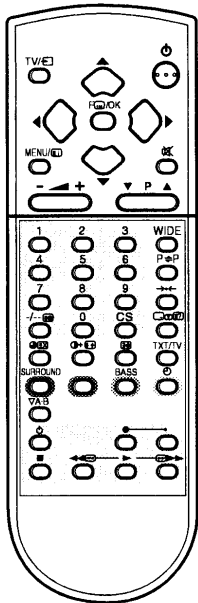

Symbol	Function
TXT/TV	Teletext/Mix/TV mode switch
0-9	0-9 numeric buttons
P▼ P▲	Page down/up
[Ei]	Index page selection
[Hold]	Hold
[Size]	Size
[EX]	Cancel
[Sub code]	Sub code entry mode
[Reveal]	Reveal
[Red]	Red
[Green]	Green
[Yellow]	Yellow
[Blue]	Blue

■ Switching to the Teletext mode

Press the **TXT/TV** button, and the screen changes as illustrated.

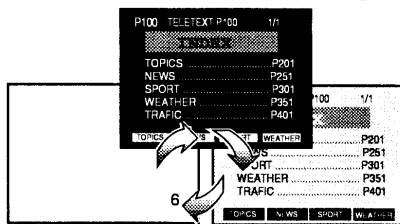

When switching from TV mode at AUTO, NORMAL, NATURAL WIDE, ZOOM, TITLE IN or FULL picture size to teletext mode, the teletext screen will always be at FULL picture size.

■ Picture & Sound in teletext mode

● Picture and Text brightness controls in the teletext mode.
You can not adjust the picture or teletext brightness in the teletext mode. You must first switch back to the TV mode and then adjust the picture control or set the teletext brightness level.

How to set the teletext brightness level

1. Press the **FLOF/OK** button repeatedly in the TV mode until the word "TEXT BRIGHTNESS" appears on the screen.



2. Press the **◀** or **▶** button to select one of the 3 teletext brightness levels either MAXIMUM, CENTRE or MINIMUM.
3. Confirm the selected teletext brightness level by switching to the teletext mode by pressing the **TXT/TV** button.

When the teletext service is not transmitting with the FLOF, 4 coloured page numbers will appear at the bottom of the screen instead of the topics.

● Sound control in the teletext mode.

Only sound volume and muting can be controlled in the teletext mode.

■ Page Selection

● Direct page access

A page can be selected with the **0-9 Numeric buttons**. eg. To display page 301, press buttons 3, 0 and then 1. The selected page number will appear on the screen.



● Up/down page access

Press the **▲** or **▼** button to select the next or previous page number.



■ Coloured page access

Depending on the TV channel, teletext is transmitted in different systems. The system utilised can be recognised by the coloured line at the bottom of the screen.

Press one of the **4 coloured buttons** to select the topics shown at the bottom of the text screen.

For example the Red topic can be selected using the **Red button**, the Blue topic by the **Blue button**, and so forth with the other colours.

■ Index Page Selection

Press the **[Ei]** button to select one of the teletext index pages.

■ Sub page access

With a text page selected which has sub pages, you may wish to read a known sub page number.

1. Press the **[Sub code]** button.

"Sub-Code ----" will be displayed on top of the screen.
2. Enter the sub page number by using the (0-9) buttons.

For example, to enter the sub page 4, press buttons **0, 0, 0** and **4**.

3. Press the **[EX]** button to return the normal TV picture.

Immediately the requested sub-coded page is found, the page number will appear over the TV picture.

4. Press the **TXT/TV** button to view the sub-coded page.

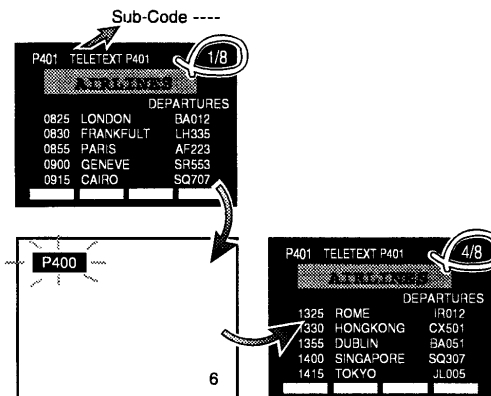

■ Updated Pages

There are teletext pages which are updated as events progress, such as sports results, news reports or traffic information. Select a page which will be updated.

1. Press the **●EX** button to return to the normal TV picture.

Immediately the selected page is updated, the page number will appear over the normal TV picture.

2. Press the **TXT/TV** button to view the updated page.

Note: If the page has sub pages the number will appear when the sub page is changed.

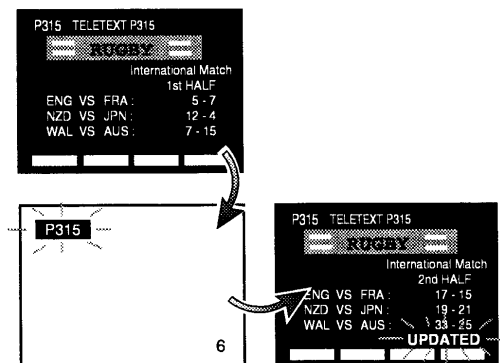

■ Double Letter Height

Either the top half or the bottom half of the page can be expanded to fill the whole screen by pressing the **EX** button.

■ Displaying Concealed Information

Press the **EX** button to reveal hidden items on the text page.

Some pages such as quiz pages have the answers hidden. The button may have to be held to keep the answer on the screen, or pressed again to remove the answers.

Sometimes the page access can take some time. While waiting you can view the TV picture by pressing the **●EX** button.

1. Enter the new page number. Press the **●EX** button.

2. When the page is found, the page number will appear over the TV picture.

3. Press the **TXT/TV** button to view the teletext page.

● Cancel

When you press the **●EX** button, the TV picture appears on the screen. Whilst in this mode you can not select another TV programme. You should first switch back to TV reception by pressing the **TXT/TV** button if required.

● Teletext reception

If your aerial signal is poor, the teletext reception may be poor.

■ Stop

Press the **EX** button to stop sub pages changing. The word "stop !" will appear instead of the page number.

Some teletext pages are made up of several sub pages. These sub pages are automatically changed. Sub page is shown as P4/8 (sub page 4 of 8 pages) the location on the text page depends on the text service.



SPECIFICATIONS / OPTION SETTINGS

TV Specifications

Common specification

Power source	AC 220~240V 50Hz
Television system	System I
Colour system	PAL/NTSC4.43 (PAL/NTSC4.43/NTSC3.58 in AV mode)

Channel coverage	UHF: 21-69
Aerial input impedance	75 ohm

AV terminal	
21-pin terminals	AV1: CENELEC Standard with RGB AV2: CENELEC Standard with S-inputs AV3: CENELEC Standard

Front AV terminals	AV3: RCA Terminal, Video and Audio(L/R) Input
--------------------	---

Sound output (Continuous) (watts)	Main L/R 10 x 2
--------------------------------------	-----------------

	CE	CE
Picture tube (inches)	28	32

Dimensions (WxHxD mm)	780 x 525.5 x 526	880 x 583.5 x 580.5
--------------------------	-------------------	---------------------

Weight (kg)	39	54.5
-------------	----	------

Specifications subject to change without notice.

Option Settings

This TV set allows you to set up the following option settings.

■ PROHIBITION

Prohibit the presetting and sets the current volume as the maximum volume level.

PROHIBITION OFF or ON

■ START POSITION

Presets the programme position when the set is switched on.

START POSITION OFF	Last programme position start
POS 1	Programme position "1" start
POS 2	Programme position "2" start
POS 3	Programme position "3" start
POS 4	Programme position "4" start
POS 5	Programme position "5" start
POS 6	Programme position "6" start
POS 7	Programme position "7" start
POS 8	Programme position "8" start
AV1	"AV1" start

SETTING PROCEDURE

- To enter the special function press and hold the  button on the **Remote control handset** and then press the **P▲** button on the **TV set**.
- Use the **▲** or **▼** button to highlight the desired control item from the menu, and to select the mode press the **◀** or **▶** button.

OPTION SETTING	
PROHIBITION	OFF
START POSITION	OFF
↕ ADJUST: ↕	EXIT: RECALL

- To return to the normal TV mode, press the  button.

Scart Specifications

The specification of the Scart sockets are as follows.

Pin	Signal function	Level	AV1	AV2	AV3
Pin 1	Audio output (right channel)	0.5V/ 1 K ohm	✓	✓	
Pin 2	Audio input (right channel)	0.5V/ 10 K ohm	✓	✓	✓
Pin 3	Audio output (left channel)	0.5V/ 1 K ohm	✓	✓	
Pin 4	Audio earth				
Pin 5	Earth (blue)				
Pin 6	Audio input (left channel)	0.5V/ 10 K ohm	✓	✓	✓
Pin 7	Blue (B) input	0.7Vpp/ 75 ohm	✓		
Pin 8	Remote switch input	L:0-2V H: 10-12V	✓	✓	✓
Pin 9	Earth green				
Pin 10					
Pin 11	Green (G) input	0.7Vpp/ 75 ohm	✓		
Pin 12					
Pin 13	Earth (red)				
Pin 14	Earth				
Pin 15	Red (R) or C (chrominance) input	0.7Vpp/ 75 ohm	✓ *Red input	✓ *C-input	
Pin 16	Fast blanking	L:0-0.4V H: 1-3V	✓		
Pin 17	Earth (video)				
Pin 18	Earth				
Pin 19	Video output	1Vpp/ 75 ohm	✓ *TV output	✓ *monitor output	
Pin 20	Video/sync *1 or Y (luminance) input	1Vpp/ 75 ohm	✓ *Video/sync-input	✓ *Video/Y-input	✓ *Video input
Pin 21	Connector shield				

SERVICING & HELPFUL HINTS

Servicing

Your television is fully transistorised and does not contain any user serviceable components.

Removal of the cabinet cover may expose you to dangerous voltages. Refer all servicing to qualified service personnel.

Unplug the television receiver from the wall outlet and refer servicing to qualified service personnel under the following conditions:

- If the power cord or plug is damaged.
- If liquid has been spilled into the television receiver.
- If television receiver has been exposed to rain or water.
- If the television receiver has been dropped or the cabinet has been damaged.
- If the television receiver exhibits a distinct change in performance.
- If the television receiver does not operate normally by following the operating instructions.

Adjust only those controls that are covered in the operating instructions as improper adjustment of other controls may result in damage. This will often require extensive work by a qualified technician to restore the television receiver to normal operation.

When replacement parts are required, have the service technician verify that the replacements he uses have the same safety characteristics as the original parts. Use of manufacturers specified replacements can prevent fire, shock or other hazards.



Helpful Hints

■ NO PICTURE, NO SOUND

- Check if TV is plugged in.
- Try a different channel, if OK, probably station trouble.

■ POOR PICTURE, SOUND OK

- Adjust BRIGHTNESS control.
- Adjust FINE TUNING control.
- Check aerial connections.

■ NO COLOUR, PICTURE OK

- Adjust COLOUR control.
- Adjust FINE TUNING control.
- Is the programme in colour ?

■ WEAK PICTURE

- Check aerial connections on back of set.
- Check aerial for broken wires.
- Re-orient aerial.

■ The following faults are not caused by the receiver.

"GHOSTS"

Reflections of signals from mountains or high buildings will cause multiple images, called "Ghosts". These abnormal conditions can be reduced to minimum by repositioning aerial or by installing new one suited for your area.

"INTERFERENCE"

Interference may be caused by electrical appliances, car ignition systems, etc. This should normally be a temporary condition, but should this interference persist, contact your dealer.

WARRANTY TO CUSTOMER

Sanyo U.K. Sales Ltd. (the company) warrants to the initial retail purchaser that if this equipment is or becomes defective and that, in the opinion of the Company, the defect is due to faulty material or workmanship the Company will, for a period of 12 calendar months from the date of sale to the original purchaser repair or replace, at its sole option, free of charge, any such defective component part of the equipment, always provided that:-

- 1: The equipment has at all times been used in accordance with the operating instructions issued by the Company, and has not been connected to an electrical mains supply for which it has not been adjusted.
- 2: Accidental damage or damage caused by negligence of misuse by the user, is specifically excluded.
- 3: Unauthorised repairs, or any modification to the equipment which has not been expressly approved by the Company, shall render this warranty null and void.
- 4: Failure due to fair wear and tear of any item is specifically excluded.

This warranty is not transferable and is only applicable within the United Kingdom (and the Republic of Ireland).

Nothing in this express warranty affects the statutory rights available to the purchaser of this equipment.

Note: This warranty supersedes any other form of guarantee that may inadvertently have been enclosed with or attached to the product.

Dear Customer.

Thank you for buying SANYO. This equipment should give you many years of pleasure and faithful service but in the event that a fault occurs, the following notes for your guidance may be helpful:-

- 1: PLEASE RETAIN YOUR PURCHASE RECEIPT WHICH WILL BE REQUIRED FOR SERVICE DURING WARRANTY.
- 2: If your Sanyo equipment proves faulty during the period of guarantee, take it or send it back to the dealer who originally supplied it together with this guarantee and the proof of purchase. We have made arrangements with our approved dealers under which they will carry out inguarantee service repairs on our behalf. In this way, we hope to reduce to a minimum the amount of time you will be without your equipment.
- 3: If for some reason it is impossible to return the equipment to the original supplier, please contact our Service Department at the address below for further advice.
- 4: Should the equipment require servicing after the expiry of the guarantee period, take or send it to the original supplier or any other Sanyo dealer. He will be pleased to give you a quotation for the repair.

Service Department,
Sanyo UK Sales Ltd., Sanyo House, Otterspool Way,
Watford, Hertfordshire, WD2 8JX.
Tel: 01923 246363

Part No. 1AA6P1P2822-- C2LR/C2MA

SANYO
Printed in U.K.