

SANYO

INSTRUCTION MANUAL

CE21DN7-B

CE25DN7-B

CE28DN7-B

Colour Television

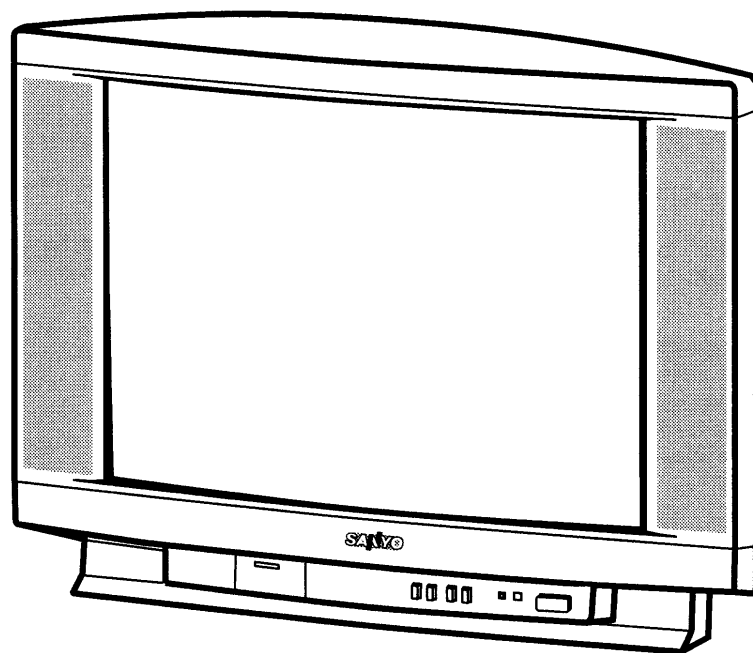

**Please read this Instruction book before using your television.
We wish you many hours of pleasure from your new television.**

SAFETY PRECAUTIONS / SPECIFICATIONS

CAUTION: Please read and retain for your safety. This unit has been engineered and manufactured to assure your personal safety. But improper use can result in potential electric shock or fire hazards. In order not to defeat the safeguards incorporated in this receiver observe the following basic rules for its installation, use and servicing.

Installation

Do not allow anything to rest on the power cord. **Do not** locate this television receiver where the cord will be damaged by people walking on it.

Do not overload wall outlets and extension cables.

The slots in the cabinet and back cover must not be blocked. These slots are for ventilation and if they are blocked will cause over heating and reduce reliability. Do not place your TV next to a heat source.

If the TV is placed into an enclosure, the minimum ventilation distances must be ensured.

Do not place your TV on an unstable surface. Your sales outlet can recommend approved stands etc.

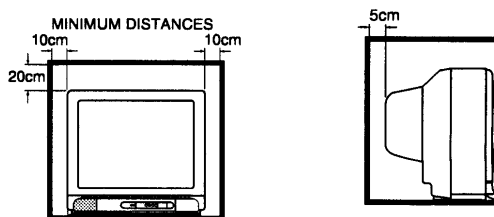

Use

This TV should be operated only from the type of power source indicated on the television or indicated under the Mains supply specifications. If you are not sure of the type of power supply in your home, consult your sales person or your local power company.

Never add accessories that have not been specifically designed for this television.

Do not drop or push objects into the television cabinet slots or openings. Some internal parts carry hazardous voltages and contact may result in an electric shock hazard. **Never** spill liquids into the TV.

Do not place items such as vases containing liquid on top of the TV set.



Do not expose the television receiver to rain or use near water. For example, near a bathtub, kitchen sink, in a wet basement, etc. Before cleaning, unplug the television receiver from the wall socket.

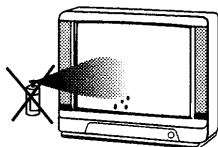

Never stand on, lean on or push the television or its stand. Never allow children to play with the television or its stand. Serious injury may result if it should fall.

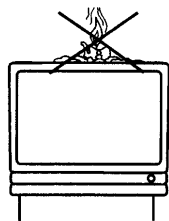

Do not apply liquid cleaners or aerosol cleaners directly onto the television receiver. Use a damp cloth for cleaning.

Do not place candles or hot objects upon the TV, next to it or behind it. Open flames must never be used near the TV set.

Mains supply

The TV set is prepared for a mains voltage AC220~240V, 50Hz.

Connect the power cord of the TV set to a wall outlet. When the TV set is not to be used for an extended period of time, it is advisable to disconnect the power cord from the power outlet.

Important:

This equipment is fitted with an approved non rewireable UK mains plug. To change a fuse in this type of plug proceed as follows:

1. Remove the fuse cover and fuse.
2. Fit a new fuse which should be a BS1362 5Amp A.S.T.A. or BSI approved type.
3. Ensure that the fuse cover is correctly refitted.

If the fuse cover is lost or damaged the plug must **NOT** be used but replaced with a serviceable plug.

If the fitted plug is not suitable for your socket outlets, it should be cut off and an appropriate plug fitted in its place. If the mains plug contains a fuse, this should have a rating of 5 Amp, ensure the fuse cover is correctly fitted. If a plug without a fuse is used, the fuse at the distribution board should not be greater than 5 Amp.

Note: The severed plug must be destroyed to avoid a possible shock hazard should it be inserted into a 13Amp socket elsewhere. The wires in this mains lead are coloured in accordance with the following code:

Blue -----> Neutral
Brown ----> Live

1. The Blue wire must be connected to the terminal which is marked with the letter "N" or coloured BLACK.
2. The Brown wire must be connected to the terminal with the letter "L" or coloured RED.
3. **Do not** connect either wire to the earth terminal in the symbol or coloured GREEN or GREEN and YELLOW.

Before replacing the plug cover, make certain that the cord grip is clamped over the sheath of the lead - not simply over the wires.

TV Specifications

Power source	AC 220~240V, 50Hz		
Television system	System I		
Colour system	PAL/NTSC 4.43 on Air (PAL/NTSC 4.43/NTSC 3.58 in AV mode)		
Channel Coverage	UHF: 21-69		
Aerial input impedance	75 ohm		
AV terminals			
	AV1: CENELEC Standard		
	Input: Composite video, RGB and audio-L/R		
	Output: TV-output with composite video and audio-L/R		
	AV2: CENELEC Standard		
	Input: Composite video, S-VHS and audio-L/R		
	Output: Monitor-output with composite video and audio-L/R		
Sound output	Main L/R	7 watts x 2	
(Continuous)			
Picture tube	CE21DN7-B	CE25DN7-B	CE28DN7-B
(Inches)	21	25	28
Dimensions	612 x 476 x 482	680 x 543 x 442	736 x 597 x 494
(W x H x D mm)			
Weight	21	26	32

SERVICING / HELPFUL HINTS / INSTALLATION

Servicing

Your television is fully transistorised and does not contain any user serviceable components.

You must not remove the rear cover of the TV by yourself. The apparatus is working with high voltages and could damage objects or even endanger people. Leave all required repair and service jobs to an authorised service technician. He will exclusively use such spare parts that are complying with the same safety standards as applicable to the original parts. The use of original spare parts can prevent fire, shock and other hazards.

Unplug the television receiver from the wall outlet and refer servicing to qualified service personnel under the following conditions:

- If the power cord or plug is damaged.
- If liquid has been spilt into the television receiver.
- If the television receiver has been exposed to rain or water.
- If the television receiver has been dropped or the cabinet has been damaged.
- If the television receiver exhibits a distinct change in performance.
- If the television receiver does not operate normally by following the operating instructions.

Adjust only those controls that are covered in the operating instructions as improper adjustment of other controls may result in damage. This will often require extensive work by a qualified technician to restore the television receiver to normal operation.



Helpful hints

■ NO PICTURE, NO SOUND

- Check if TV is plugged in.
- Try a different channel, if OK, probably station trouble.

■ POOR PICTURE, SOUND OK

- Adjust BRIGHTNESS control.
- Adjust FINE TUNING control.
- Check aerial connections.

■ NO COLOUR, PICTURE OK

- Adjust COLOUR control.
- Adjust FINE TUNING control.
- Is the programme in colour ?

■ WEAK PICTURE

- Check aerial connections on back of set.
- Check aerial for broken wires.
- Re-orient aerial.

■ The following faults are not caused by the receiver:

"GHOSTS"

Reflections of signals from mountains or high buildings will cause multiple images, called "Ghosts". These abnormal conditions can be reduced to minimum by repositioning aerial or by installing new one suited for your area.

"INTERFERENCE"

Interference may be caused by electrical appliances, car ignition systems, etc. This should normally be a temporary condition, but should this interference persist, contact your dealer.

Step : 1 Connections

- Connect the aerial into the aerial socket on the back of the TV set.
- Connect the power cord from the TV set to a wall outlet.

Step : 2 Battery Installation

Install two "AA" 1.5 volt batteries so that the "+" and "-" marks on the batteries match the "+" and "-" marks inside the unit.

- Replace the batteries when the TV set is showing the following symptoms: Operation is unsteady or erratic, sometimes the TV does not work with the transmitter. Discharged batteries may leak and damage the unit.

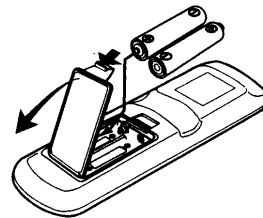

Step : 3 Switching on your TV

This TV set provides a self-automatic tuning function called "Plug & Play". The first time you switch on this TV set, it will automatically begin to search and store all available channels.

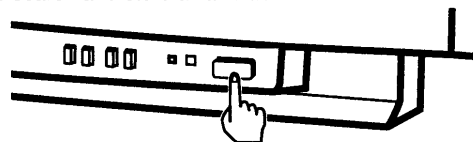

- To turn the TV set ON, press the **Mains ON/OFF switch**. The power indicator illuminates to show the power is on. A self-automatic tuning system will start as follows;

- If the TV set remains in standby mode, press **⏻**, **P▲**, **P▼** or any **0-9** on the remote control.

The welcome message will appear on the screen. To cancel the tuning, press the **MENU** button.

After completing this procedure, the ending message will appear on the screen. To make this message disappear, press any of the control buttons.

Thank you for purchasing your SANYO TV. Now I am searching and storing all the programmes. Please wait.

Auto set-up completed. Happy viewing!

If you find a power indicator flashing, please turn the TV set off completely with Mains ON/OFF switch and contact our Service desk. This warning is a sign to let you know that the power protection function of this TV set is now operating.

■ Channel sorting

The channels are stored in consecutive programme positions starting at programme position "7". After all receivable channels have been found and stored, the TV set automatically allocates following major stations in the UK into the programme positions 1 to 6.

- Programme position 1 : BBC1
- Programme position 2 : BBC2
- Programme position 3 : ITV
- Programme position 4 : CH4 or S4C
- Programme position 5 : CH5
- Programme position 6 : SKY, BBC-World or BBC-Prime

- If any of them are not available in your reception area, some programme positions from 1 to 6 will not have a stored station. The remaining stations will be stored from programme position 7 in sequence as found. This procedure only appears the first time you switch on.

- If additional channels become available (you move to another city or cable is installed), please follow the description "TUNING". (on page 5).

■ Auto shut off

This TV set will automatically switch into the standby mode, 10 minutes after a signal is no longer received or the aerial is removed. The time until the set will switch off is displayed on the screen.

- When the TV set is switched on by using the On-timer function with no signal being received, the auto-shut off function will be ignored.

GENERAL OPERATION

Standby/Power - on

To switch the TV into and out of standby. Standby mode is used for switching the TV set off for short periods of time. In standby mode the TV is switched off but is still receiving mains power.

Screen size

To optimise the picture display to "FULL" or "SQUEEZE". If you receive 16.9 picture ratio transmissions, FULL expands the vertical scale to fill the screen. SQUEEZE keeps the current picture ratio.

Sound mute

To switch the sound from the speakers. The sound changes as follows; normal -> reduced -> muted

TV/AV switch

To switch between TV, AV1, AV2 or AV3 mode repeatedly. (p.6)

Direct programme selector

For direct access to programmes using (0-9) numeric button. For selection of programme position 10-99, for example 23, first press **-/-** button and press 2 and 3 numeric buttons.

Surround selector

To switch the surround mode, OFF, ACTIVE or MONO. (p.3)

MENU

To display or exit from the menus.

Function switch

To access sequentially the picture control mode; **Brightness, Contrast, Colour, Sharpness, Text bright, Bass, Treble and Balance. Tint:** To adjust the colour phase (appears when receiving a NTSC signal only). **Text Bright :** To select the teletext brightness level of the teletext mode.

Programme up / down

To select the next programme number or previous programme number. Also operates as up and down cursor.

Programme information call

To display the programme information such as current programme number, stereo status, sound system and remaining alarm time if set, for about 5 seconds.

Nicam / Bilingual selector

To switch the sound mode as follows; **NICAM** or **MONO** in the nicam stereo programmes. **A, B** or **MONO** in the nicam bilingual programmes. If the nicam sound reception is poor in quality, you can switch to "MONO" sound reception by pressing **A+B** button.

Picture mode selection

To access a series of picture mode: **PERSONAL, STANDARD, ECO** and **DYNAMIC**. (p.4)

Channel mode selection

Press CS button. The current channel number will be displayed on the screen. If you do not know the channel number of the station. Press the **P▲** or **P▼** button to start channel searching. When a station is found searching stops automatically. If this is not the desired station repeat until the desired station is found. If you know the channel number, press CS button again to change to "C-", whilst in the CS mode enter the channel number by using (0-9) numeric buttons. While the screen display is still visible, press **F/OK** button to store your selection into the memory. The colour of the channel number changes white to yellow momentarily. Press the **F/OK** button repeatedly to select your desired control and then press **-** or **+** buttons to adjust the levels of each setting. Repeat for each control setting.

Time call

In the TV mode, if the receiving programme has a teletext service, the present time will be displayed on the screen for 5 seconds.

Bass expander switch

To get an emphasised bass sound.

Programme alternation

To switch between the previous and current programme positions watched.

Level up / down

To adjust the sound and picture control level. Also operates as left and right cursor.

Teletext / TV selector

To switch between TV, MIX and Teletext mode. (p.7)

The keys on the TV

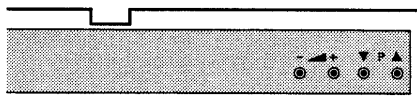

There are **P▲**, **P▼**, **▲+** and **▲-** buttons on the front of the TV. To adjust the sound and picture control levels press **▲+** or **▲-** button. Also operates as left and right cursor.

To select the next programme number or previous programme number press **P▲** or **P▼** button. Also operates as up and down cursor.

Picture mode selection and Personal preference setting

This TV provides three predefined picture modes and one adjustable personal picture preference mode. You can choose your preferred picture mode by pressing the **→←** repeatedly.

PERSONAL : Personal preference mode.

STANDARD : Normal viewing mode.

ECO : Low contrast, brightness and colour picture setting (Suitable for dimly lit rooms and gives a cinema-like effect which the lights are switched off, or Power Economical mode).

DYNAMIC : High contrast, brightness and colour picture setting (Suitable for brightly lit rooms).

To store your personal preference into "PERSONAL" mode.

1. Press the **MENU** to display the main menu. Use the **P▲** or **P▼** button to highlight the **Picture** menu and press the **▲+**.

2. Use **P▲** or **P▼** to highlight desired control from the menu eg. **Brightness**. Press **▲+** or **▲-** to adjust your preferred setting.

3. Store your preference levels by using **P▲** or **P▼** to highlight **memory?** menu and then press **▲+**.

The **memory** shows that the memorisation is completed.

Press **MENU** twice to exit from the menu.

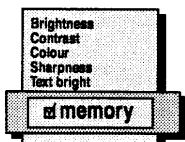
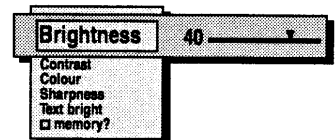
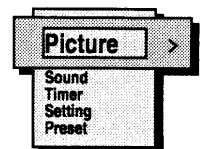

TIMER / TUNING

Timer Setting

This TV has three timer functions and you can select the following modes by using menu function.

■ ON-Timer setting

You can set a time period from which the set will switch on from the standby mode.

■ OFF Timer setting

You can select a time period from which the set will switch into the standby mode.

■ Alarm Timer setting

You can set a time which you want to display the time up sign on the screen and the alarm will beep.

- ☞ To check the remaining time, ON-Timer and OFF Timer, whilst the TV is operating, press the button.
- ☞ If the TV set is switched off by Mains Switch, a power failure occurs or entering the tuning mode, the timer settings will be cancelled. ON-Timer and Alarm Timer settings will be cancelled when entering the standby mode.

Function	Maximum time periods	Step
Off Timer	120 minutes	30 minutes
On-Timer	24:00 Hours	15 minutes
Alarm Timer	3:00 Hours	5 minutes

1. Press the **MENU** button to display the main menu. Use the **P▲** or **P▼** button to highlight the Timer menu.

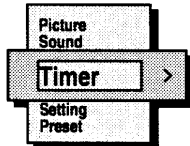

2. Press the **▲+** button to enter Timer menu. Select your desired timer setting menu such as **ON-Timer**, **OFF Timer** and **Alarm Timer** by pressing the **P▲** or **P▼** button.



3. Highlight the time setting column using the **▲+** button, and use the **P▲** or **P▼** button to select a time period. In addition, you can select the start-up programme number for **ON-Timer** mode.



4. Press the **▲+** button twice to set the timer. The shows that the timer has been set. In addition, when you use **ON-Timer** function, you need to switch into the standby mode by pressing the button.

To cancel the timer, press the **-/-** button.

5. Press the **MENU** button repeatedly to exit from the menu.

☞ When the TV set is switched on by using the on-timer function, the TV set will automatically switch into the standby mode in 3 hours if no key control functions are pressed. This is a safety feature to ensure that you are aware that the TV is functioning.

☞ When the set alarm time times out, the time up signal will appear on the screen and the alarm will sound for 15 seconds. To stop the beep and the alarm display, press any of the control buttons.

☞ When the set on-timer, times out, and the TV set is functioning, the TV set will change automatically to the programme position which you have selected in the start-up programme in the on-timer function.

Tuning

■ Automatic tuning/sorting

All receivable channels are automatically found, and stored.

1. Press the **MENU** button to display the main menu. Use the **P▲** or **P▼** button to highlight the **Preset** menu and press the **▲+** button.
2. Use the **P▲** or **P▼** button to highlight the **Tuning** menu, then press the **▲+** button.

3. Select the tuning option using the **P▲** or **P▼** button, then select **AUTO** using the **▲+** or **▲-** button.

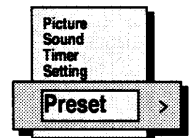

4. Select the channel option using the **P▲** or **P▼** button and press the **▲+** button. The automatic tuning will be started.



To cancel this tuning operation, press the **MENU** button repeatedly.

After completing this procedure, the TV set returns to normal TV mode and selects programme position 1.

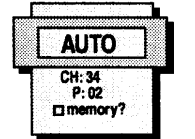

■ Channel sorting

The channels are stored in consecutive programme positions starting at programme position "7". After all receivable channels have been found and stored, the TV set automatically allocates following major stations in the UK into the programme positions 1 to 6, as shown on page 3.

IMPORTANT

If the tuning functions do not operate, please check that the special function "Prohibition" is set to **OFF**, see on page 8.

■ Semi - automatic tuning

Use to preset a receivable channel in any desired programme position.

☞ Please use steps 1. and 2. in Automatic tuning, then follow steps below.

1. Select the tuning option using the **P▲** or **P▼** button, then select **SEMI** using the **▲+** or **▲-** button.

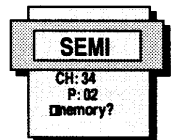

2. Select the programme option using the **P▲** or **P▼** button and press the **▲+** or **▲-** button to select the programme number which you wish the station to be stored.

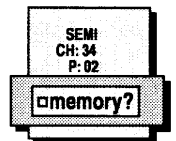

3. Select the channel option using **P▲** or **P▼** button. Press **▲+** or **▲-** button to begin searching. Or if you know the channel number of the station, enter the channel number directly with 2 digit keys.

4. To store your preferred channels, select **memory?** by using the **P▲** or **P▼** button and then press the **▲+** button. The **memory** shows that the memorisation is completed.

Repeat steps 2 to 4 for other desired channels.

Press **MENU** button repeatedly to exit from the menu.

Channel Swapping

Use this channel swapping feature to swap the channels between two stored programme positions. This feature is particularly useful after automatic tuning.

1. First display your preferred programme for swapping. Press the **MENU** button to display the main menu. Use the **P▲** or **P▼** button to highlight the **PRESET** menu. Press the **▲+** button.

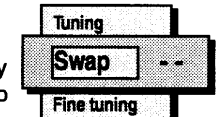

2. Select **Swap** menu using the **P▲** or **P▼** button.

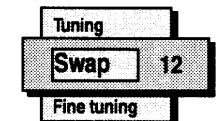

3. Enter the programme number you wish to swap using the **(0-9)** numeric buttons.

4. The channels are swapped by pressing the **▲+** button. Then exit **Tuning** menu, the TV displays your selected programme.

USING AV EQUIPMENT / 3D SURROUND

Using AV Equipment

There are various types of connections depending on the equipment which you have or its particular use. For further information please consult your local dealer.

The TV set has 2 scart sockets at the back of the set. The AV1 socket has audio and video inputs/outputs and RGB inputs. The AV2 socket has audio and video inputs/outputs and S-VHS inputs.

● Use of VCR

Connect a scart cable from VCR to AV2 scart socket. If your VCR does not have a scart socket, the only connection possible is via the aerial cable. You will therefore need to tune in your VCR's test signal and assign it programme number 0 (refer to Tuning, page 5). To watch the VCR picture, select programme number 0.

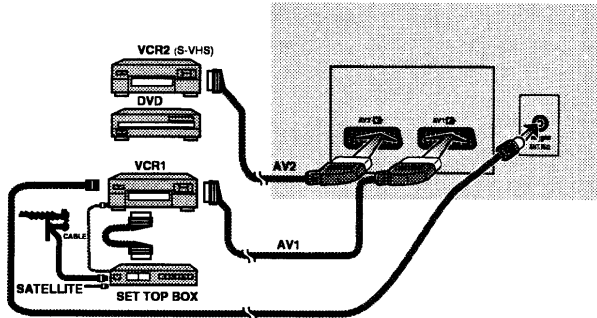

■ VCR with decoder

Connect the decoder to second scart sockets of the VCR. You will then be able to record scrambled transmissions.

■ Satellite receiver, decoder, DVD, games, etc.

Connect a scart cable from VCR to AV1 scart socket. To optimise picture quality, connect the equipment which produces the RGB signals (digital decoder, games, etc.) to AV1, and the equipment which produces the S-VHS signals (S-VHS and Hi-8 VCR, certain DVD drives) to AV2 and all other equipment to either AV1 or AV2.

■ Selection of AV mode

Most AV equipment will automatically switch to the AV mode by pressing the PLAY button on your AV equipment. If not, press TV/□ button to select the desired AV mode manually.

■ Setting of AV2 input mode

You can set the input mode, S-VIDEO or VIDEO, of the AV2 mode following to below procedure.

1. Press the **MENU** button to display the main menu. Use the **P▲** or **P▼** button to highlight the **Setting** menu. Press the **▶** button.

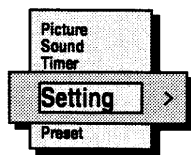

2. Use the **P▲** or **P▼** button to highlight the **AV2** menu. Select "S-VIDEO" or "VIDEO" by pressing the **▶** + or **▶** - button.

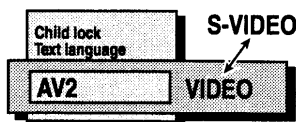

Press **MENU** button twice to exit from the menu.

■ Selection of colour system

Press TV/□ button to select AV mode manually. By pressing the □ button repeatedly in the AV mode, the colour system mode will be changed as follows;

AUTO -> PAL -> NTSC4.43 -> NTSC3.58 ->

Press TV/□ button repeatedly to exit the AV mode.

■ Use of other equipment

● Front AV3 terminal

Connect an RCA cable from a camcorder or game equipment to AV3 input terminal on the front panel. Press the TV/□ button repeatedly to select the AV3 mode.

For monaural units, connect the sound cable to the L-socket.

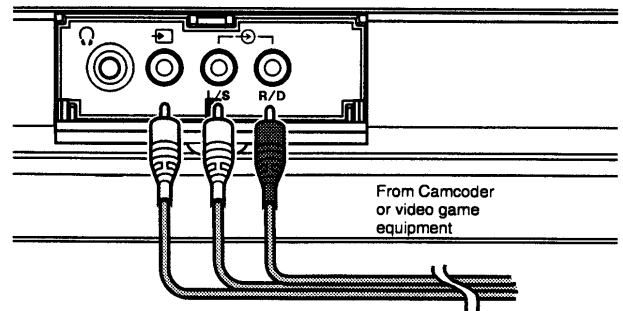

● Headphone

The 3.5mm mini-stereo jack socket located behind the door of the TV can be used for headphone.

When the headphone are inserted the sound from the TV speakers are muted.

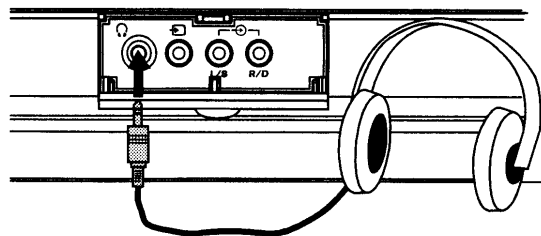

Active 3D surround

This TV provides a 3D surround processor which can create a 3 dimensional sound effect when receiving a standard stereo signal or monaural signal.

You can choose the following 3D surround mode by pressing **SURROUND** button repeatedly.

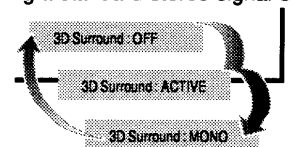

ACTIVE: Normal 3D surround sound, set to give the optimum 3D surround effect.

MONO: This mode is specially prepared for Nicam-mono broadcasting. Select this mode, when you can not get the 3D surround mode effects even if the status is Nicam stereo. You may feel 3D surround effect.

OFF: To cut off 3D surround effect.

■ Guidance for the best enjoyment of active 3D surround

Optimum positioning

Sit at a distance of approximately 2 to 4 meters from the TV set.

Listen facing the centre of the TV set.

Remove any obstructions between you and the TV set.

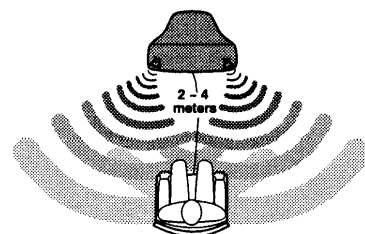

TELETEXT / VCR / DVD USE

Sub page access

To enter the sub-page access mode, see below.

Direct access to subject headings

Coloured boxes are displayed at the bottom of the screen. The 4 coloured buttons give access to the corresponding subjects or pages.

Index page selector

To select one of the teletext index pages.

Cancel

To view the TV picture in the teletext mode.

Stop

To stop sub pages changing. The word "STOP" will appear instead of the page number.

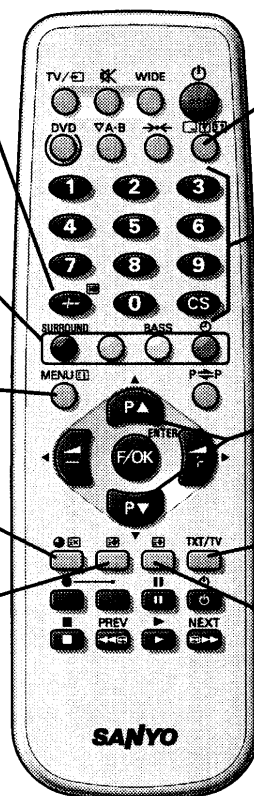

Reveal switch

To reveal hidden items on the text page.

Direct access to a page

To select a page number directly using (0-9) numeric button. eg. To select page 301, press 3 then 0 and then 1.

Up/down page access

To select the next or previous page number.

Teletext/TV selector

To switch TV, MIX and Teletext mode.

Size switch

Either the top half or the bottom half of the page can be expanded to fill the whole screen.

Picture & Sound in teletext mode

Picture and Text brightness controls in the teletext mode.

You can not adjust the picture or teletext brightness in the teletext mode. You must first switch back to the TV mode and then adjust the picture control or set the teletext brightness level.

How to set the teletext brightness level

1. Press the **F/OK** button repeatedly in the TV mode until the word "TEXT BRIGHT" appears on the screen.
2. Press the **▲ + / ▼ -** button to select one of the 3 teletext brightness levels either **MAXIMUM**, **CENTRE** or **MINIMUM**.
3. Confirm the selected teletext brightness level by switching to the teletext mode by pressing the **TXT/TV** button.

● Sound volume control

Only sound volume and muting can be controlled in the teletext mode but the on-screen display will not appear.

When the teletext service is not transmitting with the TOP or FLOF, 4 coloured page numbers will appear at the bottom of the screen instead of the topics.

Sub Page Access

With a text page selected which has sub pages, you may wish to read a known sub page number.

1. Press the **☐** button. "Sub code——" will be displayed on top of the screen.
2. Enter the sub page number by using the (0-9) numeric, **P▲** or **P▼** buttons.
3. Press the **☐** button to view the TV picture. The flashing page number appears on the TV picture. When the entered sub page is reached, it will stop flashing.
4. Press the **TXT/TV** button to view the sub-coded page.

Updated Pages

Some pages are updated as events progress, such as latest sports results, or traffic news. Select a latest page.

1. Press the **☐** button to view the TV picture. When the page is updated the page number will stop flashing.
 2. Press the **TXT/TV** button to view the updated page.
- ☞ If the page has sub pages the number will appear when the sub page is changed.

Press the **TXT/TV** button to return to normal TV picture.

Teletext reception

If your aerial signal is poor, the teletext reception may be poor.

VCR / DVD Use

■ VCR / DVD controls

This remote control transmitter has been designed to be used in conjunction with selected SANYO VCR's and DVD players. Some SANYO VCR's and DVD players may have their own functions, so please refer to the individual instruction booklet when using this remote control to ensure compatibility.

Some of the keys are used for both the VCR and DVD player. The symbols indicated with blue are for the keys to control the DVD player. When you use the DVD player with this remote control, first press and hold the **DVD** button and then press your desired control button each time.

	VCR	DVD
	Power	Power
	Play	Play
	Pause	Pause
	Stop	Stop
	Fast/Cue	Next chapter selection
	Rewind/Review	Previous chapter selection
	Record, press both buttons at the same time.	
DVD	n/a	DVD command mode selection
OK	n/a	Enter
	n/a	Cursor selection

OTHER FUNCTIONS / WARRANTY TO CUSTOMER

Fine tuning

1. Press the **MENU** to display the main menu. Use the **P▲** or **P▼** to highlight the **Preset** menu and press the **◀ +** button.

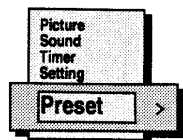

2. Select **Fine tuning** menu using **P▲** or **P▼** button and adjust fine tuning using **◀ +** or **▶ -** buttons.

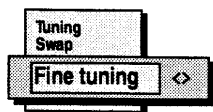

Press **MENU** button twice to exit from the menu.

☞ The Preset menu does not appear in the AV mode.

Child Lock

This TV has a child lock function which inhibits the use of the buttons on the front of the TV set. With this you can prevent small children unexpectedly pressing buttons.

1. Press **MENU** button to display the main menu. Use the **P▲** or **P▼** button to highlight the **Setting** menu. Press **◀ +** button.

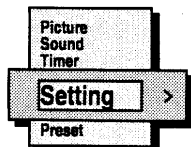

2. Use **P▲** or **P▼** button to highlight the **Child lock** menu. Select "ON" or "OFF" by pressing **◀ +** or **▶ -** button.

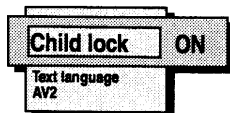

Press **MENU** button twice to exit from the menu.

The child lock mode will be reset to "OFF" when turning off the TV set with **Mains ON/OFF** Ⓞ switch.

Special Functions

This TV set allows you to set up the following special functions.

■ **Maximum volume setting and prohibition of presetting.**
Sets the current volume as the maximum volume level and prohibition of the tuning.

PROHIBITION OFF or PROHIBITION ON

■ **Start up programme position**

Presets the programme position when the set is switched on.

START POSITION OFF → Last programme position start
 START POSITION P1 → Programme position "1" start
You can use the same procedure for P1, P2, P3 etc. to P8.
 START POSITION P8 → Programme position "8" start
 START POSITION AV → "AV1" start

SETTING PROCEDURE

1. Press and hold the **□.TV.E?** button on the **Remote control handset** and then press the **P▲** button on the **TV set**.
2. Use **P▲** or **P▼** button to highlight the desired option item from the menu, and select the mode by pressing **◀ +** or **▶ -** button.
3. Press **□.TV.E?** button to exit from the menu.



☞ These options become effective after the TV is next switched on.

Sanyo U.K. Sales Ltd. (the company) warrants to the initial retail purchaser that if this equipment is or becomes defective and that, in the opinion of the Company, the defect is due to faulty material or workmanship the Company will, for a period of 12 calendar months from the date of sale to the original purchaser repair or replace, at its sole option, free of charge, any such defective component part of the equipment, always provided that:-

- 1: The equipment has at all times been used in accordance with the operating instructions issued by the Company, and has not been connected to an electrical mains supply for which it has not been adjusted.
- 2: Accidental damage or damage caused by negligence of misuse by the user, is specifically excluded.
- 3: Unauthorised repairs, or any modification to the equipment which has not been expressly approved by the Company, shall render this warranty null and void.
- 4: Failure due to fair wear and tear of any item is specifically excluded.

This warranty is not transferable and is only applicable within the United Kingdom (and the Republic of Ireland). Nothing in this express warranty affects the statutory rights available to the purchaser of this equipment.

Note: This warranty supersedes any other form of guarantee that may inadvertently have been enclosed with or attached to the product.

Dear Customer.

Thank you for buying **SANYO**. This equipment should give you many years of pleasure and faithful service but in the event that a fault occurs, the following notes for you guidance may be helpful:-

- 1: PLEASE RETAIN YOUR PURCHASE RECEIPT WHICH WILL BE REQUIRED FOR SERVICE DURING WARRANTY.
- 2: If your Sanyo equipment proves faulty during the period of guarantee, take it or send it back to the dealer who originally supplied it together with this guarantee and the proof of purchase. We have made arrangements with our approved dealers under which they will carry out inguarantee service repairs on our behalf. In this way, we hope to reduce to a minimum the amount of time you will be without your equipment.
- 3: If for some reason it is impossible to return the equipment to the original supplier, please contact our Service Department at the address below for further advice.
- 4: Should the equipment require servicing after the expiry of the guarantee period, take or send it to the original supplier or any other Sanyo dealer. He will be pleased to give you a quotation for the repair.

Service Department,
 Sanyo UK Sales,
 (A Division of SANYO Europe Ltd.), Sanyo House,
 Otterspool Way,
 Watford, Hertfordshire, WD2 8JX.
 Tel: 01923 246363