

SANYO

CE22LD94DV-B

INSTRUCTION MANUAL

Colour television

ENGLISH
1 - 58

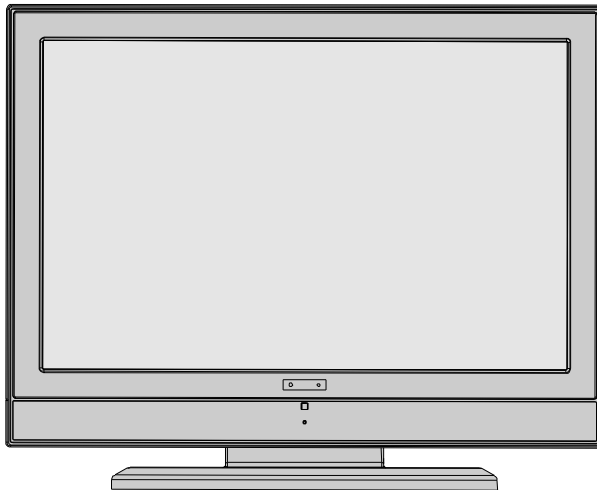

**Please read this Instruction book before using your television.
We wish you many hours of pleasure from your new television.**

Problems with set-up?

Call 0870 240 7475

Contents

Features	3	IDTV Menu System	21
Accessories	3	Channel List	21
Introduction	4	Navigating the Entire Channel List	22
Preparation	4	Deleting the Channels in the Channel List ...	22
Safety Precautions	4	Renaming Channels	22
Power Source	4	Adding Locks to Channels	22
Power Cord	4	Setting Favourites	23
Moisture and Water	4	On Screen Help	23
Cleaning	5	Installation	23
Ventilation	5	Add New Channels	24
Heat and Flames	5	Automatic Search	24
Lightning	5	Manual Search	24
Replacement Parts	5	Configuration	25
Servicing	5	Audio Language	25
Waste Disposal	5	Subtitle	25
Disconnecting the Device	5	Favourite Mode	25
Headphone Volume	5	EPG Preference	25
Installation	5	Receiver Upgrade	26
LCD Screen	5	Automatic Download (Automatic	
Warning	5	Upgrade)	26
Overview of the Remote Control	6	Search for New Version (Manual	
LCD TV and Operating Buttons	7	Upgrade)	26
Viewing the Connections	8	Parental Settings	26
Power Connection	10	Timers	27
Aerial Connection	10	Language	28
Connecting the LCD TV to a PC	11	TV Setup	28
Connecting to a DVD Player	12	Common Interface	28
Using Other Connectors	13	Navigating the Analogue TV Menu System	29
Connecting Other Equipment via Scart	14	Analogue TV Menu Map	30
Inserting Batteries in the Remote Control		Analogue TV Menu System	31
Handset	15	Sound Menu	31
Operating Range for the Remote Control	15	Volume	31
Switching the TV On/Off	16	Balance	31
To Switch the TV On	16	Sound Mode	31
To Switch the TV Off	16	Effect	31
Input Selection	16	Equalizer	31
Basic Operations	17	HP Volume	31
Operation with the Buttons on the TV	17	Store	31
Volume Setting	17	Picture Menu	31
Programme Selection	17	Picture Mode	31
Entering Main Menu	17	Brightness/Contrast/Colour/	31
AV Mode	17	Sharpness/Tint	31
Operation with the Remote Control	17	Colour Temp	32
Volume Setting	17	Picture Zoom	32
Programme Selection (Previous or Next		Store	32
Programme)	17	Features Menu	32
Programme Selection (Direct Access)	17	Sleep Timer	32
Initial Settings	18	Language	32
General Operation	18	Child Lock	32
Information Banner	18	Menu Colour	32
Electronic Programme Guide (EPG)	19	Favourite Mode	32
Displaying the Subtitles	20	Install Menu	32
Digital Teletext	20	Programming	32
Over Air Download	21	Programme	33
Widescreen	21	Band	33

Channel	33
Standard	33
Colour System	33
Search	33
VCR Mode	33
Decoder	33
Store	33
A.P.S.	33
A.P.S. Country	33
Teletext Region	34
Install menu in AV modes	34
Programming	34
Colour System	34
Program Table	34
Name	34
Move	35
Delete	35
APS (Auto Programming System)	35
Favourite Mode	35
Program Lock	35
Enter PIN	35
Change PIN	35
PC Mode Menu System	36
Sound Menu	36
Feature Menu	36
PC Picture Menu	36
Geometry Menu	36
H. (Horizontal) Position	36
V. (Vertical) Position	36
Clock	36
Phase	36
Auto Adjustment	36
Displaying TV Information	37
Mute Function	37
Personal Preference	37
Zoom Modes	37
Auto	37
4:3	37
16:9	37
Cinema	37
Subtitle	37
Teletext	38
Tips	39
Screen Care	39
Image Persistence	39
No Power	39
Poor Picture	39
No Picture	39
Sound	39
Remote Control	39
Input Sources	39
CI Module	39

Appendix A: PC Input Typical Display Modes	40
Specifications	41
Pin Specifications	42
Important Instruction	43

Features

- Remote controlled colour television.
- Fully integrated digital TV (DVB-T).
- 100 programmes from VHF, UHF bands or cable channels can be preset.
- It can tune cable channels.
- Controlling the TV is very easy by its menu driven system.
- A scart socket for external devices (e.g. video games, audio set, etc.).
- Stereo sound system (German+Nicam).
- Full function teletext .
- Fastext (10 pages), top text.
- Favourite channel.
- Channel lock.
- Headphone connection.
- A.P.S. (Automatic Programming System).
- All programmes can be named.
- Forward or backward automatic tuning.
- Sleep timer.
- Child lock.
- Automatic sound mute when no transmission.
- NTSC playback.
- AV in is available.
- It has one HDMI connectors for digital video and audio. This connection is also designed to accept high definition signals.
- When no valid signal is detected, after 5 minutes the TV switches itself automatically to standby mode.
- PLL (frequency search).
- PC input.
- Plug & Play for Windows 9X, ME, 2000, XP, Vista.

Accessories



Remote Controller

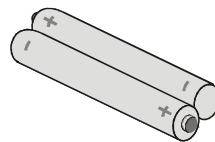

Batteries

2 XAAA

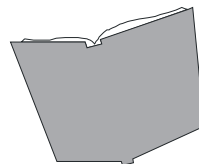

Instruction Book

Introduction



Thank you for choosing this product. This manual will guide you for the proper operation of your TV. Before operating the TV, please read this manual thoroughly.

Please do keep this manual in a safe place for future references.

Preparation

For ventilation, leave a free space of at least 10 cm all around the set. To prevent any fault and unsafe situations, please do not place any objects on top of the set.

Use this device in moderate climates.

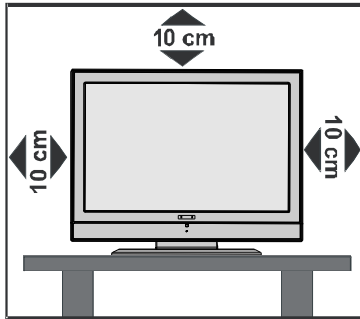

Safety Precautions

Please read the following recommended safety precautions carefully for your safety.

Power Source

The TV set should be operated only from a 220-240 V AC, 50 Hz outlet. Ensure that you select the correct voltage setting for your convenience.

Power Cord

Do not place the set, a piece of furniture, etc. on the power cord (mains lead) or pinch the cord. Handle the power cord by the plug. Do not unplug the appliance by pulling from the power cord and never touch the power cord with wet hands as this could cause a short circuit or electric shock. Never make a knot in the cord or tie it with other cords. The power cords should be placed in such a way that they are not likely to be stepped on. A damaged power cord can cause fire or give you an electric shock. When it is damaged and needs to be replaced, it should be done by qualified personnel.

Moisture and Water

Do not use this device in a humid and damp place (avoid the bathroom, the sink in the kitchen, and near the washing machine). Do not expose

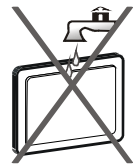

this device to rain or water, as this may be dangerous and do not place objects filled with liquids, such as flower vases, on top. Avoid from dripping or splashing.

If any solid object or liquid falls into the cabinet, unplug the TV and have it checked by qualified personnel before operating it any further.

Cleaning

Before cleaning, unplug the TV set from the wall outlet. Do not use liquid or aerosol cleaners. Use soft and dry cloth.

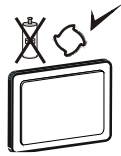

Ventilation

The slots and openings on the TV set are intended for ventilation and to ensure reliable operation. To prevent overheating, these openings must not be blocked or covered in anyway.

Heat and Flames

The set should not be placed near to open flames and sources of intense heat such as an electric heater. Ensure that no open flame sources, such as lighted candles, are placed on top of the TV. Batteries should not be exposed to excessive heat such as sunshine, fire or the like.



Lightning

In case of storm and lightning or when going on holiday, disconnect the power cord from the wall outlet.



Replacement Parts

When replacement parts are required, make sure that the service technician has used replacement parts, which are specified by the manufacturer or have the same specifications as the original one. Unauthorized substitutions may result in fire, electrical shock or other hazards.

Servicing

Please refer all servicing to qualified personnel. Do not remove the cover yourself as this may result in an electric shock.



Waste Disposal

Instructions for waste disposal:

- Packaging and packaging aids are recyclable and should principally be recycled. Packaging materials, such as foil bag, must be kept away from children.
- Batteries, including those which are heavy metal-free, should not be disposed of with household waste. Please dispose of used battery in an environment friendly manner. Find out about the legal regulations which apply in your area.
- Cold cathode fluorescent lamp in LCD PANEL contains a small amount of mercury; please follow the local laws or regulations for disposal.

Disconnecting the Device

The mains plug is used to disconnect TV set from the mains and therefore it must remain readily operable.

Headphone Volume

Excessive sound pressure from earphones and headphones can cause hearing loss.



Installation

To prevent injury, this device must be securely attached to the wall in accordance with the installation instructions when mounted to the wall (if the option is available).

LCD Screen

The LCD panel is a very high technology product with about a million thin film transistors, giving you fine picture details. Occasionally, a few non-active pixels may appear on the screen as a fixed blue, green or red point. Please note that this does not affect the performance of your product.

Warning

Do not leave your TV in standby or operating mode when you leave your house.

Overview of the Remote Control

- ① Standby
- ② **Switch to TV**
- ③ Mono-Stereo/Dual I-II
- ④ Direct programme
- ⑤ Double digit
- ⑥ Cursor up
- ⑦ Cursor left
- ⑧ Programme up
- ⑨ Programme down
- ⑩ Previous programme
- ⑪ External source
- ⑫ Time/Sub-page/Subtitle on-off
- ⑬ Teletext
- ⑭ Expand/Image size
- ⑮ Reveal / Switch to PC
- ⑯ Index page/Electronic Programme Guide (EPG)
- ⑰ Mix
- ⑱ Update
- ⑲ Hold
- ⑳ Personal preference
- ㉑ Tv button(Exit Menu or Teletext)
- ㉒ Volume down
- ㉓ Volume up
- ㉔ Cursor down
- ㉕ Cursor right
- ㉖ Okay
- ㉗ Install
- ㉘ Menu
- ㉙ Feature
- ㉚ Picture/Page down
- ㉛ Sound/Page up
- ㉜ **Switch to DVD mode**
- ㉝ **Switch to DTV mode**
- ㉞ Mute
- ㉟ Info/Programme Table

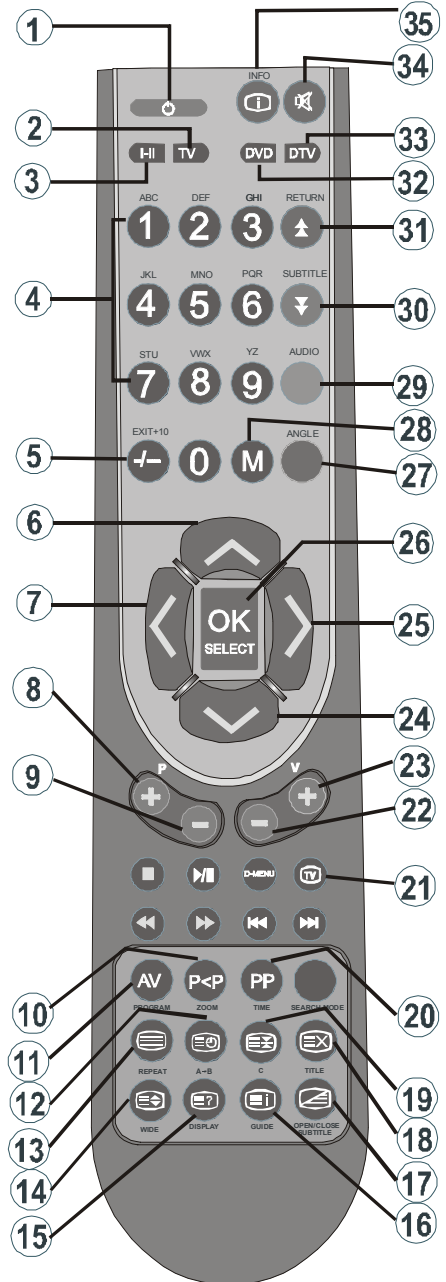

LCD TV and Operating Buttons

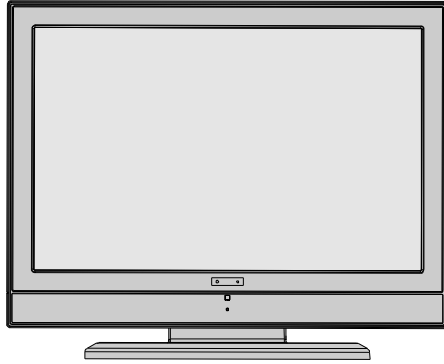

FRONT VIEW

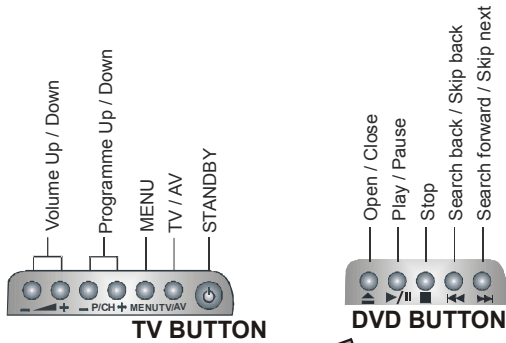

TV BUTTON

DVD BUTTON

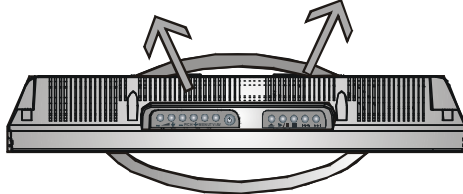

TOP VIEW

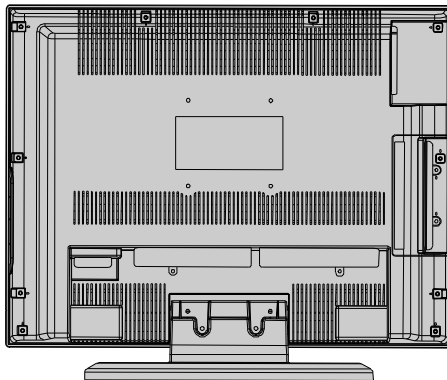

REAR VIEW

Viewing the Connections

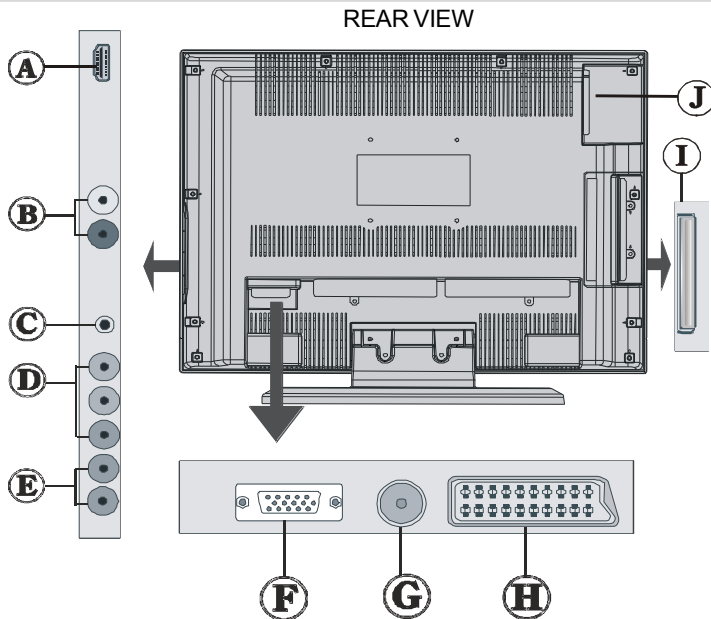

A **HDMI Input** are for connecting a device that has an **HDMI** socket.

Your LCD Television is capable of displaying High Definition pictures from devices such as a High Definition Satellite Receiver or DVD Player. These devices must be connected via the HDMI sockets or Component Socket. These sockets can accept either 720p or 1080i signals. No sound connection is needed for an HDMI to HDMI connection. If you use HDMI to DVI cable, use PC audio inputs to enable sound connection.

B **Audio Line Outs** output audio signals to an external device such as an optional sound system.

To connect the external speakers to your TV, use **AUDIO LINE OUTS** of the TV with an audio cable.

C **Headphone** jack is used for connecting an external headphone to the system. Connect to the **HEADPHONE** jack to listen to the TV from headphones (optional).

D **Component Video Inputs (YPbPr)** are used for connecting component video.

You can connect the component video and audio sockets with a device that has component output. Connect the component video cables between the **COMPONENT VIDEO INPUTS** on the TV and the component video outputs of your device. While connecting, be sure that the letters on your TV, “Y”, “Pb”, “Pr” correspond with your device’s connectors.

Note that “Y” input also functions as **CVBS Video In** jack. This means that you can connect devices such as a camcorder to your TV by using **CVBS Video In** jack. Connect the video cable between the **CVBS Video In** socket on the TV and the **VIDEO OUT** jack on your device to make such a connection.

ⓔ **PC/YPbPr Audio Inputs** are used for connecting audio signals of a PC or a device that connects to the TV via YPbPr sockets.

*Connect the PC audio cable between the **AUDIO INPUTS** on the TV and audio output of your PC to enable PC audio.*

*Connect the audio cable between **AUDIO INPUTS** on the TV and audio outputs of your device to enable component audio.*

ⓕ **PC Input** is for connecting a personal computer to the TV set.

Connect the PC cable between the **PC INPUT** on the TV and the PC output on your PC. If you want to connect a device that has YPbPr, please use YPbPr to PC cable.

ⓐ **RF Input** connects to an antenna or a cable.

Note that if you use a decoder or a media recorder, you should connect the aerial cable through the device to the television with an appropriate antenna cable, as shown in the illustration below.

ⓑ **SCART** inputs or outputs for external devices.

Connect the **SCART** cable between **SCART** sockets on TV and **SCART** socket on your external device (such as a decoder, a VCR or a DVD player).

Note: *If an external device is connected via the **SCART** sockets, the TV will automatically switch to AV mode.*

ⓓ **CI Slot** is used for inserting a CI card. A CI card allows you to view all the channels that you subscribe to. For more information, see “Common Interface” section.

ⓙ **Disc Loader**

Power Connection

IMPORTANT: The TV set is designed to operate on **220-240V AC, 50 Hz.**

- After unpacking, allow the TV set to reach the ambient room temperature before you connect the set to the mains.
- Plug the power cable to the mains socket outlet.

Aerial Connection

- Connect the aerial or cable TV plug to the **RF INPUT** socket located at the rear of the TV.

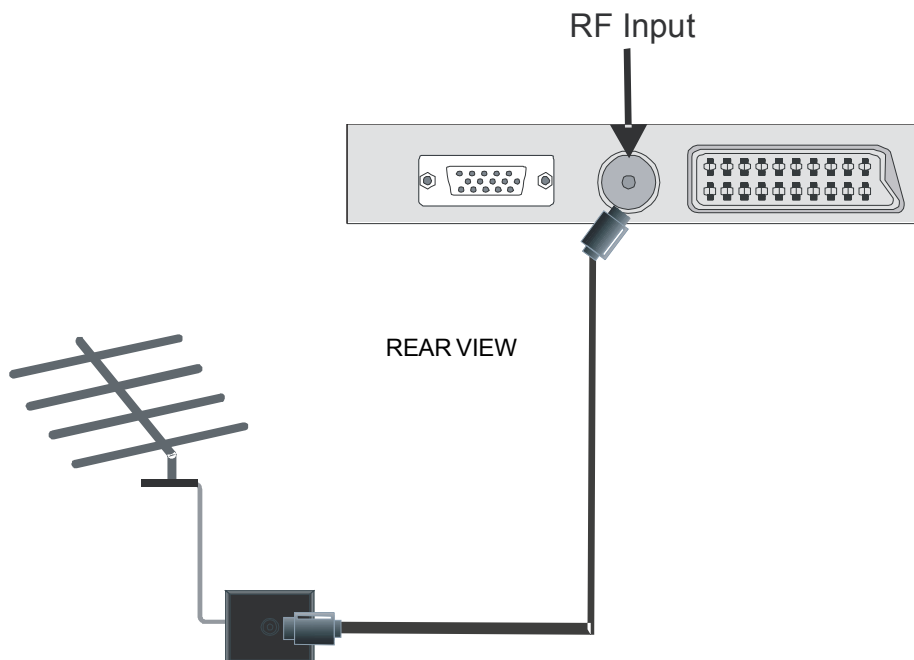

Connecting the LCD TV to a PC

For displaying your computer's screen image on your LCD TV, you can connect your computer to the TV set.

- Power off both computer and display before making any connections.
- Use 15-pin D-sub display cable to connect a PC to the LCD TV.
- When done, switch to PC source. See, “**Input selection**” section.
- Set the resolution that suits your viewing requirements.

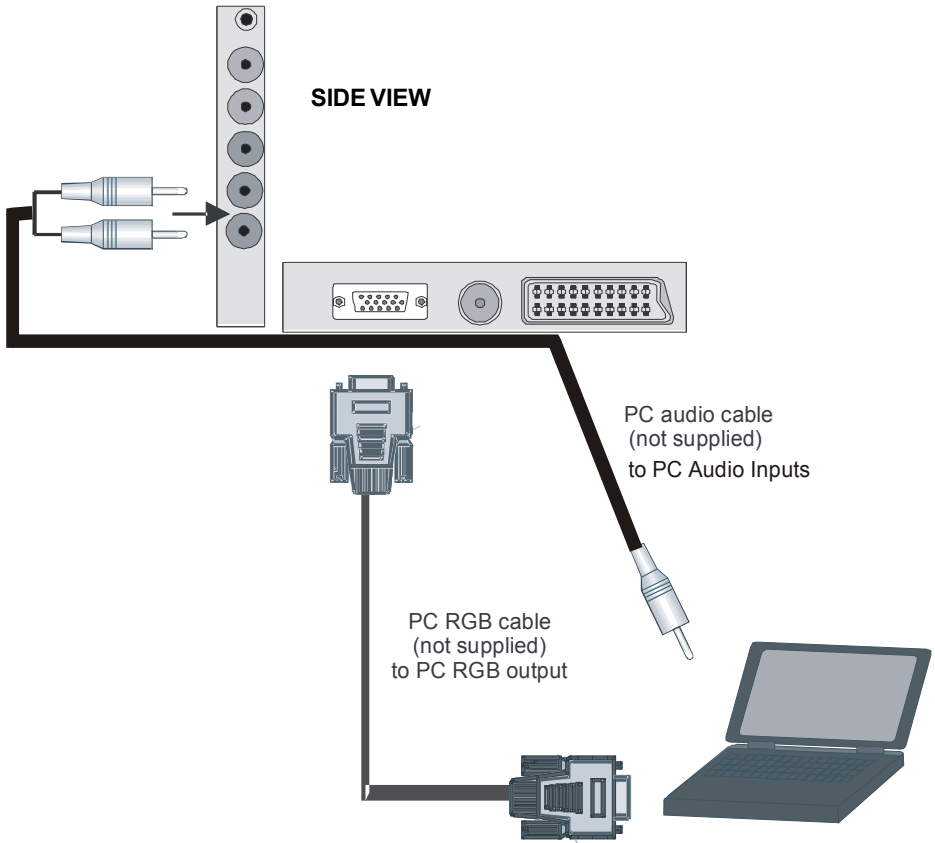

Connecting to a DVD Player

If you want to connect a DVD player to your LCD TV, you can use connectors of the TV set. DVD players may have different connectors. Please refer to your DVD player's instruction book for additional information. Power off both the TV and the device before making any connections.

Note: Cables shown in the illustration are not supplied.

- If your DVD player has an **HDMI** socket, you can connect via **HDMI**. When you connect to DVD player as illustrated below, switch to HDMI source. See, "**Input selection**" section.
- Most DVD players are connected through **RCA SOCKETS**. Use a RCA video cable to connect video input. For enabling audio, use a component audio cable as illustrated below. When done, switch to **F-AV** source. See, "**Input selection**" section.
- You may also connect through the **SCART**. Use a **SCART** cable as shown below.

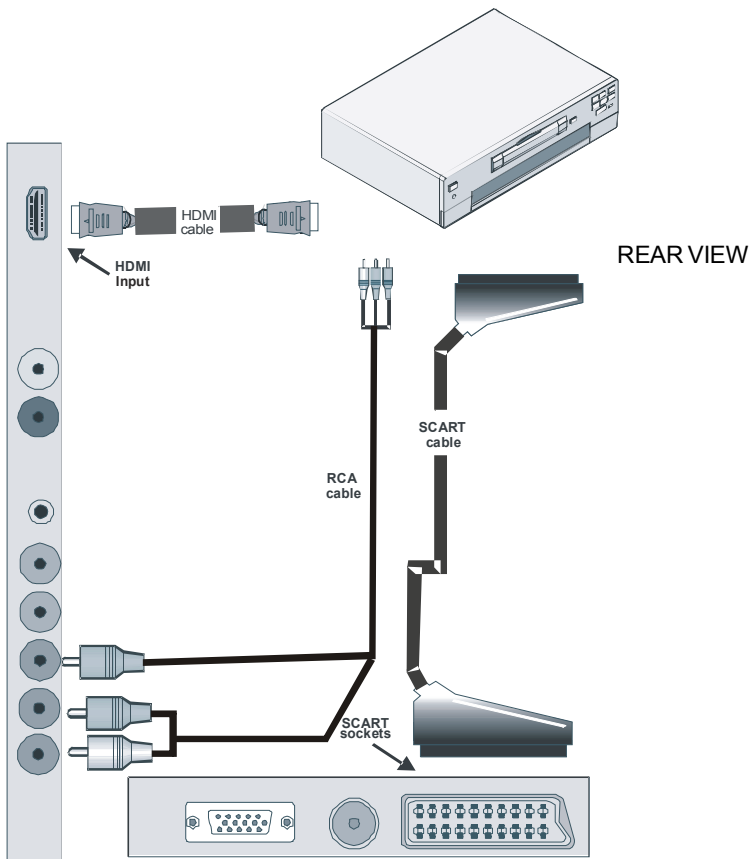

Note: These three methods of connection perform the same function but in different levels of quality. It is not necessary to connect by all three methods.

Using Other Connectors

You can connect a range of optional equipment to your LCD TV. Possible connections are shown below. *Note that cables shown in the illustration are not supplied.*

- To connect external speakers, use an audio cable. Do not reverse the **AUDIO LEFT** and **AUDIO RIGHT** jacks. Turn on the LCD TV and external speaker set after all connections are made. Refer to your speaker set's manual for further queries.
- To listen the sound from headphones, connect to the **HEADPHONE** jack of the TV.

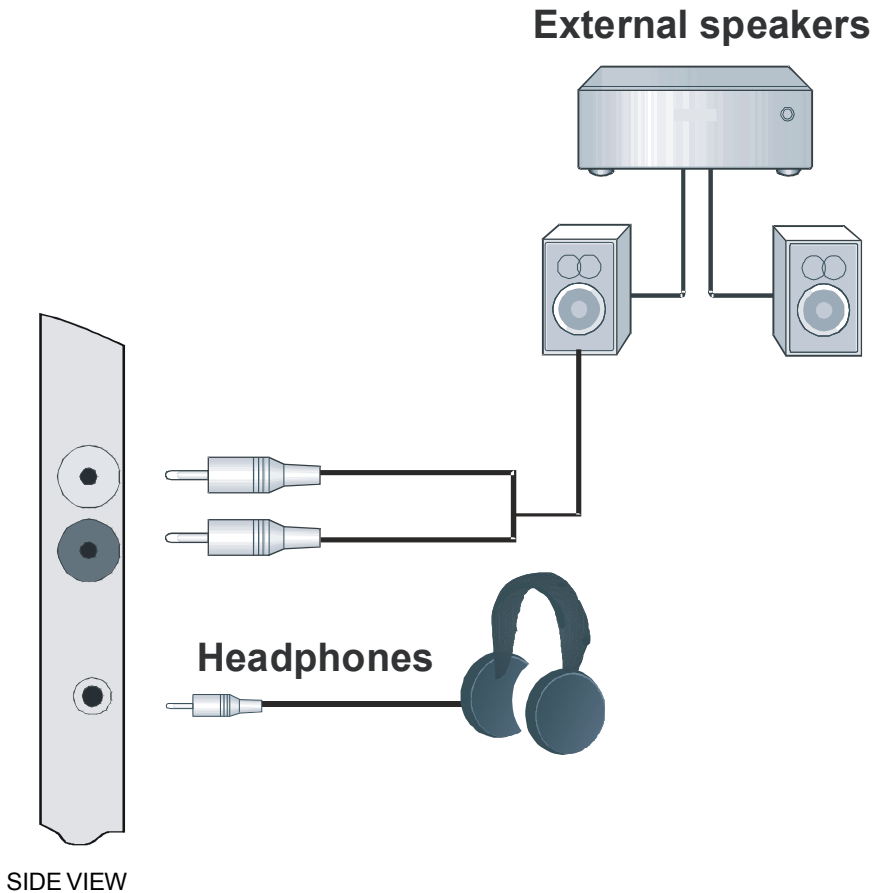

Connecting Other Equipment via Scart

Most devices support **SCART** connection. You can connect a; DVD recorder, a VCR or a decoder to your LCD TV by using the **SCART** sockets. *Note that cables shown in the illustration are not supplied.*

- Power off both the TV and the devices before making any connections.
- For more information, refer to your device's own instruction book.

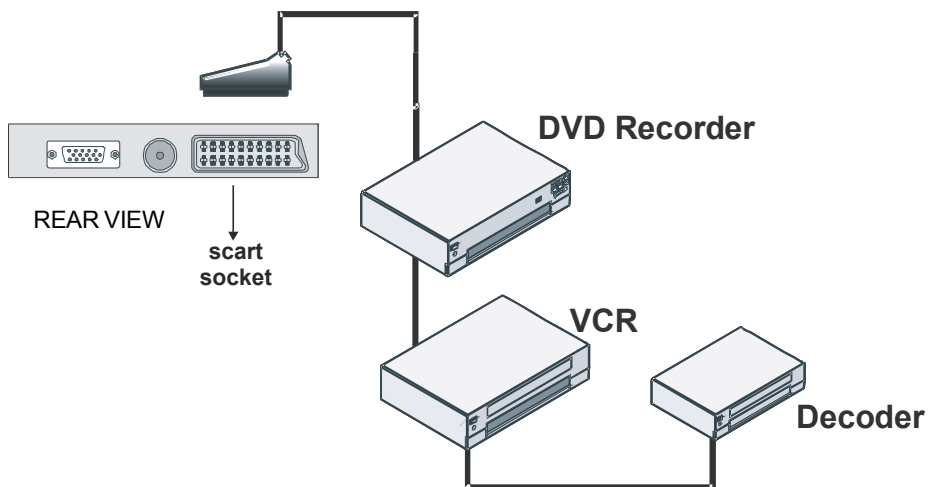

Inserting Batteries in the Remote Control Handset

- Remove the battery cover located on the back of the handset by gently pulling backwards from the indicated part.
- Insert two **AAA/R3** or equivalent type batteries inside. Place the batteries in the right directions and replace the battery cover.

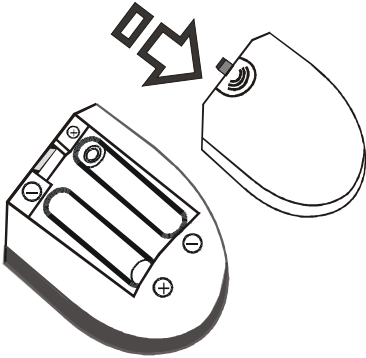

Note: Remove the batteries from the remote control when it is not going to be used for a long time. Otherwise the batteries may leak and damage the controller.

Operating Range for the Remote Control

- Point the top of the remote control toward the LCD TV's remote sensor LED while pressing a button.

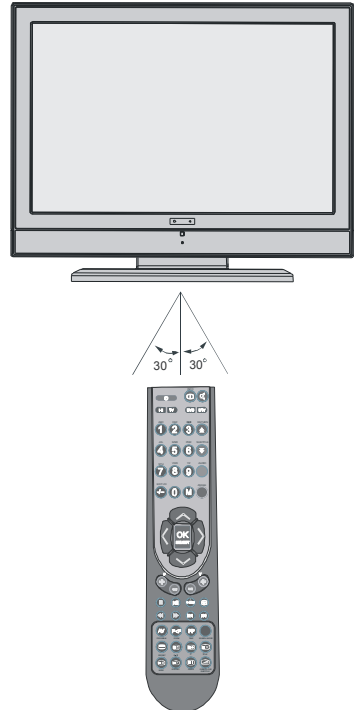

Remote range is approximately 7m/23ft.

Switching the TV On/Off

To Switch the TV On

- Connect the power cord to the 220-240V AC,50Hz.
- Press **STANDBY** button. Then the standby LED lights up.
- To switch on the TV from standby mode either:
 - Press the **⏻** button, **P/CH+ / P/CH-** or a numeric button on the remote control.
 - Press the **P/CH-** or **P/CH+** button on the TV. The TV will then switch on.

Note: *If you switch on your TV via PROGRAMME UP/DOWN buttons on the remote control or on the TV set, the programme that you were watching last will be reselected.*

To Switch the TV Off

- Press the **⏻** button on the remote control or **STANDBY** button on the TV, so the TV will switch to standby mode.
- To power down the TV completely, unplug the power cord from the mains socket.

Input Selection

Once you have connected external systems to your TV, you can switch to different input sources.

- Press the **AV** button on your remote control until the desired source is highlighted. The TV will then switch to the selected source after a short while.



- Depending on your selection of working mode, the remote control buttons' functions will change accordingly. (Except DVD and DTV).

To use DVD operation, push the DVD button.

To use DTV operation, push the DTV button.

Basic Operations

You can operate your TV using both the remote control and onset buttons.

Operation with the Buttons on the TV

Volume Setting

- Press **▲** - button to decrease volume or **▲ +** button to increase volume, so a volume level scale (slider) will be displayed on the screen.

Programme Selection

- Press **P/CH +** button to select the next programme or **P/CH -** button to select the previous programme.

Entering Main Menu

- Press the **MENU** button to enter main menu. In the Main menu select sub-menu using **P/CH -** or **P/CH +** buttons and enter the sub-menu using **▲** - or **▲ +** buttons. To learn the usage of the menus, refer to the menu system sections.

AV Mode

- Press the **TV/AV** button at the control panel on the the TV to switch your TV to AV modes.

Operation with the Remote Control

- The remote control of your TV is designed to control all the functions of the model you selected. The functions will be described in accordance with the menu system of your TV.
- Functions of the menu system are described in the following sections.

Volume Setting

Press **V +** button to increase the volume. Press **V -** button to decrease the volume. A volume level scale (slider) will be displayed on the screen.

Programme Selection (Previous or Next Programme)

- Press **P -** button to select the previous programme.
- Press **P +** button to select the next programme.

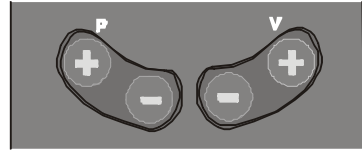

Programme Selection (Direct Access)

- Press numeric buttons on the remote control to select programmes between 0 and 9. The TV will switch to the selected programme. To select programmes between 10-99, first press the **-/--** button; then numeric buttons consecutively (e.g. for programme 27, first press 2 and then 7). When the pressing time is due for the second numeric button, only the first digit programme will be displayed. The limit of the delay time is 3 seconds.
- Press directly the programme number to reselect single digit programmes.

Initial Settings

When the TV set is operated for the first time, the IDTV turns on first.

Because this is the first time the TV is used, there are no channels stored in the memory and the following message appears on the screen:

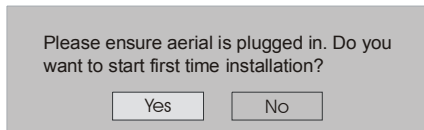

- To start installation process, select **“Yes”**, to cancel select **“No”**.
- To select the **“Yes”** or **“No”** option, highlight the item by using ◀ or ▶ buttons and press the **OK** button.

The IDTV will automatically tune to the UHF transmission channels 21 to 68, searching for digital terrestrial TV broadcasts and displaying the names of channels found. This process will take about five minutes. To cancel searching, you can press the **M** button at any time during the process.

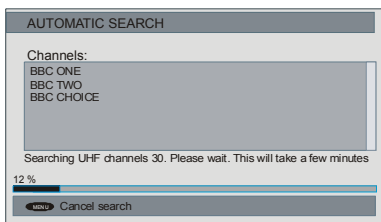

After **Automatic Search** is completed, the following message asking for analogue channel search appears on the screen:

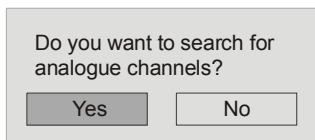

To search for analogue channels, select **“Yes”**. TV switches to the analogue TV mode. The menu below is displayed to search for analogue channels:

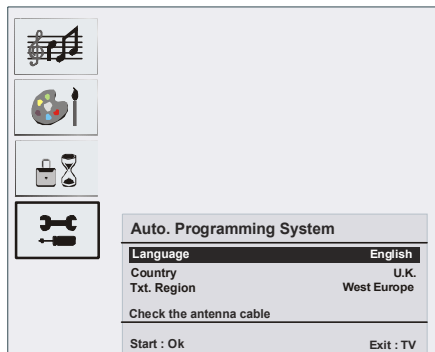

Set **Language** item by pressing ◀ or ▶ button. Press ▲ or ▼ button to highlight **Country** item and then use ◀ or ▶ to set. Press ▲ or ▼ button to highlight **Txt. Region**. Select a region by using ◀ or ▶ button. When finished, press **OK** button to continue. To cancel, press the **TV** button.

For more information on this process, see **“Install Menu”** section.

NOTE: For proper functioning of digital teletext in DTV mode, you should set **country** as UK in analogue APS.

General Operation

Pressing the TV or DTV button at any time while watching television programmes will switch the TV set between displaying the digital terrestrial television broadcasting and its normal analogue broadcasting.

Information Banner

• Whenever you change channel, using the **P-** / **P+** button or the numeric buttons, the TV displays the broadcast picture along with an information banner at the bottom of the screen. This will remain on the screen for approximately three seconds.

• The information banner can also be displayed at any time while watching TV by pressing the **i** button on the remote control:

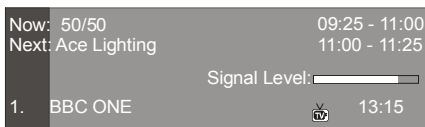

- The information banner gives information on the channel selected and the programmes on it. The name of the channel is displayed, along with its channel list number and an indication of the strength of the signal received.

Hint: *Not all channels broadcast the programme data. If the name and time of the programme are not available, then “No Information Available” will be displayed in the information banner.*

- Icons are also displayed in the information banner and if this channel is a favourite channel, favourite channel icon “” will also be displayed.

If the selected channel is locked, you must enter the correct four numeric code to view the channel. “**Enter Lock Key**” will be displayed on the screen in such a case:

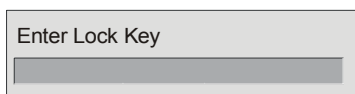

Electronic Programme Guide (EPG)

- Some, but not all, channels send information about the current and next events.
- Please note that event information is updated automatically. If there is no event information data available in channels, only channel names with “**No Information Available**” banner is displayed.
- Press **GUIDE** button to view the **EPG** menu.
- In EPG menu, you can easily see the extended help information by pressing  button.
- Press this button again to close this window.
- In the EPG menu, all channels are displayed.

Current channel is highlighted. Use **▲** or **▼** buttons to change channels. Also press **GREEN/RED** buttons to scroll up/down the pages for the channels.



- If you highlight an event; short event description, extended event description, start and end times of the event will be displayed on the screen.
- When the current programme is highlighted, the box is switched to the highlighted channel by pressing the **OK** button.
- If you press the **OK** button when a next event is highlighted, a reminder is set for the highlighted programme and a clock appears across the highlighted channel line.

Programme reminders can be set to signal that a programme is about to start when you are watching another channel. If you set reminder for a programme, then you will be asked for switching to that channel when the reminder time is reached.

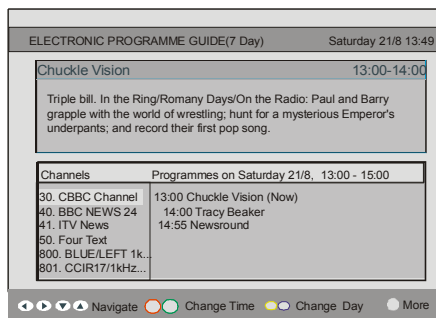
- Press the **M** button to view the 7 day EPG.
- Press **▲** or **▼** button to navigate in Channels or Programmes.
- Press **◀** or **▶** button to navigate through the channel and programme list.



- With **RED/GREEN** buttons, you can change the schedule time. By pressing **YELLOW/BLUE** you can advance the schedule backward/forward of a day.

- If you press  button you can see the detailed help information easily. Press  button again to exit help menu.
- The starting time for **EPG** is the current time. You can see the event information for the next two hours. By pressing **▲** or **▼** button, you can go to the next/previous hours while Programmes list is highlighted.
- If you press the **OK** button when a next event is highlighted, a reminder is set for the highlighted programme and a clock appears on the screen.
- Programme reminders can be set to signal that a programme is about to start when you are watching another channel. If you set reminder to a programme, then you will be asked for switching to that channel when the reminder time is due.

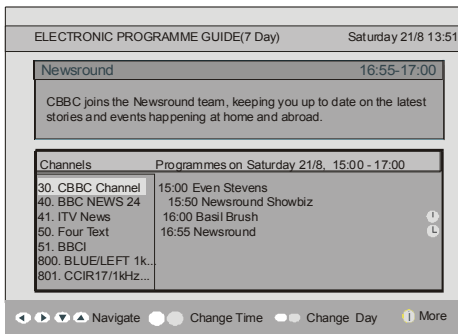

Displaying the Subtitles

With digital terrestrial broadcasting (DVB-T), some programmes are broadcast with subtitles. Subtitles can be displayed while watching these programmes.

Press the **M** button to display the main menu, highlight the **Configuration** line using **▲** or **▼** button and press the **OK** button to display the configuration menu.

Highlight the **“Subtitle”** item in configuration menu and use **◀** or **▶** button to set Subtitle to Off or a language.

If **“Subtitle”** is on and a language option is set, pressing the  button causes the following warning message display on the screen:

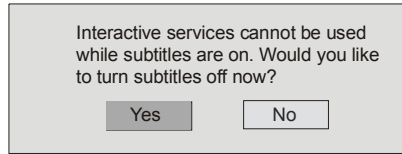

Digital Teletext



With digital terrestrial broadcasting (DVB-T), in addition to pictures and sound, you can also view digital teletext.

Digital teletext is sometimes broadcast at the same time with the normal broadcasting.

- Press the .
- The digital teletext information appears.
- Operate it with the coloured buttons, **◀/▶/▼/▲** buttons and **OK** button.

The operation method may differ depending on the contents of the digital teletext.

Follow the instructions displayed on digital teletext screen.

- When **“Press SELECT”** button or similar message appears on the screen, press the **OK** button.
- When the  (Text) button is pressed, the TV returns to television broadcasting.
- With digital terrestrial broadcasting (DVB-T), in addition to digital teletext broadcasting at the same time with the normal broadcasting, there are also channels with just digital teletext broadcasting.
- The aspect ratio when watching a channel with just digital teletext broadcasting is the same as the aspect ratio of the picture watched previously.
- When you press the  (Text) button again, the digital teletext screen will be displayed.

Over Air Download

To ensure that your IDTV always has the most up-to-date information, please ensure that, after use, it is set to standby mode. At 3 A.M. each day, the IDTV automatically searches for any new information which may be broadcast and will download this to your IDTV automatically. This operation will normally take approximately 30 seconds.

If you want to perform this, you need to set Automatic Download to “**Enabled**” in Receiver Upgrade setting.

Widescreen

Depending on the type of the broadcast being transmitted, programmes can be viewed in a number of formats. Press the **WIDE** button repeatedly to select between **Auto**, **4:3**, **16:9**, **Cinema** or **Subtitle**.

When **Auto** is selected, the format being displayed is determined by the picture being broadcast.

PLEASE NOTE: *Menu size changes depending on the chosen image size.*

IDTV Menu System

The IDTV menu can only be viewed when watching digital terrestrial broadcasting. Press the DTV button to turn IDTV on while the TV is in analogue mode.

Press the **M** button. The menu below appears on the screen:

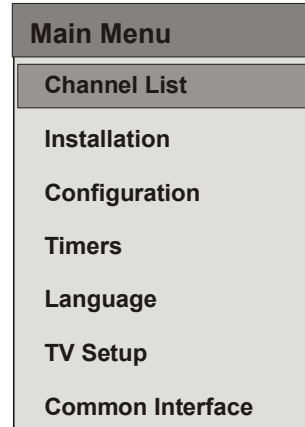

Channel List

Using the **▲** or **▼** button on the remote control, make sure that the first item, Channel List, is highlighted and press the **OK** button to display the **Channel List**.

The following operations can be performed in this menu:

- Navigating the entire list of channels
- Deleting channels
- Renaming channels
- Adding locks to channels
- Setting favourites

Channel List is the place where the channels are managed.

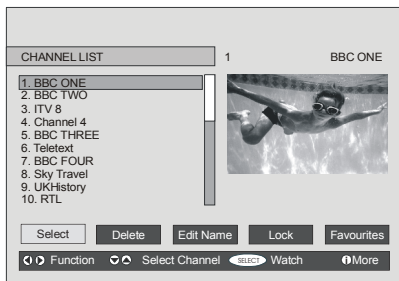

Navigating the Entire Channel List

Press **▲** or **▼** button for selecting the previous or next channel. You can press **RED** or **GREEN** button to move page up or page down.

To watch a specific channel, highlight it using **▲** or **▼** button and then press **OK** button, while the **“Select”** item on Channel List menu is highlighted by using **◀** or **▶** button.

Then the name and number of the selected channel will be displayed in the top-left and top-right of the channel display at the top-right of the screen, respectively.

Deleting the Channels in the Channel List

Press **▲** or **▼** button to select the channel that will be deleted.

Press **◀** or **▶** button to select the **“Delete”** item on Channel List menu. As seen on Channel List menu, **SELECT** is displayed next to **Delete** item at the bottom of the screen to indicate that you must press the **OK** button to delete the highlighted channel in the channel list.

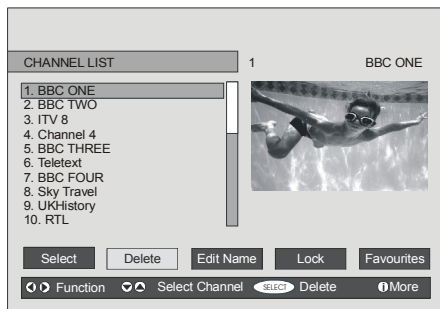

Press the **OK** button to delete the highlighted channel in the channel list. Then the message below appears on the screen:

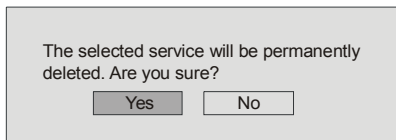

Press **◀** or **▶** button to highlight the desired option. If **OK** button is pressed while **“Yes”** is highlighted, the highlighted channel is deleted. Selecting **“No”** cancels the deletion.

Renaming Channels

To rename a specific channel, the channel must be highlighted by pressing **▲** or **▼** button. Then highlight the **Edit Name** item by pressing **◀** or **▶** button as illustrated below. Press the **OK** button to activate the rename feature.

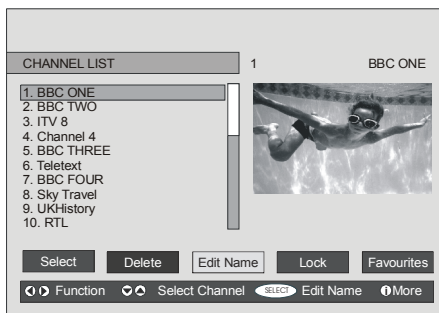

Now pressing **◀** or **▶** button moves to the previous/next character. Pressing **▲** or **▼** button toggles the current character, i.e., **‘b’** character becomes **‘a’** by **▼** and **‘c’** by **▲**. Pressing the numeric buttons **‘0...9’** replaces the highlighted character with the characters printed above the button one by one as the button is pressed.

Press the **M** button to cancel the editing or **OK** button to save the new name.

Adding Locks to Channels

Channel locking provides a password-

protected access to channels selected by parents. In order to lock a channel you should know the parental lock password (default value is set to 0000 in the factory and can only be changed from the **Configuration** menu).

Select the channel to be locked by highlighting it and select the **Lock** option by pressing ◀ or ▶ button. When the **OK** button is pressed, a dialog OSD asking for the password will be displayed.

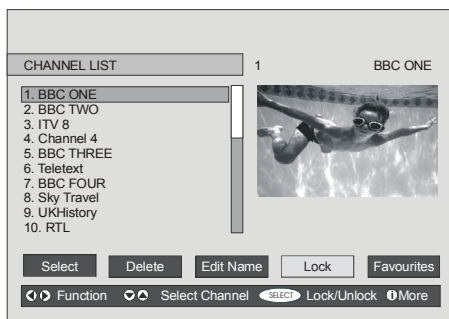

Enter Lock Key

Enter the password by using the numeric buttons on the remote control. The lock icon “” will now be displayed next to the selected channel. Repeat the same operation to cancel the lock.

Setting Favourites

You can set various channels as favourites so that only the favourite channels are navigated. To set a favourite you should highlight the **Favourites** item at the bottom of the Channel List menu.

Use the ◀ or ▶ button to highlight the “**Favourites**” item at the base of the screen and then, in turn, highlight each channel you want to add to the favourites list, using the ▲ and ▼ buttons (or red/green buttons), and press the **OK** button.

A channel selected as a favourite appears in the main channel list with a favourites icon (😊) against the channel name as illustrated below:

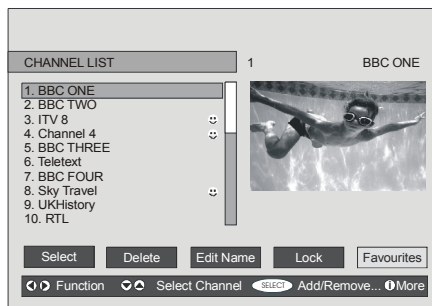

On Screen Help

For all menus, press the  button to display the help information about the menu functions. For **Channel List** menu the following message is displayed on the screen:

Press the SELECT button on your remote control to tune to the highlighted channel.
Press MENU to exit this screen.

Installation

The Installation menu is mainly intended to help you for creating a **Channel Table** in the most efficient way.

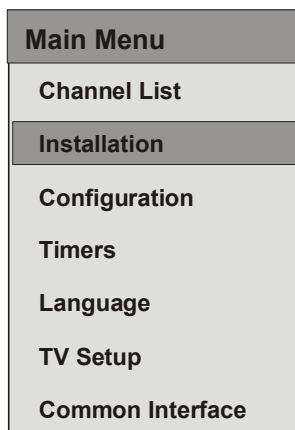

This menu includes the following items:

- Add New Channels.
- First Time Installation.

Add New Channels

This tuning menu consists of two parts:

- Automatic Search
- Manual Search

Installation	
Add New Channels	Automatic Search
First Time Installation	Manual Search

Automatic Search

Automatic search is started by pressing the **OK** button in the auto-search pop up menu. All the services will be searched and a channel table will be created automatically.

All channels found are stored in a sorted form with respect to their channel numbers. Some services may not appear with the correct channel number. If the broadcaster has no channel information, this may happen due to missing info.

Manual Search

In manual search, the number of the multiplex is entered manually and only that multiplex is searched for the channels. For every valid channel number, signal level, signal quality and network name are shown at the bottom of the screen.

In both manual and auto search, any existing channel in the database is not re-stored to avoid redundant duplicates of that channel.

First Time Installation

The user can use this item to load default settings, which were loaded to the receiver at the factory.

To install factory settings, highlight “**First Time Installation**” menu and press the **OK** button.

Installation
Add New Channels
First Time Installation

Then you will be asked to confirm for deleting all channels and settings:

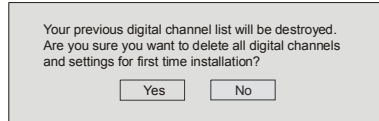

By selecting **Yes** and pressing the **OK** button, the existing channel table will be deleted.

After factory settings are loaded, “**First Time Installation**” menu will be displayed:

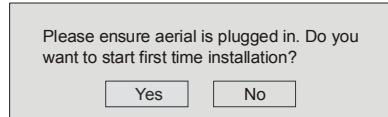

Press the **OK** button to start installation. After search is completed for digital channels, a message asking whether to search for analogue channels appears on the screen:

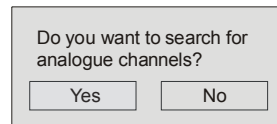

Press the **OK** button to search for analogue channels. The following menu appears on the screen for analogue channel search:

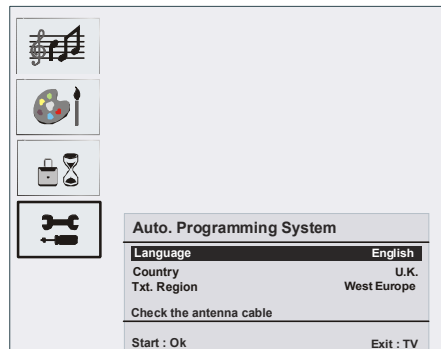

Set **Language** item by pressing ◀ or ▶ button. Press ▲ or ▼ button to highlight **Country** item and then use ◀ or ▶ to set. Press ▲ or ▼ button to highlight **Txt. Region**. Select a region by using ◀ or ▶ button. When finished, press **OK** button to continue. To cancel, press the **TV** button. The following menu will be displayed during the APS process:

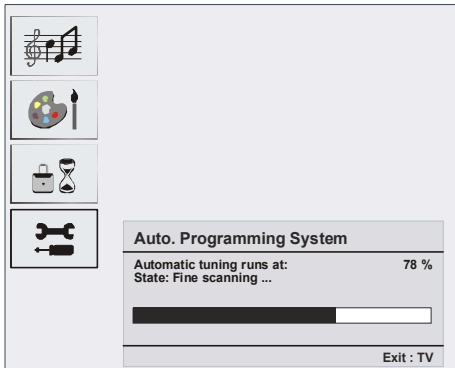

After APS is finalized, the programme table will appear on the screen. In the programme table you will see the programme numbers and names assigned to the programmes.

If you do not accept the locations and/or the programme names, you can change them in the programme table.

Configuration

Press the **M** button to display the main menu and press the **▼** button twice to highlight Configuration. Then press the **OK** button to display the configuration menu. Press the **M** button to leave the menu screen.

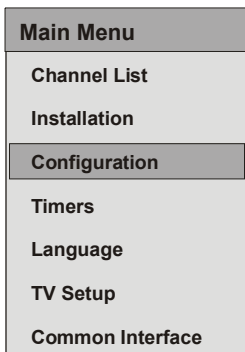

The various configuration functions are displayed in a list, along with a quarter-screen image of the currently selected channel. You can select a function by highlighting the corresponding menu line using the **▲** or **▼** button. Configuration menu will look like this:

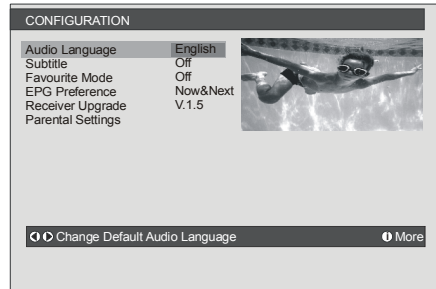

Audio Language

Digital terrestrial television channels can broadcast simultaneous soundtracks in more than one language. This function selects which language soundtrack you will hear when switching to a channel broadcasting with the multiple soundtracks.

Highlight the **Audio Language** line in the **Configuration** menu and use the **◀** or **▶** button to cycle through the language options.

Subtitle

Digital terrestrial television channels can broadcast subtitles displayed on the screen for hard-of-hearing people. This function selects the desired subtitle language and enables the automatic display of subtitles whenever subtitle information is broadcast.

Highlight the **Subtitle** line in the Configuration menu and use the **◀** or **▶** button to cycle through “Off” and language options.

Favourite Mode

This function enables or disables the favourite channel list mode.

Use **◀** or **▶** button to turn on/off favourite mode. If the “**Favourite Mode**” is on; while in normal operating mode, pressing **P+** and **P-** buttons will only navigate through the channels that were previously defined as favourites in the channel list.

EPG Preference

Digital terrestrial television channels can

broadcast simultaneous Next&Now and 7-Day electronic programme.

Highlight the EPG Preference line in the **Configuration** menu and use the ◀ or ▶ button to select **Next&Now** or **7-Day**.

Receiver Upgrade

The IDTV can be upgraded via the configuration menu, entered from the main menu.

In the configuration menu, highlight the **“Receiver Upgrade”** item by pressing ▲ or ▼ button and press the **OK** button to start upgrade process.

There are two possibilities for receiver software to be upgraded: **automatic** and **manual**.

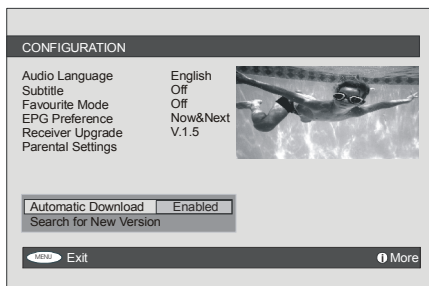

Automatic Download (Automatic Upgrade)

Automatic Download can be enabled or disabled by pressing ◀ or ▶ button. If it is enabled, then there are two ways for automatic upgrade:

- The first one is checking the existence of a new software every time the IDTV goes to standby.
- The second one is being activated at 03:00 A.M. every night, provided that the IDTV is left in standby mode.
- Both automatic upgrade methods result in standby mode either the upgraded or not.

If the automatic upgrade is set to **“Disabled”** then this function will not work.

Search for New Version (Manual Upgrade)

Manual upgrade starts if the **“Search for New Version”** item is highlighted by using ▲ or ▼ button and activated via pressing the **OK** button.

After **“Search for New Version”** is activated, the IDTV tunes to each frequency that have been stored in its database and looks for the new software. During this process, the following OSD is displayed:

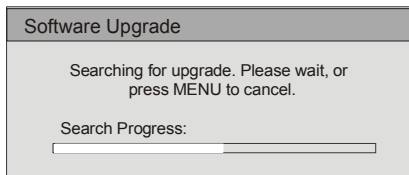

Parental Settings

Some channels broadcast material which you do not want younger members of the family to watch. Any channel can be 'locked' so that it cannot be selected for viewing unless a four-digit PIN code is entered. In this way, any channel not suitable for younger viewers can be prohibited.

This function enables or disables the menu protection system and allows the PIN code to be changed.

Use ▲ or ▼ button to highlight **Parental Settings** option. Press the **OK** button to enter Parental Settings menu. A dialog box asking for the lock key is displayed:

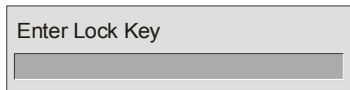

There is only one key which is set to **“0000”** initially. Enter lock key. If wrong lock key is entered, the following message is displayed and the TV then returns to the previous menu:

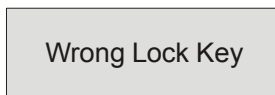

If it is correct, the **Parental Settings** menu will be displayed including the following items:

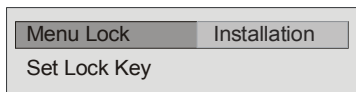

There you can set/reset locking for the main menu or the installation menu to restrict access. If the menu lock is disabled, there will be free access to the menu system. Also in this menu you can change the lock key and set/change parental lock mode.

Disabled: All menus are unlocked.

Main Menu: Main menu is accessible only with the correct lock key. So the user cannot add, delete, rename, move channels, cannot set timers.

Installation: Installation menu is locked, so the user cannot add channels.

Note: Changes will be updated after exiting configuration menu.

Timers

You can set a timer to switch the TV to any channel without your intervention. This is also for making video recordings of programmes when you are out.

Display the main menu by pressing the **M** button. Highlight the **Timers** line by pressing **▲** or **▼** button and press the **OK** button to display the Timer menu:

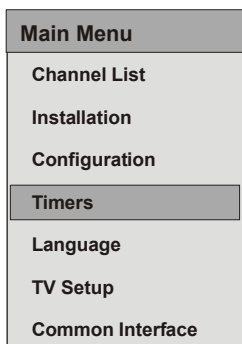

Up to five separate timer events can be set and each is displayed in the Timer screen, showing the event number, the channel to be selected, the start time, end time, date and the mode - whether that event is active (and will be acted on) or not.

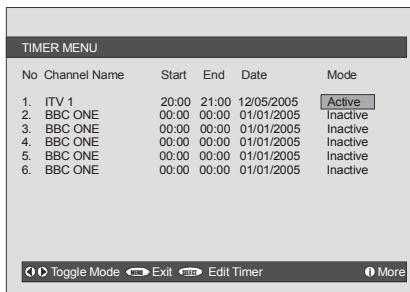

- To set an event, highlight its mode button using the **▲** or **▼** button and press the **OK** button to display the timer entry window.

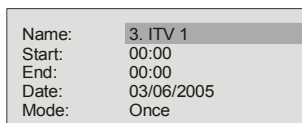

- Here the five settings consisting of the channel name, start time, end time, date and frequency mode can be set. You can move freely between each setting using the **▲** or **▼** buttons.
- The channel name is set using the **◀** or **▶** button to display the channel which broadcasts the programme.
- The start time, end time and date are each set with the numeric buttons on the remote control in 24-hour format.
- The frequency mode determines how often the receiver operates this event and is set with the **◀** or **▶** button to be either **Once**, **Daily**, or **Weekly**.

If an invalid number for the start or end times or the date is entered, “**Entered time is not valid**” message appears on the menu screen.

If timer action occurs while the TV is being watched, the TV switches to the selected channel. When timer expires, the TV switches back to the channel which it is switched from.

Selected digital channel will be output via Scart-2. You should connect your VCR to Scart-2 for recording digital broadcast.

Language

Some programmes are broadcast in two or more languages simultaneously. The language thus can be selected from the Language menu.

- Press the **M** button to display the main menu and use **▲** or **▼** button to highlight the Language line and press the **OK** button:

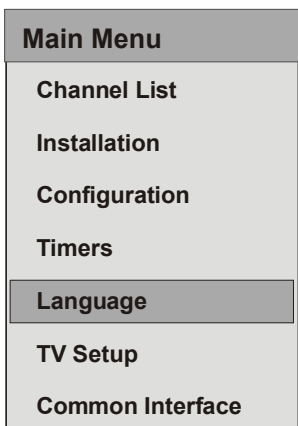

- Use the **▲** or **▼** button to highlight the soundtrack language required and press the **OK** button. Normal viewing, with the required language soundtrack, can be resumed by pressing the **M** button.

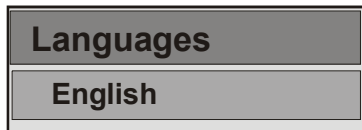

TV Setup

You can use this item to display the TV functions.

The digital TV Setup menu screen is accessed from the main menu. Press the **M** button to display the main menu and use **▲** or **▼** button to highlight “**TV Setup**”, press the **OK** button to display TV Setup menu screen.

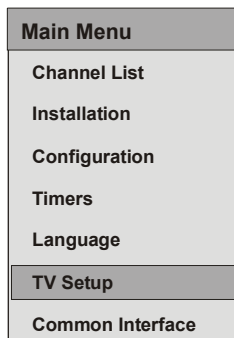

You can find detailed information for all menu items in “Analogue TV Menu System” section.

Common Interface

- Press the **M** button to display the main menu and use the **▲** or **▼** button to highlight the “**Common Interface**” line and press the **OK** button:

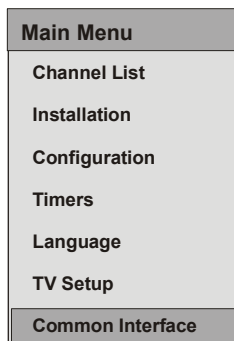

It is required to subscribe to a pay channel company to view the pay channels of the digital terrestrial broadcasting.

Obtain the Conditional Access Module (CAM) and the viewing card by subscribing to a pay

channel company, then insert those to the TV using the following procedure.

- Switch off the TV and unplug from the mains.
- Insert the CAM, then viewing card to the slot that is located in the terminal cover at the left-hand side of the TV (from front view).
- The CAM should be correctly inserted, it is impossible to insert fully if reversed. The CAM or the TV terminal may be damaged if the CAM is forcefully inserted.
- Connect the TV to the mains supply, switch on and then wait for few moments until the card is activated.
- Some CAMs may require the following set up. Please set the CAM by entering the IDTV menu, Common Interface then pressing the **OK** button. (CAM set up menu is not displayed when it is not required.)
- To see the viewing contract information: enter IDTV; press the **M** button, then highlight **Common Interface** and press the **OK** button.
- When no module is inserted, "**No Common Interface module detected**" message appears on the screen.
- Refer to the module instruction manual for details of the settings.

NOTE: Insert or remove the CI module only when the TV is in **STAND-BY** mode or **SWITCHED OFF**.

Navigating the Analogue TV Menu System

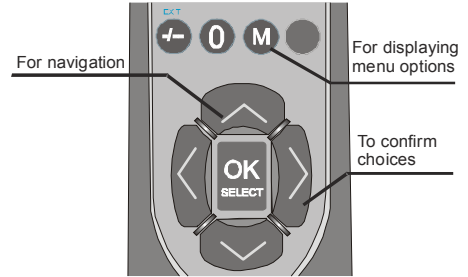

- Press **MENU** to display the main menu.
- Press **▲** or **▼** button to select an icon. Press **▶** or **OK** button for more options.
- Use **▲** or **▼** button to highlight.
- Press **◀** or **▶** buttons to change the settings. Press **OK** to set as default.
- To exit the menu or return from sub-menu screen, press **MENU**.

Note: These explanations are valid for the navigation of the whole menu system. To select options that are explained in the following parts, refer to "Navigating the Menu System".

Analogue TV Menu Map

1

SOUND	
Volume	<input type="text"/>
Balance	0 <input type="text"/>
Sound Mode	Stereo
Effect	On
Equalizer	Off
Back : Menu	Exit : TV

2

PICTURE	
Picture Mode	Bright
Brightness	<input type="text"/>
Contrast	<input type="text"/>
Colour	<input type="text"/>
Sharpness	<input type="text"/>
Back : Menu	Exit : TV

3

FEATURES	
Sleep Timer	Off
Language	English
Child Lock	Off
Menu Colour	Gray
Favourite Mode	Off
Back : Menu	Exit : TV

4

INSTALL	
Programming	>
A.P.S.	>
Txt. region	West Europe
Program Table	>
Back : Menu	Exit : TV

1 SOUND MENU

- Volume
- Balance
- Sound Mode
- Effect
- Equalizer
- Mode
- HP Volume
- Store

2 PICTURE MENU

- Picture Mode
- Brightness
- Contrast
- Colour
- Sharpness
- Colour Temp
- Picture zoom
- Store

3 FEATURES MENU

- Sleep Timer
- Language
- Childlock
- Menu Colour
- Favorite Mode

4 INSTALL MENU

- Programming
- Programme
- Band
- Channel
- Standard
- Colour System
- Search
- VCR Mode
- Decoder
- Store
- APS
- Auto Programming System
- Txt. Region
- Program Table

A menu map is provided above. For details of the items, refer to relevant explanations in the "MENU SYSTEM".

Analogue TV Menu System

Sound Menu

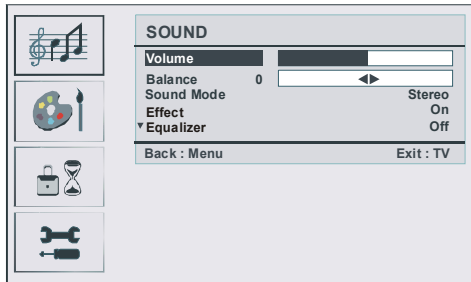

Volume

When you enter the sound menu, Volume will be the first selected option. Press ◀ / ▶ button to change the level of the Volume.

Balance

This setting is used for emphasizing the left or right speaker balance.

Press ▲ or ▼ button to select **Balance**. Press ◀ / ▶ button to change the level of the balance. Balance level can be adjusted between **-32** and **+32**.

Sound Mode

Press ▲ or ▼ button to select **Sound Mode**. Using ◀ / ▶ button, you can select **Mono**, **Stereo**, **Dual I** or **Dual II** mode, only if the selected channel supports that mode.

Effect

If you are watching a mono broadcast, set **Effect** on to obtain a better sound effect which will be more stereo-like. If the current sound system is stereo, switching this effect on will give a more spatial effect.

Press ▲ or ▼ button to select **Effect**. Press ◀ / ▶ button to set **Effect** as On or Off.

Equalizer

Press ▲ or ▼ button to select **Equalizer**. Press ◀ / ▶ button to change the Equalizer setting. In equalizer menu, the mode can be changed to **Flat**, **Speech**, **Music**, **Personal** and **Jazz**. Select the desired frequency by pressing ▼ / ▲ button and increase or decrease the frequency gain by pressing ◀ / ▶ button.

Note: Equalizer menu settings can be changed only when the mode is in Personal.

HP Volume

To adjust headphone volume level, press ▲ or ▼ button to select **HP Volume**. Press ◀ / ▶ button to change the level of the HP Volume.

Store

Select **Store** by pressing ▲ / ▼ button. Press ▶ or **OK** button to store the settings. “**Stored**” will be displayed on the screen.

Picture Menu

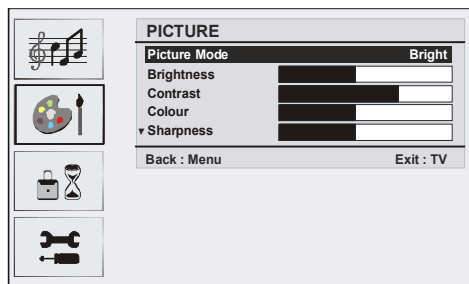

Picture Mode

For your viewing requirements, you can set the related **mode** option.

Press ▲ or ▼ button to select **Picture Mode**. Press ◀ or ▶ button to choose from one of these options: **Bright**, **Standard**, **Soft** and **Manual**.

Brightness/Contrast/Colour/Sharpness/Tint

Press ▲ or ▼ button to select the desired option. Press ◀ / ▶ button to set the level.

Hint: Tint (Hue) is displayed in picture menu when the TV receives an NTSC signal.

Colour Temp

Press ▲ or ▼ button to select **Colour Temp**. Press ◀ / ▶ to choose from one of these options: **Cool**, **Normal** and **Warm**.

Note:

- Setting **Cool** option gives white colours a slight blue stress.
- Setting **Warm** option gives white colours a slight red stress.
- For normal colours, select **Normal** option.

Picture Zoom

Picture Zoom setting enables you to select the aspect ratio of the broadcast.

Select **Picture Zoom** by pressing ▼ / ▲ button. Use ◀ / ▶ buttons to change Picture Zoom to **Auto**, **4:3**, **16:9**, **Cinema** or **Subtitle**.

Store

Select **Store** by pressing ▲ / ▼ button. Press ▶ or **OK** button to store the settings. “**Stored**” will be displayed on the screen.

Features Menu

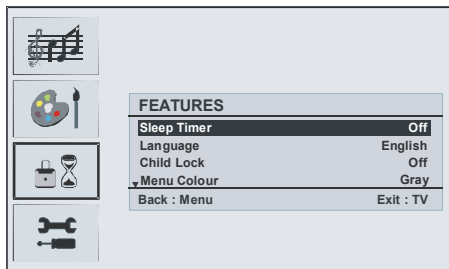

Sleep Timer

Press ▲ or ▼ button to select **Sleep Timer**. Use ◀ / ▶ button to set the **Sleep Timer**.

The timer can be programmed between **Off** and **120** minutes in steps of 10 minutes.

If **Sleep Timer** is activated, at the end of the selected time, the TV goes automatically to standby mode.

Language

Press ▲ or ▼ button to select **Language**. Use ◀ / ▶ button to select the **Language**.

Child Lock

Press ▲ or ▼ button to select **Child Lock**.

Use ◀ / ▶ button to set the Child Lock **On** or **Off**. When On is selected, the TV can only be controlled by the remote control handset. In this case the control panel buttons (except for the **STANDBY** button) will not work.

Hence, if one of those buttons is pressed, “**Child Lock On**” will be displayed on the screen when the menu screen is not visible.

Menu Colour

Press ▲ or ▼ button to select **Menu Colour**. Use ◀ / ▶ button to change menu background to **Transparent** or **Gray**.

Favourite Mode

Press ▲ or ▼ button to select **Favourite Mode**. Use ◀ / ▶ button to set Favourite mode On or Off (See the “Program Table” section for details).

Install Menu

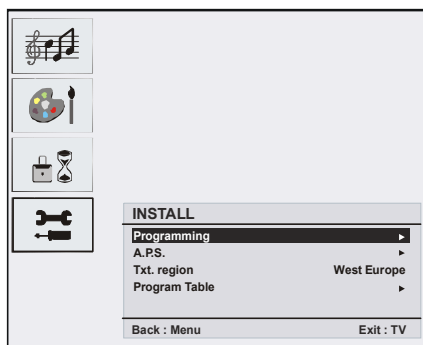

Programming

Select **Programming** by pressing ▼ / ▲ button. Then press ▶ button to display Programming menu:

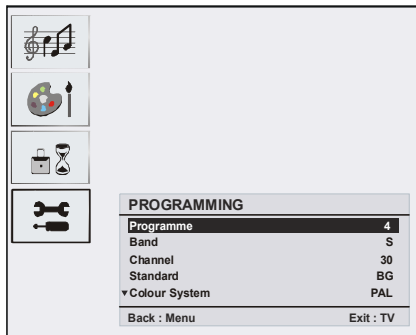

Programme

Select **Programme** by pressing ▼ / ▲ button.

Press ◀ / ▶ button to select the programme number. You can also enter a number via the numeric buttons on the remote control. There are 100 programme storage between 0 and 99.

Band

Band can be selected either **C** or **S**. Press ◀ / ▶ button to select **Band**.

Channel

Select **Channel** by pressing ▼ / ▲ button. Channel can be changed by pressing ◀ / ▶ button or the numeric buttons.

Standard

Select **Standard** by pressing ▼ / ▲ button. Use ◀ / ▶ button to change the standard to **B/G**,

D/K, **I** or **L/L'**.

Colour System

Select **Colour System** by pressing ▼ / ▲ button. Use ◀ / ▶ button to change the colour system to **PAL**, **SECAM** or **AUTO**.

Search

Select **Search** by pressing ▼ / ▲ button. Press ◀ / ▶ button to start search. The search will stop when a signal is found.

Note: If you press the buttons with one-step moves, a frequency of 0.25 Mhz will be advanced. However if you press the buttons all at once, it will advance automatically. To stop searching at a certain time, you may press ▼ / ▲ buttons.

VCR Mode

Select **VCR Mode** by pressing ▼ / ▲ button. Use ◀ / ▶ buttons to set VCR Mode as On or Off.

Hint: If you want to watch a DVD, then you have to set this item as **Off**.

Decoder

You can use this mode to connect any decoder to your TV.

Select **Decoder** by pressing ▼ / ▲ button. Press the ◀ / ▶ buttons to turn it On or Off.

When you switch the Decoder setting to **Off**, **EXT-1** output will be muted. In this case, **EXT-1** output will not be available to display video. If it is switched on, the **EXT-1** output will be the selected video source. Any decoder can be connected to **EXT-1** to unscramble required video signals.

Hint: Decoder setting should be stored separately for each programme.

Store

Select **Store** by pressing ▲ / ▼ button. Press ▶ or **OK** button to store the settings. "**Stored**" will be displayed on the screen.

A.P.S.

Select **A.P.S.** by pressing ▲ / ▼ button. Press ▶ button to enter the **A.P.S.** submenu:

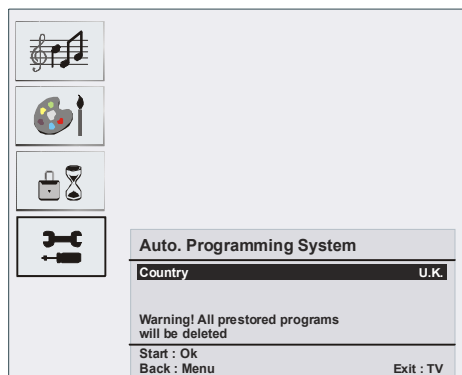

A.P.S. Country

Press ◀ / ▶ button to set your country.

If you want to exit from A.P.S. function, press the **TV** button. For going back, press **M**.

When you press **OK** button for starting APS, all stored programs will be erased and the following screen will be displayed:

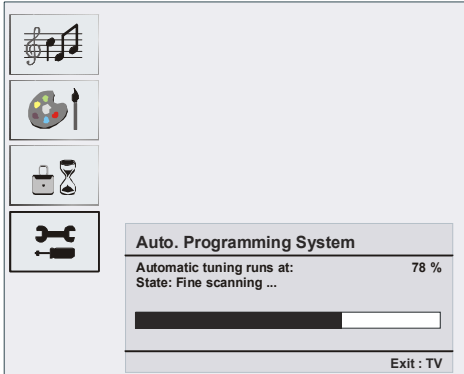

Whenever you press the **TV** button, A.P.S. function stops and program table appears on the screen.

If you wait until the end of A.P.S., Program Table is displayed with the programmes found and located.

Teletext Region

Select **Txt. region** by pressing **▲ / ▼** button. Using **◀ / ▶** buttons, select your teletext region. There are five options to select: **West Europe**, **East Europe**, **Turk/Gre**, **Cyrillic** and **Arabic/Hebrew**.

Install menu in AV modes

The following screen appears in the install menu:

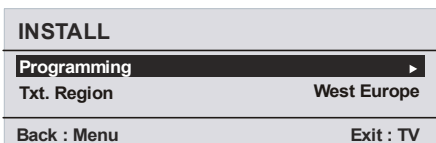

Programming

Select **Programming** by pressing **▲ / ▼** button. After pressing **▶** button, programming menu appears on the screen:

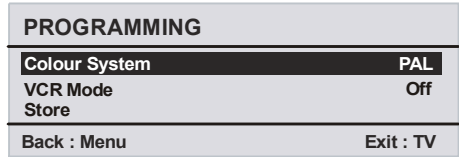

Colour System

Select **Colour System** by pressing **▲ / ▼** button. Press **◀ / ▶** button to change the colour system to **PAL**, **SECAM** or **AUTO**.

Program Table

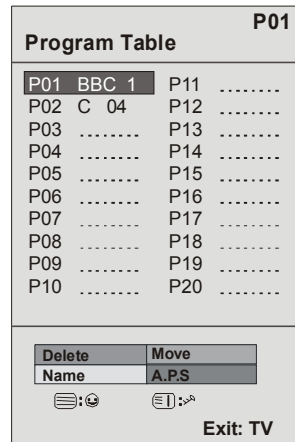

Program Table lists the channels that are stored in the memory. By moving the cursor in four directions, you can reach 20 programmes in the same page. You can scroll up or scroll down to see all the programmes while in TV mode by pressing the navigation buttons. By cursor action, programme selection is done automatically.

Name

To change the name of a programme, select the desired programme and press the **YELLOW** button.

The first letter of the selected name starts to blink. Press **▲ / ▼** button to change that letter and **◀ / ▶** button to select the other letters. By pressing the **YELLOW** button, you can store the name.

Move

Select the programme that you want to insert by using the navigation buttons. Press the **GREEN** button. Using navigation buttons, move the selected programme to the decided programme space and press the **GREEN** button again.



Delete

To delete a programme, press the **RED** button. Pressing the **RED** button again erases the selected programme from the programme list and the programmes below shift one line up.

APS (Auto Programming System)

When you press the **BLUE** button for APS, **Auto Programming System** menu will appear on the screen.

Favourite Mode

You can set various channels as favourites so that only the favourite channels are navigated. To set a favourite, use the navigation buttons to select a channel and then press the  item. The channel selected as a favourite appears in the Program Table with a favourites icon () against the channel name. For removing a favourite, carry out the same operation. To exit, press **M**.

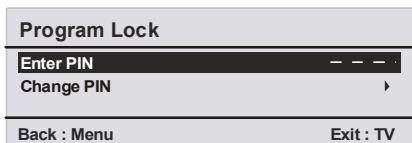

Program Lock



Program Locking provides a password-protected access to channels selected by parents. In order to lock a channel you should know the Program Lock password (default value is set to **0000** in the factory and can only be changed from the **Program Lock** menu).

Enter PIN

Select the channel that you desire to lock by

highlighting it and then press the  button. When the  button is pressed, Program Lock menu will be displayed on the screen. After entering the pin code, desired channel will be locked. The program lock icon will appear next to the channel name. When the locked channel is selected through **P+** or **P-** buttons, the following warning screen will be displayed:

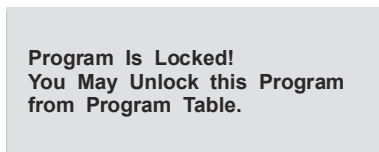

Change PIN

Select **Change PIN** by pressing **▼ / ▲** button. Use **▶** button to change the PIN code. After pressing **▶** button, the following message appears on the screen:

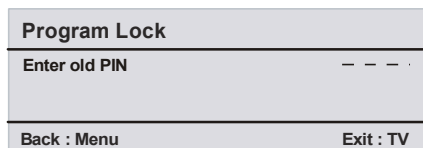

Enter old PIN code through the numeric buttons and then enter your new PIN code. Program Lock menu will be displayed on the screen when you enter the new PIN code:

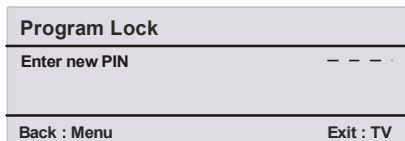

Program Lock Menu will again be displayed after a short while of the identification of new PIN.

Hint: If you forget your Program Lock password, you can deactivate the Program Lock by using the code 7910 and be able to set new password for future use. Thus, do keep this code in a safe place for future reference.

PC Mode Menu System

See the “**Connecting the LCD TV to a PC**” section for connecting a PC to the TV set.

For switching to **PC** source, press the **(AV)** button on your remote control and select **PC** input.

Note that PC mode menu settings are available only while the TV is in PC source.

Sound Menu

The items in this menu are described at “**Sound Menu**” section explained in the “Menu System” section.

Feature Menu

Feature menu settings are identical to the settings explained in “**Feature Menu**” section in the “Menu System” section.

PC Picture Menu

Select PC Picture menu by pressing **▲ / ▼** button and then press **▶** button. PC Picture menu appears on the screen. **Brightness**, **Contrast** and **Colour Temperature** adjustments in this menu are identical to adjustments defined in TV picture menu in “**Menu System**” part.

Geometry Menu

Select the fourth icon by pressing **▲ / ▼** button and then press **▶** button. Geometry menu appears on the screen:

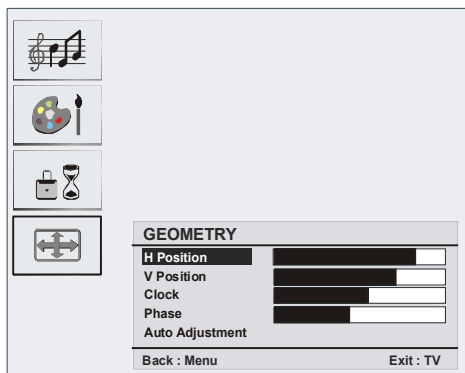

H. (Horizontal) Position

This item shifts the image horizontally to right hand side or left hand side of the screen.

Select **H. position** by pressing **▼ / ▲** button. Use **◀ / ▶** button to adjust the value.

V. (Vertical) Position

This item shifts the image vertically towards the top or bottom of the screen.

Select **V. position** by pressing **▼ / ▲** button. Use **◀ / ▶** button to adjust the value.

Clock

Clock adjustments correct interference that appear as vertical banding in dot intensive presentations like spreadsheets or paragraphs or text in smaller fonts.

Select **Clock** by pressing **▼ / ▲** button. Use **◀ / ▶** button to adjust the value.

Phase

Depending on the resolution and scan frequency that you input to the TV set, you may see a hazy or noisy picture on the screen. In such a case, you can use this item to get a clear picture by trial and error method.

Select **Phase** by pressing **▼ / ▲** button. Use **◀ / ▶** button to adjust the value.

Auto Adjustment

If you shift the picture horizontally or vertically to an unwanted position, use this item to put the picture into correct place automatically.

Select **Auto Adjustment** item by using **▼ / ▲** buttons. Press **▶** or **OK** button.

Warning: Auto position adjustment recommended to be done with the full screen image for the proper adjustment.

Displaying TV Information

Programme Number, Programme Name, Sound Indicator and **Zoom Mode** information are displayed on the screen when a new programme is entered or  button is pressed.

Mute Function

Press  button to disable sound. Mute indicator will be displayed in the upper side of the screen.



To cancel mute, there are two alternatives; the first one is pressing the  button and the second one is increasing the volume level.

Personal Preference

Press **PP** button to adopt the previous settings that you had stored before.

Zoom Modes

You can change the aspect ratio of the TV for viewing the picture in different zoom modes. Press **WIDE** button to directly change the zoom mode. Available zoom modes are listed below:

Auto

When a **WSS (Wide Screen Signalling)** signal, which shows the aspect ratio of the picture, is included in the broadcast signal or the signal from an external device, the TV automatically changes the **ZOOM** mode according to the **WSS** signal.

- When the **AUTO** mode does not function correctly due to poor **WSS** signal quality or when you want to change the **ZOOM** mode, change to another **ZOOM** mode manually.

4:3

Use to view a normal picture (4:3 aspect ratio) as this is its original size.

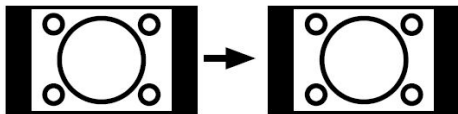

16:9

This uniformly stretches the left and right sides of a normal picture (4:3 aspect ratio) to fill the wide TV screen.

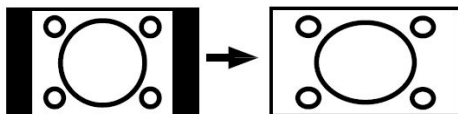

- For 16:9 aspect ratio pictures that have been squeezed into a normal picture (4:3 aspect ratio), use the **16:9** mode to restore the picture to its original shape.

Cinema

This zooms up the wide picture (16:9 aspect ratio) to the full screen.

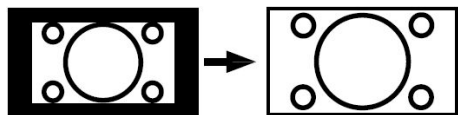

Subtitle

This zooms up the wide picture (16:9 aspect ratio) with subtitles to the full screen.

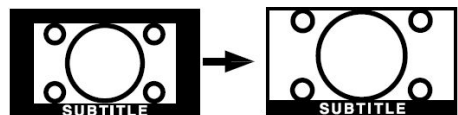

Teletext

Teletext system transmits information such as news, sports and weather on your TV. Note that if the signal becomes insufficient, some text errors may occur or the teletext mode may be quitted.

Teletext function buttons are listed below:

Teletext On-Off / PAT mode

Activates teletext mode when pressed once. Pressing this button again will split the screen into two windows, one displaying the teletext and the other displaying the current channel. Pressing again will quit the teletext mode.

Index

Selects the teletext index page.

Mix

Places the teletext screen over the programme.

Expand

Press once to enlarge top half of the page, press again to enlarge the bottom half of the page. Press again to revert back to normal size.

Reveal

Shows hidden information (e.g. solutions of games).

Hold

Holds a text page when convenient. Press again to resume.

Subcode Pages / Time

Selects subcode pages if available when the teletext is activated. When the teletext is not activated, displays time info if the programme has teletext transmission.

P+ / P- and numbers (0-9)

Press to select a page.

*Note: Most TV stations use code **100** for their index pages.*

Coloured Buttons

(RED/GREEN/YELLOW/BLUE)

Your TV supports both **FASTEXT** and **TOP text** systems. When these systems are available, the pages are divided into groups or topics.

When **FASTEXT** system is available, sections in a teletext page will become colour-coded and can be selected by pressing the coloured buttons. Press a coloured button that corresponds to with your needs.

The coloured writings will appear, showing you, which coloured buttons to use when **TOP text** transmission is present. Pressing **P -** or **P +** commands will request the next or previous page respectively.

Tips

Screen Care

Clean the screen with a slightly damp, soft cloth. Do not use abrasive solvents as they may damage the coating layer of the TV screen.

For your safety, unplug the mains plug when cleaning the set. When moving the TV, hold it properly from the bottom part.

Image Persistence

Please note that ghosting may occur while displaying a persistent image. LCD TVs' image persistence may disappear after a short time. Try turning off the TV for a while.

To avoid this, do not leave the screen in still picture for extended periods.

No Power

If your TV system has no power, please check the main power cable and connection to the mains socket outlet.

Poor Picture

Have you selected the correct TV system? Is your TV set or house aerial located too close to a non-earthed audio equipment or neon lights, etc.?

Mountains or high buildings can cause double pictures or ghost images. Sometimes you can improve the picture quality by changing the direction of the aerial.

Is the picture or teletext unrecognisable? Check if you have entered the correct frequency.

The picture quality may degrade when two peripherals are connected to the TV at the same time. In such a case, disconnect one of the peripherals.

No Picture

Is the aerial connected properly? Are the plugs connected tightly to the aerial socket? Is the aerial cable damaged? Are suitable plugs used to connect the aerial? If you are in doubt, consult your dealer.

No Picture means that your TV is not receiving a transmission. Have you selected the correct button on the remote control? Try once more.

Sound

You cannot hear any sound. Did you perhaps interrupt the sound, pressing the  button?

Sound is coming from only one of the speakers. Is the balance set to one extreme? See **Sound** menu.

Remote Control

Your TV no longer responds to the remote control. Perhaps the batteries are exhausted. If so you can still use the local buttons at the bottom of the TV.

Input Sources

If you cannot select an input source, it is possible that no device is connected.

Check the AV cables and connections if you have tried to connect a device.

CI Module

If you are experiencing a problem with the CI module, it is possible that CI module is not properly inserted. Remove the CI card and then reinsert.

If the problem persists, it is possible that your CI module is not recognized. Try inserting a different CI module.

Appendix A: PC Input Typical Display Modes

The display has a maximum resolution of 1680 x 1050, frequency range of 56-75 Hz. The following table is an illustration of some of the typical video display modes.

Your TV may not support different resolutions. Supported resolution modes are listed below.

If you switch your PC to an unsupported mode, a warning OSD will appear on the screen.

Mode	Resolution		Frequency (Hz)	
	Horizontal	Vertical		
1	640	480	60	IBM, VGA
2	720	400	70	IBM, VGA
3	800	600	56	VESA
4	800	600	60	VESA
5	640	480	72	VESA
6	640	480	75	VESA
7	800	600	72	VESA
8	800	600	75	VESA
9	1024	768	60	VESA
10	1024	768	70	VESA
11	1024	768	75	VESA
12	1280	720	60	VESA
13	1280	768	60	VESA
14	1360	768	60	VESA
15	1680	1050	60	*

Note : Your PC may not work correctly with some resolution modes which are listed above because of unexpected causes. When you confront with such a problem, please try switching your PC to different resolution modes.

Specifications

TV BROADCASTING

PAL/SECAM B/G D/K K' I/I' L/L'

RECEIVING CHANNELS

VHF (BAND I/III)

UHF (BAND U)

HYPERBAND

CABLE TV (S1-S20 / S21-S41)

NUMBER OF PRESET CHANNELS

100

CHANNEL INDICATOR

On Screen Display

RF AERIAL INPUT

75 Ohm (unbalanced)

OPERATING VOLTAGE

220-240V AC, 50 Hz.

AUDIO

German + Nicam Stereo

AUDIO OUTPUT POWER (W_{RMS}) (10% THD)

2x4W

POWER CONSUMPTION (W)

75 W

Less than 1W (Standby)

PANEL

16:9 display, 22" Screen Size

DIMENSIONS (mm)

DIMENSIONS (mm)				
D	L	H	Weight (kg)	
180	540	440	6.7	With stand
90	540	400	6.5	Without stand

Your SANYO product is designed and manufactured with high quality materials and components which can be recycled and reused.



This symbol means that electrical and electronic equipment, at their end-of-life, should be disposed of separately from your household waste.

Please dispose of this equipment at your local community waste collection/recycling centre.

In the European Union there are separate collection systems for used electrical and electronic products.

Please help us to conserve the environment we live in!

Pin Specifications

Signal Input

PC RGB Terminal (D-sub 15-pin connector)

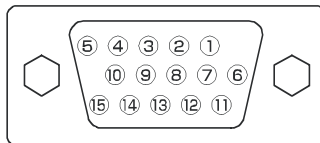

Pin	Input signal
1	R
2	G or sync on green
3	B
4	No connection
5	No connection
6	R.GND
7	G.GND
8	B.GND
9	No connection
10	GND
11	No connection
12	[SDA]
13	H.sync or H/V composite sync
14	V.sync. [V.CLK]
15	[SCL]

- When different kinds of input signals are simultaneously input to the monitor via a graphics board or the like, the monitor will automatically select the signals in the following priority order:

Sync signal type	Priority
H/V separate sync.	1
H/V composite sync.	2
sync.on Green *	3

- Even in the case of the recommended signals shown on the following page, there may be instances when correct display is not possible. In this case, use H/V separate sync, H/V composite sync.

HDMI connector pin specifications

Pin	Input signal	Pin	Input signal
1	TMDS Data2+	11	TMDS Clock Shield
2	TMDS Data2 Shield	12	TMDS Clock-
3	TMDS Data 1-	13	CEC
4	TMDS Data 1+	14	Reserved (N.C. on device)
5	TMDS Data1 Shield	15	SCL
6	TMDS Data1-	16	SDA
7	TMDS Data0+	17	DDC/CEC Ground
8	TMDS Data0 Shield	18	+5V Power
9	TMDS Data0-	19	Hot Plug Detect
10	TMDS Clock+		

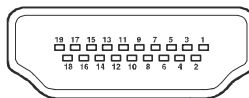

SCART connector pin specifications

Pin	Input signal	Pin	Input signal
1	AUDIO OUT (RIGHT)	12	Not used
2	AUDIO IN (RIGHT)	13	RGB-R GND
3	AUDIO OUT (LEFT/MONO)	14	GND
4	AUDIO GND	15	RGB-R / S.VHS CHROMINANCE IN
5	RGB-B GND	16	BLANKING SIGNAL
6	AUDIO IN (LEFT/MONO)	17	COMPOSITE VIDEO GND
7	RGB-B IN	18	BLANKING SIGNAL GND
8	AUDIO / RGB SWITCH / 16:9	19	COMPOSITE VIDEO OUT
9	RGB-G GND	20	COMPOSITE VIDEO / S.VHS LUMINANCE IN
10	Not used	21	GND / SHIELD (CHASSIS)
11	RGB-G IN		

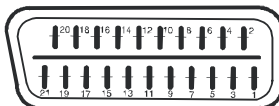

Important Instruction

For your own safety read following instruction carefully before attempting to connect this unit to the mains supply.

MAINS (AC) OPERATION

The wires in the mains lead are coloured in accordance with the following code :

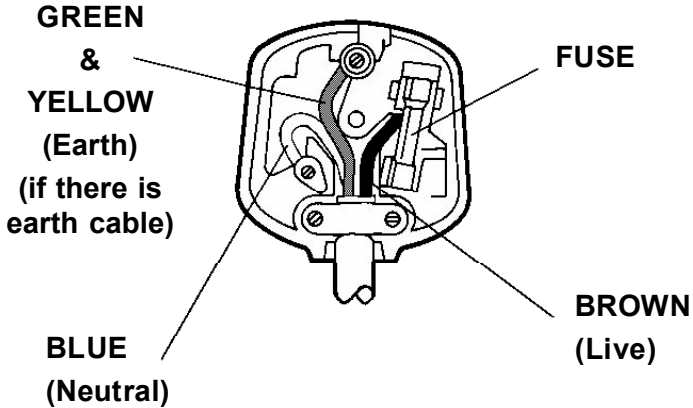

IMPORTANT

As the colours of the wires in the mains lead of this appliance may not correspond with the coloured markings identifying the terminals in your plug, proceed as follows:
The Green and Yellow coloured wire must be connected to the terminal which is marked with the letter E, or by the earth symbol, or with Green or Green and Yellow colors.

The Blue or Black coloured wire must be connected to the terminal which is marked with the letter N or black colour.

The Brown or Red coloured wire must be connected to the terminal which is marked with the letter L or Red colour.

For continued protection against risk of fire, replace only with a fuse with the same type and rating. (ASTA approved 5A 250VAC fuse).

CAUTION

TO PREVENT ELECTRIC SHOCK DISCONNECT FROM THE MAINS BEFORE REMOVING COVER. NO USER SERVICEABLE PARTS INSIDE. REFER SERVICING TO QUALIFIED SERVICE PERSONNEL.

SAFETY PRECAUTION

THIS DEVICE MUST BE DISCONNECTED FROM THE MAINS WHEN NOT IN USE. DO NOT ALLOW THIS UNIT TO BE EXPOSED TO RAIN OR MOISTURE.

Contents

General Properties	45	The language for the sound or subtitles on a DVD cannot be changed	56
About this Manual	45	Some functions (Angle, Zoom etc) do not work	56
Safety Information	45	No picture	57
Notes on Discs	46	No sound	57
DVD Control Panel Buttons	47	Distorted sound	57
Remote Control Buttons	48	No response from remote control	57
Disc Types Compatible with This Unit:	49	If nothing works	57
DVD Playback	50	Definition of Terms	57
Rapid Advance (Rapid Reverse)	50	Angle	57
Skipping Ahead or Back to Chapters	50	Chapter Number	57
Still Picture (PAUSE)	50	DVD	57
Frame Advance (STEP FORWARD)	50	Playback Control	57
Slow- motion Play Forward	50	Subtitles	57
Direct Selection of Scenes	51	Time Number	57
Repeat Play	51	Title Number	57
Convenient Functions	52	Track Number	57
Using a DVD Menu	53	Dolby Digital	57
CD Menu	53	Dolby Pro Logic	57
Basic Play	53	LPCM	57
MP3/MPEG File :	53	MPEG	57
PAUSE	53	Specifications	58
Stopping Play	54		
Skipping Ahead or Back to Tracks	54		
ZOOM	54		
REPEAT	54		
File List Function	54		
Setup Menu	55		
MAIN PAGE	55		
MENU ITEMS	55		
VIDEO SETUP PAGE	55		
LANGUAGE SETUP	55		
PREFERENCES	56		
Troubleshooting	56		
The picture quality is poor (DVD)	56		
Disc does not play	56		
Wrong OSD language	56		

DVD

HOW TO WATCH A DVD

When TV set is turned on, press DVD button on Remote Control. If there is no disc, insert a disc and press DVD button.

General Properties

- DVD/CD / CD-R / CD-RW / MP3 / JPEG / MPEG playback.
- PAL playback (according to disc content)
- User-friendly multilanguage OSD menu control.
-  LPCM audio via coaxial and optical digital audio outputs. (optional)
- Multiple Aspect Ratio support (16:9 Widescreen, 4:3 Letterbox, 4:3 PAN & SCAN)
- Multi-Audio (up to 8) support (According to disc content)
- Multi-Subtitle (up to 32) support (According to disc content)
- Multi-Angle (up to 9) support (According to disc content)
- 8 level parental control
- Fast forward and rewind in 5 different speeds. (2x, 4x, 8x, 16x, 32x)
- Slow motion playback in 4 different speeds. (1/2x, 1/4x, 1/8x, 1/16x forward)
- Frame by frame forward playback.
- Time Search
- Repeat
- A → B repeat
- Program function for Audio CD, MP3 and JPEG.
- Coaxial & Optical digital audio outputs (optional)
- Copied disks may be incompatible.

Note:

*** This DVD player may not support some MP3 recordings due to differences in recording formats or disc type.

*** Please read the owner's manual about MP3 playback.

*** CD-R/CD-RW discs recorded by CD-DA method can be played. Some CD-R/CD-RW discs may be incompatible due to laser pick-up and disc design.

*** DVD-R/RW discs recorded by DVD-Video method can be played. Some DVD-R/RW discs may be incompatible due to laser pick-up and disc design.

*** Some discs may be incompatible with JPEG Viewer function due to different recording format or condition of the discs.

About this Manual

Safety Information

CAUTION

DVD Player is a class 1 laser product. However this product uses a visible laser beam which could cause hazardous radiation exposure. Be sure to operate the player correctly as instructed.

**CLASS 1
LASER PRODUCT**

- Manufactured under license from Dolby Laboratories. "Dolby", and the double-D symbol are trademarks of Dolby Laboratories.

CAUTION

RISK OF ELECTRIC SHOCK



The lightning flash with arrowhead symbol, within an equilateral triangle, is intended to alert the user to the presence of uninsulated "dangerous voltage" within the product's enclosure that may be of sufficient magnitude to constitute a risk of electric shock of persons.



The exclamation point within an equilateral triangle is intended to alert the user to the presence of important operating and maintenance (servicing) instructions in the literature accompanying the appliance.

Notes on Discs

On handling discs

- To keep the disc clean, handle the disc by its edge. Do not touch the surface.
- Do not stick paper or tape on the disc.
- If the disc is contaminated with any substance like glue remove before using it.

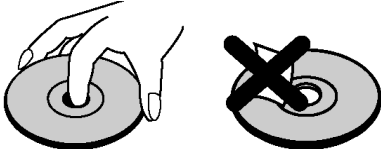

- Do not expose the disc to direct sunlight or heat sources such as hot air ducts, or leave it in a car parked in direct sunlight as the temperature can rise quickly and damage the disc.
- After playing, store the disc in its case.

HOW TO WATCH A DVD

When TV set is turned on, press DVD button on Remote Control. If there is no disc, insert a disc and press DVD button.

- This product incorporates copyright protection technology that is protected by method claims of certain U.S. patents and other intellectual property rights owned by Macrovision Corporation and other rights owners. Use of this copyright protection technology must be authorized by Macrovision Corporation, and is intended for home and other limited viewing uses only unless otherwise authorized by Macrovision Corporation. Reverse engineering or disassembly is prohibited.

On cleaning

- Before playing, clean the disc with a cleaning cloth. Wipe the disc from the center out.

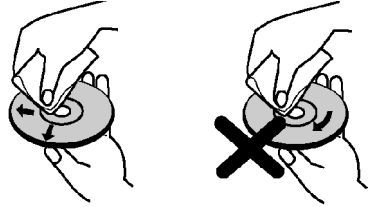

- Do not use solvents such as benzene, thinner, commercially available cleaners or anti-static spray intended for vinyl LPs.

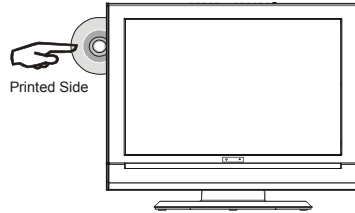

Place the disc into the loader and push gently inside while the disc's printed side confronts with you. The TV will then move the disc into the loader automatically.

DVD Control Panel Buttons

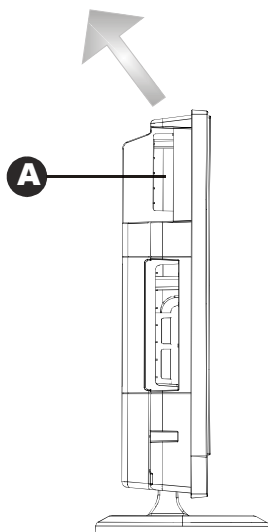
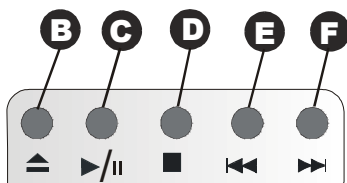

SIDE VIEW

A Disc Loader = Please insert a disc into the disc Loader.

B  = Open / Close (Eject or Load the disc)



C  = Plays/pauses the disc. When DVD menu (root menu) is active, this button functions as "button select" (selects the highlighted item in menu) if this is not prohibited by the disc.

D  = Stop (Stop playing disc.)

E  = Search back / Skip back

F  = Search forward / Skip next

Note 1: 8 cm discs should be placed into the loader in accordance with the indication marks.



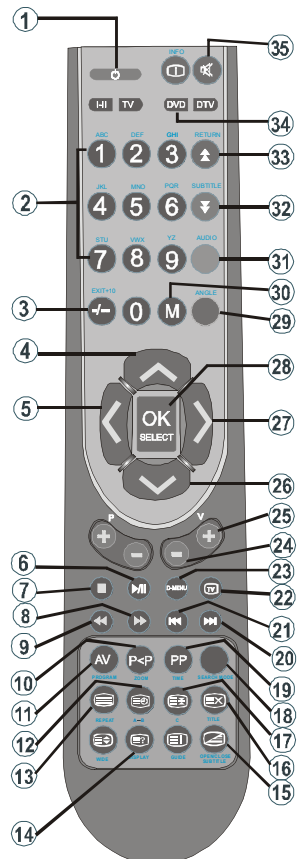

Note 2: Search forward and search back function will be available when you constantly press  or  button.

- ① Standby On-Of
- ② Digits (Press to enter track/chapter/title/time/etc... numbers directly.)
- ③ To enter 2-digit numbers
- ④ Cursor Up
- ⑤ Cursor Left
- ⑥ Play / Pause
- ⑦ Stop
- ⑧ Search Forward
- ⑨ Search Back
- ⑩ Zooms the picture by 2x, 3x, 4x while playing DVD. Pressing zoom button again disables zoom mode.
- ⑪ Press to enter file list mode to list all the files in the disc. In file list mode, the same type of files can be played back together in repeat modes.
- ⑫ Press to execute the A↔B repeat play if not prohibited by the disc.
- ⑬ Press to execute disc/title/chapter repeat if not prohibited by the disc.
- ⑭ Displays the content menu during playback or displays the set-up menu during "Stop & Resume" mode.
- ⑮ Eject/Load
- ⑯ Displays the title menu of the DVD if supported by the disc.
- ⑰ Clear
- ⑱ Press to select the unit for search (title, chapter, track, index, time etc.) if not prohibited by the disc.
- ⑲ Changes the playing time display mode of the disc, title, track etc., on the OSD.
- ⑳ Skip Next
- ㉑ Skip Back
- ㉒ No Function
- ㉓ DVD MENU
- ㉔ Volume Down
- ㉕ Volume Up
- ㉖ Cursor Down
- ㉗ Cursor Right
- ㉘ Executes the items or settings.
- ㉙ Changes the angles when playing a DVD if supported by the disc.
- ㉚ TV MENU
- ㉛ Changes the language of the sound while playing a DVD if supported by the disc.
- ㉜ Changes the language of the subtitle while playing a DVD if supported by the disc.
- ㉝ Returns to root menu or resumes playback from root menu.
- ㉞ **DVD Mode Select**
- ㉟  = Mute



Disc Types Compatible with This Unit:

This player can play the following discs.

Disc Types (Logos)	Recording Types	Disc Size	Max. Playing Time	Characteristics
DVD 	Audio + Video	12 cm	Single - sided; 240 min. Double - sided; 480 min.	<ul style="list-style-type: none"> • DVD contains excellent sound and video due to Dolby Digital and MPEG-2 System. • Various screen and audio functions can be easily selected through the on screen menu.
		8 cm	Single - sided; 80 min. Double - sided; 160 min.	
AUDIO-CD 	Audio	12 cm	74 min.	<ul style="list-style-type: none"> • An LP is recorded as an analog signal with more distortion. CD is recorded as a Digital Signal with better audio quality, less distortion and less deterioration of audio quality over time.
		8 cm	20 min.	
MP3-CD 	Audio (xxxx.mp3)	12 cm	It depends on MP3 quality.	<ul style="list-style-type: none"> • MP3 is recorded as a Digital Signal with better audio quality, less distortion and less deterioration of audio quality over time.
		8 cm		
PICTURE-CD 	Video (still picture)	12 cm	It depends on JPEG quality.	<ul style="list-style-type: none"> • JPEG is recorded as a Digital Signal with better picture quality over time.
		8 cm		

DVD Playback

Basic Play

1. Press on the power button
2. Please insert a disc to the loader.

The disc will be automatically loaded and play commences if the disc does not have any menus recorded on it.

A menu may appear on the TV screen after a few moments or the film may start immediately after the introduction of the Film Company. This behaviour depends on the disc content and may change.

NOTE: Step 3 and 4 is available only when a menu is recorded on the disc.

3. Press ◀/▶/▼/▲ or the number button(s) to select the preferred title.

4. Press SELECT.

Play of the selected items now starts. The played item may be a motion picture, a still picture or another submenu depending on the disc.

For your reference:

- If an action corresponding to a button is prohibited the "⊗" symbol appears.

Stopping Play

Press stop (■) twice.

To stop the play permanently, press STOP (■) twice. When the STOP (■) button is pressed for the first time, a message "PRESS PLAY KEY TO CONTINUE" will appear on the screen to remind you if you want to continue the play. To stop the play, press the STOP (■) button again or you can press SELECT to continue.

Stopping Play and Returning To The Menu Screen:

(When a menu is available on the disc)

Press MENU or TITLE button depending on the disc. Play is suspended, and the Disc menu screen is displayed.

Rapid Advance (Rapid Reverse)

Press **SEARCH/SLOW (▶▶)** or **SEARCH/SLOW (◀◀)** on the remote control during play.

- Normal play is resumed when the **SELECT** button or **PLAY/PAUSE (▶/||)** button is pressed.
- The speed of advance (▶▶ 2x, ▶▶ 4x, ▶▶ 8x, ▶▶ 16x, ▶▶ 32x) or reverse (◀◀ 2x, ◀◀ 4x, ◀◀ 8x, ◀◀ 16x, ◀◀ 32x) changes for every press of the ▶▶ or ◀◀ button.

Note: No sound will be heard during Rapid advance or Rapid reverse.

Skipping Ahead or Back to Chapters

Skipping ahead

Press **SKIP/ FRAME (▶▶)** on the remote control during play.

A chapter is skipped forward each time the button is pressed.

Skipping back

Press **SKIP/ FRAME (◀◀)** on the remote control during play.

When the button is pressed once midway through a chapter, play returns to the previous chapter.

Still Picture (PAUSE)

Press **PLAY/PAUSE (▶/||)** once during play.

The screen freezes.

To return to normal play press PLAY/PAUSE (▶/||) again.

Frame Advance (STEP FORWARD)

Press **PLAY/PAUSE (▶/||)** once during play.

The screen freezes.

Press **SKIP/ FRAME (▶▶)** on the remote control.

The next frame of the movie is displayed.

You can press SKIP/ FRAME (▶▶) for the following frames.

To return to normal play press **PLAY/PAUSE (▶/||)** again.

NOTE: Reverse stepping is not available.

Slow-motion Play Forward

Press **PLAY/PAUSE (▶/||)** once during play.

The screen freezes.

Press **SEARCH/SLOW (▶▶)** on the remote control.

The unit starts playing the movie at four different speeds (▶▶ 1/2, ▶▶ 1/4, ▶▶ 1/8 and ▶▶ 1/16).

You can increase or decrease the speed of the slow-motion play by pressing SEARCH/SLOW (▶▶ or ◀◀).

The speed of slow motion play is displayed on the screen each time you change it.

To return to normal play, press **PLAY/PAUSE (▶/||)**.

NOTE: No sound will be heard during Slow motion play.

NOTE: Reverse slow motion play is not available.

Direct Selection of Scenes

Selecting Scenes by Chapter Number

Press **SEARCH** on the remote control once during playback.

The chapter/title search box is displayed on the screen. You can see the currently playing and total number of chapters in right hand side of the display bar as -- / xx.

Enter the number of the chapter using number buttons.

The selected chapter is played just after you enter the chapter number.

For your convenience:

- If the chapter number you entered is between 0 and 9, player will automatically jump to the related chapter. To enter a chapter number which is more than 1 digit, press **+10** key and then enter the chapter number.
- You can clear the field by pressing the **C** button if you enter a wrong number.
- If you attempt to enter a number greater than the total number of chapters on the current title, the search box disappears and "[O] Input Invalid" message is displayed on screen.
- If you wait five seconds without pressing any key for selecting scenes by chapter number, the operation is cancelled.
- You can press **RETURN** key to cancel title search.

Selecting Scenes by Title Number

Press **SEARCH** on the remote control once during playback.

The chapter/title search box is displayed on the screen. You can see the currently playing and total number of titles in left hand side of the display bar as -- / xx.

Press **◀ (Left)** or **▶ (Right)** button on the remote control to select the title field in the search box to change the title.

You can see the currently playing title and total title numbers on the top-left side of the display as -- / xx.

Enter the number of the title using number buttons.

The selected title is played just after you enter the title number.

Selecting Scenes by Time

You can view the DVD starting from any time point you want.

Press **SEARCH** on the remote control "twice" during playback.

The time search box is displayed on the screen as **Title xx/xx Time -- : -- : --**.

Enter the time using number buttons.

The title is played beginning from the desired time just after you enter the time. If not prohibited by the DVD.

Press **SEARCH** on the remote control "three times" during playback.

The time search box is displayed on the screen as **Chapter xx/xx Time -- : -- : --**.

Enter the time using number buttons.

The Chapter is played beginning from the desired time just after you enter the time. If not prohibited by the DVD.

For your convenience:

- You can clear the fields by pressing the **C** button if you enter wrong numbers.
- If you attempt to enter a number greater than the total time of the current title, the time search box disappears, "[O] Input Invalid" message is displayed on screen.
- If you wait five seconds without pressing any key to enter time, selecting scenes by time option is cancelled.
- You can press **RETURN** key to cancel time search.

Repeat Play

Repeat Viewing

Press **REPEAT** during play.

Each time this button is pressed, a different repeat box is displayed on the screen.

- If "**CHAPTER**" is displayed, the current chapter will be played again.
- If "**TITLE**" is displayed, the current title will be played again.
- If "**ALL**" is displayed, all titles and chapters will be played again.

NOTE: Repeat play may be prohibited by some DVD titles.

Repeating two specific points between sections. (A –B repeat)

Press **A-B** during play at the point where repeat play is to commence (A).

"**A**" is displayed.

Press **A-B** again at the point where repeat play is to be concluded (B).

"**AB**" is displayed and the repeat play of the selection between points A and B starts, if not prohibited by the DVD.

To return to normal play

Press **A-B** again.

Convenient Functions

Displaying the time information

Press DISPLAY during play.

Some information is displayed on TV screen to indicate the current status of the disc. On the display screen you can find the following information lines:

Line 1: Time Counter Mode

Line 2: Title Number, Chapter Number, Time Counter

Line 3: Audio Number, Audio Format, Number of Output Channels, Audio Language

Line 4: Subtitle Number & Subtitle Language

Time counter modes can be selected by pressing **TIME** key consecutively.

The sequence for time counter modes is as follows: TITLE ELAPSED, TITLE REMAIN, CHAPTER ELAPSED and CHAPTER REMAIN.



- If "TITLE ELAPSED" is displayed, the elapsed time for the title is being displayed.
- If "TITLE REMAIN" is displayed the remaining time for the title is being displayed.
- If "CHAPTER ELAPSED" is displayed, the elapsed time for the chapter is being displayed.
- If "CHAPTER REMAIN" is displayed, the remaining time for the chapter is being displayed.

Pressing the **TIME** key for the fifth time closes display menu screen. "DISPLAY OFF" is displayed.

Displaying a scene with a larger and closer view

The 'zoom in' function enables you to take a closer look at the scene you are viewing that is especially an impressive function when you are seeing science fiction or adventure film.

Press **ZOOM** during play.

" 2X" is displayed on the screen and the picture is now larger. By pressing **ZOOM** key consecutively you can reach " 3X", " 4X" modes.

NOTE: You can move in the picture, i.e. change the zoomed location, by using the **< (Left) / > (Right) / √ (Down) / ▲ (Up)** arrow keys.

To return to normal play

Press **ZOOM** again.

Displaying / Changing Subtitle Language

It is possible to change the subtitle language from the one selected at the initial settings to a different language, if available.

(This operation works only with discs on which multiple subtitle languages are recorded.)

Press **SUBTITLE** during play.

When no subtitles are recorded "" will be displayed instead of the selected language.

Press SUBTITLE a number of times until the preferred language is selected.

When this button is pressed once, the first subtitle recorded on the disc will display. The rest of the subtitles recorded will display in sequence for every press of the **SUBTITLE** button.

NOTE:

- In some cases, the subtitle language is not changed immediately to the selected one.

For your convenience:

- When the preferred language is not selected even after pressing the button several times, it means that the language is not available on the disc.
- When the player is restarted or the disc is changed, the subtitle selection is automatically changed back to the initial settings.
- If a language is selected, which is not supported by the disc, the subtitle language will automatically be set to the disc's priority language.
- Usually a circulation will happen while switching to another language, that is you can cancel the subtitle by pressing this button a number of times until "Subtitle Off" appears on the screen.

Changing Audio Soundtrack Language

It is possible to change the audio language from the one selected at the initial settings to a different language, if available.

(This operation works only with discs on which multiple audio soundtrack languages are recorded, if not prohibited by the DVD.)

Press **AUDIO** during play.

Press AUDIO a number of times until the preferred language is selected.

For your convenience:

- When the preferred language is not selected even after pressing the button several times, it means that the language is not available on the disc.
- When the power is turned on or the disc is removed, the language heard is the one selected at the initial settings. If this language is not recorded on the disc, only the available language on the disc will be heard.

Viewing From Another Angle

Some DVD discs may contain scenes, which have been shot simultaneously from a number of different angles. For these discs, the same scenes can be viewed from each of these different angles using the ANGLE button.

The number of recorded angles differs depending on the disc used.

“ y/x ” is displayed shortly on the screen during playback. This indicates that the multi-angle scene has just started. From that moment on, the yth angle of total x angles is played and you can change the viewing angle until the end of the multi-angle scene.

- In **SETUP** menu, an ‘ANGLE MARK’ option exists, which, if enabled, will display a continuous angle mark on the screen as long as multi-angle scene is available.

Press ANGLE during play.

The current angle is changed.

Press ANGLE a number of times until the preferred viewing angle is selected.

- This function will only work on discs where different angles have been recorded.

Using a DVD Menu

Some DVD discs have unique menu structures called DVD menus. For example, DVDs programmed with complex contents provide guide menus, and those recorded with various languages provide menus for audio and subtitle language. Although the DVD menus’ contents and operation differ from disc to disc, the following explains basic operation when this feature is used.

Press TITLE or MENU on the remote control.

The DVD menu available on the disc is now displayed.

NOTE:

- If you press MENU, the root menu of DVD is displayed.
- If you press TITLE, the menu of the current title is displayed.

Press ◀ / ▶ / ▼ / ▲ to select the preferred item.

Press SELECT.

The selected item is now executed.

For your convenience:

- You can also use **number** keys to select a DVD menu item. The player will automatically execute the item. To enter an item number which is more than 1 digit, press **+10** key and

then enter the item number.

NOTE:

- Some DVDs may not contain root and/or title menus.
- To resume the playback, select PLAY item in DVD menu.

CD Menu

CD Menu is used to display the directory structure of data discs which would contain files such as JPEG/MPEG/MP3 and to display the tracks of Audio CDs.

Basic Play

1. Please insert a CD-R disc to the loader.

“Loading” message appears on screen. Please wait for a moment.

CD MENU appears. Directories and the files in the root directory are listed. (For Audio CD, the tracks are listed.)

2. Press ▼ / ▲ to select files or directories.

In the stop mode or while playing MP3 the user can navigate in the current directory.

3. Press SELECT, ◀ / ▶ to switch between directories & files.

If a directory is selected and SELECT or “▶” key is pressed then the selected directory content is displayed after reading directory.

To switch from a sub directory to an upper directory, press SELECT or “▶” key while the top-most option in the directory (“...”) is selected or press “◀”.

4. Press SELECT on a file to play.

MP3/MPEG File :

Selected MP3 / MPEG starts to play.

Elapsed or Remaining Time can be displayed using DISPLAY key and can be changed using TIME key.

JPEG File :

Selected JPEG is displayed in full screen and Slide Show starts automatically.

Audio CD Track:

Elapsed or Remaining Time can be displayed using DISPLAY key and can be changed using TIME key.

PAUSE

Press PLAY/PAUSE (▶/||) once during play.

The play freezes.

PAUSE message appears on screen.

To return to normal play press PLAY/PAUSE (▶/||) again.

Stopping Play

Press STOP (■).

The play is stopped.

NOTE: If a JPEG file is displayed, pressing MENU also stops the play.

MP3/MPEG: CD MENU is displayed.

Rapid Advance (Rapid Reverse)

MP3/MPEG Track:

Press SEARCH/SLOW (◀◀ or ▶▶) during play to decrease/increase play speed.

◀◀ 32x, ◀◀ 16x, ◀◀ 8x, ◀◀ 4x, ◀◀ 2x, PLAY, ▶▶ 2x, ▶▶ 4x, ▶▶ 8x, ▶▶ 16x, ▶▶ 32x are the play speed modes.

Skipping Ahead or Back to Tracks

Press SKIP/ FRAME (◀◀◀ / ▶▶▶) during play to jump to the previous/next file.



Next file in the current directory will be played. Press SKIP/ FRAME (◀◀◀ / ▶▶▶) during stop mode to jump to the previous/next page of the current directory.

ZOOM

MPEG:

This "zoom in" function enables you to take a closer look at the scene you are viewing that is especially an impressive function when you are seeing science fiction or adventure film.

Press ZOOM during play.

" 2X" is displayed on the screen and the picture is now larger. By pressing ZOOM key consecutively you can reach " 3X", " 4X" modes.

NOTE: You can move in the picture, i.e. change the zoomed location, by using the ◀ (Left) / ▶ (Right) / ▼ (Down) / ▲ (Up) arrow keys.

To return to normal play;

Press ZOOM again.

JPEG:

Press PLAY (▶) to start slide show.

It is provided both ZOOM in/out and Zoom pan functions for JPEG pictures.

Press ZOOM to turn on/off this function.

When this mode is on, a message will indicate the current ratio on screen.

If zoom mode is on,

Press ▶▶ / ◀◀ to control the ratio of zoom in/out.

The zoom ratios are %50 and %75 for zoom out and %100, %125, %150 and %200 for zoom in. (The order is: %50, %75, %100, %125, %150, %200)(The initial ratio is %100)

With ZOOM mode off, a picture is scaled to fit the whole screen.

Note:

- Slide Show is disabled when the ZOOM mode is on.

REPEAT

Press REPEAT to change current repeat mode.

In CD MENU it is displayed at the bottom.

The options available are:

FOLDER: When this mode is selected, the current folder will be played once.

SINGLE: When this mode is selected, the current track will be played once.

REPEAT ONE: When this mode is selected, the current track will be repeated continuously.

REPEAT FOLDER: When this mode is selected, the current folder will be repeated continuously.

Repeating two specific points between sections. (A –B repeat)

MP3, Audio CD Track:

Press A-B during play at the point where repeat play is to commence (A).

" A" is displayed on screen.

Press A-B again at the point where repeat play is to be concluded (B).

" AB" is displayed and the repeat-play of the selection between points A and B starts.

To return to normal play

Press A-B again. A-B Repeat is disabled.

Display Function

Press TIME to change displayed time mode.

There are two time modes :

- Single Elapsed
- Single Remain

Time is displayed during MP3,MPEG and Audio CD track playback.

File List Function

Press PROG to select file list mode

All the files in the disc are listed.

The same types of files in the list are played together sequentially.

If a MP3 file is selected to play then all the MP3 files in the list are played sequentially.

If a MPEG file is selected to play then all the MPEG files in the list are played sequentially.

If a JPEG file is selected to display then all the JPEG files in the list are displayed sequentially.

To stop the playback of the files:

If a MP3/MPEG file is played; press STOP (■).

If a JPEG file is displayed; press MENU or **STOP** (■).

Press **PROG** to quit file list mode.

Setup Menu

Press DISPLAY key on the remote control when the player is not in playback mode.

The setup menu-main page appears. To close the setup menu, press **DISPLAY** key.

MAIN PAGE

In the main page, the first page is selected by default.

Select pages using ◀ / ▶ arrow buttons.

When selected, the page will be highlighted and the items of the selected page will be displayed.

Press **SELECT** or ▼ arrow button to enter selected page.

When entered a page, the first item of the page is selected and the sub-items of that item are listed on the right.

NOTE: To return to main page, press ◀ arrow button. To close the setup menu, press **DISPLAY** key.

USING PAGES

When entered a page, the first item of the page is selected by default and the sub-items of the selected item are listed on the right.

Use ▼ / ▲ arrow buttons to change the selected item in the page.

The sub-items of the selected item are listed on the right.

Press **SELECT** or ▶ arrow button to select the sub-items of the selected item.

The sub-item is selected on the right menu.

Use ▼ / ▲ arrow buttons to change the selected sub-item.

Press **SELECT** to choose the selected sub-item on the right menu.

MENU ITEMS

VIDEO SETUP PAGE

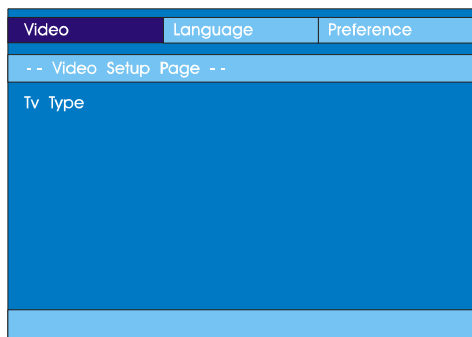

TV TYPE:

TV Type is only available as 'PAL'.

LANGUAGE SETUP

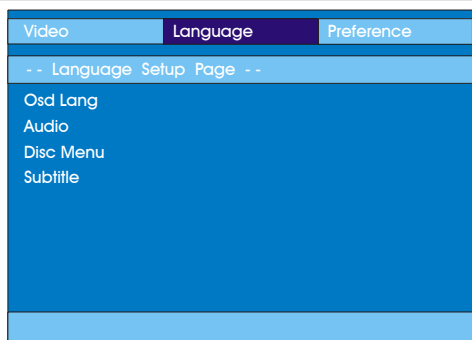

OSD LANG:

You can select the default OSD language of the player menus

AUDIO:

You can select the default audio language if supported by the DVD disc.

DISC MENU:

You can select the DVD's disc menu language among these languages. Disc menu appears in the selected language, if supported by the DVD disc.

SUBTITLE:

You can select the default subtitle language if supported by the DVD disc.

PREFERENCES

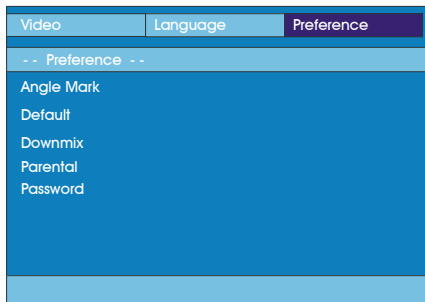

ANGLE MARK:

This option allows you to turn on/off the angle mark on the screen, which is displayed to indicate that a multi angle scene has started. It also shows which angle you are currently watching.

DEFAULT:

If you choose **RESET** and press **SELECT**, the factory-presets are loaded. Parental level and parental password does not change.

DOWNMIX:

This mode can be selected when the digital audio output of the TV is used.

SURROUND: Surround sound output.

STEREO: Two channels stereo.

PARENTAL (Parental Level):

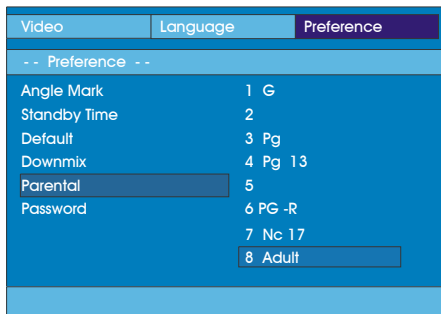

Playing some DVDs can be limited depending on the age of users. The “Parental Control” function allows playback limitation level to be set by the parent.

Parental Level can be adjusted to one of the eight levels. Level “8 ADULT” adjustment let you watch all of the DVD titles ignoring the DVD disc’s parental level. You can watch the DVD discs, which has the same or lower parental level than the player’s level only.

PASSWORD (Change Password):

Using this item you can change the current password.

To change the password you will be prompted to enter your old password. After you have entered your old password, you can now enter the new 4-digit password.

You can use **C** key to delete the incorrect entry.

Note: Factory preset of the password is “0000”. You have to enter XXXX digital password every time you want to change the parental level. If you forget your password please contact technical service.

Troubleshooting

The picture quality is poor (DVD)

- Make sure the DVD disc surface is not damaged. (Scratch, fingerprint etc.)
- Clean the DVD disc and try again.
 - See instructions described in “Notes on Discs” to clean your disc properly.
- Ensure that the DVD disc is in the drawer with the label uppermost.
- A damp DVD disc or condensation may effect the equipment. Wait for 1 to 2 hours in Stand-by to dry the equipment.

Disc does not play

- No disc in the machine.
 - Place a disc into the loader.
- Disc incorrectly loaded.
 - Ensure that the DVD disc is in the drawer with the label uppermost.
- Wrong type of disc. The machine cannot play CD-ROMS etc.
- The region code of the DVD must match the player.

Wrong OSD language

- Select the language in the set-up menu. The language for the sound or subtitles on a DVD cannot be changed.

- Multilingual sound and/or subtitles not recorded on the DVD.
- Try to change the sound or subtitles using DVD’s title menu. Some DVD’s do not allow the user to change these settings without using the disc’s menu

Some functions (Angle, Zoom etc) do not work

- These functions are not available on the DVD.
- Angle can only be changed when the angle symbol is displayed.

No picture

- Have you pressed the correct buttons on the remote control? Try once more.

No sound

- Check the volume is set to an audible level.
- Make sure you have not switched the sound off accidentally.

Distorted sound

- Check that the appropriate listening mode setting is correct.

No response from remote control

- Make sure the remote control is in the correct mode.
- Check batteries are fitted correctly.
- Change the batteries.

If nothing works

If you have tried the above solutions and none seem to work, try switching your TV-DVD off and on again. If this does not work, contact your supplier or TV-DVD repair technician. **Never attempt to repair a defective TV-DVD yourself.**

Definition of Terms

Angle

Recorded onto some DVD discs are scenes, which have been simultaneously shot from a number of different angles (the same scene is shot from the front, from the left side, from the right side, etc.). With such discs, the ANGLE button can be used to view the scene from different angles.

Chapter Number

These numbers are recorded on DVD discs. A title is subdivided into many sections, each of which are numbered, and specific parts of video presentations can be searched quickly using these numbers.

DVD

This refers to a high-density optical disc on which high-quality pictures and sound have been recorded by means of digital signals. Incorporating a new video compression technology (MPEG II) and high-density recording technology. DVD enables aesthetically pleasing full-motion video to be recorded over long periods of time (for instance, a whole movie can be recorded).

DVD has a structure consisting of two 0.6-mm thin discs, which are adhered to each other. Since the thinner the disc, the higher the density at which the information can be recorded, a DVD

disc has a greater capacity than a single 1.2 mm thick disc. Since the two thin discs are adhered to each other, there is the potential to achieve double-sided play sometime in the future for even longer duration play.

Playback Control

This is recorded on a Video CD (Version 2.0). The scenes or information to be viewed (or listened to) can be selected interactively with the TV monitor by looking at the menu shown on the TV monitor.

Subtitles

These are printed lines appearing at the bottom of the screen, which translate or transcribe the dialogue. They are recorded on the DVD discs.

Time Number

This indicates the playtime, which has elapsed from the start of a disc or a title. It can be used to find a specific scene quickly. (Not all discs permit the time search feature to be used. Availability is determined by the disc's manufacturer.)

Title Number

These numbers are recorded on DVD discs. When a disc contains two or more movies, these movies are numbered as title 1, title 2, etc.

Track Number

These numbers are assigned to the tracks, which are recorded on AudioCDs. They enable specific tracks to be located quickly.

Dolby Digital

Many movie theatres are equipped with 5.1 channel surround systems. This same type of technology is available to you in your home. To enjoy full 5.1-channel surround, your DVD player must be connected to an external Dolby Digital decoder via the digital outputs (either coaxial or optical).

Dolby Pro Logic

This is Dolby Laboratories' technology to decode Dolby Surround encoded programs actively. Dolby Surround programs have four channels of audio (Left, Center, Right and Surround) encoded into a standard 2-channel stereo signal. The rear channel is monaural.

LPCM

LPCM stands for Pulse Code Modulation and is digital audio.

MPEG

Short for Moving Picture Experts Group. This is an international standard for compression of moving images. On some DVDs digital audio has been compressed and recorded in this format.

Specifications

DVD / CD / CD-R / CD-RW / MP3 / JPEG / MPEG player,

Types of Discs Supported	<p><u>DVD:</u> SS/SL 4.7" (DVD-5) SS/DL 4.7" (DVD-9) DS/SL 4.7" (DVD-10) DS/DL 4.7" (DVD-18)</p> <p><u>CD-DA</u> <u>CD-R</u> <u>CD-RW</u> <u>MP-3/JPEG</u></p>
Video Type	<p>MPEG-2 Video Standard Decoding (MPEG-1 supported) Full-Screen Video Display of 720 x 576 (PAL) pixels 50 and 60 Hz frame refresh rates (PAL) Digital bit-stream processing rate up to 108Mbits/sec Line resolution more than 500 lines</p>
Audio Type	<p>Dolby Digital Decoding LPCM</p>
Audio Output	<p><u>Digital Audio Outputs:</u> IEC 958 TOSLINK</p> <p><u>Analog Outputs:</u> 24 bit /48, 44.1kHz down-sampling DAC</p>

THE GUARANTEE

The seller of this equipment (the vendor) warrants to the initial retail purchaser that if the equipment becomes defective, and the defect is shown to be due to faulty materials or workmanship within a period of 12 Months from the date of sale to the original purchaser it will be repaired (or at the vendors sole option) replaced free of charge, always providing that: The equipment has at all times been used in accordance with the operating instructions issued by the manufacturer, and has not been connected to an electrical supply for which it has not been properly adjusted.

Unauthorised repairs or modifications, which have not been expressly approved by the manufacturer, shall render this guarantee null and void.

This guarantee is not transferable and is only applicable in the UK.

Nothing in this express warranty affects the statutory rights available to the purchaser of this equipment

EXCLUSIONS

SANYO shall not be liable for any removal or installation or re-installation of the equipment.

The warranty does not cover Failure due to fair wear and tear of any item.

Cosmetic items, remote controls or parts and consumable items such as lamps, filters, batteries, tapes, cables or connectors.

Accidental damage or damage caused by negligence or misuse by the user.

Failure caused by lightning strike, storage or operation outside the specified environment, incorrect installation, lack of routine maintenance outlined in the operating instructions supplied with the unit, incorrect fitting of lamps, filters, batteries or other consumables or parts.

Units not originally supplied by SANYO Europe Ltd through a UK Reseller.

Dear Customer.

Thank you for buying SANYO. This equipment should give you many years of pleasure and faithful service but in the event that a fault occurs, the following notes for your guidance may be helpful:-

- 1: PLEASE RETAIN YOUR PURCHASE RECEIPT WHICH WILL BE REQUIRED FOR SERVICE DURING WARRANTY.
- 2: If your SANYO equipment proves faulty during the period of guarantee, take it or send it back to the dealer who originally supplied it together with this guarantee and the proof of purchase. We have made arrangements with our approved dealers under which they will carry out in guarantee service repairs on our behalf. In this way, we hope to reduce to a minimum the amount of time you will be without your equipment.
- 3: If for some reason it is impossible to return the equipment to the original supplier, please contact our Customer Relations Department at the address below for further advice.
- 4: Should the equipment require servicing after the expiry of the guarantee period, take or send it to the original supplier or any other Sanyo dealer. He will be pleased to give you a quotation for the repair.

Customer Relations Department,
SANYO Europe Ltd.
SANYO House,
18, COLONIAL WAY,
Watford, Hertfordshire, WD24 4PT.
Tel: 01923 246363

Manufacturer and Address

SANYO Electric Co., Ltd.
5-5, Keihan-hondori, 2-chome, Moriguchi City, Osaka, Japan

Authorized Representative and Address

SANYO FISHER Sales (Europe) GmbH
Stahlgruberring 4, D-81829 Munich, Germany



SANYO

SANYO Electric Co., Ltd.

