



**Contact SAMSUNG WORLD WIDE**

If you have any questions or comments relating to Samsung products, please contact the SAMSUNG customer care centre.

Country	Customer Care Centre ☎	Web Site
EIRE	0818 717100	www.samsung.com
U.K	0330 SAMSUNG (7267864)	www.samsung.com



# LED TV

## user manual

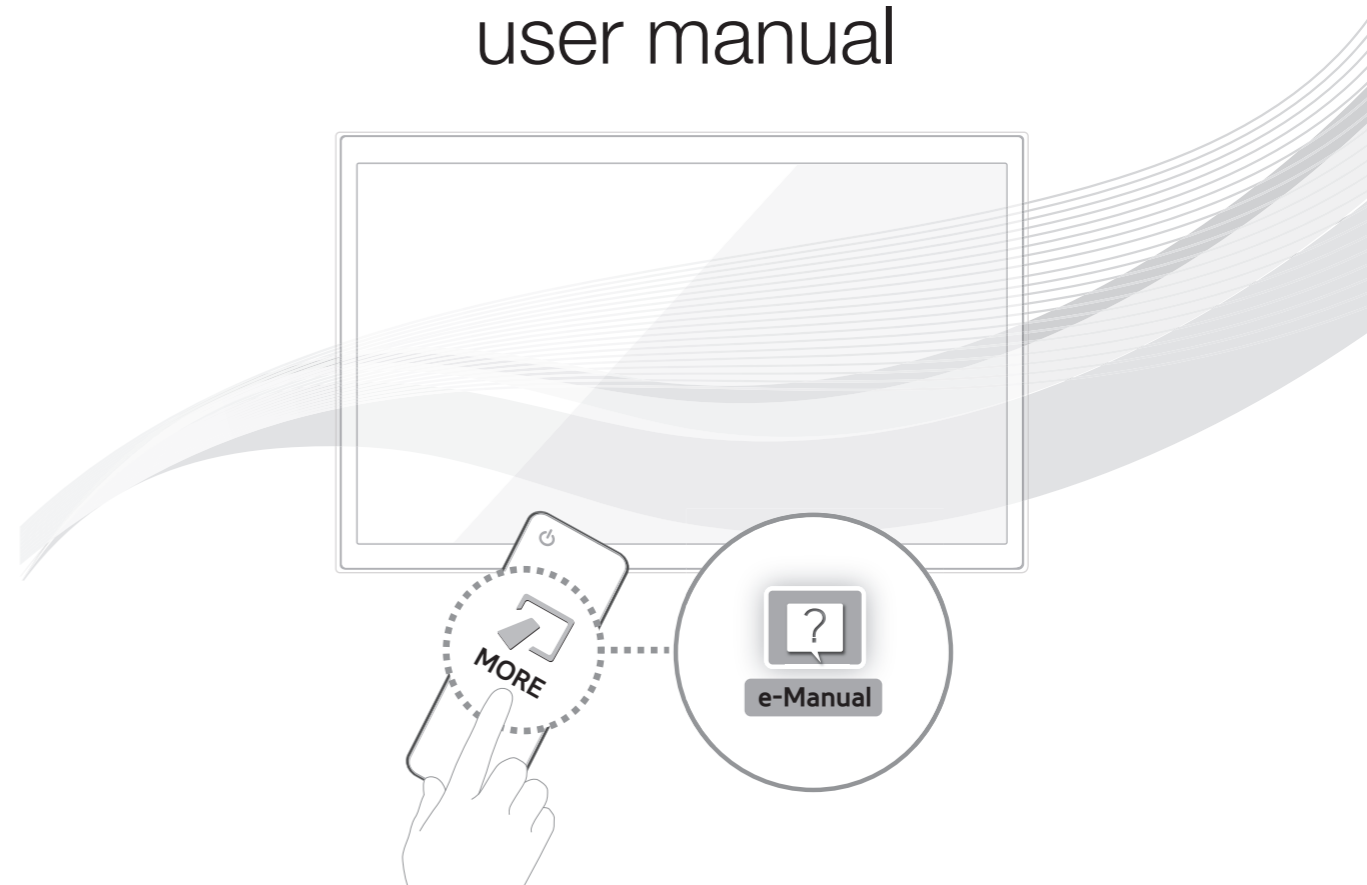

Thank you for purchasing this Samsung product.  
To receive more complete service, please register  
your product at

[www.samsung.com/register](http://www.samsung.com/register)

Model \_\_\_\_\_ Serial No. \_\_\_\_\_



# Important Safety Instructions

**SAMSUNG**

## Warning! Important Safety Instructions

(Please read the appropriate section that corresponds to the marking on your Samsung product before attempting to install the product.)

### CAUTION

#### RISK OF ELECTRIC SHOCK DO NOT OPEN

CAUTION: TO REDUCE THE RISK OF ELECTRIC SHOCK, DO NOT REMOVE COVER (OR BACK). THERE ARE NO USER SERVICEABLE PARTS INSIDE. REFER ALL SERVICING TO QUALIFIED PERSONNEL.



This symbol indicates that high voltage is present inside. It is dangerous to make any kind of contact with any internal part of this product.



This symbol alerts you that important literature concerning operation and maintenance has been included with this product.

- The slots and openings in the cabinet and in the back or bottom are provided for necessary ventilation. To ensure reliable operation of this apparatus, and to protect it from overheating, these slots and openings must never be blocked or covered.
  - Do not cover this apparatus in a confined space, such as a bookcase, or built-in cabinet, unless proper ventilation is provided.
  - Do not place this apparatus near or over a radiator or heat resistor, or where it is exposed to direct sunlight.
  - Do not place a water containing vessel(vases etc.) on this apparatus, as this can result in a risk of fire or electric shock.
- Do not expose this apparatus to rain or place it near water(near a bathtub, washbowl, kitchen sink, or laundry tub, in a wet basement, or near a swimming pool etc.). If this apparatus accidentally gets wet, unplug it and contact an authorized dealer immediately. Make sure to pull out the power cord from the outlet before cleaning.
- This apparatus use batteries. In your community there might be regulations that require you to dispose of these batteries properly under environmental considerations. Please contact your local authorities for disposal or recycling information.
- Do not overload wall outlets, extension cords or adaptors beyond their capacity, since this can result in fire or electric shock.
- Power-supply cords should be routed so that they are not likely to be walked on or pinched by items placed upon or against them, paying particular attention to cords at plug end, adaptors and the point where they exit from the appliance.
- To protect this apparatus from a lightning storm, or when it is left unattended and unused for long periods of time, unplug it from the wall outlet and disconnect the antenna or cable system. This will prevent damage to the set due to lightning and power line surges.
- Before connecting the AC power cord to the DC adaptor outlet, make sure the voltage designation of the DC adaptor corresponds to the local electrical supply.
- Never insert anything metallic into the open parts of this apparatus. Doing so may create a danger of electric shock.
- To avoid electric shock, never touch the inside of this apparatus. Only a qualified technician should open this apparatus.
- Make sure to plug the power cord in until it is firmly inserted. When removing the power cord, make sure to hold the power plug when pulling the plug from the outlet. Do not touch the power cord with wet hands.
- If this apparatus does not operate normally - in particular, if there are any unusual sounds or smells coming from it - unplug it immediately and contact an authorized dealer or service centre.
- Be sure to pull the power plug out of the outlet if the TV is to remain unused or if you are to leave the house for an extended period of time (especially when children, elderly or disabled people will be left alone in the house).
  - Accumulated dust can cause an electric shock, an electric leakage or a fire by causing the power cord to generate sparks and heat or the insulation to deteriorate.
- Be sure to contact an authorized service centre, when installing your set in a location with heavy dust, high or low temperatures, high humidity, chemical substances and where it operates for 24 hours such as the aerial port, the train station etc.
- Failure to do so may cause serious damage to your set.
- Use only a properly grounded plug and receptacle.
  - An improper ground may cause electric shock or equipment damage. (Class I Equipment only.)
- To disconnect the apparatus from the mains, the plug must be pulled out from the mains socket, therefore the mains plug shall be readily operable.
- Do not allow children to hang onto the product.
- Store the accessories (battery, etc.) in a location safely out of the reach of children.
- Do not install the product in an unstable location such as a shaky shelf, a slanted floor or a location exposed to vibration.
- Do not drop or impart any shock to the product. If the product is damaged, disconnect the power cord and contact a service centre.
- Unplug the power cord from the power outlet and wipe the product using a soft, dry cloth. Do not use any chemicals such as wax, benzene, alcohol, thinners, insecticide, aerial freshener, lubricant or detergent. This may damage the appearance or erase the printing on the product.
- Apparatus shall not be exposed to dripping or splashing.
- Do not dispose of batteries in a fire.
- Do not short circuit, disassemble or overheat the batteries.
- Danger of explosion if battery is incorrectly replaced. Replace only with the same or equivalent type.
- **WARNING - TO PREVENT THE SPREAD OF FIRE, KEEP CANDLES OR OTHER OPEN FLAMES AWAY FROM THIS PRODUCT AT ALL TIMES.**



English - 2

# Contents

## Basic Features

- 6 Using the Smart Touch Control
  - 7 Connecting to the TV
  - 7 Inserting the Batteries (AAA X 2)
  - 8 Using the touchpad
  - 8 Changing Channels by Entering Numbers
  - 9 Show Status and Notification Banner
  - 9 Recommendations
  - 9 History
  - 9 Searching
  - 9 Adjusting the Touchpad
  - 9 Using the Virtual Remote Control
- 10 Using the Remote Control
  - 11 Installing batteries (Battery size: AAA)
- 11 Turning on the TV
- 12 Built-in TV Camera and Microphone
  - 12 Extending the TV Camera
  - 12 Retracting the Camera
- 13 Universal Remote Setup
  - 13 Add the External Device
- 13 The Evolution Kit Slot (Kit Sold Separately)
- 14 SETUP
- 15 Switching Between Video Sources
- 16 Connecting to a COMMON INTERFACE slot  
(Your TV viewing Card Slot)
- 17 Viewing the e-Manual
  - 17 Scrolling a Page
  - 17 Using the Icons at the Top of the Page

## Network Configuration

- 18 Connecting to a Network
  - 18 Network Connection - Wireless
  - 18 Wireless Network Precautions
  - 18 Network Security Protocols
  - 19 Network Connection - Wired

## 3D Basics

- 20 3D Active Glasses
  - 20 Pairing 3D Active Glasses
  - 22 Watching 3D Video

## Troubleshooting and Other Information

- 23 What is Remote Support?
- 23 Assembling the Cable manager
- 23 Assembling the Power Cover
- 24 Troubleshooting
- 24 Mounting the TV on the Wall Using  
the Wall Mount Kit (Optional)
- 26 Storage and Maintenance
- 26 Providing Proper Ventilation for Your TV
- 27 Eco Sensor and Screen Brightness
- 27 Tip Prevention – Securing the TV to the Wall

## Specifications

- 30 Specifications - TV

## Guides

- 31 Licences
- 32 Warranty Card
  - 33 Wiring the Mains Power Supply Plug (UK Only)

Figures and illustrations in this User Manual are provided for reference only and may differ from the actual product appearance. Product design and specifications may change without notice.

CIS languages (Russian, Ukrainian, Kazakhs) are not available for this product, since this is manufactured for customers in EU region.

## Features for your new TV

- **3D:** This new feature enables you to view 3D content.
- **SMART HUB:**

This TV features Smart Hub, a multi-purpose entertainment and family centre. With Smart Hub, users can surf the web, download applications, and stay in touch with family and friends through social networking services. In addition, you can enjoy photo, video, and music files stored on external storage devices.

Press the  button to launch Smart Hub. Choose a service using the icons displayed in the top part of the screen.

**Social:** Watch the latest YouTube videos and you and your friends' video posts on Facebook and Twitter. You can also make video calls to friends by the TV camera.

**Apps:** Download and install applications such as Web Browser.

**On TV:** **On TV** recommends TV programmes based on their popularity or your personal preferences. (Depending on the country)

**Films and TV Shows:** Purchase and watch movies and series without a separate external device. (Depending on the country)

**Photos, Videos & Music:** Play back photo, video, and music files from an external storage device.

- **Anynet+ (HDMI-CEC):** This allows you to control all connected Samsung devices that support Anynet+ with your Samsung TV's remote.
- **e-Manual:** Provides a detailed, on-screen user's manual built into your TV. (page 17)
- **SMART Interaction:** Using this function, you can access and control menu options and functions using motions.
- **Device Manager:** Use the TV features with a USB or Bluetooth keyboard and mouse.
- **MHL & Screen Mirroring:** Displays mobile device screens on your TV using a wired or wireless connection.



### Correct Disposal of This Product (Waste Electrical & Electronic Equipment) (Applicable in countries with separate collection systems)

This marking on the product, accessories or literature indicates that the product and its electronic accessories (e.g. charger, headset, USB cable) should not be disposed of with other household waste at the end of their working life. To prevent possible harm to the environment or human health from uncontrolled waste disposal, please separate these items from other types of waste and recycle them responsibly to promote the sustainable reuse of material resources.

Household users should contact either the retailer where they purchased this product, or their local government office, for details of where and how they can take these items for environmentally safe recycling.

Business users should contact their supplier and check the terms and conditions of the purchase contract. This product and its electronic accessories should not be mixed with other commercial wastes for disposal.



### Correct disposal of batteries in this product (Applicable in countries with separate collection systems)

This marking on the battery, manual or packaging indicates that the batteries in this product should not be disposed of with other household waste at the end of their working life. Where marked, the chemical symbols Hg, Cd or Pb indicate that the battery contains mercury, cadmium or lead above the reference levels in EC Directive 2006/66. If batteries are not properly disposed of, these substances can cause harm to human health or the environment.

To protect natural resources and to promote material reuse, please separate batteries from other types of waste and recycle them through your local, free battery return system.

# Accessories

- ✎ Please make sure the following items are included with your TV. If any items are missing, contact your dealer.
- ✎ The items' colours and shapes may vary depending on the models.
- ✎ Cables not included in the package contents can be purchased separately.
- ✎ Check that there is no accessory hidden behind packing materials when you open the box.

- Smart Touch Control & Batteries (AAA x 2)
- Remote Control & Batteries (AAA x 2)
- User Manual
- Regulatory Guide
- Power Cord
- Samsung 3D Active Glasses

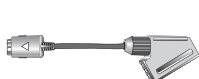

Scart Adapter



IR Extender Cable



AV Adapter



Component adapter

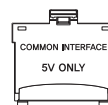

CI Card Adapter



Power cover



Wall mount adapter x 2



TV-Holder Kit

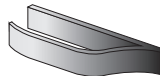

Cable manager

- An administration fee may be charged if either
  - (a) an engineer is called out at your request and there is no defect in the product (i.e. where you have failed to read this user manual)
  - (b) you bring the unit to a repair centre and there is no defect in the product (i.e. where you have failed to read this user manual).
- The amount of such administration charge will be advised to you before any work or home visit is carried out.



**Warning:** Screens can be damaged from direct pressure when handled incorrectly. We recommend lifting the TV by the edges, as shown.

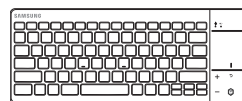
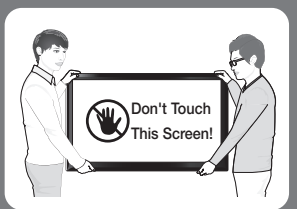

Wireless Keyboard (Sold Separately)

# Using the Smart Touch Control

You can use the MIC to give **Voice Recognition** commands. Simply press the **VOICE** button.

**Voice Recognition** function can be affected by unclear pronunciation, voice level, or surrounding noise.

Turns the TV on and off (page 11).

Displays and selects the available video sources (page 15).

Cuts off the sound temporarily.

Press and hold this button to select **Audio Description** and **Subtitle**. (Depending on the country or region.)

Adjusts the volume.

This button toggles between the Recommended and Search functions (page 9).

The colour buttons work differently, depending on the function that the TV is currently performing.

Press and hold the button while watching TV to view information about the current programme.

Returns to the previous menu.

Press and hold this button to exit all currently running applications.

Brings up Smart Hub applications. See the e-Manual chapter, **Smart TV Features > Smart Hub**.

To exit an application that is running, press the button.

Turn on and off the satellite or cable set-top box connected to the TV. For this, the Smart Touch Control must be configured as a universal remote control (page 13).

**VOICE** Take your voice command and enter a text using your voice.

Changes channels.

Displays a virtual remote panel on the screen. See the e-Manual chapter, **Controlling TV > Using the Virtual Remote Control**. Pressing and holding the **MORE** button takes the user to the Virtual Remote Control's Quick Access Panel (page 9).

Touch Pad (page 8).

- Drag on the Touch Pad to move the cursor on the screen.
- Press the Touch Pad to run, activate, or select the highlighted item.
- Press and hold the touch pad to display the **Channel List**.

View each digital channel's programming schedule, including showtimes. In addition, sets a **Schedule Viewing** or **Schedule Recording** to press the touch pad on the programme entry scheduled to air later.

## Connecting to the TV

In order to operate the TV using a Smart Touch Control unit, you must first pair it to the TV via Bluetooth. However, the Smart Touch Control is only available for the paired Samsung TV.

 We recommend to use the Smart Touch Control in less than 6m. A usable distance may differ depending on the wireless environmental conditions.

1. When the TV is off, point the Smart Touch Control at the remote control receiver of the TV and press the TV button for the first pairing. Only this button sends an IR signal. The remote control receiver's location may vary depending on the model.
2. A Bluetooth icon will appear at the bottom left of the screen as shown below. The TV will then attempt to connect to the Smart Touch Control automatically.



<Attempting to connect and completion icons>

## Reconnecting the Smart Touch Control

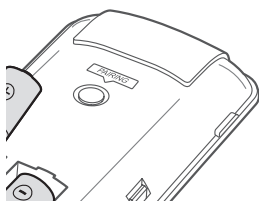

<The Smart Touch Control's pairing button>

If the Smart Touch Control stops operating or works abnormally, replace the battery as this may be caused by insufficient battery power. If the problem persists, press the **PAIRING** button on the Smart Touch Control to restore pairing with the TV. The **PAIRING** button cannot be accessed without removing the Smart Touch Control's battery cover. Within a distance between 30cm to 4m, point the Smart Touch Control to the TV receiver and press the **PAIRING** button. When pairing is complete, the pairing image displays at the bottom left of the TV screen.

## Battery Low Alarm



If the battery becomes low while using the Smart Touch Control, the following alarm window blinks and appears at the bottom left of the screen. If the alarm window pops up, replace the batteries of the Smart Touch Control. Use alkaline batteries for longer usage.



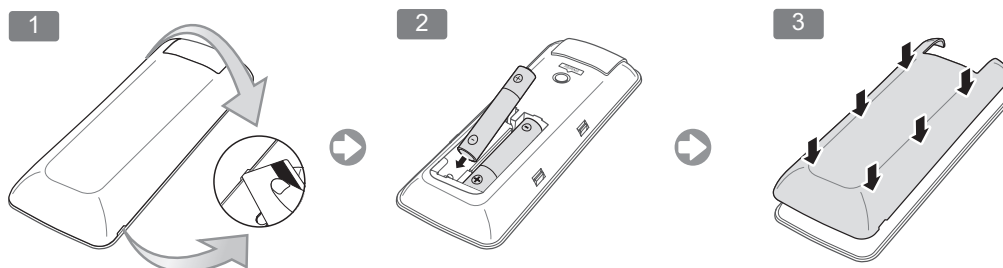

## Inserting the Batteries (AAA X 2)



1. Slightly lift the battery cover using a plastic card. Next, pull on the cover's notch with a fingernail to remove the cover completely.
  -  Check the location of the battery cover groove. The groove's location may vary depending on the type of Smart Touch Control is provided with the product.
2. Insert 2 AAA batteries, making sure to align the positive and negative ends correctly.
3. Align the battery cover with the back of the remote control and press down along the edges until it is cleanly attached to the remote control.

## Using the touchpad

Use the touchpad to perform various commands. Navigate to **Tutorial (System > Device Manager > Smart Touch Control Settings > Tutorial)** to view an on-screen guide to using the Smart Touch Control.

Dragging	Press
	
<p>Drag on the touchpad in the desired direction. Move the focus or the pointer in the direction the finger is dragging.</p>	<p>Press on the touchpad. This selects the highlighted item. When watching TV, pressing and holding the touchpad displays the channel list. On some apps, pressing and holding the touchpad for over 2 seconds displays a list of functions available for the app.</p>
Scrolling Up and Down	Scrolling Left and Right
	
<p>Slide a finger along the ridge on either side of the Touch Pad to scroll up or down in a list or webpage. The ridge on the left side is designed for left-handed users.</p>	<p>Move your finger horizontally on the ridge at the top of the touchpad. You can horizontally scroll a horizontal list or the Smart Hub panel.</p>

## Changing Channels by Entering Numbers

While watching TV, press the ridge on the left or right edge of the touchpad to bring up the numerical input window on the screen. Use your finger to enter the number for the channel you want to watch. The recognised number is displayed on the screen and the TV switches to the corresponding channel. See the e-Manual chapter, **Controlling TV > Touchpad**.

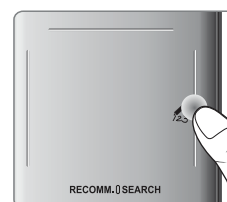

### Numerical Input Guide

Refer to the diagrams below when entering numerical values. The TV may not recognise your entries if you do not follow the sequences shown below.

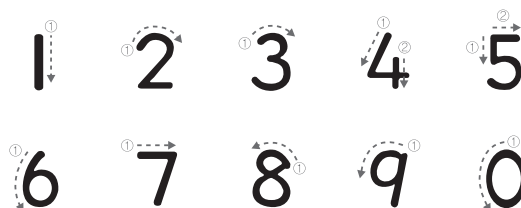



## Show Status and Notification Banner

Press the **MORE** button on the Smart Touch Control and then select **STATUS** on the virtual remote panel to display the status and notification banner at the top of the screen.

## Recommendations

Press the **RECOMM. / SEARCH** button and then select **Recommended** from the list displayed at the bottom of the screen. Select a programme that is currently airing to jump to the corresponding channel or a programme that is scheduled to air to set up a **Schedule Viewing** or **Schedule Recording** setting. Select an application to launch. Samsung Apps will launch if the selected application is not installed on the TV.

## History

Press the **RECOMM. / SEARCH** button and then select **History** from the list displayed at the bottom of the screen. This displays an interactive list of recently accessed channels, media content and applications.

 The **RECOMM. / SEARCH** button may function as a **History** recall feature, depending on your country or region.

### Deleting History Data

You can delete the history information about recently viewed channels, content and applications.

## Searching

Press the **RECOMM. / SEARCH** button on the Smart Touch Control. The list appears at the bottom of the screen. Press the **RECOMM. / SEARCH** button again. The keypad will appear on the screen. Enter search criteria to search not only many apps and their contents on the TV but also the Web. This button toggles between **Recommended** and **Search**.

## Adjusting the Touchpad

Users can adjust the sensitivity of the Smart Touch Control's touchpad. Set **Touch Sensitivity** to adjust sensitivity and make it more convenient to use.

## Using the Virtual Remote Control

Press **MORE** button to display the virtual remote panel on the screen. The virtual remote panel consists of a number panel, a playback control panel, and a quick access panel. Use the touchpad to select numbers and buttons.

 The displayed virtual remote panel on the TV screen may differ depending on the country.

### Changing the Virtual Remote Panel

Choose the number panel, playback control panel, or quick access panel as the panel to be shown on the screen.

Use the touchpad to keep moving the cursor left or right. The panel changes when the cursor is moved beyond the leftmost or rightmost edge.

 Use left/right scroll function on the touchpad to change the panel easily.

### Using the Number Panel

Use the number panel to enter numbers on a keypad screen or webpage or to change the channel while watching TV. Changing the channel using the number pad leaves a record, allowing you to easily return to previous channels.

### Using the Playback Control Panel

Use the playback control panel to pause, rewind, fast forward, skip to the next file, and much more while enjoying media content.

### Using the Quick Access Panel

Quickly access the **INFO**, **MENU** and **e-Manual** buttons. However, the availability of buttons vary depending on the operating mode of the Smart Touch Control unit (with the TV only, as a universal remote, etc.).

# Using the Remote Control

Learn where the function buttons are on your remote. Especially note these: **SOURCE**, **MUTE**, **- ▲ +**, **▲ P ▼**, **MENU**, **TOOLS**, **↔**, **INFO**, **CH LIST**, **RETURN**, **GUIDE** and **EXIT**.

- This remote control has Braille points on the **Power**, **Channel**, and **Volume** buttons and can be used by visually impaired persons.
- Your TV also comes with a Smart Touch Control. For information about the Smart Touch Control, refer to the e-Manual.

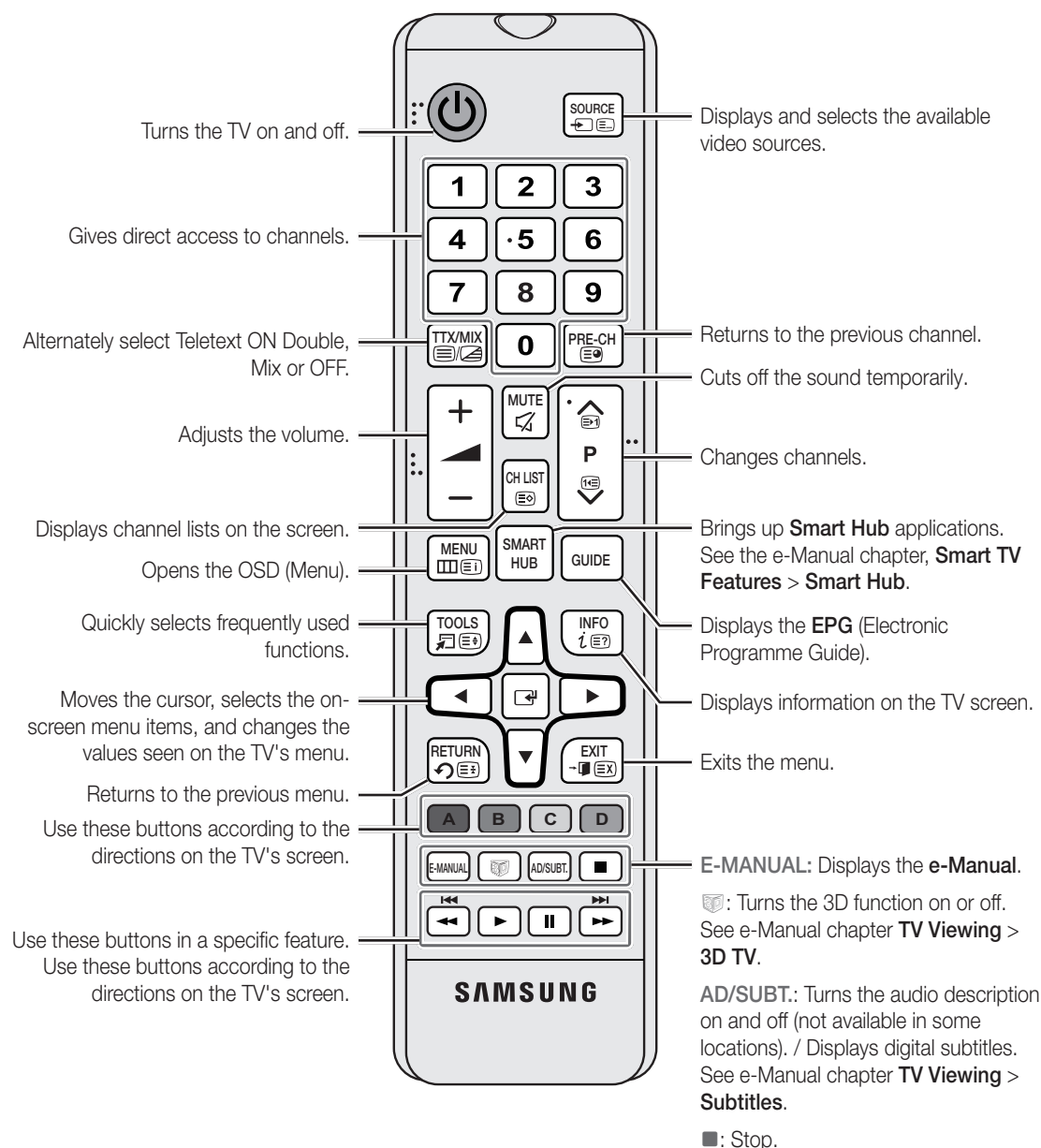

## Installing batteries (Battery size: AAA)

Match the polarity of the batteries to the symbols in the battery compartment.

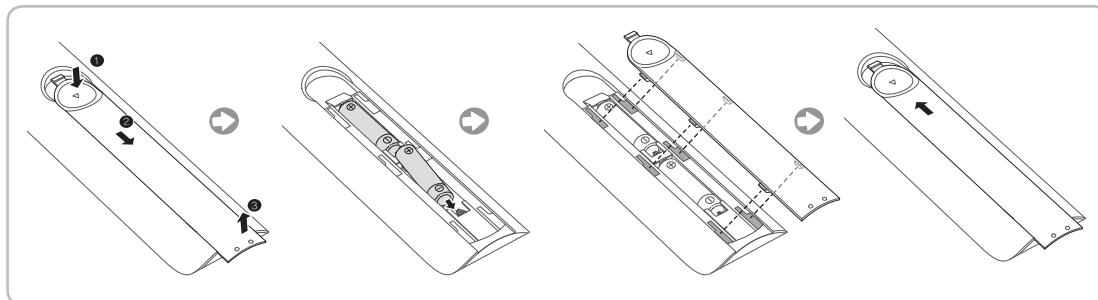

### NOTE

- Use the remote control within 23 feet of the TV.
- Bright light may affect the performance of the remote control. Avoid using when near special fluorescent lights or neon signs.
- The colour and shape may vary depending on the model.

---

## Turning on the TV

Turn on the TV using the  button on the remote control or TV panel.

 The product colour and shape may vary depending on the model.

 The TV's Controller, a small joy stick like button on the rear right side of the TV, lets you control the TV without the remote control.

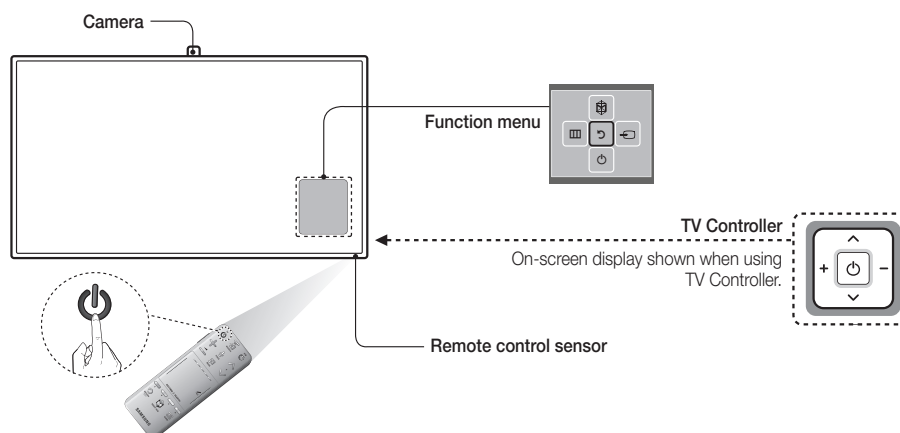

## Built-in TV Camera and Microphone

This TV features a built-in TV camera that can be used for the Motion Control, Voice Recognition (built-in microphone), and Face Recognition features. You can also use the knob for camera's angle adjustment to change the camera's viewing angle.

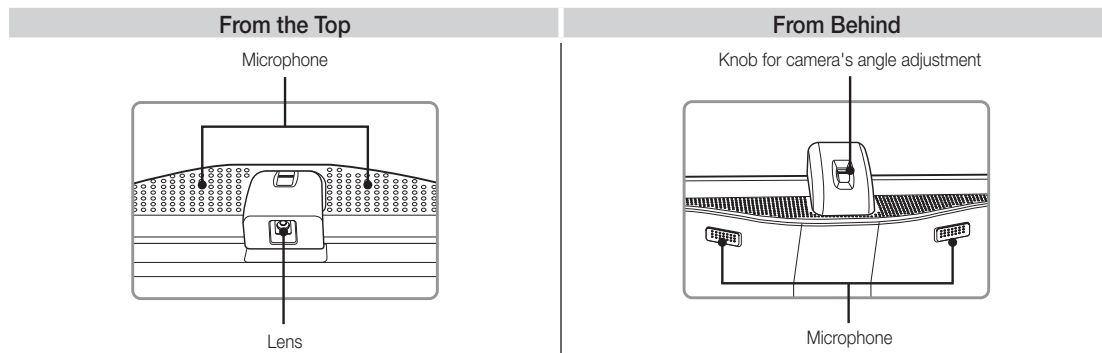

### Extending the TV Camera

In order to use the TV camera, you must first extend it.

Gently push the camera in without touching the lens until you hear a click.

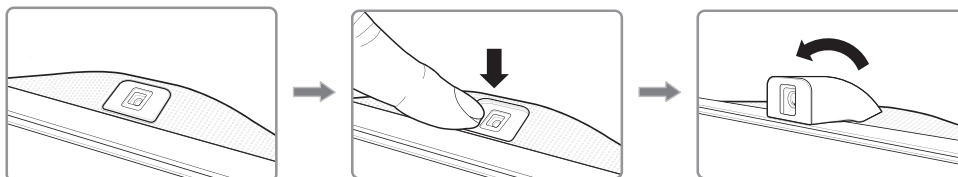

### Retracting the Camera

If you are not using the TV camera, keep it retracted inside the TV. The Motion Control and Face Recognition features cannot be used while the TV camera is in the retracted state, but Voice Recognition will still be available.

Gently push the camera in without touching the lens until you hear a click.

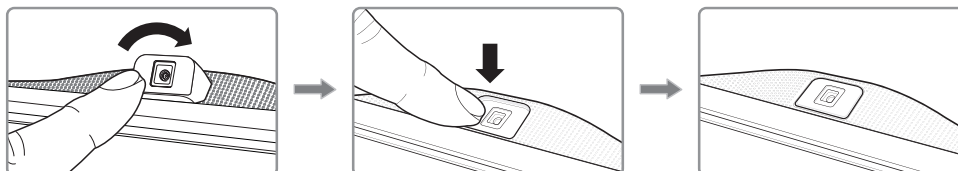

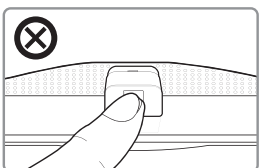
	<p data-bbox="521 1588 579 1641"></p> <p data-bbox="608 1574 1220 1661">Do not touch the lens while operating the TV camera. Leave fingerprints that may affect the image quality. If the lens gets dirty, clean it using a soft piece of cloth.</p>
---	--

---

## Universal Remote Setup

This TV has a universal remote control feature that lets you control cable boxes, Blu-ray players, home theatres, and other third-party external devices connected to the TV using the TV's remote control.

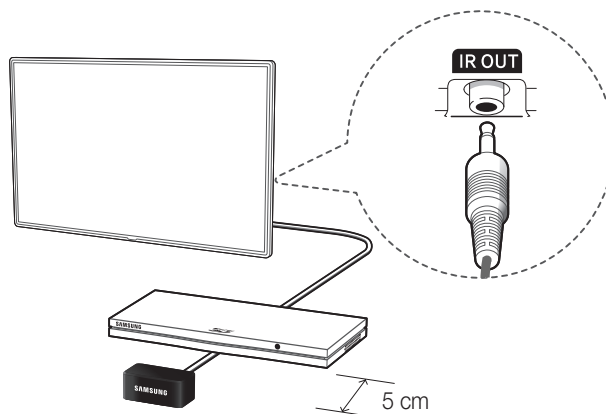

Plug the cable into the TV IR connector and then point the transmitter at the other end of the cable towards the external device's remote panel receiver. However, there can't be any obstacles between the IR extension cable and the external device. The presence of an obstacle will interfere with the transmission of the remote control signal.

### Add the External Device



1. Turn on the external device you wish to set up universal remote function for and then press **SOURCE** to bring up the **Source** screen.
2. Select **Universal remote setup** from the top of the screen. This initiates the universal remote setup process.
3. Follow the on-screen instruction and set up the universal remote control. If it does not work, set up the remote control by entering the model number manually.

---

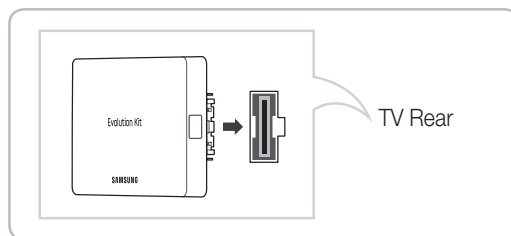
## The Evolution Kit Slot (Kit Sold Separately)



Attaching the Evolution Kit to your Samsung TV upgrades the TV's hardware and software without your needing to purchase a new TV. With the Evolution Kit, you can keep your TV updated with the latest features and services provided by Samsung Electronics.

-  The Evolution Kit is sold separately. When users purchase an Evolution Kit released in 2014 or later, the user's TV can be upgraded to match the software version of the Evolution Kit. However, an Evolution Kit may not be available, depending on the product.
-  The colour and design of the Evolution Kit may vary depending on the model.

# SETUP

The initial setup dialog appears when the TV is first activated. Follow the on-screen instructions to finish the initial setup process, including menu language choice, channel scan, network connection, and more. At each step, either make a choice or skip the step. Users can manually perform this process at a later time under the Screen Menu > **System** > **Setup** menu.

- ✎ If you connect any device to **HDMI1** before starting the installation, the **Channel Source** will be changed to **Set-top box** automatically.
- ✎ If you do not want to select **Set-top box**, please select **Aerial**.

## Samsung 'On TV' Recommendations Service

The **On TV** service recommends TV programmes based on their popularity or your personal preferences. To enjoy the On TV service, please follow the steps below. (You must have an Internet connection.)

- 1. Configure your TV:** Select **TV** source to be used for **On TV**.  
**Aerial:** Freeview, Freesat, DVB-T/C/S  
**Set-top box:** External Cable Box, External Satellite Box
- 2. Auto tuning channels:** This step only occurs if '**Aerial**' was selected in step 1.
- 3. Select a Service Provider:** To select your preferred programme provider for On TV, enter your postcode and select your Freeview, Freesat or external satellite television provider from the displayed list.
- 4. Set-top Box Control Test:** This test is for checking that your TV remote can control your Set-top Box. This step only occurs if '**Set-top box**' was selected in step 1.

## Password Change

Screen Menu > **System** > **Change PIN**

**Change the TV's password.**

1. Run **Change PIN** and then enter the current password in the password field. The default password is "0-0-0-0".
  2. Enter a new password and then enter it again to confirm it. The password change is complete.
- ✎ If you forget the PIN code, press the buttons in the following sequence which resets the PIN to "0-0-0-0":  
**For Standard Remote Control:** In Standby mode: **MUTE** → 8 → 2 → 4 → **POWER** (On)  
**For Smart Touch Control:** When the TV turns on: **MUTE** → Volume up → **RETURN** → Volume down → **RETURN** → Volume up → **RETURN**

---

# Switching Between Video Sources

Press **SOURCE** button to switch between devices connected to the TV.

For example, to switch to a game console connected to the second HDMI connector, press **SOURCE** button. From the **Source** list, select **HDMI2**. The connector names may vary depending on the product. Select **Tools** button at the upper-right corner of the screen to access the following functions.

 For some compatible devices connected via SCART or HDMI sockets, the TV may automatically select the correct source when this device is accessed. For this to work the HDMI Anynet+ system must be switched on (see Screen Menu > **System** > **Anynet+ (HDMI-CEC)**). Anynet+ will also automatically power off compatible HDMI devices when the TV is switched off.

- **Anynet+ (HDMI-CEC)**

A list appears showing Anynet+ compatible ones of external devices connected to the TV.

 This function is only available **Anynet+ (HDMI-CEC)** function set to **On**.

- **Edit Name**

You can rename devices connected to the TV to more easily identify external sources.

With a computer connected to the TV's HDMI (DVI) port via an HDMI cable, for example, you can change **Edit Name** to **PC**.

With a computer connected to the TV's HDMI (DVI) port via an HDMI-to-DVI cable, for example, you can change **Edit Name** to **DVI PC**.

With an AV device connected to the TV's HDMI (DVI) port via an HDMI-to-DVI cable, for example, you can change **Edit Name** to **DVI Devices**.

- **Information**

View detailed information about the connected devices.

- **Disconnect USB Device**

Remove the USB device from the list safely. This function is only available when the USB device selected.

- **Universal remote setup**

To add a new external device to control it with the Smart Touch Control, press the **SOURCE** button and select **Universal remote setup** on the top right of the screen.

Using the universal remote control, users can control external devices connected to the TV, such as a settop box, Blu-ray player, and AV receiver.

# Connecting to a COMMON INTERFACE slot (Your TV viewing Card Slot)

✎ Turn the TV off to connect or disconnect a CI card or CI card adapter.

## Attaching the CI Card Adapter

Attach the adapter as shown side.

✎ To install the CI CARD Adapter, please remove the sticker attached to the TV.

To connect the CI CARD Adapter, follow these steps.

✎ We recommend attaching the adapter before installing the wall mount, or inserting the “CI or CI+ CARD”.

1. Insert the CI CARD Adapter into the two holes on the product ❶.

✎ Please find two holes on the rear of the TV, beside the **COMMON INTERFACE** port.

2. Connect the CI CARD Adapter into the **COMMON INTERFACE** port on the product ❷.

3. Insert the “CI or CI+ CARD”.

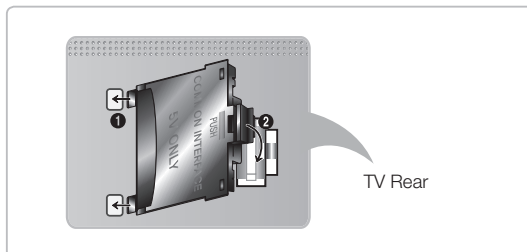

We recommend that you attach the CI Card adapter and insert the CI card (viewing card) before you mount the TV on the wall because it may be difficult and hazardous do this when it is on the wall.

## Using the “CI or CI+ CARD”

Attach the adapter as shown side.

✎ To install the CI CARD Adapter, please remove the sticker attached to the TV.

To connect the CI CARD Adapter, follow these steps.

✎ We recommend attaching the adapter before installing the wall mount, or inserting the “CI or CI+ CARD”.

To watch paid channels, the “CI or CI+ CARD” must be inserted.

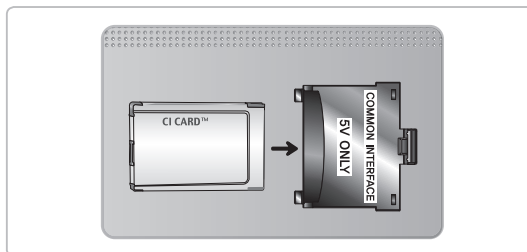

- If you don't insert the “CI or CI+ CARD”, some channels will display the message “Scrambled Signal”.
- The pairing information containing a telephone number, the “CI or CI+ CARD” ID the Host ID and other information will be displayed in about 2~3 minutes. If an error message is displayed, please contact your service provider.
- When the configuration of channel information has finished, the message “Updating Completed” is displayed, indicating the channel list is updated.

### NOTE

- You must obtain a “CI or CI+ CARD” from a local cable service provider.
- When removing the “CI or CI+ CARD”, carefully pull it out with your hands since dropping the “CI or CI+ CARD” may cause damage to it.
- Insert the “CI or CI+ CARD” in the direction marked on the card.
- The location of the COMMON INTERFACE slot may be different depending on the model.
- “CI or CI+ CARD” is not supported in some countries and regions; check with your authorized dealer.
- If you have any problems, please contact a service provider.
- Insert the “CI or CI+ CARD” that supports the current aerial settings. The screen will be distorted or will not be seen.



---

# Viewing the e-Manual

The embedded e-Manual contains information about your TV's key features.

This TV has a built-in user guide. To read it, use one of the following methods:





- Open the **Support** menu and choose **e-Manual (Troubleshooting)**.
- Press the **E-MANUAL** button on the standard remote control.
- Press the **MORE** button on the Smart Touch Control to display control buttons on the screen. Flick the touchpad until **e-Manual** appears and select it.

 Words in blue refer to screen menu options and words in light blue refer to remote control buttons.

 A printable version of this guide is also available at [www.samsung.com/support](http://www.samsung.com/support).

## Scrolling a Page

To scroll a page, use one of the following methods:

- Press the  or  button on the scroll bar at the right edge of the screen.
- Drag or flick up or down the ridge on either the left or right edge of the touchpad.
- Place the cursor on the  or  button at the right edge of the screen, drag or flick up or down on the touchpad.



## Using the Icons at the Top of the Page

Use the **Back**, **Forward**, and **Opened page** icons on the top left of the screen to navigate through pages. These icons are available when two or more pages are passed.



### Returning to the Home Page

To return to the home page, press the  button or select  on the top right of the screen.

### Searching the Index

Press the  button or select  on the top right of the screen to display the index. Select a term to display the page containing the term.

### Searching Pages

Press the  button or select  on the top of the screen to access the search screen. Enter a search phrase and select **Done**. Select an item from the search results list to navigate to the relevant page.

### Closing the e-Manual

To close the e-Manual, press and hold the **RETURN** button or select  at the upper-right corner of the screen or press **EXIT** button.

### Jumping to a Menu Item

To directly jump to the menu item that is described in the current section, select . It is possible to jump from a menu item directly to the related section in the e-Manual. If you want to read an e-Manual entry on a specific screen menu feature, press the virtual remote panel's or the regular remote's **E-MANUAL** button to load the corresponding e-Manual page.

 This feature may not be available, depending on the menu.

### Updating the e-Manual

Open the **Smart Hub** and select **Apps**, and then select **More Apps**. The e-Manual can be updated in the same way with an application update.

On the **More Apps** screen, select **Apps to update**, and then select e-Manual from the list. The e-Manual starts updating to the latest version. However, **Apps to update** appears on the screen only when the update is required.

## Connecting to a Network

Connecting the Smart TV to a network gives you access to online services such as the Smart Hub, as well as software updates.

### Network Connection - Wireless

Connect the TV to the Internet using a standard router or modem.

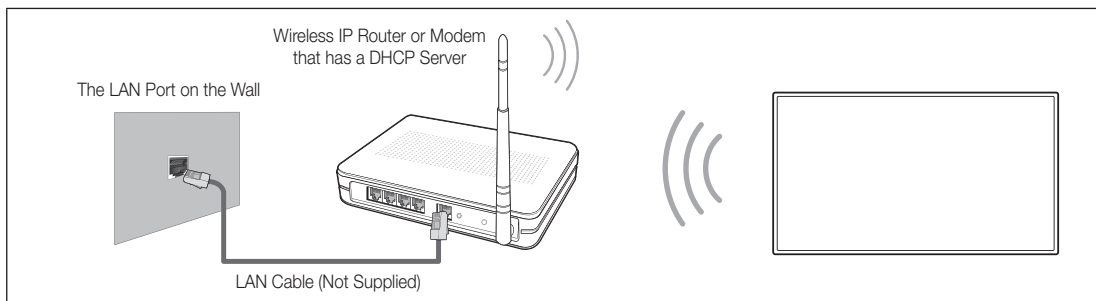

### Wireless Network Precautions

- This Smart TV supports the IEEE 802.11a/b/g/n communication protocols. Samsung recommends using IEEE 802.11n. Otherwise when you play video over a network connection, the video may not play smoothly.
- To use a wireless network, the TV must be connected to a wireless router or modem. If the wireless router supports DHCP, the TV can use a DHCP or static IP address to connect to the wireless network.
- Select a channel that is not currently in use for the wireless router. If the channel set for the wireless router is currently being used by another device, the result is usually interference and/or a communications failure.
- Most wireless networks have an optional security system. To enable a wireless network's security system, you need to create a security key using characters and numbers. This security key is then needed to connect to the wireless network.

### Network Security Protocols

The TV only supports the following wireless network security protocols and is unable to connect to non-certified wireless routers:

- Authentication Modes: WEP, WPAPSK, WPA2PSK
- Encryption Types: WEP, TKIP, AES

If the wireless router has been set to Pure High-throughput (Greenfield) 802.11n mode and the Encryption Type to WEP or TKIP, Samsung Smart TVs will not support the connection in compliance with the new Wi-Fi certification specifications.

If the wireless router supports WPS (Wi-Fi Protected Setup), it is possible to connect to the network using PBC (Push Button Configuration) or a PIN (Personal Identification Number). WPS automatically configures the SSID and WPA key settings.

## Network Connection - Wired

There are three main ways to connect your TV to your network using cable, depending on your network setup. They are illustrated starting below:

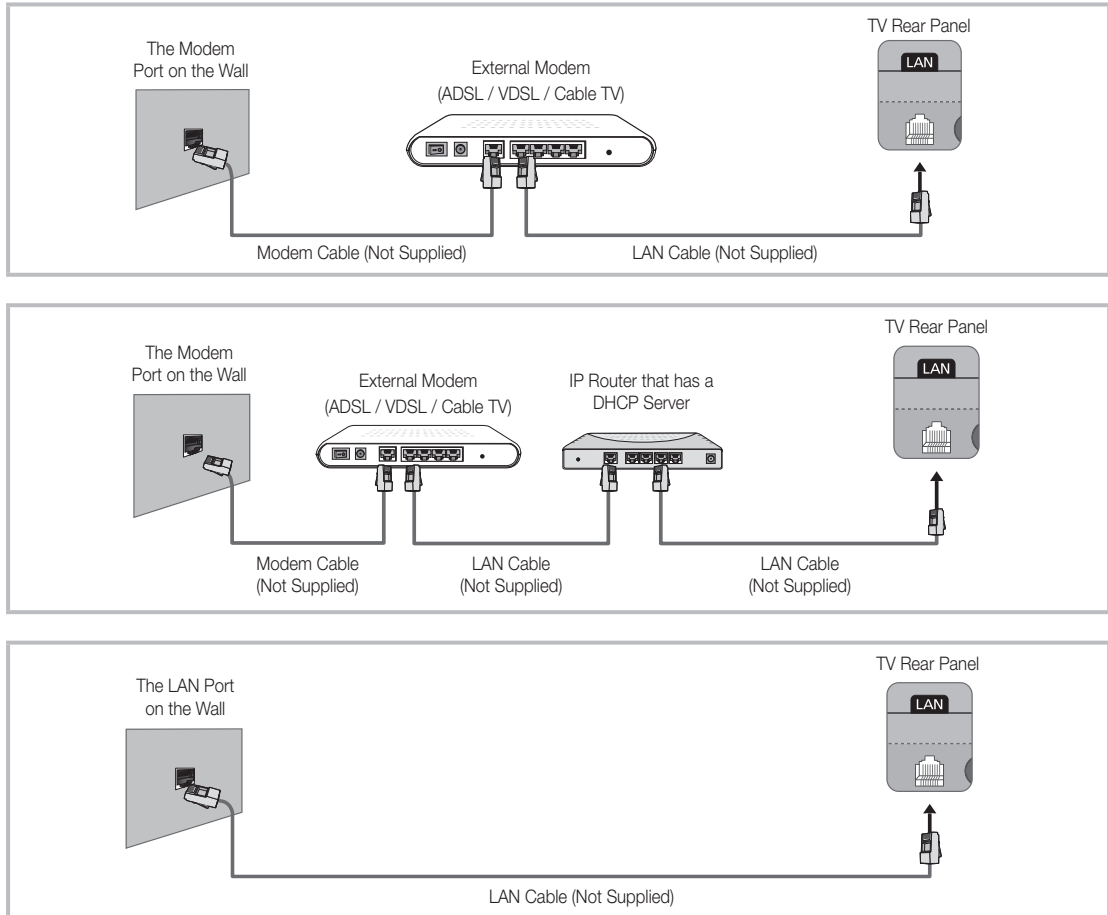

- ✎ The TV does not support network speeds less than or equal to 10Mbps.
- ✎ Use Cat 7 cable for the connection.

# 3D Active Glasses

## Features

Samsung's SSG-5100GB 3D glasses enable you to view 3D images on your 3D TV. The Samsung 3D glasses communicate with Samsung 3D TVs via the 2.4GHz RF band.

The Samsung 3D glasses are only compatible with Samsung D, E, and F series 3D TV's that were released in 2011, 2012, and 2013. These 3D glasses cannot be connected to other Bluetooth devices.

## Parts

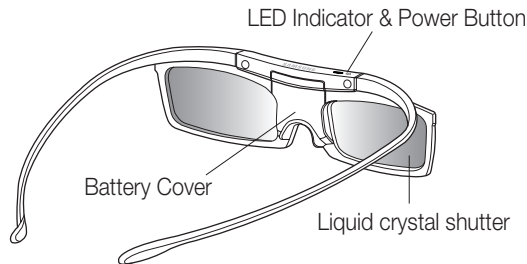

For details on how to attach the glasses' arms and how to pair the glasses with the TV, refer to the separate 3D glasses manual.

## Replacing the Battery

If the red LED blinks every two seconds continually, replace the battery with a new one.

- Insert the "+" side of the battery into the side marked with "+" in the battery compartment.
- To check the remaining battery capacity, refer to the pairing section in this manual.

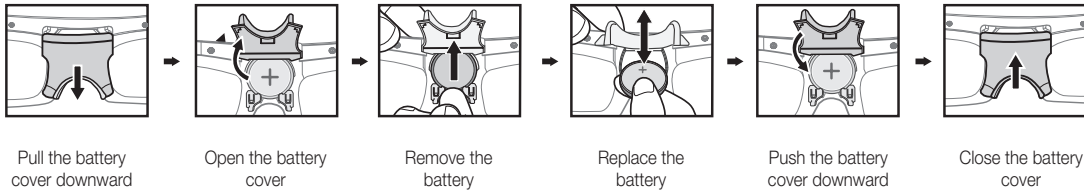

## Pairing 3D Active Glasses

- What is Pairing? Pairing is the process of connecting 3D glasses and a 3D TV so that the two devices can exchange data.
- Ensure your Samsung TV and 3D glasses are no farther than 19.5 in (50 cm) apart from each other while pairing is in progress.

- Turning the glasses on**

Press the power button briefly. The green LED is turned on for 3 seconds. (Make sure that 3D is activated on the TV before using the 3D glasses.)

- Turning the glasses off**

Press the power button briefly. The red LED is turned on for 3 seconds.

- Performing the pairing process**

Turn the TV on and let it power up completely. Press and hold the Power button on the glasses. The green and the red LEDs blink alternately for 2 seconds.

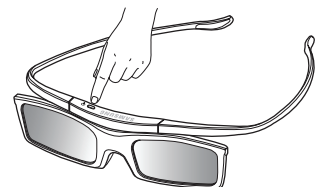

- **Operating range**

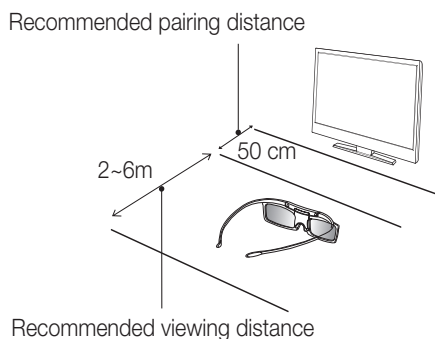

Recommended viewing distance	2~6m (6.5 to 19.5 ft)
Recommended pairing distance	50 cm or less (19.5 in)

- ✎ Once the 3D glasses are paired, the remaining battery capacity is displayed on the TV screen. (This feature only applies to Samsung F series 3D TVs and 3D glasses that have been available since 2013.)
- ✎ If you keep trying to pair the glasses and the TV, the battery level will decrease significantly. However, the battery level will recover to a certain degree in about a minute.
- ✎ The working distance depends on the existence of obstacles (a person, metal, walls, etc.) between the glasses and the TV and the strength of the Bluetooth signal.
- ✎ Turn off the 3D glasses while they are not in use. If you leave the 3D glasses on, the battery lifespan decreases.

### **Pairing steps**

1. Turn on the TV, and then move the glasses within 19.5 inches of the TV.
2. Press the power button on the 3D glasses briefly. The 3D glasses will power on and pairing will start.
3. The message “3D glasses are connected to TV.” will be displayed on the TV screen when the pairing is successfully completed.
  - If pairing fails, the 3D glasses will power off.
  - If the first attempt to pair fails, power the TV off and on again and perform step 2.
  - How to pair again: Press the power button on the 3D glasses for more than 1 second.

### **Pairing is needed again in the following situations:**

- If the 3D glasses do not function, even when the power button is pressed, especially with a 3D TV after a repair.
- If you want to play 3D content on another Samsung 3D TV model that belongs to the D, E, or F series released in 2011 through 2013. You must pair the glasses with the other TV.

## Watching 3D Video

Some 3D modes may not be available depending on the format of the image source.

To watch in 3D, you must wear 3D Active Glasses and turn the glasses on by pressing the power button.

1. Go to the 3D screen. (**Picture > 3D**)
2. Select the 3D Mode. The 3D Mode screen appears.
3. Set the 3D Mode of the image you want to view.

### Troubleshooting

If you encounter...	Try this...
<b>My 3D glasses do not work.</b>	Replace the battery. The 3D glasses should be close to the TV. Make sure that the distance between the TV and your 3D glasses is less than 19.5 feet (6m) in a straight line. Check the 3D function settings of your TV.
<b>The LED keeps blinking</b>	The battery is dead. Replace the battery.

### Specifications (Model Number: SSG-5100GB )

<b>Optics</b>	<b>Shutters</b>	Liquid crystal	<b>Transmittance</b>	36±2%
	<b>Recommended operating distance</b>	2 ~ 6m (6.5 to 19.5 ft)	<b>Field Rate</b>	120 fields/second
<b>Weight</b>	<b>Glasses</b>	21.5g/.76 oz. (including the battery: 24.0±0.5g/.85±.018oz. )		
<b>Power</b>	<b>Glasses</b>	One 3V lithium/manganese dioxide battery 3V(CR2025)		
<b>Power consumption</b>	<b>Glasses</b>	0.85mA (Average)		
	<b>Battery</b>	<b>Type</b>	165mAh, 3.0V (CR2025)	
		<b>Operating time</b>	150 hours	
<b>Operating conditions</b>	<b>Operating temperature</b>	50 °F ~ 104 °F (10°C ~ 40°C)		
	<b>Custody temperature</b>	-4 °F ~ 113 °F (-20°C ~ 45°C)		

Product specifications may be changed without notice in order to enhance product performance.

 The continuous operating time may differ depending on the wireless communication environment and usage conditions.

### [ Recommendation ]- EU ONLY



Hereby, Samsung Electronics, declares that this 3D Active Glasses is in compliance with the essential requirements and other relevant provisions of Directive 1999/5/EC.

This equipment may be operated in all EU countries.

---

## What is Remote Support?

Samsung Remote Support service offers you one-on-one support with a Samsung Technician who can remotely.

- **Diagnose** your TV
- **Adjust the TV settings** for you
- **Perform a factory reset** your TV
- Install recommended **firmware updates**

### How Does it Work?

Having a Samsung Tech remotely service your TV is really pretty simple



1. **Call Samsung Contact Centre** and ask for remote support.



2. **Open the menu** on your TV and go to the **Support section**.



3. Select Remote Management and **Provide the Pin#** to the agent.



4. The agent will then **access your TV**. That's it!

---

## Assembling the Cable manager

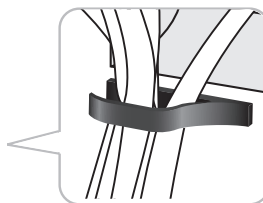
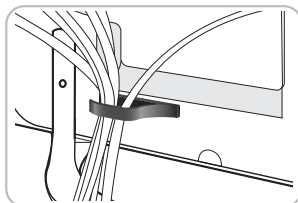
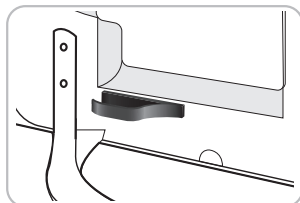

---

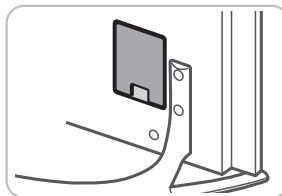
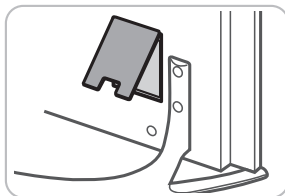
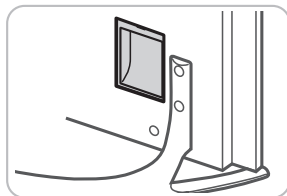

## Assembling the Power Cover



# Troubleshooting

If you have any questions about the TV, first refer to this list. If none of these troubleshooting tips apply, please visit “[www.samsung.com](http://www.samsung.com),” then click on Support, or contact the call centre listed on the back-cover of this manual.

Issues	Solutions and Explanations
The TV won't turn on.	<ul style="list-style-type: none"><li>• Make sure the AC power cord is securely plugged in to the wall outlet and the TV.</li><li>• Make sure the wall outlet is working.</li><li>• Try pressing the  button on the TV to make sure the problem is not the remote. If the TV turns on, refer to “Remote control does not work” below.</li></ul>
There is no picture/video.	<ul style="list-style-type: none"><li>• Check the cable connections. Remove and reconnect all cables connected to the TV and external devices.</li><li>• Set the video outputs of your external devices (Cable/Sat Box, DVD, Blu-ray etc) to match the TV's input connections. For example, if an external device's output is HDMI, it should be connected to an HDMI input on the TV.</li><li>• Make sure your connected devices are powered on.</li><li>• Be sure to select the correct input source.</li><li>• Reboot the connected device by unplugging it, and then reconnecting the device's power cable.</li></ul>
The remote control does not work.	<ul style="list-style-type: none"><li>• Replace the remote control batteries. Make sure the batteries are installed with their poles (+/-) in the correct direction.</li><li>• Clean the sensor's transmission window on the remote.</li><li>• Try pointing the remote directly at the TV from 5~6 feet away.</li></ul>
The cable/set top box remote control doesn't turn the TV on or off or adjust the volume.	<ul style="list-style-type: none"><li>• Programme the Cable/Set remote control to operate the TV. Refer to the Cable/Set-Top-Box user manual for the SAMSUNG TV code.</li></ul>

-  This TFT LED panel uses a panel consisting of sub pixels which require sophisticated technology to produce. There may be, however, be a few bright or dark pixels on the screen. These pixels will have no impact on the performance of the product.
-  To keep your TV in optimum condition, upgrade to the latest firmware on the Samsung web site by USB ([Samsung.com](http://Samsung.com) > Support > Downloads).
-  Some of above pictures and functions are available at specific models only.

## Mounting the TV on the Wall Using the Wall Mount Kit (Optional)



### Wall or Ceiling Mounting

If you mount this product on a wall, it should be mounted only as recommended by the manufacturer. Unless it is correctly mounted, the product may slide or fall, causing serious injury to a child or adult, and serious damage to the product.

### Installing the Wall Mount Kit

The wall mount kit (sold separately) lets you mount the TV on the wall.

For detailed information about installing the wall mount, see the instructions provided with the wall mount. We recommend you contact a technician for assistance when installing the wall mount bracket. We do not advise you to do it yourself. Samsung Electronics is not responsible for any damage to the product or injury to yourself or others if you select to install the wall mount on your own.



## Preparing before installing Wall-Mount

Case A. Installing the SAMSUNG Wall-Mount

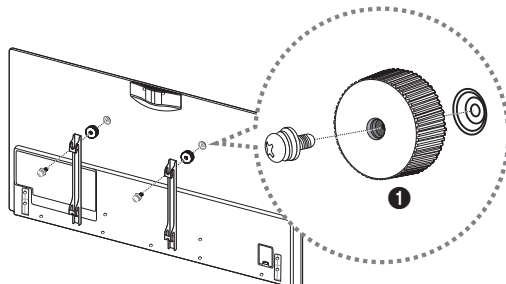

Case B. Installing another company's Wall-Mount

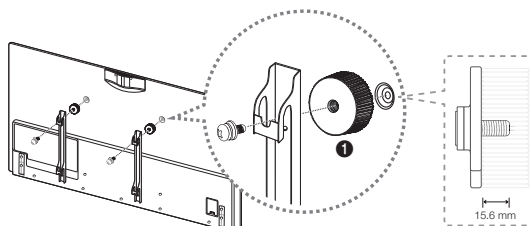

To install a wall-mount, use the Wall mount adapter ❶.

### Wall Mount Kit Specifications (VESA)

The wall mount kit is not supplied, but sold separately. Install your wall mount on a solid wall perpendicular to the floor. When attaching to other building materials, please contact your nearest dealer. If installed on a ceiling or slanted wall, it may fall and result in severe personal injury.

#### NOTE

- Standard dimensions for wall mount kits are shown in the table below.
- When purchasing our wall mount kit, a detailed installation manual and all parts necessary for assembly are provided.
- Do not use screws that do not comply with the VESA standard screw specifications.
- Do not use screws that are longer than the standard dimension or do not comply with the VESA standard screw specifications. Screws that are too long may cause damage to the inside of the TV set.
- For wall mounts that do not comply with the VESA standard screw specifications, the length of the screws may differ depending on the wall mount specifications.
- Do not fasten the screws that are too strongly; this may damage the product or cause the product to fall, leading to personal injury. Samsung is not liable for these kinds of accidents.
- Samsung is not liable for product damage or personal injury when a non-VESA or non-specified wall mount is used or the consumer fails to follow the product installation instructions.
- Do not mount the TV at more than a 15 degree tilt.

Product Family	Inch	VESA Spec.(A * B)	Standard Screw	Quantity
LED-TV	40 - 46	200 X 200	M8	4
	55 - 75	400 X 400		

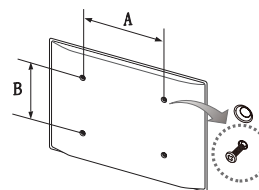

Do not install your Wall Mount Kit while your TV is turned on. It may result in personal injury due to electric shock.

## Storage and Maintenance

- ✎ If a sticker was attached to the TV screen, some debris can remain after you remove the sticker. Please clean the debris off before watching TV.
- ✎ The exterior and screen of the product can get scratched during cleaning. Be sure to wipe the exterior and screen carefully using a soft cloth to prevent scratches.

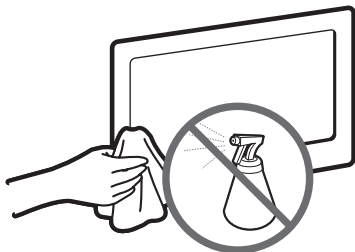

Do not spray water directly onto the product. Any liquid that goes into the product may cause a failure, fire, or electric shock.

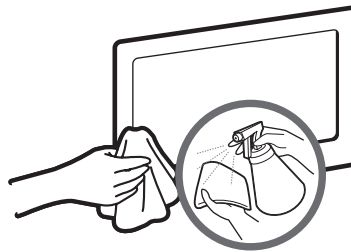

Clean the product with a soft cloth dampened with a small amount of water. Do not use a flammable liquid (e.g. benzene, thinners) or a cleaning agent.

## Providing Proper Ventilation for Your TV

When you install your TV, maintain a distance of at least 10 cm between the TV and other objects (walls, cabinet sides, etc.) to ensure proper ventilation. Failing to maintain proper ventilation may result in a fire or a problem with the product caused by an increase in its internal temperature.

- ✎ Whether you install your TV using a stand or a wall-mount, we strongly recommend you use parts provided by Samsung Electronics only.
- If you use parts provided by another manufacturer, it may cause difficulties with the product or result in injury caused by the product falling.

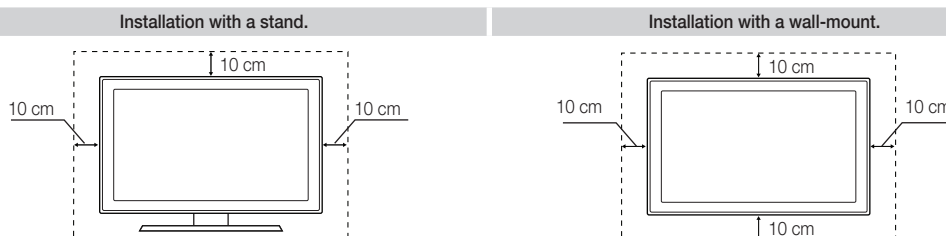

### Other Warnings

- ✎ The actual appearance of the TV may differ from the images in this manual, depending on the model.
- ✎ Be careful when you touch the TV. Some parts can be somewhat hot.

## Eco Sensor and Screen Brightness



Eco Sensor measures the light in your room and optimizes the brightness of the TV automatically to reduce power consumption. This causes the TV to brighten and dim automatically. If you want to turn this function off, go to Screen Menu > **System** > **Eco Solution** > **Eco Sensor**



**Do not block the sensor with any material. It can decrease picture brightness.**

1. **Eco Sensor:** This power-saving feature automatically adjusts the screen brightness of the TV according to the ambient light intensity detected by the Light Sensor.
2. To enable or disable **Eco Sensor**, go to Screen Menu > **System** > **Eco Solution** > **Eco Sensor** and select **On** or **Off**.
3. Precaution: If you find the screen too dark while watching the TV in a dark area, this may be caused by the **Eco Sensor**.

## Tip Prevention – Securing the TV to the Wall



**Caution:** Pulling, pushing, or climbing on the TV may cause the TV to fall. In particular, ensure your children do not hang on or destabilize the TV. Doing so may cause the TV to tip over, causing serious injuries or death. Follow all safety precautions provided in the Safety Flyer included with your TV. For added stability and safety, you can purchase and install the anti-fall device as described below.

### Installing the TV-Holder Kit:

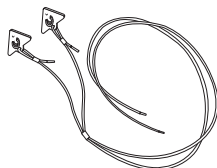

TV-Holder



Holder



Screw (M8 X L28) 2ea

## Installing the TV-Holder

1. Screw the provided wall mount adapters on the back of the TV.

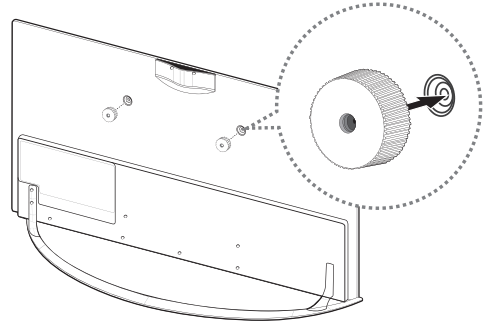

2. Insert the screw into the centre of the TV-holder, as shown by the illustration.

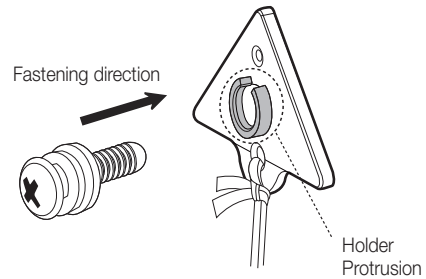

3. Tighten the TV-holders on the wall mount adapters, as shown by the illustration.

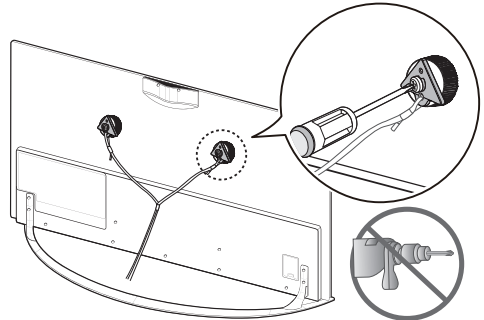

4. Fasten the Holder to the cabinet using a wood screw.
  - 🔩 Use an M5 x L35 or a larger screw.
  - 🔩 Ensure that the Holder cord is in the middle of the TV Holder and that the Holder cord is stretched tight.

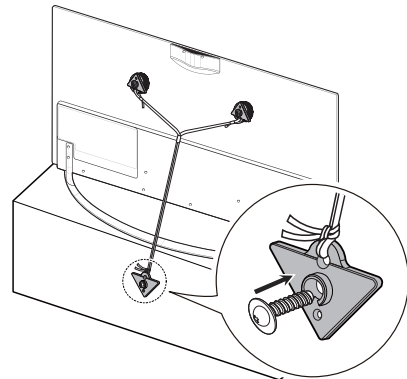

5. If you fasten the Holder to a wall, attach it as described in Step 4. Make sure to centre the Holder cord and stretch it tight. Also, attach the Holder so that the cord is level with the ground or slanted downwards from the wall.

🔩 When attaching the holder to a wall, use an anchor compatible with the wall's material. If you can, drive the screw into a stud (Recommended).

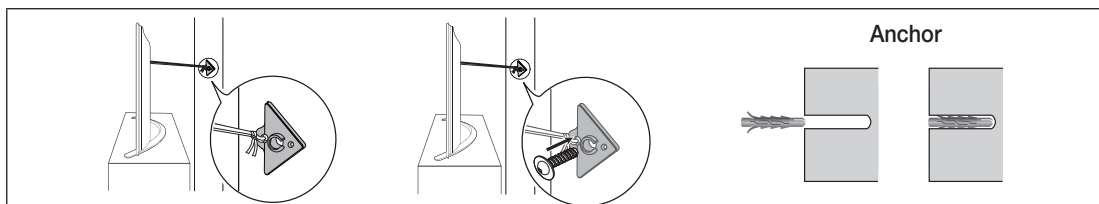

- 🔩 Install the TV close to the wall so that it does not fall.
- 🔩 When attaching the TV-Holder cord to the wall, tie the cord level with the ground or slanted downwards for safety purposes.
- 🔩 Check the cord occasionally to make sure it is secure.
- 🔩 Before moving the TV, separate the connected cord first.
6. Verify all connections are properly secured. Periodically check the connections for any sign of fatigue or failure. If you have any doubt about the security of your connections, contact a professional installer.

#### IMPORTANT INFORMATION

If a television is not installed in a stable location, it can fall and cause serious injuries. To prevent injuries, particularly to children, take these simple precautions:

- Use cabinets or stands recommended by the manufacturer of the television.
- Only use furniture that can safely support the television.
- Ensure the television is not overhanging the edge of the supporting furniture.
- Do not place the television on tall pieces of furniture (for example, cupboards or bookcases) without anchoring both the furniture and the television to a suitable support.
- Do not rest the television on a piece of cloth or or similar material placed between the television and the supporting furniture.
- Educate children about the dangers of climbing on furniture to reach the television or its controls.

# Specifications - TV

Display Resolution	1920 x 1080		
Environmental Considerations	50°F to 104°F (10°C to 40°C)		
Operating Temperature	10% to 80%, non-condensing		
Operating Humidity	-4°F to 113°F (-20°C to 45°C)		
Storage Temperature	5% to 95%, non-condensing		
Storage Humidity			
Stand Swivel (Left / Right)	0°		
Model Name	UE40F8000	UE46F8000	
Screen Size (Diagonal)	40 inches	46 inches	
Sound (Output)	40W (10x2, woofer 10x2)		
Dimensions (W x H x D)			
Body	900.2 x 525.0 x 34.9 mm	1032.7 x 599.5 x 34.9 mm	
With stand	900.2 x 559.0 x 235.0 mm	1032.7 x 634.3 x 257.7 mm	
Weight			
Without Stand	10.3 kg	12.8 kg	
With Stand	11.2 kg	14.0 kg	
Model Name	UE55F8000	UE65F8000	UE75F8000
Screen Size (Diagonal)	55 inches	65 inches	75 inches
Sound (Output)	40W (10x2, woofer 10x2)		60W (15x2, woofer 15x2)
Dimensions (W x H x D)			
Body	1224.2 x 707.2 x 34.9 mm	1447.3 x 837.6 x 38.4 mm	1670.2 x 962.7 x 39.9 mm
With stand	1224.2 x 741.9 x 310.3 mm	1447.3 x 876.0 x 330.3 mm	1670.2 x 1000.5 x 342.1 mm
Weight			
Without Stand	16.8 kg	24.6 kg	35.9 kg
With Stand	18.3 kg	26.9 kg	42.7 kg

 Design and specifications are subject to change without prior notice.

 For information about the power supply, and more about power consumption, refer to the label attached to the product.

 Typical power consumption is measured according to IEC 62087 Ed.2

## Standby mode

To decrease power consumption unplug the power cord when you don't use the TV for a long time.

## Recommendation - EU Only



- Hereby, Samsung Electronics, declares that this LED TV is in compliance with the essential requirements and other relevant provisions of Directive 1999/5/EC.
- The official Declaration of Conformity may be found at <http://www.samsung.com>, go to Support > Search Product Support and enter the model name.
- This equipment may only be used indoors.
- This equipment may be operated in all EU countries.

---

## Licences



### Still image warning

Avoid displaying still images (such as jpeg picture files), still image elements (such as TV channel logos, stock or news bars at the screen bottom etc.), or programmes in panorama or 4:3 image format on the screen. Constantly displaying still pictures can cause image burn-in on the LED screen, which will affect image quality. To reduce risk of this effect, please follow the recommendations below:

- Avoid displaying the same TV channel for long periods.
- Always try to display any image in full screen. Use the TV set's picture format menu for the best possible match.
- Reduce brightness and contrast to avoid the appearance of after-images.
- Use all TV features designed to reduce image retention and screen burn. Refer to the e-Manual for details.

 **WARNINGS:** Image retention, commonly known as screen burn-in, can occur on most types of television if the same image is displayed continuously. The most common causes of image retention are logos that remain stationary on the TV screen. These logos are common on many programmes received via a Set-top Box. To reduce this risk, avoid displaying still images for long durations and lower the brightness or contrast settings to decrease the intensity of the picture. Extended viewing of movies and programs in aspect ratios that are different from the aspect ratio of the TV may cause image retention. Always endeavour to avoid black borders top or bottom by using the zoom function. This will help eliminate the black borders and fit the picture to the entire area of the screen. Using a video game console may cause image retention and is not recommended. When using a PC input, avoid displaying still images for long durations and reduce the brightness or contrast settings to decrease the intensity of the picture.

 **IMPORTANT:** Image retention issues are not covered by your Samsung® warranty.

# Warranty Card



United Kingdom



Republic of Ireland (EIRE)

This Samsung product is warranted for a period of twelve (12) months from the original date of purchase, against defective materials and workmanship. In the event that warranty service is required, you should return the product to the retailer from whom it was purchased. However, Samsung Authorised Dealers and Authorised Service Centres in other EC Countries will comply with the warranty on the terms issued to purchasers in the country concerned. In case of difficulty, details of our Authorised Service Centres are available from:

**Samsung Electronics U.K. Ltd.**

**Customer Care Centre**

**PO Box 479**

**GATESHEAD NE9 9BJ**

**United Kingdom**

**Tel: 0330 SAMSUNG (7267864) / Fax: 0330 7260001 (UK & Northern Ireland)**

**Tel: 0818 717100 / Fax: +44 117 915 6736 (EIRE Only)**

**Web: [www.samsung.com](http://www.samsung.com)**

## **WARRANTY CONDITIONS**

1. The warranty is only valid if, when warranty service is required, the warranty card is fully and properly completed and is presented with the original invoice or sales slip or confirmation, and the serial number on the product has not been defaced.
2. Samsung's obligations are limited to the repair or, at its discretion, replacement of the product or the defective part.
3. Warranty repairs must be carried out by Authorised Samsung Dealers or Authorised Service Centres. No re-imbursement will be made for repairs carried out by non Samsung Dealers and, any such repair work and damage to the products caused by such repair work will not be covered by this warranty.
4. This product is not considered to be defective in materials nor workmanship by reason that it requires adaptation in order to conform to national or local technical or safety standards in force in any country other than the one for which the product was originally designed and manufactured.
5. This warranty covers none of the following:
  - a) Periodic check ups, maintenance and repair or replacement of parts due to normal wear and tear.
  - b) Cost relating to transport, removal or installation of the product.
  - c) Misuse, including the failure to use this product for its normal purposes or incorrect installation.
  - d) Damage caused by Lightning, Water, Fire, Acts of God, War, Public Disturbances, incorrect mains voltage, improper ventilation or any other cause beyond the control of Samsung.
  - e) Spillage of food or liquid or use of any other hazardous substances, which may effect the product.
  - f) Performance due to differences in broadcasting method between countries
6. This warranty is valid for any person who legally acquired possession of the product during the warranty period.
7. The consumers statutory rights in any applicable national legislation whether against the retailer arising from the purchase contract or otherwise are not affected by this warranty. Unless there is national legislation to the contrary, the rights under this warranty are the consumers sole rights and Samsung, its subsidiaries and distributors shall not be liable for indirect or consequential loss or any damage to records, compact discs, videos or audio taper or any other related equipment or material.
8. Some products may differ from these guidelines. Please check with your dealer or the local Samsung web-site.



## Wiring the Mains Power Supply Plug (UK Only)

### IMPORTANT NOTICE

The mains lead on this equipment is supplied with a moulded plug incorporating a fuse. The value of the fuse is indicated on the pin face of the plug and, if it requires replacing, a fuse approved to BS11362 of the same rating must be used.

Never use the plug with the fuse cover omitted if the cover is detachable. If a replacement fuse cover is required, it must be of the same colour as the pin face of the plug. Replacement covers are available from your dealer.

If the fitted plug is not suitable for the power points in your house or the cable is not long enough to reach a power point, you should obtain a suitably approved extension lead or consult your dealer for assistance. However, if there is no alternative but to cut off the plug, remove the fuse and then safely dispose of the plug.

Do NOT connect the plug to a mains socket as there is a risk of shock hazard from the bared flexible cord.

### IMPORTANT

The wires in the mains lead are coloured in accordance with the following code:

BLUE - NEUTRAL BROWN - LIVE

As these colours may not correspond to the coloured markings identifying the terminals in your plug, proceed as follows : The wire coloured BLUE must be connected to the terminal marked with the letter N or coloured BLUE or BLACK. The wire coloured BROWN must be connected to the terminal marked with the letter L or coloured BROWN or RED.

### WARNING

DO NOT CONNECT EITHER WIRE TO THE EARTH TERMINAL, WHICH IS MARKED WITH THE LETTER E OR BY THE EARTH SYMBOL , OR COLOURED GREEN OR GREEN AND YELLOW.