

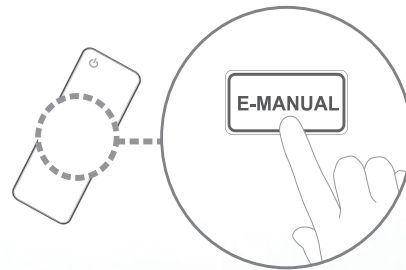

E-MANUAL



imagine the possibilities

Thank you for purchasing this Samsung product. To receive more complete service, please register your product at www.samsung.com/register

Model _____ Serial No. _____

Contents

Channel Setting

- Using the INFO button (Now & Next guide) 1
- Using Channel menu (Watch TV) 2
- Schedule Manager 5
- Channel List 7
- Channel Manager 11
- Retuning Channels 17

Basic Features

- Picture Menu 27
- Sound Menu 44

Preference Features

- **Network** for LED 5 series 32-46 inches 56
- System Menu 84
- Support Menu 108

Advanced Features

- **My Contents** 116
- Anynet+ 143
- **AllShare™** for LED 5 series 32-46 inches 157

Other Information

- Analogue Channel Teletext Feature 161
- Anti-theft Kensington Lock 165
- Connections Common Interface Slot 167
- Troubleshooting 170
- Licence 187

❑ Using the INFO button (Now & Next guide)

The display identifies the current channel and the status of certain audio-video settings.

The Now & Next guide shows daily TV programme information for each channel according to the broadcasting time.

- Scroll ◀, ▶ to view information for a desired programme while watching the current channel.
- Scroll ▲, ▼ to view information for other channels. If you want to move to the currently selected channel, press the **ENTER**  button.

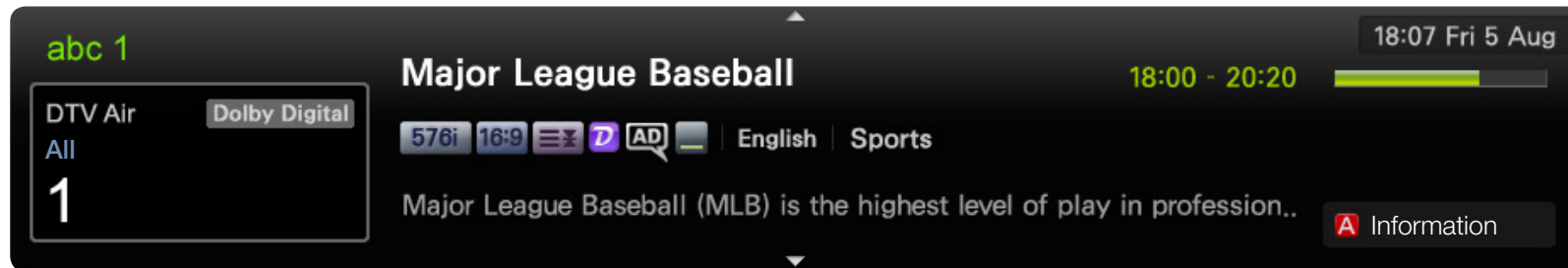

* It may differ depending on the model.

❑ Using Channel menu (Watch TV)

 MENU  → Support → Contents Home → ENTER 

Press the **CONTENT** button to select **Watch TV**, then select the desired menu. Each screen will be displayed.

■ Guide

The EPG (Electronic Programme Guide) information is provided by broadcasters. Using programme schedules provided by broadcasters, you can specify programmes you want to watch in advance so that the channel automatically changes to the selected programme channel at the specified time. Programme entries may appear blank or out of date depending on a channel status.



Using Guide

Guide 19:10 Tue 1 Jun



DTV Air 3 five
Home and Away
19:00 - 19:30
Drama
Dani is devastated when scott makes clear his views on marriage...

Channel View - All

Today		19:00	19:30	20:00	20:30
1	Discovery	American Chopper	Tine Team		
2	DiscoveryH&L	Tsunami Pri...	The Curious...	Dark Angel	Fiv...
3	five	Home and...	No Information		
4	price-drop.tv	No Information			
5	QVC	No Information			
▼ 6	R4DTT	No Information			

A Sche.Mgr **B** -24 Hours **C** +24 Hours **D** Ch. Mode Information Page Schedule

1 **2** **3** **4** **5** **6** **7**

* It may differ depending on the model.





- ① **A** Red (**Sche.Mgr**): Moves to the reserved programmes in **Sche.Mgr**.
- ② **B** Green (**-24 Hours**): Viewing the list of programmes to be broadcasted before 24 hours.
- ③ **C** Yellow (**+24 Hours**): Viewing the list of programmes to be broadcasted after 24 hours.
- ④ **D** Blue (**Ch. Mode**): Select the type of channels you want to display on the **Channel List** window. (**All, TV, Radio, Data/Other, Analogue, Favourites 1-5**)
- ⑤ **i** (**Information**): Displays details of the selected programme.
- ⑥ **↕** (**Page**): Move to previous or next page.
- ⑦ **⏪** (**Watch / Schedule**)
 - When selecting the current programme, you can watch the selected programme.
 - When selecting the future programme, you can reserve to watch the selected programme. To cancel the schedule, press the **ENTER** **⏪** button again and select **Cancel Schedules**.

■ Schedule Manager

Cancel or set the **Timer Viewing** to display the channel you want at the intended time.

Using Timer Viewing

You can set a desired channel to be displayed automatically at the intended time. Set the current time first to use this function.

1. Press the **ENTER**  button to add programme to schedule manually.
2. Press the /// button to set the **Antenna, Channel, Repeat, Date, Start Time**.
 - **Antenna**: Select the desired broadcasting signal.
 - **Channel**: Select the desired channel.

- **Repeat:** Select **Once**, **Manual**, **Sat~Sun**, **Mon~Fri** or **Everyday** to set at your convenience. If you select **Manual**, you can set the day you want.

 The (✓) mark indicates the day you've selected.

- **Date:** You can set the desired date.

 It is available when you select **Once** in **Repeat**.

- **Start Time:** You can set the start time you want.

 If you want to edit or cancel the schedule, select the reserved schedule on the **Schedule List**, and select the **Edit** or **Cancel Schedules**.

Channel List

You can view channel information, **All**, **TV**, **Radio**, **Data/Other**, **Analogue** or **Favourites 1-5**.

 When you press the **CH LIST** button on the remote control, **Channel List** screen will be displayed at once.



- **All**: Shows all currently available channels.
- **TV**: Shows all currently available TV channels.
- **Radio**: Shows all currently radio channels.
- **Data/Other**: Shows all currently available MHP or other channels.
- **Analogue**: Shows all currently available analogue channels.
- **Favourites 1-5**: Shows all favourite channels.





 **Favourites 1-5** will be displayed when you set **Add to Favourites**.

 If you want to view favourite channels you added, press the **CH LIST** button and use  (**Ch.Mode**) button to move **Favourites 1-5**.



 Using the remote control buttons with the **Channel List**.

-  Red (**Antenna**): Switches to **Air** or **Cable**.
-  Yellow (**Programme View / Channel View**): Displays the programme when digital channel is selected. Returns to the channel view.
-  (**Ch.Mode / Channel**): Move to the **All**, **TV**, **Radio**, **Data/Other**, **Analogue** or **Favourites 1-5**.

 When you press the  (**Programme View**) button, you can move to other channels using  (**Channel**) button.



-  (**Watch / Information**): Watches the channel you select. / Displays details of the selected programme.
-  (**Page**): Move to next or previous page.

Channel Status Display Icons

Icon	Operations
	An analogue channel.
	A reserved programme.
	A locked channel.

How to use Timer Viewing in Channel List (digital channels only)

When you set the **Timer Viewing** in **Channel List**, you can only set the programme in **Programme View**.

1. Press the **CH LIST** button, then select a desired digital channel.
 2. Press the **c** (**Programme View**) button.
 3. Press the **▲ / ▼** buttons to select the desired programme, then press the **ENTER**  (**Information**) or **INFO** button.
 4. Select **Timer Viewing**, then press the **ENTER**  button when done.
-  If you want to cancel **Timer Viewing**, follow steps 1 through 3. Select **Cancel Schedules**.

Channel Manager

You can edit the channel to your preference.

- (📡) **Channels**: Shows the channel list according to the channel type.
- (★) **Favourites 1-5**: Shows favourite channels.







Using the colour buttons with the **Channel Manager**.

- **A** Red (**Antenna**): Switches to **Air** or **Cable**.
- **D** Blue (**Sorting**): Changes the list ordered by number or name.



* It may differ depending on the model.

Channel Status Display Icons

Icon	Operations
	An analogue channel.
	A channel selected.
	A channel set as a favourite.
	A locked channel.
	Displays the Channel Manager option menu.





Channel Manager Option Menu

Set each channel using the **Channel Manager** menu options (**Watch, Add to Favourites/Edit Favourites, Lock/Unlock, Edit Channel Name, Edit Channel Number, Delete, Select All/Deselect All**).

Option menu items may differ depending on the channel status.

1. Select a channel and press the **TOOLS** button.
2. Select a function and change its settings.



- **Watch:** Watch the selected channel.
- **Add to Favourites/Edit Favourites:** Set channels you watch frequently as favourites. / Add or Delete the selected channel in **Favourites 1-5**.
 1. Select the **Add to Favourites/Edit Favourites**, then press the **ENTER**  button.
 -  If the channel is already added to favourite channel, **Edit Favourites** will be shown.
 2. Press the **ENTER**  button to select **Favourites 1-5**, then press the **OK** button.
 -  One favourite channel can be added in several of Favourites among **Favourites 1-5**.

- **Lock/Unlock:** Lock a channel so that the channel cannot be selected and viewed.



NOTE

- This function is available only when the **Channel Lock** is set to **On**.
- The PIN input screen appears. Enter your 4-digit PIN. Change the PIN using the **Change PIN** option.
- **Edit Channel Name** (analogue channels only): Assign your own channel name.
- **Edit Channel Number:** Edit the number by pressing the number buttons desired.



Some area may not be able to support **Edit Channel Name** and **Edit Channel Number** function.

- **Delete**: You can delete a channel to display the channels you want.
- **Deselect All**: Deselect all the selected channels.
 -  You can only select **Deselect All** when one or more channels are selected.
- **Select All**: Select all the channels in the channel list.



❑ Retuning Channels

👉 MENU  → Channel → ENTER 

■ Antenna (Air / Cable) **TOOLS**

Before your television can begin memorising the available channels, you must specify the type of signal source that is connected to the TV (i.e. an **Air** or **Cable** system).



■ Country

(depending on the country)

The PIN input screen appears. Enter your 4 digit PIN number.

- **Digital Channel:** Change the country for digital channels.
- **Analogue Channel:** Change the country for analogue channels.



■ Auto Tuning

(depending on the country)

Scans for a channel automatically and stores in the TV.

 Automatically allocated programme numbers may not correspond to actual or desired programme numbers. If a channel is locked, the PIN input window appears.

- **Auto Tuning**

Air / Cable: Select the antenna source to memorise.

Digital & Analogue / Digital / Analogue: Select the channel source to memorise.

When Antenna Source is set to Air or Cable:

When selecting **Cable** → **Digital & Analogue** or **Digital**: Provide a value to scan for cable channels.

- **Search Mode (Full / Network / Quick)**: Scans for all channels with active broadcast stations and stores them in the TV.
 - ✎ If you select **Quick**, you can set up the **Network, Network ID, Frequency, Modulation** and **Symbol Rate** manually by pressing the button on the remote control.
- **Network (Auto / Manual)**: Selects the **Network ID** setting mode among **Auto** or **Manual**.
- **Network ID**: When **Network** is **Manual**, you can set up **Network ID** using the numeric buttons.

- **Frequency**: Displays the frequency for the channel. (differs in each country)
- **Modulation**: Displays available modulation values.
- **Symbol Rate**: Displays available symbol rates.

- **Cable Search Option**

(depending on the country & cable channels only)

Sets additional search options such as the frequency and symbol rate for a cable network search.

Start frequency / Stop frequency: Set the start or stop frequency (differs in each country).

Symbol Rate: Displays available symbol rates.

Modulation: Displays available modulation values.

■ Manual Tuning

Scans for a channel manually and stores in the TV.

- 📄 If a channel is locked, the PIN input window appears.
- 📄 According to the channel source, **Manual Tuning** may be supported.

When Antenna Source is set to Air or Cable:

- **Digital Channel Tuning**: Scans for a digital channel manually and stores in the TV. Press the **A** (**New**) button to search the digital channels. When scanning has finished, a channel is updated in the channel list.
 - When selecting **Antenna** → **Air: Channel, Frequency, Bandwidth**
 - When selecting **Antenna** → **Cable: Frequency, Modulation, Symbol Rate**

- **Analogue Channel Tuning**: Scans for an analogue channel. Press the **A** (**New**) button to search the digital channels by adjusting the **Programme, Colour System, Sound System, Channel, Search**.



Channel mode

- **P** (programme mode): When tuning is complete, the broadcasting stations in your area have been assigned to the position numbers from P0 to P99. You can select a channel by entering the position number in this mode.
- **C** (aerial channel mode) / **S** (cable channel mode): These two modes allow you to select a channel by entering the assigned number for each aerial broadcasting station or cable channel.

■ Edit Channel Number (Disable / Enable)

(depending on the country)

Use this to change channel number. When channel number is changed, channel information is not updated automatically.



■ Fine Tune

(analogue channels only)

If the signal is weak or distorted, fine tune the channel manually.

 Fine tuned channels are marked with an asterisk “*”.

 To reset the fine-tuning, select **Reset**.



■ Transfer Channel List

(depending on the country)

Imports or exports the channel map. You should connect a USB storage to use this function.

 The PIN number input screen appears. Enter your 4 digit PIN number.

- **Import from USB:** Import channel list from USB.
- **Export to USB:** Export channel list to USB.

❑ Changing the Preset Picture Mode

 MENU  → **Picture** → **Picture Mode** → ENTER 

■ **Picture Mode**

Select your preferred picture type.

 When connecting a PC, you can only make changes to the **Entertain** and **Standard**.

- **Dynamic**: Suitable for a bright room.
- **Standard**: Suitable for a normal environment.
- **Natural** for LED 5 series 32-46 inches: Suitable for reducing eye strain.
- **Movie**: Suitable for watching movies in a dark room.
- **Entertain**: Suitable for watching movies and games.

 It is only available when connecting a PC.

❑ Adjusting Picture Settings

■ Samsung MagicAngle for LED 4 series 19 inches, 5 series 22-27 inches

 MENU  → Picture → Samsung MagicAngle → ENTER 

Adjust screen viewing Angle to optimize screen quality according to your viewing position.

- **Samsung MagicAngle:** When viewing the screen at an angle from below or above by setting the appropriate mode for each position you can obtain a similar picture quality as viewing the screen directly from the front.

Off: Select when viewing from the front position.

Lean Back Mode: Select when viewing from a slightly lower position.



Standing Mode: Select when viewing from the upper position.

- **Mode:** Adjust screen viewing angle.

 When **Samsung MagicAngle** is set to **Lean Back Mode** or **Standing Mode**, **Gamma** is not available.

■ Backlight / Contrast / Brightness / Sharpness / Colour / Tint (G/R)

Your television has several setting options for picture quality control.

 **MENU**  → **Picture** → **Backlight** → **ENTER** 

NOTE

- In analogue **TV**, **Ext.**, **AV** modes of the PAL system, the **Tint (G/R)** function is not available.
- When connecting a PC, you can only make changes to **Backlight**, **Contrast**, **Brightness** and **Sharpness**.
- Settings can be adjusted and stored for each external device connected to the TV.

■ Screen Adjustment

Set the various picture options such as picture size and aspect ratio.

- **Picture Size:** Your cable box/satellite receiver may have its own set of screen sizes as well. However, we highly recommend you use 16:9 mode most of the time.

Auto Wide: Automatically adjusts the picture size to the **16:9** aspect ratio.

16:9: Sets the picture to 16:9 wide mode.

Wide Zoom: Magnifies the picture size more than 4:3.

 Adjusts the **Position** by using ▲, ▼ buttons.

Zoom: Magnifies the 16:9 wide pictures vertically to fit the screen size.

 Adjusts the **Zoom** or **Position** by using ▲, ▼ button.

4:3: Sets the picture to basic (4:3) mode.

 Do not watch in 4:3 format for a long time. Traces of borders displayed on the left, right and centre of the screen may cause image retention (screen burn) which are not covered by the warranty.

Screen Fit: Displays the full image without any cut-off when HDMI (720p / 1080i / 1080p) or Component (1080i / 1080p) signals are inputted.

Smart View1 **for LED 5 series 32-46 inches**: Reduces original screen by 50%.

Smart View2 **for LED 5 series 32-46 inches**: Reduces original screen by 25%.

 **NOTE**

- **Smart View1** is enabled only in HDMI mode.
- **Smart View2** is enabled only in DTV and HDMI modes.
- The picture size can vary depending on the input resolution when content is played using **Videos** under **My Downloads**.

- **Position**: Adjust the picture position. It is only available in **Screen Fit** or **Wide Zoom**.
- **Zoom/Position**: Adjust the picture position. It is only available in **Zoom**.



NOTE

- After selecting **Screen Fit** in HDMI (1080i / 1080p) or Component (1080i / 1080p) mode, you may need to centre the picture:
 1. Press the ▲ or ▼ button to select **Position**.
 2. Press the **ENTER**  button.
 3. Press the ▲, ▼, ◀ or ▶ button to move the picture.
- Depending on the input source, the picture size options may vary.
- If you want to reset the position you adjusted, select **Reset** in the **Position** screen. The picture will be set to its default position.

- The available items may differ depending on the selected mode.
- When connecting a PC, only **16:9** and **4:3** modes can be adjusted.
- Settings can be adjusted and stored for each external device connected to an input on the TV.
- If you use the **Screen Fit** function with HDMI 720p input, 1 line will be cut at the top, bottom, left and right as in the overscan function.
- **4:3 Screen Size (16:9 / Wide Zoom / Zoom / 4:3)**: Available only when picture size is set to **Auto Wide**. You can determine the desired picture size at the 4:3 WSS (Wide Screen Service) size or the original size. Each European country requires different picture size.

- **PC Screen Adjustment**

 It is available in **PC** mode.

Coarse / Fine: Removes or reduces picture noise. If the noise is not removed by Fine-tuning alone, then adjust the frequency as best as possible (**Coarse**) and Fine-tune again. After the noise has been reduced, readjust the picture so that it is aligned to the centre of screen.

Position: Adjust the PC's screen positioning if it does not fit the TV screen. Press the ▲ or ▼ button to adjust the Vertical-Position. Press the ◀ or ▶ button to adjust the Horizontal-Position.

Image Reset: Resets the image to default settings.

■ Auto Adjustment **TOOLS**

 **MENU**  → **Picture** → **Auto Adjustment** → **ENTER** 

Adjust frequency values/positions and fine tune the settings automatically.

 It is available in **PC** mode.

 Not available when connecting with an HDMI/DVI cable.

Using Your TV as a Computer (PC) Display

Setting Up Your PC Software (Based on Windows XP)

◀ Depending on the version of Windows and the video card, the actual screens on your PC may differ in which case the same basic set-up information will almost always be applied. (If not, contact your computer manufacturer or Samsung Dealer.) ▶

1. Click on “Control Panel” on the Windows start menu.
2. Click on “Appearance and Themes” in the “Control Panel” window and a display dialog-box will appear.
3. Click on “Display” and a display dialog box will appear.
4. Navigate to the “Settings” tab on the display dialog-box.
 - The correct size setting (resolution)
 - If a vertical-frequency option exists on your display settings dialog box, the correct value is “60” or “60 Hz”. Otherwise, just click “OK” and exit the dialog box.

❑ Changing the Picture Options

■ Advanced Settings

👉 MENU  → Picture → Advanced Settings → ENTER 

(available in **Standard / Movie** mode)

You can adjust the detailed setting for the screen including colour and contrast.

👉 When connecting a PC, you can only make changes to **Gamma** and **White Balance**.

- **Black Tone (Off / Dark / Darker / Darkest)**: Select the black level to adjust the screen depth.

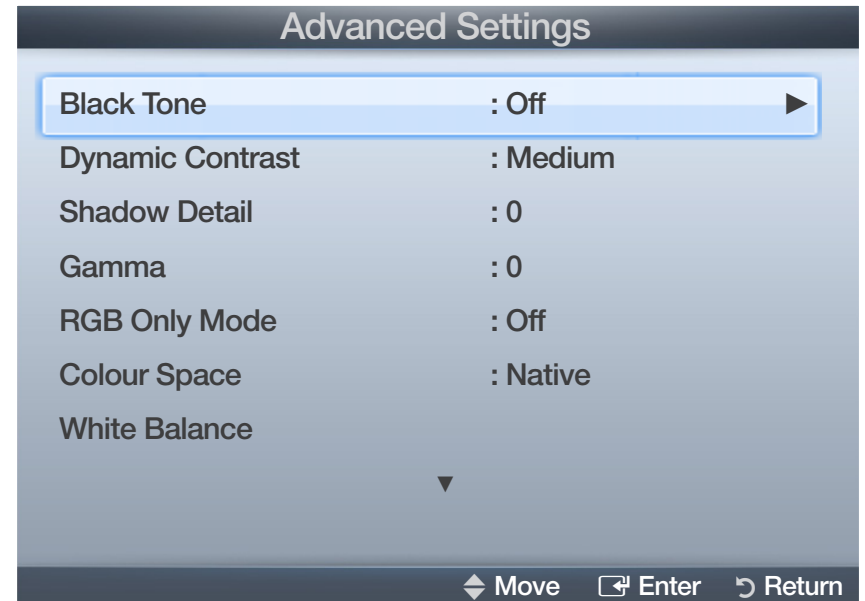

- **Dynamic Contrast (Off / Low / Medium / High)**: Adjust the screen contrast.
- **Shadow Detail**: Increase the brightness of dark images.
- **Gamma**: Adjust the primary colour intensity.
- **RGB Only Mode (Off / Red / Green / Blue)**: Displays the Red, Green and Blue colour for making fine adjustments to the hue and saturation.
- **Colour Space (Auto / Native)**: Adjust the range of colours available to create the image.



- **White Balance:** Adjust the colour temperature for a more natural picture.
R-Offset / G-Offset / B-Offset: Adjust each colour's (red, green, blue) darkness.
R-Gain / G-Gain / B-Gain: Adjust each colour's (red, green, blue) brightness.
Reset: Resets the **White Balance** to its default settings.
- **Flesh Tone:** Emphasize pink "Flesh Tone."
- **Edge Enhancement (Off / On):** Emphasize object boundaries.
- **Motion Lighting (Off / On):** Reduce power consumption by brightness control adapted motion.
- **LED Motion Plus (Off / On)** **for LED 5 series 32-46 inches**: Removes drag from fast scenes with a lot of movement to provide a clear picture.

Picture Options

 MENU  → **Picture** → **Picture Options** → ENTER 

 When connecting a PC, you can only make changes to the **Colour Tone**.

- **Colour Tone (Cool / Standard / Warm1 / Warm2)**

 **Warm1** or **Warm2** will be deactivated when the picture mode is **Dynamic**.

 Settings can be adjusted and stored for each external device connected to an input on the TV.

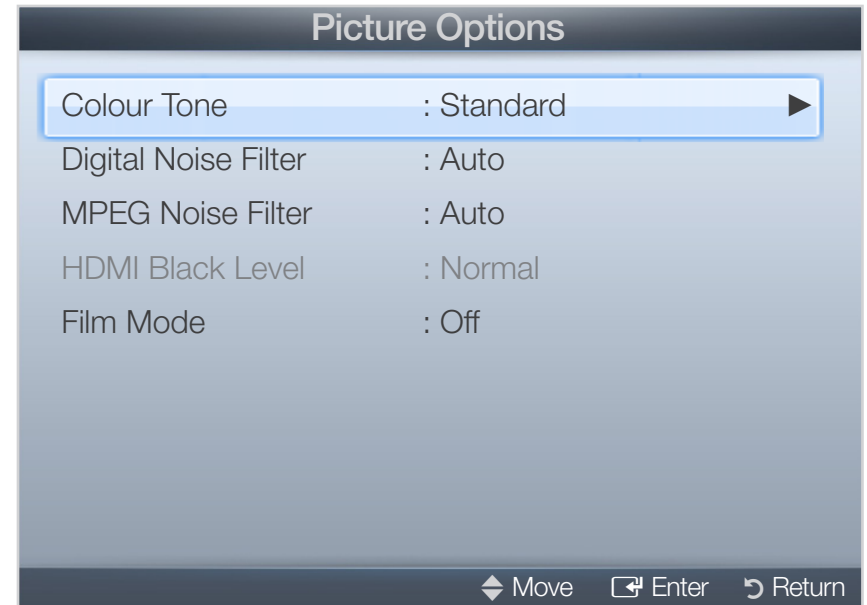

- **Digital Noise Filter (Off / Low / Medium / High / Auto / Auto Visualisation):** If the broadcast signal received by your TV is weak, you can activate the **Digital Noise Filter** feature to reduce any static and ghosting that may appear on the screen.

 When the signal is weak, try other options until the best picture is displayed.

Auto Visualisation: When changing analogue channels, displays signal strength.

 Only available for analogue channels.

 When the **INFO** button is pressed, the signal strength bar is displayed.

 When bar is green, you are receiving the best possible signal.

- **MPEG Noise Filter (Off / Low / Medium / High / Auto):** Reduces MPEG noise to provide improved picture quality.

- **HDMI Black Level (Low / Normal)**: Selects the black level on the screen to adjust the screen depth.
 - ☞ Available only in **HDMI** mode (RGB signals).
- **Film Mode (Off / Auto1 / Auto2)**: Sets the TV to automatically sense and process film signals from all sources and adjust the picture for optimum quality.
 - ☞ Available in TV mode, AV, COMPONENT (480i / 1080i) and HDMI (1080i).
 - ☞ If the screen does not seem natural, change its option to **Off / Auto1 / Auto2** in **Film Mode**.

■ **Reset Picture (OK / Cancel)**

Resets your current picture mode to its default settings.



❑ Changing the Preset Sound Mode

 MENU  → **Sound** → **Sound Mode** → ENTER 

■ **Sound Mode**

- **Standard**: Selects the normal sound mode.
- **Music**: Emphasizes music over voices.
- **Movie**: Provides the best sound for movies.
- **Clear Voice**: Emphasizes voices over other sounds.
- **Amplify**: Increase the intensity of high-frequency sound to allow a better listening experience for the hearing impaired.

 If **Speaker Select** is set to **External Speaker**, **Sound Mode** is disabled.

□ Sound Systems, Etc.

 MENU  → Sound → Sound Effect → ENTER 

■ Sound Effect

(standard sound mode only)

Use the up and down arrow keys to select an option, and then press **ENTER** .

- **SRS TruSurround HD (Off / On)**

(standard sound mode only)

This function provides a virtual 5.1 channel surround sound experience through a pair of speakers using HRTF (Head Related Transfer Function) technology.

- **SRS TruDialog (Off / On)**

(standard sound mode only)

This function allows you to increase the intensity of a voice over background music or sound effects so that dialog can be heard more clearly.

- **Equalizer**

Use Equalizer to customize sound setting for each speaker.

Balance: Adjusts the balance between the right and left speaker.

100Hz / 300Hz / 1kHz / 3kHz / 10kHz (Bandwidth Adjustment): Adjusts the level of specific bandwidth frequencies.

Reset: Resets the equalizer to its default settings.



If **Speaker Select** is set to **External Speaker**, **Sound Effect** is disabled.

■ Broadcast Audio Options

- **Audio Language**

(digital channels only)

Change the default value for audio languages.



The available language may differ depending on the broadcast.

- **Audio Format**

(digital channels only)

When sound is emitted from both the main speaker and the audio receiver, a sound echo may occur due to the decoding speed difference between the main speaker and the audio receiver. In this case, use the TV Speaker function.



Audio Format option may differ depending on the broadcast. 5.1ch Dolby digital sound is only available when connecting an external speaker through an optical cable.

- **Audio Description**

(not available in all locations) (digital channels only)

This function handles the Audio Stream for the AD (Audio Description) which is sent along with the Main audio from the broadcaster.

 **Audio Description (Off / On):** Turn the audio description function on or off.

 **Volume:** Adjust the audio description volume.



■ Additional Settings

- **DTV Audio Level (MPEG / HE-AAC)** (digital channels only): This function allows you to reduce the disparity of a voice signal (which is one of the signals received during a digital TV broadcast) to a desired level.
 - ☞ According to the type of broadcast signal, **MPEG / HE-AAC** can be adjusted between -10dB and 0dB.
 - ☞ To increase or decrease the volume, adjust between the range 0 and -10 respectively.

- **SPDIF Output:** SPDIF (Sony Philips Digital InterFace) is used to provide digital sound, reducing interference going to speakers and various digital devices such as a DVD player.

Audio Format: You can select the Digital Audio output(SPDIF) format. The available Digital Audio output(SPDIF) format may differ depending on the input source.

 By connecting to 5.1ch speakers in a Dolby Digital setup, maximize your interactive 3D sound experience.

Audio Delay: Correct audio-video sync problems, when watching TV or video, and when listening to digital audio output using an external device such as an AV receiver (0ms ~ 250ms).

- **Dolby Digital Comp (Line / RF)**: This function minimizes signal disparity between a dolby digital signal and a voice signal (i.e. MPEG Audio, HE-AAC, ATV Sound).

 Select **Line** to obtain dynamic sound, and **RF** to reduce the difference between loud and soft sounds at night time.

Line: Set the output level for signals greater or less than -31dB (reference) to either -20dB or -31dB.

RF: Set the output level for signals greater or less than -20dB (reference) to either -10dB or -20dB.

■ Speaker Settings

- **Speaker Select (External Speaker / TV Speaker)**

A sound echo may occur due to a difference in decoding speed between the main speaker and the audio receiver. In this case, set the TV to **External Speaker**.

 When **Speaker Select** is set to **External Speaker**, the volume and **MUTE** buttons will not operate and the sound settings will be limited.

 When **Speaker Select** is set to **External Speaker**.

- **TV Speaker:** Off, **External Speaker:** On

 When **Speaker Select** is set to **TV Speaker**.

- **TV Speaker:** On, **External Speaker:** On

 If there is no video signal, both speakers will be mute.

- **Auto Volume (Off / Normal / Night)**

To equalize the volume level on each channel, set to **Normal**.

Night: This mode provides an improved sound experience compared to **Normal** mode, making almost no noise. It is useful at night.

 To use the volume control on the source device connected to the TV, set **Auto Volume** to **Off** on the TV. Otherwise, a change to the volume control of the source device may not be applied.

■ **Reset Sound (OK / Cancel)**

Reset all sound settings to the factory defaults.



❑ Selecting the Sound Mode

 DUAL I-II → ENTER 

When you set to **Dual I-II**, the current sound mode is displayed on the screen.

	Audio Type	Dual I-II	Default
A2 Stereo	Mono	Mono	Automatic change
	Stereo	Stereo ↔ Mono	
	Dual	Dual I ↔ Dual II	Dual I
NICAM Stereo	Mono	Mono	Automatic change
	Stereo	Mono ↔ Stereo	
	Dual	Mono → Dual I ↖ Dual II ↙	Dual I

 If the stereo signal is weak and an automatic switching, occurs, then switch to the mono.

 Only activated in stereo sound signal.

 Only available when the **Source** is set to **TV**.

❑ **Setting the Network** for LED 5 series 32-46 inches

■ **Network Settings**

 MENU  → **Network** → **Network Settings** → ENTER 

Set the network connection to use AllShare™ and perform software upgrade.

■ **Network Status**

 MENU  → **Network** → **Network Status** → ENTER 

You can check the current network and Internet status.

■ **AllShare Settings**

 MENU  → **Network** → **AllShare Settings** → ENTER 

Selects whether to use media functions on the network. For details on set up options, refer to the “AllShare™” instructions.

❑ Connecting to a Wired Network

You can attach your TV to your LAN using cable in three ways:

- You can attach your TV to your LAN by connecting the LAN port on the back of your TV to an external modem using a LAN cable. See the diagram below.

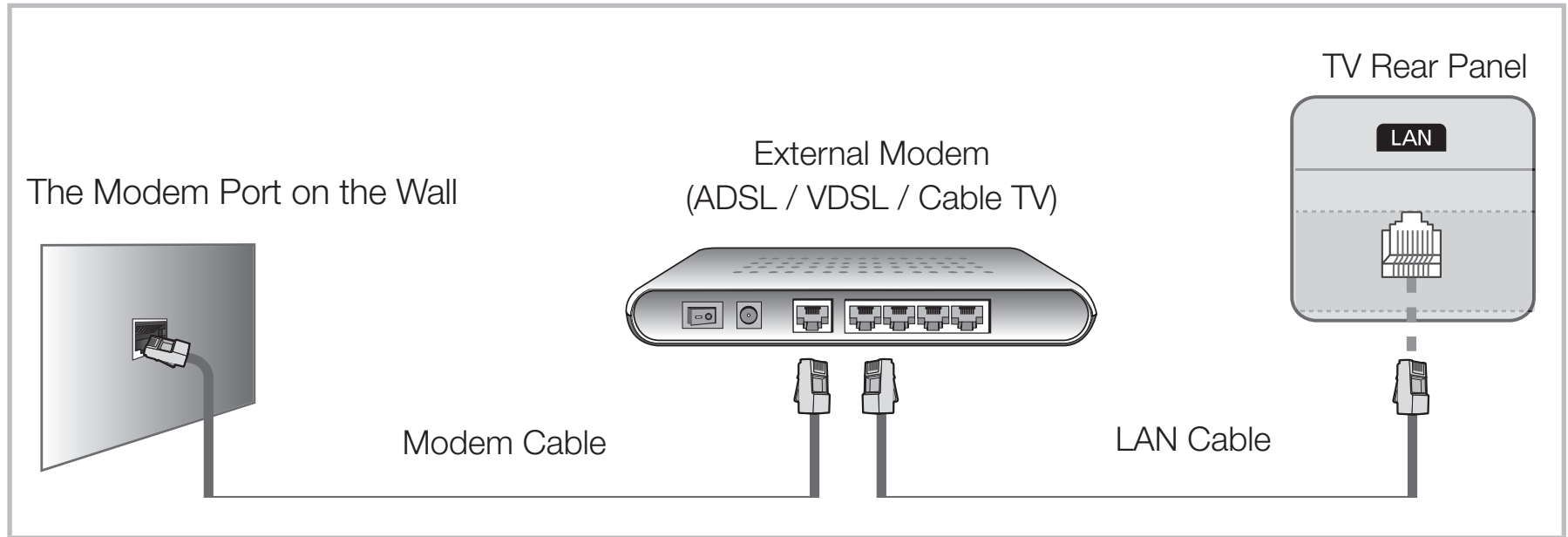

- You can attach your TV to your LAN by connecting the LAN port on the back of your TV to a IP Sharer which is connected to an external modem. Use LAN cable for the connection. See the diagram below.

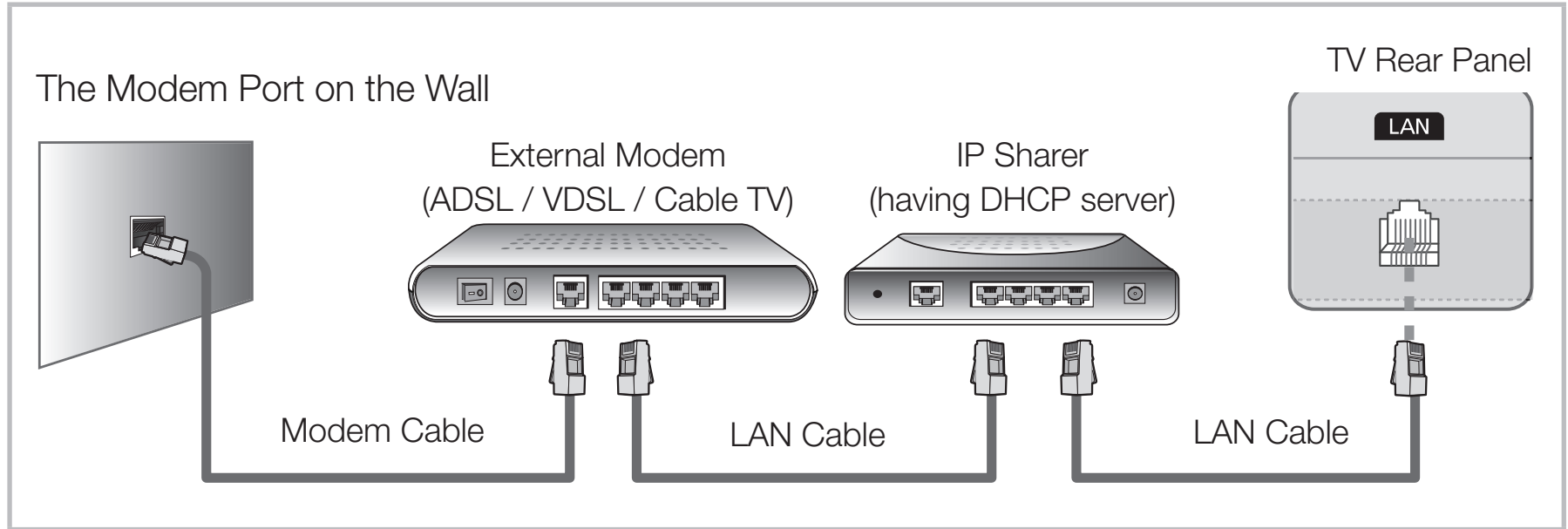

- Depending on how your network is configured, you may be able to attach your TV to your LAN by connecting the LAN port on the back of your TV directly to a network wall outlet using a LAN cable. See the diagram below. Note that the wall outlet is attached to a modem or router elsewhere in your house.

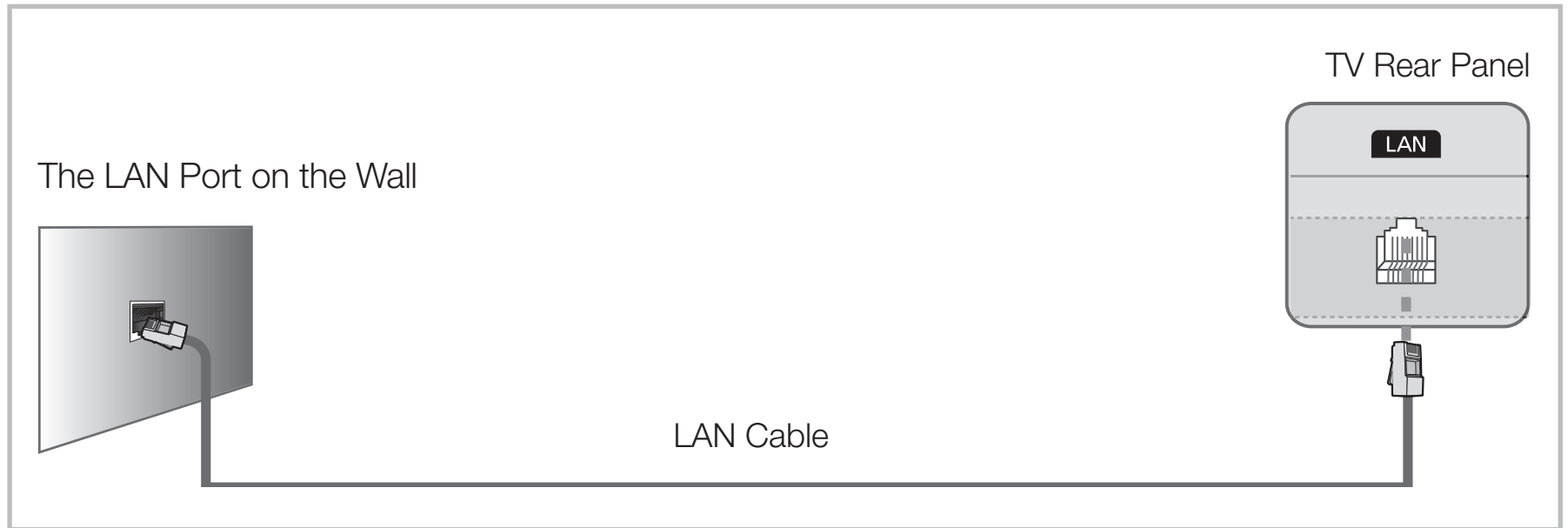

- If you have a Dynamic Network, you should use an ADSL modem or router that supports Dynamic Host Configuration Protocol (DHCP). Modems and routers that support DHCP automatically provide the IP address, subnet mask, gateway, and DNS values your TV needs to access the Internet so you do not have to enter them manually. Most home networks are Dynamic Networks. Some networks require a Static IP address. If your network requires a Static IP address, you must enter the IP address, subnet mask, gateway, and DNS values manually on your TV's Cable Setup Screen when you set up the network connection. To get the IP address, subnet mask, gateway, and DNS values, contact your Internet Service Provider (ISP). If you have a Windows computer, you can also get these values through your computer.

 You can use ADSL modems that support DHCP if your network requires a Static IP address. ADSL modems that support DHCP also let you use Static IP addresses.

 A network speed of lower than 10 Mbps is not supported.

■ Network Setup (Auto)

Use the Automatic Network Setup when connecting your TV to a network that supports DHCP. To set up your TV's cable network connection automatically, follow these steps:

How to set up automatically

1. Go to **Network Settings** screen. To enter it, follow the directions of **Network Settings**.
2. Select the **Wired**.
3. The network connection screen appears, and network setting is done.

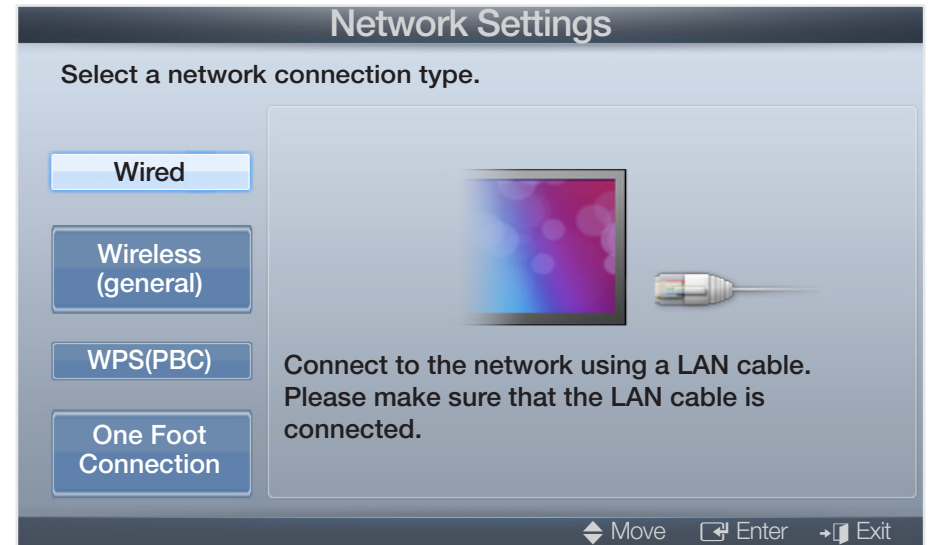

- ✎ If it fails to set automatically, check the connection of LAN port.
- ✎ If you cannot find network connection values or if you want to set connection manually, set it to Manual. Refer to following “How to set up manually”.



■ Network Setup (Manual)

Use the Manual Network Setup when connecting your TV to a network that requires a Static IP address.

Getting the Network Connection Values

To get the Network connection values on most Windows computers, follow these steps:

1. Right click the Network icon on the bottom right of the screen.
2. In the pop-up menu that appears, click Status.
3. On the dialog that appears, click the Support tab.
4. On the Support Tab, click the Details button. The Network connection values are displayed.

How to set up manually

To set up your TV's cable network connection manually, follow these steps:

1. Follow Steps 1 through 2 in the “How to set up automatically” procedure.
2. Select the **IP Settings** on network test screen.
3. Set **IP Mode** to **Manual**.
4. Press the ▼ button on your remote to go to the first entry field.

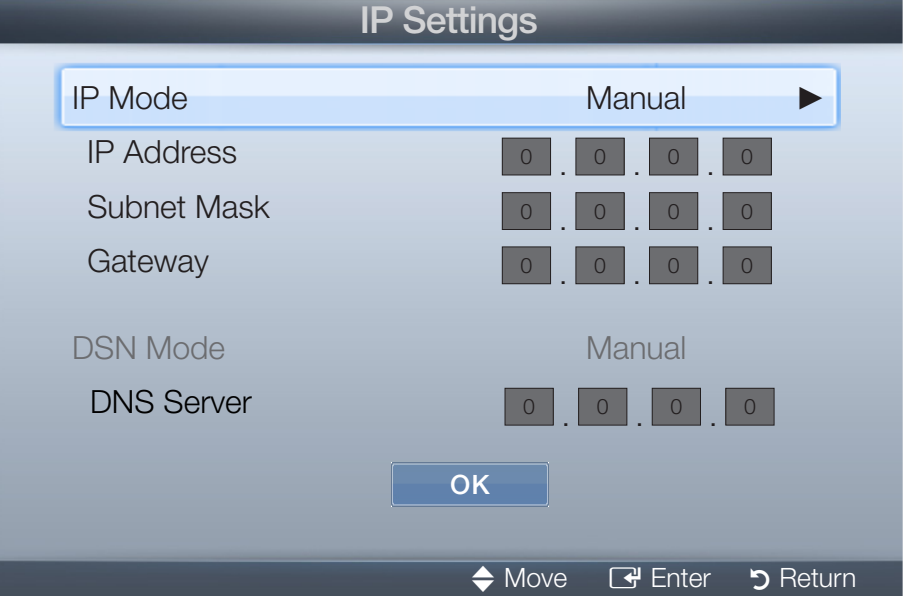

IP Settings

IP Mode Manual ▶

IP Address 0 . 0 . 0 . 0

Subnet Mask 0 . 0 . 0 . 0

Gateway 0 . 0 . 0 . 0

DSN Mode Manual

DNS Server 0 . 0 . 0 . 0

OK

◊ Move ↵ Enter ↻ Return

5. Enter the **IP Address**, **Subnet Mask**, **Gateway**, and **DNS Server** values. Use the number buttons on your remote to enter numbers and the arrow buttons to move from one entry field to another.
6. When done, select the **OK**.
7. The network connection screen appears, and network setting is done.



❑ Connecting to a Wireless Network for LED 5 series 32-46 inches

To connect your TV to your network wireless, you need a wireless router or modem and a Samsung Wireless LAN Adapter (WIS09ABGN, WIS09ABGN2, WIS10ABGN), which you connect to your TV's back or side panel USB port. See the illustration below.

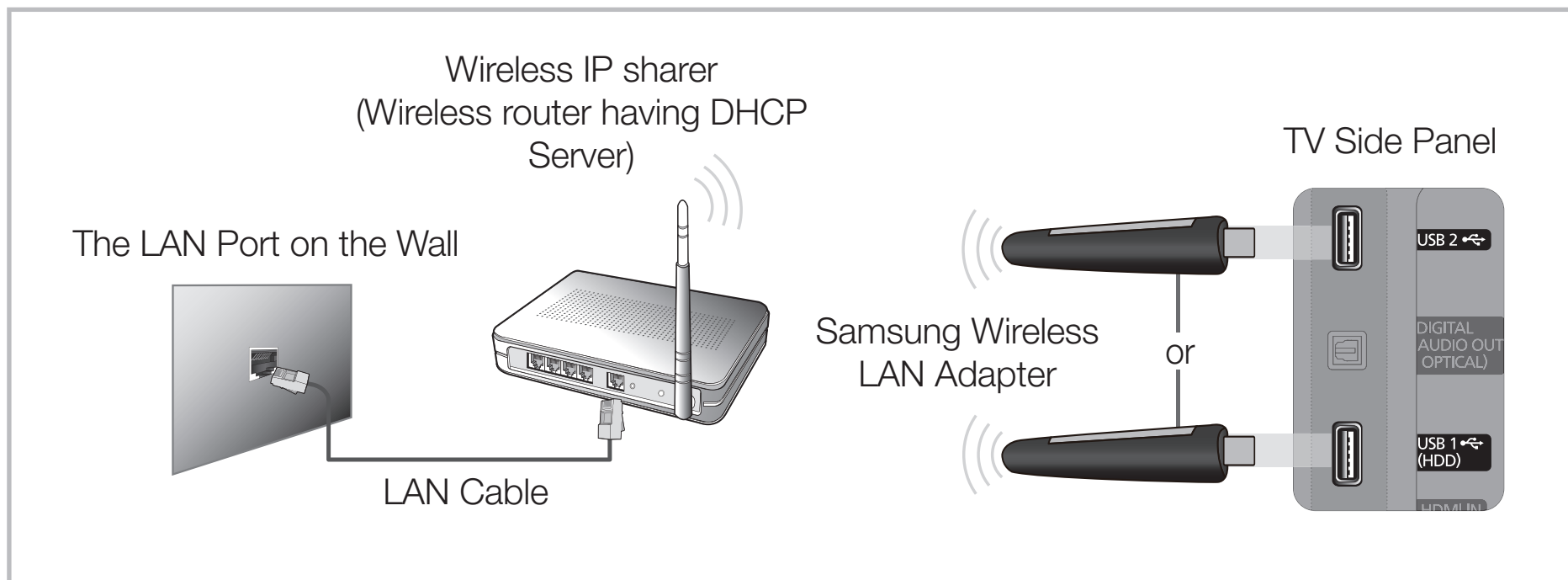

Samsung's Wireless LAN adapter is sold separately and is offered by select retailers and Ecommerce sites. Samsung's Wireless LAN adapter supports the IEEE 802.11a/b/g and n communication protocols. Samsung recommends using IEEE 802.11n. When you play video over a network connection, the video may not be played smoothly.



NOTE

- You must use the “Samsung Wireless LAN Adapter” (WIS09ABGN, WIS09ABGN2, WIS10ABGN) to use a wireless network.
- Samsung Wireless LAN Adapter and the USB extension Cable are sold separately and are offered by select retailers and Ecommerce sites.

- To use a wireless network, your TV must be connected to a wireless IP sharer (either a router or a modem). If the wireless IP sharer supports DHCP, your TV can use a DHCP or static IP address to connect to the wireless network.
- Select a channel for the wireless IP sharer that is not currently being used. If the channel set for the wireless IP sharer is currently being used by another device nearby, this will result in interference and communication failure.
- If you apply a security system other than the systems listed below, it will not work with the TV.

- If HIGH PURE THROUGHPUT (Greenfield) 802.11n mode is selected and the Encryption type is set to WEP, TKIP or TKIP AES (WPS2Mixed) for your wireless router, Samsung TVs will not support a connection in compliance with new Wi-Fi certification specifications.
- If your wireless router supports WPS (Wi-Fi Protected Setup), you can connect to the network via PBC (Push Button Configuration) or PIN (Personal Identification Number). WPS will automatically configure the SSID and WPA key in either mode.

- If your router, modem, or device is not certified, it may not connect to the TV via the “Samsung Wireless LAN Adapter.”
- Ensure the TV is turned off before you connect the Samsung Wireless LAN Adapter.
- Connection Methods: You can setup the wireless network connection on five ways.
 - Auto Setup (Using the Auto Network Search function)
 - Manual Setup
 - **WPS (PBC)**
 - **One Foot Connection**
 - **Ad hoc**
- The Samsung Wireless LAN Adapter may not be recognized when using a connection via a USB hub or via a USB extension cable other than the cable supplied.

Notice

The picture may appear corrupted or have static for some channels when the TV is connected to the Samsung Wireless LAN Adapter. In such a case, establish a connection using one of the following methods or connect the Samsung Wireless LAN Adapter using a USB cable in a place that is not affected by radio interference.

Method 1

Connect using the USB right angle adapter To connect the Samsung Wireless LAN Adapter using the USB right angle adapter, follow these steps:

1. Connect the USB right angle adapter to the Samsung Wireless LAN Adapter.
2. Connect the other end of the right angle adapter to the USB port.



Method 2

Connect via an extension cable

To reconnect the Samsung Wireless LAN Adapter using the extension cable, follow these steps:

1. Connect the extension cable to the USB port.
 2. Connect the extension cable and Samsung Wireless LAN Adapter.
 3. Attach the Samsung Wireless LAN Adapter to the back of the TV near the top, using double-sided adhesive tape.
-  The Samsung Wireless LAN Adapter should be installed in an interference-free area in order to avoid interference between the adapter and tuner.

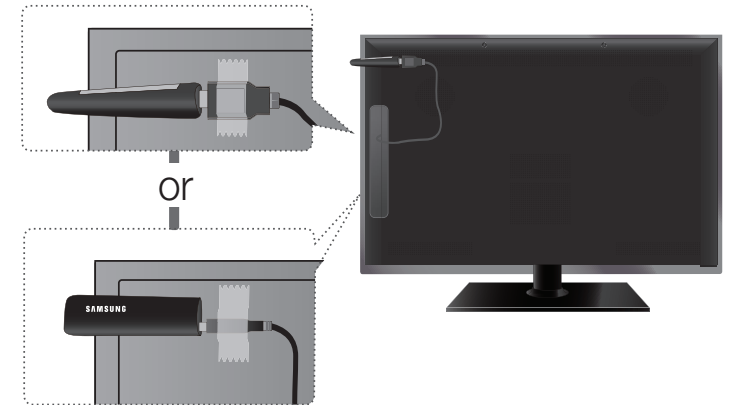

■ Network Setup (Auto)

Most wireless networks have an optional security system that requires devices that access the network to transmit an encrypted security code called an Access or Security Key. The Security Key is based on a Pass Phrase, typically a word or a series of letters and numbers of a specified length you were asked to enter when you set up security for your wireless network. If you use this method of setting up the network connection, and have a Security Key for your wireless network, you will have to enter the Pass Phrase during the setup process.

How to set up automatically

1. Go to **Network Settings** screen. To enter it, follow the directions of **Network Settings**.

2. Select the **Wireless(general)**.
3. The Network function searches for available wireless networks. When done, it displays a list of the available networks.
4. In the list of networks, press the ▲ or ▼ button to select a network, and then press the **ENTER**  button.

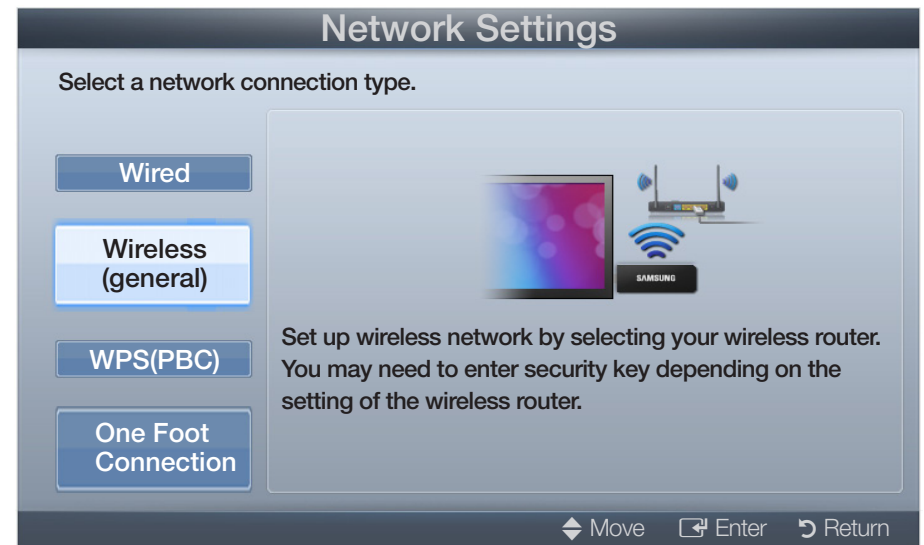

-  If the wireless router is set to Hidden (Invisible), you have to select **Add Network** and enter the correct network **Name (SSID)** and Security key to establish the connection.
5. If the Security screen pop-up appears, go to step 6. If you select the wireless router which does not have security, go to step 7.

6. If the wireless router has security, enter the Security key(Security or PIN), then select **Done**.

 When you enter the Security key(Security or PIN), use ▲/▼/◀/▶ buttons on your remote to select number/characters.

 You should be able to find the Pass Phrase on one of the set up screens you used to set up your router or modem.

7. The network connection screen appears, and network setting is done.

 If it fails to set Security key(Security or PIN), select **Retry** or **IP Settings**.

 If you want to set connection manually, select the **IP Settings**. Refer to following “How to set up manually”.



■ Network Setup (Manual)

Use the Manual Network Setup when connecting your TV to a network that requires a Static IP address.

Getting the Network Connection Values

To get the Network connection values on most Windows computers, follow these steps:

1. Right click the Network icon on the bottom right of the screen.
2. In the pop-up menu that appears, click Status.
3. On the dialog that appears, click the Support tab.
4. On the Support Tab, click the Details button. The Network connection values are displayed.

How to set up manually

To set up your TV's cable network connection manually, follow these steps:

1. Follow Steps 1 through 7 in the “How to set up automatically” procedure.
2. Select the **IP Settings** on network test screen.
3. Set **IP Mode** to **Manual**.
4. Press the ▼ button on your remote to go to the first entry field.
5. Enter the **IP Address**, **Subnet Mask**, **Gateway**, and **DNS Server** values.
Use the number buttons on your remote to enter numbers and the arrow buttons to move from one entry field to another.
6. When done, select the **OK**.
7. The network connection screen appears, and network setting is done.

■ Network Setup (WPS(PBC))

How to set up using WPS(PBC)

If your router has a WPS(PBC) button, follow these steps:

1. Go to **Network Settings** screen. To enter it, follow the directions of **Network Settings**.
2. Select the **WPS(PBC)**.
3. Press the WPS(PBC) button on your router within 2 minutes. Your TV automatically acquires all the network setting values it needs and connects to your network.
4. The network connection screen appears, and network setting is done.

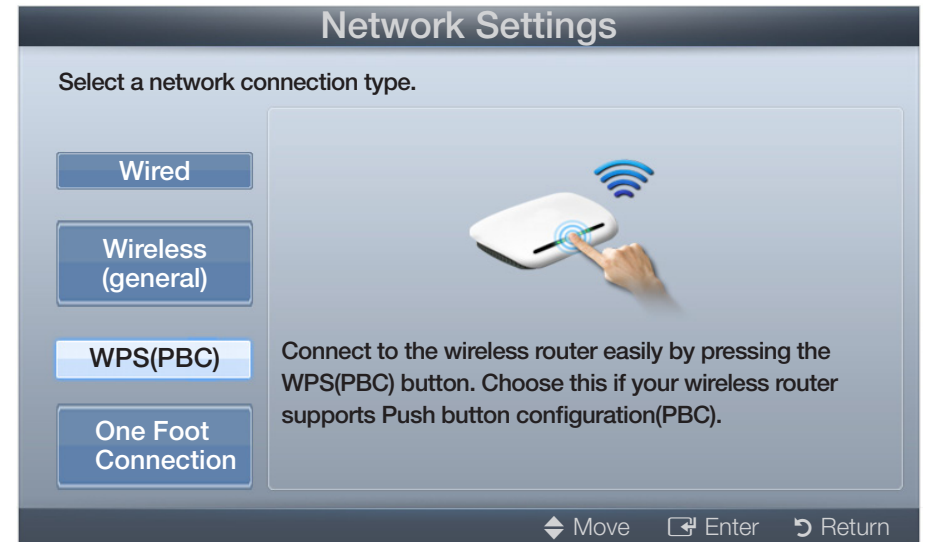

■ Network Setup (One Foot Connection)

The **One Foot Connection** make you easy to connect samsung TV and samsung wireless router by placing samsung wireless router within 1foot(25cm) from samsung TV. If your wireless router does not support **One Foot Connection**, you must connect using one of the other methods.

 You can check for equipment that supports **One Foot Connection** on www.samsung.com.

How to set up using One Foot Connection

Turn on the power of wireless router and TV.

1. Go to **Network Settings** screen. To enter it, follow the directions of **Network Settings**.

2. Select the **One Foot Connection**.

3. Place the wireless router in parallel with the Samsung Wireless LAN Adapter giving a gap no larger than 25cm.

4. Wait until the connection is automatically established.

5. The network connection screen appears, and network setting is done.

6. Place the wireless router in a desired location.

 If the wireless router settings change or you install a new wireless router, you must perform the **One Foot Connection** procedure again, beginning from Step 1.

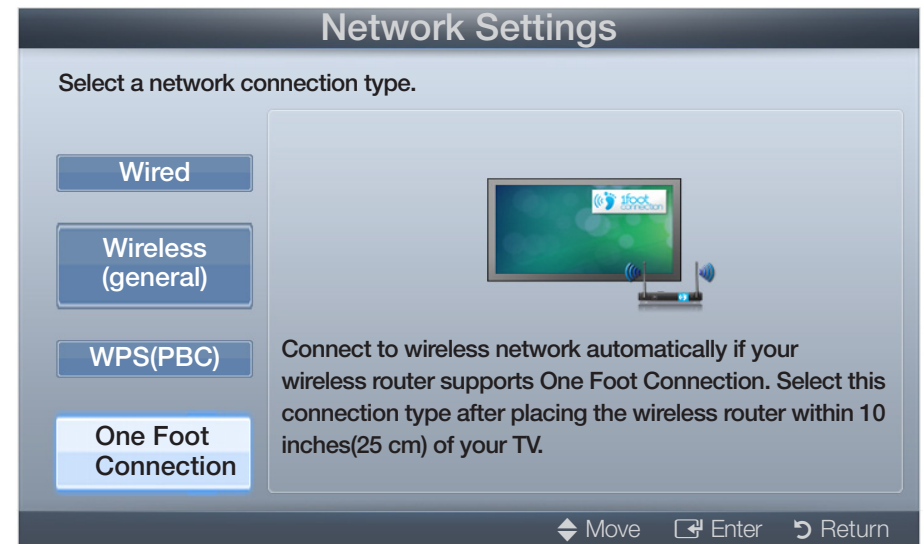



■ Network Setup (Ad-Hoc)

You can connect to a mobile device supporting Ad-hoc without an wireless router through the “Samsung Wireless LAN Adapter”. When connecting mobile device, you can use files on device or connect internet using AllShare or Multimedia function.

How to connect to new Ad-hoc

1. Go to **Network Settings** screen. To enter it, follow the directions of **Network Settings**.
2. Select the **Wireless(general)**.
3. When select the **Ad hoc**, the message "**Ad hoc service supports a direct connection with Wi-Fi compatible devices like a cell phone or PC. The existing network system may have limited functionality. Do you want to change the network connection?**". is displayed.

4. Input the generated **Network Name (SSID)** and **Security Key** into the device you want to connect.
 -  If network does not operate normally, check the **Network Name (SSID)** and **Security key** again. An incorrect **Security key** may cause a malfunction.
 -  If a device is connected once, it is displayed in **Network Setting** list. When you connect it again, you can find it in network setting list.

If Your TV Fails to Connect to the Internet

Your TV may not be able to connect to the Internet because your ISP has permanently registered the MAC address (a unique identifying number) of your PC or modem, which it then authenticates each time you connect to the Internet as a way of preventing unauthorized access. As your TV has a different MAC address, your ISP can not authenticate its MAC address, and your TV can not connect.

To resolve this problem, ask your ISP about the procedures required to connect devices other than a PC (such as your TV) to the Internet.

If your Internet service provider requires an ID or password to connect to the Internet, your TV may not be able to connect to the Internet. If this is the case, you must enter your ID or password when connecting to the Internet.

The internet connection may fail because of a firewall problem. If this is the case, contact your Internet service provider.

If you cannot connect to the Internet even after you have followed the procedures of your Internet service provider, please contact Samsung Electronics.

□ Setting the Time

 MENU  → **System** → **Time** → ENTER 

■ Time

 The current time will appear every time you press the **INFO** button.

- **Clock**: Setting the clock is for using various timer features of the TV.

 If you disconnect the power cord, you have to set the clock again.

Clock Mode: Set up the current time manually or automatically.

- **Auto**: Set the current time automatically using the time from a digital channel.

 The antenna must be connected in order to set the time automatically.

– **Manual**: Set the current time manually.

 Depending on the broadcast station and signal, the auto time set up may not be correct. In this case, set the time manually.

Clock Set: Set the **Day, Month, Year, Hour** and **Minute** manually.

 Available only when **Clock Mode** is set to **Manual**.

Time Zone (depending on the country): Select your time zone.

 This function is only available when the **Clock Mode** is set to **Auto**.

 When selecting **Manual** in **Time Zone**, **GMT** and **DST** will be activated.

Using the Sleep Timer

 MENU  → **System** → **Time** → **Sleep Timer** → ENTER 

- **Sleep Timer** : Automatically shuts off the TV after a preset period of time. (30, 60, 90, 120, 150 and 180 minutes).

 To cancel **Sleep Timer**, select **Off**.

❑ Setting the On / Off Timer

👉 MENU  → System → Time → On Timer <or> Off Timer → ENTER 

- On Timer 1 / On Timer 2 / On Timer

3: Three different on timer settings can be made. You must set the clock first.

- **Setup**: Select **Off**, **Once**, **Everyday**, **Mon~Fri**, **Mon~Sat**, **Sat~Sun** or **Manual** to set at your convenience. If you select **Manual**, you can set up the day you want to activate the timer.

👉 The ✓ mark indicates the day you've selected.

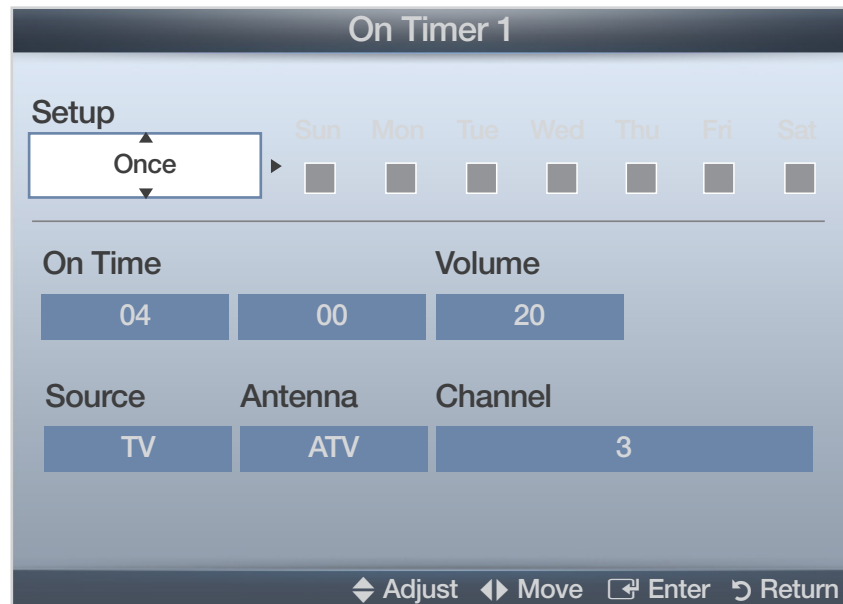

- **On Time**: Set the hour and minute.
- **Volume**: Set the desired volume level.
- **Source**: Select **TV** or **USB** content to be played when the TV is turned on automatically. (**USB** can be selected only when a USB device is connected to the TV)
- **Antenna** (when the **Source** is set to **TV**): Select **ATV** or **DTV**.
- **Channel** (when the **Source** is set to **TV**): Select the desired channel.
- **Music / Photo** (when the **Source** is set to **USB**): Select a folder in the USB device containing music or photo files to be played when the TV is turned on automatically.



NOTE

- If there is no music file on the USB device or the folder containing a music file is not selected, the Timer function does not operate correctly.
- When there is only one photo file in the USB device, the Slide Show will not play.
- If a folder name is too long, the folder cannot be selected.
- Each USB you use is assigned its own folder. When using more than one of the same type of USB, make sure the folders assigned to each USB have different names.
- It is recommended that you use a USB memory stick and a multi card reader when using **On Timer**.
- The **On Timer** function may not work with USB devices with a built-in battery, MP3 players, or PMPs made by some manufacturers because these devices take a long time to be recognized.

- **Off Timer 1 / Off Timer 2 / Off Timer 3:**

Three different off timer settings can be made. You must set the clock first.

Setup: Select **Off**, **Once**, **Everyday**, **Mon~Fri**, **Mon~Sat**, **Sat~Sun** or **Manual** to set at your convenience. If you select **Manual**, you can set up the day you want to activate the timer.

 The ✓ mark indicates the day you've selected.

Off Time: Set the hour and minute.

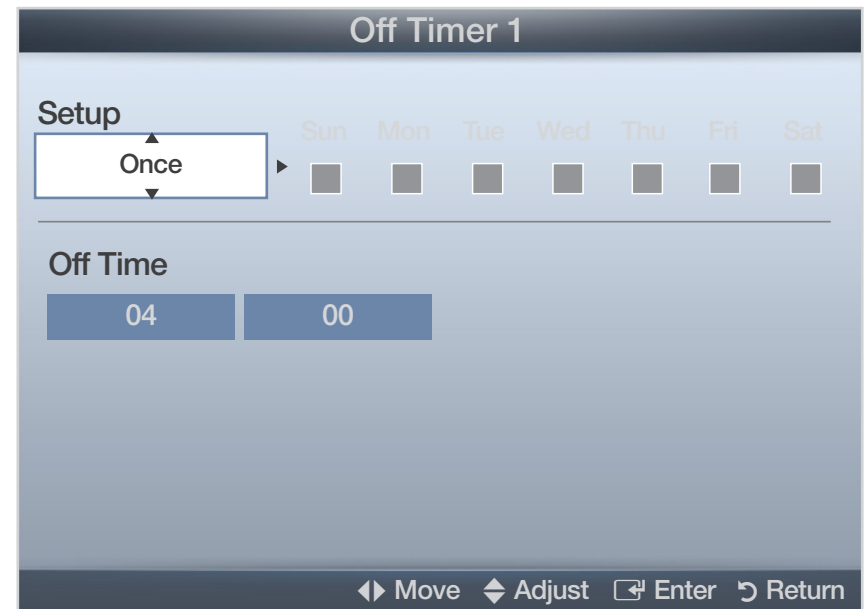

❑ Locking Programme

 MENU  → System → Security → ENTER 



■ Security

 The PIN input screen appears before the setup screen.

 Enter your 4-digit PIN. Change the PIN using the **Change PIN** option.

- **Channel Lock (Off / On)**: Lock channels in Channel Manager, to prevent unauthorized users, such as children, from watching unsuitable programme.

 Only available when the Input source is set to **TV**.

- **Program Rating Lock** (depending on the country): Prevent unauthorized users, such as children, from watching unsuitable programme with a user-defined 4-digit PIN code. If the selected channel is locked, the “” symbol will be displayed.
 -  The items of **Program Rating Lock** differs depending on the country.
- **Change PIN**: Change your password required to set up the TV.

□ Picture In Picture (PIP)

 MENU  → System → PIP → ENTER 

■ PIP TOOLS







You can watch the TV tuner and one external video source simultaneously. **PIP** (Picture-in-Picture) does not function in the same mode.

NOTE

- For PIP sound, refer to the **Sound Select** instructions.
- If you turn the TV off while watching in **PIP** mode, the PIP window will disappear.
- You may notice that the picture in the PIP window becomes slightly unnatural when you use the main screen to view a game or karaoke.

- PIP settings



Main picture	Sub picture
Component, HDMI, PC	TV

- **PIP (Off / On)**: Activate or deactivate the PIP function.
- **Channel**: Select the channel for the sub-screen.
- **Size** ( / ): Select a size for the sub-picture.
- **Position** ( /  /  / ): Select a position for the sub-picture.
- **Sound Select (Main / Sub)**: You can choose the desired sound (**Main** / **Sub**) in **PIP** mode.

□ Economical Solutions

 MENU  → System → Eco Solution → ENTER 

■ Eco Solution

- **Energy Saving (Off / Low / Medium / High / Picture Off)** : This adjusts the brightness of the TV in order to reduce power consumption. If you select **Picture Off**, the screen is turned off, but the sound remains on. Press any button except volume button to turn on the screen.
- **Eco Sensor (Off / On)** : To enhance your power savings; the picture settings will automatically adapt to the light in the room.

 If you adjust the **Backlight**, the **Eco Sensor** will be set to **Off**.

Min Backlight: When **Eco sensor** is **On**, the minimum screen brightness can be adjusted manually.

 If **Eco Sensor** is **On**, the display brightness may change (become slightly darker or brighter) depending on the surrounding light intensity.

- **No-Signal Power Off (Off / 15 min / 30 min / 60 min):**

To avoid unnecessary energy consumption, set how long you want the TV to remain on if it's not receiving a signal.

 Disabled when the PC is in power saving mode.

- **Auto Power Off (Off / On):** The TV will be automatically turned off when no user operation is received for 4 hours.



Other Features

 MENU  → **System** → ENTER 

Language

- **Menu Language:** Set the menu language.
- **Teletext Language** (depending on the country): Set a desired language for teletext.
 -  English is the default in cases where the selected language is unavailable in the broadcast.

- **Preference (Primary Audio Language / Secondary Audio Language / Primary Subtitle Language / Secondary Subtitle Language / Primary Teletext Language / Secondary Teletext Language):** Select a language, which will be the default language when a channel is selected.

 **Primary Teletext Language** and **Secondary Teletext Language** may not be supported in some locations.

■ Subtitle

Use this menu to set the **Subtitle** mode.

- **Subtitle (Off / On)**: Switches subtitles on or off.
- **Subtitle Mode (Normal / Hearing Impaired)**: Sets the subtitle mode.
- **Subtitle Language**: Sets the subtitle language.

 If the programme you are watching does not support the **Hearing Impaired** function, **Normal** automatically activates even if the **Hearing Impaired** mode is selected.

 English is the default in cases where the selected language is unavailable in the broadcast.

■ Digital Text (Disable / Enable)

(UK only)

If the programme broadcasts with digital text, this feature is enabled.

MHEG (Multimedia and Hypermedia Information Coding Experts Group)

An International standard for data encoding systems used in multimedia and hypermedia. This is at a higher level than the MPEG system which includes data-linking hypermedia such as still images, character service, animation, graphic and video files as well as multimedia data. MHEG is user runtime interaction technology and is being applied to various fields including VOD (Video-On-Demand), ITV (Interactive TV), EC (Electronic Commerce), teleeducation, tele-conferencing, digital libraries and network games.

■ Auto Protection Time

- **Auto Protection Time (Off / 2 hours / 4 hours / 8 hours / 10 hours):** If the screen remains idle with a still image for a certain period of time defined by the user, the screen saver is activated to prevent the formation of ghost images on the screen.



■ General

- **Game Mode (Off / On):** When connecting to a game console such as PlayStation™ or Xbox™, you can enjoy a more realistic gaming experience by selecting game mode.



NOTE

- Precautions and limitations for game mode
 - To disconnect the game console and connect another external device, set **Game Mode** to **Off** in the setup menu.
 - If you display the TV menu in **Game Mode**, the screen shakes slightly.
- **Game Mode** is not available in **PC** and **TV** mode.

- After connecting the game console, set **Game Mode** to **On** to prevent poor picture quality.
 - If **Game Mode** is **On**:
 - **Picture Mode** is set to **Standard** and **Sound Mode** is set to **Movie**.
 - **Menu Transparency (Bright / Dark)**: Set the Transparency of the menu.
 - **Boot Logo (Off / On)**: Display Samsung logo when the TV is turned on.
 - **TV Name** **for LED 5 series 32-46 inches**: Make changes the **TV Name**.
-  If you select **User Input**, you can make TV name manually.

■ Anynet+(HDMI-CEC)

For details on set up options, refer to the “Anynet+(HDMI-CEC)” instructions.



■ DivX® Video On Demand

Shows the registration code authorized for the TV. If you connect to the DivX web site and register, you can download the VOD registration file. If you play the VOD registration using **My Downloads**, the registration is completed.

 For more information on DivX® VOD, visit “<http://vod.divx.com>”.

■ Common Interface

- **CI Menu:** This enables the user to select from the CAM-provided menu. Select the CI Menu based on the menu PC Card.
- **Application Info:** View information on the CAM inserted into the CI slot and on the “CI or CI+ CARD” which is inserted into the CAM. You can install the CAM anytime whether the TV is on or off.
 1. Purchase a CI CAM module at your nearest dealer or by phone.
 2. Firmly insert the “CI or CI+ CARD” into the CAM in the direction of the arrow.
 3. Insert the CAM with the “CI or CI+ CARD” into the common interface slot, in the direction of the arrow so that it aligns parallel with the slot.
 4. Check if you can see a picture on a scrambled signal channel.

■ **Network Remote Control** for LED 5 series 32-46 inches

Turn on/off or give permission to Samsung mobile phones devices to connect with and control the TV.

You must have a Samsung Mobile phone/device which supports Network Remote Control. For more details, refer to each device's manual.



Support Menu

 MENU  → Support → e-Manual → ENTER 

■ e-Manual

You can read the introduction and instructions about the TV features stored in your TV.

 For the detailed information about e-Manual Screen, refer to “How to view the e-Manual” in User Manual.

■ Self Diagnosis

- 📖 **Self Diagnosis** might take few seconds, this is part of the normal operation of the TV.
- **Picture Test (Yes / No)**: Use to check for picture problems.
- **Sound Test (Yes / No)**: Use the built-in melody sound to check for sound problems.
 - 📖 If you hear no sound from the TV's speakers, before performing the sound test, make sure **Speaker Select** is set to **TV Speaker** in the **Sound** menu.
 - 📖 The melody will be heard during the test even if **Speaker Select** is set to **External Speaker** or the sound is muted by pressing the **MUTE** button.

- **Signal Information:** (digital channels only) HDTV channel's reception quality is either perfect or the channels are unavailable. Adjust your antenna to increase signal strength.
- **Troubleshooting:** If the TV seems to have a problem, refer to this description.
 - ✍ If none of these troubleshooting tips apply, contact the Samsung customer service centre.

■ Software Upgrade

Software Upgrade can be performed by downloading the latest firmware from “www.samsung.com” to a USB memory device.

Current Version-the software already installed in the TV.

 Software is represented as “Year/ Month/Day_Version”.

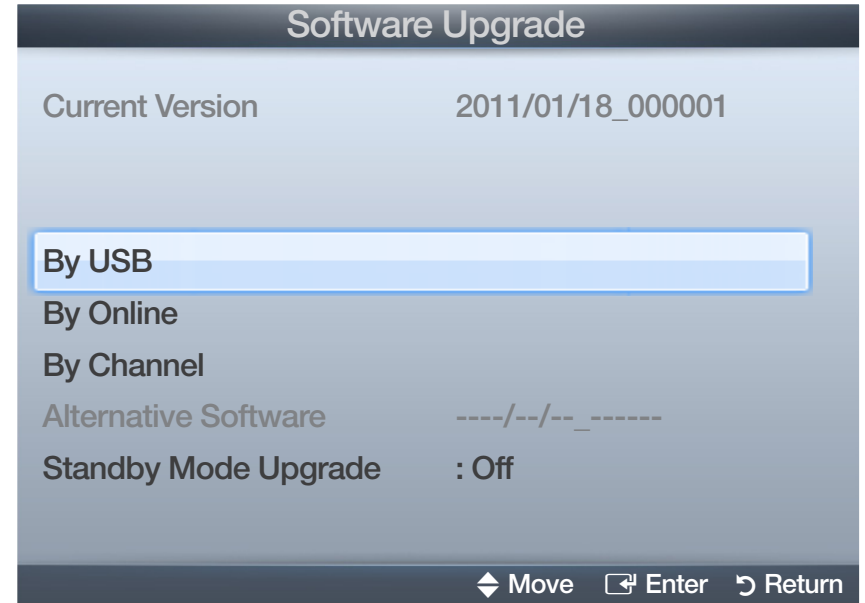

* It may differ depending on the model.

Installing the Latest Version

- **By USB:** Insert a USB drive containing the firmware upgrade file, downloaded from “www.samsung.com” into the TV. Please be careful not to disconnect the power or remove the USB drive until upgrades are complete. The TV will be turned off and on automatically after completing the firmware upgrade. When software is upgraded, video and audio settings you have made will return to their default settings. We advise you to write down your settings so that you can easily reset them after the upgrade.

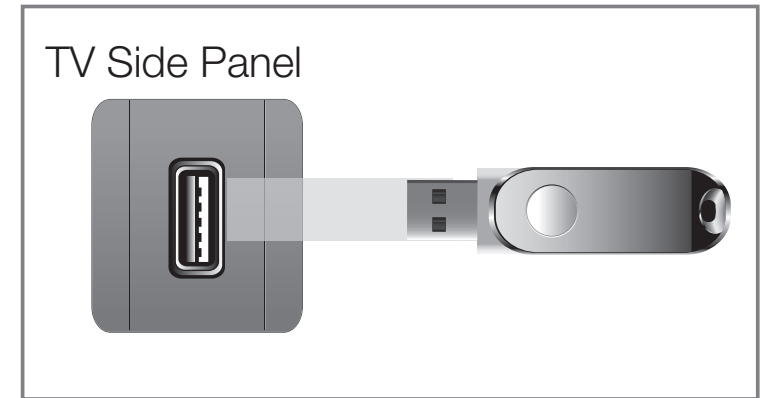

* It may differ depending on the model.

- **By Online** for LED 5 series 32-46 inches: Upgrade the software using the Internet.
 - ☞ First, configure your network. For detailed procedures on using the Network Setup, refer to the “Network Connection” instructions.
 - ☞ If the internet connection doesn’t operate properly, the connection may be broken. Please retry downloading. If the problem persists, download by USB and upgrade.
- **By Channel**: Upgrade the software using the broadcasting signal.
 - ☞ If the function is selected during the software transmission period, software will be automatically searched and downloaded.
 - ☞ The time required to download the software is determined by the signal status.

- **Alternative Software** (backup): If there is an issue with the new firmware and it is affecting operation, you can change the software to the previous version.
 If the software was changed, existing software is displayed.
- **Standby Mode Upgrade (Off / 1 hour later / 2 hours later/ 00:00 / 02:00 / 12:00 / 14:00)**: A manual upgrade will be automatically performed at selected time. Since the power of the unit is turned on internally, the screen may be turned on slightly for the product. This phenomenon may continue for more than 1 hour until the software upgrade is complete.

■ **Contact Samsung**

View this information when your TV does not work properly or when you want to upgrade the software. You can find information regarding our call centres, and how to download products and software.

■ **Contents Home**

You can enjoy useful and various contents.



❑ Using the My Downloads

Enjoy photos, music and movie files saved on a USB Mass Storage Class (MSC) device and your PC.

1. Press the **CONTENT** button to select **My Downloads**.
2. Press **▲/▼** button to select desired menu (**Videos**, **Photos**, **Music**), then press the **ENTER**  button.

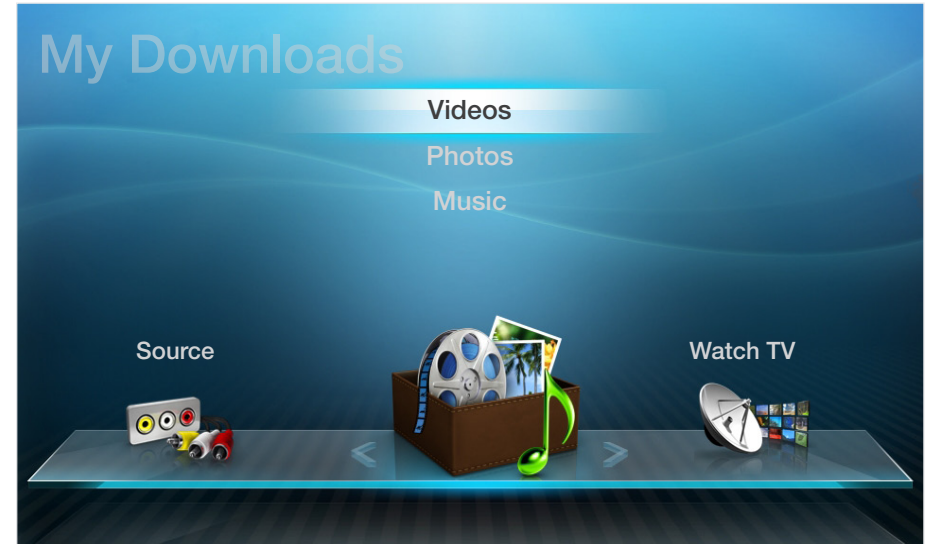



* It may differ depending on the model.

❑ Connecting a USB Device

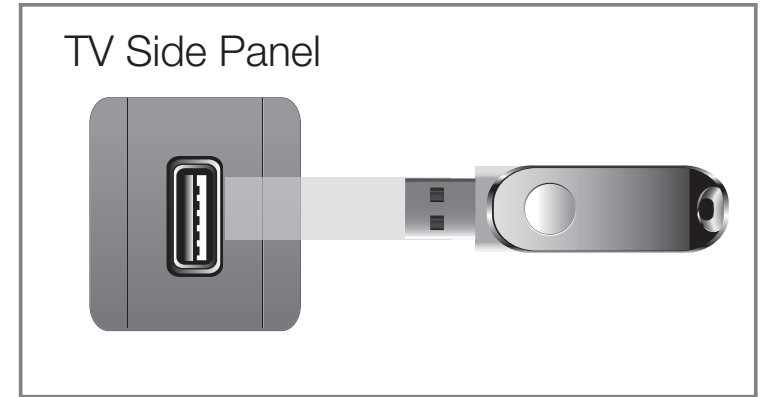
1. Turn on your TV.
2. Connect a USB device containing photo, music and movie files to the USB jack on the side of the TV.
3. When USB is connected to the TV, popup window appears. Then you can select **New device connected**.



* It may differ depending on the model.

-  It might not work properly with unlicensed multimedia files.
-  Need-to-Know List before using **My Downloads**
 - MTP (Media Transfer Protocol) is not supported.
 - The file system supports FAT16, FAT32 and NTFS.
 - Certain types of USB Digital camera and audio devices may not be compatible with this TV.
 - **My Downloads** only supports USB Mass Storage Class (MSC) devices. MSC is a Mass Storage Class Bulk-Only Transport device. Examples of MSC are Thumb drives, Flash Card Readers and USB HDD (USB HUB are not supported). Devices should be connected directly to the TV's USB port.
 - Before connecting your device to the TV, please back up your files to prevent them from damage or loss of data. SAMSUNG is not responsible for any data file damage or data loss.

- USB (HDD) is not supported. **for LED 4 series 19-32 inches, 5 series 22-27 inches**
- Connect a USB HDD to the dedicated port, USB 1 (HDD) port.
for LED 5 series 32-46 inches
- Do not disconnect the USB device while it is loading.
- The higher the resolution of the image, the longer it takes to display on the screen.
- The maximum supported JPEG resolution is 15360 x 8640 pixels.
- For unsupported or corrupted files, the “Not Supported File Format” message is displayed.
- If the files are sorted by **Folder View**, up to 1000 files can be displayed in each folder.

- MP3 files with DRM that have been downloaded from a non-free site cannot be played. Digital Rights Management (DRM) is a technology that supports the creation, distribution and management of the content in an integrated and comprehensive way, including the protection of the rights and interests of the content providers, the prevention of the illegal copying of contents, as well as managing billings and settlements.
- If more than 2 PTP devices are connected, you can only use one at a time.
- If more than two MSC devices are connected, some of them may not be recognized. A USB device that requires high power (more than 500mA or 5V) may not be supported.

- If an over-power warning message is displayed while you are connecting or using a USB device, the device may not be recognized or may malfunction.
- If the TV has been no input during time set in **Auto Protection Time**, the Screensaver will run.
- The power-saving mode of some external hard disk drives may be released automatically when connected to the TV.



- If a USB extension cable is used, the USB device may not be recognized or the files on the device may not be read.
- If a USB device connected to the TV is not recognized, the list of files on the device is corrupted or a file in the list is not played, connect the USB device to the PC, format the device and check the connection.
- If a file deleted from the PC is still found when **My Downloads** is run, use the “Empty the Recycle Bin” function on the PC to permanently delete the file.
- **My Downloads** only supports sequential jpeg format.
- The scene search and thumbnail functions are not supported in the **Videos**.
- If the number of files and folders saved on a USB storage device is approximately over 4000, the files and folders may not appear and some folders may not be opened.

❑ **Connecting to the PC through network** for LED 5 series 32-46 inches



You can play pictures, music and videos saved on your PC through a network connection in the **My Downloads** mode over your TV.

📖 If you want to use **My Downloads** to play files saved on your PC over your TV, you should download “AllShare PC Software” and users manual from “www.samsung.com.”

1. For more information on how to configure your network, refer to ‘Network Connection’.
 - You are recommended to locate both TV and PC in same subnet. The first 3 parts of the IP address of the TV and PC should be the same and only the last part (the host address) should be changed. (e.g. IP Address: 123.456.789.**)





2. Using a LAN cable, connect between the external modem and the PC onto which the AllShare PC Software programme will be installed.
 - You can connect the TV to the PC directly without connecting it through a Sharer (Router).

 Functions that are not supported when connecting to a PC through a network:

- The **Background Music** and **Background Music Setting** functions.
- The  (REW) or  (FF) button while a movie is playing.

 The DivX DRM, Multi-audio, embedded caption does not supported.

 AllShare PC Software should be permitted by the firewall programme on your PC.

-  When you use **My Downloads** mode through a network connection, according to functions of the provided server:
- The sorting method may vary.
 - The  (REW),  (FF) or  (Pause) buttons may not work depending on the content information.
-  If you experience any file stuttering issue while playing a video over a wireless network, we recommend using a wired network.

❑ Screen Display

Move to the desired file using the ◀/▶/▲/▼ buttons and then press the **ENTER** ↵ or ▶ (Play) button. The file is played. **My Downloads** screen may differ depending on the way to enter the screen.

Information:

You can ascertain the selected device name, contents mode, folder/file name, page and sorting list.

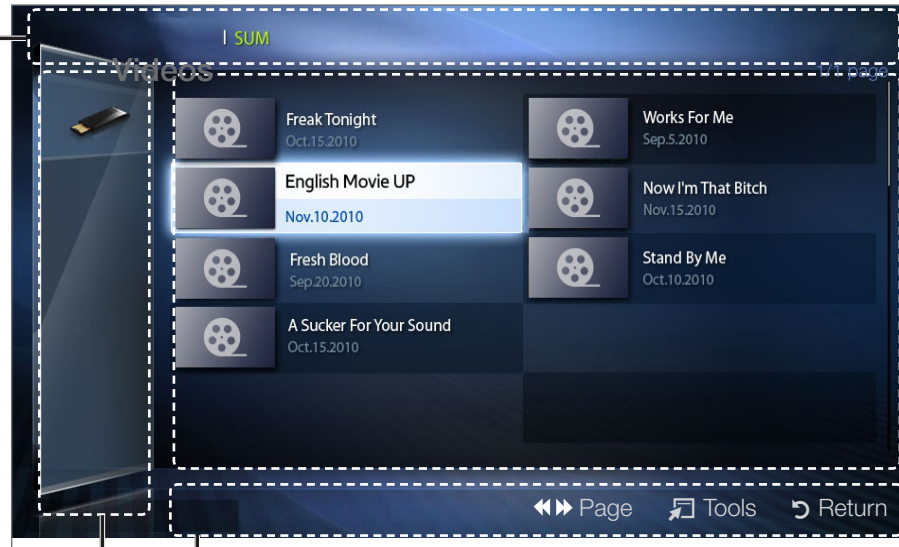

File List Section:

You can confirm the files and groups that are sorted by category.

Contents mode / Device name:

You can select the desired Contents mode or Device name.

Operation Buttons:

- **c** Yellow (**Edit Mode**): Selects the desired music. The check box is shown in the screen to check the music you want. It is only available in Music.
- ◀▶ (**Page**): Move to next or previous page.
- ⚙ (**Tools**): Displays the option menu.
- ↵ (**Return**): Move to the previous step.

■ Videos

Playing Video

1. Press the ◀/▶/▲/▼ button to select the desired video in the file list.
2. Press the ENTER ↵ button or ▶ (Play) button.
 - The selected file name is displayed on the top with its playing time.
 - If video time information is unknown, play time and progress bar are not displayed.



- During video playback, you can search using ◀ and ▶ button.
- You can use (◀◀) (REW) and (▶▶) (FF) buttons during playback.



In this mode, you can enjoy movie clips contained on a Game, but you cannot play the Game itself.

- Supported Subtitle Formats

Name	File extension	Format
MPEG-4 time-based text	.ttxt	XML
SAMI	.smi	HTML
SubRip	.srt	string-based
SubViewer	.sub	string-based
Micro DVD	.sub or .txt	string-based

- Supported Video Formats

File Extention	Container	Video Codec	Resolution	Frame rate (fps)	Bit rate (Mbps)	Audio Codec
*.avi *.mkv	AVI MKV	DivX 3.11/4. x/5.1/6.0	1920 x 1080	6 ~ 30	8	MP3 / AC3 / LPCM / ADPCM / DTS Core
		XviD	1920 x 1080	6 ~ 30	8	
		H.264 BP/MP/ HP	1920 x 1080	6 ~ 30	25	
		MPEG4 SP/ASP	1920 x 1080	6 ~ 30	8	
		Motion JPEG	640 x 480	6 ~ 30	8	

File Extention	Container	Video Codec	Resolution	Frame rate (fps)	Bit rate (Mbps)	Audio Codec
*.asf	ASF	DivX 3.11/4. x/5.1/6.0	1920 x 1080	6 ~ 30	8	MP3 / AC3 / LPCM / ADPCM / WMA
		XviD	1920 x 1080	6 ~ 30	8	
		H.264 BP/MP/ HP	1920 x 1080	6 ~ 30	25	
		MPEG4 SP/ASP	1920 x 1080	6 ~ 30	8	
		Motion JPEG	640 x 480	6 ~ 30	8	
*.wmv	ASF	Window Media Video v9	1920 x 1080	6 ~ 30	25	WMA

File Extention	Container	Video Codec	Resolution	Frame rate (fps)	Bit rate (Mbps)	Audio Codec
*.mp4	MP4	H.264 BP/MP/HP	1920 x 1080	6 ~ 30	25	MP3 / ADPCM / AAC
		MPEG4 SP/ASP	1920 x 1080	6 ~ 30	8	
		XVID	1920 x 1080	6 ~ 30	8	
*.3gp	3GPP	H.264 BP/MP/HP	1920 x 1080	6 ~ 30	25	ADPCM / AAC / HE-AAC
		MPEG4 SP/ASP	1920 x 1080	6 ~ 30	8	
*.vro	VRO	MPEG2	1920 x 1080	24/25/30	30	AC3 / MPEG / LPCM
	VOB	MPEG1	1920 x 1080	24/25/30	30	

File Extention	Container	Video Codec	Resolution	Frame rate (fps)	Bit rate (Mbps)	Audio Codec
*.mpg *.mpeg	PS	MPEG1	1920 x 1080	24/25/30	30	AC3 / MPEG / LPCM / AAC
		MPEG2	1920 x 1080	24/25/30	30	
		H.264	1920 x 1080	6 ~ 30	25	
*.ts *.tp *.trp	TS	MPEG2	1920 x 1080	24/25/30	30	AC3 / AAC / MP3 / DD+ / HE-AAC
		H.264	1920 x 1080	6 ~ 30	25	
		VC1	1920 x 1080	6 ~ 30	25	

Other Restrictions

NOTE

- Video content will not play, or not play correctly, if there is an error in the content or the container.
- Sound or video may not work if the contents have a standard bit rate/frame rate above the compatible Frame/sec listed in the table above.
- If the Index Table is in error, the Seek (Jump) function is not supported.
- When playing the video through network, it may not work depending on the network status. When you play video over a network connection, the video may not be played smoothly. **for LED 5 series 32-46 inches**
- The menu can be displayed late if the video is over 10Mbps(bit rate).
- Some USB/digital camera devices may not be compatible with the player.
- Video content can not be played, if there are many contents in one file.

Video Decoder	Audio Decoder
<ul style="list-style-type: none">● Supports up to H.264, Level 4.1● H.264 FMO / ASO / RS, VC1 SP / MP / AP L4 and AVCHD are not supported.● XVID, MPEG4 SP, ASP:<ul style="list-style-type: none">– Below 1280 x 720: 60 frame max– Above 1280 x 720: 30 frame max● GMC is not supported.	<ul style="list-style-type: none">● Supports up to WMA 7, 8, 9, STD, 9 PRO● WMA Lossless, Voice Lossless, Voice is not supported.● WMA sampling rate 22050 Hz mono is not supported.





■ Music

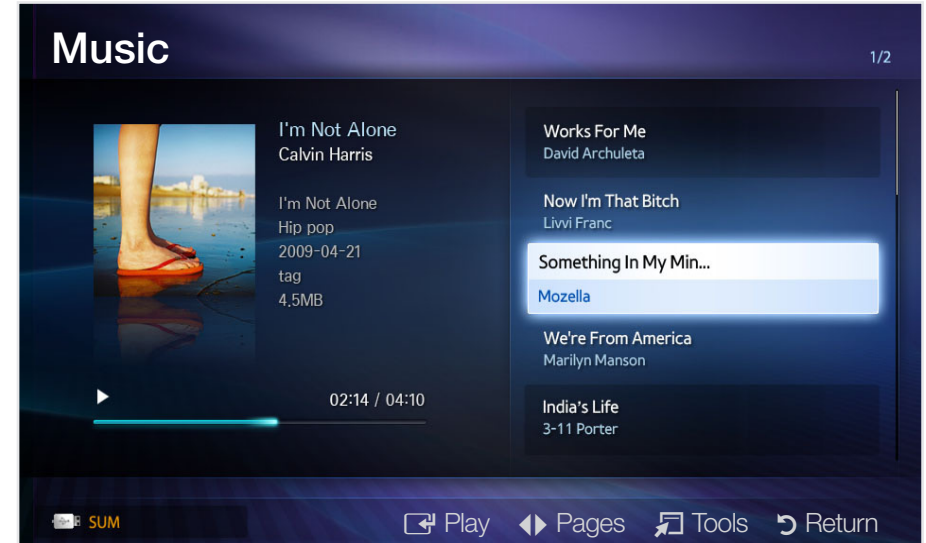

Playing Music

1. Press the ◀/▶/▲/▼ button to select the desired Music in the file list.
2. Press the ENTER ↵ button or ▶ (Play) button.
 - You can use ◀◀ (REW) and ▶▶ (FF) buttons during playback.



-  Only displays the files with MP3 file extension. Other file extensions are not displayed, even if they are saved on the same USB device.
-  If the sound is abnormal when playing MP3 files, adjust the **Equalizer** in the **Sound** menu. (An over-modulated MP3 file may cause a sound problem.)

Playing the selected music

1. Press the  (**Edit Mode**) button.
2. Select the desired music.
 -  The check box appears to the left of the selected files.
3. Press the **TOOLS** button and select **Play Selected Contents**.
 -  You can select or deselect all music pressing the **Select All / Deselect All**.

■ Photos

Viewing a Photo (or Slide Show)

1. Press the ◀/▶/▲/▼ button to select the desired photo in the file list.
 2. Press the ENTER ↵ button.
 - When a selected photo is displayed, press the ENTER ↵ button to start the slide show.
 - During the slide show, all files in the file list will be displayed in order.
- ☞ When you press the ▶ (Play) button in the file list, slide show will be started immediately.



-  Music files can be automatically played during the Slide Show if the **Background Music** is set to **On**.

❑ My Downloads - Additional Functions

Videos/Music/Photos Play Option menu

During playing a file, press the **TOOLS** button.

Category	Operation	Videos	Music	Photos
Title Search	You can move the other file directly.	✓		
Time Search	You can search the video using ◀ and ▶ button at one minute interval or entering the number directly.	✓		
Shuffle Mode	You can play the music randomly.		✓	

Category	Operation	Videos	Music	Photos
Repeat Mode	You can play movie and music files repeatedly.	✓	✓	
Picture Size	You can adjust the picture size to your preference.	✓		
Picture Mode	You can adjust the picture setting.	✓		✓
Sound Mode	You can adjust the sound setting.	✓	✓	✓

Category	Operation	Videos	Music	Photos
Subtitle Language	You can enjoy video in one of supported languages as required. The function is only enabled when stream-type files which support multiple audio formats are played.	✓		
Subtitle Setting	You can play the video with Subtitles. This function only works if the subtitles are the same file name as the video.	✓		



Category	Operation	Videos	Music	Photos
Start Slide Show / Pause Slide Show	You can start or pause a Slide Show.			✓
Slide Show Speed	You can select the slide show speed during the slide show.			✓
Background Music	You can on/off background music when watching a Slide Show.			✓



Category	Operation	Videos	Music	Photos
Background Music Setting	You can select background music when watching a Slide Show.			✓
Zoom	You can zoom into images in full screen mode.			✓
Rotate	You can rotate images in full screen mode.			✓
Information	You can see detailed information about the played file.	✓	✓	✓



What is Anynet+? **TOOLS**

Anynet+ is a function that enables you to control all connected Samsung devices that support Anynet+ with your Samsung TV's remote. The Anynet+ system can be used only with Samsung devices that have the Anynet+ feature. To be sure your Samsung device has this feature, check if there is an Anynet+ logo on it.

 For the method of connecting external devices, refer to the supported user manual.

NOTE

- Connect the Optical cable between the DIGITAL AUDIO OUT (OPTICAL) jack on your TV and the Digital Audio Input on the Home Theatre.

- When following the connection above, the Optical jack only outputs 2 channel audio. You will only hear sound from the Home Theatre's Front Left and Right speakers and the subwoofer. If you want to hear 5.1 channel audio, connect the DIGITAL AUDIO OUT (OPTICAL) jack on the DVD / Satellite Box (i.e. Anynet Device 1 or 2) directly to the Amplifier or Home Theatre, not the TV.
- You can connect only one Home Theatre.
- You can connect an Anynet+ device using the HDMI cable. Some HDMI cables may not support Anynet+ functions.
- Anynet+ works when the AV device supporting Anynet+ is in the standby or on status.
- Anynet+ supports up to 12 AV devices in total. Note that you can connect up to 3 devices of the same type.

Anynet+ Menu

 **TOOLS**  → **Anynet+ (HDMI-CEC)** → **ENTER** 

The Anynet+ menu changes depending on the type and status of the Anynet+ devices connected to the TV.

Anynet+ Menu	Description
View TV	Changes Anynet+ mode to TV broadcast mode.
Device List	Shows the Anynet+ device list.
(device_name) MENU	Shows the connected device menus. E.g. If a DVD recorder is connected, the disc menu of the DVD recorder will appear.

Anynet+ Menu	Description
(device_name) TOOLS	Shows the play menu of the connected device. E.g. If a DVD recorder is connected, the play menu of the DVD recorder will appear.
(device_name) Title Menu	Shows the title menu of the connected device. E.g. If a DVD recorder is connected, the title menu of the DVD recorder will appear.  Depending on the device, this menu may not be available.
Receiver	Sound is played through the receiver.

❑ Setting Up Anynet+

 MENU  → System → Anynet+ (HDMI-CEC) → ENTER 

■ Anynet+ (HDMI-CEC)

Anynet+ (HDMI-CEC) (Off / On): To use the Anynet+ Function, **Anynet+ (HDMI-CEC)** must be set to **On**.

 When the **Anynet+ (HDMI-CEC)** function is disabled, all the Anynet+ related operations are deactivated.

Auto Turn Off (No / Yes): Setting an Anynet+ Device to turn off automatically when the TV is turned off.

 If **Auto Turn Off** is set to **Yes**, running external devices will turn off at the same time as the TV powers off.

 May not be enabled depending on the device.

❑ Switching between Anynet+ Devices

1. Press the **TOOLS** button, then select **Anynet+ (HDMI-CEC)**.
2. Anynet+ devices connected to the TV are listed in **Device List**.
 - 📝 If you cannot find a device you want, press the **A** button to refresh the list.
3. Select a device and press the **ENTER**  button. You can switch to the selected device.
 - 📝 Only when you set **Anynet+ (HDMI-CEC)** to **On** in the **System** menu, the **Device List** menu appears.
 - Switching to the selected device may take up to 2 minutes. You cannot cancel the operation during the switching operation.
 - If you have selected external input mode by pressing the **SOURCE** button, you cannot use the Anynet+ function. Make sure to switch to an Anynet+ device by using the **Device List**.

❑ Listening through a Receiver

You can listen to sound through a receiver (i.e Home Theatre) instead of the TV speaker.

1. Select **Receiver** and set to **On**.

2. Press the **EXIT** button to exit.

- 📖 If your receiver supports audio only, it may not appear in the device list.
- 📖 The receiver will work when you have properly connected the optical in jack of the receiver to the DIGITAL AUDIO OUT (OPTICAL) jack of the TV.
- 📖 When the receiver (i.e Home Theatre) is set to **On**, you can hear sound output from the TV's Optical jack. When the TV is displaying a DTV (air) signal, the TV will send out 5.1 channel sound to the receiver. When the source is a digital component such as a DVD and is connected to the TV via HDMI, only 2 channel sound will be heard from the receiver.



NOTE

- You can only control Anynet+ devices using the TV remote control, not the buttons on the TV.
- The TV remote control may not work under certain conditions. If this occurs, reselect the Anynet+ device.



❑ Troubleshooting for Anynet+

Problem	Possible Solution
Anynet+ does not work.	<ul style="list-style-type: none">● Check if the device is an Anynet+ device. The Anynet+ system supports Anynet+ devices only.● Only one receiver (home theatre) can be connected.● Check if the Anynet+ device power cord is properly connected.● Check the Anynet+ device's Video/Audio/HDMI cable connections.● Check whether Anynet+ (HDMI-CEC) is set to On in the System menu.

Problem	Possible Solution
Anynet+ does not work.	<ul style="list-style-type: none">● Check whether the TV remote control is in TV mode.● Check whether the remote control is Anynet+ compatible.● Anynet+ does not work in certain situations. (Searching channels, operating My Downloads or Plug & Play (initial setup), etc.)● When connecting or removing the HDMI cable, please make sure to search devices again or turn your TV off and on again.● Check if the Anynet+ Function of Anynet+ device is set on.

Problem	Possible Solution
I want to start Anynet+.	<ul style="list-style-type: none">● Check if the Anynet+ device is properly connected to the TV and check if the Anynet+ (HDMI-CEC) is set to On in the System menu.● Press the TOOLS button to display the Anynet+ menu and select a menu you want.
I want to exit Anynet+.	<ul style="list-style-type: none">● Select View TV in the Anynet+ menu.● Press the SOURCE button on the TV remote control and select a device other than Anynet+ devices.● Press ∨ CH ∧ button to change the TV mode. (Note that the channel button operates only when a tuner-embedded Anynet+ device is not connected.)

Problem	Possible Solution
<p>The message “Connecting to Anynet+ device...” appears on the screen.</p> <p>The Anynet+ device does not play.</p>	<ul style="list-style-type: none"><li data-bbox="732 161 1999 287">● You cannot use the remote control when you are configuring Anynet+ or switching to a view mode.<li data-bbox="732 325 1999 451">● Use the remote control when the Anynet+ setting or switching to view mode is complete.<li data-bbox="732 489 1999 615">● You cannot use the play function when Plug & Play (initial setup) is in progress.



Problem	Possible Solution
The connected device is not displayed.	<ul style="list-style-type: none">● Check whether or not the device supports Anynet+ functions.● Check whether or not the HDMI cable is properly connected.● Check whether Anynet+ (HDMI-CEC) is set to On in the System menu.● Search Anynet+ devices again.● You can connect an Anynet+ device using the HDMI cable only. Some HDMI cables may not support Anynet+ functions.● If it is terminated by an abnormal situation such as disconnecting the HDMI cable or power cord or a power failure, please repeat the device scan.

Problem	Possible Solution
The TV sound is not output through the receiver.	<ul style="list-style-type: none"><li data-bbox="732 161 2074 211">● Connect the optical cable between TV and the receiver.



About AllShare™ for LED 5 series 32-46 inches

AllShare™ connects your TV and compatible Samsung mobile phones / devices through a network. You can play media contents including videos, photos and music saved on your mobile phones or the other devices (such as your PC) by controlling them on the TV via the network.

 For more information, visit “www.samsung.com” or contact the Samsung call centre. Mobile devices may need additional software installation. For details, refer to each device’s user’s guide.

❏ Setting Up AllShare™

👉 MENU  → Network → AllShare Settings → ENTER 

■ AllShare Settings

- **Media (On / Off)**: Enables or disables the media function. When the media function is on, Media contents play can be controlled by mobile phones or other devices that support DLNA DMC.

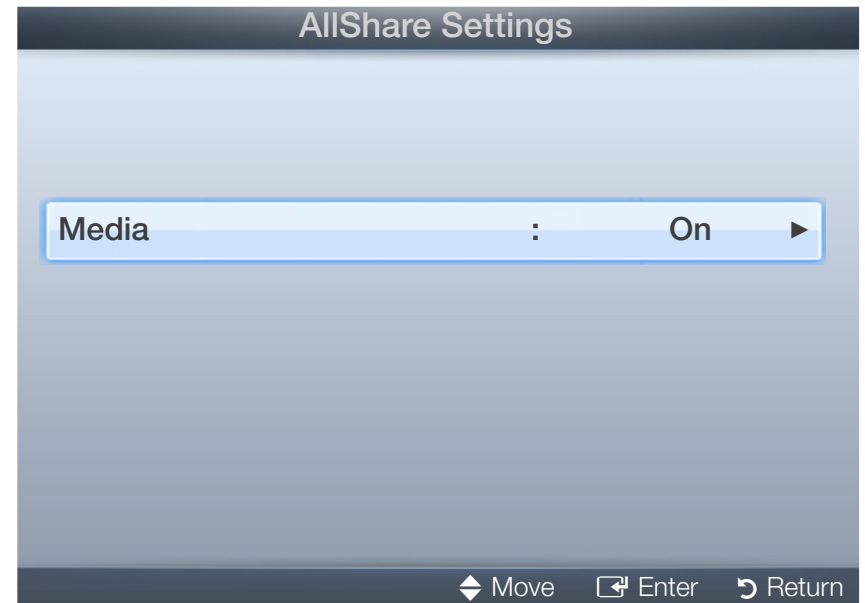

■ Media

Shows a list of mobile phones or connected devices which have been set up with this TV for using the **Media** function.



 The **Media** function is available in all devices which support DLNA DMC.

- **Allow / Deny**: Allows/Blocks the devices.
- **A Delete**: Deletes the devices from the list.

 This function only deletes the name of the devices from the list. If the deleted device is turned on or tries to connect to the TV, it may appear on the list again.

Using the Media Function



You can play media contents including videos, photos and music saved on your mobile phones or the other devices (such as your PC) by controlling them on the TV via the network.







- To turn off the media contents transmission from the devices, set **Media** to **Off** in the **AllShare Settings**.
- Contents may not be played on your TV depending on their resolution and format.
- The **ENTER**  and  /  buttons may not work depending on the type of media content.
- Using the devices, you can control the media playing. For details, refer to each device's user's guide.



❑ Analogue Channel Teletext Feature

The index page of the Teletext service gives you information on how to use the service. For Teletext information to be displayed correctly, channel reception must be stable. Otherwise, information may be missing or some pages may not be displayed.

You can change Teletext pages by pressing the numeric buttons on the remote control.

-  (mode): Selects the Teletext mode (LIST/FLOF). If pressed during LIST mode, switches the mode to List save mode. In List save mode, you can save a Teletext page into a list using the 8(store) button.
-  (Teletext on/mix/off): Activates the Teletext mode for the current channel. Press the button twice to overlap the Teletext mode with the current broadcasting screen. Press it one more time to exit teletext.

-  (sub-page): Displays the available sub-page.
-  (store): Stores the Teletext pages.
-  (index): Displays the index (contents) page at any time while you are viewing Teletext.
-  (size): Displays the teletext on the upper half of the screen in double-size. To move the text to the lower half of the screen, press it again. For normal display, press it once again.
-  (hold): Holds the display at the current page, in the case that there are several secondary pages that follow automatically. To undo, press it again.
-  (page up): Displays the next Teletext page.
-  (page down): Displays the previous Teletext page.

-  (reveal): Displays the hidden text (answers to quiz games, for example). To display the normal screen, press it again.
-  (cancel): Shrinks the Teletext display to overlap with the current broadcast.
- Colour buttons (red, green, yellow, blue): If the FASTEXT system is used by the broadcasting company, the different topics on a Teletext page are colour-coded and can be selected by pressing the coloured buttons. Press the colour corresponding to the topic of your choice. A new colourcoded page is displayed. Items can be selected in the same way. To display the previous or next page, press the corresponding coloured button.

The Teletext pages are organized according to six categories:

Part	Contents
A	Selected page number.
B	Broadcasting channel identity.
C	Current page number or search indications.
D	Date and time.
E	Text.
F	Status information. FASTEXT information.

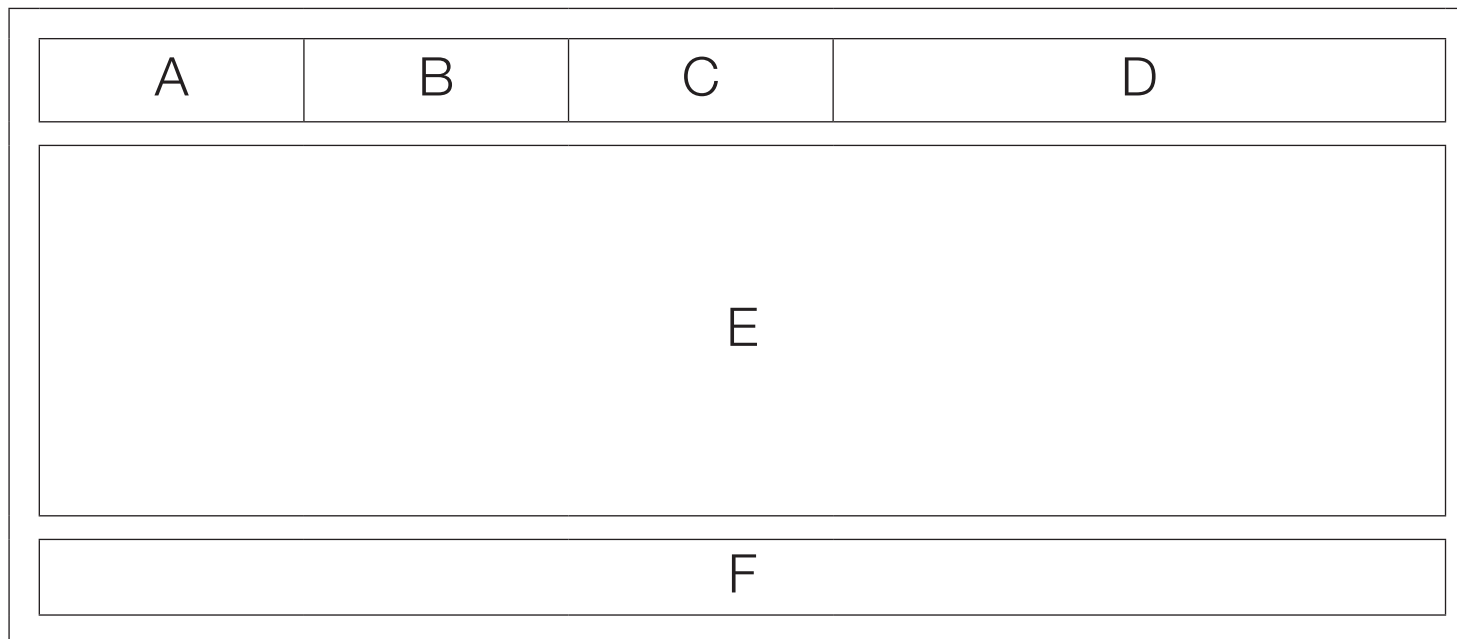

❑ Anti-theft Kensington Lock

The Kensington Lock is not supplied by Samsung. It is a device used to physically fix the system when using it in a public place. The appearance and locking method may differ from the illustration depending on the manufacturer. Refer to the manual provided with the Kensington Lock for additional information on proper use.

📖 Please find a “” icon on the rear of the TV. A kensington slot is beside the “” icon.

📖 The position and colour may differ depending on the model.

To lock the product, follow these steps:

1. Wrap the Kensington lock cable around a large, stationary object such as desk or chair.

TV Rear

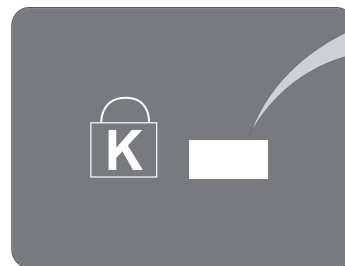

Optional

2. Slide the end of the cable with the lock attached through the looped end of the Kensington lock cable.
3. Insert the locking device into the Kensington slot on the product **1**.
4. Lock the lock.



NOTE

- These are general instructions. For exact instructions, see the User manual supplied with the locking device.
- The locking device has to be purchased separately.
- The location of the Kensington slot may be different depending on the TV model.

❑ Connections Common Interface Slot

Attaching the CI Card Adaptor

Attach the adapter as shown in the right.

To connect the CI CARD Adapter, follow these steps.

- ❏ Make sure that you attach the adaptor before you mount the TV on a wall.
1. Insert the CI CARD Adapter into the two holes on the product **1**.
 - ❏ Please find the two holes on the rear of the TV. The two holes are beside the COMMON INTERFACE port.
 - ❏ Press it firmly at center of adapter to ensure it is fully lock.
 2. Connect the CI CARD Adapter into the COMMON INTERFACE port.
 3. Insert the “CI or CI+ CARD”.

<TV Rear>

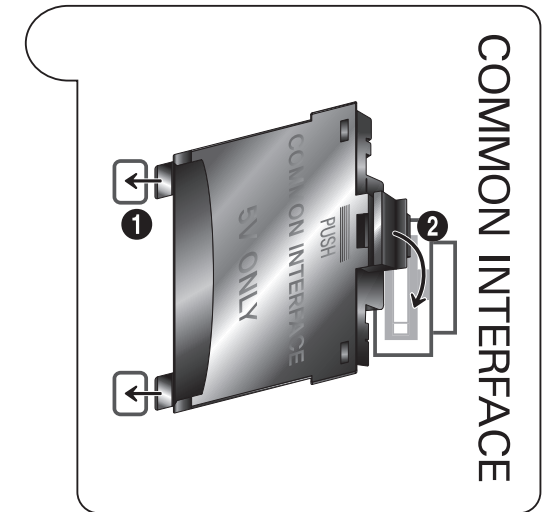

To watch paid channels, the “CI or CI+ CARD” must be inserted.

- If you do not insert the “CI or CI+ CARD”, some channels will display the message “Scrambled Signal”.
- The pairing information containing a telephone number, the “CI or CI+ CARD” ID, the Host ID and other information will be displayed in about 2~3 minutes. If an error message is displayed, please contact your service provider.
- When the configuration of channel information has finished, the message “Updating Completed” is displayed, indicating the channel list is updated.

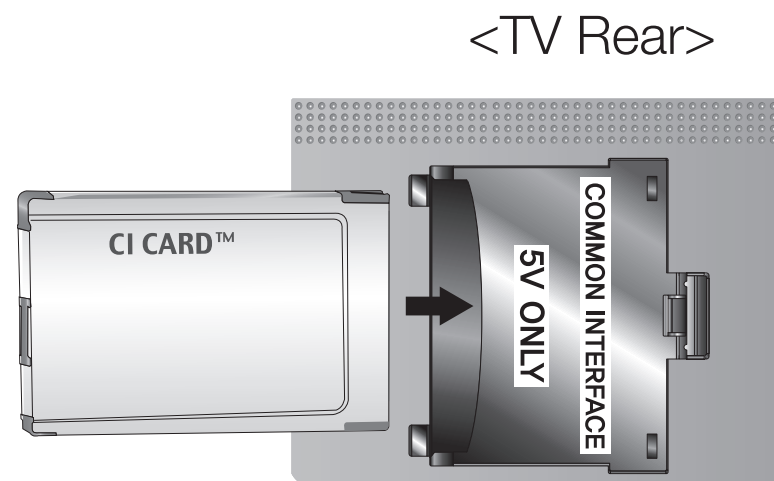



NOTE

- You must obtain a “CI or CI+ CARD” from a local cable service provider.
- When removing the “CI or CI+ CARD”, carefully pull it out with your hands since dropping the “CI or CI+ CARD” may cause damage to it.
- Insert the “CI or CI+ CARD” in the direction marked on the card.
- The location of the COMMON INTERFACE slot may be different depending on the model.
- “CI or CI+ CARD” is not supported in some countries and regions; check with your authorized dealer.
- If you have any problems, please contact a service provider.
- Insert the “CI or CI+ CARD” that supports the current antenna settings. The screen will be distorted or will not be seen.

❑ Troubleshooting

If you have any questions about the TV, first refer to this list. If none of these troubleshooting tips apply, please visit “www.samsung.com”, then click on Support.

Issues	Solutions and Explanations
Picture Quality	First of all, please perform the Picture Test and confirm that your TV is properly displaying test image. (go to MENU - Support - Self Diagnosis - Picture Test) If the test image is properly displayed, the poor picture may be caused by the source or signal.

Issues

The TV image does not look as good as it did in the store.

Solutions and Explanations

- If you have an analogue cable/set top box, upgrade to a digital set top box. Use HDMI or Component cables to deliver HD (high definition) picture quality.
- Cable/Satellite subscribers: Try HD stations from the channel line up.
- Antenna connection: Try HD stations after performing Auto tuning.
 - ✍ Many HD channels are up scaled from SD(Standard Definition) contents.
- Adjust the Cable/Set top box video output resolution to 1080i or 720p.
- Make sure you are watching the TV at the minimum recommended distance based on the size and definition of the signal.

Issues	Solutions and Explanations
The picture is distorted: macroblock error, small block, dots, pixelization	<ul style="list-style-type: none">● Compression of video contents may cause picture distortion especially in fast moving pictures such as sports and action movies.● Low signal level or bad quality can cause picture distortion. This is not a TV issue.● Mobile phones used close to the TV (cca up to 1m) may cause noise in picture on analogue and digital TV.
Colour is wrong or missing.	<ul style="list-style-type: none">● If you're using a component connection, make sure the component cables are connected to the correct jacks. Incorrect or loose connections may cause colour problems or a blank screen.

Issues	Solutions and Explanations
There is poor colour or brightness.	<ul style="list-style-type: none">● Adjust the Picture options in the TV menu. (go to Picture Mode / Colour / Brightness / Sharpness)● Adjust Energy Saving option in the TV menu. (go to MENU - System - Eco Solution - Energy Saving)● Try resetting the picture to view the default picture settings. (go to MENU - Picture - Reset Picture)
There is a dotted line on the edge of the screen.	<ul style="list-style-type: none">● If the picture size is set to Screen Fit, change it to 16:9.● Change cable/satellite box resolution.
The picture is black and white.	If you are using an AV composite input, connect the video cable (yellow) to the Green jack of component input 1 on the TV.

Issues	Solutions and Explanations
When changing channels, the picture freezes or is distorted or delayed.	<ul style="list-style-type: none">● If connected with a cable box, please try to reset the cable box. Reconnect the AC cord and wait until the cable box reboots. It may take up to 20 minutes.● Set the output resolution of the cable box to 1080i or 720p.
Sound Quality	<p>First of all, please perform the Sound Test to confirm that your TV audio is properly operating. (go to MENU - Support - Self Diagnosis - Sound Test)</p> <p>If the audio is OK, the sound problem may be caused by the source or signal.</p>
There is no sound or the sound is too low at maximum volume.	<ul style="list-style-type: none">● Please check the volume of the device (Cable/Sat Box, DVD, Blu-ray etc) connected to your TV.

Issues

Solutions and Explanations

The picture is good but there is no sound.

- Set the **Speaker Select** option to **TV Speaker** in the sound menu.
- If you are using an external device, make sure the audio cables are connected to the correct audio input jacks on the TV.
- If you are using an external device, check the device's audio output option (ex. you may need to change your cable box's audio option to HDMI when you have a HDMI connected to your TV).
- If you are using a DVI to HDMI cable, a separate audio cable is required.
- Reboot the connected device by reconnecting the device's power cable.
- If your TV has a headphone jack, make sure there is nothing plugged into it.

Issues	Solutions and Explanations
The speakers are making an inappropriate noise.	<ul style="list-style-type: none">● Check the cable connections. Make sure a video cable is not connected to an audio input.● For antenna or cable connections, check the signal strength. Low signal level may cause sound distortion.
No Picture, No Video	
The TV will not turn on.	<ul style="list-style-type: none">● Make sure the AC power cord is securely plugged in to the wall outlet and the TV.● Make sure the wall outlet is working.● Try pressing the POWER button on the TV to make sure the problem is not the remote. If the TV turns on, refer to “The remote control does not work” below.

Issues

The TV turns off automatically.

Solutions and Explanations

- Ensure the **Sleep Timer** is set to **Off** in the **Time** menu.
- If your PC is connected to the TV, check your PC power settings.
- Make sure the AC power cord is plugged in securely to the wall outlet and the TV.
- When watching TV from an antenna or cable connection, the TV will turn off after 10 ~ 15 minutes if there is no signal.

Issues

There is no picture/
video.

Solutions and Explanations

- Check cable connections (remove and reconnect all cables connected to the TV and external devices).
- Set your external devices' (Cable/Set top Box, DVD, Blu-ray etc) video outputs to match the connections to the TV input. For example, if an external device's output is HDMI, it should be connected to an HDMI input on the TV.
- Make sure your connected devices are powered on.
- Be sure to select the TV's correct source by pressing the **SOURCE** button on the TV remote.
- Reboot the connected device by reconnecting the device's power cable.

Issues	Solutions and Explanations
RF(Cable/Antenna) Connection	
The TV is not receiving all channels.	<ul style="list-style-type: none">● Make sure the Antenna cable is connected securely.● Please try Plug & Play (Initial setup) to add available channels to the channel list. Go to MENU - System - Plug & Play (Initial setup) and wait for all available channels to be stored.● Verify the Antenna is positioned correctly.
The picture is distorted: macro block error small block, dots, pixelization	<ul style="list-style-type: none">● Compression of video contents may cause picture distortion, especially on fast moving pictures such as sports and action movies.● A low signal can cause picture distortion. This is not a TV issue.

Issues	Solutions and Explanations
PC Connection	
A “ Mode Not Supported ” message appears.	<ul style="list-style-type: none">● Set your PC’s output resolution so it matches the resolutions supported by the TV.
“ PC ” is always shown on the source list, even if a PC is not connected.	<ul style="list-style-type: none">● This is normal; “PC” is always shown on the source list, regardless of whether a PC is connected.
The video is OK but there is no audio.	<ul style="list-style-type: none">● If you are using a HDMI connection, check the audio output setting on your PC.

Issues	Solutions and Explanations
Network Connection for LED 5 series 32-46 inches	
The wireless network connection failed.	<ul style="list-style-type: none">● Samsung Wireless USB dongle is required to use a wireless network.● Make sure the Network Connection is set to Wireless.● Make sure the TV is connected to a wireless IP sharer (Router).
Software Upgrade over the network fails.	<ul style="list-style-type: none">● Try Network Settings in Network menu.● If you have latest SW version, SW upgrade will not proceed.

Issues	Solutions and Explanations
Others	
The picture will not display in full screen.	<ul style="list-style-type: none">● HD channels will have black bars on either side of the screen when displaying up scaled SD (4:3) contents.● Black bars on the top and bottom will appear during movies that have aspect ratios different from your TV.● Adjust the picture size options on your external device or TV to full screen.
The remote control does not work.	<ul style="list-style-type: none">● Replace the remote control batteries with the poles (+/-) in the right direction.● Clean the sensor's transmission window on the remote.● Try pointing the remote directly at the TV from 5~6 feet away.

Issues	Solutions and Explanations
<p>The cable/set top box remote control doesn't turn the TV on or off, or adjust the volume.</p>	<ul style="list-style-type: none"> ● Programme the Cable/Set top box remote control to operate the TV. Refer to the Cable/Set user manual for the SAMSUNG TV code.
<p>A “Mode Not Supported” message appears.</p>	<ul style="list-style-type: none"> ● Check the supported resolution of the TV, and adjust the external device's output resolution accordingly.
<p>There is a plastic smell from the TV.</p>	<ul style="list-style-type: none"> ● This smell is normal and will dissipate over time.
<p>The TV Signal Information is unavailable in the Self Diagnosis Test menu.</p>	<ul style="list-style-type: none"> ● This function is only available with digital channels from an Antenna / RF / Coax connection.

Issues	Solutions and Explanations
TV is tilted to the right or left side.	<ul style="list-style-type: none"> ● Remove the stand base from the TV and reassemble it.
There are difficulties assembling the stand base.	<ul style="list-style-type: none"> ● Make sure the TV is placed on a flat surface. If you can not remove the screws from the TV, please use a magnetized screw driver.
The Channel menu is grey out (unavailable).	<ul style="list-style-type: none"> ● The Channel menu is only available when the TV source is selected.
◀ Your settings are lost after 30 minutes or every time the TV is turned off.	<ul style="list-style-type: none"> ● If the TV is in the Store Demo mode, it will reset audio and picture settings every 30 minutes. Change the settings from Store Demo mode to Home Use mode in the Plug & Play (Initial setup) procedure. Press the SOURCE button to select TV mode, and go to MENU → System → Plug & Play (Initial setup) → ENTER . ▶

Issues	Solutions and Explanations
You have intermittent loss of audio or video.	<ul style="list-style-type: none">● Check the cable connections and reconnect them.● Loss of audio or video can be caused by using overly rigid or thick cables. Make sure the cables are flexible enough for long term use. If mounting the TV to the wall, we recommend using cables with 90 degree connectors.
You see small particles when you look closely at the edge of the frame of the TV.	<ul style="list-style-type: none">● This is part of the product's design and is not a defect.
The PIP menu is not available.	<ul style="list-style-type: none">● PIP functionality is only available when you are using a HDMI, PC or components source.

Issues	Solutions and Explanations
<p>You turned the TV off 45 minutes ago, and it turned on again.</p>	<ul style="list-style-type: none"> ● It is normal. The TV operates the OTA (Over The Aerial) function itself to upgrade firmware downloaded whilst your watching TV.
<p>The message “Scramble signal” or “Weak Signal/No Signal” appears.</p>	<ul style="list-style-type: none"> ● If you are using a CAM CARD (CI/CI+), check that it is installed into the common interface slot. ● If there is still a problem, pull the CAM CARD out of the TV and insert it into the slot again.
<p>There are recurrent picture/sound issues.</p>	<ul style="list-style-type: none"> ● Check and change the signal/source.
<p>A reaction may occur between the rubber cushion pads on the base stand and the top finish of some furniture.</p>	<ul style="list-style-type: none"> ● To prevent this, use felt pads on any surface of the TV that comes in direct contact with furniture.

❑ Licence



Manufactured under licence from Dolby Laboratories. Dolby and the double-D symbol are trademarks of Dolby Laboratories.



Manufactured under licence under U.S. Patent #'s: 5,451,942; 5,956,674; 5,974,380; 5,978,762; 6,487,535 & other U.S. and worldwide patents issued & pending. DTS and the Symbol are registered trademarks. & DTS 2.0+ Digital Out and the DTS logos are trademarks of DTS, Inc. Product Includes software. © DTS, Inc. All Rights Reserved.



DivX Certified to play DivX video up to HD 1080p, including premium content.

ABOUT DIVX VIDEO: DivX[®] is a digital video format created by DivX, Inc. This is an official DivX Certified device that plays DivX video. Visit www.divx.com for more information and software tools to convert your files into DivX video. ABOUT DIVX VIDEO-ON-DEMAND: This DivX Certified[®] device must be registered in order to play DivX Video-on-Demand (VOD) content. To generate the registration code, locate the DivX VOD section in the device setup menu. Go to vod.divx.com with this code to complete the registration process and learn more about DivX VOD. Pat. 7,295,673; 7,460,688; 7,519,274



TheaterSound, SRS and  symbol are trademarks of SRS Labs, Inc.

TheaterSound technology is incorporated under licence from SRS Labs, Inc.

Open Source Licence Notice

In the case of using open source software, Open Source Licences are available on the product menu. Open Source Licence Notice is written only English.