

SAMSUNG

DIGITAL HOME CINEMA SYSTEM

HT-UP30

HT-TP33

THIS APPLIANCE IS MANUFACTURED BY:

Instruction Manual

SAMSUNG

ELECTRONICS



Safety Warnings

**CLASS 1 LASER PRODUCT
KLASSE 1 LASER PRODUKT
LUOKAN 1 LASER LAITE
KLASS 1 LASER APPARAT
PRODUCTO LASER CLASE 1**



CAUTION
RISK OF ELECTRIC SHOCK.
DO NOT OPEN



CAUTION:
TO REDUCE THE RISK OF ELECTRIC SHOCK, DO NOT REMOVE REAR COVER. NO USER SERVICEABLE PARTS INSIDE. REFER SERVICING TO QUALIFIED SERVICE PERSONNEL.

CLASS 1 LASER PRODUCT

This Compact Disc player is classified as a CLASS 1 LASER product.

Wiring the Main Power Supply Plug(UK Only)

IMPORTANT NOTICE

The main lead on this equipment is supplied with a moulded plug incorporating a fuse. The value of the fuse is indicated on the pin face of the plug and if it requires replacing, a fuse approved to BS1362 of the same rating must be used.

Never use the plug with the fuse cover removed. If the cover is detachable and a replacement is required, it must be of the same colour as the fuse fitted in the plug. Replacement covers are available from your dealer.

If the fitted plug is not suitable for the power points in your house or the cable is not long enough to reach a power point, you should obtain a suitable safety approved extension lead or consult your dealer for assistance.

However, if there is no alternative to cutting off the plug, remove the fuse and then safely dispose of the plug. Do not connect the plug to a main socket as there is a risk of shock hazard from the bared flexible cord.

Never attempt to insert bare wires directly into a main socket. A plug and fuse must be used at all times.

IMPORTANT

The wires in the main lead are coloured in accordance with the following code:-

BLUE = NEUTRAL

BROWN = LIVE

As these colours may not correspond to the coloured markings identifying the terminals in your plug, proceed as follows:-

The wire coloured BLUE must be connected to the terminal marked with the letter N or coloured BLUE or BLACK.

The wire coloured BROWN must be connected to the terminal marked with the letter L or coloured BROWN or RED.

WARNING: DO NOT CONNECT EITHER WIRE TO THE EARTH TERMINAL WHICH IS MARKED WITH THE LETTER E OR BY THE EARTH SYMBOL \perp , OR COLOURED GREEN OR GREEN AND YELLOW.

Use of controls, adjustments or performance of procedures other than those specified herein may result in hazardous radiation exposure.

CAUTION-INVISIBLE LASER RADIATION WHEN OPEN AND INTERLOCKS DEFEATED, AVOID EXPOSURE TO BEAM.



This symbol indicates that dangerous voltage which can cause electric shock is present inside this unit.



This symbol alerts you to important operating and maintenance instructions accompanying the unit.

WARNING: To reduce the risk of fire or electric shock, do not expose this appliance to rain or moisture.

CAUTION: TO PREVENT ELECTRIC SHOCK, MATCH WIDE BLADE OF PLUG TO WIDE SLOT, FULLY INSERT.

Precautions

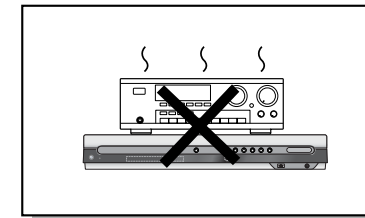
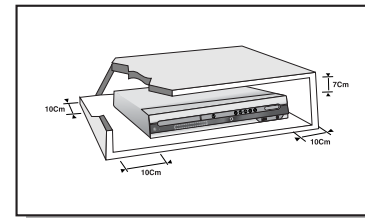

Ensure that the AC power supply in your house complies with the identification sticker located on the back of your player. Install your player horizontally, on a suitable base (furniture), with enough space around it for ventilation (3-4inches). Make sure the ventilation slots are not covered. Do not stack anything on top of the player. Do not place the player on amplifiers or other equipment which may become hot. Before moving the player, ensure the disc tray is empty. This player is designed for continuous use. Switching off the DVD player to the stand-by mode does not disconnect the electrical supply. In order to disconnect the player completely from the power supply, remove the main plug from the wall outlet, especially when left unused for a long period of time.

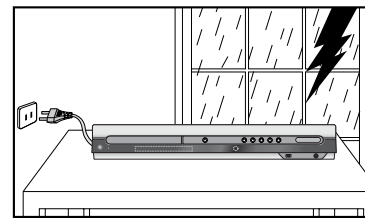

During thunderstorms, disconnect AC main plug from the wall outlet. Voltage peaks due to lightning could damage the unit.

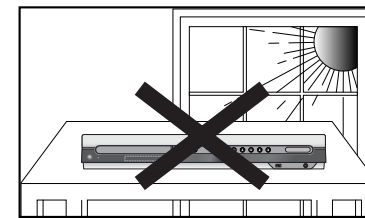

Do not expose the unit to direct sunlight or other heat sources. This could lead to overheating and malfunction of the unit.

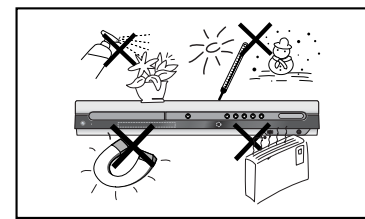

Protect the player from moisture (i.e. vases), and excess heat (e.g. fireplace) or equipment creating strong magnetic or electric fields (i.e. speakers...). Disconnect the power cable from the AC supply if the player malfunctions. Your player is not intended for industrial use.

Use of this product is for personal use only.

Condensation may occur if your player or disc has been stored in cold temperatures.

If transporting the player during the winter, wait approximately 2 hours until the unit has reached room temperature before using.

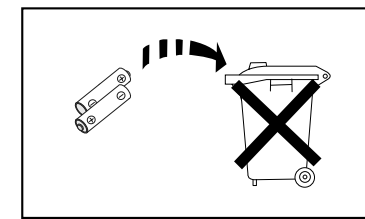

The batteries used with this product contain chemicals that are harmful to the environment.

Do not dispose of batteries in the general household trash.

Features

● Multi-Disc Playback & FM Tuner

The HT-UP30/HT-TP33 combines the convenience of multi-disc playback capability, including DVD-AUDIO, DVD-VIDEO, VCD, CD, MP3-CD, DivX, CD-R/RW, and DVD-R/RW, with a sophisticated AM/FM tuner, all in a single player.

● DVD-Audio compatible

Experience the super high-quality audio performance of DVD-Audio. The on-board 24-bit/192kHz DAC enables this player to deliver exceptional sound quality in terms of dynamic range, low-level resolution and high-frequency detail.

● USB HOST Function support

You can connect and play files from external USB storage devices such as MP3 players, USB flash memory, etc. using the Home Theater's USB HOST function.

● Dolby Pro Logic II

Dolby Pro Logic II is a new form of multi-channel audio signal decoding technology that improves upon existing Dolby Pro Logic.

● DTS (Digital Theater Systems)

DTS is an audio compression format developed by Digital Theater Systems Inc. It delivers full-frequency 5.1 channel sound.

● TV Screen Saver Function

The HT-UP30/HT-TP33 automatically brightens and darkens your TV screen after 3 minutes in the stop mode. The HT-UP30/HT-TP33 automatically switches itself into the power saving mode after 20 minutes in the screen saver mode.

● Power Saving Function

The HT-UP30/HT-TP33 automatically shuts itself off after 20 minutes in the stop mode.

● Customized TV Screen Display

The HT-UP30/HT-TP33 allows you to select your favorite image during JPEG, DVD or VCD playback and set it as your background wallpaper.

Contents

● PREPARATION

Safety Warnings.....	1
Precautions.....	2
Features.....	3
Notes on Discs.....	5
Description.....	7

● CONNECTIONS

Connecting the Speakers.....	11
Connecting the Video Out to TV.....	14
P.SCAN(Progressive Scan) Function.....	15
Connecting the FM and AM Antennas.....	16
Connecting External Components.....	17

● OPERATION

Before Using Your Home Theater.....	19
Disc Playback.....	21
MP3-CD Playback.....	22
JPEG File Playback.....	23
DivX Playback.....	25
Playing Media Files using the USB HOST feature.....	27
Displaying Disc Information.....	29
Checking the Remaining Time.....	29
Fast/Slow Playback.....	30
Skipping Scenes/Songs.....	30
Repeat Playback.....	31
A-B Repeat Playback.....	32
Step Function.....	33
Angle Function.....	33
Zoom (Screen Enlarge) Function.....	34
EZ VIEW Function.....	34
Bonus Group / Navigating Pages.....	35
Selecting Audio/Subtitle Language.....	36
Moving Directly to a Scene/Song.....	37
Using Disc Menu.....	38
Using the Title Menu.....	38

● SETUP

Setting the Language.....	39
Setting TV Screen type.....	41
Setting Parental Controls (Rating Level).....	43
Setting the Password.....	44
Setting the Wallpaper.....	45
DVD Audio Disc Playback Mode.....	47
Setting the Speaker Mode.....	48
Setting the Delay Time.....	49
Setting the Test Tone.....	51
Setting the DRC (Dynamic Range Compression).....	52
Setting the Audio Quality.....	53
AV SYNC Setup.....	55
Sound Field (DSP)/EQ Function.....	56
Dolby Pro Logic II Mode.....	57
Dolby Pro Logic II Effect.....	58

● RADIO OPERATION

Listening to Radio.....	59
Presetting Stations.....	60
About RDS broadcasting.....	61

● MISCELLANEOUS

Convenient Functions.....	63
Operating a TV with the Remote Control.....	65
Before Calling for Service.....	67
Cautions on Handling and Storing Discs.....	69
Language Code List.....	70
Specifications.....	71

Notes on Discs



DVD (Digital Versatile Disc) offers fantastic audio and video, thanks to Dolby Digital surround sound and MPEG-2 video compression technology. Now you can enjoy these realistic effects in the home, as if you were in a movie theater or concert hall.



DVD players and the discs are coded by region. These regional codes must match in order for the disc to play. If the codes do not match, the disc will not play. The Region Number for this player is given on the rear panel of the player. (Your DVD player will only play DVDs that are labeled with identical region codes.)

Playable Discs

Disc Type	Mark (Logo)	Recorded Signals	Disc Size	Max. Playing Time
DVD-AUDIO DVD-VIDEO		Audio + Video	12cm	Approx. 240 min. (single-sided) Approx. 480 min. (double-sided)
			8cm	Approx. 80 min. (single-sided) Approx. 160 min. (double-sided)
VIDEO-CD		Audio + Video	12cm	74 min.
			8cm	20 min.
AUDIO-CD		Audio	12cm	74 min.
			8cm	20 min.

Do not use the following types of disc!

- LD, CD-G, CD-I, CD-ROM and DVD-ROM discs cannot be played on this player. If such discs are played, a "WRONG DISC FORMAT" message appears on the TV screen.
- DVD discs purchased abroad may not play on this player. If such discs are played, a "WRONG REGION CODE" message appears on the TV screen.

Copy Protection

- Many DVD discs are encoded with copy protection. Because of this, you should only connect your DVD player directly to your TV, not to a VCR. Connecting to a VCR results in a distorted picture from copy-protected DVD discs.
- This product incorporates copyright protection technology that is protected by methods claims of certain U.S. patents and other intellectual property rights owned by Macrovision Corporation and other rights owners. Use of this copyright protection technology must be authorized by Macrovision Corporation, and is intended for home and other limited viewing uses only unless otherwise authorized by Macrovision Corporation. Reverse engineering or disassembly is prohibited.

Disc Recording Format

CD-R Discs

- Some CD-R discs may not be playable depending on the disc recording device (CD-Recorder or PC) and the condition of the disc.
- Use a 650MB/74 minute CD-R disc.
Do not use CD-R disk over 700MB/80 minute as much as possible since it may not be played back.
- Some CD-RW (Rewritable) media, may not be playable.
- Only CD-Rs that are properly "closed" can be fully played. If the session is closed but the disc is left open, you may not be able to fully play the disc.

CD-R MP3 Discs

- Only CD-R discs with MP3 files in ISO 9660 or Joliet format can be played.
- MP3 file names should be 8 characters or less in length and contain no blank spaces or special characters (. / = +).
- Use discs recorded with a compression/decompression data rate greater than 128Kbps.
- Only files with the ".mp3" and ".MP3" extensions can be played.
- Only a consecutively written Multisession disc can be played. If there is a blank segment in the Multisession disc, the disc can be played only up to the blank segment.
- If the disc is not closed, it will take longer to begin playback and not all of the recorded files may be played.
- For files encoded in Variable Bit Rate (VBR) format, i.e. files encoded in both low bit rate and high bit rate (e.g., 32Kbps ~ 320Kbps), the sound may skip during playback.
- A maximum of 500 tracks can be played per CD.
- A maximum of 300 folders can be played per CD.

CD-R JPEG Discs

- Only files with the ".jpeg" and ".JPEG" extensions can be played.
- If the disc is not closed, it will take longer to start playing and not all of the recorded files may be played.
- Only CD-R discs with JPEG files in ISO 9660 or Joliet format can be played.
- JPEG file names should be 8 characters or less in length and contain no blank spaces or special characters (. / = +).
- Only a consecutively written multisession disc can be played. If there is a blank segment in the multisession disc, the disc can be played only up to the blank segment.
- A maximum of 9,999 images can be stored on a single CD.
- When playing a Kodak/Fuji Picture CD, only the JPEG files in the picture folder can be played.
- Picture discs other than Kodak/Fuji Picture CDs may take longer to start playing or may not play at all.

Description



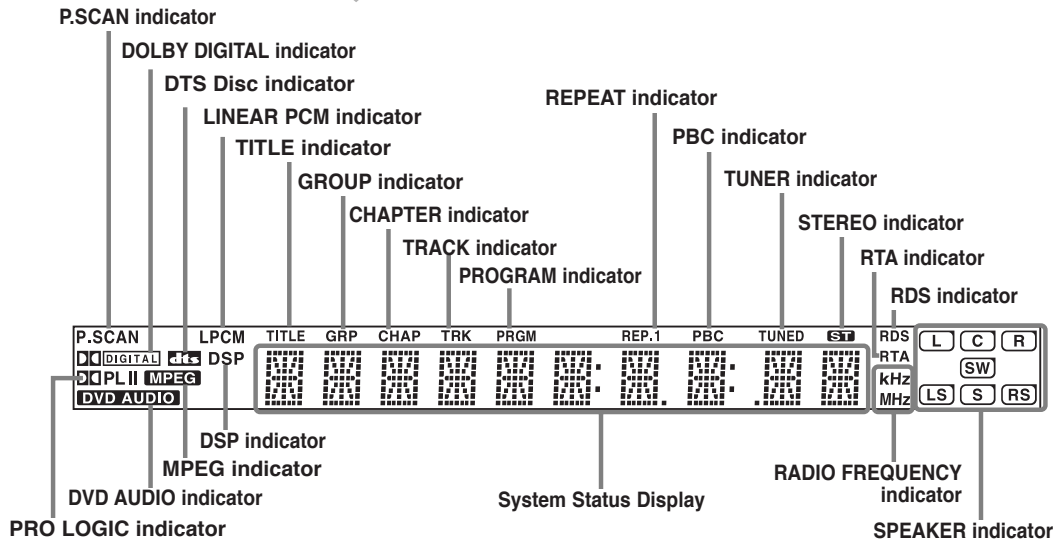
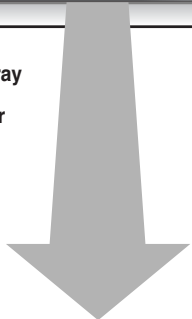
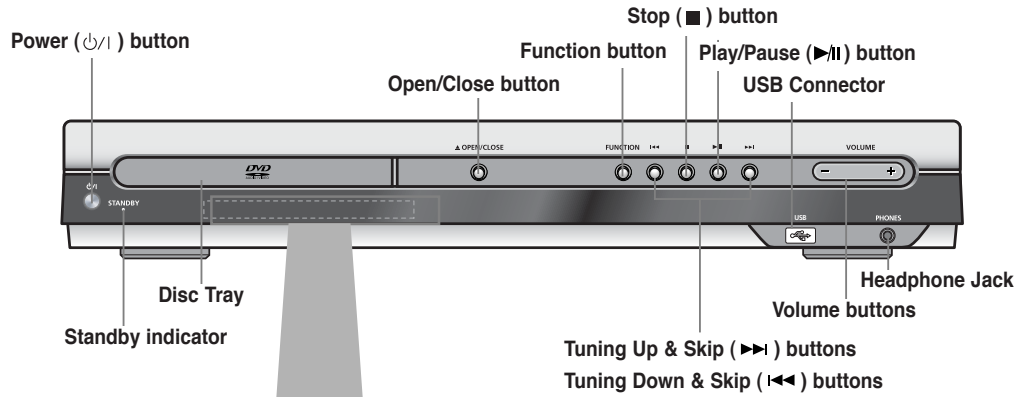

—Front Panel—

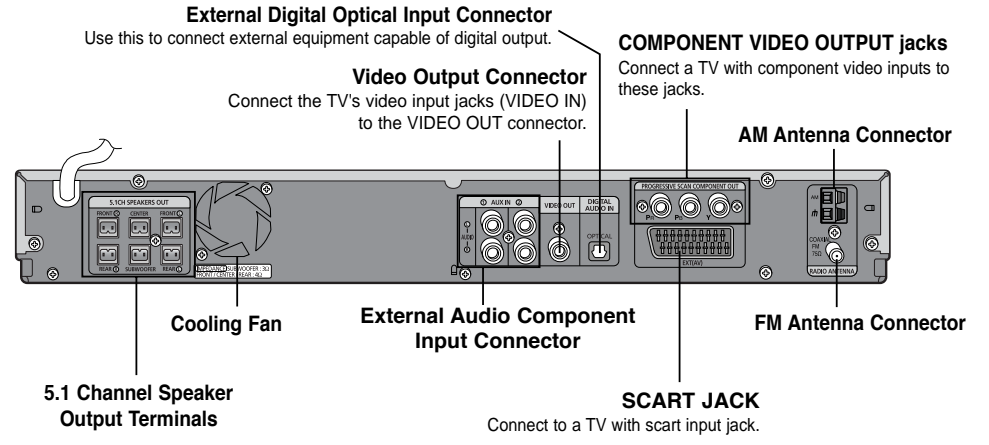

—Rear Panel—



Accessories

 Remote Control	 Video Cable	 AM Antenna
 FM Antenna	 User's Manual	

Description

—Remote Control—

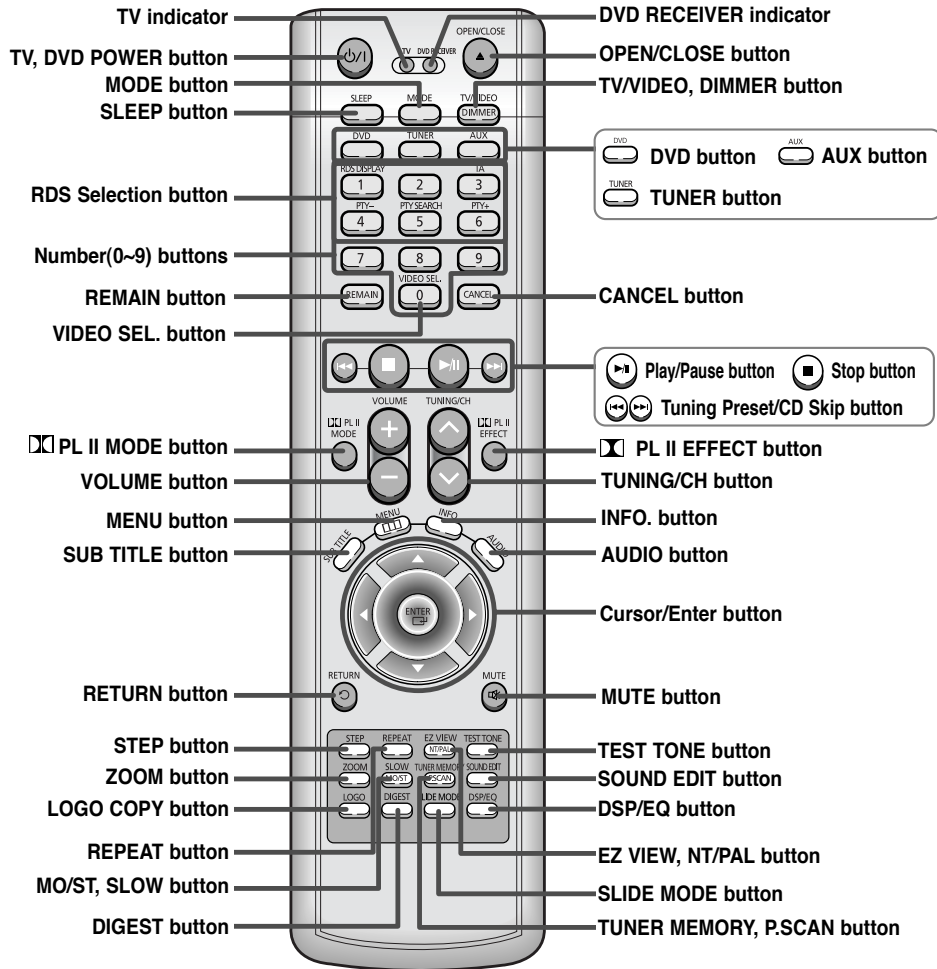

Insert Remote Batteries

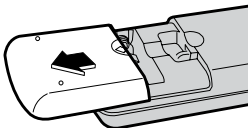
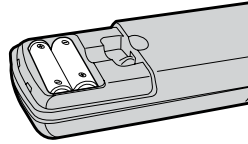
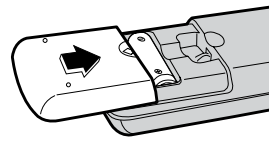
<p>1 Remove the battery cover on the back of the remote by pressing down and sliding the cover in the direction of the arrow.</p> 	<p>2 Insert two 1.5V AAA batteries, paying attention to the correct polarities (+ and -).</p> 	<p>3 Replace the battery cover.</p> 
--	--	--

- Caution** Follow these precautions to avoid leaking or cracking cells:
- Place batteries in the remote control so they match the polarity:(+) to (+)and (-)to (-).
 - Use the correct type of batteries.Batteries that look similar may differ in voltage.
 - Always replace both batteries at the same time.
 - Do not expose batteries to heat or flame.

Range of Operation of the Remote Control

The remote control can be used up to approximately 23 feet/7 meters in a straight line. It can also be operated at a horizontal angle of up to 30° from the remote control sensor.

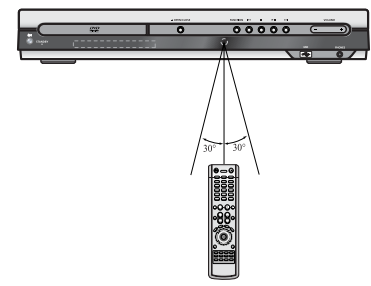

Connecting the Speakers

Before moving or installing the product, be sure to turn off the power and disconnect the power cord.

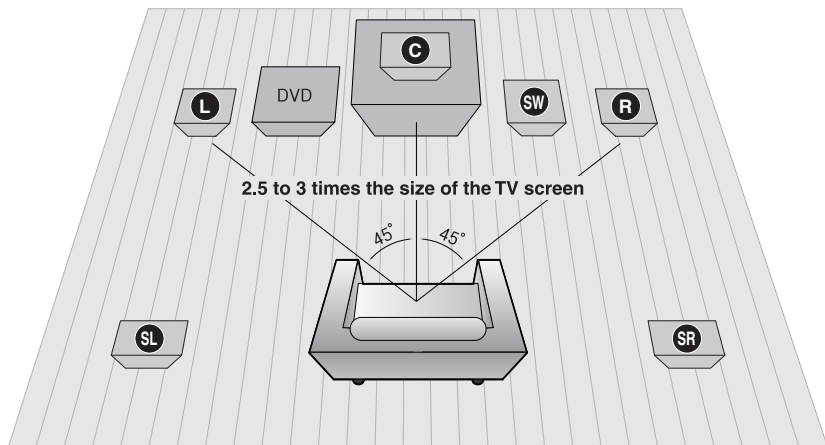

Position of the DVD Player

- Place it on a stand or cabinet shelf, or under the TV stand.

Selecting the Listening Position

The listening position should be located about 2.5 to 3 times the distance of the TV's screen size away from the TV. Example: For 32" TVs 2-2.4m (6-8feet)
For 55" TVs 3.5-4m (11-13feet)

Front Speakers L R

- Place these speakers in front of your listening position, facing inwards (about 45°) toward you.
- Place the speakers so that their tweeters will be at the same height as your ear.
- Align the front face of the front speakers with the front face of the center speaker or place them slightly in front of the center speakers.

Center Speaker C

- It is best to install it at the same height as the front speakers.
- You can also install it directly over or under the TV.

Rear Speakers SL SR

- Place these speakers behind your listening position.
- If there isn't enough room, place these speakers so they face each other.
- Place them about 60 to 90cm (2 to 3feet) above your ear, facing slightly downward.

* Unlike the front and center speakers, the rear speakers are used to handle mainly sound effects and sound will not come from them all the time.

Subwoofer SW

- The position of the subwoofer is not so critical. Place it anywhere you like.

HT-UP30

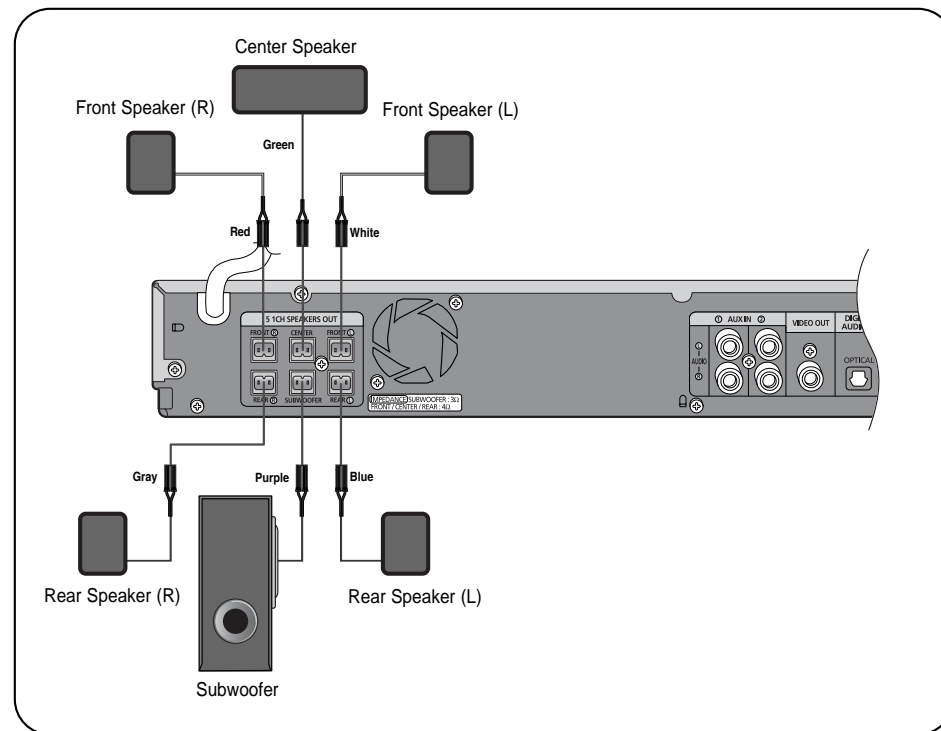

Back of the Speakers

- Press down the terminal tab on the back of the speaker.
- Insert the black wire into the black terminal (-) and the gray wire into the gray (+) terminal, and then release the tab.

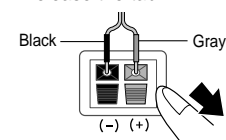
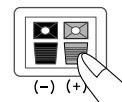

Back of the Main Unit

- Connect the connecting plugs to the back of the DVD player.

- Make sure the colors of the speaker terminals match the colors of the connecting plugs.

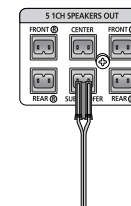

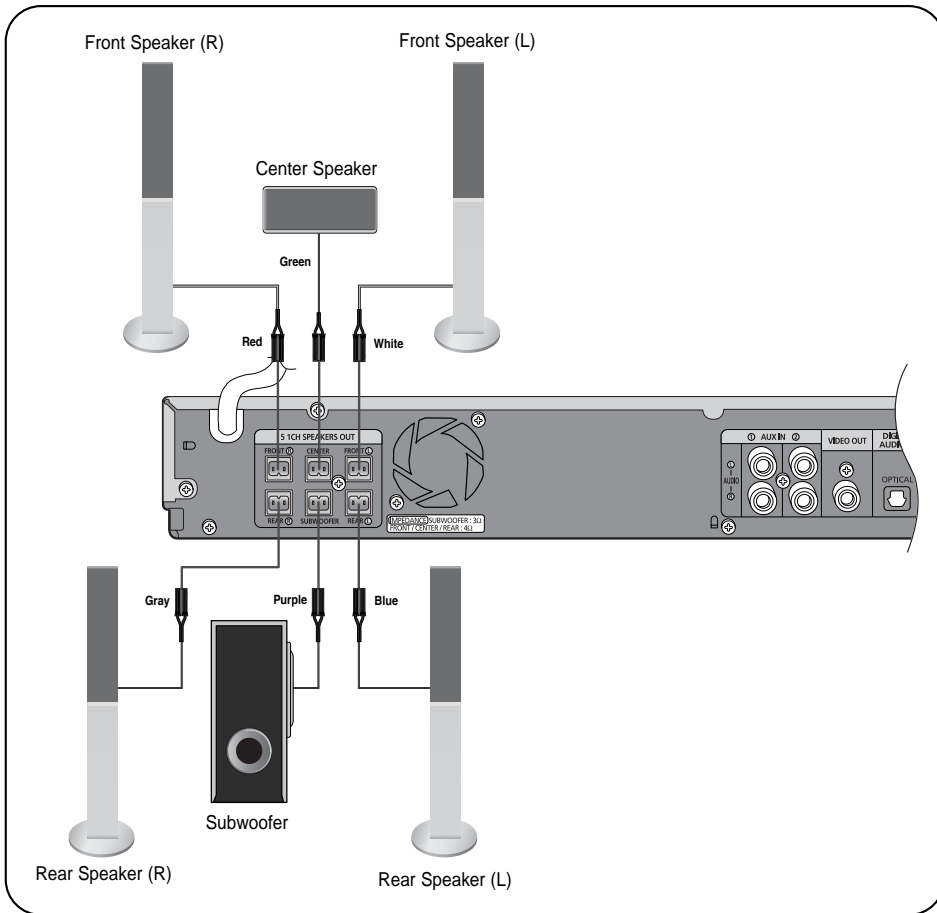

Back of the Speakers

- 1 Press down the terminal tab on the back of the speaker.
- 2 Insert the black wire into the black terminal (-) and the gray wire into the gray terminal (+), and then release the tab.

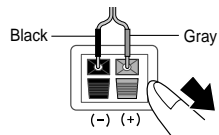
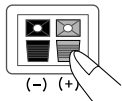

Back of the Main Unit

- 3 Connect the connecting plugs to the back of the DVD player.
 - Make sure the colors of the speaker terminals match the colors of the connecting plugs.

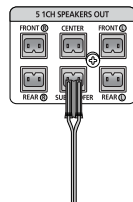

Connecting the Video Out to TV

Choose one of the three methods for connecting to a TV.

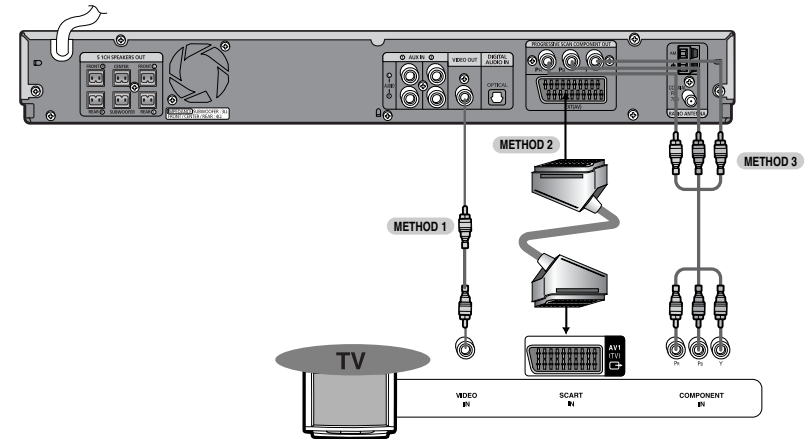

METHOD 1 Composite Video Good Quality

Connect the supplied video cable from the VIDEO OUT jack on the back panel of the system to the VIDEO IN jack on your television.

METHOD 2 Scart Better Quality

If your television is equipped with an SCART input, connect an Scart Jack (not supplied) from the AV OUT jack on the back panel of the system to the SCART IN jack on your television.

VIDEO SELECT Function

Press and hold VIDEO SEL. button on the remote control for over 5 seconds.

- "COMPOSITE" or "RGB" will appear in the display. At this time, press the VIDEO SEL. button shortly to select between "COMPOSITE" and "RGB".
- If Scart (RGB Input) is equipped for your TV, press VIDEO SEL. button to select RGB mode. You can get a better picture quality by using Scart setting.
- If Scart (RGB Input) is not equipped for your TV, press VIDEO SEL. button to select COMPOSITE mode.

METHOD 3 Component (Progressive Scan) Video Best Quality

If your television is equipped with Component Video inputs, connect a component video cable (not supplied) from the Pr, Pb and Y jacks on the back panel of the system to the corresponding jacks on your television.

Note • When the Progressive scan mode is selected, the VIDEO and SCART outputs do not feed any signal.

P.SCAN(Progressive Scan) Function

Unlike regular Interlace Scan, in which two fields of picture information alternate to create the entire picture (odd scan lines, then even scan lines), Progressive Scan uses one field of information (all lines displayed in one pass) to create a clear and detailed picture without visible scan lines.

1 Press STOP button.

- When disc is played back, press the **STOP** button twice so that "STOP", appears on the display.

2 Press and hold P.SCAN button on the remote control for over 5 seconds.

- Pressing and holding the button for over 5 seconds will select "Progressive Scan" and "Interlace Scan" alternately.
- When you select P.SCAN, "P.SCAN" will appear on the display.
- To set P.SCAN mode for DivX discs, press the **P.SCAN** button on the remote control for more than 5 seconds with no disc in the unit ("NO DISC" on the display), then load the DivX disc and play.

What is Progressive (or Non-Interlaced) Scanning?

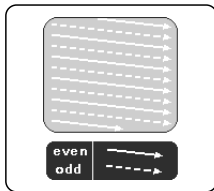
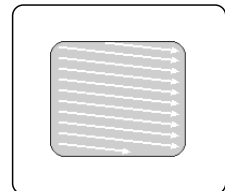
Interlaced Scan (1 FRAME = 2 FIELDS)	Progressive Scan (FULL FRAME)
 <p>In interlaced-scan video, a frame consists of two interlaced fields (odd and even), where each field contains every other horizontal line in the frame. The odd field of alternating lines is displayed first, and then the even field is displayed to fill in the alternating gaps left by the odd field to form a single frame. One frame, displayed every 1/30th of a second, contains two interlaced fields, thus a total of 60 fields are displayed every 1/60th of a second. The interlaced scanning method is intended for capturing a still object.</p>	 <p>The progressive scanning method scans one full frame of video consecutively down the screen, line by line. An entire image is drawn at one time, as opposed to the interlaced scanning process by which a video image is drawn in a series of passes. The progressive scanning method is desirable for dealing with moving objects.</p>

Note

- This function works only on TVs equipped with component video inputs (Y, Pr, Pb) that support Progressive Video. (It does not work on TVs with conventional component inputs, i.e., non-progressive scan TVs.)
- Depending on the brand and model of your TV, this function may not work.

Connecting the FM and AM Antennas

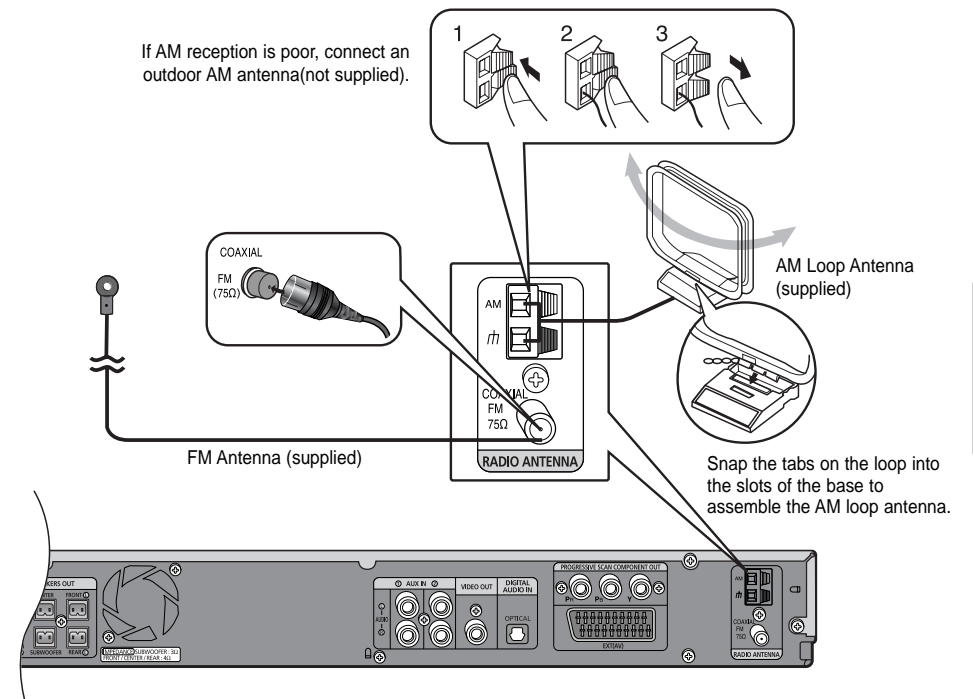

FM antenna connection

1. Connect the FM antenna supplied to the FM 75Ω COAXIAL terminal.
2. Slowly move the antenna wire around until you find a location where reception is good, then fasten it to a wall or other rigid surface.

AM antenna connection

1. Connect the AM loop antenna supplied to the AM and \oplus terminals.
 - Insert the black wire into the black terminal and the white wire into the white terminal.
2. If reception is poor, connect an outdoor single vinyl-covered wire to the AM terminal. (Keep the AM loop antenna connected).

Cooling Fan

The cooling fan supplies cool air to the unit to prevent overheating.

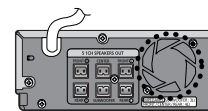

Please observe the following cautions for your safety.

- Make sure the unit is well-ventilated. If the unit has poor ventilation, the temperature inside the unit could rise and may damage it.
- Do not obstruct the cooling fan or ventilation holes. (If the cooling fan or ventilation holes are covered with a newspaper or cloth, heat may build up inside the unit and fire may result.)

Connecting External Components

Connecting an External Digital Component

Example: Digital signal components such as a Set-Top Box or CD Recorder.

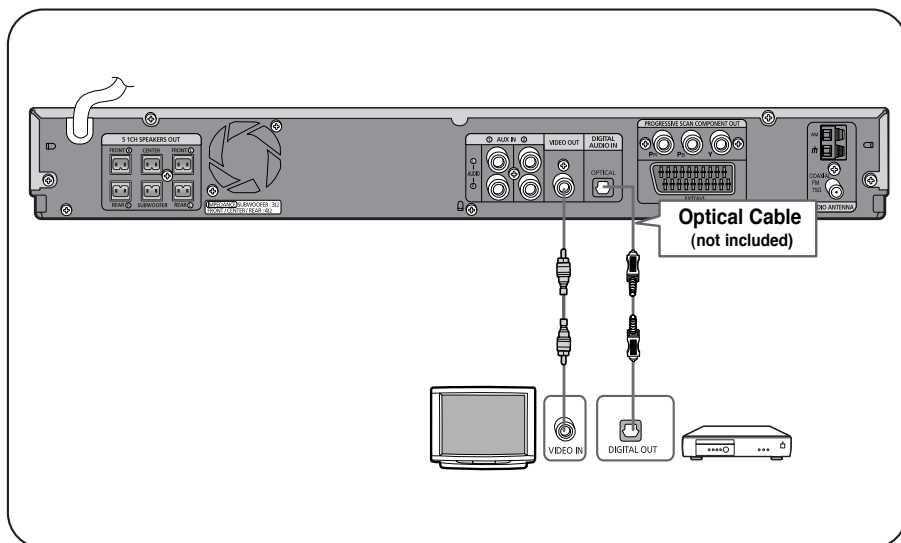

- 1 Connect Video Out on the Home Theater to Video In on the TV.
- 2 Connect the Digital Input (OPTICAL) to the Digital Output on the external digital component.
- 3 Press **AUX** on the remote control to select 'DIGITAL IN'.
 - Each time the button is pressed, the selection changes as follows: **DIGITAL IN** → **AUX 1** → **AUX 2**.
 - You can also use the **FUNCTION** button on the main unit.
The mode switches as follows: **DVD/CD** → **DIGITAL IN** → **AUX 1** → **AUX 2** → **FM** → **AM**.

Connecting an External Analog Component

Analog signal components such as a VCR or TV.

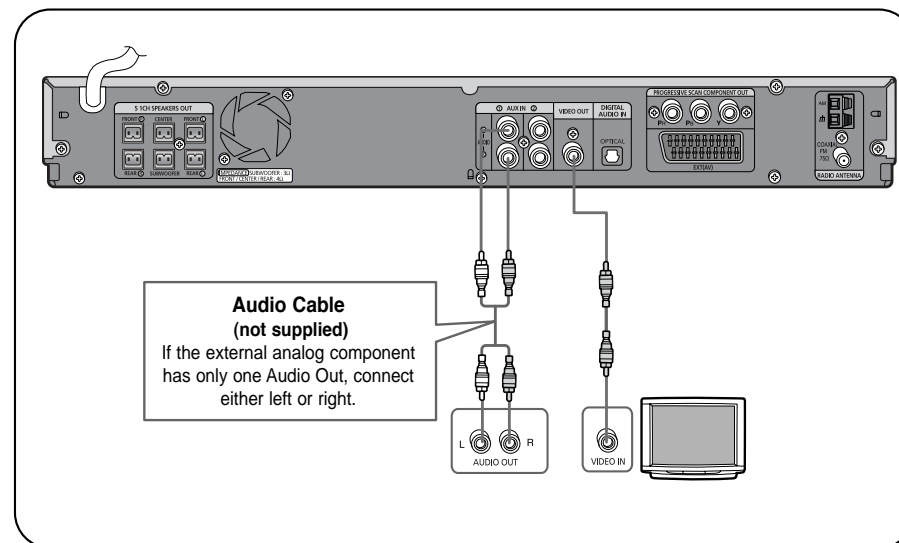

- 1 Connect Video Out on the Home Theater to Video In on the TV.
- 2 Connect Video In on the Home Theater player to Video Out on the external analog component.
- 3 Connect Audio In on the Home Theater to Audio Out on the external analog component.
 - Be sure to match connector colors.
- 4 Press **AUX** on the remote control to select **AUX 1** or **AUX 2** input.
 - Each time the button is pressed, the selection changes as follows: **DIGITAL IN** → **AUX 1** → **AUX 2**.
 - You can also use the **FUNCTION** button on the main unit.
The mode switches as follows: **DVD/CD** → **DIGITAL IN** → **AUX 1** → **AUX 2** → **FM** → **AM**.

Note

- If you have connected an external digital component and also an Analog component to Video In (1, 2) at the same time, there will be video from AUX 1 even when you select DIGITAL IN.
- If you have connected Audio In (L, R) to 1, connect Video In to 1 as well, and if you have connected Audio In (L, R) to 2, connect Video In to 2 also.
- When you select Aux 1 or 2, you are selecting Video 1 or 2 inputs respectively.

Before Using Your Home Theater

Your Home Theater is capable of playing DVD, CD, MP3, DivX and JPEG discs. Depending on the disc you are using, these instructions may vary slightly. Read the instructions carefully before using.

1 Plug the main unit's power cord into the AC power supply.

2 Press **MODE** button until the DVD indicator lights.

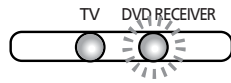

3 Press **POWER** button to turn on the main unit and then press **DVD** button to select "DVD/CD" function of the remote control.



4 Press the **MODE** button until the TV indicator lights.

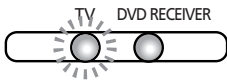

5 Press **POWER** button to turn on the Home Theater and then press **TV/VIDEO** button on your TV remote to select "External Input" mode.

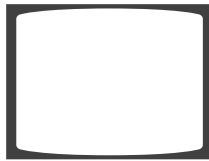

6 Press **FUNCTION** button on the main unit or DVD on the remote to select DVD/CD mode.

To Operate the TV and DVD Player with a Single Remote Control

Press **MODE** button.

- You can operate the TV after TV indicator (red) blinks 1 time, and operate DVD receiver after DVD indicator (green) blinks 1 time.
- Buttons Enabled for TV Operation: POWER, CHANNEL, VOLUME, TV/VIDEO, and Numeric (0-9) buttons.
- By default, the remote control is set to work with Samsung TVs.
See page 66 for more information on the operation of the remote control.

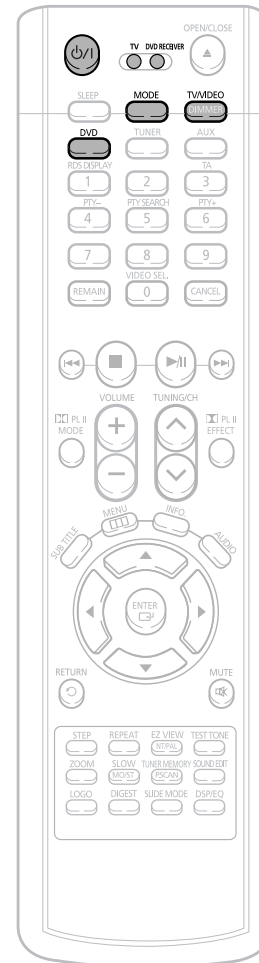

Disc terminology

Groups and tracks (DVD-AUDIO)

- DVD-audio is divided into several large sections called "groups" and smaller sections called "tracks". Numbers are allotted to these sections. These numbers are called "group numbers" and "track numbers".

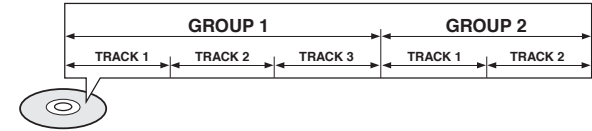

Titles and chapters (DVD-VIDEO)

- DVD-video is divided into several large sections called "titles" and smaller sections called "chapters". Numbers are allotted to these sections. These numbers are called "title numbers" and "chapter numbers".

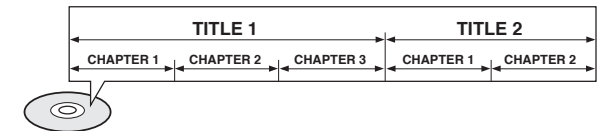

Tracks (Video and music CDs)

- Video and music CDs are divided into sections called "tracks". Numbers are allotted to these sections. These numbers are called "track numbers".

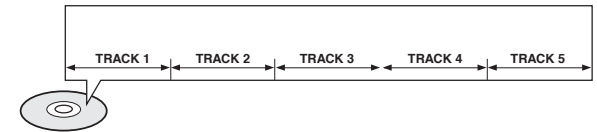

Files (DivX)

- DivX is divided into sections called "files". Numbers are allotted to these sections. These numbers are called "file numbers".

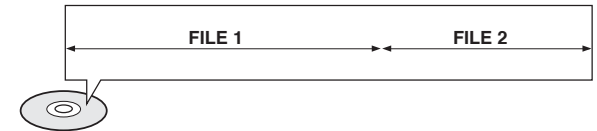

Note • In this manual, the instructions marked with "DVD (DVD)" are applicable to DVD-VIDEO, DVD-AUDIO, and DVD-R/RW discs.
Where a particular DVD type is mentioned, it is indicated separately.

- Depending on the content of the disc, the initial screen may appear different.

Disc Playback

1 Press **OPEN/CLOSE** button to open the disc

2 Load a disc.

- Place a disc gently into the tray with the disc's label facing up.

3 Press **OPEN/CLOSE** button to close the disc tray.

DVD VCD CD

- Playback starts automatically.

Note

- Depending on the content of the disc, the initial screen may appear different.

To stop playback, press **STOP** during playback.

- If pressed once, "PRESS PLAY" is displayed and the stop position will be stored in memory. If **PLAY/PAUSE** (▶/||) button or **ENTER** button is pressed, playback resumes from the stop position. (This function works only with DVDs.)
- If pressed twice, "STOP" is displayed, and if **PLAY/PAUSE** (▶/||) button is pressed, playback starts from the beginning.

To temporarily pause playback, press **PLAY/PAUSE** during playback.

- To resume playback, press **PLAY/PAUSE** (▶/||) button again.

Selecting the Video Format

Press and hold **NT/PAL** button on the remote controller for over 5 seconds while the power is turned off.

- By default, the video format is set to "PAL".
- "NTSC" or "PAL" will appear in the display. At this time, press the **NT/PAL** button shortly to select between "NTSC" and "PAL".
- Each country has a different video format standard.
- For normal playback, the video format of the disc must be the same as the video format of your TV.

MP3-CD Playback

Data CDs (CD-ROM, CD-R, CD-RW) encoded in MP3 format can be played.

MP3

1 Press the **OPEN/CLOSE** button to open the disc tray, and then load the MP3 disc.

- The MP3 menu screen will appear and playback will start.
- The appearance of the menu depends on the MP3 disc.



2 In Stop mode, use ◀ ▶ ▲ ▼ to select the album, and then press the **ENTER** button.



3 To change the album, use ◀ ▶ ▲ ▼ to select another album and then press the **ENTER** button.

- To select another album and track, repeat Steps 2 and 3 above.

4 Press the **STOP** button to stop playback.

Note

- Depending on the recording mode, some MP3-CDs may not play.
- Table of contents of a MP3-CD varies depending on the MP3 track format recorded on the disc.
- MP3 file support: MPEG1 LAYER3 (BITRATE : 128KBPS~320KBPS, SAMPLING FREQ.: 32K/44.1K/48KHz)

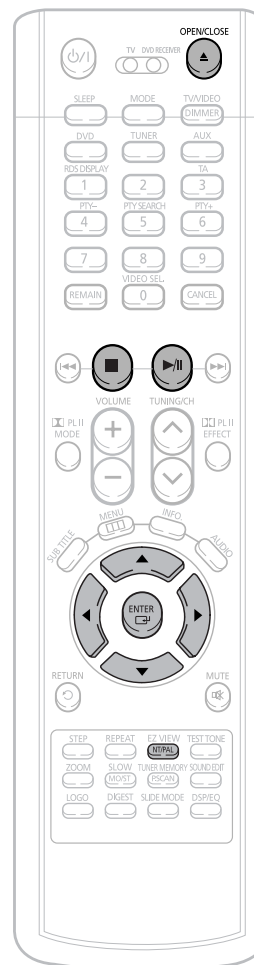

JPEG File Playback JPEG

Images captured with a digital camera or camcorder, or JPEG files on a PC can be stored on a CD and then played back with this DVD player.

Slide Mode

1 Place the JPEG disc on the disc tray.

2 Press the **OPEN/CLOSE** button.

3 Press **SLIDE MODE** button.

- Playback starts automatically.
- Each time the button is pressed, the image makes the transition as follows:

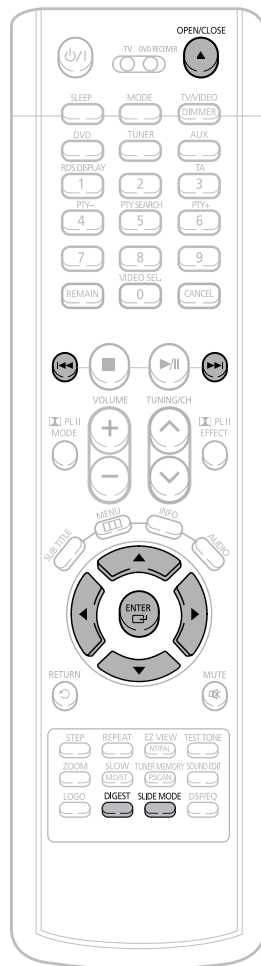
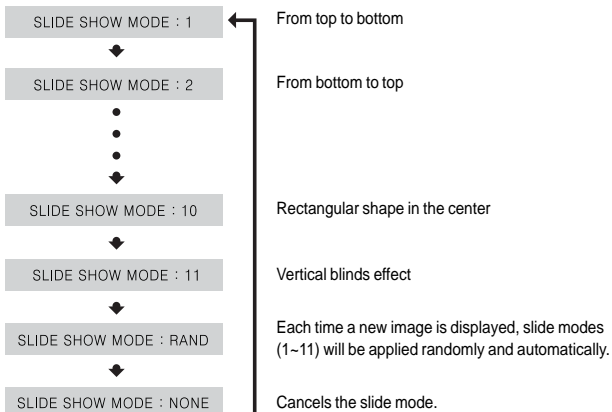

Press **◀▶** to skip to the next slide.

- Each time the button is pressed, the slide moves backward or forward.

Digest Function

You can view 9 JPEG images on the TV screen.

1 Press **DIGEST** button during playback.

- JPEG files will be shown in 9 windows.



2 Press Cursor **▲, ▼, ◀, ▶** buttons to select the desired image and then press **ENTER** button.

- The selected image is played for 5 seconds before moving to the next image.



To view the previous or next image with 9 windows, press **◀▶**.

Rotate/Flip Function

Press Cursor **▲, ▼, ◀, ▶** buttons during playback.

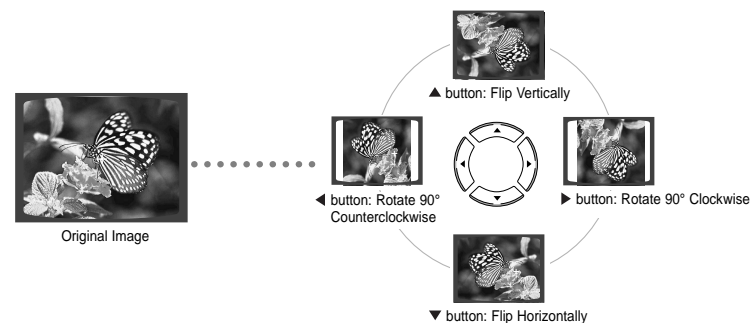

DivX Playback

Skip Forward/Back

During playback, press the **◀▶▶▶** button.

- Go to the next file whenever you press **▶▶▶▶** button, if there are over 2 files in the disk.
- Go to the previous file whenever you press **◀◀◀◀** button, if there are over 2 files in the disk.

Fast playback

To play back the disc at a faster speed, press and hold **◀◀◀** or **▶▶▶** during playback.

- Each time you press and hold either button, the playback speed will change as follows:
2x → 4x → 8x → 32x → Normal.

5 Minute Skip function

During playback, press the **◀, ▶** button.

- Playback skips 5 minutes forward whenever you press **▶** button.
- Playback skips 5 minutes back whenever you press **◀** button.

Zoom Function

1 Press **ZOOM** button.

- Each time you press the button, your selection will toggle between "ZOOM X2" and "ZOOM OFF".

2 Press Cursor **▲, ▼, ◀, ▶** buttons to move to the area you want to enlarge.

- Note** • DIVX file can be zoomed only in ZOOM X2 mode.

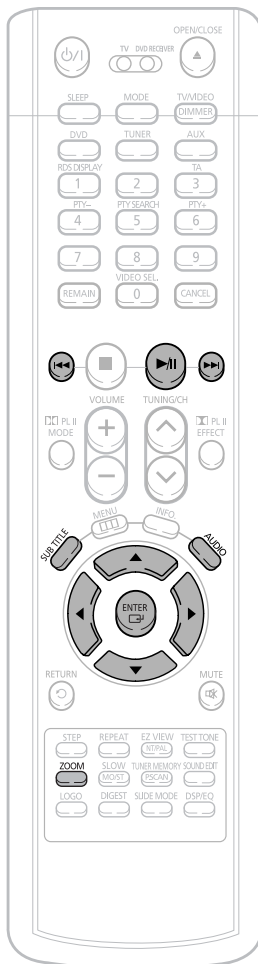

Subtitle Display

Press the **SUBTITLE** button.

- Each time you press the button, your selection will toggle between "SUBTITLE ON" (1/1, 1/2 ...) and "SUBTITLE OFF".
- If the disc has only one subtitle file, it will be played automatically.

Audio Display

Press the **AUDIO** button.

- Each time you press the button, your selection will toggle between "AUDIO ON" (1/1, 1/2 ...) and "AUDIO OFF".

- Note** • " " is displayed when there is one supported language in the disc.

DivX(Digital internet video eXpress)

DivX is a video file format developed by Microsoft and is based on MPEG4 compression technology to provide audio and video data over the Internet in real-time. MPEG4 is used for video encoding and MP3 for audio encoding so that the users can watch a movie at near DVD-quality video and audio.

1. Supported Formats

- This product only provides the following media formats. If both video and audio formats are not supported, the user may experience problems such as broken images or no sound.

• Supported Video Formats

Format	AVI	WMA
Supported Versions	DivX3.11 ~ 5.1	V1/V2/V3/V7

• Supported Audio Formats

Format	MP3	WMA	AC3	DTS
Bit Rate	80~384kbps	56~128kbps	128~384kbps	N/A
Sampling Frequency	44.1khz		44.1/48khz	N/A

- Aspect Ratio: Although default DivX resolution is 640*480 pixels (4:3), this product supports up to 720*480 pixels (16:9). TV screen resolutions higher than 800 will not be supported.
- When you play a disc whose sampling frequency is higher than 48khz or 320kbps, you may experience shaking on the screen during playback.

2. Caption Function

- You must have some experience with video extraction and editing in order to use this feature properly.
- To use the caption function, save the caption file (*.smi) in the same file name as that of the DivX media file (*.avi) within the same folder.

Example. Root Samsung_Bluetek_007CD1.avi
Samsung_Bluetek_007CD1.smi

- Up to 60 alphanumeric characters or 30 East Asian characters (2 byte characters such as Korean and Chinese) for the file name.

Playing Media Files using the USB HOST feature

You can connect and play files from external USB storage devices such as MP3 players, USB flash memory, etc. using the Home Theater's USB HOST function.

1 Open the USB cap and connect the USB cable.

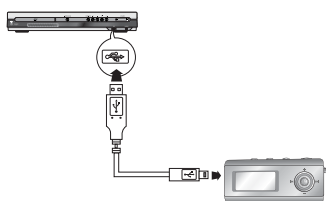

2 Press the **FUNCTION** button on the main unit or the **AUX** button on the remote control to select the USB mode.

- "USB" appears on the display screen and then disappears.
- USB SORTING screen appears on the TV screen and the saved file is played.

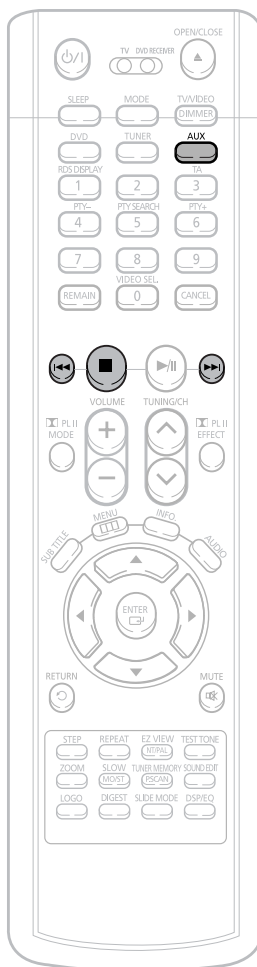

To stop playback, press the **STOP** (■) button.

- Note**
- Video files (DivX, ASF, WMV, MPEG, etc.) are not supported.
 - To prevent the loss of data saved in the USB device, please turn the unit off or switch it to another mode before disconnecting the USB cable.

To play a file in the USB menu screen,

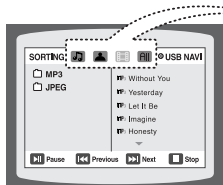

- Music File Icon
- Image File Icon
- All File Icon

Press the ◀ ▶ ▲ ▼ button when it is in stop status and select a desired icon from the top part of the menu.

- To play music files only, select the 🎵 icon.
- To view image files only, select the 🖼️ icon.
- To select all files select the 📁 icon.

Skip Forward/Back

During playback, press the ◀▶▶▶ button.

- When there is more than a file, when you press the ▶▶▶ button, the next file is selected.
- When there is more than a file, when you press the ◀◀◀ button, the previous file is selected.

Fast playback

To play back the disc at a faster speed, press and hold ◀◀ or ▶▶ during playback.

- Each time you press and hold either button, the playback speed will change as follows: 2x → 4x → 8x → 32x → Normal.

Compatible Devices

1. USB devices that support USB Mass Storage v1.0. (USB devices that operate as a removable disk in Windows (2000 or later) without additional driver installation.)
2. MP3 Player: HDD and flash type MP3 player.
3. Digital camera: PTP protocol is not supported.
 - Devices which require additional program installation when you have connected it to a computer, are not supported.
4. USB HDD and USB Flash Drive: Devices that support USB2.0 or USB1.1.
 - You may experience a difference in playback quality when you connect a USB1.1 device.
 - For a USB HDD, make sure to connect an auxiliary power cord to the USB HDD for proper operation.
5. USB card Reader: One slot USB card reader and Multi slot USB card reader
 - Depending on the manufacturer, the USB card reader may not be supported.
 - If you install multiple memory devices into a multi card reader, you may experience problems.

Supported Formats

	File name	File extension	Bit rate	Version	Pixel	Sampling Frequency
Still Picture	JPG	.JPG .JPEG	-	-	640*480	-
Music	MP3	.MP3	80-384kbps	-	-	44.1kHz
	WMA	.WMA	56-128kbps	V8	-	44.1kHz

- A device using NTFS file system is not supported. (Only FAT file system is supported.)

Displaying Disc Information

You can view disc playback information on the TV screen.

Press **INFO** button.

- Each time the button is pressed, the display changes as follows:

DVD

↓

↓

The information display disappears from the screen

VCD CD

↓

The information display disappears from the screen

MP3 DivX JPEG

↓

The information display disappears from the screen

↓

Hand icon appears on the TV screen!

If this symbol appears on the TV screen while buttons are being operated, that

Note

- Depending on the disc, the disc information display may appear different.
- Depending on the disc, you can also select DTS, DOLBY DIGITAL, or PRO LOGIC.

Screen Display

DVD DVD display	DivX DivX display	CHAPTER display	REPEAT PLAYBACK display	LR STEREO (L/R) display
VCD VCD display	DVD AUDIO DVD-AUDIO display	TRACK (FILE) display	AUDIO LANGUAGE display	DOLBY DIGITAL display
CD CD display	TITLE display	ELAPSED TIME display	SUBTITLE display	ANGLE display
MP3 MP3 CD display	GROUP display			

Checking the Remaining Time

Press the **REMAIN** button.

- For checking the total and remaining time of a title or chapter being played.

Each time the **REMAIN** button is pressed

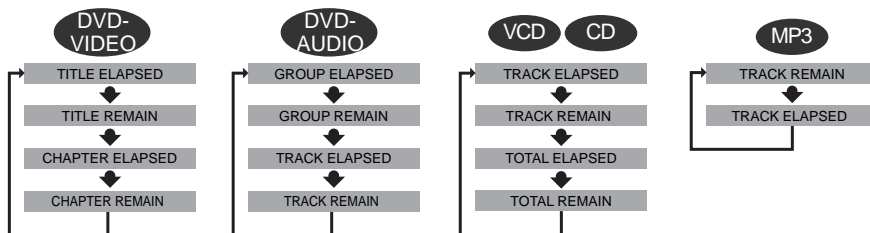

Fast/Slow Playback

Fast Playback

DVD VCD CD MP3

Press and hold **Fast Playback** button.

- Each time the button is held down during playback, the playback speed changes as follows:

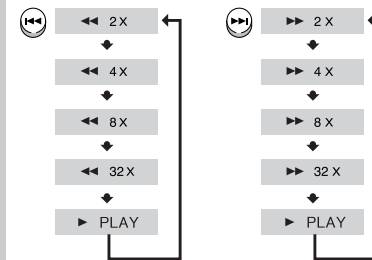

Slow Playback

Press **SLOW** button.

- Each time the button is pressed during playback, the playback speed changes as follows:

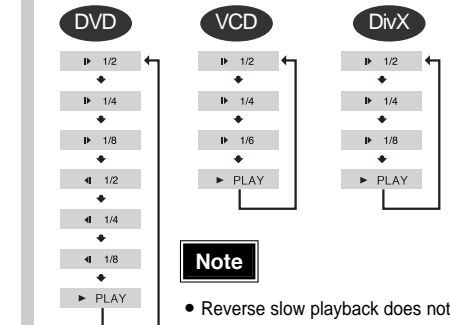

Skipping Scenes/Songs

Briefly press **Scene/Song Skip** button.

- Each time the button is pressed briefly during playback, the previous or next chapter, track, or directory (file) will be played.
- You cannot skip chapters consecutively.



- When watching a VCD with a track longer than 15 minutes, each time **Scene/Song Skip** is pressed, playback will skip back or forward 5 minutes.

Repeat Playback

Repeat playback allows you to repeatedly play a chapter, title, track (song), or directory (MP3 file).

DVD VCD CD MP3 JPEG

Press **REPEAT** button.

- Each time the button is pressed during playback, the repeat playback mode changes as follows:

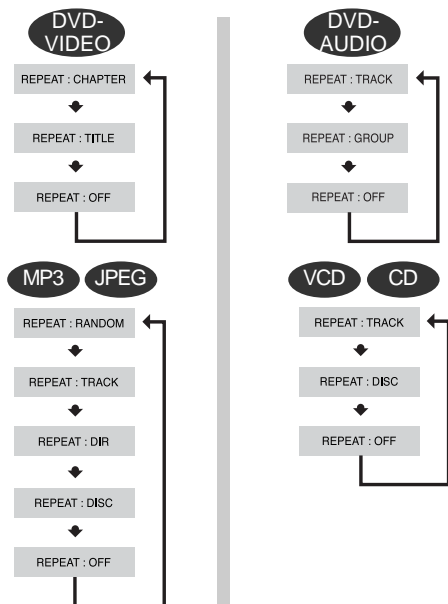

Repeat Playback Options

- CHAPTER**
Repeatedly plays the selected chapter.
- TITLE**
Repeatedly plays the selected title.
- GROUP**
Repeatedly plays the selected group.
- RANDOM**
Plays tracks in random order.
(A track that has already been played may be played again.)
- TRACK**
Repeatedly plays the selected track.
- DIR**
Repeatedly plays all tracks in the selected folder.
- DISC**
Repeatedly plays the entire disc.
- OFF**
Cancels Repeat Playback.

To Select a Repeat Playback Mode in the Disc Information Screen

- Press **INFO** button twice.
- Press Cursor **▶** button to move to REPEAT PLAYBACK (↻) display.
- Press Cursor **▼** button to select the desired Repeat Playback mode.
- Press **ENTER** button.

* For MP3 and JPEG discs, you cannot select Repeat Play from the information display screen.

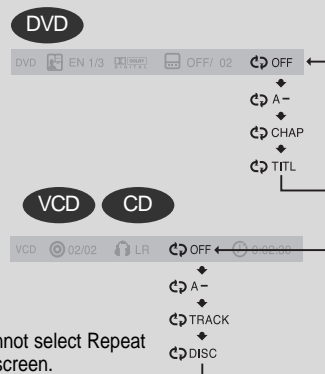

A-B Repeat Playback

You can repetitively play back a designated section of a DVD.

DVD VCD CD

- Press **INFO** button twice.

- For a VCD or CD, press **INFO** button once.



- Press Cursor **▶** button to move to REPEAT PLAYBACK (↻) display.



- Press Cursor **▲**, **▼** buttons to select 'A' and then press **ENTER** button at the beginning of the desired segment.

- When **ENTER** button is pressed, the selected position will be stored in memory.



- Press **ENTER** button at the end of the desired segment.

- The specified segment will be played repeatedly.

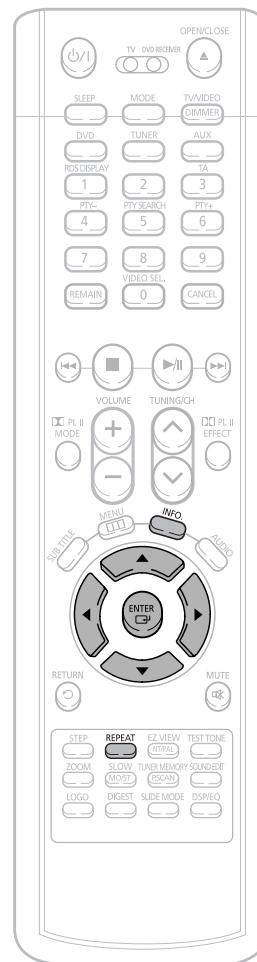

- To return to normal playback, press Cursor **▲**, **▼** buttons to select **↻ OFF**.

Note

- The A-B Repeat function will not work on an MP3 or JPEG disc.

Note

- Repeat playback operation is not possible with version 2.0 VCD discs if PBC is turned on. To use Repeat Playback on a VCD with PBC, you should set the PBC to OFF in the disc menu. (See page 38.)

OPERATION

Step Function DVD VCD

Press **STEP** button.

- The picture moves forward one frame each time the button is pressed during playback.



Note

- During fast playback of a CD or MP3-CD, sound is heard only at 2x speed, and not at 4x, 8x, and 32x speeds.
- No sound is heard during slow playback and step motion playback.

Angle Function DVD

This function allows you to view the same scene in different angles.

1 Press **INFO** button.

2 Press Cursor **▶** button to move to **ANGLE** () display.

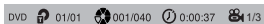

3 Press Cursor **▲, ▼** or numeric buttons to select the desired angle.

- Each time the button is pressed, the angle changes as follows:



Note

- The Angle function works only with discs on which multiple angles have been recorded.

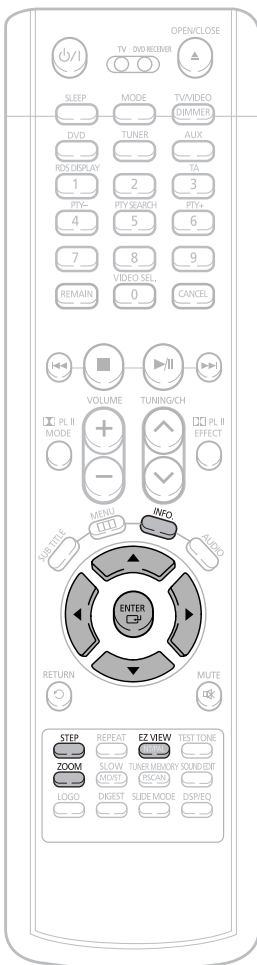

Zoom (Screen Enlarge) Function DVD VCD

This function allows you to enlarge a particular area of the displayed image.

1 Press **ZOOM** button.



2 Press Cursor **▲, ▼, ◀, ▶** buttons to move to the area you want to enlarge.



3 Press **ENTER** button.

- Each time the button is pressed, the zoom level changes as follows:

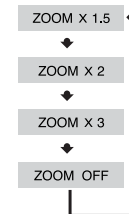

EZ VIEW Function DVD

Press **EZ VIEW** button.

- Each time the button is pressed, the zoom function will switch between On and Off.
- When a movie is played in Widescreen format, black bars at the top and bottom of the TV screen can be removed by pressing the **EZ VIEW** button.

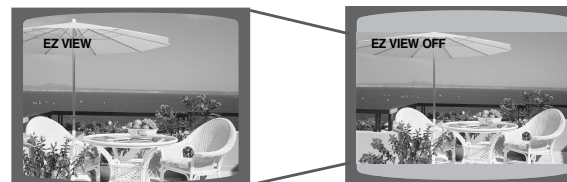

Note

- This function will not work if the DVD is recorded with multi-camera angle format.
- Black bars may not disappear because some DVD discs have a built-in horizontal to vertical ratio.

Bonus Group / Navigating Pages

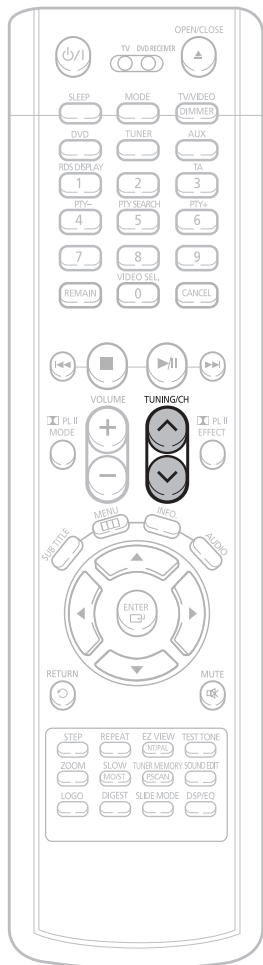

Bonus Group DVD-AUDIO

Some DVD-Audio discs have an extra 'bonus' group that requires a 4-digit key number to access. See the disc packaging for details and the key number.

When you play a DVD-Audio disc that has a bonus group, the key number input screen appears automatically.



Note

- If you eject the disc, switch the power off, or unplug the player, you will need to re-enter the key number.

Navigating Pages DVD-AUDIO

During playback, press the **TUNING/CH** button on the remote control.

- You can select the desired image from a DVD-Audio disc containing still images.
- With some discs, you may not be able to select images depending on how the disc was manufactured.

Selecting Audio/Subtitle Language

Audio Language Selection Function DVD

1 Press **INFO** button twice.



2 Press Cursor **▲**, **▼** buttons or numeric buttons to select the desired audio language.

- Depending on the number of languages on a DVD disc, a different audio language (ENGLISH, SPANISH, FRENCH, etc.) is selected each time the button is pressed.

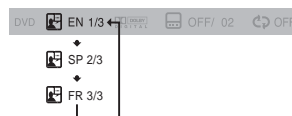

Note

- You can use the **AUDIO** button on the remote control to select a audio language.

Subtitle Language Selection Function DVD

1 Press **INFO** button twice.



2 Press Cursor **▶** button to move to **SUBTITLE ()** display.



3 Press Cursor **▼** button or numeric buttons to select the desired subtitle.

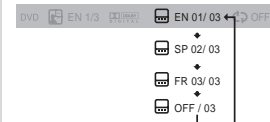

Note

- You can use the **SUBTITLE** button on the remote control to select a subtitle language.
- Depending on the disc, the Subtitle and Audio Language functions may not work.

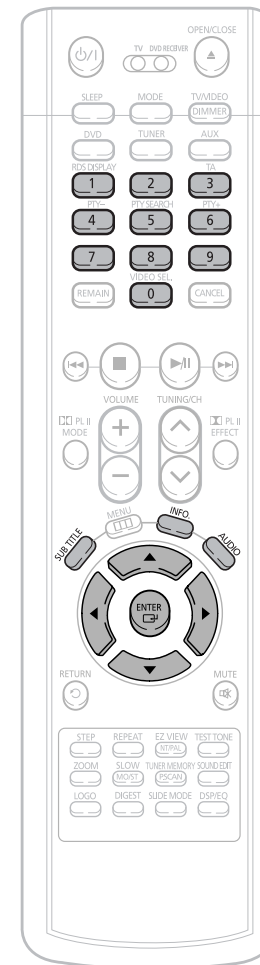

Moving Directly to a Scene/Song

DVD VCD CD

1 Press **INFO** button.

DVD 01/05 001/040 0:00:37 1/1

Moving to a Title/Track

2 Press Cursor \uparrow , \downarrow buttons or numeric buttons to select the desired title/track and then press **ENTER** button.

DVD 03/05 001/002 0:00:01 1/1

Moving to a Chapter

3 Press Cursor \leftarrow , \rightarrow buttons to move to Chapter () display.

DVD 01/05 001/040 0:00:01 1/1

Moving to a Chapter

4 Press Cursor \uparrow , \downarrow buttons or numeric buttons to select the desired chapter and then press **ENTER** button.

DVD 01/05 025/040 0:00:01 1/1

Moving to a Specific Time

5 Press Cursor \leftarrow , \rightarrow buttons to move to time display.

DVD 01/05 025/040 1:17:30 1/1

Moving to a Specific Time

6 Press the numeric buttons to select the desired time and then press **ENTER** button.

DVD 01/05 028/040 1:30:00 1/1

MP3 JPEG

Press the **numeric** buttons.

- The selected file will be played.
- An MP3 or JPEG disc cannot be moved in the disc information screen.
- When playing an MP3 or JPEG disc, you cannot use \uparrow , \downarrow to move to a folder. To move a folder, press \blacksquare (Stop) and then press \uparrow , \downarrow .

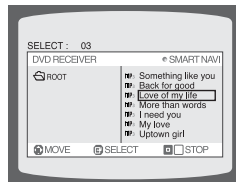

Note

- You can press \lll \ggg on the remote control to move directly to the desired title, chapter, or track.
- Depending on the disc, you may not be able to move to the selected title or time.

Using Disc Menu

You can use the menus for the audio language, subtitle language, profile, etc. DVD menu contents differ from disc to disc.

1 In Stop mode, press **MENU** button.

- When playing a VCD (version 2.), this toggles between PBC ON and OFF.



2 Press Cursor \uparrow , \downarrow buttons to move to 'DISC MENU' and then press **ENTER** button.

- When you select the disc menu that is not supported by the disc, the "This menu is not supported!" message appears on the screen.



3 Press Cursor \uparrow , \downarrow \leftarrow , \rightarrow buttons to select the desired item.

- Press **ENTER** button.



Note

- Disc menu display may be different depending on the disc.

PBC (Playback Control) Function

When playing a VCD (version 2.0), you can select and view various scenes according to the menu screen.

PBC ON: This VCD disc is version 2.0. The disc is played back according to the menu screen. Some functions may be disabled. When some functions are disabled, select "PBC OFF" to enable them.

PBC OFF: This VCD disc is version 1.1. The disc is played back in the same way as with a music CD.

Using the Title Menu

For DVDs containing multiple titles, you can view the title of each movie. Depending on the disc, the availability of this feature may vary.

1 In Stop mode, press **MENU** button.



2 Press Cursor \uparrow , \downarrow button to move to 'Title Menu'.



3 Press **ENTER** button.

- The title menu appears.



Press **MENU** button to exit the setup screen.

Note

- Title menu display may be different depending on the disc.

Setting the Language

OSD (On-Screen Display) language is set to English by default.

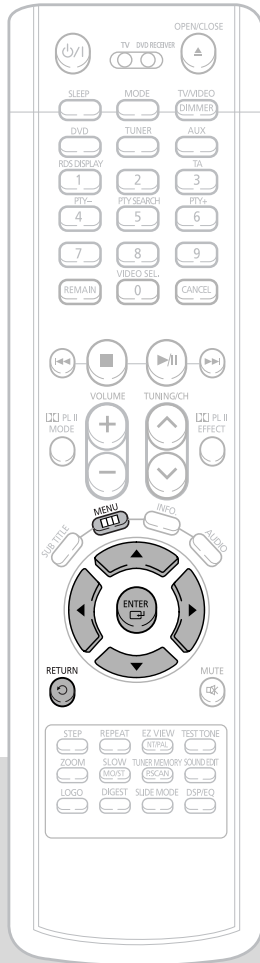

1 In Stop mode, press **MENU** button.



2 Press Cursor **▼** button to move to 'Setup' and then press **ENTER** button.



3 Select 'Language' and then press **ENTER** button



4 Press Cursor **▲, ▼** button to select 'OSD Language' and then press **ENTER** button.



5 Press Cursor **▲, ▼** button to select the desired language and then press **ENTER** button.



- Once the setup is complete, if the language was set to English, OSD will be displayed in English.

Press **RETURN** button to return to the previous level.

Press **MENU** button to exit the setup screen.

Note

- To select another language, select OTHER and enter the language code of your country. (See page 70 for language codes)
AUDIO, SUB TITLE and DISC MENU language can be selected.



Selecting the OSD Language



Selecting the Audio Language (recorded on the disc)



Selecting the Subtitle Language (recorded on the disc)



Selecting the Disc Menu Language (recorded on the disc)

- * If the language you selected is not recorded on the disc, menu language will not change even if you set it to your desired language.

Setting TV Screen type

Depending on your TV type (Wide Screen or conventional 4:3), you can select the TV's aspect ratio.

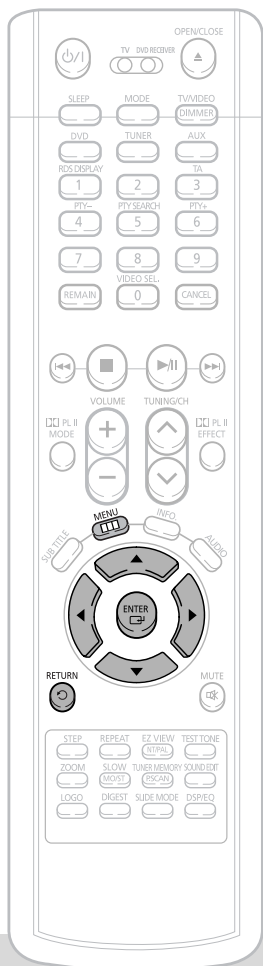

1 In Stop mode, press **MENU** button.



2 Press Cursor \blacktriangledown button to move to 'Setup' and then press **ENTER** button.



3 Press Cursor \blacktriangledown button to move to 'TV DISPLAY' and then press **ENTER** button.



4 Press Cursor $\blacktriangle, \blacktriangledown$ button to select the desired item and then press **ENTER** button.



• Once the setup is complete, you will be taken to the previous screen.

Adjusting the TV Aspect Ratio (Screen Size)

The horizontal to vertical screen size ratio of conventional TVs is 4:3, while that of widescreen and high definition TVs is 16:9. This ratio is called the aspect ratio. When playing DVDs recorded in different screen size, you should adjust the aspect ratio to fit your TV or monitor.

• For a standard TV, select either "4:3LB" or "4:3PS" option according to personal preference. Select "16:9" if you have a widescreen TV.

WIDE

: Select this to view a 16:9 picture in the full-screen mode on your widescreen TV.
• You can enjoy the widescreen aspect.



4:3LB (4:3 Letterbox)

: Select this to play a 16:9 picture in the letter box mode on a conventional TV.
• Black bars will appear at the top and bottom of the screen.



4:3PS (4:3 Pan&Scan)

: Select this to play a 16:9 picture in the pan & scan mode on a conventional TV.
• You can see the central portion of the screen only (with the sides of the 16:9 picture cut off).



Note

• If a DVD is in the 4:3 ratio, you cannot view it in widescreen.
• Since DVD discs are recorded in various image formats, they will look different depending on the software, the type of TV, and the TV aspect ratio setting.

Press **RETURN** button to return to the previous level.

Press **MENU** button to exit the setup screen.

Setting Parental Controls (Rating Level)

Use this to restrict playback of adult or violent DVDs you do not want children to view.

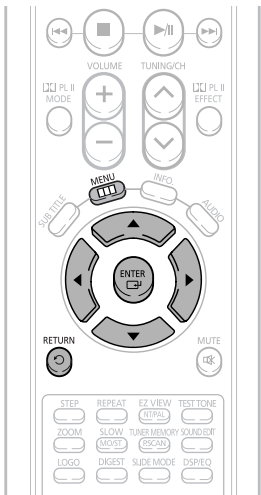

1 In Stop mode, press **MENU** button.



2 Press Cursor \blacktriangledown button to move to 'Setup' and then press **ENTER** button.



3 Press Cursor \blacktriangledown button to move to 'PARENTAL' and then press **ENTER** button.



4 Press Cursor \blacktriangle , \blacktriangledown button to select the desired rating level and then press **ENTER** button.

- If you have selected Level 6, you cannot view DVDs with Level 7 or higher.
- The higher the level, the closer the content is to violent or adult material.



5 Enter the password and then press **ENTER** button.

- The password is set to "7890" by default.
- Once the setup is complete, you will be taken to the previous screen.

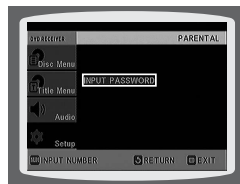

Note • This function works only if a DVD disc contains the rating level information.

Press **RETURN** button to return to the previous level.

Press **MENU** button to exit the setup screen.

Setting the Password

You can set the password for the Parental (rating level) setting.

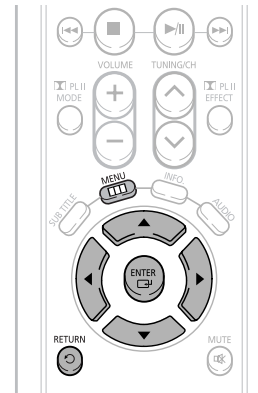

1 Press **MENU** button.



2 Press Cursor \blacktriangledown button to move to 'Setup' and then press **ENTER** button.



3 Press Cursor \blacktriangledown button to move to 'PASSWORD' and then press **ENTER** button.



4 Press **ENTER** button.

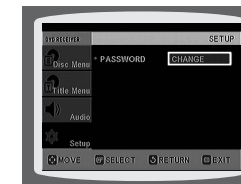

5 Enter the password and then press **ENTER** button.

- Enter the old password, a new password, and confirm new password.
- The setting is complete.



Note • The password is set to "7890" by default.

If you have forgotten the rating level password, do the following:

- While the player is in the no disc mode, hold the main unit's O button for longer than 5 seconds. "INITIALIZE" appears on the display and all settings will return to the default values.
- Press the POWER button.

Using the RESET function will erase all stored settings. Do not use this unless necessary.

Setting the Wallpaper

JPEG DVD VCD

While watching a DVD, VCD or JPEG CD, you can set the image you like as background wallpaper.

Setting the Wallpaper

1 During playback, press **PLAY/PAUSE** button when an image you like appears.



2 Press **LOGO** button.

- "COPY LOGO DATA" will be displayed on the TV screen.



3 The power will turn off and then back on.

- The selected wallpaper will be displayed.
- You can select up to 3 wallpaper settings.

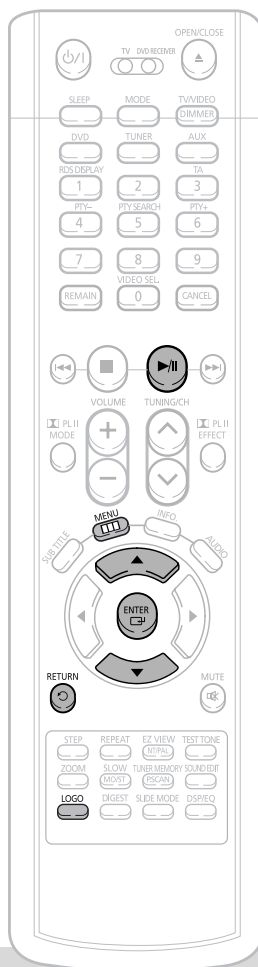

To select one of the 3 wallpaper settings you've made

1 In Stop mode, press **MENU** button.



2 Press **Cursor** button to move to 'Setup' and then press **ENTER** button.



3 Press **Cursor** button to move to 'LOGO' and then press **ENTER** button.



4 Press **▼** to select the desired 'USER', and then press **ENTER**.



5 Press **MENU** button to exit the setup screen.



Select this to set the Samsung Logo image as your wallpaper.



Select this to set the desired image as your wallpaper.

Press **RETURN** button to return to the previous level.

Press **MENU** button to exit the setup screen.

DVD Audio Disc Playback Mode

Some DVD-Audio discs contain DVD-Video as well as DVD-Audio. To play back the DVD-Video portion of the DVD-Audio disc, set the unit to DVD-Video mode.

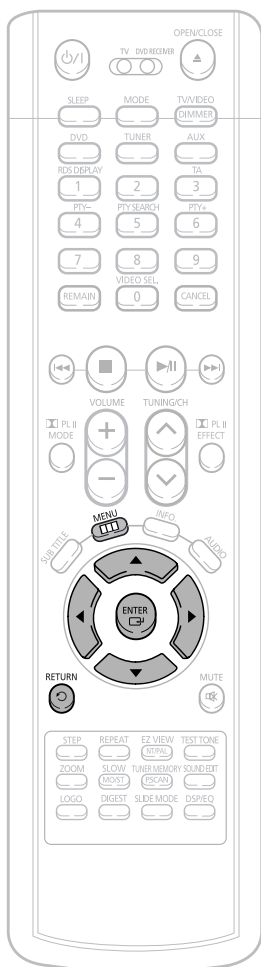

1 Press the **MENU** button while the disc tray is open.



2 Press Cursor **▼** button to move to 'Setup' and then press **ENTER** button.



3 Press Cursor **▼** button to move to 'DVD TYPE' and then press **ENTER** button.



4 Press Cursor **▲, ▼** button to move to 'DVD VIDEO' and then press **ENTER** button.



When Selecting DVD Play Mode:

- **DVD VIDEO** : set to play the DVD video contents contained on a DVD audio disc.
- **DVD AUDIO** : set to play the default DVD audio.

Note

- DVD Play mode is set to DVD Audio as factory default setting.

DivX (R) registration



- Please use the Registration code to register this player with the DivX (R) video on demand format. To learn more, go to www.divx.com/vod.

Setting the Speaker Mode

Signal outputs and frequency responses from the speakers will automatically be adjusted according to your speaker configuration and whether certain speakers are used or not.

1 In Stop mode, press **MENU** button.



2 Press Cursor **▼** button to move to 'Audio' and then press **ENTER** button.

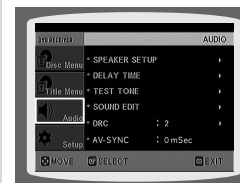

3 In the Speaker Setup, press the **ENTER** button again.



4 Press Cursor **▲, ▼, ◀, ▶** buttons to move to the desired speaker and then press **ENTER** button.

- For C, LS, and RS, each time the button is pressed, the mode switches alternately as follows: SMALL → NONE.
- For L and R, the mode is set to SMALL.



SMALL : Select this when using the speakers.

NONE : Select this when no speakers are connected.

Note

- Depending on PRO LOGIC and STEREO settings, the speaker mode may vary (see page 57).

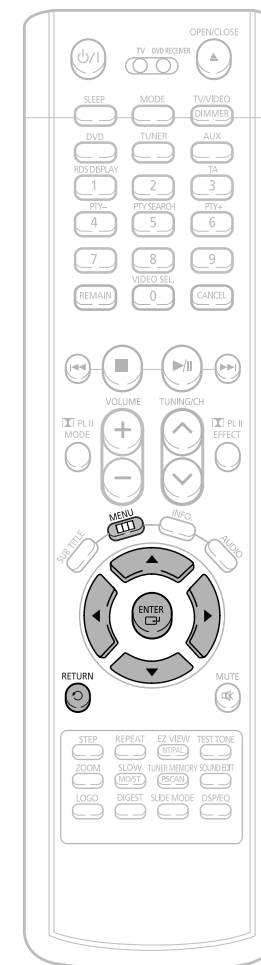

Setting the Delay Time

If the speakers cannot be placed at equal distances from the listening position, you can adjust the delay time of the audio signals from the center and rear speakers.

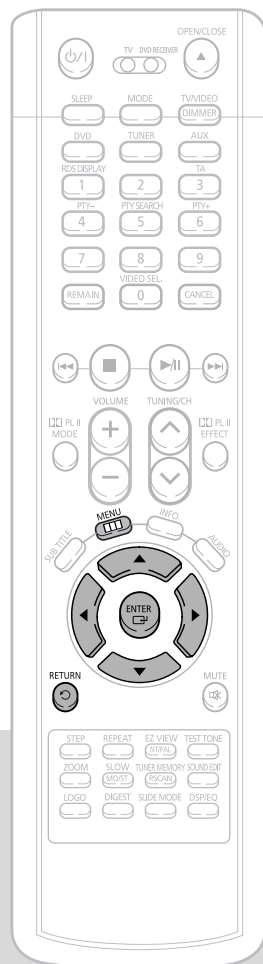

1 In Stop mode, press **MENU** button.



2 Press Cursor ∇ button to move to 'Audio' and then press **ENTER** button.



3 Press Cursor ∇ button to move to 'DELAY TIME' and then press **ENTER** button.



4 Press Cursor $\uparrow, \downarrow, \leftarrow, \rightarrow$ buttons to move to the desired speaker and then press **ENTER** button.



5 Press Cursor \leftarrow, \rightarrow to set the Delay time.



- You can set the delay time for C between 00 and 05mSEC and for LS and RS between 00 and 15mSEC.

Setting up the Speaker Delay Time

When 5.1CH Surround Sound is played, you can enjoy the best sound if the distance between you and each speaker is the same. Since the sounds arrive at the listening position at different times depending on the placement of speakers, you can adjust this difference by adding a delay effect to the sound of the Center Speaker and Surround Speakers.

Note

- With \square PL (Dolby Pro Logic II), the delay time may be different for each mode.
- With AC-3 and DTS, the delay time can be set between 00 and 15mSEC.
- The Center channel is only adjustable on 5.1 channel discs.

Setting CENTER SPEAKER

If the distance of D_c is equal to or longer than the distance of D_f in the figure, set the mode as 0ms. Otherwise, change the setting according to the table.

Distance between D_f and D_c	Delay Time
0.00 m	0 ms
0.34 m	1 ms
0.68 m	2 ms
1.02 m	3 ms
1.36 m	4 ms
1.70 m	5 ms

Setting REAR (SURROUND) SPEAKERS

If the distance of D_f is equal to the distance of D_s in the figure, set the mode as 0ms. Otherwise, change the setting according to the table.

Distance between D_f and D_s	Delay Time
0.00 m	0 ms
1.02 m	3 ms
2.04 m	6 ms
3.06 m	9 ms
4.08 m	12 ms
5.10 m	15 ms

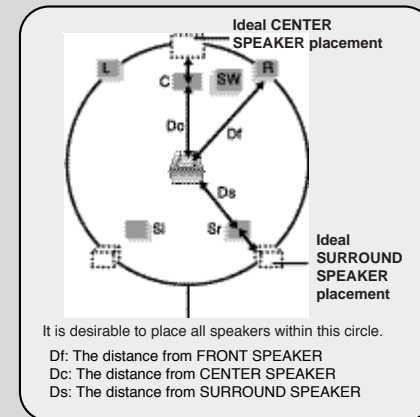

Setting the Test Tone

Use the Test Tone feature to check the speaker connections.

1 In Stop or no disc mode, press **MENU** button.



2 Press Cursor \blacktriangledown button to move to 'Audio' and then press **ENTER** button.



3 Press Cursor \blacktriangledown button to move to 'TEST TONE' and then press **ENTER** button.

- The test tone will be sent to L \rightarrow C \rightarrow R \rightarrow RS \rightarrow LS \rightarrow SW in order. If the **ENTER** button is pressed again at this time, the test tone will stop.



Press **RETURN** button to return to the previous level.

Press **MENU** button to exit the setup screen.

Alternate method: press the **TEST TONE** button on the remote.

Press **TEST TONE** button.

- Test tone will be produced as follows: When playing a DVD or CD, this will work only in Stop mode.
- Use this function to check that each speaker is correctly connected and that there is no problem.

To end the test tone, press **TEST TONE** button again.

L: Front Speaker (L) C: Center Speaker SW: Subwoofer
R: Front Speaker (R) SL: Rear Speaker (L) SR: Rear Speaker (R)

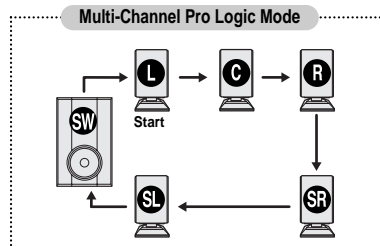

Setting the DRC (Dynamic Range Compression)

You can use this function to enjoy Dolby Digital sound when watching movies at low volume at night.

1 In Stop mode, press **MENU** button.



2 Press Cursor \blacktriangledown button to move to 'Audio' and then press **ENTER** button.



3 Press Cursor \blacktriangledown button to move to 'DRC' and then press **ENTER** button.

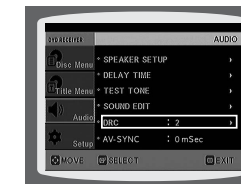

4 Press Cursor $\blacktriangle, \blacktriangledown$ to adjust the 'DRC'.

- When the Cursor \blacktriangle button is pressed, the effect is greater, and when the Cursor \blacktriangledown button is pressed, the effect is smaller.

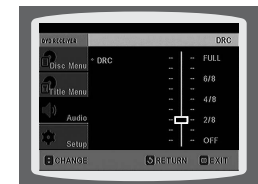

Press **RETURN** button to return to the previous level.

Press **MENU** button to exit the setup screen.

Setting the Audio Quality

You can adjust the balance and level for each speaker.

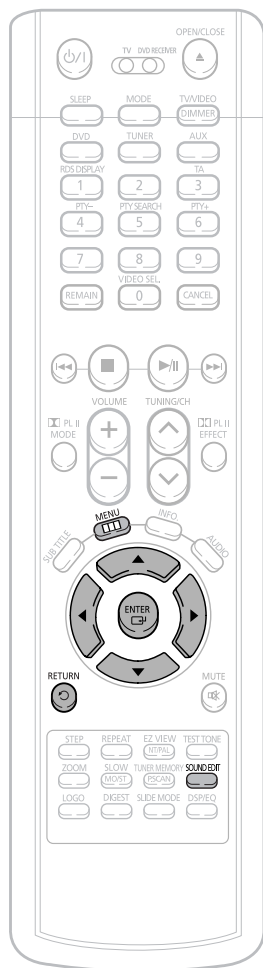

Method 1 When adjusting the audio quality using the setup screen

- 1 In Stop mode, press **MENU** button.
- 2 Press Cursor **▼** button to move to 'Audio' and then press **ENTER** button.
- 3 Press Cursor **▼** button to move to 'SOUND EDIT' and then press **ENTER** button.
- 4 Press Cursor **▲, ▼** buttons to select and adjust the desired item. Press the **◀, ▶** buttons to adjust the settings.

Method 2 When manually adjusting with the SOUND EDIT button

<h3>Adjusting Front Speaker Balance</h3> <ol style="list-style-type: none"> 1 Press SOUND EDIT button and then press Cursor ◀, ▶. <p>00 F -01</p>	<h3>Adjusting Rear Speaker Balance</h3> <ol style="list-style-type: none"> 2 Press SOUND EDIT button and then press Cursor ◀, ▶. <p>00 R -01</p>	<h3>Adjusting Center Speaker Level</h3> <ol style="list-style-type: none"> 3 Press SOUND EDIT button and then press Cursor ◀, ▶. <p>CENTER +1dB</p>
<h3>Adjusting Rear Speaker Level</h3> <ol style="list-style-type: none"> 4 Press SOUND EDIT button and then press Cursor ◀, ▶. <p>REAR -01dB</p>	<h3>Adjusting Subwoofer Speaker Level</h3> <ol style="list-style-type: none"> 5 Press SOUND EDIT button and then press Cursor ◀, ▶. <p>S/W +01dB</p>	

- Press **RETURN** button to return to the previous level.
- Press **MENU** button to exit the setup screen.

- Note**
- The adjustments will appear on the main unit's display, not on your TV screen.
- Adjusting Front/Rear Speaker Balance**
- You can select between 00 and -06 and OFF.
 - The volume decreases as you move closer to -6.
- Adjusting Center/Rear/Subwoofer Speaker Level**
- The volume level can be adjusted in steps from +6dB to -6dB.
 - The sound gets louder as you move closer to +6dB and quieter as you get closer to -6dB.

AV SYNC Setup

Video may look slower than the audio if it is connected to a digital TV. If this occurs, adjust the audio delay time to match the video.

1 Press the **MENU** button.

- Setup menu appears.



2 Press Cursor **▲**, **▼** buttons to move to 'Audio' and then press **ENTER** button.

- 'Audio' menu appears.

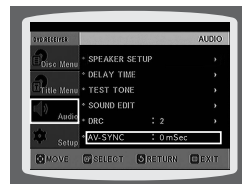

3 Press Cursor **▲**, **▼** buttons to move to 'AV-SYNC' and then press **ENTER** button.

- AV-SYNC screen appears.

4 Press Cursor **▲**, **▼** buttons to select the AV-SYNC Delay Time and then press the **ENTER** button.

- You can set the audio delay time between 0 ms and 300 ms. Set it to the optimal status.

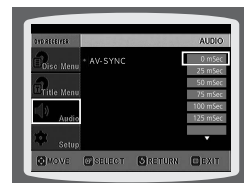

Press **RETURN** button to return to the previous level.

Press **MENU** button to exit the setup screen.

Sound Field (DSP)/EQ Function

DSP(Digital Signal Processor) DSP modes have been designed to simulate different acoustic environments. EQ: You can select ROCK, POP, or CLASSIC to optimize the sound for the genre of music you are playing

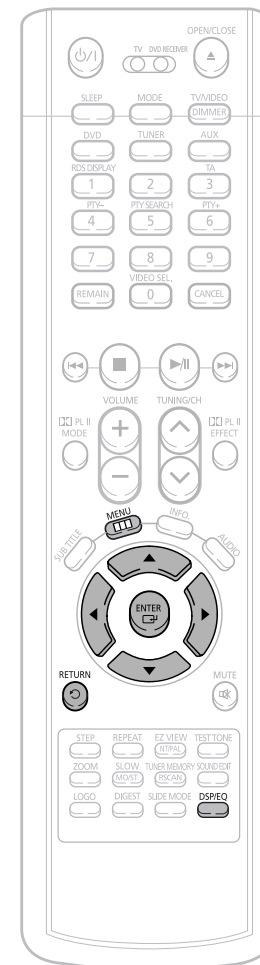

Press **DSP/EQ** button.

- "DSP" appears on the display panel.
- Each time the button is pressed, the selection changes as follows:

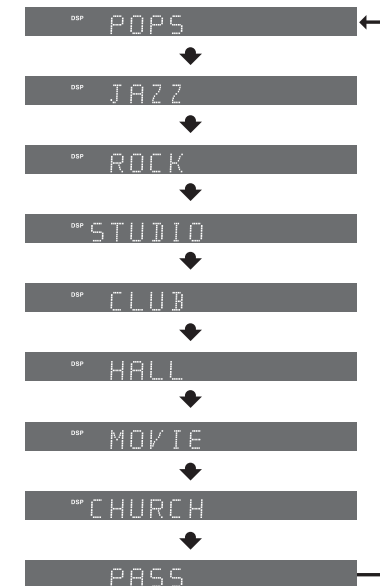

- Note**
- DSP/EQ function is only available in STEREO mode. Press the **PL II** mode button to show STEREO on the display.
 - This feature works with CDs, MP3-CDs, 2 channel DVD-Audio, DivX and Dolby Digital discs.
 - When playing a DVD disc encoded with two or more channels, multi-channel mode will be selected automatically and DSP/EQ function does not work.

Note

- POP, JAZZ, ROCK:** Depending on the genre of music, you can select POP, JAZZ, and ROCK.
- STUDIO :** Provides a sense of presence as if in a studio.
- CLUB :** Simulates the sound of a dance club with a throbbing bass beat.
- HALL :** Provides a clear vocal as if listening in a concert hall.
- MOVIE:** Provides the feeling of a movie theater.
- CHURCH:** Gives the feel of being in a grand church.
- PASS:** Select this for normal listening.

Dolby Pro Logic II Mode

You can select the desired Dolby Pro Logic II audio mode.

Press **PL II MODE** button.

- Each time the button is pressed, the mode changes as follows.

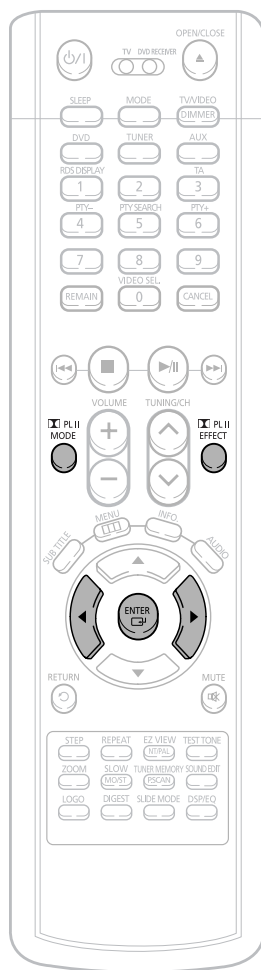
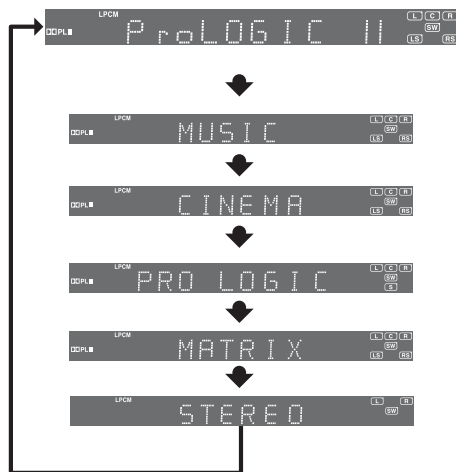

Note

- When selecting Pro Logic II mode, connect your external device to the AUDIO INPUT jacks (L and R) on the player. If you connect to only one of the inputs (L or R), you cannot listen to surround sound.

Dolby Pro Logic II Effect

This function works only in Dolby Pro Logic MUSIC mode.

1 Press **PL II MODE** button to select 'MUSIC' mode.



2 Press **PL II EFFECT** button to select Panorama, then press Cursor **◀**, **▶** buttons to select the desired effect setting.

- You can select either 0 or 1.
- This mode extends the front stereo image to include the surround speakers for an exciting "wraparound" effect with side wall imaging.



3 Press **PL II EFFECT** button to select C-Width, then press Cursor **◀**, **▶** buttons to select the desired effect setting.

- You can select between 0 and 7.
- This sets the width of the center image. The higher the setting, the less sound comes from the center speaker.



4 Press **PL II EFFECT** button to select Dimension, then press the Cursor **◀**, **▶** buttons to select the desired setting.

- You can select between 0 and 6.
- Incrementally adjusts the sound field (DSP) from the front or rear.



Note

- When playing a DVD disc encoded with two or more channels, multi-channel mode will be selected automatically and **PL II** (Dolby Pro Logic II) button does not work.

PRO LOGIC II

- MUSIC:** When listening to music, you can experience sound effects as if you are listening to the actual performance.
- CINEMA:** Adds realism to the movie soundtrack.
- PRO LOGIC:** You will experience a realistic multi-channel effect, as if using five speakers, while using just the front left and right speakers.
- MATRIX:** You will hear 5.1 channel surround sound.
- STEREO:** Select this to listen to sound from the front left and right speakers and the subwoofer only.

About RDS broadcasting

Using the RDS (Radio Data System) to receive FM stations

RDS allows FM stations to send an additional signal along with their regular program signals. For example, the stations send their station names, as well as information about what type of program they broadcast, such as sports or music, etc.

When tuned to an FM station which provides the RDS service, the RDS indicator lights up on the display.

• Description on RDS function

- PTY (Program Type)** : Displays the type of programme currently being broadcast
- PS NAME (Program Service Name)** : Indicates the name of broadcasting station and is composed of 8 characters.
- RT (Radio Text)** : Decodes the text broadcast by a station (if any) and is composed of maximum 64 characters.
- CT (Clock Time)** : Decodes the real time clock from the FM frequency.
 - Some stations may not transmit PTY, RT or CT information therefore this may not be displayed in all cases.
- TA (Traffic Announcement)** : When this symbol flashes it shows that the traffic announcement is in progress.

Note • RDS may not operate correctly if the station tuned is not transmitting RDS signal properly or if the signal strength is weak.

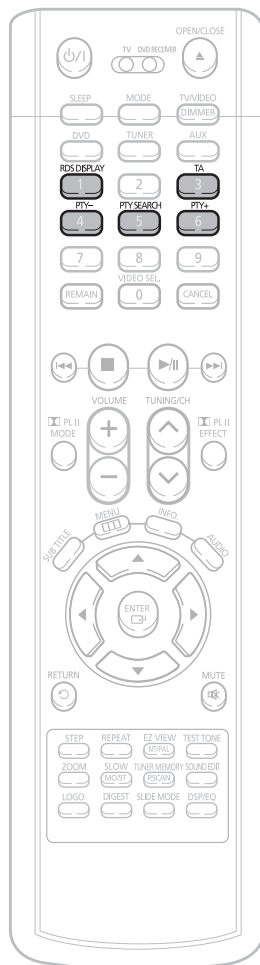

What information can RDS signals provide?

You can see the RDS signals the station sends on the display.

TO show the RDS signals

Press RDS DISPLAY while listening to an FM station.

Each time you press the button, the display change to show you the following information:

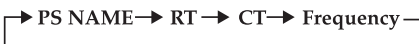

PS (Program Service) : While searching, "PS" appears and then the station names will be displayed. "NO PS" appears if no signal is sent.

RT (Radio Text) : While searching, "RT" appears and then text messages the station sends will be displayed. "NO RT" appears if no signal is sent.

Frequency : station frequency (non-RDS service)

About characters shown in the display

When the display shows PS, or RT signals, the following characters are used.

- The display window cannot differentiate upper case and lower case letters and always uses upper case letters.
- The display window cannot show accented letters, "A," for instance, may stand for accented "A's" like "Ä, Å, Ä, Å, and Ä."

Note • If searching finishes at once, "PS" and "RT" will not appear on the display.

PTY (Program Type) indication and PTY-SEARCH function

One of the advantages of the RDS service is that you can locate a particular kind of program from the preset channels by specifying the PTY codes.

To search for a program using the PTY codes

Before you start, remember...

- The PTY Search is only applicable to preset stations.
- To stop searching any time during the process, press PTY SEARCH while searching.
- There is a time limit in doing the following steps. If the setting is cancelled before you finish, start from step 1 again.
- When pressing the buttons on the primary remote control, make sure that you have selected the FM station using the primary remote control.

- 1 Press PTY SEARCH while listening to an FM station.
- 2 Press the PTY-or PTY+ until the PTY code you want appears on the display.
 - The display gives you the PTY codes described to the right.
- 3 Press PTY SEARCH again, while the PTY code selected in the previous step is still on the display.
 - The center unit searches 15 preset FM stations, stops when it finds the one you have selected, and tunes in that station.

Display	Program Type
NEWS	• News including an announced opinion and report
AFFAIRS	• Several matters including a current incident, documentary, discussion and analysis.
INFO	• Information including weights and measures, returns and forecast, matters interesting the customer, medical information, etc.
SPORT	• Sports
EDUCATE	• Education
DRAMA	• Drama-Radio serial, etc.
CULTURE	• Culture-National or local culture including the religious problem, social science, language, theater, etc.
SCIENCE	• Natural science and technology
VARIED	• Others-Speech, amusing program (quiz, game), interview, comedy and satirical play, etc.
POP M	• Pop music
ROCK M	• Rock music
M.O.R.M	• Current contemporary music considered to be "easy listening."
LIGHT M	• Light classical music- Classical music and instrumental and chorus music
CLASSICS	• Heavy classical music-Orchestra music, symphony, chamber music and opera
OTHER M	• Other music - Jazz, R&B country music
WEATHER	• Weather
FINANCE	• Finance
CHILDREN	• Children's programmes
SOCIAL A	• Social affairs
RELIGION	• Religion
PHONE IN	• Phone in
TRAVEL	• Travel
LEISURE	• Leisure
JAZZ	• Jazz Music
COUNTRY	• Country Music
NATION M	• National Music
OLDIES	• Oldies Music
FOLK M	• Folk Music
DOCUMENT	• Documentary

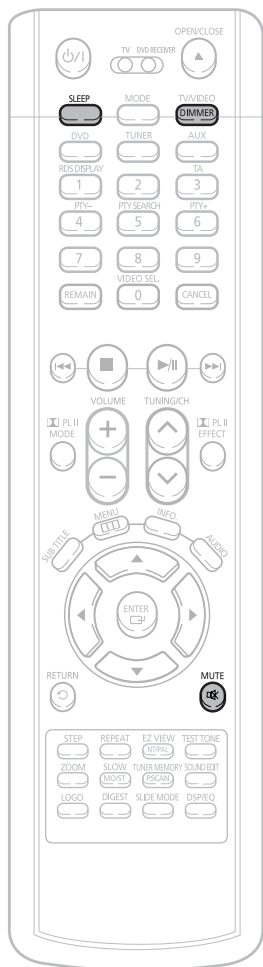

Sleep Timer Function

You can set the time that the DVD player will shut itself off.

Press **SLEEP** button.

- "SLEEP" will be displayed. Each time the button is pressed the preset time changes as follows: 10 → 20 → 30 → 60 → 90 → 120 → 150 → OFF.

- To confirm the sleep timer setting, press **SLEEP** button.
- The remaining time before the DVD player will shut itself off is displayed.
- Pressing the button again changes the sleep time from what you have set earlier.

To cancel the sleep timer, press **SLEEP** button until OFF appears on the display.

Adjusting Display Brightness

You can adjust the brightness of the display on the main unit so it won't interfere with your movie viewing.

Press **DIMMER** button.

- Each time the button is press, the brightness changes as follows: DARK → BRIGHT.

Mute Function

This is useful when answering a doorbell or telephone call.

Press **MUTE** button.

- 'MUTE' flash in the display.
- To switch the sound back on (at the same volume as before), press **MUTE** again or the **VOLUME** buttons.

Using Headphones

Use headphones (not supplied) for private listening pleasure.

Connect the headphones to the PHONES jack for private listening.

Caution

- To prevent hearing damage, do not increase the volume excessively when using headphones.

Operating a TV with the Remote Control

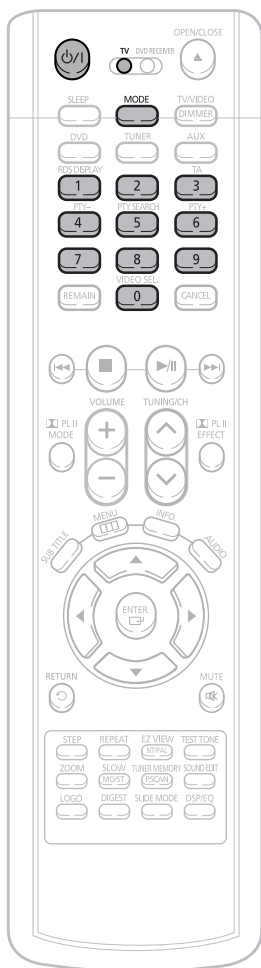

When operating a TV with the remote control

1 Press the **MODE** button to make the TV indicator on the remote control flash.



2 Press **POWER** button to turn on the TV.

3 Point the remote control toward the TV.

4 While holding down **POWER**, enter the code corresponding to your brand of TV.

- If the code matches the TV's code, the TV will be turned off.
- If there is more than one code listed for your TV in the table, enter one at a time to determine which code works.

Example: For a Samsung TV

While holding down **POWER**, use the number buttons to enter 00, 01, 02, 03, 04, and 05.

5 Point the remote control toward the TV and press **POWER**. If the TV turns off or on, the setting is complete.

- You can use the TV POWER, VOLUME, CHANNEL, and Numeric buttons (0-9).

Note

- The remote control may not work on some brands of TVs. Also some operations may not be possible depending on your brand of TV.
- If you do not set the remote control with the code for your brand of TV, the remote control will work on a Samsung TV by default.



TV Brand Code List

No.	Brand	Code	No.	Brand	Code
1	SAMSUNG	00(Initial Value), 01, 02, 03, 04, 05, 73	30	BRANDT	41
2	ANAM	06-11, 59	31	FERGUSON	41
3	DAEWOO	12-18, 20, 21	32	PIONEER	41, 48, 74
4	LG	05, 20, 21, 22, 53	33	TELEAVA	41
5	HITACHI	23, 40, 41, 49	34	FINLUX	05, 42, 47
6	JVC	24, 55	35	FISHER	31
7	SHARP	27, 33, 34, 35, 54	36	AKAI	31
8	SONY	27, 36	37	YOKO	05
9	TOSHIBA	27, 37, 42, 43, 44, 46	38	PHONOLA	05, 45, 47
10	SANYO	27, 30, 31, 32	39	RADIOLA	05, 45
11	MITSUBISHI	05, 27, 28	40	SCHNEIDER	05
12	MATSUSHITA	09, 26	41	NEWSAN	58
13	TELEFUNKEN	41, 49, 51, 57	42	CONTINENTAL EDISON	49
14	RCA	29, 61	43	SALORA	48
15	PANASONIC	07, 09, 26, 48, 49, 50	44	SELECO	48
16	SABA	40, 41, 47, 48, 49	45	NOKIA	48
17	PHILIPS	05, 45, 47, 64, 65, 66, 67, 68, 69	46	REX	48
18	GRUNDIG	39, 42, 46, 70, 71, 72	47	MIVAR	46
19	ZENITH	38	48	IMPERIAL	46
20	MIVAL	52	49	CGE	46
21	NOBLEX	56	50	BANG & OLUFSEN	47
22	EMERSON	19	51	BRIONVEGA	47
23	MAGNAVOX	25	52	FORMENTI	47
24	LOEWE	05, 60	53	METZ	47
25	THOMSON	40, 41, 49, 62, 63	54	WEGA	47
26	NORDMENDE	40, 41, 49	55	RADIOMARELLI	47
27	LOEWE OPTA	36, 47, 05	56	SINGER	47
28	BLAUPUNKT	39	57	SINUDYNE	47
29	SIEMENS	39			

Before Calling for Service

Refer to the chart below when this unit does not function properly. If the problem you are experiencing is not listed below or if the instruction below does not help, turn off the unit, disconnect the power cord, and contact the nearest authorized dealer or Samsung Electronics Service Center.

Symptom	Check/Remedy
Disc tray does not open.	<ul style="list-style-type: none"> • Is the power cord plugged securely into the outlet? • Turn off the power and then turn it back on.
Playback does not start.	<ul style="list-style-type: none"> • Check the region number of the DVD. DVD discs purchased from abroad may not be playable. • CD-ROMs and DVD-ROMs cannot be played on this DVD player. • Make sure that the rating level is correct.
Playback does not start immediately when the Play/Pause button is pressed.	<ul style="list-style-type: none"> • Are you using a deformed disc or a disc with scratches on the surface? • Wipe the disc clean.
Sound is not produced.	<ul style="list-style-type: none"> • No sound is heard during fast playback, slow playback, and step motion playback. • Are the speakers connected properly? Is the speaker setup correctly customized? • Is the disc severely damaged?
Sound can be heard only from a few speakers and not all six.	<ul style="list-style-type: none"> • When listening to a CD or radio, sound is output to the front speakers (L/R) only. Select "PRO LOGIC II" by pressing  PL II (Dolby Pro Logic II) on the remote control to use all six speakers. • Make sure that the DVD disc is 5.1-CH compatible. • If you set C, SL, and SR to NONE in the speaker mode in the audio setup of the setup screen, no sound is heard from the center speaker and the front left and right speakers. Set C, SL, and SR to SMALL.
Picture does not appear, sound is not produced, or the disc tray opens 2 to 5 seconds later.	<ul style="list-style-type: none"> • Was the DVD player suddenly moved from a cold place to a warm one? When condensation forms inside the player, remove the disc and let the player stand for 1 or 2 hours with the power on. (You can use the player again after condensation disappears.)
Dolby Digital 5.1 CH Surround Sound is not produced.	<ul style="list-style-type: none"> • Is there "Dolby Digital 5.1 CH" mark on the disc? Dolby Digital 5.1 CH Surround Sound is produced only if the disc is recorded with 5.1 channel sound. • Is the audio language correctly set to DOLBY DIGITAL 5.1-CH in the information display?

Symptom	Check/Remedy
<ul style="list-style-type: none"> • Disc is rotating but no picture is produced. • Picture quality is poor and picture is shaking. 	<ul style="list-style-type: none"> • Is the TV power on? • Are the video cables connected properly? • Is the disc dirty or damaged? • A poorly manufactured disc may not be playable.
The remote control does not work.	<ul style="list-style-type: none"> • Is the remote control being operated within its operation range of angle and distance? • Are the batteries exhausted?
Audio language and subtitles do not work.	<ul style="list-style-type: none"> • Audio language and subtitles will not work for DVDs not containing them. And depending on the disc, they may work differently.
Menu screen does not appear even when the menu function is selected.	<ul style="list-style-type: none"> • Are you using a disc that does not contain menus?
Aspect ratio cannot be changed.	<ul style="list-style-type: none"> • You can play 16:9 DVDs in 16:9 WIDE mode, 4:3 LETTER BOX mode, or 4:3 PAN SCAN mode, but 4:3 DVDs can be seen in 4:3 ratio only. Refer to the DVD disc jacket and then select the appropriate function.
Can't receive radio broadcast.	<ul style="list-style-type: none"> • Is the antenna connected properly? • If the antenna's input signal is weak, install an external FM antenna in an area with good reception.
<ul style="list-style-type: none"> • The main unit is not working. (Example: The power goes out or strange noise is heard.) • The DVD player is not working normally. 	<ul style="list-style-type: none"> • Turn off the power and hold the  button on the main unit for longer than 5 seconds. <p>Using the RESET function will erase all stored settings. Do not use this unless necessary.</p>
The password for rating level has been forgotten.	<ul style="list-style-type: none"> • While "NO DISC" message appears on the display of main unit, hold the main unit's  button for longer than 5 seconds. "INITIALIZE" appears on the display and all settings will return to the default values. • Press the POWER button. <p>Using the RESET function will erase all stored settings. Do not use this unless necessary.</p>

Cautions on Handling and Storing Discs

Small scratches on the disc may reduce sound and picture quality or cause skipping. Be especially careful not to scratch discs when handling them.

● Handling discs

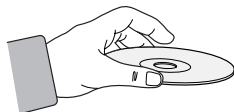

Do not touch the playback side of the disc. Hold the disc by the edges so that fingerprints will not get on the surface.
Do not stick paper or tape on the disc.

● Disc Storage

Do not keep in direct sunlight

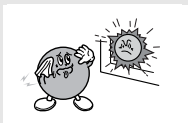

Keep in a cool ventilated area

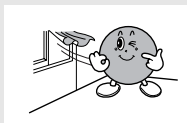

Keep in a clean Protection jacket. Store vertically.



Caution

- Do not allow the discs to become contaminated with dirt.
- Do not load cracked or scratched discs.

● Handling and Storing Discs



When you get fingerprints or dirt on the disc, clean it with a mild detergent diluted in water and wipe with a soft cloth.

- When cleaning, wipe gently from the inside to the outside of the disc.

Note

- Condensation may form if warm air comes into contact with cold parts inside the player. When condensation forms inside the player, the player may not operate correctly. If this occurs, remove the disc and let the player stand for 1 or 2 hours with the power on.

Language Code List

Enter the appropriate code number for the initial settings "Disc Audio", "Disc Subtitle" and/or "Disc Menu" (See page 39).

Code	Language	Code	Language	Code	Language	Code	Language
1027	Afar	1181	Frisian	1334	Latvian, Lettish	1506	Slovenian
1028	Abkhazian	1183	Irish	1345	Malagasy	1507	Samoan
1032	Afrikaans	1186	Scots Gaelic	1347	Maori	1508	Shona
1039	Amharic	1194	Galician	1349	Macedonian	1509	Somali
1044	Arabic	1196	Guarani	1350	Malayalam	1511	Albanian
1045	Assamese	1203	Gujarati	1352	Mongolian	1512	Serbian
1051	Aymara	1209	Hausa	1353	Moldavian	1513	Siswati
1052	Azerbaijani	1217	Hindi	1356	Marathi	1514	Sesotho
1053	Bashkir	1226	Croatian	1357	Malay	1515	Sundanese
1057	Byelorussian	1229	Hungarian	1358	Maltese	1516	Swedish
1059	Bulgarian	1233	Armenian	1363	Burmese	1517	Swahili
1060	Bihari	1235	Interlingua	1365	Nauru	1521	Tamil
1069	Bislama	1239	Interlingue	1369	Nepali	1525	Tegulu
1066	Bengali; Bangla	1245	Inupiak	1376	Dutch	1527	Tajik
1067	Tibetan	1248	Indonesian	1379	Norwegian	1528	Thai
1070	Breton	1253	Icelandic	1393	Occitan	1529	Tigrinya
1079	Catalan	1254	Italian	1403	(Afan) Oromo	1531	Turkmen
1093	Corsican	1257	Hebrew	1408	Oriya	1532	Tagalog
1097	Czech	1261	Japanese	1417	Punjabi	1534	Setswana
1103	Welsh	1269	Yiddish	1428	Polish	1535	Tonga
1105	Danish	1283	Javanese	1435	Pashto, Pushto	1538	Turkish
1109	German	1287	Georgian	1436	Portuguese	1539	Tsonga
1130	Bhutani	1297	Kazakh	1463	Quechua	1540	Tatar
1142	Greek	1298	Greenlandic	1481	Rhaeto-Romance	1543	Twi
1144	English	1299	Cambodian	1482	Kirundi	1557	Ukrainian
1145	Esperanto	1300	Kannada	1483	Romanian	1564	Urdu
1149	Spanish	1301	Korean	1489	Russian	1572	Uzbek
1150	Estonian	1305	Kashmiri	1491	Kinyarwanda	1581	Vietnamese
1151	Basque	1307	Kurdish	1495	Sanskrit	1587	Volapuk
1157	Persian	1311	Kirghiz	1498	Sindhi	1613	Wolof
1165	Finnish	1313	Latin	1501	Sangro	1632	Xhosa
1166	Fiji	1326	Lingala	1502	Serbo-Croatian	1665	Yoruba
1171	Faeroese	1327	Laothian	1503	Singhalese	1684	Chinese
1174	French	1332	Lithuanian	1505	Slovak	1697	Zulu

Specifications

GENERAL	Power Consumption	80W
	Weight	3.5Kg
	Dimensions (W x H x D)	430 x 60 x 340 mm
	Operating Temperature Range	+5°C~+35°C
	Operating Humidity Range	10%~75%
TUNER	Usable Sensitivity	10dB
	S/N Ratio	60dB
	Distortion	0.5%
AM TUNER	Usable Sensitivity	55dB
	S/N Ratio	40dB
	Distortion	2%
VIDEO OUTPUT	Composite Video	1.0Vp-p(75Ω load)
	Scart Jack	Compositive Video : 1.0Vp-p(75Ω load)
		RGB Signal : 0.714Vp-p(75Ω load)
	Component Video	Y:1.0Vp-p(75Ω load)
		Pr:0.70Vp-p(75Ω load) Pb:0.70Vp-p(75Ω load)
AMPLIFIER	Front speaker output	75W(4Ω)/CH
	Center speaker output	80W(4Ω)
	Rear speaker output	75W(4Ω)/CH
	Subwoofer speaker output	120W(3Ω)
	Frequency range	20Hz~20kHz
	S/N Ratio	75dB
	Channel separation	70dB
	Input sensitivity	(AUX)500mV

HT-UP30

SPEAKER	Speaker system (PS-UP30)	5.1ch speaker system		
		Front/Rear speaker	Center speaker	Subwoofer speaker
	Impedance	4Ω x 4	4Ω	3Ω
	Frequency range	150Hz~20kHz	150Hz~20kHz	30Hz~150Hz
	Output sound pressure level	85dB/W/M	85dB/W/M	86dB/W/M
	Rated input	75W	80W	120W
	Maximum input	150W	160W	240W
	Dimensions (W x H x D)	85.5 x 156 x 98 mm	300 x 85.5 x 98 mm	160 x 320 x 400 mm
	Weights	0.5 Kg / 0.35 Kg	0.65 Kg	5.2 Kg

HT-TP33

SPEAKER	Speaker system (PS-TP33)	5.1ch speaker system		
		Front/Rear speaker	Center speaker	Subwoofer speaker
	Impedance	4Ω x 4	4Ω	3Ω
	Frequency range	145Hz~20kHz	145Hz~20kHz	35Hz~140Hz
	Output sound pressure level	85dB/W/M	85dB/W/M	86dB/W/M
	Rated input	75W	80W	120W
	Maximum input	150W	160W	240W
	Dimensions (W x H x D)	85 x 1050 x 90 mm	295 x 90 x 94 mm	180 x 320 x 400 mm
	Weights	3.1 Kg / 2.95 Kg	0.7 Kg	5.2 Kg