



SLIM DIGITAL HOME THEATER SYSTEM HT-P1200

THIS APPLIANCE IS MANUFACTURED BY:



Instruction Manual

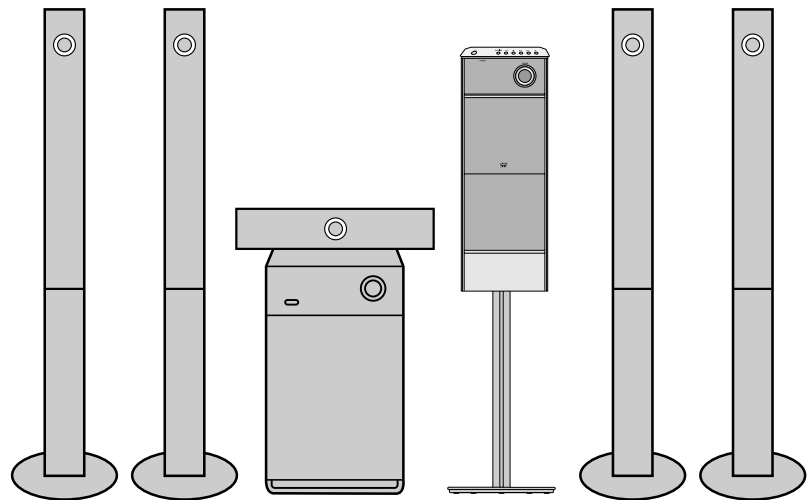

Safety Warnings

CLASS 1 LASER PRODUCT
 KLASSE 1 LASER PRODUKT
 LUOKAN 1 LASER LAITE
 KLASSE 1 LASER APPARAT
 PRODUCTO LASER CLASE 1

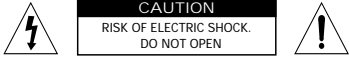

CAUTION
 RISK OF ELECTRIC SHOCK.
 DO NOT OPEN

CAUTION:
 TO REDUCE THE RISK OF ELECTRIC SHOCK, DO NOT REMOVE REAR COVER. NO USER SERVICEABLE PARTS INSIDE. REFER SERVICING TO QUALIFIED SERVICE PERSONNEL.

CLASS 1 LASER PRODUCT
 This Compact Disc player is classified as a CLASS 1 LASER product.

Use of controls, adjustments or performance of procedures other than those specified herein may result in hazardous radiation exposure.

CAUTION-INVISIBLE LASER RADIATION WHEN OPEN AND INTERLOCKS DEFEATED, AVOID EXPOSURE TO BEAM.



This symbol indicates that dangerous voltage which can cause electric shock is present inside this unit.



This symbol alerts you to important operating and maintenance instructions accompanying the unit.

WARNING: To reduce the risk of fire or electric shock, do not expose this appliance to rain or moisture.

CAUTION: TO PREVENT ELECTRIC SHOCK, MATCH WIDE BLADE OF PLUG TO WIDE SLOT, FULLY INSERT.

Precautions

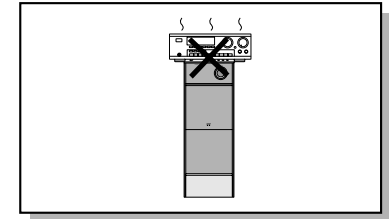
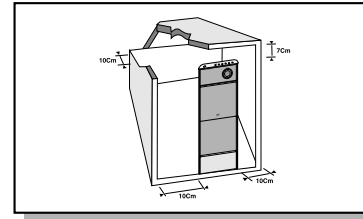

Ensure that the AC power supply in your house complies with the identification sticker located on the back of your player. Install your player horizontally, on a suitable base (furniture), with enough space around it for ventilation (3–4inches). Make sure the ventilation slots are not covered. Do not stack anything on top of the player. Do not place the player on amplifiers or other equipment which may become hot. Before moving the player, ensure the disc tray is empty. This player is designed for continuous use. Switching off the DVD player to the stand-by mode does not disconnect the electrical supply. In order to disconnect the player completely from the power supply, remove the main plug from the wall outlet, especially when left unused for a long period of time.

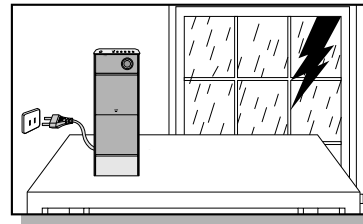

During thunderstorms, disconnect AC main plug from the wall outlet.
 Voltage peaks due to lightning could damage the unit.

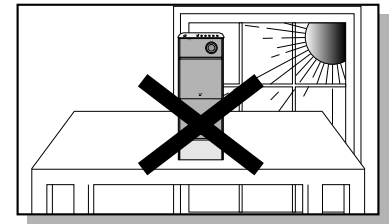

Do not expose the unit to direct sunlight or other heat sources.
 This could lead to overheating and malfunction of the unit.

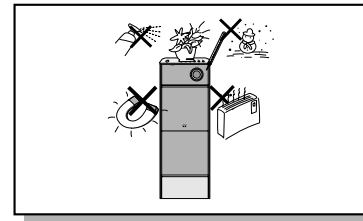

Protect the player from moisture (i.e. vases), and excess heat (e.g. fireplace) or equipment creating strong magnetic or electric fields (i.e. speakers...). Disconnect the power cable from the AC supply if the player malfunctions. Your player is not intended for industrial use. Use of this product is for personal use only.

Condensation may occur if your player or disc has been stored in cold temperatures.

If transporting the player during the winter, wait approximately 2 hours until the unit has reached room temperature before using.

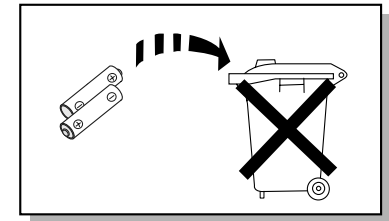

The batteries used with this product contain chemicals that are harmful to the environment.
 Do not dispose of batteries in the general household trash.

Features

● Multi-Disc Playback & FM Tuner

The HT-P1200 combines the convenience of multi-disc playback capability, including DVD-AUDIO, DVD-VIDEO, VCD, SACD, CD, MP3-CD, WMA-CD, DivX, CD-R/RW, and DVD-R/RW, with a sophisticated FM tuner, all in a single player.

● DVD-Audio compatible

Experience the super high-quality audio performance of DVD-Audio. The on-board 24-bit/192kHz DAC enables this player to deliver exceptional sound quality in terms of dynamic range, low-level resolution and high-frequency detail.

● USB Host Play

You can enjoy media files such as pictures, movies and tunes saved in an MP3 player, digital camera, or USB memory by connecting the storage device to the USB port of the home theater.

● SACD Play

You can listen to high quality multi-channel sound that exceeds regular CD playback.

● SDSM-EX (360 Degree Surround Sound)

SDSM-EX is a proprietary audio technology that provides 360-degree surround technology.

● Logo Sound

When you turn on the power, a 'sound logo' will be heard.

● TV Screen Saver Function

The HT-P1200 automatically brightens and darkens the brightness of the TV screen after 3 minutes in the stop mode.

The HT-P1200 automatically switches itself into the power saving mode after 20 minutes in the screen saver mode.

● AV SYNC Function

Video may lag behind the audio if the unit is connected to a digital TV. To compensate for this, you can adjust the audio delay time to sync up with the video.

● HDMI

HDMI transmits DVD video and audio signals simultaneously, and provides a clearer picture.



Contents





● PREPARATION	
Safety Warnings.....	1
Precautions.....	2
Features.....	3
Notes on Discs.....	5
Description.....	7
● CONNECTIONS	
Installing the DVD player.....	11
Installing Speakers.....	13
Connecting the Speakers.....	15
Connecting the Video Out to TV.....	18
HDMI Function.....	19
Connecting External Components.....	21
Connecting the FM Antenna.....	22
● OPERATION	
Before Using Your Home Theater.....	23
Disc Playback.....	25
SACD (Super Audio CD) Playback.....	27
MP3-CD Playback.....	28
JPEG File Playback.....	29
Checking the Remaining Time.....	30
DivX Playback.....	31
Playing Media Files using the USB HOST feature.....	33
Displaying Disc Information.....	35
Fast/Slow Playback.....	36
Skipping Scenes/Songs.....	36
Repeat Playback.....	37
A-B Repeat Playback.....	38
Step Function.....	39
Angle Function.....	39
Zoom (Screen Enlarge) Function.....	40
EZ VIEW Function.....	40
Bonus Group / Navigating Pages.....	41
Selecting Audio/Subtitle Language.....	42
Moving Directly to a Scene/Song.....	43
Using Disc Menu.....	44
Using the Title Menu.....	44
● SETUP	
Setting the Language.....	45
Setting TV Screen type.....	47
Setting Parental Controls (Rating Level).....	49
Setting the Password.....	50
Setting the Wallpaper.....	51
DVD Audio Disc Playback Mode.....	53
SACD Playback Mode.....	54
Setting the Speaker Mode.....	55
Setting the Test Tone.....	56
Setting the Delay Time.....	57
Setting the Audio Quality.....	59
Setting the DRC (Dynamic Range Compression).....	61
AV SYNC Setup.....	62
Dolby Pro Logic II Mode.....	63
Dolby Pro Logic II Effect.....	64
Auto Sound Calibration Setup.....	65
Live Surround Mode.....	67
● RADIO OPERATION	
Listening to Radio.....	69
Presetting Stations.....	70
● MISCELLANEOUS	
Convenient Functions.....	71
Operating a TV with the Remote Control.....	73
Before Calling for Service.....	75
Cautions on Handling and Storing Discs.....	77
Language Code List.....	78
USB Host Feature Supported Products.....	79
Specifications.....	81
Memo.....	82

DVD (Digital Versatile Disc) offers fantastic audio and video, thanks to Dolby Digital surround sound and MPEG-2 video compression technology. Now you can enjoy these realistic effects in the home, as if you were in a movie theater or concert hall.

DVD players and the discs are coded by region. These regional codes must match in order for the disc to play. If the codes do not match, the disc will not play.

The Region Number for this player is given on the rear panel of the player. (Your DVD player will only play DVDs that are labeled with identical region codes.)

Playable Discs

Disc Type	Mark (Logo)	Recorded Signals	Disc Size	Max. Playing Time
DVD-AUDIO DVD-VIDEO		Audio + Video	12cm	Approx. 240 min. (single-sided) Approx. 480 min. (double-sided)
			8cm	Approx. 80 min. (single-sided) Approx. 160 min. (double-sided)
VIDEO-CD		Audio + Video	12cm	74 min.
			8cm	20 min.
AUDIO-CD		Audio	12cm	74 min.
			8cm	20 min.
DivX		MPEG4 MP3	12cm	74 min.
			8cm	20 min.
Super Audio CD		Audio	12cm	74 min.

Do not use the following types of disc!

- LD, CD-G, CD-I, CD-ROM and DVD-ROM discs cannot be played on this player. If such discs are played, a **"WRONG DISC FORMAT"** message appears on the TV screen.
- DVD discs purchased abroad may not play on this player. If such discs are played, a **"WRONG REGION CODE"** message appears on the TV screen.

Copy Protection

- Many DVD discs are encoded with copy protection. Because of this, you should only connect your DVD player directly to your TV, not to a VCR. Connecting to a VCR results in a distorted picture from copy-protected DVD discs.
- This product incorporates copyright protection technology that is protected by methods claims of certain U.S. patents and other intellectual property rights owned by Macrovision Corporation and other rights owners. Use of this copyright protection technology must be authorized by Macrovision Corporation, and is intended for home and other limited viewing uses only unless otherwise authorized by Macrovision Corporation. Reverse engineering or disassembly is prohibited.

Disc Recording Format

CD-R Discs

- Some CD-R discs may not be playable depending on the disc recording device (CD-Recorder or PC) and the condition of the disc.
- Use a 650MB/74 minute CD-R disc. Do not use CD-R disk over 700MB/80 minute as much as possible since it may not be played back.
- Some CD-RW (Rewritable) media, may not be playable.
- Only CD-Rs that are properly "closed" can be fully played. If the session is closed but the disc is left open, you may not be able to fully play the disc.

CD-R MP3 Discs

- Only CD-R discs with MP3 files in ISO 9660 or Joliet format can be played.
- MP3 file names should be 8 characters or less in length and contain no blank spaces or special characters (. / = +).
- Use discs recorded with a compression/decompression data rate greater than 128Kbps.
- Only files with the ".mp3" and ".MP3" extensions can be played.
- Only a consecutively written Multisession disc can be played. If there is a blank segment in the Multisession disc, the disc can be played only up to the blank segment.
- If the disc is not closed, it will take longer to begin playback and not all of the recorded files may be played.
- For files encoded in Variable Bit Rate (VBR) format, i.e. files encoded in both low bit rate and high bit rate (e.g., 32Kbps ~ 320Kbps), the sound may skip during playback.
- A maximum of 500 tracks can be played per CD.
- A maximum of 300 folders can be played per CD.

CD-R JPEG Discs

- Only files with the ".jpeg" and ".JPEG" extensions can be played.
- If the disc is not closed, it will take longer to start playing and not all of the recorded files may be played.
- Only CD-R discs with JPEG files in ISO 9660 or Joliet format can be played.
- JPEG file names should be 8 characters or less in length and contain no blank spaces or special characters (. / = +).
- Only a consecutively written multisession disc can be played. If there is a blank segment in the multisession disc, the disc can be played only up to the blank segment.
- A maximum of 9,999 images can be stored on a single CD.
- When playing a Kodak/Fuji Picture CD, only the JPEG files in the picture folder can be played.
- Picture discs other than Kodak/Fuji Picture CDs may take longer to start playing or may not play at all.

Description

—Front Panel—

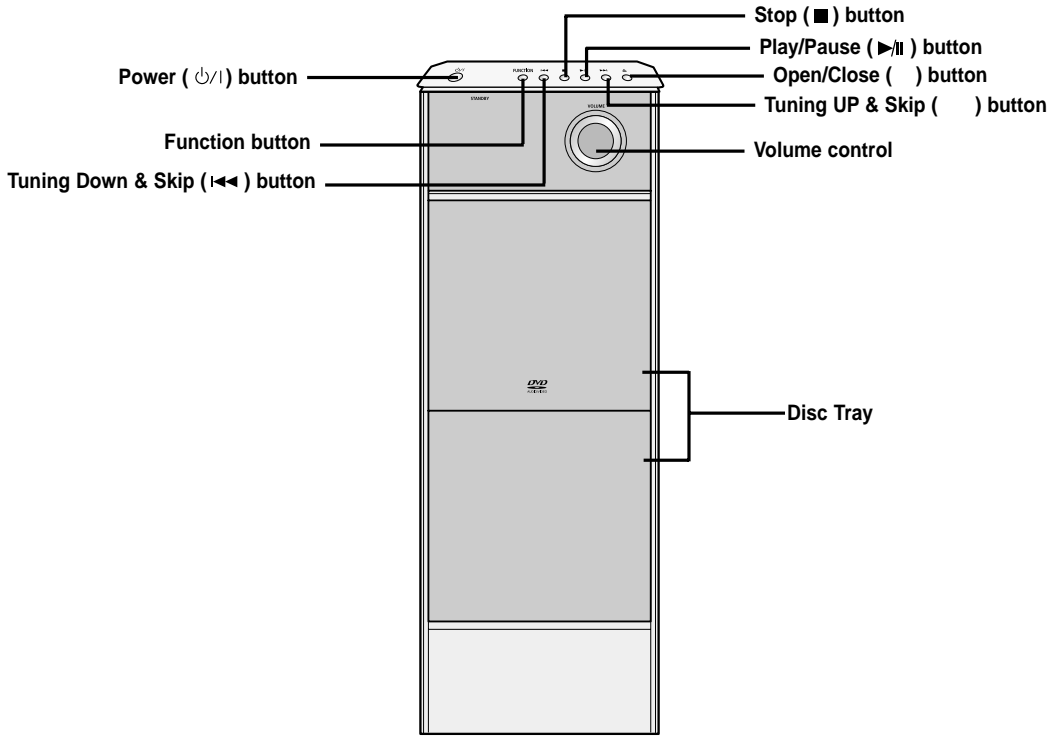

Display

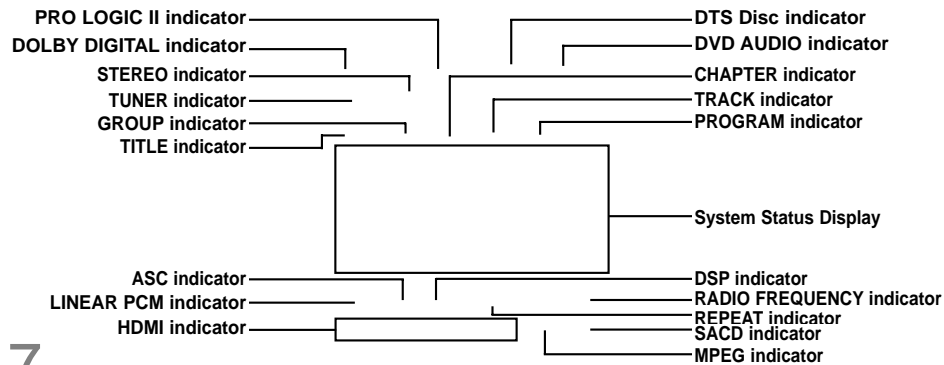

—Rear Panel—

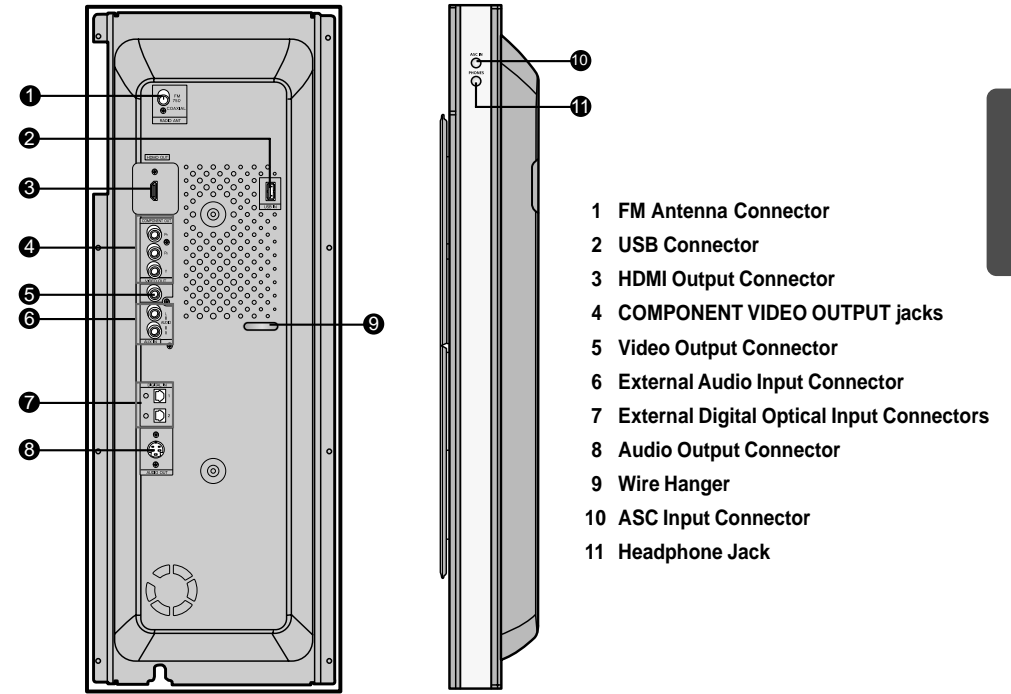

Accessories

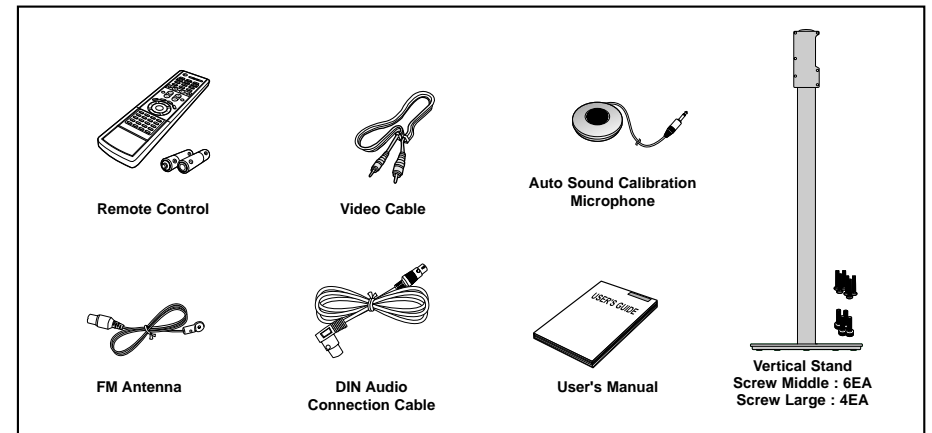

Description

—Remote Control—

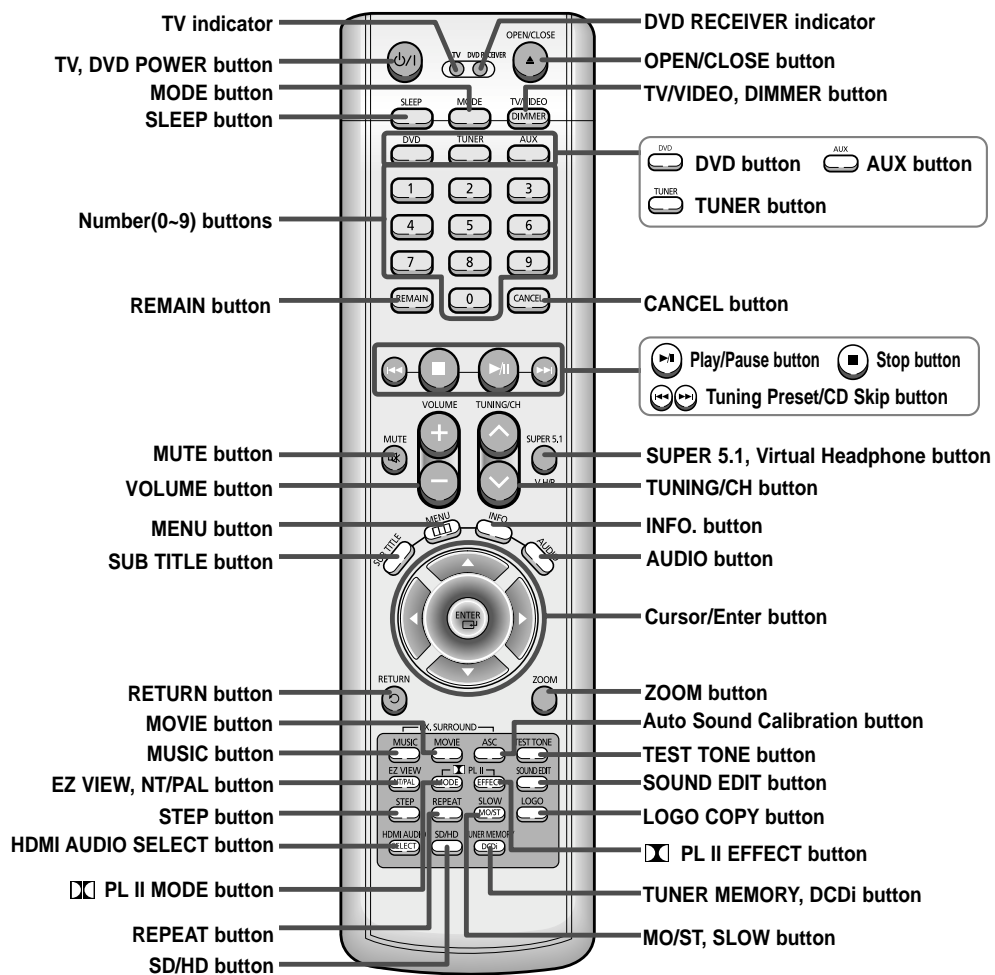

Insert Remote Batteries

- 1** Remove the battery cover on the back of the remote by pressing down and sliding the cover in the direction of the arrow.
- 2** Insert two 1.5V AAA batteries, paying attention to the correct polarities (+ and -).
- 3** Replace the battery cover.

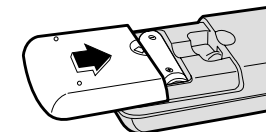
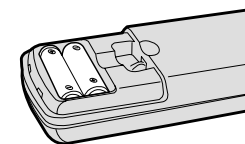
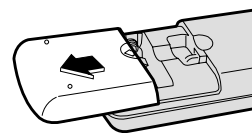

Caution

Follow these precautions to avoid leaking or cracking cells:

- Place batteries in the remote control so they match the polarity:(+) to (+)and (-)to (-).
- Use the correct type of batteries.Batteries that look similar may differ in voltage.
- Always replace both batteries at the same time.
- Do not expose batteries to heat or flame.

Range of Operation of the Remote Control

The remote control can be used up to approximately 23 feet/7 meters in a straight line. It can also be operated at a horizontal angle of up to 30° from the remote control sensor.

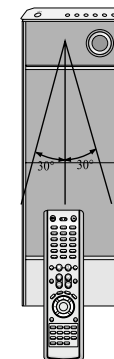

Installing the DVD player

- 1 Combine the round board and the stand with the screws (4).

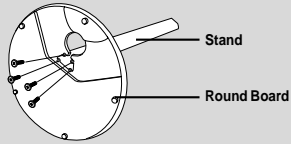

- 2 Insert two screws in the top holes, but only screw them in 1/2 way.

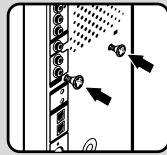

- 3 Align the stand with the two screws.

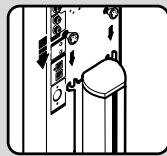

- 4 Fully tighten the screws to secure the stand to the DVD player.

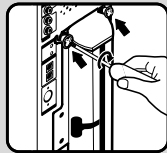

- 5 Insert the remaining four screws & tighten.

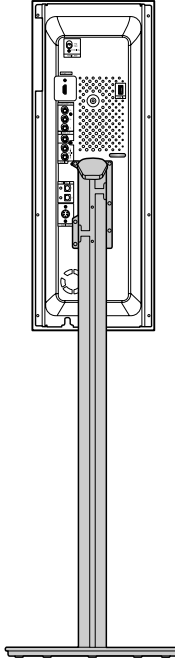
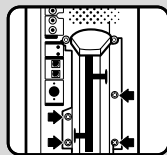

Tidying Cables Up

- 1 Push the cables connected to the HDMI OUT, Component OUT, Video OUT ports into the groove shown in figure 1 using the Wire Hanger.

- 2 Push the cables connected to the Audio IN, Anynet IN/OUT, Optical Digital Audio IN and Audio OUT ports into the groove shown in figure 2.

- 3 Open the holder cover of the round board on the bottom of the stand and pass the cables through the holder.

- 4 Squeeze the cables into the groove on the holder of the round board.

- 5 Close the holder cover.

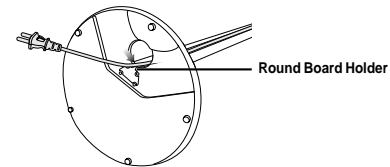
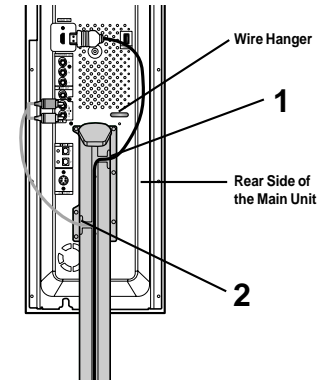

Caution • Keep the main unit and speakers out of the reach of children as the equipment could tip over.

Installing Speakers

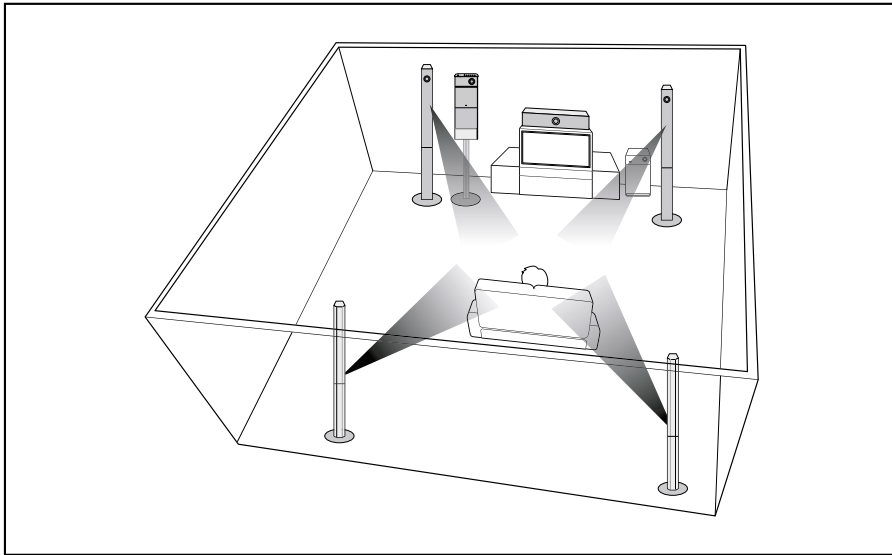

Assembling the Speakers

- 1 Set the front speaker on the front stand.
- 2 Connect the front speaker cable to the rear side of the front stand.
- 3 Fix the speaker and the stand with the screws.

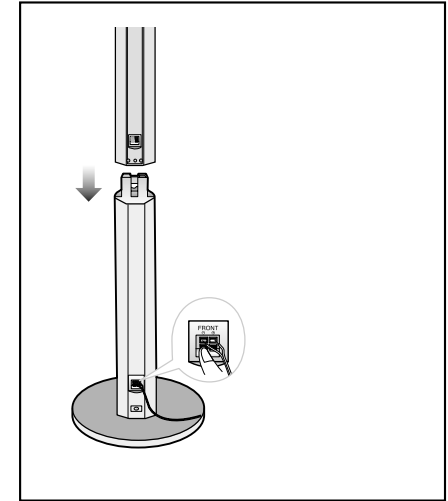

Speaker Packages

Please confirm that all the following contents are included in the package.

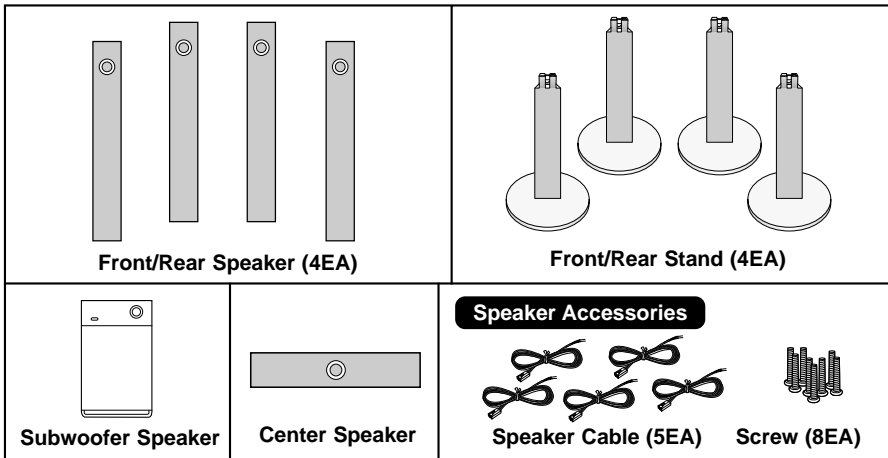

Note

- Connect the speaker cable to the connection port of either the front speaker or the front stand. Both of the connection ports will work.
- If you have combined the front speaker and the stand, connecting the speaker cable to the connection port on the rear side of the front stand is recommended.

To mount the speakers on the wall

Drive screws (2) into the wall for each speaker and then hook the front and rear speakers over them.

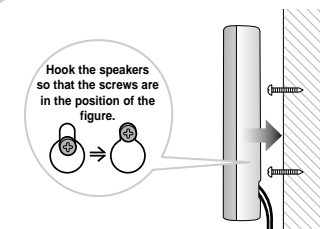

Connecting the Speakers

Before moving or installing the product, be sure to turn off the power and disconnect the power cord.

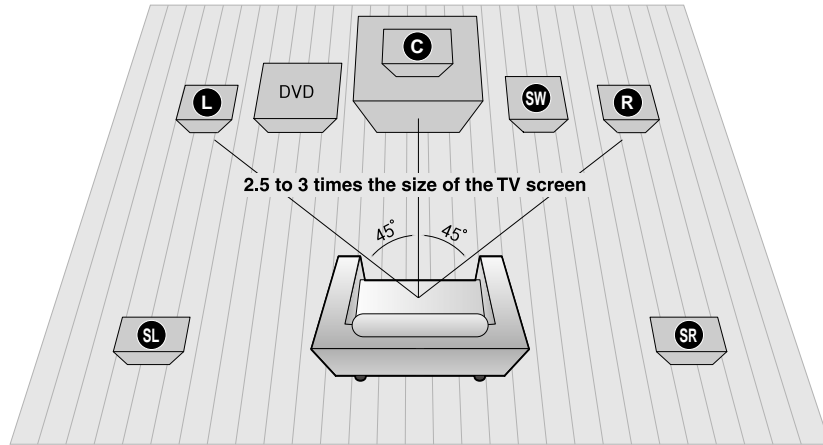

Position of the DVD Player

- Place it on a stand or cabinet shelf, or under the TV stand.

Selecting the Listening Position

The listening position should be located about 2.5 to 3 times the distance of the TV's screen size away from the TV. Example: For 32" TVs 2-2.4m (6-8feet)
For 55" TVs 3.5-4m (11-13feet)

Front Speakers **L R**

- Place these speakers in front of your listening position, facing inwards (about 45°) toward you.
- Place the speakers so that their tweeters will be at the same height as your ear.
- Align the front face of the front speakers with the front face of the center speaker or place them slightly in front of the center speakers.

Rear Speakers **SL SR**

- Place these speakers behind your listening position.
- If there isn't enough room, place these speakers so they face each other.
- Place them about 60 to 90cm (2 to 3feet) above your ear, facing slightly downward.

* Unlike the front and center speakers, the rear speakers are used to handle mainly sound effects and sound will not come from them all the time.

Center Speaker **C**

- It is best to install it at the same height as the front speakers.
- You can also install it directly over or under the TV.

Subwoofer **SW**

- The position of the subwoofer is not so critical. Place it anywhere you like.

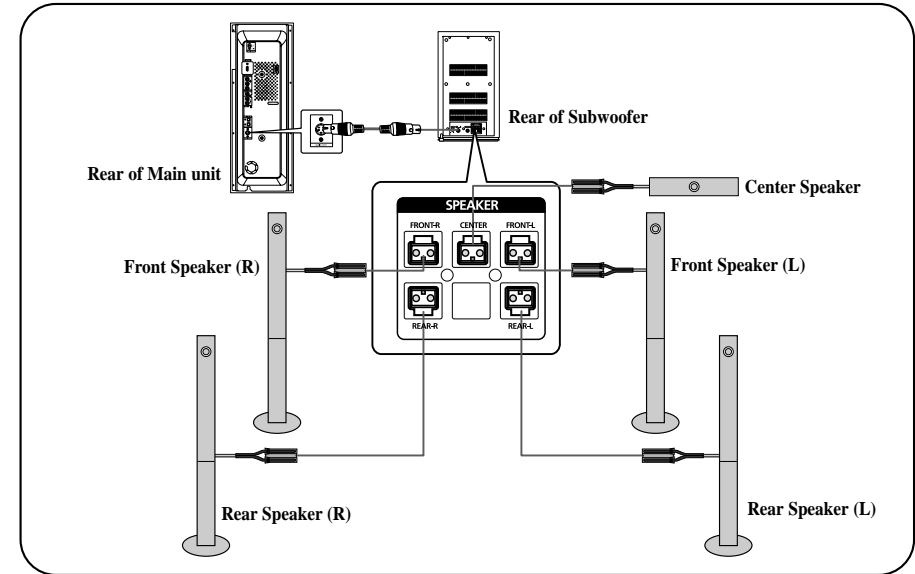

Connecting the Speakers

- Press down the terminal tab on the back of the speaker.
- Insert the black wire into the black terminal (-) and the gray wire into the gray (+) terminal, and then release the tab.
- Connect the correct color speaker cable to the same color speaker output terminal on the rear of the subwoofer, according to the polarity markings (+/-).

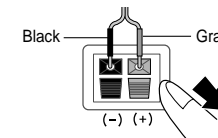
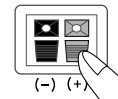

Example: Connect the green center speaker cable to the green center speaker output terminal on the rear of the subwoofer according to the polarity markings (+/-).

Caution

- Do not let children play with or near the speakers. They could get hurt if a speaker falls.
- When connecting the speaker wires to the speakers, make sure that the polarity (+/-) is correct.

Note

- If you place a speaker near your TV set, screen color may be distorted because of the magnetic field generated by the speaker. If this occurs, place the speaker away from your TV set.

Connecting the Speakers (con't)

Connecting the Main Unit and Sub Woofer

- 1 Connect the DIN Audio Out of the main unit and the DIN Audio In of the sub woofer with the DIN audio cable.
- 2 Press the power button of the sub woofer to turn it on.

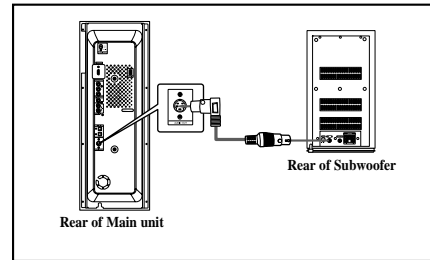

Sub Woofer Functions

Subwoofer: With the built-in, dedicated 150W amplifier, the subwoofer generates rich bass sounds.

Crossover: The Crossover sets the cutoff frequency for the subwoofer. Set the Crossover control for the best bass response in your room.

- You can adjust the bass or treble output from the front, rear, center speakers and the subwoofer.
- To the left increases the bass and to the right, treble.

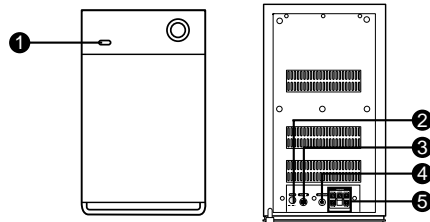

- 1 Power LED
- 2 Power button
- 3 External Audio Input Connector
- 4 Crossover Controller
- 5 Speaker Output Terminals

Connecting the Video Out to TV

Choose one of the three methods for connecting to a TV.

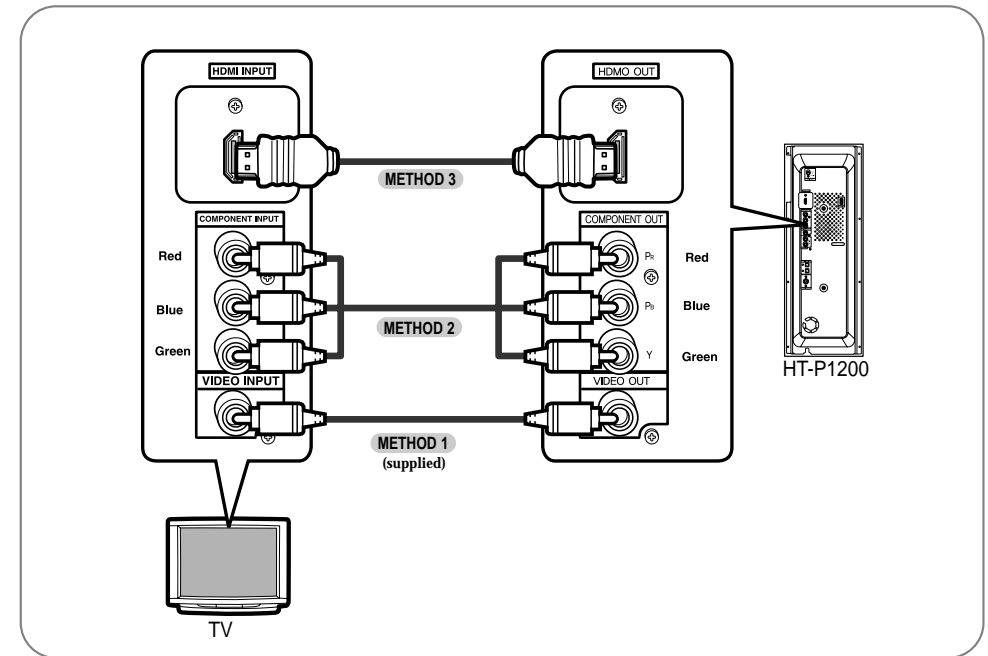

METHOD 1 Composite Video (Good Quality)

- Connect the supplied video cable from the VIDEO OUT jack on the back panel of the system to the VIDEO IN jack on your TV.

METHOD 2 Component (Better Quality)

- If your television is equipped with Component Video inputs, connect a component video cable (not supplied) from the Pr, Pb and Y jacks on the back panel of the system to the corresponding jacks on your TV.

METHOD 3 HDMI (Best Quality)

- Connect the HDMI out to the HDMI input on your TV.

Note

- This product operates in Progressive scan mode(Only 480p) for Component Output.
- If the TV only supports a resolution of 576i(480i), the screen may be divided into 2 screens, or display nothing.

What is HDMI (High Definition Multimedia Interface)?

This device transmits DVD video signal digitally without the process of converting to analog. You can get sharper digital pictures by connecting the video to your TV using an HDMI connection cable.

HDMI Audio ON/OFF function

- The audio signals transmitted over the HDMI Cable can be toggled ON/OFF.

Press the **HDMI AUDIO SELECT** button on the remote control.

- This toggles between "AUDIO ON" and "AUDIO OFF" on the display.
- AUDIO ON** : Both video and audio signals are transmitted over the HDMI connection cable, and audio output is through the TV speakers only.
- AUDIO OFF** : Video is transmitted over the HDMI connection cable only, and audio output is through the home theater speakers only.

Note

- The default setting value of this product is HDMI AUDIO OFF.
- HDMI AUDIO is automatically down-mixed to 2ch for TV speakers.
- If you turn the unit off and on, or switch functions when the HDMI AUDIO is automatically set to OFF.

DCDi (Directional Correlational Deinterlacing) Function

Converts the interlace signal to progressive to prevent flickering and to remove distortion or noise on the edge of screen.

Press and hold **DCDi** button on the remote control for over 3 seconds.

- Each time the button is pressed, the selection alternates between **DCDi ON** and **DCDi OFF**.

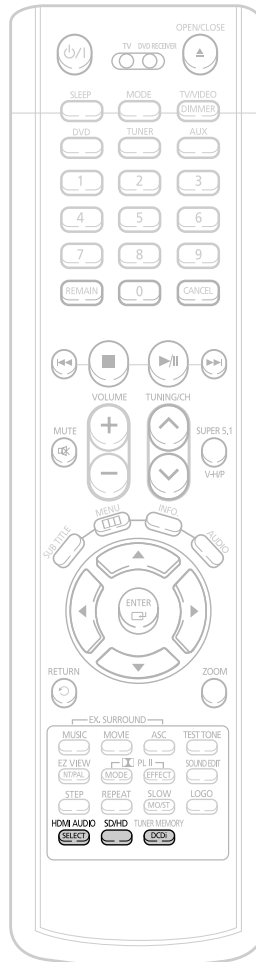

Resolution Selection

- This function allows the user to select screen resolution for HDMI output.

In Stop mode, press and hold the **SD/HD** (Standard Definition/High Definition) button on the remote control.

- SD (Standard Definition) means resolution of 480p and HD (High Definition) means resolution of 720p/1080i.

Example: If the TV supports resolution up to 480p

Press the **SD/HD** button.

- A 480p video signal is output through the HDMI output.
- If the TV does not support the configured resolution, you will not be able to see the picture properly.

Note

- Since this product has an embedded Video Upscaler function with Faroudja DCDi technology, it can enhance a 576i(480i) DVD resolution output to 480p/720p/1080i.
- You do not have to make separate adjustments, since the Home Theater and TV will be automatically adjust themselves to the optimal resolution and aspect ratio if connected to HDMI. (If the TV is an HDTV and has an HDMI Input jack, output is automatically converted to 1080i resolution (if supported by the TV).)
- For component video output, only 480P is supported.
- When both HDMI and COMPONENT jacks are connected, COMPONENT video is not displayed.
- See your TV owner's manual for more information on how to select the TV's Video Input source.

Connecting External Components

Connecting an External Digital, Analog Component

Example: Digital signal components such as a Set-top Box or CD Recorder.
Analog signal components such as a VCR or TV.

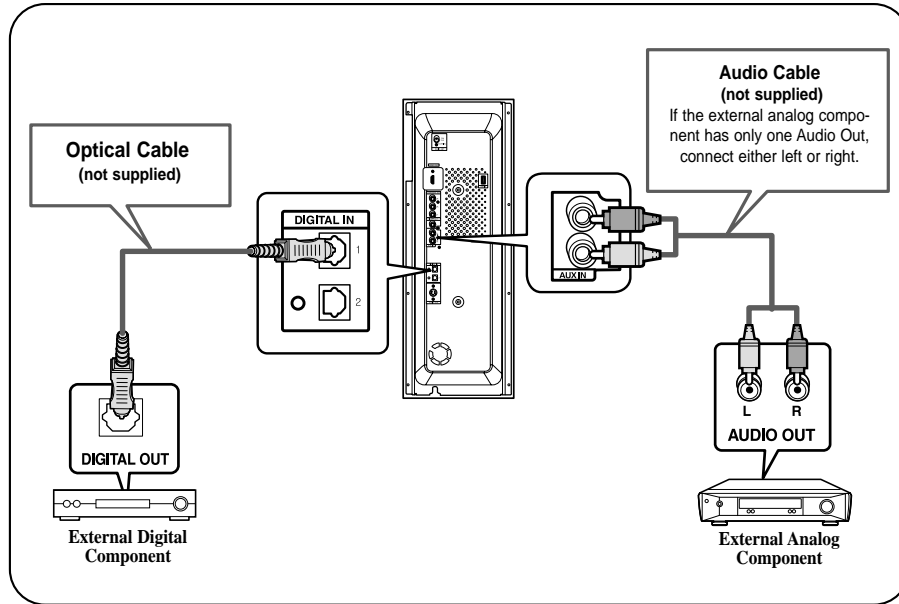

- 1 Connect the Digital In 1 or 2 (OPTICAL) on the main unit to the Digital Output on the external digital component.
- 2 Connect Audio In on the Home Theater to Audio Out on the external analog component.
 - Be sure to match connector colors.
- 3 Press **AUX** on the remote control to select 'D.IN 1 / D.IN 2 / AUX'.
 - Each time the button is pressed, the selection changes as follows: **USB** → **D.IN 1** → **D.IN 2** → **AUX**.
 - You can also use the **FUNCTION** button on the main unit.
The mode switches as follows: **DVD/CD** → **D.IN 1** → **D.IN 2** → **AUX** → **USB** → **FM**.

- Note**
- To listen to the audio from the TV in 5.1 channel through the main unit, press the Dolby Pro Logic II or the SUPER 5.1 button.
 - You can connect Video Output jack on the VCR to the TV, and connect Audio Output jack on the VCR to this product.

Connecting the FM Antenna

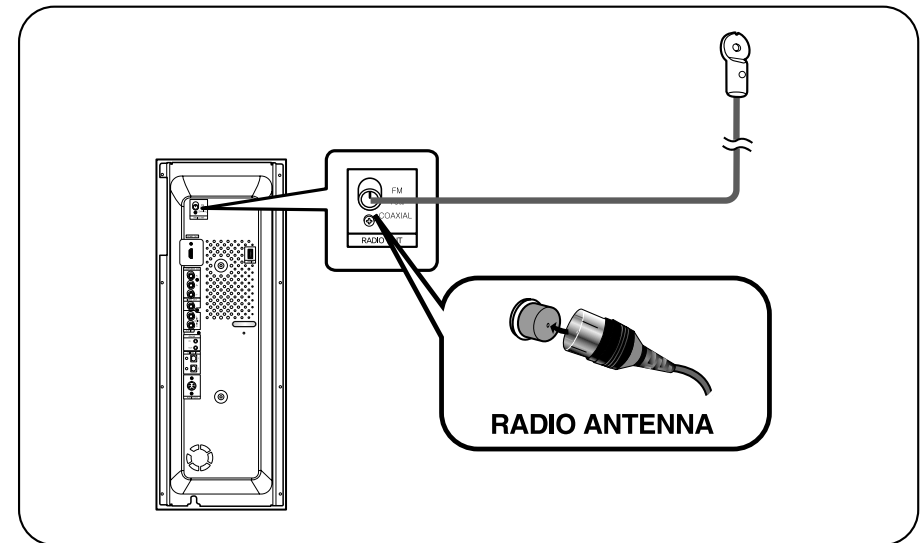

FM antenna connection

- 1 Connect the FM antenna supplied to the FM 75Ω COAXIAL terminal.
- 2 Slowly move the antenna wire around until you find a location where reception is good, then fasten it to a wall or other rigid surface.

Cooling Fan

The cooling fan supplies cool air to the unit to prevent overheating.

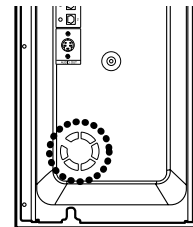

Please observe the following cautions for your safety.

- Make sure the unit is well-ventilated. If the unit has poor ventilation, the temperature inside the unit could rise and may damage it.
- Do not obstruct the cooling fan or ventilation holes. (If the cooling fan or ventilation holes are covered with a newspaper or cloth, heat may build up inside the unit and fire may result.)

Before Using Your Home Theater

Your Home Theater is capable of playing DVD, CD, MP3, DivX and JPEG discs. Depending on the disc you are using, these instructions may vary slightly. Read the instructions carefully before using.

To Operate the TV and DVD Player with a Single Remote Control

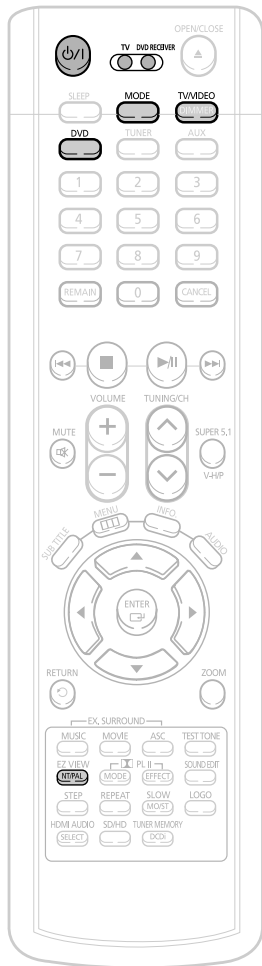

1 Plug the main unit's power cord into the AC power supply.

4 Press **TV/VIDEO** button to select VIDEO mode.



Note

- Buttons Enabled for TV Operation: POWER, CHANNEL, VOLUME, TV/VIDEO, and Numeric (0-9) buttons.
- By default, the remote control is set to work with Samsung TVs. See page 75 for more information on the operation of the remote control.

2 Press **MODE** button until the TV indicator lights red.

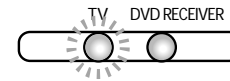

5 Press the **MODE** button until the DVD RECEIVER indicator lights green.

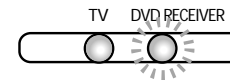

3 Press **POWER** button to turn on the main unit and then press **DVD** button to select "DVD/CD" function of the remote control.



6 Press **FUNCTION** button on the main unit or DVD on the remote to select DVD/CD mode.

Selecting the Video Format

Press and hold **NT/PAL** button on the remote controller for over 5 seconds while the power is turned off.

- By default, the video format is set to "PAL".
- "NTSC" or "PAL" will appear in the display. At this time, press the **NT/PAL** button shortly to select between "NTSC" and "PAL".
- Each country has a different video format standard.
- For normal playback, the video format of the disc must be the same as the video format of your TV.

1 Press **OPEN/CLOSE** button to open the disc tray.

2 Insert the disc so that the printed side faces out.

3 Press **OPEN/CLOSE** button to close the disc window.

- The disc plays automatically when the disc window is closed.
- The disc menu may appear differently depending on the disc.



- Playback starts automatically.

Note • Depending on the content of the disc, the initial screen may appear different.

To stop playback, press **STOP** during playback.

- If pressed once, "PRESS PLAY" is displayed and the stop position will be stored in memory. If **PLAY/PAUSE** (▶/||) button or **ENTER** button is pressed, playback resumes from the stop position. (This function works only with DVDs.)
- If pressed twice, "STOP" is displayed, and if **PLAY/PAUSE** (▶/||) button is pressed, playback starts from the beginning.

To temporarily pause playback, press **PLAY/PAUSE** during playback.

- To resume playback, press **PLAY/PAUSE** (▶/||) button again.

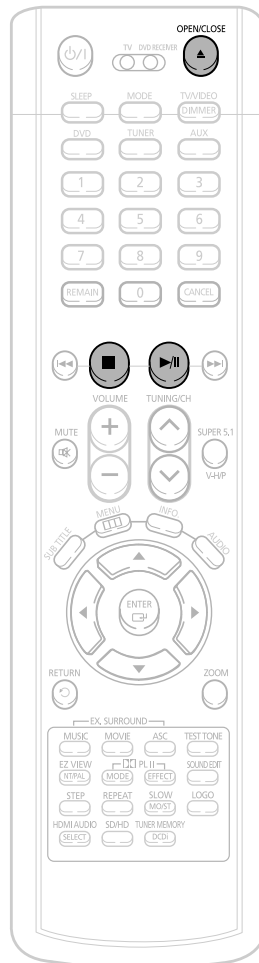

Disc terminology

Groups and tracks (DVD-AUDIO)

- DVD-audio is divided into several large sections called "groups" and smaller sections called "tracks". Numbers are allotted to these sections. These numbers are called "group numbers" and "track numbers".

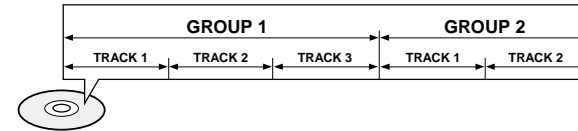

Titles and chapters (DVD-VIDEO)

- DVD-video is divided into several large sections called "titles" and smaller sections called "chapters". Numbers are allotted to these sections. These numbers are called "title numbers" and "chapter numbers".

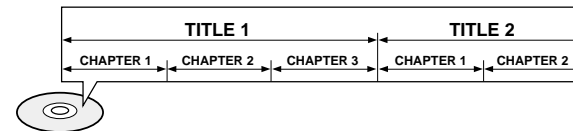

Tracks (SACD, Video and music CDs)

- Video and music CDs are divided into sections called "tracks". Numbers are allotted to these sections. These numbers are called "track numbers".

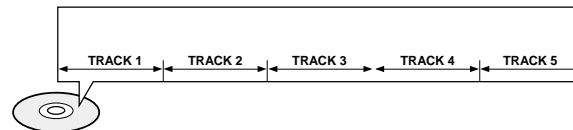

Files (DivX)

- DivX is divided into sections called "files". Numbers are allotted to these sections. These numbers are called "file numbers".

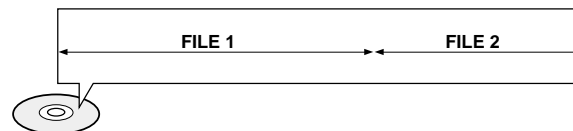

- Note** • In this manual, the instructions marked with "DVD (DVD)" are applicable to DVD-VIDEO, DVD-AUDIO, and DVD-R/RW discs. Where a particular DVD type is mentioned, it is indicated separately.
- Depending on the content of the disc, the initial screen may appear different.

SACD (Super Audio CD) Playback

You can listen to the high quality original sound of multi-channels that produces sound exceeding the limit of human sense.

1 Open the disk tray by using the **OPEN/ CLOSE** button and then insert SACD.

- SACD menu appears and the play begins.



2 When the play is stopped, select a track using the button and press the **ENTER** button.

- During the play, you cannot select a track using the **▲ ▼** button.

3 Press the **STOP** button to stop playback.

Disc Spec

Item	CD	SACD	DVD Audio
Number of Channels and Play Time	2 Channels: 70 Minutes	2 Channels: 110 Minutes 5.1 Channels: 81 Minutes	2 Channels: 120 Minutes 5.1 Channels: 89 Minutes
Sampling Frequency	44.1 KHz	2822.4 KHz (64 Times of CD)	44.1~192 KHz (4.4 Times of CD)
Dynamic Range	96 dB	120 dB	144 dB
Play Frequency	~20 KHz	~100 KHz	~96 KHz

- Note**
- SACD has three kinds of formats: Single Layer Disc that has 1 HD layer, Dual Layer Disc that has 2 HD layers and Hybrid Disc that has both CD and HD layers. Hybrid Discs can play in regular CD players.

MP3-CD Playback

Data CDs (CD-ROM, CD-R, CD-RW) encoded in MP3 format can be played.

1 Press the **OPEN/CLOSE** button to open the disc tray, and then load the MP3 disc.

- The MP3 menu screen will appear and playback will start.
- The appearance of the menu depends on the MP3 disc.
- WMA-DRM files cannot be played.

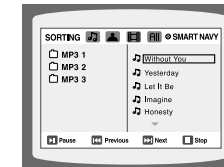

2 In Stop mode, use **◀ ▶ ▲ ▼** to select the album, and then press the **ENTER** button.

- User **▲ ▼** to select the track.

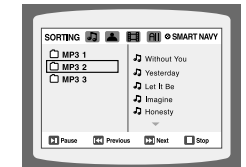

3 To change the album, use **◀ ▶ ▲ ▼** to select another album in Stop mode, and then press the **ENTER** button.

- To select another album and track, repeat Steps 2 and 3 above.

- Note**
- Depending on the recording mode, some MP3-CDs may not play.
 - Table of contents of a MP3-CD varies depending on the MP3 track format recorded on the disc.

4 Press the **STOP** button to stop playback.

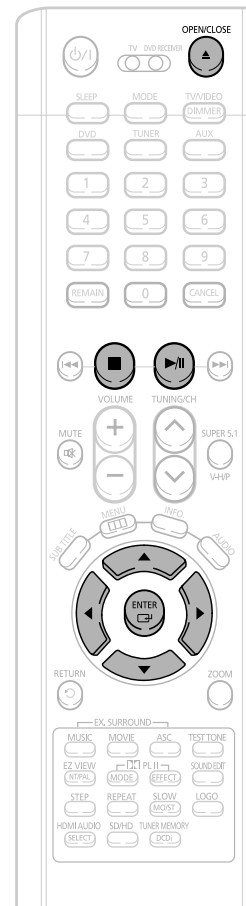

To play a file icon in the screen,

Press the **◀ ▶ ▲ ▼** button when it is in stop status and select a desired icon from the top part of the menu.

- To play music files only, select the **🎵** Icon.
- To view image files only, select the **👤** Icon.
- To view movie files only, select the **🎬** Icon.
- To select all files select the **📁** Icon.

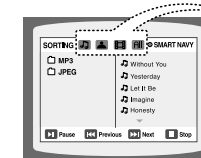

- Music File Icon
- Image File Icon
- Movie File Icon
- All File Icon

JPEG File Playback JPEG

Images captured with a digital camera or camcorder, or JPEG files on a PC can be stored on a CD and then played back with this DVD player.

Press the **OPEN/CLOSE** button to open the disc windows, and then load the JPEG disc.

- Playback will start automatically and each image will show for 5 seconds before moving to the next image.

To rotate the image

During playback, press ▲▼◀▶.

- | | |
|-----------------------|-------------------------------|
| ▲ Rotate vertically | ◀ Rotate 90° counterclockwise |
| ▼ Rotate horizontally | ▶ Rotate 90° clockwise |

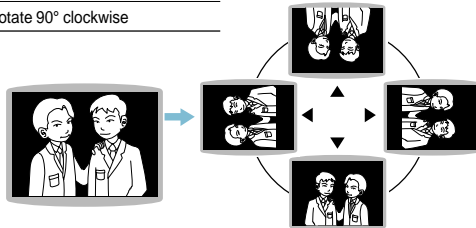

JPEG limitation

The maximum resolution is 5120 x 3840 (or 19.0 MPixel) for baseline images, and 2048 x 1536 (3.0 MPixel) for progressive images.

There is no filesize limitation.

The decoder is device independent, thus above applies to USB and other devices as well.

📶 Progressive JPEG images — those that appear gradually as the image is being downloaded.

Checking the Remaining Time

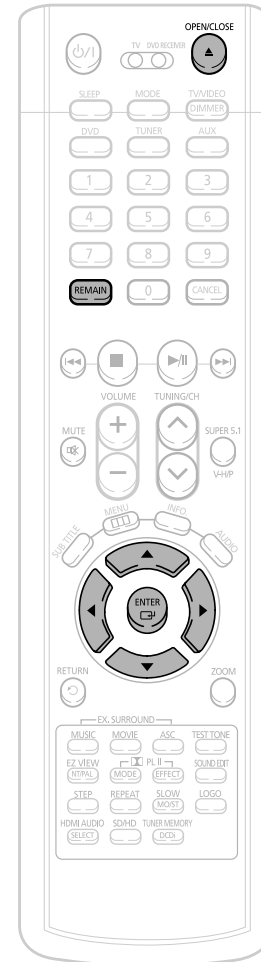

Press the **REMAIN** button.

- For checking the total and remaining time of a title or chapter being played.

Each time the **REMAIN** button is pressed

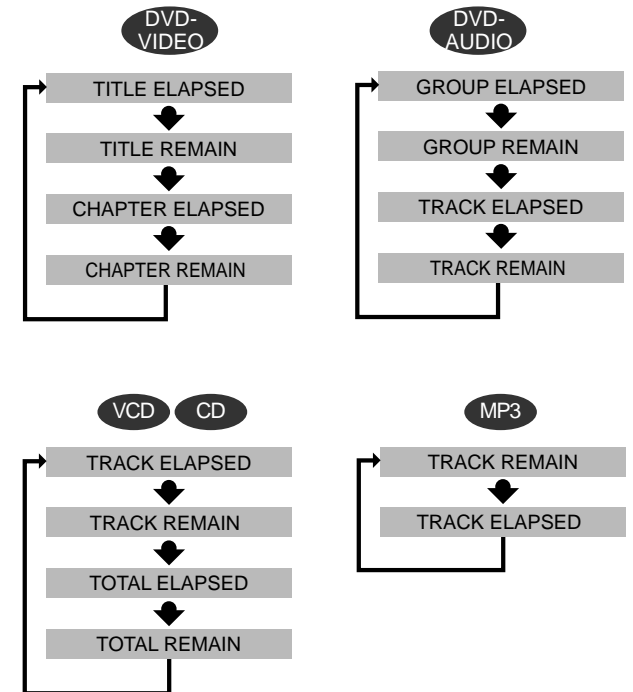

DivX Playback

Skip Forward/Back

During playback, press the **⏮️⏭️** button.

- Goes to the next file whenever you press **⏭️** button, if there are over 2 files in the disk.
- Goes to the previous file whenever you press **⏮️** button, if there are over 2 files in the disk.

Fast playback

To play back the disc at a faster speed, press and hold **⏮️** or **⏭️** during playback.

- Each time you press and hold either button, the playback speed will change as follows:
2x → 4x → 8x → 32x → Normal.

5 Minute Skip function

During playback, press the **⏪** , **⏩** button.

- Playback skips 5 minutes forward whenever you press **⏩** button.
- Playback skips 5 minutes back whenever you press **⏪** button.

Zoom Function

1 Press **ZOOM** button.

- Each time you press the button, your selection will toggle between "ZOOM X2" and "ZOOM OFF".

2 Press Cursor **⬆️** , **⬇️** , **⬅️** , **➡️** buttons to move to the area you want to enlarge.

- Note**
- DivX file can be zoomed only in ZOOM X2 mode.
 - DivX files have .Avi file extensions, however, not all .Avi files are DivX and may not be playable in this unit.

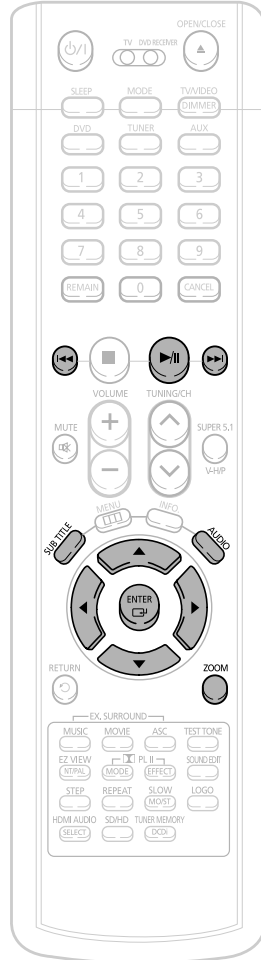

Subtitle Display

Press the **SUBTITLE** button.

- Each time you press the button, your selection will toggle between "SUBTITLE ON" (1/1, 1/2 ...) and "SUBTITLE OFF".
- If the disc has only one subtitle file, it will be played automatically.

Audio Display

Press the **AUDIO** button.

- Each time you press the button, your selection will toggle between "AUDIO ON" (1/1, 1/2 ...) and "⏮️".

Note • "⏮️" is displayed when there is one supported language in the disc.

DivX(Digital internet video eXpress)

DivX is a video file format developed by Microsoft and is based on MPEG4 compression technology to provide audio and video data over the Internet in real-time. MPEG4 is used for video encoding and MP3 for audio encoding so that the users can watch a movie at near DVD-quality video and audio.

1. Supported Formats

- This product only provides the following media formats. If both video and audio formats are not supported, the user may experience problems such as broken images or no sound.

Supported Video Formats

Format	AVI	WMV
Supported Versions	DivX3.11 ~ 5.1	V1/V2/V3/V7

Supported Audio Formats

Format	MP3	WMA	AC3	DTS
Bit Rate	80~384kbps	56~128kbps	128~384kbps	1.5Mbps
Sampling Frequency	44.1khz	44.1/48khz	44.1khz	

- DivX files, including audio and video files, created in the DTS format can only support up to 6Mbps.
- Aspect Ratio: Although default DivX resolution is 640*480 pixels (4:3), this product supports up to 720*480 pixels (16:9). TV screen resolutions higher than 800 will not be supported.
- When you play a disc whose sampling frequency is higher than 48khz or 320kbps, you may experience shaking on the screen during playback.

2. Caption Function

- You must have some experience with video extraction and editing in order to use this feature properly.
- To use the caption function, save the caption file (*.smi) in the same file name as that of the DivX media file (*.avi) within the same folder.
Example. Root Samsung_Blueetek_007CD1.avi
 Samsung_Blueetek_007CD1.smi
- Up to 60 alphanumeric characters or 30 East Asian characters (2 byte characters such as Korean and Chinese) for the file name.

Playing Media Files using the USB HOST feature

You can enjoy media files such as pictures, movies and music saved in an MP3 player, USB memory or digital camera in high quality video with 5.1 channel home theater sound by connecting the storage device to the USB port of the home theater.

- 1 Connect the USB device to the USB port on the reside of the unit.

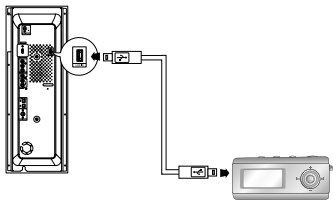

- 2 Press the **FUNCTION** button on the main unit or the **AUX** button on the remote control to select the USB mode.

- "USB" appears on the display screen and then disappear.
- USB SORTING screen appears on the TV screen and the saved file is played.

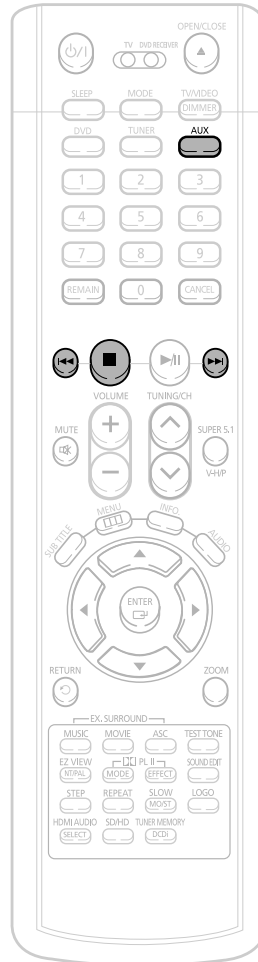

To stop playback, press the **STOP (■)** button.

Safe USB Removal

To prevent damage to the memory stored in the USB device, perform safe removal before disconnecting the USB cable.

- (1) Press the stop button twice in a row.
The display will show **REMOVE → USB**.
- (2) When the main unit is powered off, or in a different function mode, remove the USB cable.

Skip Forward/Back

During playback, press the **⏮⏭** button.

- When there is more than one file, when you press the **⏭** button, the next file is selected.
- When there is more than one file, when you press the **⏮** button, the previous file is selected.

Fast playback

To play back the disc at a faster speed, press and hold **⏮** or **⏭** during playback.

- Each time you press and hold either button, the playback speed will change as follows:
2x → 4x → 8x → 32x → Normal.

Compatible Devices

1. USB devices that support USB Mass Storage v1.0. (USB devices that operate as a removable disk in Windows (2000 or later) without additional driver installation.)
2. MP3 Player: HDD and flash type MP3 player.
3. CBI (Control/Bulk/Interrupt) is not supported.
4. Digital camera: PTP protocol is not supported.
 - Devices which require additional program installation when you have connected it to a computer, are not supported.
5. USB HDD and USB Flash Drive: Devices that support USB2.0 or USB1.1.
 - You may experience a difference in playback quality when you connect a USB1.1 device.
 - For a USB HDD, make sure to connect an auxiliary power cord to the USB HDD for proper operation.
6. USB card Reader: One slot USB card reader and Multi slot USB card reader
 - Depending on the manufacturer, the USB card reader may not be supported.
 - If you install multiple memory devices into a multi card reader, you may experience problems.
7. If you use a USB extension cable, the USB device might not be recognized.

Supported Formats

	File name	File extension	Bit rate	Version	Pixel	Sampling Frequency
Still Picture	JPG	.JPG .JPEG	-	-	640*480	-
Music	MP3	.MP3	128~320kbps	-	-	32k/44.1k/48kHz
	WMA	.WMA	56~128kbps	V8	-	32k/44.1k/48kHz

- A device using NTFS file system is not supported. (Only FAT 16/32 (File Allocation Table 16/32) file system is supported.)
- **The USB host function of this product does not support all USB devices. For information on the supported devices, see pages 81~82.**

Displaying Disc Information

You can view disc playback information on the TV screen.

Press **INFO** button.

- Each time the button is pressed, the display changes as follows:

DVD

↓

↓

Display disappears

VCD CD

↓

Display disappears

MP3 DivX JPEG

↓

Display disappears

• **Hand icon appears on the TV screen!**
If this symbol appears on the TV screen while buttons are being operated, that operation is not possible with the disc currently being played.

- **What is a Group?**
A section of tracks contained in a DVD-AUDIO disc.
- **What is a Title?**
A movie contained in a DVD-VIDEO disc.
- **What is a Chapter?**
Each title on a DVD disc is divided into several smaller sections called "chapters".
- **What is a Track (File)?**
A section of video or a music file recorded on a DVD-AUDIO, CD, or MP3-CD.

Note

- Depending on the disc, the disc information display may appear different.
- Depending on the disc, you can also select DTS, DOLBY DIGITAL, or PRO LOGIC.

Screen Display

DVD DVD display	DivX DivX display	CHAPTER display	REPEAT PLAYBACK display	LR STEREO (L/R) display
VCD VCD display	DVD AUDIO DVD-AUDIO display	TRACK (FILE) display	AUDIO LANGUAGE display	DOLBY DIGITAL display
CD CD display	TITLE display	ELAPSED TIME display	SUBTITLE display	ANGLE display
MP3 MP3 CD display	GROUP display	SACD display		

Fast/Slow Playback

Fast Playback

DVD VCD SACD CD MP3

Press and hold **Fast Playback** button.

- Each time the button is held down during playback, the playback speed changes as follows:

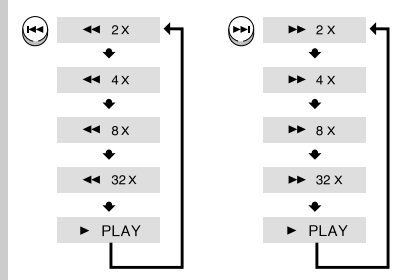

Slow Playback

Press **SLOW** button.

- Each time the button is pressed during playback, the playback speed changes as follows:

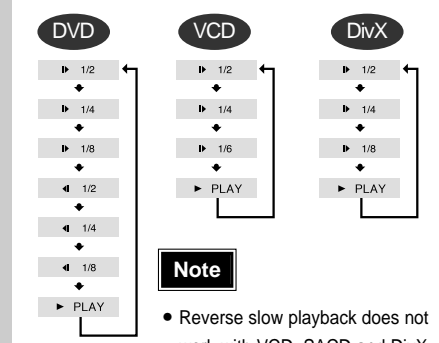

Note

- Reverse slow playback does not work with VCD, SACD and DivX.

Skipping Scenes/Songs

Briefly press **Fast Playback** button.

- Each time the button is pressed briefly during playback, the previous or next chapter, track, or directory (file) will be played.
- You cannot skip chapters consecutively.

DVD

VCD SACD

MP3

• When watching a VCD with a track longer than 15 minutes, each time **Fast Playback** is pressed, playback will skip back or forward 5 minutes.

Repeat Playback

Repeat playback allows you to repeatedly play a chapter, title, track (song), or directory (MP3 file).

DVD VCD SACD CD MP3 JPEG

Press **REPEAT** button.

- Each time the button is pressed during playback, the repeat playback mode changes as follows:

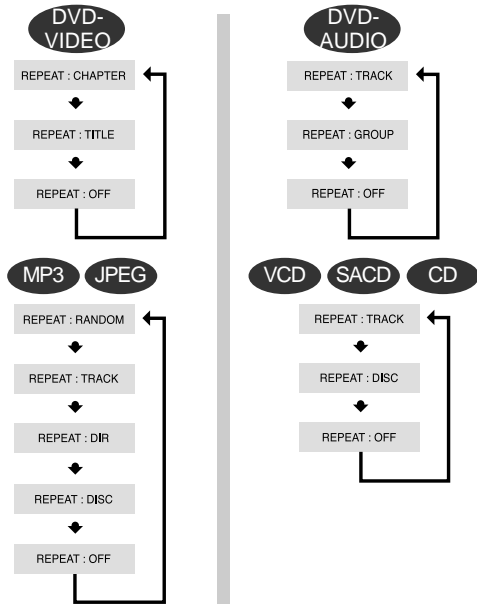

Repeat Playback Options

- CHAPTER**
Repeatedly plays the selected chapter.
- TITLE**
Repeatedly plays the selected title.
- GROUP**
Repeatedly plays the selected group.
- RANDOM**
Plays tracks in random order. (A track that has already been played may be played again.)
- TRACK**
Repeatedly plays the selected track.
- DIR**
Repeatedly plays all tracks in the selected folder.
- DISC**
Repeatedly plays the entire disc.
- OFF**
Cancels Repeat Playback.

To Select a Repeat Playback Mode in the Disc Information Screen

- Press **INFO** button twice.
- Press Cursor **▶** button to move to REPEAT PLAYBACK () display.
- Press Cursor **▼** button to select the desired Repeat Playback mode.
- Press **ENTER** button.

* For MP3 and JPEG discs, you cannot select Repeat Play from the information display screen.

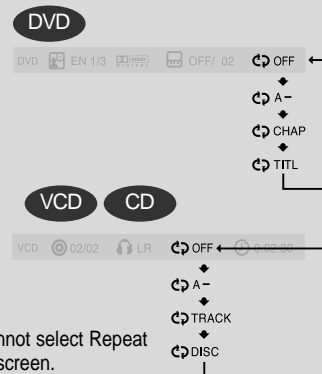

Note

- Repeat playback operation is not possible with version 2.0 VCD discs if PBC is turned on. To use Repeat Playback on a VCD with PBC, you should set the PBC to OFF in the disc menu. (See page 44.)

A-B Repeat Playback

You can repetitively play back a designated section of a DVD.

DVD VCD CD

- Press **INFO** button twice.

- For a VCD or CD, press **INFO** button once.

DVD EN 1/3 OFF/ 02 OFF

- Press Cursor **▶** button to move to REPEAT PLAYBACK () display.

DVD EN 1/3 OFF/ 02 OFF

- Press Cursor **▲**, **▼** buttons to select 'A' and then press **ENTER** button at the beginning of the desired segment.

- When **ENTER** button is pressed, the selected position will be stored in memory.

DVD EN 1/3 OFF/ 02 A-

DVD EN 1/3 OFF/ 02 A-? REPEAT: A-

- Press **ENTER** button at the end of the desired segment.

- The specified segment will be played repeatedly.

DVD EN 1/3 OFF/ 02 A-B

REPEAT: A-B



- To return to normal playback, press Cursor **▲**, **▼** buttons to select **OFF**.

Note

- The A-B Repeat function will not work on an SACD, MP3 or JPEG disc.

Step Function DVD VCD

Press **STEP** button.

- The picture moves forward one frame each time the button is pressed during playback.

Note

- During fast playback of a SACD, CD or MP3-CD, sound is heard only at 2x speed, and not at 4x, 8x, and 32x speeds.
- No sound is heard during slow playback and step motion playback.



Angle Function DVD

This function allows you to view the same scene in different angles.

1 Press **INFO** button.

2 Press Cursor **↔** button to move to **ANGLE** () display.

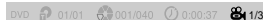
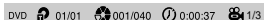

3 Press Cursor **▲, ▼** or numeric buttons to select the desired angle.

- Each time the button is pressed, the angle changes as follows:

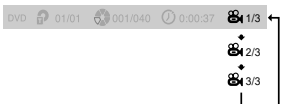

Note

- The Angle function works only with discs on which multiple angles have been recorded.

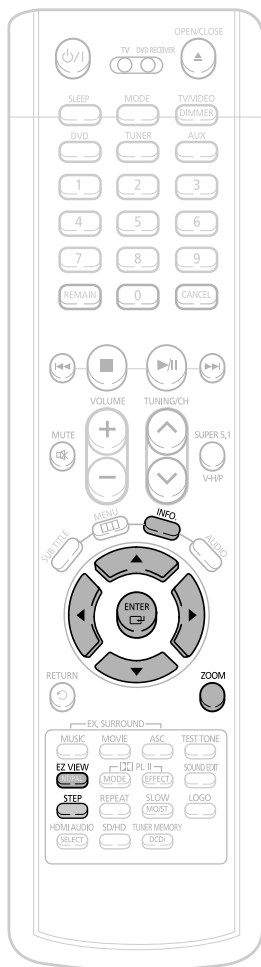

Zoom (Screen Enlarge) Function DVD VCD GB

This function allows you to enlarge a particular area of the displayed image.

1 Press **ZOOM** button.

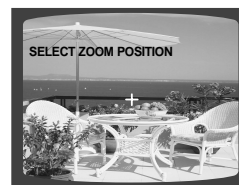

2 Press Cursor **▲, ▼, ◀, ▶** buttons to move to the area you want to enlarge.



3 Press **ENTER** button.

- Each time the button is pressed, the zoom level changes as follows:

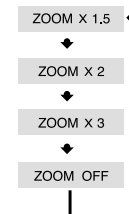

Note

- When a DivX disc is being played, only the 2:1 zoom-in is available.

EZ VIEW Function DVD

Press **EZ VIEW** button.

- Each time the button is pressed, the zoom function will switch between On and Off.
- When a movie is played in Widescreen format, black bars at the top and bottom of the TV screen can be removed by pressing the **EZ VIEW** button.



Note

- This function will not work if the DVD is recorded with multi-camera angle format.
- Black bars may not disappear because some DVD discs have a built-in horizontal to vertical ratio.
- This feature is not supported for DivX discs.

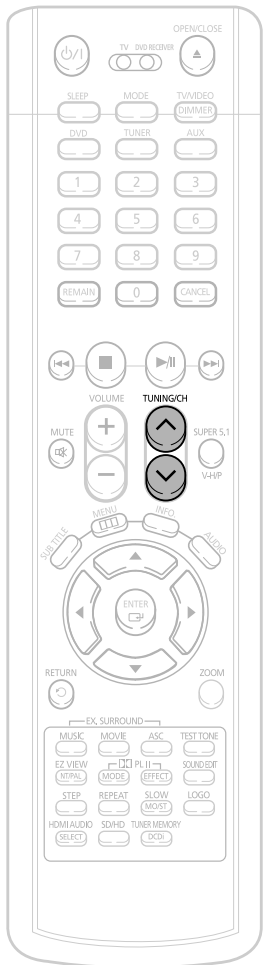

Bonus Group DVD-AUDIO

Some DVD-Audio discs have an extra 'bonus' group that requires a 4-digit key number to access. See the disc packaging for details and the key number.

When you play a DVD-Audio disc that has a bonus group, the key number input screen appears automatically.

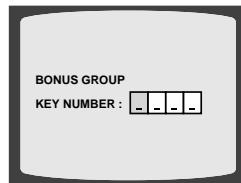

Note

- If you eject the disc, switch the power off, or unplug the player, you will need to re-enter the key number.

Navigating Pages DVD-AUDIO

During playback, press the **TUNING/CH** button on the remote control.

- You can select the desired image from a DVD-Audio disc containing still images.
- With some discs, you may not be able to select images depending on how the disc was manufactured.

Audio Language Selection Function DVD

1 Press **INFO** button twice.

2 Press Cursor **▲**, **▼** buttons or numeric buttons to select the desired audio language.

- Depending on the number of languages on a DVD disc, a different audio language (ENGLISH, SPANISH, FRENCH, etc.) is selected each time the button is pressed.

DVD EN 1/3 OFF/ 02 OFF

DVD EN 1/3 OFF/ 02 OFF

SP 2/3
FR 3/3

Note

- You can use the **AUDIO** button on the remote control to select a audio language.

Subtitle Language Selection Function DVD

1 Press **INFO** button twice.

2 Press Cursor **▶** button to move to **SUBTITLE** () display.

DVD EN 1/3 OFF/ 02 OFF

DVD EN 1/3 OFF/ 02 OFF

3 Press Cursor **▼** button or numeric buttons to select the desired subtitle.

DVD EN 1/3 OFF/ 02 OFF

EN 01/ 03
SP 02/ 03
FR 03/ 03
OFF / 03

Note

- To operate this function, you can also press the Select **AUDIO** or Select **SUBTITLE** buttons on the remote control.
- You can use the **SUBTITLE** button on the remote control to select a subtitle language.
- Depending on the disc, the Subtitle and Audio Language functions may not work.

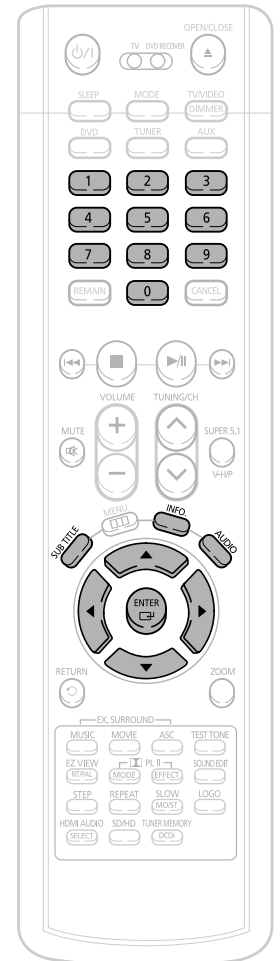

Moving Directly to a Scene/Song

DVD VCD SACD CD

1 Press **INFO** button.

DVD 01/05 001/040 0:00:37 1/1

Moving to a Title/Track

2 Press Cursor **▲, ▼** buttons or numeric buttons to select the desired title/track and then press **ENTER** button.

DVD 03/05 001/002 0:00:01 1/1

Moving to a Chapter

3 Press Cursor **◀, ▶** buttons to move to Chapter () display.

DVD 01/05 001/040 0:00:01 1/1

Moving to a Chapter

4 Press Cursor **▲, ▼** buttons or numeric buttons to select the desired chapter and then press **ENTER** button.

DVD 01/05 025/040 0:00:01 1/1

Moving to a Specific Time

5 Press Cursor **◀, ▶** buttons to move to time display.

DVD 01/05 025/040 1:17:30 1/1

Moving to a Specific Time

6 Press the numeric buttons to select the desired time and then press **ENTER** button.

DVD 01/05 028/040 1:30:00 1/1

MP3 JPEG

Press the **numeric** buttons.

- The selected file will be played.
- An MP3 or JPEG disc cannot be moved in the disc information screen.
- When playing an MP3 or JPEG disc, you cannot use **▲, ▼** to move to a folder. To move a folder, press **■** (Stop) and then press **▲, ▼**.

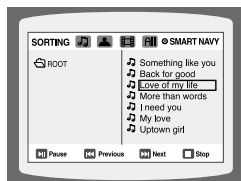

Note

- You can press **◀◀▶▶** on the remote control to move directly to the desired title, chapter, or track.
- Depending on the disc, you may not be able to move to the selected title or time.

Using Disc Menu DVD

You can use the menus for the audio language, subtitle language, profile, etc. DVD menu contents differ from disc to disc.

1 In Stop mode, press **MENU** button.

- When playing a VCD (version 2.), this toggles between PBC ON and OFF.



2 Press Cursor **▲, ▼** buttons to move to 'DISC MENU' and then press **ENTER** button.

- When you select the disc menu that is not supported by the disc, the "This menu is not supported" message appears on the screen.



3 Press Cursor **▲, ▼**, **◀, ▶** buttons to select the desired item.

- Press **ENTER** button.



Note

- Disc menu display may be different depending on the disc.

PBC (Playback Control) Function

When playing a VCD (version 2.0), you can select and view various scenes according to the menu screen.

PBC ON: This VCD disc is version 2.0. The disc is played back according to the menu screen. Some functions may be disabled. When some functions are disabled, select "PBC OFF" to enable them.

PBC OFF: This VCD disc is version 1.1. The disc is played back in the same way as with a music CD.

Using the Title Menu DVD

For DVDs containing multiple titles, you can view the title of each movie. Depending on the disc, the availability of this feature may vary.

1 In Stop mode, press **MENU** button.



2 Press Cursor **▲, ▼** button to move to 'Title Menu'.



3 Press **ENTER** button.

- The title menu appears.



Press **MENU** button to exit the setup screen.

Note

- Title menu display may be different depending on the disc.

Setting the Language

OSD (On-Screen Display) language is set to English by default.

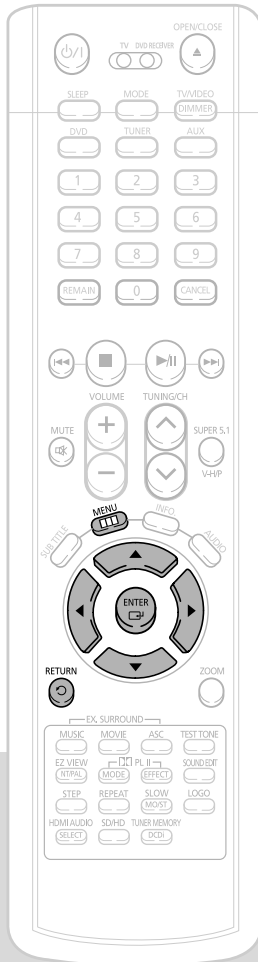

1 In Stop mode, press **MENU** button.

2 Press Cursor **▼** button to move to 'Setup' and then press **ENTER** button.

3 Select 'Language' and then press **ENTER** button

4 Press Cursor **▲, ▼** button to select 'OSD Language' and then press **ENTER** button.

5 Press Cursor **▲, ▼** button to select the desired language and then press **ENTER** button.

• Once the setup is complete, if the language was set to English, OSD will be displayed in English.

- Press **RETURN** button to return to the previous level.
- Press **MENU** button to exit the setup screen.

Note

• To select another language, select OTHER and enter the language code of your country. (See page 78 for language codes)
AUDIO, SUB TITLE and DISC MENU language can be selected.



Selecting the OSD Language



Selecting the Audio Language (recorded on the disc)



Selecting the Subtitle Language (recorded on the disc)



Selecting the Disc Menu Language (recorded on the disc)

* If the language you selected is not recorded on the disc, menu language will not change even if you set it to your desired language.

Setting TV Screen type

Depending on your TV type (Wide Screen or conventional 4:3), you can select the TV's aspect ratio.

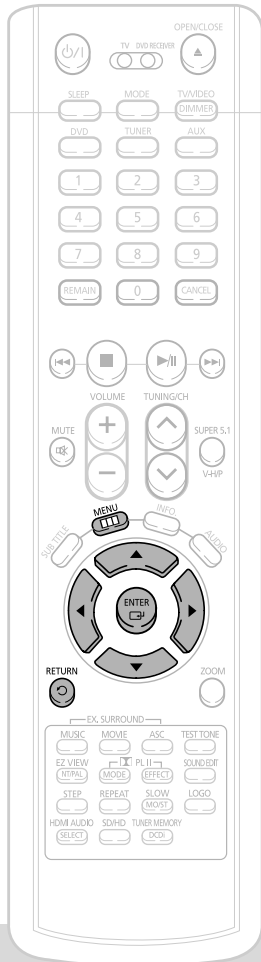

1 In Stop mode, press **MENU** button.



2 Press Cursor **▼** button to move to 'Setup' and then press **ENTER** button.



3 Press Cursor **▼** button to move to 'TV DISPLAY' and then press **ENTER** button.



4 Press Cursor **▲, ▼** button to select the desired item and then press **ENTER** button.



• Once the setup is complete, you will be taken to the previous screen.

Adjusting the TV Aspect Ratio (Screen Size)

The horizontal to vertical screen size ratio of conventional TVs is 4:3, while that of widescreen and high definition TVs is 16:9. This ratio is called the aspect ratio. When playing DVDs recorded in different screen sizes, you should adjust the aspect ratio to fit your TV or monitor.

- For a standard TV, select either "4:3LB" or "4:3PS" option according to personal preference. Select "16:9" if you have a widescreen TV.

WIDE

: Select this to view a 16:9 picture in the full-screen mode on your widescreen TV.
• You can enjoy the widescreen aspect.



4:3LB (4:3 Letterbox)

: Select this to play a 16:9 picture in the letter box mode on a conventional TV.
• Black bars will appear at the top and bottom of the screen.



4:3PS (4:3 Pan&Scan)

: Select this to play a 16:9 picture in the pan & scan mode on a conventional TV.
• You can see the central portion of the screen only (with the sides of the 16:9 picture cut off).



Note

- If a DVD is in the 4:3 ratio, you cannot view it in widescreen.
- Since DVD discs are recorded in various image formats, they will look different depending on the software, the type of TV, and the TV aspect ratio setting.

Press **RETURN** button to return to the previous level.

Press **MENU** button to exit the setup screen.

Setting Parental Controls (Rating Level)

Use this to restrict playback of adult or violent DVDs you do not want children to view.

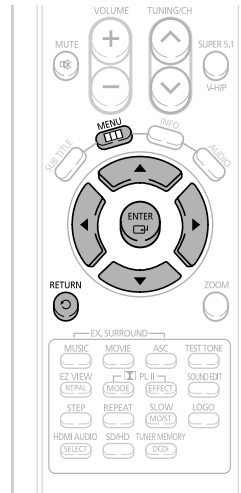

1 In Stop mode, press **MENU** button.



2 Press Cursor **▼** button to move to 'Setup' and then press **ENTER** button.



3 Press Cursor **▼** button to move to 'PARENTAL' and then press **ENTER** button.

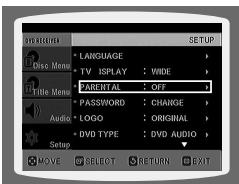

4 Press Cursor **▲, ▼** button to select the desired rating level and then press **ENTER** button.

- If you have selected Level 6, you cannot view DVDs with Level 7 or higher.
- The higher the level, the closer the content is to violent or adult material.



5 Enter the password and then press **ENTER** button.

- The password is set to "7890" by default.
- Once the setup is complete, you will be taken to the previous screen.

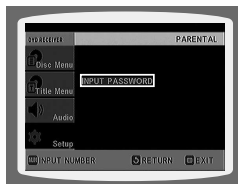

Note • This function works only if a DVD disc contains the rating level information.

Press **RETURN** button to return to the previous level.

Press **MENU** button to exit the setup screen.

Setting the Password

You can set the password for the Parental (rating level) setting.

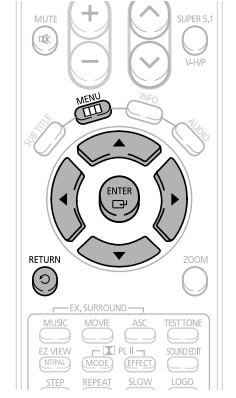

1 Press **MENU** button.



2 Press Cursor **▼** button to move to 'Setup' and then press **ENTER** button.



3 Press Cursor **▼** button to move to 'PASSWORD' and then press **ENTER** button.



4 Press **ENTER** button.

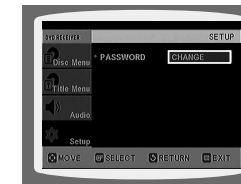

5 Enter the password and then press **ENTER** button.

- Enter the old password, a new password, and confirm new password.
- The setting is complete.



Note • The password is set to "7890" by default.

If you have forgotten the rating level password, do the following:

- While the player is in the no disc mode, hold the main unit's **○** button for longer than 5 seconds. "INITIALIZE" appears on the display and all settings will return to the default values.
- Press the **POWER** button.

Using the RESET function will erase all stored settings. Do not use this unless necessary.

Setting the Wallpaper

JPEG DVD VCD

While watching a DVD, VCD or JPEG CD, you can set the image you like as background wallpaper.

Setting the Wallpaper

1 During playback, press **PLAY/PAUSE** button when an image you like appears.



2 Press **LOGO** button.

• "COPY LOGO DATA" will be displayed on the TV screen.



3 The power will turn off and then back on.

- The selected wallpaper will be displayed.
- You can select up to 3 wallpaper settings.

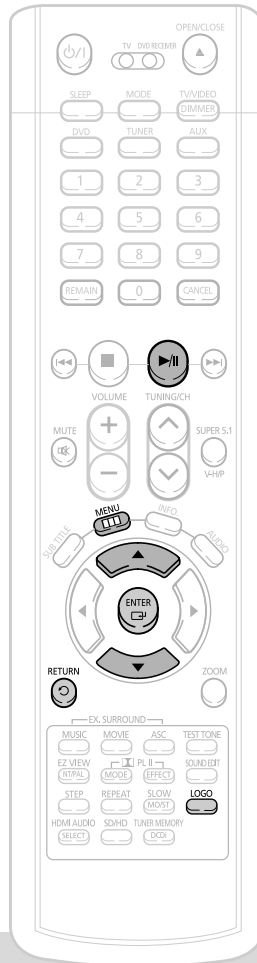

To select one of the 3 wallpaper settings you've made

1 In Stop mode, press **MENU** button.



2 Press **Cursor** button to move to 'Setup' and then press **ENTER** button.



3 Press **Cursor** button to move to 'LOGO' and then press **ENTER** button.

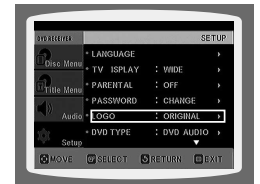

4 Press **▼** to select the desired 'USER', and then press **ENTER**.

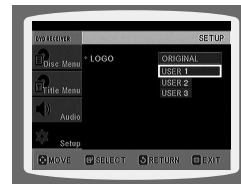

5 Press **MENU** button to exit the setup screen.



Select this to set the Samsung Logo image as your wallpaper.



Select this to set the desired image as your wallpaper.

Press **RETURN** button to return to the previous level.

Press **MENU** button to exit the setup screen.

DVD Audio Disc Playback Mode

Some DVD-Audio discs contain DVD-Video as well as DVD-Audio.
To play back the DVD-Video portion of the DVD-Audio disc, set the unit to DVD-Video mode.

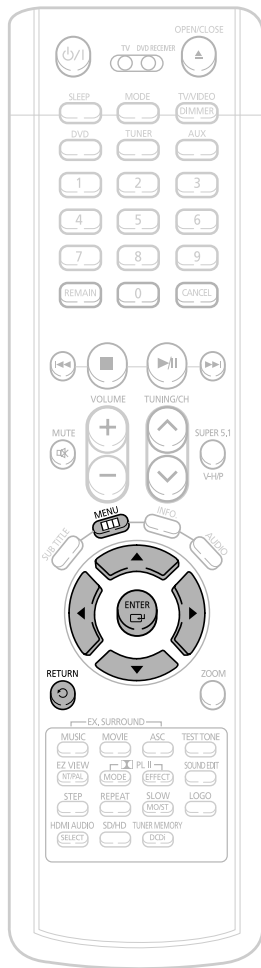

1 Press the **MENU** button while the disc tray is open.



2 Press Cursor **▼** button to move to 'Setup' and then press **ENTER** button.



3 Press Cursor **▼** button to move to 'DVD TYPE' and then press **ENTER** button.



4 Press Cursor **▲, ▼** button to move to 'DVD VIDEO' and then press **ENTER** button.



When Selecting DVD Play Mode:

- **DVD VIDEO** : set to play the DVD video contents contained on a DVD audio disc.
- **DVD AUDIO** : set to play the default DVD audio.

Note • DVD Play mode is set to DVD Audio as factory default setting.
• Powering off the main unit will automatically switch to the DVD Audio mode.

DivX (R) registration

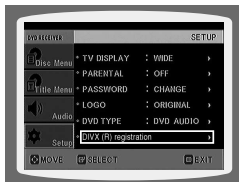

• Please use the Registration code to register this player with the DivX (R) video on demand format. To learn more, go to www.divx.com/vod.

SACD Playback Mode

If the SACD is created in HYBRID disc format, you can play the disc in CDDA MODE as well.

1 Press the **MENU** button while the disc tray is open.



2 Press Cursor **▼** button to move to 'Setup' and then press **ENTER** button.



3 Press Cursor **▼** button to move to 'SACD TYPE' and then press **ENTER** button.



4 Press Cursor **▲, ▼** button to move to 'SACD MODE' and then press **ENTER** button.

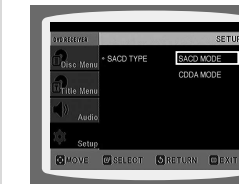

• Set steps 1 ~ 4 again if you want to switch to CDDA Play mode.

- **SACD MODE** : Set this mode to play SACD.
- **CDDA MODE** : Set this mode to play CDDA contents included in a disc.

Note • Powering off the main unit will automatically switch to the SACD mode.

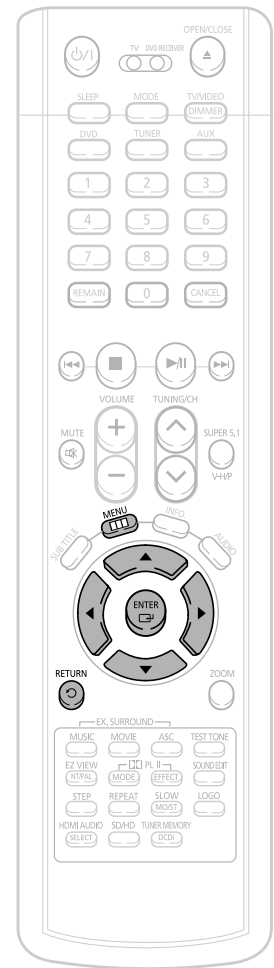

Setting the Speaker Mode

Signal outputs and frequency responses from the speakers will automatically be adjusted according to your speaker configuration and whether certain speakers are used or not.

1 In Stop mode, press **MENU** button.



2 Press Cursor \blacktriangledown button to move to 'Audio' and then press **ENTER** button.



3 In the Speaker Setup, press the **ENTER** button again.



4 Press Cursor \blacktriangle , \blacktriangledown , \blacktriangleleft , \blacktriangleright buttons to move to the desired speaker and then press **ENTER** button.



- For C, SL, and SR, each time the button is pressed, the mode switches alternately as follows: SMALL \rightarrow NONE.
- For L and R, the mode is set to SMALL.

SMALL : Select this when using the speakers.
NONE : Select this when no speakers are connected.

Note

- Depending on PRO LOGIC and STEREO settings, the speaker mode may vary (see page 63).

Setting the Test Tone

Use the Test Tone feature to check the speaker connections.

1 In Stop or no disc mode, press **MENU** button.



2 Press Cursor \blacktriangledown button to move to 'Audio' and then press **ENTER** button.

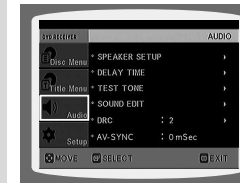

3 Press Cursor \blacktriangledown button to move to 'TEST TONE' and then press **ENTER** button.

- The test tone will be sent to L \rightarrow C \rightarrow R \rightarrow SR \rightarrow SL \rightarrow SW in order. If the ENTER button is pressed again at this time, the test tone will stop.



Press **RETURN** button to return to the previous level.

Press **MENU** button to exit the setup screen.

Alternate method: press the **TEST TONE** button on the remote.

Press **TEST TONE** button.

- Test tone will be produced as follows: When playing a DVD or CD, this will work only in Stop mode.
- Use this function to check that each speaker is correctly connected and that there is no problem.

To end the test tone, press **TEST TONE** button again.

L: Front Speaker (L) C: Center Speaker SW: Subwoofer
 R: Front Speaker (R) SL: Rear Speaker (L) SR: Rear Speaker (R)

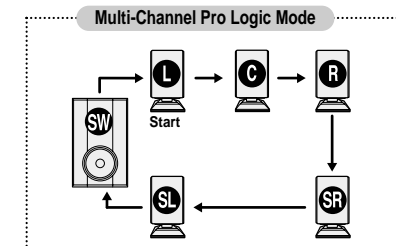

Setting the Delay Time

If the speakers cannot be placed at equal distances from the listening position, you can adjust the delay time of the audio signals from the center and rear speakers.

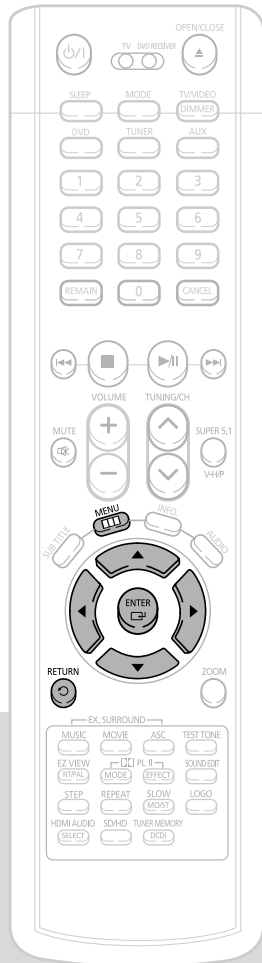

1 In Stop mode, press **MENU** button.



2 Press Cursor **▼** button to move to 'Audio' and then press **ENTER** button.



3 Press Cursor **▼** button to move to 'DELAY TIME' and then press **ENTER** button.

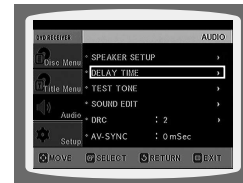

4 Press Cursor **▲, ▼, ◀, ▶** buttons to move to the desired speaker and then press **ENTER** button.



5 Press Cursor **◀, ▶** to set the Delay time.



- You can set the delay time for C between 00 and 05mSEC and for SL and SR between 00 and 15mSEC.

Setting up the Speaker Delay Time

When 5.1CH Surround Sound is played, you can enjoy the best sound if the distance between you and each speaker is the same. Since the sounds arrive at the listening position at different times depending on the placement of speakers, you can adjust this difference by adding a delay effect to the sound of the Center Speaker and Surround Speakers.

Note

- With **DOLBY** (Dolby Pro Logic II), the delay time may be different for each mode.
- With AC-3 and DTS, the delay time can be set between 00 and 15mSEC.
- The Center channel is only adjustable on 5.1 channel discs.

• Setting CENTER SPEAKER

If the distance of D_c is equal to or longer than the distance of D_f in the figure, set the mode as 0ms. Otherwise, change the setting according to the table.

Distance between D_f and D_c	Delay Time
0.00 m	0 ms
0.34 m	1 ms
0.68 m	2 ms
1.02 m	3 ms
1.36 m	4 ms
1.70 m	5 ms

• Setting REAR (SURROUND) SPEAKERS

If the distance of D_f is equal to the distance of D_s in the figure, set the mode as 0ms. Otherwise, change the setting according to the table.

Distance between D_f and D_s	Delay Time
0.00 m	0 ms
1.02 m	3 ms
2.04 m	6 ms
3.06 m	9 ms
4.08 m	12 ms
5.10 m	15 ms

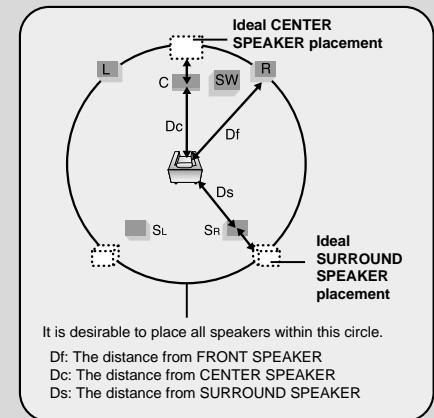

Setting the Audio Quality

You can adjust the balance and level for each speaker.

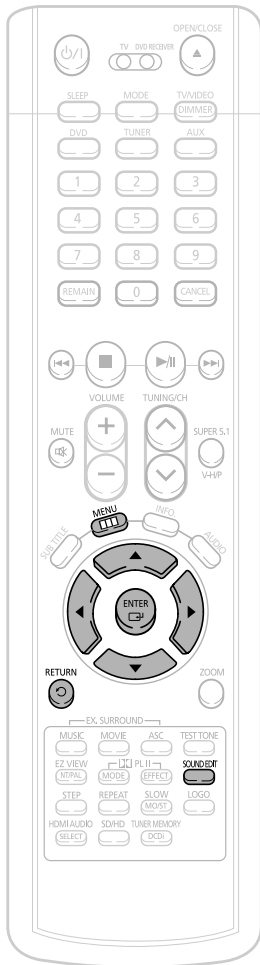



Method 1 When adjusting the audio quality using the setup screen

- 1** In Stop mode, press **MENU** button.

- 2** Press Cursor **▼** button to move to 'Audio' and then press **ENTER** button.

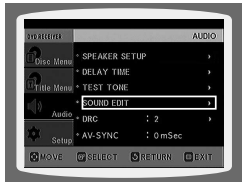
- 3** Press Cursor **▼** button to move to 'SOUND EDIT' and then press **ENTER** button.



- 4** Press Cursor **▲, ▼** buttons to select and adjust the desired item. Press the **◀, ▶** buttons to adjust the settings.



Method 2 When manually adjusting with the SOUND EDIT button

- Adjusting Front Speaker Balance**

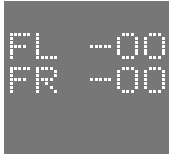
1 Press **SOUND EDIT** button and then press Cursor **◀, ▶**.

- Adjusting Rear Speaker Balance**

2 Press **SOUND EDIT** button and then press Cursor **◀, ▶**.

- Adjusting Center Speaker Level**

3 Press **SOUND EDIT** button and then press Cursor **◀, ▶**.

- Adjusting Rear Speaker Level**

4 Press **SOUND EDIT** button and then press Cursor **◀, ▶**.

- Adjusting Subwoofer Speaker Level**

5 Press **SOUND EDIT** button and then press Cursor **◀, ▶**.



Press **RETURN** button to return to the previous level.

Press **MENU** button to exit the setup screen.

Note

- The adjustments will appear on the main unit's display, not on your TV screen.

Adjusting Front/Rear Speaker Balance

- You can select between 00 and -06 and OFF.
- The volume decreases as you move closer to -6.

Adjusting Center/Rear/Subwoofer Speaker Level

- The volume level can be adjusted in steps from +6dB to -6dB.
- The sound gets louder as you move closer to +6dB and quieter as you get closer to -6dB.

Setting the DRC (Dynamic Range Compression)

You can use this function to enjoy Dolby Digital sound when watching movies at low volume at night.

1 In Stop mode, press **MENU** button.



2 Press Cursor **▼** button to move to 'Audio' and then press **ENTER** button.



3 Press Cursor **▼** button to move to 'DRC' and then press **ENTER** button.



4 Press Cursor **▲, ▼** to adjust the 'DRC'.

- When the Cursor **▲** button is pressed, the effect is greater, and when the Cursor **▼** button is pressed, the effect is smaller.

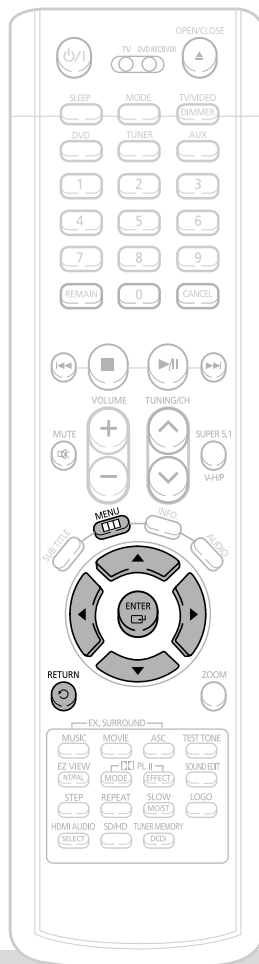
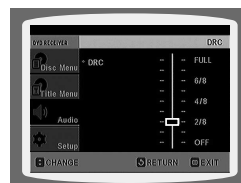

AV SYNC Setup

Video may look slower than the audio if it is connected to a digital TV. If this occurs, adjust the audio delay time to match the video.

1 Press the **MENU** button.

- Setup menu appears.



2 Press Cursor **▲, ▼** buttons to move to 'Audio' and then press **ENTER** button.

- 'Audio' menu appears.

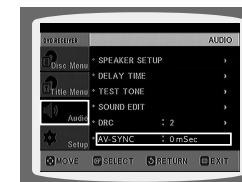

3 Press Cursor **▲, ▼** buttons to move to 'AV-SYNC' and then press **ENTER** button.

- AV-SYNC screen appears.

4 Press Cursor **▲, ▼** buttons to select the AV-SYNC Delay Time and then press the **ENTER** button.

- You can set the audio delay time between 0 ms and 300 ms. Set it to the optimal status.

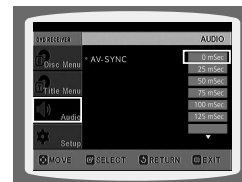

Press **RETURN** button to return to the previous level.

Press **MENU** button to exit the setup screen.

Press **RETURN** button to return to the previous level.

Press **MENU** button to exit the setup screen.

Dolby Pro Logic II Mode

You can select the desired Dolby Pro Logic II audio mode.

Press **PL II MODE** button.

- Each time the button is pressed, the mode changes as follows.

PRO LOGIC II

- **MUSIC:** When listening to music, you can experience sound effects as if you are listening to the actual performance.
- **CINEMA:** Adds realism to the movie soundtrack.
- **PRO LOGIC:** You will experience a realistic multi-channel effect, as if using five speakers, while using just the front left and right speakers.
- **MATRIX:** You will hear simulated 5.1 channel surround sound.
- **STEREO:** Select this to listen to sound from the front left and right speakers and the subwoofer only.

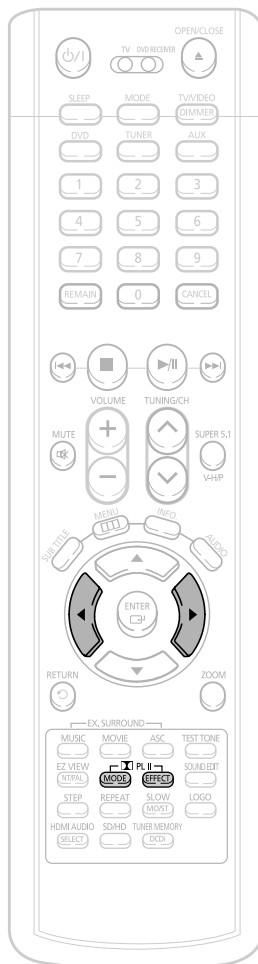

Note

- When selecting Pro Logic II mode, connect your external device to the AUDIO INPUT jacks (L and R) on the player. If you connect to only one of the inputs (L or R), you cannot listen to surround sound.

Dolby Pro Logic II Effect

This function works only in Dolby Pro Logic MUSIC mode.

1 Press **PL II MODE** button to select 'MUSIC' mode.



2 Press **PL II EFFECT** button to select Panorama, then press Cursor **◀**, **▶** buttons to select the desired effect setting.

- You can select either 0 or 1.
- This mode extends the front stereo image to include the surround speakers for an exciting "wraparound" effect with side wall imaging.



3 Press **PL II EFFECT** button to select C-Width, then press Cursor **◀**, **▶** buttons to select the desired effect setting.

- You can select between 0 and 7.
- This sets the width of the center image. The higher the setting, the less sound comes from the center speaker.



4 Press **PL II EFFECT** button to select Dimension, then press the Cursor **◀**, **▶** buttons to select the desired setting.

- You can select between 0 and 6.
- Incrementally adjusts the sound field (DSP) from the front or rear.

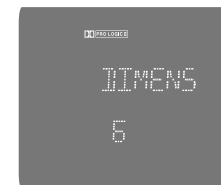

Note

- When playing a DVD disc encoded with two or more channels, multi-channel mode will be selected automatically and **PL II** (Dolby Pro Logic II) button does not work.

Auto Sound Calibration Setup

* This function is available only for DVD/CD playback.

Auto Sound Calibration

By setting the auto sound calibration function just once when you relocate or install the unit, you can have the unit automatically recognize the distance between speakers, levels between channels, and frequency characteristics to create a 5.1-channel sound field optimized for the listener's environment.

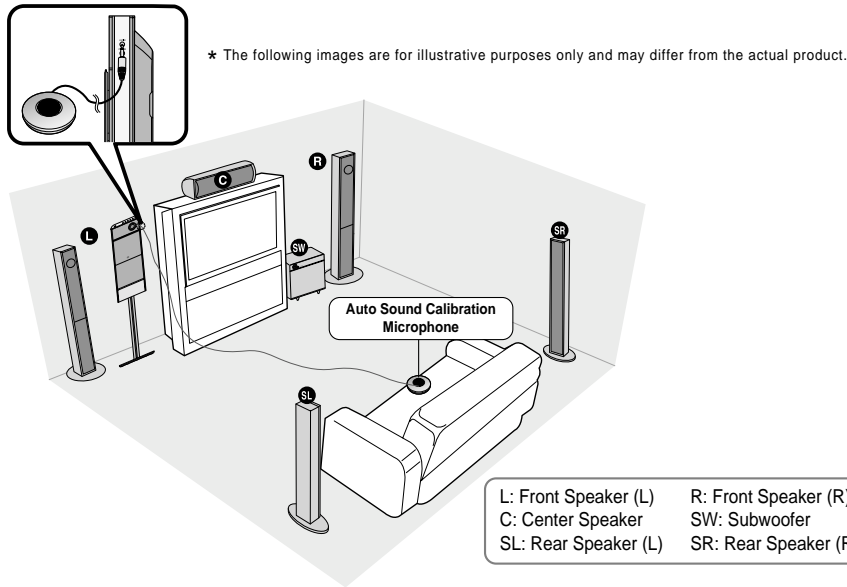

Note

- If you purchased the unit for the first time or initialized it, pressing the Auto Sound Calibration button without connecting the auto sound calibration microphone will display the message "PLEASE SET ASC FUNCTION FIRST" in the display.
- Because the volume level of the tone is fixed during the auto sound calibration setup, you cannot adjust the volume using the volume control buttons.
- If the auto sound microphone is disconnected during the auto sound calibration setup, the setup will be cancelled.

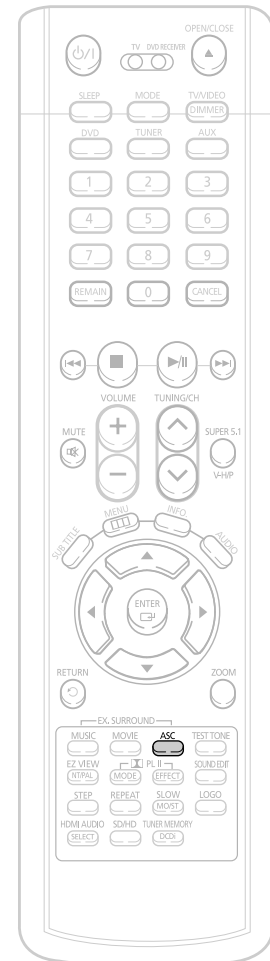

1 Plug the auto sound calibration microphone into the auto sound calibration input jack.

2 Place the auto sound calibration microphone at the listener's position.

3 Adjust the volume control on the main unit as follows:

- If the distance between the listener and the speaker is over 5 m: Set the main unit's volume to over 25.
- If the distance between the listener and the speaker is 3 to 5 m: Set the main unit's volume to 25.
- If the distance between the listener and the speaker is less than 3 m: Set the main unit's volume to 15.

4 Press ASC button.

- To create the optimal 5.1 channel sound field, the selections are in the following sequence: L → C → R → SR → SL → SW
- The auto sound calibration setup takes about 2 minutes to complete.



A tone is output.



A result for each speaker is displayed.

• A bell sounds and the setup finishes.

5 When the message "REMOVE MIC" appears in the display, unplug the auto sound calibration microphone.

To Turn the Sound Logo On/Off

When you turn on the power, the unit produces a sound logo after the disc is read to notify that the unit is optimized for playback.

- 1 Press and hold **ASC** button.
 - "S.LOGO ON" or "S.LOGO OFF" appears in the display.
- 2 Briefly press **ASC** button.
 - Each time the button is pressed, the selection alternates between **S.LOGO ON** and **S.LOGO OFF**.
 - If you select "S.LOGO ON", a sound logo will be output when the disc reading is finished after power-on. If you select "S.LOGO OFF", no sound logo will be output.

To Verify the Auto Sound Calibration

- 1 Press and hold **ASC** button twice.
 - "ASC CHECK" appears in the display.
- 2 Briefly press **ASC** button.
 - Distance and level values specified for each channel will appear in the display.

To cancel the auto sound calibration setup, press ASC button.

- The tone output stops, "CANCEL ASC" appears in the display followed by "REMOVE MIC", and the setup is cancelled.

To listen in the auto sound calibration mode, briefly press ASC button.

- The selection alternates between **ASC ON** and **ASC OFF** in the display.
- If you select "ASC ON", you will hear sound in the auto sound calibration mode.
- If you select "ASC OFF", you will hear sound in the mode set in the audio setting of the setup screen.

Live Surround Mode

SUPER 5.1

You can reproduce a 2-channel sound source, such as CD, and radio broadcast, in 5.1-channel surround sound.

Press **SUPER5.1** button.

- Each time the button is pressed, the selection alternates between **SUPER 5.1** and **SUPER OFF**.
- Select "**SUPER 5.1**" to play 2-channel sound in 5.1 channels.

MUSIC

If you press the **MUSIC** button when listening to a 2-channel sound source, it will be reproduced in 4.1-channel surround sound so that you can enjoy a dynamic sound with a sense of presence.

Press **MUSIC** button.

- Each time the button is pressed, the selection changes as follows: **CONCERT1** → **CONCERT2** → **JAZZ CLUB** → **CATHEDRAL** → **BYPASS**.

MOVIE

You can select from 4 different sound field modes for movies.

Press **MOVIE** button.

- Each time the button is pressed, the selection changes as follows: **VIRTUAL 9.1** → **EX.MOVIE** → **CINEMA** → **SPORTS** → **BYPASS**.
- **VIRTUAL 9.1**: Provides surround sound effect for audiences at home that simulates 9.1 channel surround sound of a movie theater.

Note

- When you insert a DVD recorded in 2-channel or multi-channel format and press the SUPER 5.1 button, the message "**THIS FUNCTION APPLIES ONLY 2CH SOURCE**" appears in the display and it will not work.
- This function does not work with SACD or DVD-AUDIO discs.
- 5.1 channel outputs are available in VIRTUAL 9.1 or EX. MOVIE mode only.

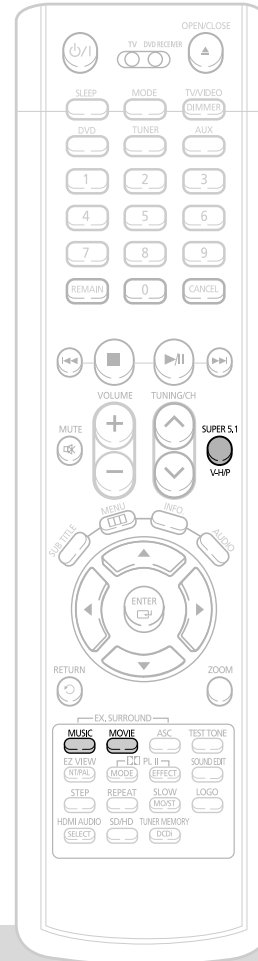

Virtual Headphone Function

Use headphones (not supplied) for private listening pleasure. You can enjoy dynamic sound effects similar to that of 5.1 channel surround sound using conventional stereo headphones.

1 Plug the headphones into the headphone jack.

- You can purchase headphones from most Electronics stores.

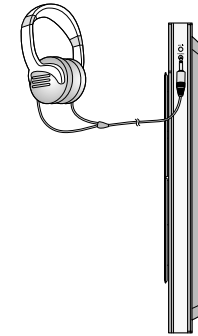

2 Press **V-H/P** button.

- Each time the button is pressed, the selection alternates between **V-H/P ON** and **V-H/P OFF**.

Note

- Do not listen at extremely high volume levels when using headphones. Extended, high-volume listening can lead to permanent hearing loss.

- **VIRTUAL HEADPHONE ON**: Select to enjoy a 5.1-channel surround sound that gives the feeling of being in a baseball park or concert hall.
- **VIRTUAL HEADPHONE OFF**: Select to listen to a standard 2-channel stereo sound.

Listening to Radio

Remote Control Unit

1 Press **TUNER** button.

2 Tune in to the desired station.

Automatic Tuning 1 When **◀▶▶▶▶** is pressed, a preset broadcast station is selected.

Automatic Tuning 2 Press and hold **TUNING/CH** to automatically search for active broadcasting stations.

Manual Tuning Briefly press **TUNING/CH** to increase or decrease the frequency incrementally.

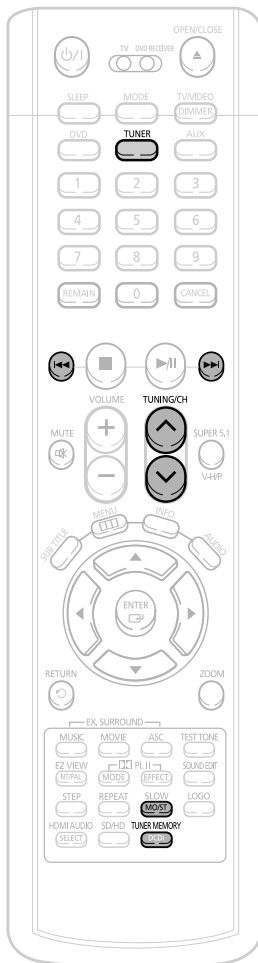

Main Unit

1 Press the **Function** button to select the desired band (FM).

2 Select a broadcast station.

Automatic Tuning 1 Press the **STOP** (■) button to select PRESET and then press **◀▶▶▶▶** button to select the preset station.

Automatic Tuning 2 Press the **STOP** (■) button to select "MANUAL" and then press and hold **◀▶▶▶▶** button to automatically search the band.

Manual Tuning Press **STOP** (■) to select MANUAL and then briefly press **◀▶▶▶▶** to tune in to a lower or higher frequency.

Presetting Stations

You can store up to: 15 FM stations

Example: Presetting FM 89.1 in the memory

1 Press the **TUNER** button and select the FM band.



2 Press **TUNING/CH** to select "89.10".

- Refer to Step 2 on page 69 to automatically or manually tune in to a station.

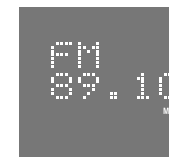

3 Press the **TUNER MEMORY** button.

- "PRGM" flashes in the display.



4 Press **◀▶▶▶▶** to select preset number.

- You can select between 1 and 15.



5 Press the **TUNER MEMORY** button again.

- Press the **TUNER MEMORY** button before 'PRGM' disappears from the display.
- 'PRGM' disappears from the display and the station is stored in memory.

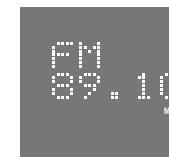

6 To preset another station, repeat steps 2 to 5.

Press **MO/ST** button to listen in Mono/Stereo.

- Each time the button is pressed, the sound switches between "STEREO" and "MONO".
- In a poor reception area, select MONO for a clear, interference-free broadcast.

To tune in to a preset station, press **◀▶▶▶▶** on the remote control to select a channel.

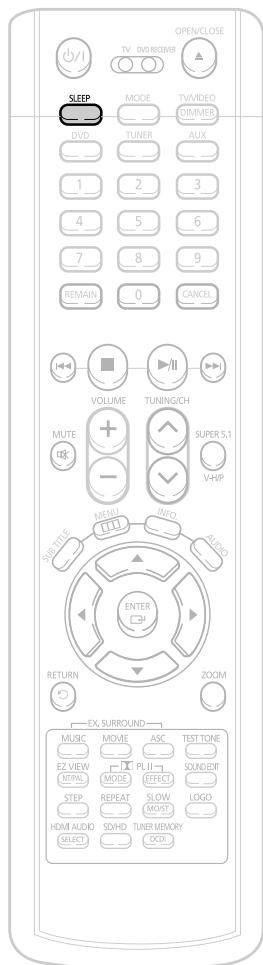

Sleep Timer Function

You can set the time that the DVD player will shut itself off.

Press **SLEEP** button.

- "SLEEP" will be displayed. Each time the button is pressed the preset time changes as follows: **10 → 20 → 30 → 60 → 90 → 120 → 150 → OFF**.

SLEEP 10

To confirm the sleep timer setting, press **SLEEP** button.

- The remaining time before the DVD player will shut itself off is displayed.
- Pressing the button again changes the sleep time from what you have set earlier.

To cancel the sleep timer, press **SLEEP** button until **OFF** appears on the display.

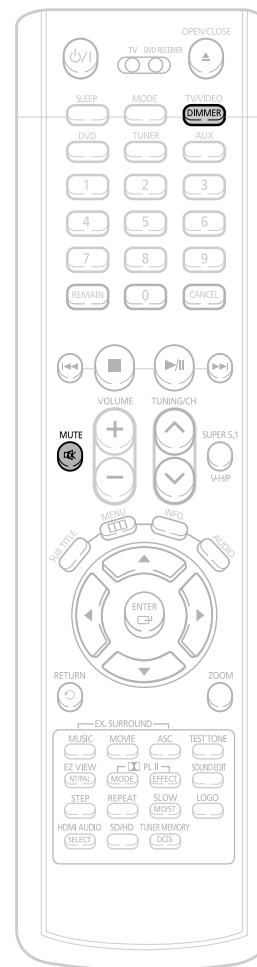

Adjusting Display Brightness

You can adjust the brightness of the display on the main unit so it won't interfere with your movie viewing.

Press **DIMMER** button.

- Each time the button is pressed, the brightness changes as follows: **DARK → BRIGHT**.

Mute Function

This is useful when answering a doorbell or telephone call.

Press **MUTE** button.

- 'MUTE' flash in the display.
- To switch the sound back on (at the same volume as before), press **MUTE** again or the **VOLUME** buttons.

MUTE

Operating a TV with the Remote Control

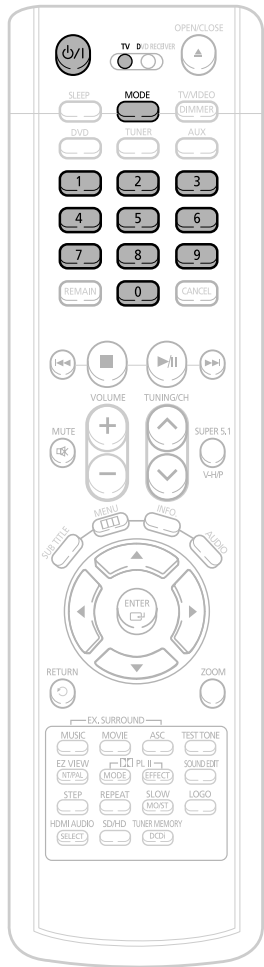

When operating a TV with the remote control

1 Press the **MODE** button to make the TV indicator on the remote control flash.



2 Press **POWER** button to turn on the TV.

3 Point the remote control toward the TV.

4 While holding down **POWER**, enter the code corresponding to your brand of TV.

- If the code matches the TV's code, the TV will be turned off.
- If there is more than one code listed for your TV in the table, enter one at a time to determine which code works.

Example: For a Samsung TV

While holding down **POWER**, use the number buttons to enter 00, 01, 02, 03, 04, and 05.

5 Point the remote control toward the TV and press **POWER**. If the TV turns off or on, the setting is complete.

- You can use the TV **POWER**, **VOLUME**, **CHANNEL**, and **Numeric** buttons (0-9).

Note

- The remote control may not work on some brands of TVs. Also some operations may not be possible depending on your brand of TV.
- If you do not set the remote control with the code for your brand of TV, the remote control will work on a Samsung TV by default.

TV Brand Code List

No.	Brand	Code	No.	Brand	Code
1	SAMSUNG	00(Initial Value), 01, 02, 03, 04, 05, 73	30	BRANDT	41
2	ANAM	06-11, 59	31	FERGUSON	41
3	DAEWOO	12-18, 20, 21	32	PIONEER	41, 48, 74
4	LG	05, 20, 21, 22, 53	33	TELEAVA	41
5	HITACHI	23, 40, 41, 49	34	FINLUX	05, 42, 47
6	JVC	24, 55	35	FISHER	31
7	SHARP	27, 33, 34, 35, 54	36	AKAI	31
8	SONY	27, 36	37	YOKO	05
9	TOSHIBA	27, 37, 42, 43, 44, 46	38	PHONOLA	05, 45, 47
10	SANYO	27, 30, 31, 32	39	RADIOLA	05, 45
11	MITSUBISHI	05, 27, 28	40	SCHNEIDER	05
12	MATSUSHITA	09, 26	41	NEWSAN	58
13	TELEFUNKEN	41, 49, 51, 57	42	CONTINENTAL EDISON	49
14	RCA	29, 61	43	SALORA	48
15	PANASONIC	07, 09, 26, 48, 49, 50	44	SELECO	48
16	SABA	40, 41, 47, 48, 49	45	NOKIA	48
17	PHILIPS	05, 45, 47, 64, 65, 66, 67, 68, 69	46	REX	48
18	GRUNDIG	39, 42, 46, 70, 71, 72	47	MIVAR	46
19	ZENITH	38	48	IMPERIAL	46
20	MIVAL	52	49	CGE	46
21	NOBLEX	56	50	BANG & OLUFSEN	47
22	EMERSON	19	51	BRIONVEGA	47
23	MAGNAVOX	25	52	FORMENTI	47
24	LOEWE	05, 60	53	METZ	47
25	THOMSON	40, 41, 49, 62, 63	54	WEGA	47
26	NORDMENDE	40, 41, 49	55	RADIOMARELLI	47
27	LOEWE OPTA	36, 47, 05	56	SINGER	47
28	BLAUPUNKT	39	57	SINUDYNE	47
29	SIEMENS	39			

Before Calling for Service

Refer to the chart below when this unit does not function properly. If the problem you are experiencing is not listed below or if the instruction below does not help, turn off the unit, disconnect the power cord, and contact the nearest authorized dealer or Samsung Electronics Service Center.

Symptom	Check/Remedy
Disc tray does not open.	<ul style="list-style-type: none"> • Is the power cord plugged securely into the outlet? • Turn off the power and then turn it back on.
Playback does not start.	<ul style="list-style-type: none"> • Check the region number of the DVD. DVD discs purchased from abroad may not be playable. • CD-ROMs and DVD-ROMs cannot be played on this DVD player. • Make sure that the rating level is correct.
Playback does not start immediately when the Play/Pause button is pressed.	<ul style="list-style-type: none"> • Are you using a deformed disc or a disc with scratches on the surface? • Wipe the disc clean.
Sound is not produced.	<ul style="list-style-type: none"> • No sound is heard during fast playback, slow playback, and step motion playback. • Are the speakers connected properly? Is the speaker setup correctly customized? • Is the disc severely damaged?
Sound can be heard only from a few speakers and not all six.	<ul style="list-style-type: none"> • When listening to a CD or radio, sound is output to the front speakers (L/R) only. Select "PRO LOGIC II" by pressing PL II (Dolby Pro Logic II) on the remote control to use all six speakers. • Make sure that the DVD disc is 5.1-CH compatible. • If you set C, SL, and SR to NONE in the speaker mode in the audio setup of the setup screen, no sound is heard from the center speaker and the front left and right speakers. Set C, SL, and SR to SMALL.
Picture does not appear, sound is not produced, or the disc tray opens 2 to 5 seconds later.	<ul style="list-style-type: none"> • Was the DVD player suddenly moved from a cold place to a warm one? When condensation forms inside the player, remove the disc and let the player stand for 1 or 2 hours with the power on. (You can use the player again after condensation disappears.)
Dolby Digital 5.1 CH Surround Sound is not produced.	<ul style="list-style-type: none"> • Is there "Dolby Digital 5.1 CH" mark on the disc? Dolby Digital 5.1 CH Surround Sound is produced only if the disc is recorded with 5.1 channel sound. • Is the audio language correctly set to DOLBY DIGITAL 5.1-CH in the information display?

Symptom	Check/Remedy
<ul style="list-style-type: none"> • Disc is rotating but no picture is produced. • Picture quality is poor and picture is shaking. 	<ul style="list-style-type: none"> • Is the TV power on? • Are the video cables connected properly? • Is the disc dirty or damaged? • A poorly manufactured disc may not be playable.
The remote control does not work.	<ul style="list-style-type: none"> • Is the remote control being operated within its operation range of angle and distance? • Are the batteries exhausted?
Audio language and subtitles do not work.	<ul style="list-style-type: none"> • Audio language and subtitles will not work for DVDs not containing them. And depending on the disc, they may work differently.
Menu screen does not appear even when the menu function is selected.	<ul style="list-style-type: none"> • Are you using a disc that does not contain menus?
Aspect ratio cannot be changed.	<ul style="list-style-type: none"> • You can play 16:9 DVDs in 16:9 WIDE mode, 4:3 LETTER BOX mode, or 4:3 PAN SCAN mode, but 4:3 DVDs can be seen in 4:3 ratio only. Refer to the DVD disc jacket and then select the appropriate function.
Can't receive radio broadcast.	<ul style="list-style-type: none"> • Is the antenna connected properly? • If the antenna's input signal is weak, install an external FM antenna in an area with good reception.
<ul style="list-style-type: none"> • The main unit is not working. (Example: The power goes out or strange noise is heard.) • The DVD player is not working normally. 	<ul style="list-style-type: none"> • Turn off the power and hold the button on the main unit for longer than 5 seconds. <p>Using the RESET function will erase all stored settings. Do not use this unless necessary.</p>
The password for rating level has been forgotten.	<ul style="list-style-type: none"> • While "NO DISC" message appears on the display of main unit, hold the main unit's button for longer than 5 seconds. "INITIALIZE" appears on the display and all settings will return to the default values. • Press the POWER button. <p>Using the RESET function will erase all stored settings. Do not use this unless necessary.</p>

Cautions on Handling and Storing Discs

Small scratches on the disc may reduce sound and picture quality or cause skipping. Be especially careful not to scratch discs when handling them.

● Handling discs

Do not touch the playback side of the disc.
Hold the disc by the edges so that fingerprints will not get on the surface.
Do not stick paper or tape on the disc.

● Disc Storage

<p>Do not keep in direct sunlight</p> 	<p>Keep in a cool ventilated area</p> 	<p>Keep in a clean Protection jacket. Store vertically.</p> 
--	--	--

Caution

- Do not allow the discs to become contaminated with dirt.
- Do not load cracked or scratched discs.

● Handling and Storing Discs

When you get fingerprints or dirt on the disc, clean it with a mild detergent diluted in water and wipe with a soft cloth.

- When cleaning, wipe gently from the inside to the outside of the disc.

Note

- Condensation may form if warm air comes into contact with cold parts inside the player. When condensation forms inside the player, the player may not operate correctly. If this occurs, remove the disc and let the player stand for 1 or 2 hours with the power on.

Language Code List

Enter the appropriate code number for the initial settings "Disc Audio", "Disc Subtitle" and/or "Disc Menu" (See page 45).

Code	Language	Code	Language	Code	Language	Code	Language
1027	Afar	1181	Frisian	1334	Latvian, Lettish	1506	Slovenian
1028	Abkhazian	1183	Irish	1345	Malagasy	1507	Samoan
1032	Afrikaans	1186	Scots Gaelic	1347	Maori	1508	Shona
1039	Amharic	1194	Galician	1349	Macedonian	1509	Somali
1044	Arabic	1196	Guarani	1350	Malayalam	1511	Albanian
1045	Assamese	1203	Gujarati	1352	Mongolian	1512	Serbian
1051	Aymara	1209	Hausa	1353	Moldavian	1513	Siswati
1052	Azerbaijani	1217	Hindi	1356	Marathi	1514	Sesotho
1053	Bashkir	1226	Croatian	1357	Malay	1515	Sundanese
1057	Byelorussian	1229	Hungarian	1358	Maltese	1516	Swedish
1059	Bulgarian	1233	Armenian	1363	Burmese	1517	Swahili
1060	Bihari	1235	Interlingua	1365	Nauru	1521	Tamil
1069	Bislama	1239	Interlingue	1369	Nepali	1525	Tegulu
1066	Bengali; Bangla	1245	Inupiak	1376	Dutch	1527	Tajik
1067	Tibetan	1248	Indonesian	1379	Norwegian	1528	Thai
1070	Breton	1253	Icelandic	1393	Occitan	1529	Tigrinya
1079	Catalan	1254	Italian	1403	(Afan) Oromo	1531	Turkmen
1093	Corsican	1257	Hebrew	1408	Oriya	1532	Tagalog
1097	Czech	1261	Japanese	1417	Punjabi	1534	Setswana
1103	Welsh	1269	Yiddish	1428	Polish	1535	Tonga
1105	Danish	1283	Javanese	1435	Pashto, Pushto	1538	Turkish
1109	German	1287	Georgian	1436	Portuguese	1539	Tsonga
1130	Bhutani	1297	Kazakh	1463	Quechua	1540	Tatar
1142	Greek	1298	Greenlandic	1481	Rhaeto-Romance	1543	Twi
1144	English	1299	Cambodian	1482	Kirundi	1557	Ukrainian
1145	Esperanto	1300	Kannada	1483	Romanian	1564	Urdu
1149	Spanish	1301	Korean	1489	Russian	1572	Uzbek
1150	Estonian	1305	Kashmiri	1491	Kinyarwanda	1581	Vietnamese
1151	Basque	1307	Kurdish	1495	Sanskrit	1587	Volapuk
1157	Persian	1311	Kirghiz	1498	Sindhi	1613	Wolof
1165	Finnish	1313	Latin	1501	Sangro	1632	Xhosa
1166	Fiji	1326	Lingala	1502	Serbo-Croatian	1665	Yoruba
1171	Faeroese	1327	Laothian	1503	Singhalese	1684	Chinese
1174	French	1332	Lithuanian	1505	Slovak	1697	Zulu

USB Host Feature Supported Products

Digital Camera

Product	Company	Type
PowerShot A70	Canon	Digital Camera
A90	Canon	Digital Camera
IXY40	Canon	Digital Camera
IXY50	Canon	Digital Camera
A90	Canon	Digital Camera
A95	Canon	Digital Camera
G6	Canon	Digital Camera
S60	Canon	Digital Camera
Exilom Z-40	Casio	Digital Camera
QV-R51	Casio	Digital Camera
Finepix-A340	Fuji	Digital Camera
Finepix-F810	Fuji	Digital Camera
Finepix-F610	Fuji	Digital Camera
Finepix-F450	Fuji	Digital Camera
Finepix S7000	Fuji	Digital Camera
Finepix A310	Fuji	Digital Camera
Easy Save CX-4300	Kodak	Digital Camera
KD-310Z	Konica	Digital Camera
Finecam SL300R	Kyocera	Digital Camera
Finecam SL400R	Kyocera	Digital Camera
Finecam SSR	Kyocera	Digital Camera
Finecam Xt	Kyocera	Digital Camera
Dimage-Z1	Minolta	Digital Camera
Dimage Z1	Minolta	Digital Camera
Dimage X21	Minolta	Digital Camera
Coolpix4200	NIKON	Digital Camera
Coolpix4300	NIKON	Digital Camera
Coolpix 2200	Nikon	Digital Camera
Coolpix 3500	Nikon	Digital Camera
Coolpix 3700	Nikon	Digital Camera
Coolpix 4100	Nikon	Digital Camera
Coolpix 5200	Nikon	Digital Camera
stylus 410 digital	Olympus	Digital Camera
300-digital	Olympus	Digital Camera
u300	Olympus	Digital Camera
X-350	Olympus	Digital Camera
C-760	Olympus	Digital Camera
C-5060	Olympus	Digital Camera
X1	Olympus	Digital Camera
u-mini	Olympus	Digital Camera
Lumix-FZ20	Panasonic	Digital Camera
DMC-FX7GD	Panasonic	Digital Camera

Product	Company	Type
Lumix LC33	Panasonic	Digital Camera
LUMIX DMC-F1	Panasonic	Digital Camera
Optio-S40	Pentax	Digital Camera
Optio-S50	Pentax	Digital Camera
Optio 33LF	Pentax	Digital Camera
Optio 33L	Pentax	Digital Camera
Optio X	Pentax	Digital Camera
S₩ø	Pentax	Digital Camera
Optio MX	Pentax	Digital Camera
Digimax-420	Samsung	Digital Camera
Digimax-400	Samsung	Digital Camera
Kenox UX4	Samsung	Digital Camera
VPC-AZ1	Sanyo	Digital Camera
Not recognize in PC		
DSC-F828	Sony	Digital Camera
DSC-P73	Sony	Digital Camera
DSC-T1	Sony	Digital Camera
DSC-F88	Sony	Digital Camera
DSC-M1	Sony	Digital Camera
DSC-W1	Sony	Digital Camera
DSC-T3	Sony	Digital Camera
Sora PDR-T30	Toshiba	Digital Camera
Coolpix 5900	Nikon	Digital Camera
Coolpix S1	Nikon	Digital Camera
Coolpix 7600	Nikon	Digital Camera
DMC-FX7	Panasonic	Digital Camera
DMC-LS1	Panasonic	Digital Camera
DMC-LZ2	Panasonic	Digital Camera
IXY-Digital600	Canon	Digital Camera
S5i	Pentax	Digital Camera
Dimage Xt	Minolta	Digital Camera
AZ-1	Olympus	Digital Camera
DSC-W5	Sony	Digital Camera

USB Flash Disk

Product	Company	Type
Cruzer Micro	SanDisk	USB2.0 USB Flash Drive 128M
Cruzer Mini	SanDisk	USB2.0 128M
Cruzer Mini	SanDisk	USB2.0 256M
SONY Micro Vault	SONY	USB2.0 64MB
FLEX DRIVE	serotech	USB2.0 32MB
AnyDrive	A.L tech	USB2.0 128MB
XTICK	LG	USB2.0 128M
Micro Mini	IOMEGA	USB2.0 128M
iFlash	Imation	USB2.0 64M
LG	XTICK(M)	USB2.0 64M
RIDATA	EZDrive	USB2.0 64M

MP3 Player

Product	Company	Type
Creative MuVo NX128M	Creative	128 MB MP3 Player
Iriver H320	Iriver	20G HDD MP3 player
yepp YH-920	samsung	20G HDD MP3 player
yepp YH-925	samsung	20G HDD MP3 player
i-pod	apple	HDD MP3 player(40G)
i-pod mini	Apple	HDD MP3 Player(20G)
yepp (YP-T7)	samsung	MP3 Player
yepp(YP-MT6)	samsung	MP3 Player
yepp(YP-T6)	samsung	MP3 Player
yepp(YP-53)	samsung	MP3 Player
yepp(YP-ST5)	samsung	MP3 Player
yepp(YP-T5)	samsung	MP3 Player
yepp(YP-60)	samsung	MP3 Player
yepp(YP-780)	samsung	MP3 Player
yepp(YP-35)	samsung	MP3 Player
yepp(YP-55)	samsung	MP3 Player
iAUDIO U2	COWON(Korea)	MP3 Player
iAUDIO G3	COWON(Korea)	MP3 Player
iAudio M3	COWON(Korea)	HDD MP3 player
SI-M500L	SHARP(Japan)	256MB MP3Player
H10	IRIVER(Korea)	MP3Player
YEPP YP-T5 VB	Samsung(Korea)	MP3Player
YEPP YP-53	Samsung(Korea)	256MB MP3Player

Multi Card Reader

Product	Company	Type
UNICORN	Unicom	USB 2.0 7 IN 1 CARD READER UC-601R
USB2.0 Card Reader	Billinton(Taiwan)	USB 2.0 Card Reader for SD/MMC/RS-MMC(3-in-1)

USB External HDD

Product	Company	Type
CUTIE	serotech	POCKET HARD DISK DRIVE
MOMOBAY UX-2	DVICO	USB2.0

GENERAL	Power Consumption	MAIN UNIT : 30W SUBWOOFER : 100W		
	Weight	MAIN UNIT : 2.8kg		
		VERTICAL STAND : 8.0kg		
	Dimensions (W x H x D)	MAIN UNIT : 183 x 500 x 82 mm		
		WITH STAND : 328 x 1200 x 328 mm		
Operating Temperature Range	5°C ~ 35°C			
Operating Humidity Range	10% ~ 75%			
TUNER	Usable Sensitivity	10dB		
	S/N Ratio	60dB		
	Distortion	0.5%		
VIDEO OUTPUT	Composite Video	1.0Vp-p(75Ω load)		
	Component Video	Y:1.0Vp-p(75Ω load)		
		Pr:0.70Vp-p(75Ω load)		
		Pb:0.70Vp-p(75Ω load)		
HDMI	Impedance: 85~115Ω			
AMPLIFIER	Front speaker output	130W x 2(3Ω)		
	Center speaker output	130W(3Ω)		
	Rear speaker output	130W x 2(3Ω)		
	Subwoofer speaker output	150W(3Ω)		
	Frequency range	20Hz~20kHz		
	S/N Ratio	70dB		
	Channel separation	60dB		
	Input sensitivity	(AUX)500mV		
SPEAKERS	Speaker system	5.1ch speaker system		
		Front/Center/Rear speaker	Subwoofer speaker	
	Impedance	3Ω x 5	3Ω	
	Frequency range	110Hz~20kHz	20Hz~200Hz	
	Output sound pressure level	84dB/W/M	86dB/W/M	
	Rated input	130W	150W	
	Maximum input	260W	300W	
	Dimensions (W x H x D)	Front/Rear	105.6 x 1310 x 76 mm	270 x 498 x 379.5 mm
		Center	550 x 110 x 78 mm	
	Weight	Front/Rear	6.2kg	13kg
Center		2.9kg		