

HT-C5500

HT-C5530

HT-C5550

5.1CH Blu-ray  
Home Cinema System  
user manual

imagine the possibilities

Thank you for purchasing this Samsung product.

To receive more complete service,  
please register your product at



[www.samsung.com/register](http://www.samsung.com/register)

**SAMSUNG**

# Safety Information

## Safety Warnings

TO REDUCE THE RISK OF ELECTRIC SHOCK, DO NOT REMOVE THE COVER(OR BACK).  
NO USER-SERVICEABLE PARTS ARE INSIDE. REFER SERVICING TO QUALIFIED SERVICE PERSONNEL.

	<div style="border: 1px solid black; padding: 5px; text-align: center;"> <b>CAUTION</b>  <small>RISK OF ELECTRIC SHOCK DO NOT OPEN</small> </div>	
<p>This symbol indicates “dangerous voltage” inside the product that presents a risk of electric shock or personal injury.</p>	<p><b>CAUTION</b> : TO PREVENT ELECTRIC SHOCK, MATCH WIDE BLADE OF PLUG TO WIDE SLOT, FULLY INSERT.</p>	<p>This symbol indicates important instructions accompanying the product.</p>

### WARNING

- To reduce the risk of fire or electric shock, do not expose this appliance to rain or moisture.

### CAUTION

- Apparatus shall not be exposed to dripping or splashing and no objects filled with liquids, such as vases, shall be placed on the apparatus.
- The Mains plug is used as a disconnect device and shall stay readily operable at any time.
- This apparatus shall always be connected to a AC outlet with a protective grounding connection.
- To disconnect the apparatus from the mains, the plug must be pulled out from the mains socket, therefore the mains plug shall be readily operable.

**CLASS 1      LASER PRODUCT**  
**KLASSE 1    LASER PRODUKT**  
**LUOKAN 1    LASER LAITE**  
**KLASS 1      LASER APPARAT**  
**PRODUCTO   LÁSER CLASE 1**

### **CLASS 1 LASER PRODUCT**

This Compact Disc player is classified as a CLASS 1 LASER product. Use of controls, adjustments or performance of procedures other than those specified herein may result in hazardous radiation exposure.

### CAUTION

- INVISIBLE LASER RADIATION WHEN OPEN AND INTERLOCKS DEFEATED, AVOID EXPOSURE TO BEAM.

## Wiring the Main Power Supply Plug (UK Only)

### **IMPORTANT NOTICE**

The mains lead on this equipment is supplied with a moulded plug incorporating a fuse. The value of the fuse is indicated on the pin face of the plug and if it requires replacing, a fuse approved to BS1362 of the same rating must be used. Never use the plug with the fuse cover removed. If the cover is detachable and a replacement is required, it must be of the same colour as the fuse fitted in the plug. Replacement covers are available from your dealer. If the fitted plug is not suitable for the power points in your house or the cable is not long enough to reach a power point, you should obtain a suitable safety approved extension lead or consult your dealer for assistance. However, if there is no alternative to cutting off the plug, remove the fuse and then safely dispose of the plug. Do not connect the plug to a mains socket as there is a risk of shock hazard from the bared flexible cord. Never attempt to insert bare wires directly into a mains socket. A plug and fuse must be used at all times.

### **IMPORTANT**

The wires in the mains lead are coloured in accordance with the following code:- BLUE = NEUTRAL BROWN = LIVE As these colours may not correspond to the coloured markings identifying the terminals in your plug, proceed as follows:-The wire coloured BLUE must be connected to the terminal marked with the letter N or coloured BLUE or BLACK. The wire coloured BROWN must be connected to the terminal marked with the letter L or coloured BROWN or RED.

**WARNING : DO NOT CONNECT EITHER WIRE TO THE EARTH TERMINAL WHICH IS MARKED WITH LETTER E OR BY THE EARTH SYMBOL , OR COLOURED GREEN OR GREEN AND YELLOW.**

## Precautions

- Ensure that the AC power supply in your house complies with the identification sticker located on the back of your product.
- Install your product horizontally, on a suitable base (furniture), with enough space around it for ventilation (7.5~10cm).
- Do not place the product on amplifiers or other equipment which may become hot. Make sure the ventilation slots are not covered.
- Do not stack anything on top of the product.
- Before moving the product, ensure the Disc Insert Hole is empty.
- In order to disconnect the product completely from the power supply, remove the main plug from the wall outlet, especially when left unused for a long period of time.
- During thunderstorms, disconnect the AC main plug from the wall outlet. Voltage peaks due to lightning could damage the product.
- Do not expose the product to direct sunlight or other heat sources. This could lead to overheating and malfunction of the product.
- Protect the product from moisture, and excess heat or equipment creating strong magnetic or electric fields (i.e. speakers.).
- Disconnect the power cable from the AC supply if the product malfunctions.
- Your product is not intended for industrial use. Use of this product is for personal use only.
- Condensation may occur if your product or disc has been stored in cold temperatures. If transporting the product during the winter, wait approximately 2 hours until the product has reached room temperature before using.
- The batteries used with this product contain chemicals that are harmful to the environment. Do not dispose of batteries in the general household trash.

# Safety Information

## Cautions on Handling and Storing Discs

Small scratches on the disc may reduce sound and picture quality or cause skipping.

Be especially careful not to scratch discs when handling them.

## Holding discs

- Do not touch the playback side of the disc.
- Hold the disc by the edges so that fingerprints will not get on the surface.
- Do not stick paper or tape on the disc.



## Disc Storage

- Do not keep in direct sunlight
- Keep in a cool ventilated area
- Keep in a clean Protection jacket.  
Store vertically.

### NOTE

- Do not allow the discs to become contaminated with dirt.
- Do not load cracked or scratched discs.

## Handling and Storing Discs

If you get fingerprints or dirt on the disc, clean it with a mild detergent diluted in water and wipe with a soft cloth.

- When cleaning, wipe gently from the inside to the outside of the disc

### NOTE

- Condensation may form if warm air comes into contact with cold parts inside the product. When condensation forms inside the product, it may not operate correctly. If this occurs, remove the disc and let the product stand for 1 or 2 hours with the power on.

## Licence

- This product incorporates copyright protection technology that is protected by U.S. patents and other intellectual property rights. Use of this copyright protection technology must be authorized by Rovi Corporation, and is intended for home and other limited viewing uses only unless otherwise authorized by Rovi Corporation. Reverse engineering or disassembly is prohibited.

- ABOUT DIVX VIDEO: DivX® is a digital video format created by DivX, Inc. This is an official DivX Certified device that plays DivX video. Visit [www.divx.com](http://www.divx.com) for more information and software tools to convert your files into DivX video. ABOUT DIVX VIDEO-ON-DEMAND: This DivX Certified® device must be registered in order to play DivX Video-on-Demand (VOD) content. To generate the registration code, locate the DivX VOD section in the device setup menu. Go to [vod.divx.com](http://vod.divx.com) with this code to complete the registration process and learn more about DivX VOD.



DivX Certified to play DivX video up to HD 1080p, including premium content.

- iPod is a trademark of Apple Inc., registered in the U.S. and other countries.



iPhone is a trademark of Apple Inc.

- Manufactured under licence from Dolby Laboratories. Dolby, Pro Logic and the double-D symbol are trademarks of Dolby Laboratories.
- < Open Source Licence Notice >  
In the case of using open source software, Open Source Licences are available on the product menu.

## Copyright

© 2010 Samsung Electronics Co., Ltd. All rights reserved.

# Contents

## SAFETY INFORMATION

2

- 2 Safety Warnings
- 3 Precautions
- 4 Cautions on Handling and Storing Discs
- 4 Licence
- 4 Copyright

## GETTING STARTED

7

- 7 Icons that will be used in manual
- 8 Disc Types and Characteristics
- 12 Accessories
- 13 Description
  - 13 Front Panel
  - 14 Rear Panel
- 15 Remote control

## CONNECTIONS

17

- 17 Connecting the Speakers
- 20 Connecting the Optional Wireless Receiver Module
- 22 Connecting External Devices/your TV via HDMI
- 24 Connecting the Video Out to your TV
- 25 Connecting Audio from External Components
- 26 Connecting to the Network
- 27 Connecting the FM Antenna

## SETUP

28

- 28 Before Starting (Initial Settings)
- 29 Setting the Menu
- 30 Display
  - 30 TV Aspect
  - 30 BD Wise
  - 30 Resolution
  - 32 HDMI Format
  - 32 Movie Frame (24 Fs)
  - 32 Progressive Mode
  - 32 Still Mode
  - 32 HDMI Deep Color
- 33 Audio
  - 33 Speaker Setting
  - 34 Musical Auto Calibration
  - 34 EQ Optimizer
  - 34 HDMI Audio
  - 35 Digital Output
  - 36 Dynamic Range Control
  - 36 AV Sync
- 36 System
  - 36 Initial Settings
  - 36 Internet@TV Screen Size
  - 36 Anynet+(HDMI-CEC)
  - 36 BD Data Management
  - 37 Clock
  - 37 DivX(R) Registration
  - 37 DivX(R) Deactivation
- 38 Network Setup
  - 38 Network Settings
  - 41 Network Status
  - 41 BD-LIVE Internet Connection
- 41 Language
- 42 Security
  - 42 Parental Rating
  - 42 Change Password

# Contents

## SETUP

42

- 42 General
- 42 Background
- 42 Energy Saving
- 42 Front Display
- 42 Power On/Off Sound
- 43 Support
- 43 Software Upgrade
- 43 Contact Samsung

## BASIC FUNCTIONS

44

- 44 Playing a Disc
- 44 Using the Disc menu / Title menu / Popup menu
- 45 Using the Search and Skip Functions
- 46 Slow Motion Play/Step Motion Play
- 46 Repeat Playback
- 47 Using the TOOLS button
- 49 Listening to Music
- 51 Sound Mode
- 52 Playing back a Picture
- 53 Playing back a USB Storage
- 53 Listening to Radio
- 55 Using an iPod

## NETWORK SERVICES

57

- 57 Using Internet@TV
- 61 BD-LIVE™
- 61 Software Upgrade Notification
- 61 Using the AllShare Function

## OTHER INFORMATION





















63

- 63 Troubleshooting
- 66 Specifications

- Figures and illustrations in this User Manual are provided for reference only and may differ from actual product appearance.

## Icons that will be used in manual

Make sure to check the following terms before reading the user manual.

Term	Logo	Icon	Definition
BD-ROM			This involves a function available on a BD-ROM.
BD-RE/-R			This involves a function available on a BD-RE/-R disc recorded in the BD-RE format.
DVD-VIDEO			This involves a function available on a DVD-VIDEO.
DVD-RW(V)			This involves a function available on recorded DVD+RW or DVD-RW(V)/DVD-R/+R discs that have been recorded and finalised.
DVD-R			
DVD+RW			
DVD+R			
Audio CD			This involves a function available on an audio CD-RW/-R (CD-DA format).
MP3 WMA	-		This involves a function available in a CD-RW/-R, DVD-RW/-R disc or a USB storage media containing MP3 or WMA contents.
JPEG	-		This involves a function available in a CD-RW/-R, DVD-RW/-R disc or a USB storage media containing JPEG contents.
DivX MKV MP4	 DivX		This involves a function available in a CD-RW/-R, DVD-RW/-R disc or a USB storage media containing DivX contents.
USB storage device	-		This involves a function available on a USB storage device.
CAUTION	-		This involves a situation where a function does not operate or settings may be cancelled.
NOTE	-		This involves tips or instructions on the page that help each function operate.
Shortcut Key	-		This function provides direct and easy access pressing the button on the remote control.

- This product is compatible with the PAL colour system only.
- NTSC discs will not play.

# Getting Started

## Disc Types and Characteristics

### Blu-ray Disc Compatibility

Blu-ray is a new and evolving format. Accordingly, disc compatibility issues are possible. Not all discs are compatible and not every disc will play back. For additional information, refer to the Disc Types and Characteristics section of this Manual. If you encounter compatibility problems, please contact the SAMSUNG customer care centre.

#### NOTE

- Playback may not work for some types of discs, or when specific operations, such as angle change and aspect ratio adjustment, are being performed. Information about the discs is written in detail on the box. Please refer to this if necessary.
- Do not allow the disc to become dirty or scratched. Fingerprints, dirt, dust, scratches or deposits of cigarette smoke on the recording surface may make it impossible to use the disc for playback.
- When a BD-Java title is played, loading may take longer than a normal title, or some functions may perform slowly.









### Discs that cannot be played

- HD DVD Disc
- DVD-RAM
- 3.9 GB DVD-R Disc for Authoring.
- DVD-RW(VR mode)
- Super Audio CD(except CD layer)
- DVD-ROM/PD/MV-Disc, etc CVD/CD-ROM/CDV/CD-G/CD-I/LD
- CDGs play audio only, not graphics.

#### NOTE

- Some commercial discs and DVD discs purchased outside your region may not be playable with this product. When these discs are played, either "Cannot read this disc. Please check the regional code of the disc." will be displayed.
- If a DVD-RV-RW disc has not been recorded properly in DVD video format, it will not be playable.



## Logos of Discs that can be played

	
Blu-ray Disc	Dolby Digital Plus
	
PAL broadcast system in U.K, France, Germany, etc.	Dolby TrueHD
	
DTS-HD High Resolution Audio	Java
	
DTS-HD Master Audio   Essential	BD-LIVE



## Region code

Both the product and the discs are coded by region. These regional codes must match in order to play the disc. If the codes do not match, the disc will not play.

Disc Type	Region Code	Area
Blu-ray		North America, Central America, South America, Korea, Japan, Taiwan, Hong Kong and South East Asia.
		Europe, Greenland, French territories, Middle East, Africa, Australia and New Zealand.
		India, China, Russia, Central and South Asia.
DVD-VIDEO		The U.S., U.S. territories and Canada
		Europe, Japan, the Middle East, Egypt, South Africa, Greenland
		Taiwan, Korea, the Philippines, Indonesia, Hong Kong
		Mexico, South America, Central America, Australia, New Zealand, Pacific Islands, Caribbean
		Russia, Eastern Europe, India, most of Africa, North Korea, Mongolia
		China

## Disc Types

### BD-ROM

Blu-ray Disc Read Only Memory. A BD-ROM disc contains pre-recorded data. Although a BD-ROM may contain any form of data, most BD-ROM discs will contain movies in High Definition format, for playback on the product. This product can play back pre-recorded commercial BD-ROM discs.

### BD-RE/BD-R

Blu-ray Disc Rewritable/Blu-ray Disc Recordable. BD-RE/BD-R is the ideal format for making backups, or recording personal video.

### DVD-VIDEO

- A digital versatile disc (DVD) can contain up to 135-minutes of images, 8 audio languages and 32 subtitle languages. It is equipped with MPEG-2 picture compression and Dolby Digital surround, allowing you to enjoy vivid and clear quality images.
- When switching from the first layer to the second layer of a dual-layered DVD Video disc, there may be momentary distortion in the image and sound. This is not a malfunction of the product.
- Once a DVD-RW/-R recorded in Video Mode is finalised, it becomes DVD-Video. Pre-recorded (pre-stamped) commercial DVDs with movies are also referred to as DVD-Videos. This product can play back pre-recorded commercial DVD discs (DVD-Video discs) with movies.

### DVD-R/-RW

- Once a DVD-R/-RW recorded in Video Mode is finalised, it becomes DVD-Video. Ability to play back may depend on recording conditions.
- This product can play back DVD-R disc recorded and finalised with a Samsung DVD video recorder.
- Playback can be performed with DVD-RW discs in the Video Mode and finalised only.

### DVD+RW

- This product can play back a DVD+RW disc recorded with a DVD Video recorder. Ability to play back may depend on recording conditions.

### DVD+R

- This product can play back a DVD+R disc recorded and finalised with a DVD Video recorder. Ability to play back may depend on recording conditions.

# Getting Started

## Audio CD

- An audio disc on which 44.1kHz PCM Audio is recorded.
- This product can play back CD-DA format audio CD-R and CD-RW discs.
- The product may not be able to play some CD-R or CD-RW discs due to the condition of the recording.

## CD-R/-RW

- Use a 700MB(80 minutes) CD-R/-RW disc. If possible, do not use a 800MB(90 minutes) or above disc, as the disc may not play back.
- If the CD-R/-RW disc was not recorded as a closed session, you may experience delays when playing back the beginning of the disc or all recorded files may not play.
- Some CD-R/-RW discs may not be playable with this product, depending on the device which was used to burn them. For contents recorded on CD-R/-RW media from CDs for your personal use, playability may vary depending on contents and discs.

## Disc Format

### Using MP3 disc

- CD-R/-RW, DVD-RW/-R recorded with UDF, ISO9660 or JOLIET format can be played back.
- Only MP3 files with the ".mp3" or ".MP3" extension can be played.
- Playable bit rate range is from 56 Kbps to 320 Kbps.
- Playable sample-rate is 32KHz to 48KHz.
- The product can handle a maximum of 1500 files and folders under a parent folder. For MP3 files recorded with a VBR(Variable Bit Rates), the sound may cut in and out.

### Using JPEG disc

- CD-R/-RW, DVD-RW/-R recorded with UDF, ISO9660 or JOLIET format can be played back.
- Only JPEG files with the ".jpg", ".JPG", ".jpeg" or ".JPEG" extension can be displayed.
- Progressive JPEG is supported.

### DVD-RW/-R (V)

- This is a format that is used for recording data on a DVD-RW or DVD-R disc. The disc can be played by this product once it has been finalised.
- If a disc that has been recorded in Video Mode by a different maker's recorder but has not been finalised, it cannot be played by this product.

## DivX(Digital Video Express)

DivX is a video file format developed by Microsoft and is based on MPEG4 compression technology to provide audio and video data over the Internet in real-time.

MPEG4 is used for video encoding and MP3 for audio encoding so that the users can watch a movie at near DVD-quality video and audio.

## Supported Formats(DivX)

This product only supports the following media formats. If both video and audio formats are not supported, the user may experience problems such as broken images or no sound.

### Supported Video Formats

Format	Supported Versions
AVI	DivX3.11~DivX5.1, XviD

### Supported Audio Formats

Format	Bit Rate	Sampling Frequency
MP3	80~384kbps	44.1khz
AC3	128~384kbps	44.1/48khz
DTS	1.5Mbps	44.1khz

- DivX files, including audio and video files, created in the DTS format can only support up to 6Mbps.
- Aspect Ratio : Although the default DivX resolution is 640x480 pixels (4:3), this product supports up to 800x600 pixels (16:9). TV screen resolutions higher than 800 will not be supported.
- When you play a disc whose sampling frequency is higher than 48khz or 320kbps, you may experience shaking on the screen during playback.
- Qpel and gmc is not supported.

## MKV, MP4

- CD-R/-RW, DVD-R/-RW, USB, PC streaming
- Video Files with the following extensions can be played. : .avi, .divx, .mkv, .mp4, .AVI, .DIVX, .MKV, .MP4

### NOTE

- Some DivX, MKV and MP4 format discs may not play, depending on the video resolution and frame rate condition.

## Supported File Formats

### Video File Support

File Extension	Container	Video Codec	Audio Codec	Resolution
*.avi	AVI	Divx 3.11/4.x/5.1/6.0	MP3	1920x1080
		XviD	AC3	1920x1080
		MP4v3	DTS	1920x1080
		H.264 BP/MP/HP	WMA PCM	1920x1080
*.mkv	MKV	VC-1 AP(wmv1)	MP3 AC3 DTS	1920x1080
		DivX 5.1/6.0		1920x1080
		XviD		1920x1080
		H.264 BP/MP/HP		1920x1080
*.wmv	WMV	VC-1 AP	WMA	1920x1080
		VC-1 SM		1920x1080
*.mp4	MP4	MP4 (mp4v)	AAC	1920x1080
		H.264 BP/MP/HP		1920x1080
*.mpg *.mpeg	PS	MPEG1	MP1, 2 AC3 DTS	1920x1080
		MPEG2		1920x1080
		H.264 BP/MP/HP		1920x1080

### Music File Support

File Extension	Container	Audio Codec	Support Range
*.mp3	MP3	MP3	-
*.wma	WMA	WMA	Compliant with WMA version 10 * Sampling rates (in kHz) - 8, 11, 16, 22, 32, 44.1, 48 * Bit rates - All bit-rates in the range 5kbps to 384kbps

# Getting Started

## USB Host Specification

### USB Host Specification

- Supports USB 1.1 or USB 2.0 compliant devices.
- Supports devices connected using the USB A type cable.
- Supports UMS (USB Mass Storage Device) V1.0 compliant devices.
- Supports FAT(FAT, FAT16, FAT32) file system formatting.

### Non-compliance

- Does not support a device that requires installing a separate driver on the PC (Windows).
- Does not support connection to a USB hub.
- A USB device that is connected using an USB extension cable may not be recognized.

### Operational Limitations

- If the connected device has multiple drives (or partitions) installed, only one drive (or partition) can be connected.
- A device supporting USB 1.1 alone may cause a difference in the picture quality, depending on the device.

### Supported file Formats

Format	Still Picture	Music
File name	JPG	MP3
File extension	JPG .JPEG	.MP3
Bit rate	–	80~384kbps
Version	–	–
Pixel	640x480	–
Sampling Frequency	–	44.1kHz







- CBI (Control/Bulk/Interrupt) is not supported.
- Digital Cameras that use PTP protocol or require additional program installation when connected to a PC are not supported.
- A device using the NTFS file system is not supported. (Only the FAT 16/32 (File Allocation Table 16/32) file system is supported.)
- Does not operate with Janus enabled MTP (Media Transfer Protocol) devices.

### USB Devices that can be used with the product

1. USB Storage Device
2. MP3 Player
3. Digital Camera
4. Removable HDD
  - Removable HDDs equipped with less than 160 Gbytes are supported. Removable HDDs equipped with 160Gbytes or more may not be recognized, depending on the device.
  - If the connected device does not work due to insufficient power supply, you can use a separate power cable to supply power so that it can work properly. The USB cable connector may differ, depending on the manufacturer of the USB device.
5. USB card Reader: One slot USB card reader and Multi-slot USB card reader.
  - The USB card reader may not be supported, depending on the manufacturer.
  - If you install multiple memory devices into a multi-card reader, you may experience problems.

## Accessories

Check for the supplied accessories below.

					
Video Cable	FM Antenna	iPod Dock	User's Manual	Remote Control/ Batteries (AAA size)	ASC Microphone

## Description

## Front Panel

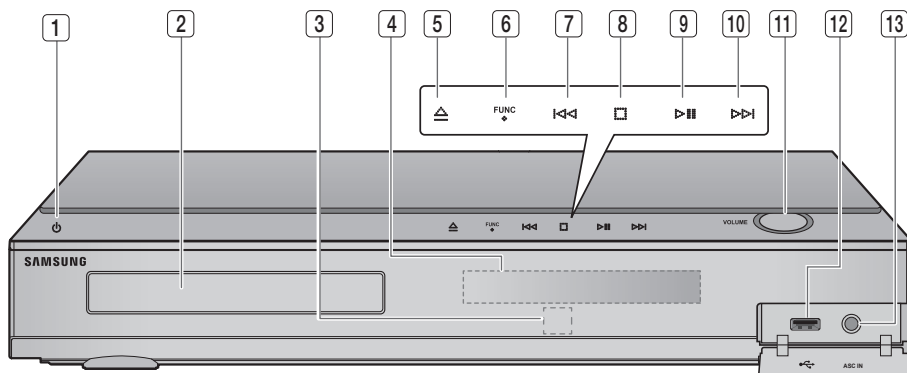

1	POWER BUTTON (🔌)	Turns the product on and off.
2	DISC TRAY	Insert disc here.
3	REMOTE CONTROL SENSOR	Detects signals from the remote control.
4	DISPLAY	Displays the playing status, time, etc.
5	OPEN/CLOSE BUTTON	Opens and closes the disc tray.
6	FUNCTION BUTTON	The mode switches as follows : <b>BD/DVD → D. IN → AUX → HDMI 1 → HDMI 2 → FM</b>
7	TUNING DOWN & SKIP BUTTON	Goes back to the previous title/chapter/track. Tunes down the FM frequency band.
8	STOP BUTTON	Stops disc playback.
9	PLAY/PAUSE BUTTON	Plays a disc or pauses playback.
10	TUNING UP & SKIP BUTTON	Goes to the next title/chapter/track. Tunes up the FM frequency band.
11	VOLUME CONTROL	Volume adjustment.
12	USB PORT	A USB storage device can be connected here and used as storage when connected to BD-LIVE. It can also be used for software upgrades and MP3/JPEG/DivX/MKV/MP4 playback.
13	ASC IN JACK	Used to connect the ASC Microphone for setting up MAC(Musical Auto Calibration).

NOTE

- Software upgrades using the USB Port must be performed with a USB memory flash stick only.
- A USB device consuming more than 500mA requires a separate power supply device for normal operation.
- A USB HDD device cannot be used for BD Data storage (BD-LIVE).

# Getting Started

## Rear Panel

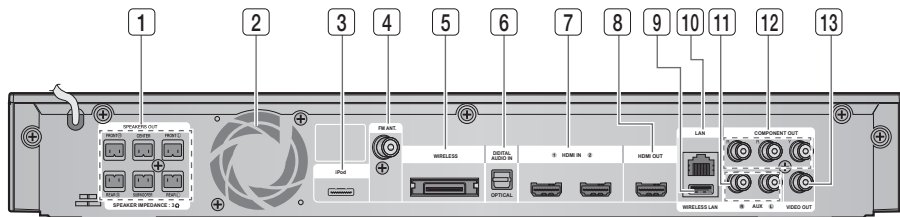

<b>1</b>	<b>5.1 CHANNEL SPEAKER OUTPUT CONNECTORS</b>	Connect the front, centre, surround, subwoofer speakers.
<b>2</b>	<b>COOLING FAN</b>	The cooling fan supplies cool air to the product to prevent overheating and always revolves when the power is on.
<b>3</b>	<b>iPod JACK</b>	Connect the iPod dock connector here.
<b>4</b>	<b>FM 75Ω COAXIAL JACK</b>	Connect the FM antenna.
<b>5</b>	<b>TX CARD CONNECTION (WIRELESS)</b>	The TX card enables communication between the product and the optional wireless receiver module.
<b>6</b>	<b>EXTERNAL DIGITAL OPTICAL IN JACKS (OPTICAL)</b>	Use this to connect external equipment capable of digital output.
<b>7</b>	<b>HDMI IN JACKS</b>	Receives digital video and audio signals simultaneously using an HDMI cable.
<b>8</b>	<b>HDMI OUT JACK</b>	Use an HDMI cable, connect this HDMI output terminal to the HDMI input terminal on your TV for the best quality picture.
<b>9</b>	<b>WIRELESS LAN JACK</b>	Can be used for network based services (see pages 57~62), BD-LIVE and software upgrade with a wireless LAN adapter.
<b>10</b>	<b>LAN TERMINAL</b>	Can be used for network based services (see pages 57~62), BD-LIVE and software upgrade under the network connection.
<b>11</b>	<b>AUX IN JACKS</b>	Connect to the 2CH analogue output of an external device (such as a VCR)
<b>12</b>	<b>COMPONENT VIDEO OUT JACKS</b>	Connect a TV with Component video inputs to these jacks.
<b>13</b>	<b>VIDEO OUT JACK</b>	Connect your TV's Video Input jack (VIDEO IN) to the VIDEO OUT Jack on this product.

### ! CAUTION

- Ensure a minimum of 10 cm of clear space on all sides of the cooling fan when installing the product.
- Do not obstruct the cooling fan or ventilation holes.

## Remote control

### Tour of the Remote Control

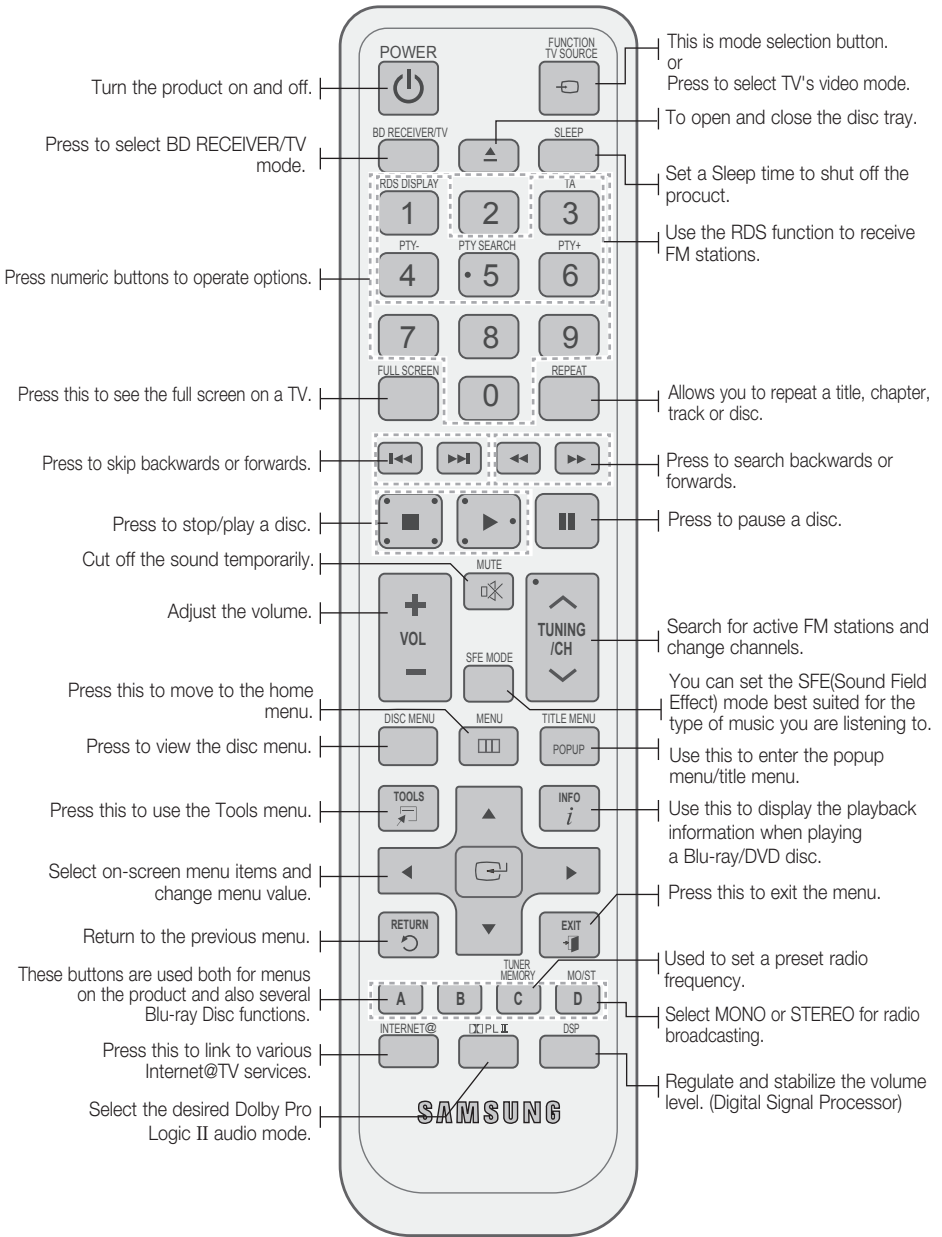

# Getting Started

## Installing batteries in the Remote Control

\* Battery size: AAA

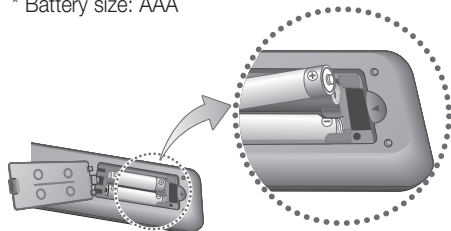

### NOTE

- Make sure to match the “+” and “-” ends of the batteries with the diagram inside the compartment.
- Assuming typical TV usage, the batteries last for about one year.
- The remote control can be used up to approximately 7 meters in a straight line.

## Setting the Remote Control

You can control certain functions of your TV with this remote control.

### When operating a TV with the remote control

1. Press the **BD RECEIVER/TV** button to set the remote control to TV mode.
2. Press the **POWER** button to turn on the TV.
3. While holding down the **POWER** button, enter the code corresponding to your brand of TV.
  - If there is more than one code listed for your TV in the table, enter one at a time to determine which code works.
  - **Example : For a Samsung TV**  
While holding down the **POWER** button, use the number buttons to enter 00, 15, 16, 17 and 40.
4. If the TV turns off, the setting is complete.
  - You can use the TV **POWER**, **VOLUME**, **CHANNEL**, and **Numeric** buttons (0~9).

### NOTE

- The remote control may not work on some brands of TV's. Also, some operations may not be possible, depending on your brand of TV.
- The remote control will work with Samsung TVs by default.

## TV Brand Code List

Brand	Code	Brand	Code
Admiral (M.Wards)	56, 57, 58	Mitsubishi/ MGA	18, 40, 59, 60, 75
A Mark	01, 15	MTC	18
Anam	01, 02, 03, 04, 05, 06, 07, 08, 09, 10, 11, 12, 13, 14	NEC	18, 19, 20, 40, 59, 60
AOC	01, 18, 40, 48	Nikei	03
Bell & Howell (M.Wards)	57, 58, 81	Onking	03
Brocsonic	59, 60	Onwa	03
Candle	18	Panasonic	06, 07, 08, 09, 54, 66, 67, 73, 74
Cetronic	03	Penney	18
Citizen	03, 18, 25	Philco	03, 15, 17, 18, 48, 54, 59, 62, 69, 90
Cinema	97	Philips	15, 17, 18, 40, 48, 54, 62, 72
Classic	03	Pioneer	63, 66, 80, 91
Concerto	18	Portland	15, 18, 59
Contec	46	Proton	40
Coronado	15	Quasar	06, 66, 67
Craig	03, 05, 61, 82, 83, 84	Radio Shack	17, 48, 56, 60, 61, 75
Croslex	62	RCA/ Proscan	18, 59, 67, 76, 77, 78, 92, 93, 94
Crown	03	Realistic	03, 19
Curtis Mates	59, 61, 63	Sampo	40
CXC	03	Samsung	00, 15, 16, 17, 40, 43, 46, 47, 48, 49, 59, 60, 98
Daewoo	02, 03, 04, 15, 16, 17, 18, 19, 20, 21, 22, 23, 24, 25, 26, 27, 28, 29, 30, 32, 34, 35, 36, 48, 59, 90	Sanyo	19, 61, 65
Daytron	40	Scott	03, 40, 60, 61
Dynasty	03	Sears	15, 18, 19
Emerson	03, 15, 40, 46, 59, 61, 64, 82, 83, 84, 85	Sharp	15, 57, 64
Fisher	19, 65	Signature 2000 (M.Wards)	57, 58
Funai	03	Sony	50, 51, 52, 53, 55
Futuretech	03	Soundesign	03, 40
General Electric (GE)	06, 40, 56, 59, 66, 67, 68	Spectricon	01
Hall Mark	40	SSS	18
Hitachi	15, 18, 50, 59, 69	Sylvania	18, 40, 48, 54, 59, 60, 62
Inkel	45	Symphonic	61, 95, 96
JC Penny	56, 59, 67, 86	Tatung	06
JVC	70	Techwood	18
KTV	59, 61, 87, 88	Teknika	03, 15, 18, 25
KEC	03, 15, 40	TMK	18, 40
KMC	15	Toshiba	19, 57, 63, 71
LG (Goldstar)	01, 15, 16, 17, 37, 38, 39, 40, 41, 42, 43, 44	Vidtech	18
Luxman	18	Videch	59, 60, 69
LXI (Sears)	19, 54, 56, 59, 60, 62, 63, 65, 71	Wards	15, 17, 18, 40, 48, 54, 60, 64
Magnavox	15, 17, 18, 48, 54, 59, 60, 62, 72, 89	Yamaha	18
Marantz	40, 54	York	40
Matsui	54	Yupiteru	03
MGA	18, 40	Zenith	58, 79
		Zonda	01
		Dongyang	03, 54



# Connections

This section involves various methods of connecting the product to other external components. Before moving or installing the product, be sure to turn off the power and disconnect the power cord.

## Connecting the Speakers

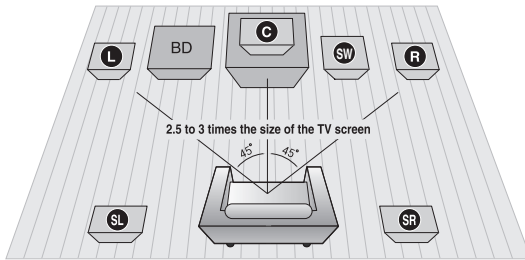

### Position of the product

Place it on a stand or cabinet shelf, or under the TV stand.

### Selecting the Listening Position

The listening position should be located about 2.5 to 3 times the distance of the TV's screen size away from the TV.

Example : For 32" TV's 2~2.4m  
For 55" TV's 3.5~4m

<b>Front Speakers</b> L R	Place these speakers in front of your listening position, facing inwards (about 45°) toward you. Place the speakers so that their tweeters will be at the same height as your ear. Align the front face of the front speakers with the front face of the centre speaker or place them slightly in front of the centre speakers.
<b>Centre Speaker</b> C	It is best to install it at the same height as the front speakers. You can also install it directly over or under the TV.
<b>Surround Speakers</b> SL SR	Place these speakers to the side of your listening position. If there isn't enough room, place these speakers so they face each other. Place them about 60 to 90cm above your ear, facing slightly downward.  * Unlike the front and centre speakers, the surround speakers are used to handle mainly sound effects and sound will not come from them all the time.
<b>Subwoofer</b> SW	The position of the subwoofer is not so critical. Place it anywhere you like.

### ! CAUTION

- Do not let children play with or near the speakers. They could get hurt if a speaker falls.
- When connecting the speaker wires to the speakers, make sure that the polarity (+/-) is correct.
- Keep the subwoofer speaker out of reach of children so as to prevent children from inserting their hands or alien substances into the duct (hole) of the subwoofer speaker.
- Do not hang the subwoofer on the wall through the duct (hole).

### NOTE

- If you place a speaker near your TV set, screen colour may be distorted because of the magnetic field generated by the speaker. If this occurs, place the speaker away from your TV set.

# Connections

## Speaker Components

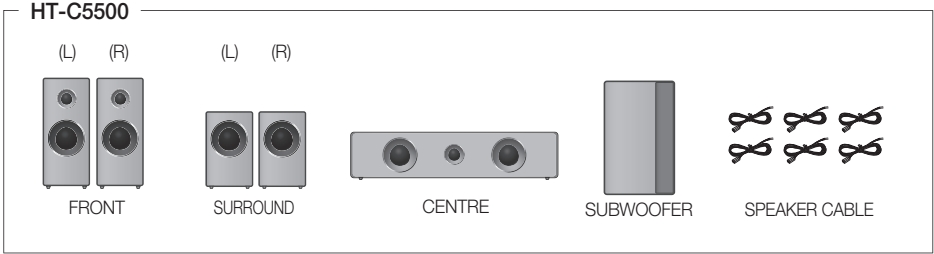

## Speaker Components

## Assembled Speakers

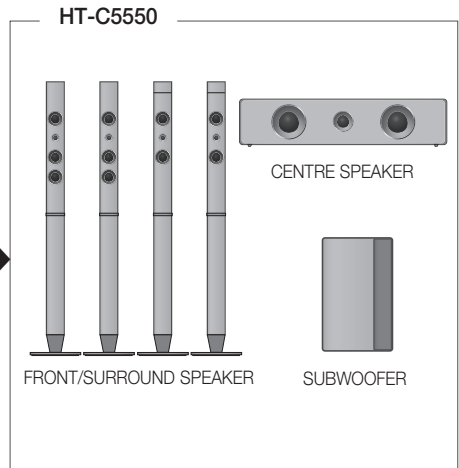
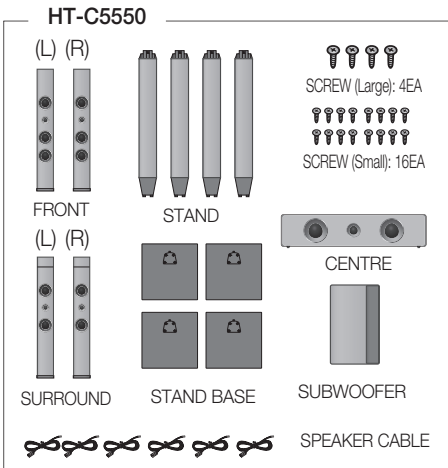
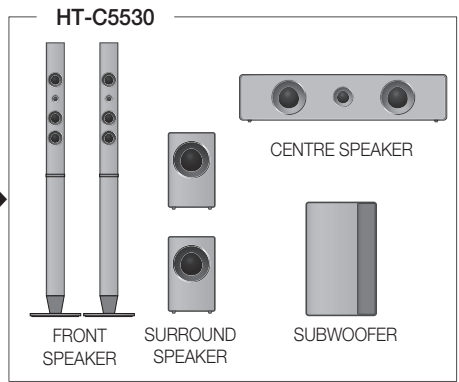
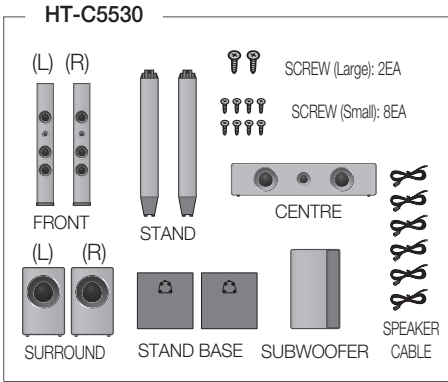

**NOTE**

- Refer to page 19 to install the Speakers on the Tallboy Stand.

## Installing the Speakers on the Tallboy Stand

- \* HT-C5530 only - Front Speakers
- \* HT-C5550 only - Front/Surround speakers

1. Turn the Stand Base upside-down and connect it to the Stand.
2. Insert four small screws clockwise into the four holes marked using a screwdriver as shown in the illustration.
3. Connect the upper Speaker to the assembled Stand.
4. Insert another large screw clockwise into the hole on the rear of the speaker using a screwdriver.

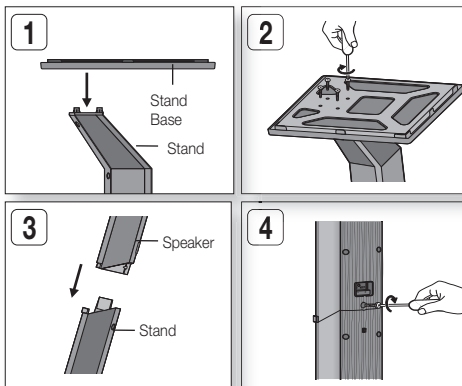

## Connecting The Speakers

1. Press down the terminal tab on the back of the speaker.
2. Insert the black wire into the black terminal (-) and the red wire into the red terminal (+), and then release the tab.
3. Connect the connecting plugs to the back of the product by matching the colours of the speaker plugs to the speaker jacks.

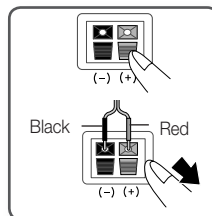

### In case of HT-C5500

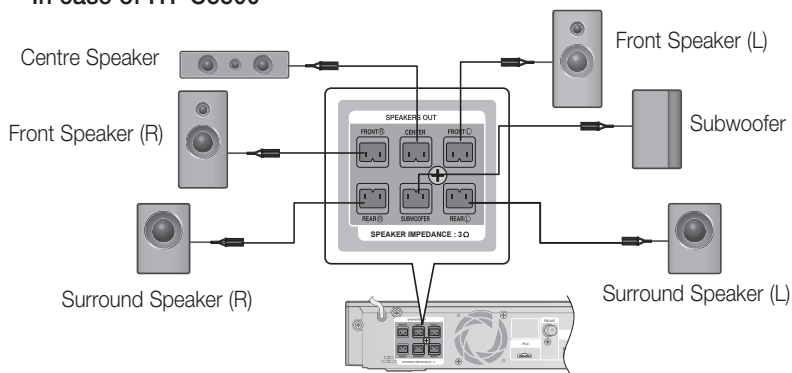

\* Refer to page 18 for the speakers of HT-C5530/C5550.

# Connections

## Connecting the Optional Wireless Receiver Module

To connect the surround speakers wirelessly, you have to purchase the wireless receiver module and TX card from your Samsung retailer.

- This product should be connected with the SWA-5000 only.

### In Case of HT-C5500

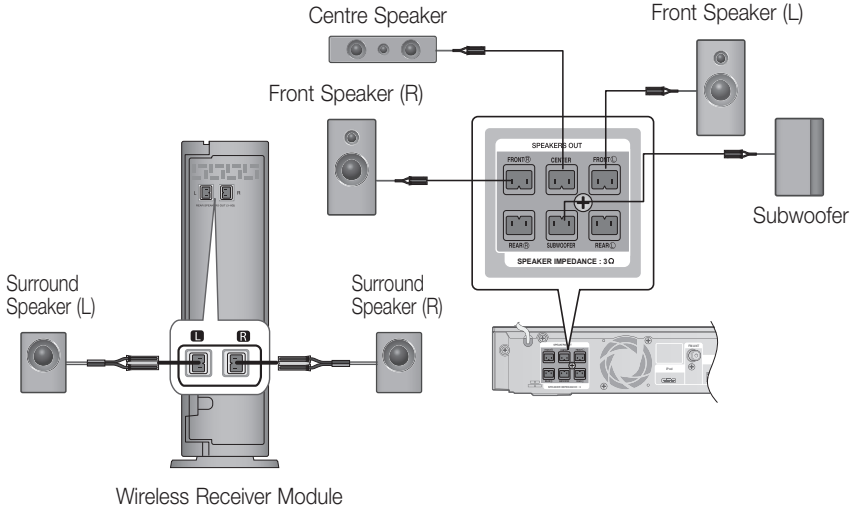

\* Refer to page 18 for the speakers of HT-C5530/C5550.

1. Press down the terminal tab on the back of the speaker.
2. Insert the black wire into the black terminal (-) and the red wire into the red terminal (+), and then release the tab.
3. Connect the connecting plugs to the back of the product by matching the colours of the speaker plugs to the speaker jacks.
4. With the product turned off, insert the TX card into the TX Card Connection (**WIRELESS**) on the back of the product.
  - Hold the TX card so that the label "WIRELESS" faces upward and insert the card into the port.
  - The TX card enables communication between the product and the wireless receiver module.
5. Connect the left and right surround speakers to the wireless Receiver module.
6. Plug the power cord of the wireless Receiver module in the wall outlet .

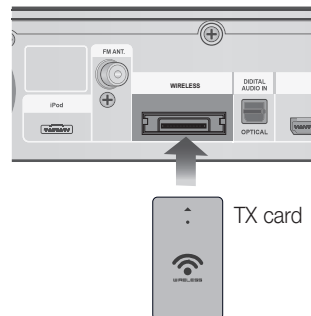
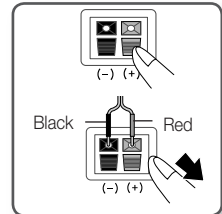

 **NOTE**

- Place the wireless receiver module at the rear of the listening position. If the wireless receiver module is too close to the product, some sound interruption may be heard due to interference.
- If you use a device such as a microwave oven, wireless LAN Card, Bluetooth equipment, or any other device that uses the same frequency (2.4/5.8GHz) near the product, some sound interruption may be heard due to interference.
- The transmission distance from the product to the wireless receiver module is about 10m, but may vary depending on your operating environment. If a steel-concrete wall or metallic wall is between the product and the wireless receiver module, the system may not operate at all, because the radio wave cannot penetrate metal.
- If the product doesn't make wireless connection, the product needs ID Setting between the product and wireless receiver module. With the product turned off, press remote control's number buttons "0"→"1"→"3"→"5" and turn on the product. With the wireless receiver module turned on, press "ID SET" button on the back of the wireless receiver module for 5 seconds.

**! CAUTION**

- Do not insert any other card except the provided TX card.  
If a different TX card is used, the product may be damaged or the card may not be removed easily.
- Do not insert the TX card upside down or in the reverse direction.
- Insert the TX card when the product is turned off. Inserting the card when it is turned on may cause a problem.
- If the TX Card is inserted and wireless receiver module setting is complete, sound is not output from the surround speaker connectors on the product.
- The wireless receiver antenna is built into the wireless receiver module. Keep it away from water and moisture.
- For optimal listening performance, make sure that the area around the wireless receiver module location is clear of any obstructions.
- **If no sound is heard from the wireless receiver module, switch the mode to DVD 5.1 channel or Dolby ProLogic II .**
- In 2-CH mode, no sound will be heard from the wireless receiver module.

# Connections

## Connecting External Devices/your TV via HDMI

HDMI is a standard digital interface for connection to such devices as a TV, projector, DVD player, Blu-ray player, set top box and more.

HDMI removes any loss of signal from analogue conversion, enabling you to enjoy video and audio sound quality as it was originally created in the digital source.

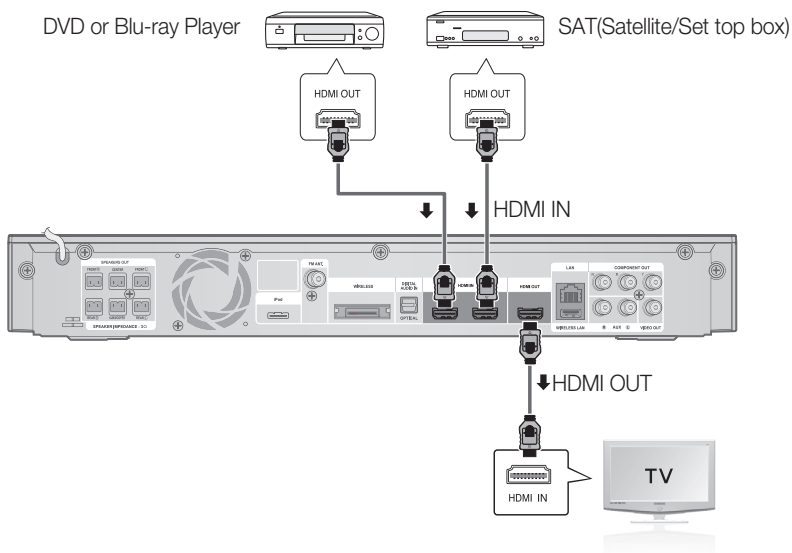

### HDMI OUT : Connecting to a TV with an HDMI Cable (BEST QUALITY)

Connect an HDMI cable (not supplied) from the HDMI OUT jack on the back of the product to the HDMI IN jack on your TV.

#### NOTE

- Certain HDMI output resolutions may not work, depending on your TV.
- If an HDMI cable is connected or removed during playback of a CD-DA, MP3 or JPEG file, the product will stop playing.
- After making the video connection, set the Video input source on your TV to match the corresponding Video output (HDMI, Component or Composite) on your product. See your TV owner's manual for more information on how to select the TV's Video Input source.
- If you have set the product's remote control to operate your TV, press the **SOURCE** button on the remote control and select HDMI as the external source of the TV.

## HDMI IN : Connecting to an External Component with an HDMI Cable

1. Connect an HDMI cable (not supplied) from the HDMI IN jack on the back of the product to the HDMI OUT jack on your digital devices.
2. Press the **FUNCTION** button to select **HDMI 1** or **HDMI 2** input.  
The mode switches as follows : **BD/DVD → D. IN → AUX → HDMI 1 → HDMI 2 → FM**

### HDMI Auto Detection Function

The product's video output will automatically change to HDMI mode when connecting an HDMI cable before power is on. For possible HDMI resolutions, see page 31.

- This function is not available if the HDMI cable does not support CEC.
- HDMI connection description
  - HDMI outputs only a pure digital signal to the TV.
  - If your TV does not support HDCP, random noise appears on the screen.
- What is the HDCP?

HDCP (High-band width Digital Content Protection) is a system for protecting BD/DVD content outputted via HDMI from being copied. It provides a secure digital link between a video source (PC, DVD, etc) and a display device (TV, projector, etc). Content is encrypted at the source device to prevent unauthorized copies from being made.

### **!** CAUTION

- The Anynet+ function is supported only when an HDMI Cable is connected to the HDMI OUT of the product.

# Connections

## Connecting the Video Out to your TV

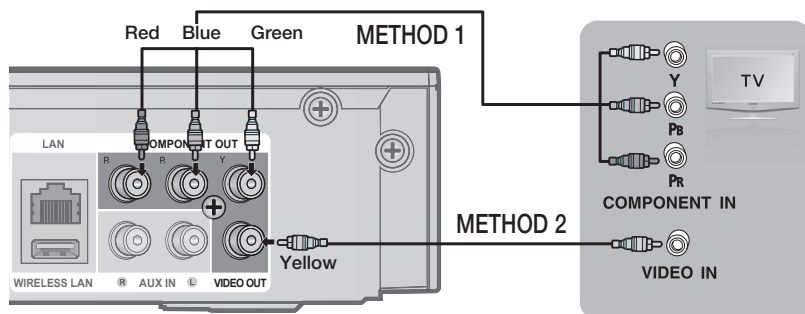

### METHOD 1 : Component Video (BETTER QUALITY)

If your television is equipped with Component Video inputs, connect a Component video cable (not supplied) from the Component Video Output (Pr, Pb and Y) Jacks on the back of the product to the Component Video Input Jacks on your TV.

#### NOTE

- You can select from a variety of resolution settings such as 1080i, 720p, 576p(480p) and 576i(480i), depending on the disc type. (See page 31)
- The actual resolution may differ from the setting in the Setup menu if both Component and HDMI cables are connected. The resolution may also be different depending on the disc. (See page 31)
- After making the video connection, set the Video input source on your TV to match the corresponding Video output (HDMI, Component or Composite) on your product.  
See your TV owner's manual for more information on how to select the TV's Video Input source.
- If you have set the product's remote control to operate your TV, press the **TV SOURCE** button on the remote control and select COMPONENT as the external source of the TV.
- In DVD playback, if both HDMI and Component jacks are connected and you select the Component 1080p, 1080i, 720p or 576p(480p) mode, the Display Setup menu will show the output resolution as 1080p, 1080i, 720p or 576p(480p) in the menu. The resolution is actually 576i(480i).

### METHOD 2 : Composite Video (GOOD QUALITY)

Connect the supplied Video cable from the VIDEO OUT jack on the back of the product to the VIDEO IN jack on your TV.

#### NOTE

- The VIDEO source is always output in 576i(480i) resolution regardless of the resolution set in the Setup menu. (See page 31)
- After making the video connection, set the Video input source on your TV to match the corresponding Video output (HDMI, Component or Composite) on your product.  
See your TV owner's manual for more information on how to select the TV's Video Input source.
- If you have set the product's remote control to operate your TV, press the **TV SOURCE** button on the remote control and select VIDEO as the external source of the TV.

#### **!** CAUTION

- Do not connect the unit through a VCR. Video signals fed through VCRs may be affected by copyright protection systems and the picture will be distorted on the television.



## Connecting Audio from External Components

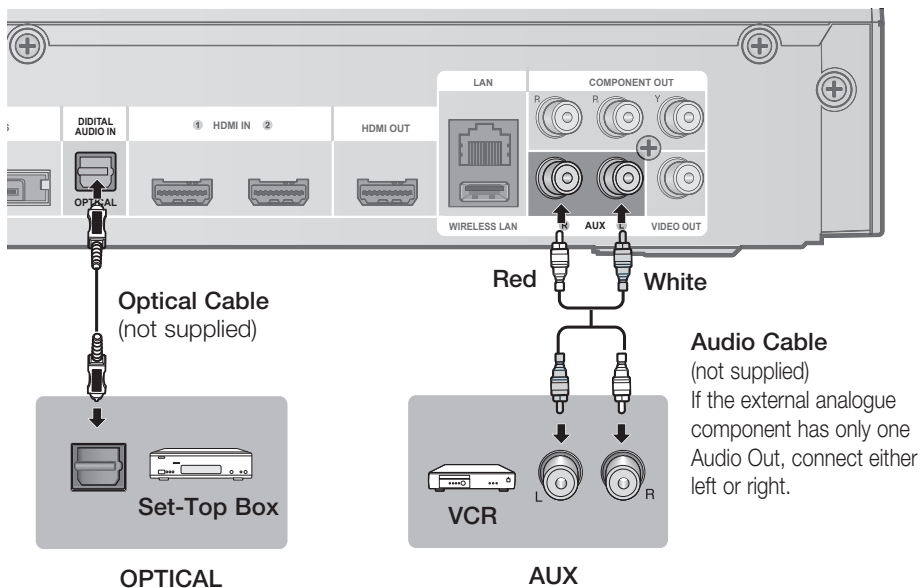

### OPTICAL : Connecting an External Digital Component

Digital signal components such as a Cable Box/Satellite receiver (Set-Top Box).

1. Connect the Digital Input (OPTICAL) on the product to the Digital Output of the external digital component.
2. Press the **FUNCTION** button to select **D.IN** input.
  - The mode switches as follows : **BD/DVD** → **D. IN** → **AUX** → **HDMI 1** → **HDMI 2** → **FM**

#### NOTE

- To see video from your Cable Box/Satellite receiver, you must connect its video output to a TV.
- This system supports Digital sampling frequencies of 32 kHz or higher from external digital components.
- This system supports only DTS and Dolby Digital audio, MPEG audio which is bitstream cannot be supported.

### AUX : Connecting an External Analogue Component

Analogue signal components such as a VCR.

1. Connect AUX IN (Audio) on the product to the Audio Out of the external analogue component.
  - Be sure to match connector colours.
2. Press the **FUNCTION** button to select **AUX** input.
  - The mode switches as follows : **BD/DVD** → **D. IN** → **AUX** → **HDMI 1** → **HDMI 2** → **FM**

#### NOTE

- You can connect the Video Output jack of your VCR to the TV, and connect the Audio Output jacks of the VCR to this product.

# Connections

## Connecting to the Network

This product enables you to view network based services (See pages 57~62) such as Internet@TV and BD-LIVE, as well as receive software upgrades when a network connection is made. We recommend using an AP (Access Point) or IP router for the connection.

For more information on router connection, refer to the user manual of the router or contact the router manufacturer for technical assistance.

### Cable Network

1. Using the Direct LAN Cable (UTP cable), connect the LAN terminal of the product to the LAN terminal of your modem.
2. Set the network options. (See page 38)

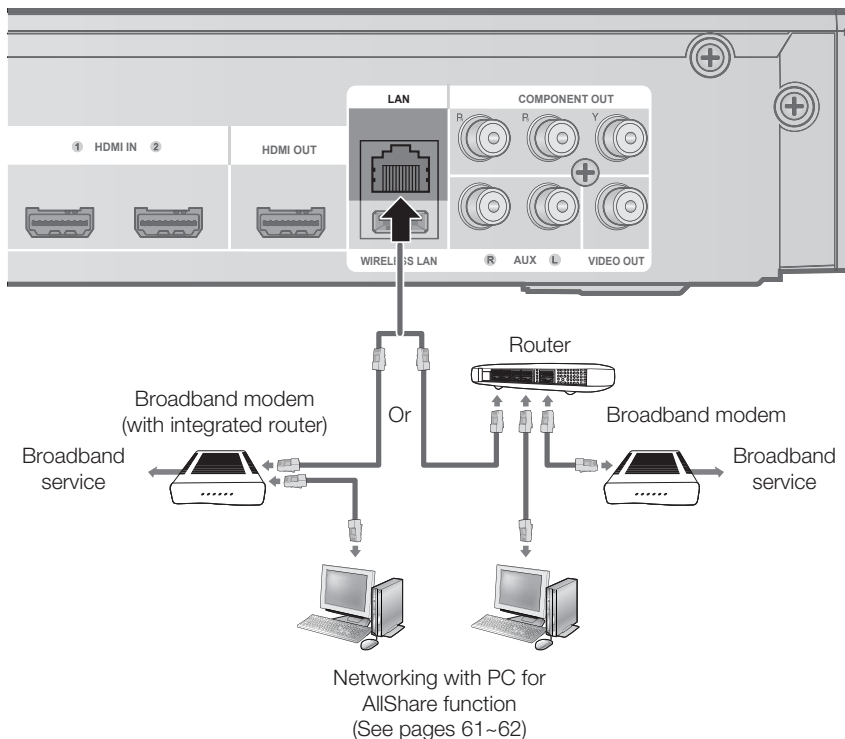

#### NOTE

- Internet access to Samsung's software update server may not be allowed, depending on the router you use or the ISP's policy. For more information, contact your ISP (Internet Service Provider).
- For DSL users, please use a router to make a network connection.
- For the AllShare function, a PC must be connected in the network as shown in the figure.

## Wireless Network

You can connect to the network with a Wireless IP sharer.

1. A wireless AP/IP router is required to make a wireless network connection. Connect the wireless LAN adapter to the Wireless LAN Adapter on the rear panel of the product.
2. Set the network options. (See page 38)

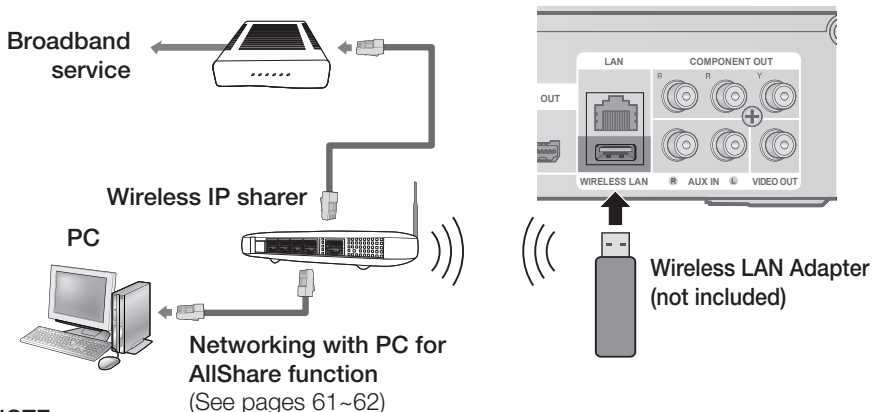

### NOTE

- This product is compatible with only Samsung's Wireless LAN Adapter. (not supplied) (Model name: WIS09ABGN).  
- The Samsung Wireless LAN Adapter is sold separately. Contact a Samsung Electronics retailer for purchasing.
- You must use a wireless IP sharer that supports IEEE 802.11 a/b/g/n. (n is recommended for stable operation of the wireless network.)
- Wireless LAN, by its nature, may cause interference, depending on the use condition (AP performance, distance, obstacles, interference by other radio devices, etc).
- Set the wireless IP sharer to Infrastructure mode. Ad-hoc mode is not supported.
- When applying the security key for the AP (wireless IP sharer), only the following is supported.
  - 1) Authentication Mode : WEP, WPAPSK, WPA2PSK
  - 2) Encryption Type : WEP, AES
- For the AllShare function, a PC must be connected in the network as shown in the figure.

## Connecting the FM Antenna

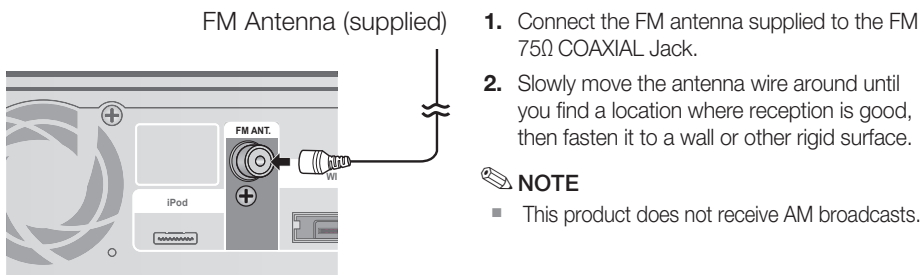

### NOTE

- This product does not receive AM broadcasts.

# Setup

## Before Starting (Initial Settings)

1. Turn on your TV after connecting the product. (When the product is connected to TV for the first time, product will turn on automatically and the Initial Settings screen will be displayed.)

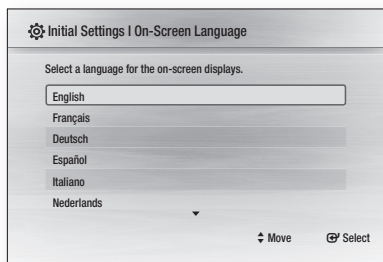

2. Press the ▲▼ buttons to select the desired language, then press the ENTER button.
3. Press the ENTER button to select Start button.

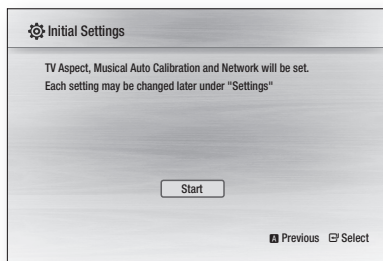

4. Press the ▲▼ buttons to select desired TV Aspect ratio, then press the ENTER button. (See page 29)  
**Musical Auto Calibration** screen will be displayed.
5. Plug the ASC microphone into the **ASC IN** jack on the product. (See page 34)
6. Press the ENTER button to select Start button.



Setting the Musical Auto Calibration function takes about 3 minutes.

7. Press the ◀▶ buttons to select the desired Network Settings: Wired, Wireless or PBC (WPS), then press the ENTER button. (See pages 38–41)  
The Network Test will start and Initial Settings will be completed.

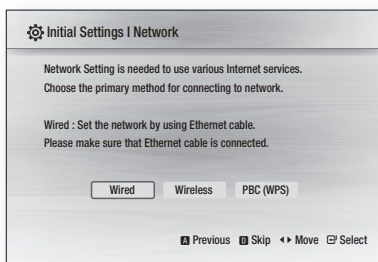

8. Press the OK button.  
The home menu will be displayed. (For more information about home menu, please see page 29)

### • Home Menu



### NOTE

- When the product is connected to TV for the first time, product will turn on automatically. Do not confuse because this is not malfunction.
- The home menu will not be displayed if you do not configure the initial settings.
- If you press the **BLUE(D)** button during the Musical Auto Calibration/Network setup, you can access the home menu even if the network setup is not completed yet.
- When you return to home menu, the full screen mode will be cancelled automatically.

- If you want to display Initial Settings screen again in order to make changes, press the **STOP** (■) button on the front panel of the product for more than 5 seconds with no disc inserted.
- Use the HDMI cable to connect the product to an **Anynet+(HDMI-CEC)**-compliant Samsung TV. If the TV uses a language supported by the product, that language will be set to a preferred language automatically. However, the **Anynet+(HDMI-CEC)** feature should be set to **On** in both TV and the product.
- If the product is left in the stop mode for more than 5 minutes without being operated, a screen saver will appear on your TV. If the product is left in the screen saver mode for more than 25 minutes, the power will automatically turn off except during playback of a CD-DA (Automatic Power-Off Function).

## Setting the Menu

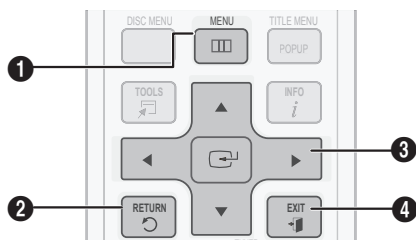

- |   |   |
|---|---|
| 1 | <b>MENU</b> Button : Press this to move to the home menu.   |
| 2 | <b>RETURN</b> Button : Return to the previous menu.   |
| 3 | <b>ENTER / DIRECTION</b> Button:<br>Press the arrow buttons to move the cursor and select an item.<br>Press the <b>ENTER</b> button to launch the selected item or confirm the setting. |
| 4 | <b>EXIT</b> Button : Press this to exit the menu.   |

1. Press the **POWER** button.  
The Home Menu will appear.

### • Home Menu

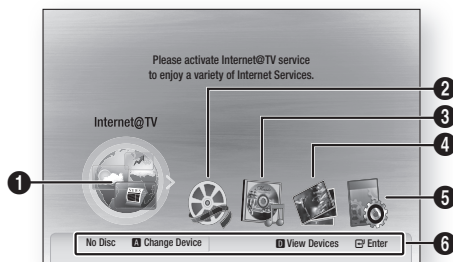

- |   |                             |
|---|-----------------------------|
| 1 | Selects the Internet@TV.    |
| 2 | Selects the Videos.         |
| 3 | Selects the Music.          |
| 4 | Selects the Photos.         |
| 5 | Selects the Settings.       |
| 6 | Displays buttons available. |

2. Press the **◀▶** buttons to select **Settings**, then press the **ENTER** button.
3. Press the **▲▼** buttons to select the desired submenu, then press the **ENTER** button.
4. Press the **▲▼** buttons to select the desired item, then press the **ENTER** button.
5. Press the **EXIT** button to exit the menu.

### NOTE

- When the product is connected to the network, select Internet@TV from the home menu. Download desired content from **Samsung AppS**.
- The access step may differ depending on the selected menu.
- The OSD (On Screen Display) may change in this product after upgrading the software version.

# Setup

## Display

You can configure various display options such as the TV Aspect, Resolution, etc.

### TV Aspect

Depending on the type of television you have, you may want to adjust the screen setting.

#### • 16:9 Normal



Certain movies(4:3 source) will be displayed in 4:3 Pillarbox (black bars on sides of picture) if 16:9 normal is selected.

#### • 16:9 Wide



You can view the full 16:9 picture on your widescreen TV.

#### • 4:3 Letter Box

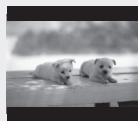

Select when you want to see the total 16:9 ratio screen Blu-ray Disc/DVD supplies, even though you have a TV with a 4:3 ratio screen. Black bars will appear at the top and bottom of the screen.

#### • 4:3 Pan-Scan



Select when you want to see the 16:9 video supplied by the Blu-ray Disc/DVD without the black bars on top and bottom, even though you have a TV with a 4:3 ratio screen(extreme left and right portion of the movie picture will be cut off).

#### NOTE

- Depending on the disc type, some aspect ratios may not be available.
- If you select an aspect ratio and option which is different than the aspect ratio of your TV screen, then the picture might appear to be distorted.
- If you select the 4:3 Pan-Scan or 4:3 Letter Box, you can't see full screen by pressing the **FULL SCREEN** button on the remote control.

## BD Wise (Samsung Products only)

BD Wise is Samsung's latest inter-connectivity feature.

When you connect Samsung products with BD-Wise to each other via HDMI, the optimum resolution will be set automatically.

- **Off** : The output resolution will be fixed according to the Resolution previously set, regardless of the resolution of the disc.
- **On** : The original resolution of the BD/DVD disc will be output to the TV.

#### NOTE

- If you want to change the resolution in BD Wise, you must set BD Wise to **Off** in advance.
- If you set off the BD Wise, the resolution of the connected TV will be adjusted to its maximum resolution automatically.
- If the product is connected to a device that does not support BD Wise, you can not use BD Wise function.
- For a proper operation of BD Wise, set each BD Wise menu of the product and the TV to **On** respectively.

## Resolution

Sets the output resolution of the Component and HDMI video signal.

The number in 1080p, 1080i, 720p, 576p(480p), 576i(480i) indicates the number of lines of video. The i and p indicate interlace and progressive scan, respectively.

- **Auto** : It automatically checks and sets the optimal resolution. (HDMI only)
- **BD Wise** : Automatically sets the optimal resolution when connected via HDMI to a TV with the BD Wise feature. (The BD Wise menu item appears only if BD Wise is set to On.) (HDMI only)
- **1080p** : Outputs 1080 lines of progressive video. (HDMI only)
- **1080i** : Outputs 1080 lines of interlaced video.
- **720p** : Outputs 720 lines of progressive video.
- **576p/480p** : Outputs 576(480) lines of progressive video.
- **576i/480i** : Outputs 576(480) lines of interlaced video. (Component & VIDEO only)

## Resolution according to the output mode

### • Blu-ray Disc playback

Setup \ Output	HDMI / connected		HDMI / not connected	
	HDMI Mode	Component/VIDEO Mode	Component Mode	VIDEO Mode
Auto	Optimal Resolution	576i(480i)	-	-
1080p, Movie Frame(24Fs) off	1080p@60F	576i(480i)	-	-
1080p/1080i, Movie Frame(24Fs) on	1080p@24F	576i(480i)	-	-
1080i, Movie Frame(24Fs) off	1080i	576i(480i)	1080i	576i(480i)
720p	720p	576i(480i)	720p	576i(480i)
576p(480p)	576p(480p)	576i(480i)	576p(480p)	576i(480i)
576i(480i)	-	-	576i(480i)	576i(480i)

### • DVD playback

Setup \ Output	HDMI / connected		HDMI / not connected	
	HDMI Mode	Component/VIDEO Mode	Component Mode	VIDEO Mode
Auto	Optimal Resolution	576i(480i)	-	-
1080p	1080p@60F	576i(480i)	-	-
1080i	1080i	576i(480i)	576p(480p)	576i(480i)
720p	720p	576i(480i)	576p(480p)	576i(480i)
576p(480p)	576p(480p)	576i(480i)	576p(480p)	576i(480i)
576i(480i)	-	-	576i(480i)	576i(480i)

### NOTE

- If the connected TV does not support Movie Frame or the selected resolution, the message "If no pictures are shown after the selection, please wait for 15 seconds. And then, the resolution will be reverted to the previous value automatically. Would you like to make a selection?" will be displayed.  
If you select **Yes** and the resolution is not supported, the TV's screen will be blank. Please wait for 15 seconds and the resolution will be reverted to the previous value automatically.
- If the screen is blank, press and hold the **STOP (■)** button on the front of the product for more than 5 seconds (no disc inserted). All settings are restored to the factory default. Follow the steps on the previous page to access each mode and select the Display Setup that your TV will support.
- When the factory default settings are restored, all the user data stored in the BD data will be deleted.
- The Blu-ray Disc must have the 24 frame feature in order to use the Movie Frame (24Fs) mode.
- If both HDMI and Component jacks are connected and you are currently viewing component output, there is a difference between resolution table and actual resolution depending on your TV.
- If the HDMI Auto Detection feature does not work, you can't select the 1080p resolution or Movie Frame (24Fs).

# Setup

## HDMI Format

---

You can optimize the colour setting from the HDMI output. Select a connected device Type.

- **TV** : Select if connected to a TV via HDMI.
- **Monitor** : Select if connected to a Monitor via HDMI.

### NOTE

- A TV or monitor has to be connected to the product before you select this option.

## Movie Frame (24 Fs)

---

Setting the Movie Frame (24Fs) feature to On allows you to adjust the product's HDMI output to 24 frames per second for improved picture quality. You can enjoy the Movie Frame (24Fs) feature only on a TV supporting this frame rate. This menu can only be selected in 1080i or 1080p HDMI output resolution modes.

- **Off** : Movie Frame (24Fs) functions will not work.
- **On** : Movie Frame (24Fs) functions will work.

### NOTE

- Two types of frame rates may be included, depending on the disc: Movie material (24 frame) and Video material (30 frame). When the setting switches between Movie (24 frame) and Video (30 frame), the screen may blink for a few seconds.
- If your TV does not support Movie Frame (24Fs) function, the pop-up message will be displayed.

## Progressive Mode

---

Set to improve picture quality when viewing DVDs.

- **Auto** : Select this to have the product automatically set the best picture for the DVD you're watching.
- **Video** : Select this for the best picture from Concert or TV show DVDs.

## Still Mode

---

Set the type of picture shown when you pause DVD playback.

- **Auto**: Automatically set the best still picture depending on the content.
- **Frame** : Select when pausing a scene with a little action.
- **Field** : Select when pausing a scene with a lot of action.

## HDMI Deep Color

---

Set to output the picture from the HDMI OUT jack with Deep Colour or not. Deep Colour allows more accurate colour reproduction with deeper colour depth.

- **Auto**: The picture will be output with Deep Colour to the connected TV which supports HDMI Deep Colour.
- **Off** : The picture will be output without Deep Colour.



## Audio

### Speaker Setting

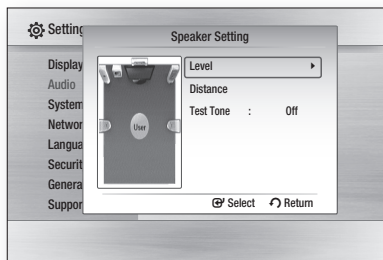

#### Level

You can adjust the balance and level for each speaker.

#### Adjusting Front/Centre/Surround/Subwoofer Speaker Level

- The volume level can be adjusted in steps from +6dB to -6dB.
- The sound gets louder as you move closer to +6dB and quieter as you get closer to -6dB.

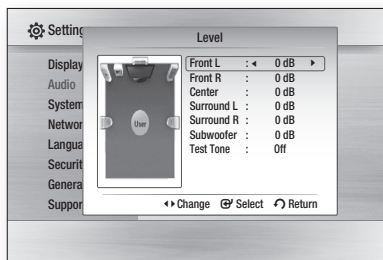

#### Distance

If the speakers cannot be placed at equal distances from the listening position, you can adjust the delay time of the audio signals from the front, centre, surround and subwoofer speakers.

- You can set the Speaker Distance between 1ft(0.3m) and 30ft(9.0m).

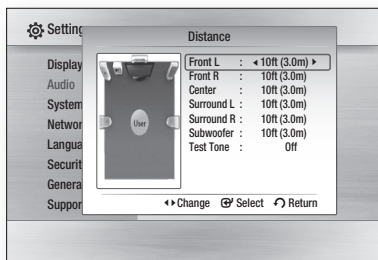

#### Test Tone

Use the Test Tone feature to check the speaker connections.

Press the ◀, ▶ buttons to select **All**.

- A test tone will be sent to **Front Left → Center → Front Right → Surround Right → Surround Left → Subwoofer** in order so you can make sure the speakers are set up correctly.

To stop the test tone, press the ◀, ▶ buttons to select **Off**.

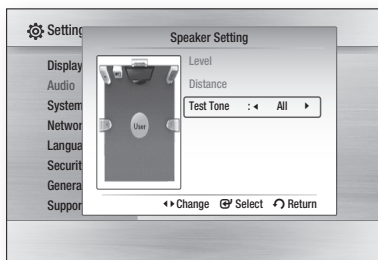

#### NOTE

- When HDMI Audio is ON (audio is produced through TV speakers), the Test Tone function is not available.

# Setup

## Musical Auto Calibration

By setting the Musical Auto Calibration (MAC) function just once when you relocate or install the product, you can have the product automatically recognize the distance between speakers, levels between channels, and frequency characteristics to create a 5.1-channel sound field optimized for your environment.

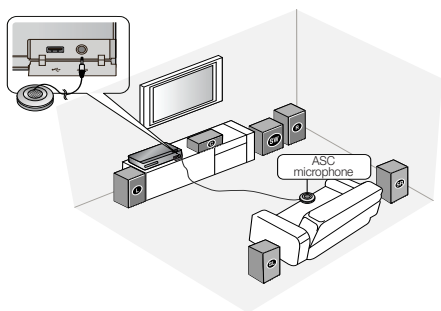

### Musical Auto Calibration

You will hear either the Musical Auto Calibration mode or the User Speaker Settings.

- **Off:** You will hear sound in the the Speaker Setting value.
- **On:** You will hear sound in the Musical Auto Calibration mode.

### Musical Auto Calibration Setting

1. Plug the ASC microphone into the **ASC IN** jack.
2. Place the ASC microphone at the listening position.
  - Musical Auto Calibration will be automatically set up in the following sequence:  
**Front Left → Center → Front Right → Surround Right → Surround Left → Subwoofer**
  - Press the **RETURN** button to cancel the Musical Auto Calibration Setting.
  - When the message "**REMOVE MIC**" appears in the display, unplug the ASC microphone.

### NOTE

- Setting the Musical Auto Calibration function takes about 3 minutes.
- The Musical Auto Calibration setup can be made when there is no disc in the product.
- If the ASC microphone is disconnected during the Musical Auto Calibration setup, the setup will be cancelled.
- When the Musical Auto Calibration function is activated, the DSP, Dolby Pro Logic II and SFE Mode will not work.
- If the product is connected to external devices or other components (such as an iPod, AUX, D.IN), the Musical Auto Calibration Setup may not work properly.

## EQ Optimizer

Set optimal EQ automatically depending on the region.

- **Off** : Turn EQ Optimizer off.
- **On** : Turn EQ Optimizer on.

## HDMI Audio

The audio signals transmitted over the HDMI Cable can be toggled On/Off.

- **Off** : Video is transmitted over the HDMI connection cable only, and audio is output through your product speakers only.
- **On** : Both video and audio signals are transmitted over the HDMI connection cable, and audio is output through your TV speakers only.

### NOTE

- HDMI Audio is automatically down-mixed to 2ch for TV speakers.

## Digital Output

Set Digital output depending on the connected receiver. (For more details, please refer to the digital output selection.)

- **PCM**
- **Bistream(Re-encode)**
- **Bistream(Audiophile)**

Blu-ray Discs may include three audio streams.

- Primary Audio : The audio soundtrack of the main feature.
- Secondary Audio : Additional soundtrack such as director or actor's commentary.
- Interactive Audio : Interactive sounds will be heard when selected. Interactive Audio is different on each Blu-ray Disc.

### NOTE

- Be sure to select the correct Digital Output or you will hear no sound or a loud noise.
- If the HDMI device (Receiver, TV) is not compatible with compressed formats (Dolby digital, DTS), the audio signal outputs as PCM.
- Secondary and Effect audio will not be heard with regular DVDs.
- Some Blu-ray Discs do not have Secondary and Effect audio.
- This Digital Output setup does not effect the analogue (L/R) audio or HDMI audio output to your TV.  
It effects the optical and HDMI audio output when connected to a receiver.
- If you play MPEG audio soundtracks, audio signal outputs PCM regardless of Digital Output Selections (PCM or Bitstream).

## Digital Output Selection

Setup		PCM		Bitstream (Re-encode)	Bitstream (Audiophile)	
Connection		HDMI Receiver	Optical	HDMI Receiver or Optical	HDMI Receiver	Optical
Audio Stream on Blu-ray Disc	PCM	Up to 7.1ch	PCM 2ch	DTS re-encoded	PCM	PCM 2ch
	Dolby Digital	Up to 5.1ch	PCM 2ch	DTS re-encoded	Dolby Digital	Dolby Digital
	Dolby Digital Plus	Up to 7.1ch	PCM 2ch	DTS re-encoded	Dolby Digital Plus	Dolby Digital
	Dolby TrueHD	Up to 7.1ch	PCM 2ch	DTS re-encoded	Dolby TrueHD	Dolby Digital
	DTS	Up to 6.1ch	PCM 2ch	DTS re-encoded	DTS	DTS
	DTS-HD HRA	Up to 7.1ch	PCM 2ch	DTS re-encoded	DTS-HD HRA	DTS
	DTS-HD MA	Up to 7.1ch	PCM 2ch	DTS re-encoded	DTS-HD MA	DTS
Audio Stream on DVD	PCM	PCM 2ch	PCM 2ch	PCM 2ch	PCM 2ch	PCM 2ch
	Dolby Digital	Up to 5.1ch	PCM 2ch	Dolby Digital	Dolby Digital	Dolby Digital
	DTS	Up to 6.1ch	PCM 2ch	DTS	DTS	DTS
Definition for Blu-ray Disc	Any	Decodes Primary, Secondary and Effect audio streams together into PCM audio.		Decodes Primary, Secondary and Effect audio streams together into PCM audio, then re-encodes the PCM audio into DTS bitstream.	Outputs only the Primary audio soundtrack (main soundtrack of the movie) so that your receiver can decode the audio bitstream. You will not hear Secondary and Effect audio.	

# Setup

## Dynamic Range Control

You can listen at low volumes but still hear dialog clearly. This is only active when a Dolby Digital signal is detected.

- **Off** : You can enjoy the movie with the standard Dynamic Range.
- **On** : When Movie soundtracks are played at low volume or from smaller speakers, the system can apply appropriate compression to make low-level content more intelligible and prevent dramatic passages from getting too loud.

## AV Sync

Video may look slower than the audio when the product is connected to a digital TV. If this occurs, adjust the audio delay time to match the video.

- You can set the audio delay time between 0 msec and 300 msec. Set it to the optimal status.

## System

### Initial Settings

By using the Initial Settings, you can set language, TV aspect, Musical Auto Calibration and Network setting, etc.

For more information on the settings, refer to the corresponding section in this user manual.

### Internet@TV Screen Size

Set the Internet@TV Screen to the optimal size.

- **Size 1** : Display smaller application icons, you may see some black on sides of screen.
- **Size 2** : Display normal application icons, image may be too large for your TV screen.
- **Size 3** : Display larger application icons, image may be too large for your TV screen.

## Anynet+ (HDMI-CEC)

Anynet+ is a convenient function that offers linked operations with other Samsung products with the Anynet+ feature.

To operate this function, connect this product to a Samsung TV with an HDMI cable.

You can operate this product using a Samsung TV remote control and start disc playback simply by pressing the **PLAY** (▶) button on the TV's remote control.

For more information, please see the TV user manual.

- **Off** : Anynet+ function will not work.
- **On** : Anynet+ functions will work.

### NOTE

- This function is not available if the HDMI cable does not support CEC.
- If your Samsung TV has an **Anynet+** logo, then it supports the Anynet+ function.
- Depending on your TV, certain HDMI output resolutions may not work. Please refer to the user manual of your TV.

## BD Data Management

Enables you to manage the downloaded contents from the Blu-ray disc that supports the BD-LIVE service.

You can check the device information including the storage size, and delete the BD data or change the device.

- \* You must have a minimum 1GB USB Memory device inserted in one of the USB slots (The Wireless LAN Jack also functions as a USB slot.) in order to download content from BD-LIVE.

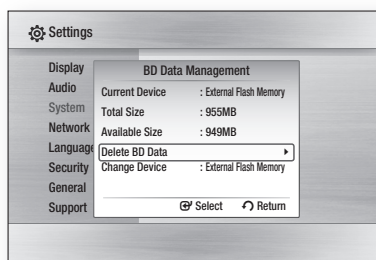

## Description of Device(Storage) Information on the Product

- **Total Size** : Total size of the Device (Storage).
- **Available Size** : Available size of the Device (Storage).

### NOTE

- In the external memory mode, disc playback will be stopped if you disconnect the USB device in the middle of the playback.
- Only those USB devices formatted in FAT file system (DOS 8.3 volume label) are supported, and it is recommended to use USB devices that support USB 2.0 protocol, 4 MB/sec or faster read/write speed.
- A USB HDD device cannot be used for BD Data storage (BD-LIVE).
- The Resume Play function may not work after formatting the storage device.
- The total size of BD Data Management may differ, depending on the software version.

## Clock

Set time-related functions.

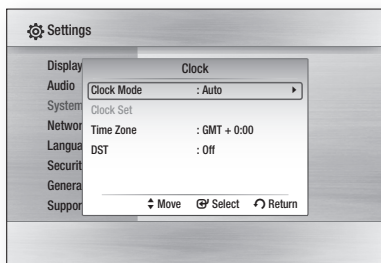

- **Clock Mode** : You can select **Auto** or **Manual**. If you select **Manual**, the **Clock Set** menu will be activated while **DST** will be deactivated.
- **Clock Set** : You can specify the current time and date manually.
- **Time Zone** : You can specify the time zone that is applicable to your area.
- **DST** : You can set DST (Daylight Saving Time) 1 hour, 2 hour and off.

## DivX(R) Registration

View DivX(R) VOD Registration Code to purchase and play DivX(R) VOD content.

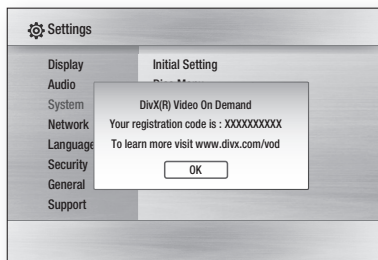

### NOTE

- This option is not activated if you select OK. To activate this option, please activate the DivX(R) Deactivation.

## DivX(R) Deactivation

Select this to get a new registration code.

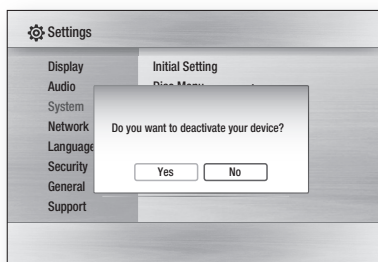

### NOTE

- This function can be operated when DivX(R) Registration function is deactivated.

# Setup

## Network Setup

To begin setting up the network connection for your product, follow these steps:

1. In the Home menu, press the ◀▶ buttons to select the **Settings**, and then press the **ENTER** button.
2. Press the ▲▼ buttons to select **Network**, and then press the **ENTER** button.
3. Press the ▲▼ buttons to select **Network Settings**, and then press the **ENTER** button.
4. Press the ▲▼ buttons to select **Network Type**, and then press the **ENTER** button.
5. Press the ▲▼ buttons to select **Wired** or **Wireless**, and then press the **ENTER** button.
6. Go to the next section.

## Network Settings

Please contact your ISP to find out if your IP address is static or dynamic. If it is dynamic, we recommend using the Auto setting. This is the easiest and will work in the majority of cases. If it is static, you must use the manual set up procedure.

Directions for wired networks are below. Directions for wireless networks are after the directions for wired networks.

### Wired Network

1. In the Network Settings menu, press the ▲▼ buttons to select **Network Settings**, and then press the **ENTER** button. The Internet Protocol Setup screen appears.
2. Press the ▶ button, then select **Auto** or **Manual**, and then press the **ENTER** button.

### Setting Up a Wired Connector - Auto

1. If you selected **Auto**, the Network Function acquires and fills in the values for IP Address, Subnet Mask, etc., automatically.

#### NOTE

- This process can take up to five minutes.

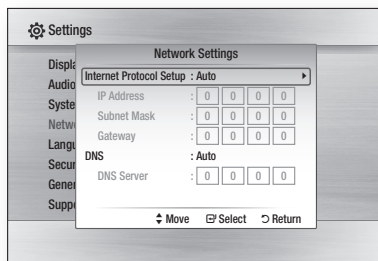

2. After the Network Function has acquired the network values, press the **RETURN** button. Then, run a Network Test to ensure the product has connected to your network (See page 41).
3. If the Network Function does not acquire the network values or you selected Manual, go to the directions for Manual Setup.

### Setting Up a Wired Connector - Manual

If the Auto Setting does not work, you'll need to set the Network Setting values manually.

To get the Network setting values from most Windows computers, follow these steps:

1. Right click the Network icon on the bottom right of the screen.
2. In the pop-up menu, click Status.
3. On the dialog that appears, click the Support tab.
4. On the Support tab, click the Details button. The Network settings are displayed.

To enter the Network settings into your product, follow these steps:

1. On the Internet Protocol Setup screen, press the **ENTER** button.
2. Press the ▲▼ buttons to select **Manual**, and then press the **ENTER** button.
3. Press the ▼ button to go to the first entry field (IP Address).

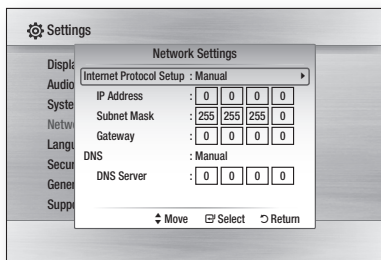

4. Use the number buttons on your remote to enter numbers.
5. When done with each field, use the ► button to move successively to the next field.  
You can also use the other arrow buttons to move up, down, and back.
6. Enter the **IP Address**, **Subnet Mask**, and **Gateway** values.
7. Press the ▼ button to go to **DNS**.
8. Press the ▼ button to go to the first DNS entry field. Enter the numbers as above.
9. Press the **RETURN** button on your remote.
10. Run a Network Test to ensure the product has connected to your network (See page 41).

## Wireless Network

You can setup the wireless network three ways:

- Using PBC (WPS)
- Using the Auto Network Search function.
- Manually.

Each method is described below.

### Setting Up the Wireless Network Connection - PBC (WPS)

The easiest way to set up the wireless network connection is using the PBC (WPS) function. If your wireless router has a PBC (WPS) button, follow these steps:

1. In the Network Settings menu, press the ▲▼ buttons to select **Network Settings**, and then press the **ENTER** button. The Internet Protocol Setup screen appears.

2. Press the **RED(A)** button on the remote control.
3. Press the **PBC (WPS)** button on your router within two minutes. Your product displays the Network Selection Screen, and automatically acquires all the network setting values it needs and connects to your network. When it is done, it displays an **OK** button. Press the **ENTER** button on your remote.
4. After the network connection is set up, press the **RETURN** button to exit the Network Setting screen.

### Setting Up the Wireless Network Connection - Auto Network Search

Most wireless networks have an optional security system that requires devices that access the network to transmit an encrypted security code called an Access or Security Key. The Security Key is based on a Pass Phrase, typically a word or a series of letters and numbers of a specified length you were asked to enter when you set up security for your wireless network. If you use this method of setting up the network connection, and have a Security Key for your wireless network, you will have to enter the Pass Phrase during the setup process.

#### ■ Setting Up the Network Connection

To set up the wireless connection using Auto Network Search, follow these steps:

1. In the Network Settings menu, press the ▲▼ buttons to select **Network Settings**, and then press the **ENTER** button. The Internet Protocol Setup screen appears.
2. Press the ▲▼ buttons to select the **Internet Protocol Setup**, and then press the **ENTER** button.
3. Press the ▲▼ buttons to select **Auto** or **Manual**, and then press the **ENTER** button.
4. If you selected **Auto**, press the ▲ button to go to **Access Point Selection**, and then press the **ENTER** button. The Network function searches for available wireless networks. When done, it displays a list of the available networks.

# Setup

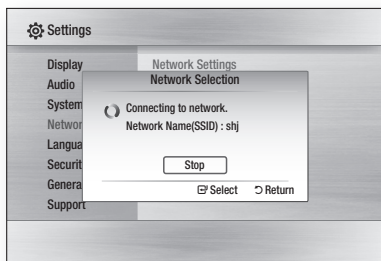

6. In the list of networks, press the ▲▼ buttons to select a network, and then press the ENTER button.
7. If the PIN/Security pop-up appears, go to Step 7. If the Network Connecting Screen appears, go to Step 11.
8. Press the ▲▼ buttons to select PIN or Security.  
For most home networks, you would select Security (for Security Key).
9. On the Security screen, enter your network's Pass Phrase.

## NOTE

- You should be able to find the Pass Phrase on one of the set up screens you used to set up your router or modem.
9. To enter the Pass Phrase, follow these general directions:
    - Press the number keys on your remote to enter numbers.
    - Use the arrow keys on your remote to move from button to button on the Security Key screen.
    - To enter letters, move to the button labelled a/A/1/★, and then press the ENTER button. Each time you press the ENTER button, you change the kind of characters you can enter (a/A/1/★).
    - To enter a letter, press the number button that corresponds to the letter. Pressing the button repeatedly changes the letter.
    - To delete the last letter or number you entered, move to the **Delete** button, and then press the ENTER button.
    - To clear all entered letters and numbers, move to the Clear key, and then press the ENTER button. You can also just press the **RED(A)** button on your remote.

10. When done, press the **YELLOW(C)** button on your remote, or move to the **Done** button, and then press the ENTER button. The Network Connecting screen appears.
11. Wait until the connection confirmation message is displayed, and then press the ENTER button. The Network Settings screen reappears.
12. To test the connection, press the ▼ button to select **Network Test**, and then press the ENTER button.

## Setting Up the Wireless Network Connection - Manual

If the Auto Setting does not work, you need to enter the Network setting values manually.

To get the Network setting values from most Windows computers, follow these steps:

1. Right click the Network icon on the bottom right of the screen.
2. In the pop-up menu, click Status.
3. On the dialog that appears, click the Support tab.
4. On the Support tab, click the Details button. The Network settings are displayed.

To Enter the Network settings into your product, follow these steps:

1. On the Internet Protocol Setup screen, press the ENTER button.
2. Press the ▲▼ buttons to select **Manual**, and then press the ENTER button.
3. Press the ▼ button to go to the first entry field (IP Address).
4. Use the number buttons to enter numbers.

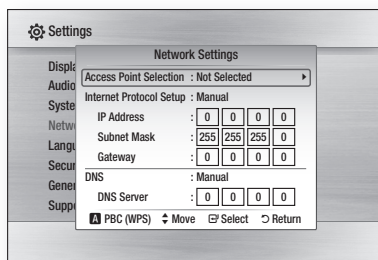



5. When done with each field, use the ► button to move successively to the next field.  
You can also use the other arrow buttons to move up, down, and back.
6. Enter the **IP Address**, **Subnet Mask**, and **Gateway** values.
7. Press the ▼ to go to **DNS**.
8. Press the ▼ button to go to the first DNS entry field. Enter the numbers as above.
9. When done, press the ▲ button to return to Access Point Selection. Select the network, and then press the **ENTER** button.
10. Go to Step 6 in the Automatic Wireless procedure above, and follow the directions from that point on.

## Network Test

Use this menu to connect the wired network or check whether your network connection is working or not.

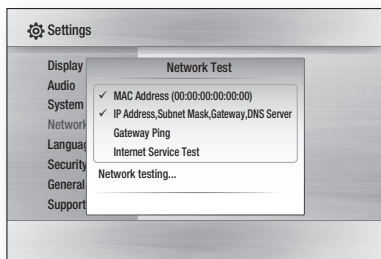

## Network Status

Check whether a connection to the network and the Internet have been established.

## BD-LIVE Internet Connection

Set whether to allow internet connection when BD-LIVE service is used.

- **Allow (All)** : The Internet connection will be allowed for all BD-LIVE contents.
- **Allow (Valid Only)** : The Internet connection will be allowed only for BD-LIVE contents containing a valid certificate.
- **Prohibit** : No Internet connection will be allowed for any BD-LIVE content.

### NOTE

- **What is a valid certificate?**  
When the product uses BD-LIVE to send the disc data and request to the server to certify the disc, the server uses the transferred data to check if the disc is valid and sends the certificate back to the product.
- The Internet connection may be restricted while you are using BD-LIVE contents.

## Language

You can select the language you prefer for home menu, disc menu, etc.

- **On-Screen Menu** : Select the language for the on-screen displays.
- **Disc Menu** : Select the language for the disc menu displays.
- **Audio** : Select the language for disc audio.
- **Subtitle** : Select the language for disc subtitles.

### NOTE

- The selected language will only appear if it is supported on the disc.

# Setup

## Security

When you operate this menu for the first time, password setup screen will be displayed. Enter the desired 4-digit password using the number buttons. (Default password is set to 0000.)

### Parental Rating

This function works in conjunction with Blu-ray Disc/DVDs that have been assigned a rating, which helps you control the types of Blu-ray Disc/DVDs that your family watches.

Select the rating level you want to set. A larger number indicates that the program is intended for adult use only. For example, if you select up to Level 6, discs that contain Level 7, 8 will not play.

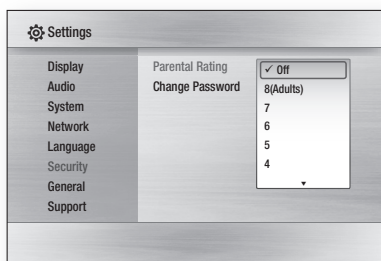

### Change Password

Change the 4-digit password used to access security functions.

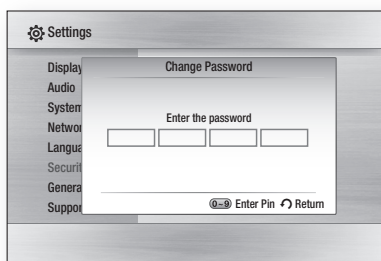

### If you forgot your password

1. Remove the disc.
2. Press and hold the **STOP** (■) button on the front panel for 5 seconds or more.  
All settings will revert to the factory settings.

#### NOTE

- When the factory default settings are restored, all the user data stored in the BD data will be deleted.

## General

### Background

Change the background theme of the menu screen.

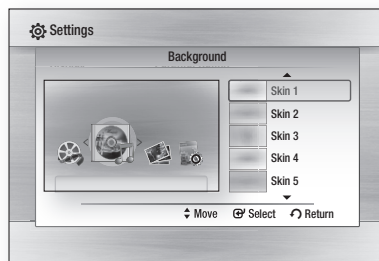

### Energy Saving

You can reduce power consumption by setting the front panel to turn off automatically when there is no operation for 5 seconds.

- **Off** : Energy Saving function is not used.
- **On** : The front panel will automatically turn off when there is no operation for 5 seconds.

### Front Display

Change the brightness of the front panel.

- **Auto** : Dim during playback only.
- **Dim** : Dim the display window.
- **Bright** : Brighten the display window.

### Power On/Off Sound

Play a melody when the product is turned on and off.

- **Off** : Turn Power Sound Off.
- **On** : Turn Power Sound On.

## Support

### Software Upgrade

This menu allows you to upgrade software for performance improvements or additional services. You can check the current software version, upgrade by internet and set the Auto upgrade notification. If the product is properly connected to the network by cable or wirelessly, the product will automatically connect to our website each time it is turned on and download update files if any valid upgrade exists.

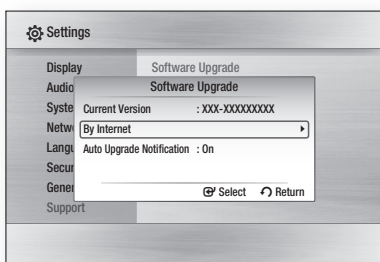

1. To select **By Internet**, press the **ENTER** button.  
A popup message will appear if an update is available.
2. If you select **Yes**, the product will turn off automatically before restarting.  
(Never turn it on manually.)
3. The update progress popup will appear.  
When the update is completed, the product will turn back off automatically.
4. Press the **POWER** button to turn on the product.

#### NOTE

- The Update will be completed when the product turns off after restarting. Press the **POWER** button to turn on the updated product for your use.  
Never turn off or on the product manually during the update process.
- Samsung Electronics shall take no legal responsibility for product malfunction caused an unstable internet connection or consumer negligence during software upgrade.

You can update software in any of the two ways as follows: Software update is the same as in the **By Internet** menu.

- **USB** : Visit [www.samsung.com/bluraysupport](http://www.samsung.com/bluraysupport), then download and store the latest software (RUF file) into the USB flash drive. Connect the USB flash drive to the USB port of the product (disc tray must be empty) to update the software, then follow the on-screen instructions.
- **CD** : Visit [www.samsung.com/bluraysupport](http://www.samsung.com/bluraysupport), download and write the latest software (RUF file) onto a disc. Insert and play the disc in the product to start the update, then follow the on-screen instructions.

#### NOTE

- Software upgrades using the USB Host jack must be performed with no disc inside.
- If you want to cancel the upgrade in the process of downloading the upgrade data, press the **ENTER** button.
- When the system upgrade is done, check the software details in the software Upgrade menu.
- Do not turn off the product during the System Upgrade, as it may cause the product to not work properly.
- Do not use USB devices other than USB Flash Drives to do software upgrades when using the USB Host jack.

### Contact Samsung

Provide contact information for assistance with your product.

# Basic Functions

## Playing a Disc

### Playback

1. Press the **OPEN/CLOSE** (▲) button to open the disc tray.
2. Place a disc gently into the tray with the disc's label facing up.
3. Press the **PLAY** (▶) button or **OPEN/CLOSE** (▲) button to close the disc tray.

### Playback related buttons

<b>PLAY</b> (▶)	Starts playback.
<b>STOP</b> (■)	Stops playback. <ul style="list-style-type: none"><li>• If pressing the button once: The stop position will be memorized.</li><li>• If pressing the button twice: The stop position will be not memorized.</li></ul> (With some Blu-ray discs (BD-J), this function may not work.)
<b>PAUSE</b> (  )	Pauses playback.

#### NOTE

- "Not Available" will appear when an invalid button is pressed.

## Disc Structure

The contents of disc are usually divided as below.

### • Blu-ray Disc, DVD-VIDEO



### • Audio CD (CD-DA)



### • MP3, WMA, DivX, MKV and MP4



## Using the Disc menu / Title menu / Popup menu

### Using the Disc Menu



1. During playback, press the **DISC MENU** button on the remote control.
2. Press the ▲▼◀▶ buttons to make the desired selection, then press the **ENTER** button.



#### NOTE

- Depending on the disc, the menu items may differ and this menu may not be available.

## Using the Title Menu

1. During playback, press the **TITLE MENU** button on the remote control.
2. Press the **▲▼◀▶** buttons to make the desired selection, then press the **ENTER** button.



### NOTE

- Depending on the disc, the menu items may differ and this menu may not be available.
- The Title Menu will only be displayed if there are at least two titles on the disc.

## Playing the Title List

1. During playback, press the **DISC MENU** or **TITLE MENU** button.
2. Press the **▲▼** buttons to select an entry you want to play from Title List, then press the **ENTER** button.



## Using the Popup Menu

1. During playback, press the **POPUP** button on the remote control.
2. Press the **▲▼◀▶** buttons or **ENTER** button to select the desired menu.



### NOTE

- Depending on the disc, the menu items may differ and this menu may not be available.

## Using the Search and Skip Functions

During playback, you can search quickly through a chapter or track, and use the skip function to jump to the next selection.

### Searching for a Desired Scene



- During playback, press the **SEARCH (◀◀▶▶)** button.

Each time you press the **SEARCH (◀◀▶▶)** button, the playback speed will change as follows.

BD-ROM, BD-RE/-R, DVD-RW/-R, DVD+RW/+R, DVD-VIDEO	▶▶ 1 → ▶▶ 2 → ▶▶ 3 → ▶▶ 4 → ▶▶ 5 → ▶▶ 6 → ▶▶ 7 ◀◀ 1 → ◀◀ 2 → ◀◀ 3 → ◀◀ 4 → ◀◀ 5 → ◀◀ 6 → ◀◀ 7
DivX, MKV, MP4	▶▶ 1 → ▶▶ 2 → ▶▶ 3 ◀◀ 1 → ◀◀ 2 → ◀◀ 3

- To return to normal speed playback, press the **PLAY (▶)** button.

### NOTE

- No sound is heard during search mode.

## Skipping Chapters



- During playback, press the **SKIP (◀◀▶▶)** button.

If you press the **SKIP (▶▶)** button, it moves to the next chapter.

If you press the **SKIP (◀◀)** button, it moves to the beginning of the chapter. One more press makes it move to the beginning of the previous chapter.

# Basic Functions

## Slow Motion Play/Step Motion Play

### Slow Motion Play



- In pause mode, press the **SEARCH** (▶▶) button.  
If you press the **SEARCH** (▶▶) button, the playback speed is reduced to  
▶▶ 1/8 ▶▶ 1/4 ▶▶ 1/2
- To return to normal speed playback, press the **PLAY** (▶) button.

#### NOTE

- No sound is heard during slow mode.
- Slow motion operates only in the forward direction.

### Step Motion Play



- In pause mode, press the **PAUSE** (||) button.  
Each time the **PAUSE** (||) button is pressed, a new frame will be appear.
- To return to normal speed playback, press the **PLAY** (▶) button.

#### NOTE

- No sound is heard during step mode.
- Step motion operates only in the forward direction.

## Repeat Playback

### Repeat the Title or Chapter



Repeat the disc title or chapter.

1. During playback, press the **REPEAT** button on the remote control.
2. Press the ▲▼ buttons to select **Chapter** or **Title**, then press the **ENTER** button.



3. To return to normal play, press the **REPEAT** button again.
4. Press the ▲▼ buttons to select **Off**, then press the **ENTER** button.

#### NOTE

- Depending on the disc, the Repeat function may not be available.

### Repeat the Section



1. During playback, press the **REPEAT** button on the remote control.
2. Press the ▲▼ buttons to select **REPEAT A-B**.



3. Press the **ENTER** button at the point where you want repeat play to start (A).
4. Press the **ENTER** button at the point where you want repeat play to stop (B).
5. To return to normal play, press the **REPEAT** button again.
6. Press the **ENTER** button.

#### NOTE

- If you set point (B) before 5 seconds has lapsed, the prohibition message will appear.

## Using the TOOLS button

During playback, you can operate disc menu by pressing the **TOOLS** button.



### • TOOLS Menu Screen

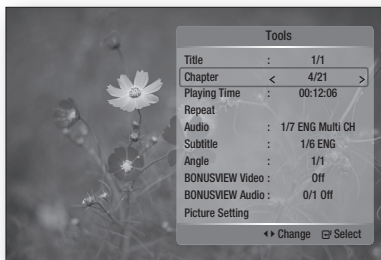

### NOTE

- Depending on the disc, the TOOLS menu may differ.

## Moving to a Desired Scene Directly



- During playback, press the **TOOLS** button.
- Press the **▲▼** buttons to select **Title**, **Chapter** or **Playing Time**.
- Enter the desired **Title**, **Chapter** or **Playing Time** using the number buttons, then press the **ENTER** button.

## Selecting the Audio Language



- During playback, press the **TOOLS** button.
- Press the **▲▼** buttons to select **Audio**.
- Press the **◀▶** buttons to select the desired audio language.

### NOTE

- The **◀▶** indicator will not be displayed on the screen if the BONUSVIEW section does not contain any BONUSVIEW audio settings.

- Information about the primary / secondary mode will be also displayed if the Blu-ray Disc has a BONUSVIEW section. Use the **◀▶** button to switch between primary and secondary audio modes.
- This function depends on what audio languages are encoded on the disc and may not be available.
- A Blu-ray Disc can contain up to 32 audio languages and a DVD up to 8.
- Some Blu-ray Discs may allow you to select either the multi-channel LPCM or Dolby digital audio soundtrack in English.

## Selecting the Subtitle Language



- During playback, press the **TOOLS** button.
- Press the **▲▼** buttons to select **Subtitle**.
- Press the **◀▶** buttons to select the desired subtitle language.

### NOTE

- Depending on the Blu-ray Disc / DVD, you may be able to change the desired subtitle in the Disc Menu. Press the **DISC MENU** button.
- This function depends on what subtitles are encoded on the disc and may not be available on all Blu-ray Discs/DVDs.
- A Blu-ray Disc can contain up to 255 subtitle languages and a DVD up to 32.
- Information about the primary / secondary mode will also be displayed if the Blu-ray Disc has a BONUSVIEW section.
- This function changes both the primary and secondary subtitles at the same time.
- The total number of subtitles is the sum of the primary and secondary ones.

# Basic Functions

## Caption Function



- You must have some experience with video extraction and editing in order to use this feature properly.
- To use the caption function, save the caption file (\*.smi) in the same file name as that of the DivX media file (\*.avi) within the same folder.  
Example. Root Samsung\_007CD1.avi  
                  Samsung\_007CD1.smi
- Up to 60 alphanumeric characters or 30 East Asian characters (2 byte characters such as Korean and Chinese) for the file name.

## Changing the Camera Angle



When a Blu-ray Disc/DVD contains multiple angles of a particular scene, you can use the ANGLE function.

1. During playback, press the **TOOLS** button.
2. Press the **▲▼** buttons to select **Angle**.
3. Press the **◀▶** buttons to select the desired Angle.

## Selecting the Picture Setting



This function enables you to adjust video quality when you are connected to a TV via HDMI.

1. During playback, press the **TOOLS** button.
2. Press the **▲▼** buttons to select **Picture Setting**, then press the **ENTER** button.
3. Press the **◀▶** buttons to select the desired **Picture Setting**, then press the **ENTER** button.
  - **Dynamic** : Choose this setting to increase Sharpness.
  - **Normal** : Choose this setting for most viewing applications.
  - **Movie** : This is the best setting for watching movies.

- **User** : The user can adjust the sharpness and noise reduction function respectively.

## Setting the BONUSVIEW



The BONUSVIEW feature allows you to view additional content (such as commentaries) in a small screen window while the movie is playing. This function is only available if the disc has the bonusview feature.



Primary a audio/video

Secondary a audio/video

1. During playback, press the **TOOLS** button.
2. Press the **▲▼** buttons to select **BONUSVIEW Video** or **BONUSVIEW Audio**.
3. Press the **◀▶** buttons to select the desired bonusview.

### NOTE

- If you switch from BONUSVIEW Video, BONUSVIEW Audio will change automatically in accordance with BONUSVIEW Video.

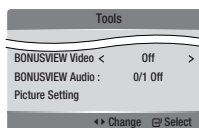



## Listening to Music



### Buttons on the Remote Control used for Music Playback

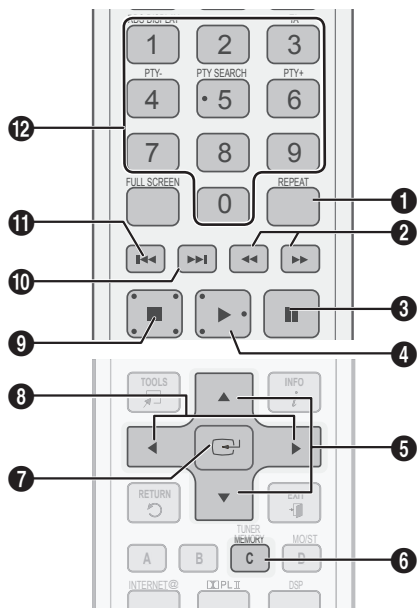

1	<b>REPEAT</b> buttons : Selects the play mode in the Playlist.
2	<b>SEARCH</b> buttons : Fast Play. (Audio CD (CD-DA) only)
3	<b>PAUSE</b> button : Pauses playback.
4	<b>PLAY</b> button : Plays the currently selected track.
5	<b>▲ ▼</b> buttons : Selects a track in the Music List or Playlist.
6	<b>YELLOW(C)</b> button : Select or deselect a track in the music list.

7	<b>ENTER</b> button : Plays and pauses the selected track.
8	<b>◀▶</b> buttons : Fast Play. (except for Audio CD (CD-DA))
9	<b>STOP</b> button : Stops a track.
10	<b>SKIP(▶▶)</b> button : During playback, moves to the next page in the Music List or moves to the next track in the Playlist.
11	<b>SKIP(◀◀)</b> button : During playback, moves to the previous page in the Music List or moves to the previous track in the Playlist. If you press this button after three seconds of playback in the Playlist, the current track will be replayed from the beginning. But, if you press this button within three seconds after playback starts in the Playlist, the previous track will be played.
12	<b>NUMBER</b> button : During the Playlist playback, press the desired track number. The selected track will be played.

# Basic Functions

## Playing an Audio CD (CD-DA)/MP3

1. Insert an Audio CD (CD-DA) or an MP3 Disc into the disc tray.
  - For an Audio CD (CD-DA), the first track will be played automatically.
  - For an MP3 disc, press the ◀▶ buttons to select **Music**, then press the **ENTER** button.

### Audio CD (CD-DA)/MP3 Screen Elements

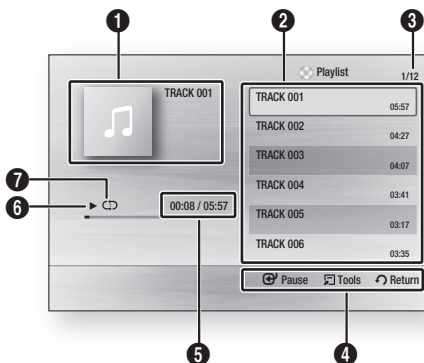

1	Displays the music information.
2	Displays the playlist.
3	Shows the current track/total tracks.
4	Displays buttons available.
5	Shows the current play time/total play time.
6	Displays the current playback status.
7	Displays the repeated playback status.

2. Press the ▲▼ buttons to select the track you want to play, and then press the **ENTER** button.

## Repeat an Audio CD (CD-DA)/MP3

1. During the Playlist playback, press the **REPEAT** button.
2. Select the desired play mode by pressing the **REPEAT** button repeatedly.



Off	Audio CD (CD-DA)/MP3	Tracks on a disc are played in the order in which they were recorded on the disc.
(C) Track	Audio CD (CD-DA)	Current track is repeated.
(C) One	MP3	Current track is repeated.
(C) All	Audio CD (CD-DA)/MP3	All tracks are repeated.
(C) Shuffle	Audio CD (CD-DA)/MP3	The random option plays a disc's track in random order.

## Playlist

1. Insert an Audio CD (CD-DA) or an MP3 Disc into the disc tray.
  - For an Audio CD (CD-DA), the first track will be played automatically.
  - For an MP3 disc, press the ◀▶ buttons to select **Music**, then press the **ENTER** button.
2. To move to the Music List, press the **STOP** (■) or **RETURN** button. The Music List screen is displayed.
3. Press the ▲▼◀▶ buttons to move to the desired track, then press the **YELLOW(C)** button to check desired tracks. Repeat this procedure to select additional tracks.



- If there is an undesired track in the playlist, press the **YELLOW(C)** button again. The selected track will be deleted.
- Press the **ENTER** button to play the selected tracks. The selected track will automatically play.

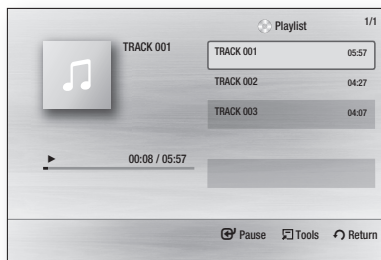

- To go to the Music List, press the **STOP** (■) or **RETURN** button.
- To go to the Playlist, press the **ENTER** button.

#### **NOTE**

- You can create a playlist with up to 99 tracks on Audio CD (CD-DA).

## Sound Mode

### DSP(Digital Signal Processor) Function

This will regulate and stabilize the volume level against a drastic volume change when changing channels or during a scene transition.

Press the **DSP** button.



**SMART SOUND** → **MP3 ENHANCER** →  
**POWER BASS** → **DSP MODE OFF**

- SMART SOUND** : This will regulate and stabilize the volume level against a drastic volume change when changing channels or during a scene transition.
- MP3 ENHANCER** : This also helps enhance your sound experience (ex. mp3 music). You can upscale your MP3 level sound(24 kHz, 8bit) to CD level sound(44.1 kHz, 16bit).
- POWER BASS** : This function stresses low tones providing thudding sound effects.

### SFE(Sound Field Effect) MODE

You can set the SFE mode best suited for the type of music you are listening to.

Press the **SFE MODE** button.



<b>HALL1</b>	Provides a clear vocal as if listening in a concert hall.
<b>HALL2</b>	Provides also a clear vocal as if listening in a concert hall but, less powerful than HALL1.
<b>JAZZ</b>	Recommended setting for Jazz.
<b>CHURCH</b>	Gives the feel of being in a grand church.
<b>ROCK</b>	Recommended setting for Rock.
<b>SFE OFF</b>	Select this for normal listening.

# Basic Functions

## Dolby Pro Logic II Mode

You can select the desired Dolby Pro Logic II audio mode.

Press the  **PL II** button.



<b>MUSIC</b>	When listening to music, you can experience sound effects as if you are listening to the actual performance.
<b>MOVIE</b>	Adds realism to the movie soundtrack.
<b>PROLOG</b>	You will experience a realistic multi-channel effect, as if using six speakers, while using just the front left and right speakers.
<b>MATRIX</b>	You will hear multi channel surround sound.
<b>STEREO</b>	Select this to listen to sound from the front left and right speakers and the subwoofer only.

### **NOTE**

- When selecting Dolby Pro Logic II mode, connect your external device to the AUDIO INPUT jacks (L and R) on the product. If you connect to only one of the inputs (L or R), you cannot listen to surround sound.
- This mode is available only with 2 channel audio.

## Playing back a Picture



## Playing a JPEG Disc

- Insert a JPEG disc into the disc tray.
- Press the ◀▶ buttons to select the **Photos**, and then press the **ENTER** button.
- Press the ▲▼◀▶ buttons to select the folder you want to play, and then press the **ENTER** button.
- Press the ▲▼◀▶ buttons to select the photo you want to play, and then press the **ENTER** button.

### **NOTE**

- You can't enlarge the subtitle and PG graphic in the full screen mode.

## Using the TOOLS button

During the slide show playback, you can use various function by pressing the **TOOLS** button.



- Stop Slide Show** : Select this if you want to stop the slide show.
- Slide Show Speed** : Select this if you want to adjust the Slide Show speed.
- Background Music** : Select this if you want to listen to music while viewing a picture.
- Zoom** : Select this if you want to enlarge the current picture. (Enlarged up to 4 times)
- Rotate** : Select this if you to rotate the picture. (This will rotate the picture either clockwise or counter clockwise.)
- Information** : Shows the picture information including the name and size, etc.

### **NOTE**

- To enable the Background Music function, both music and MP3 files must be contained in the same folder. However, the sound quality can be affected by the bit rate of the MP3 file, the size of the photo and the encoding method.

## Playing back a USB Storage



You can use the USB connection to play multimedia files (MP3, JPEG, DivX, etc) downloaded from the USB storage device.

1. Move to the home menu.
2. In Stop mode, connect the USB storage device to the USB port on the front panel of the product. The message “Do you want to access the device?” will be displayed.
3. Press the ◀▶ button to select **Yes**, then press the **ENTER** button.
4. Press the **RED(A)** button.



5. Press the ▲▼ buttons to select the USB, then press the **ENTER** button.
6. Press the ◀▶ buttons to select the desired Videos, Music or Photos, then press the **ENTER** button.
- 4-1. Press the **BLUE(D)** button.



- 5-1. Press the ◀▶ buttons to select the USB, then press the **ENTER** button.
- 6-1. Press the ▲▼ buttons to select the desired Videos, Music or Photos, then press the **ENTER** button.
7. For playing back Video, Music or Photos files, see pages 44~52.

## NOTE

- You must remove the USB storage device safely (by performing the “Safe to Remove Hardware” function) in order to prevent a possible damage to the USB memory. Press the **MENU** button to move to the main screen, and select the **YELLOW(C)** button and press the **ENTER** button.
- When the Audio-CD (CD-DA), MP3 and JPEG files are in stop mode, you can't see full screen by pressing the **FULL SCREEN** button on the remote control.
- If you insert the disc when playing USB storage device, the device mode is changed to “DVD or CD” automatically.
- To listen to your music files with 5.1 channel sound, you must set the Dolby Pro Logic II mode to Matrix. (See page 52)

## Listening to Radio

### Using buttons on the Remote Control

1. Press the **FUNCTION** button to select **FM**.
2. Tune in to the desired station.
  - **Automatic Tuning 1** : When the ◀▶ button is pressed, a preset broadcast station is selected.
  - **Automatic Tuning 2** : Press and hold the **TUNING/CH** (^v) button to automatically search for active broadcasting stations.
  - **Manual Tuning** : Press the **TUNING/CH** (^v) button to increase or decrease the frequency incrementally.

### Using buttons on the product

1. Press the **FUNCTION** (●) button to select **FM**.
2. Select a broadcast station.
  - **Automatic Tuning 1** : Press the **STOP** (■) button to select **PRESET** and then press the ◀▶ button to select the preset station.
  - **Automatic Tuning 2** : Press the **STOP** (■) button to select **MANUAL** and then press and hold the ◀▶ button to automatically search the band.
  - **Manual Tuning** : Press the **STOP** (■) button to select **MANUAL** and then press the ◀▶ button to tune in to a lower or higher frequency.

# Basic Functions

## Setting Mono/Stereo

Press the **MO/ST** button.

- Each time the button is pressed, the sound switches between **STEREO** and **MONO**.
- In a poor reception area, select **MONO** for a clear, interference-free broadcast.



## Presetting Stations

Example : Presetting FM 89.10 into memory

1. Press the **FUNCTION** button to select **FM**.
2. Press the **TUNING/CH** (^v) button to select <89.10>.
3. Press the **TUNER MEMORY** button.
  - **NUMBER** flashes on the display.
4. Press the **◀▶** button to select preset number.
  - You can select between 1 and 15 presets.
5. Press the **TUNER MEMORY** button again.
  - Press the **TUNER MEMORY** button before **NUMBER** disappears from the display.
  - **NUMBER** disappears from the display and the station is stored in memory.
6. To preset another station, repeat steps 2 to 5.
  - To tune in to a preset station, press the **◀▶** button on the remote control to select a channel.



## About RDS broadcasting

### Using the RDS (Radio Data System) to receive FM stations

RDS allows FM stations to send an additional signal along with their regular program signals. For example, the stations send their station names, as well as information about what type of program they broadcast, such as sports or music, etc.

When tuned to an FM station which provides the RDS service, the RDS indicator lights up on the display.

### Description on RDS function

- **PTY** (Program Type) : Displays the type of programme currently being broadcast.

- **PS NAME** (Program Service Name) : Indicates the name of broadcasting station and is composed of 8 characters.
- **RT** (Radio Text) : Decodes the text broadcast by a station (if any) and is composed of maximum 64 characters.
- **CT** (Clock Time) : Decodes the real time clock from the FM frequency. Some stations may not transmit **PTY**, **RT** or **CT** information therefore this may not be displayed in all cases.
- **TA** (Traffic Announcement) : **TA ON/OFF** it shows that the traffic announcement is in progress.

### NOTE

- RDS may not operate correctly if the station tuned is not transmitting RDS signal properly or if the signal strength is weak.

### To show the RDS signals

You can see the RDS signals the station sends on the display.

Press the **RDS DISPLAY** button while listening to an FM station.

- Each time you press the button, the display change to show you the following information : **PS NAME** → **RT** → **CT** → **Frequency**



<b>PS</b> (Program Service)	While searching, <PS> appears and then the station names will be displayed. <NO PS> appears if no signal is sent.
<b>RT</b> (RadioText)	While searching, <RT> appears and then text messages the station sends will be displayed. <NO RT> appears if no signal is sent.
<b>Frequency</b>	Station frequency (non-RDS service)

### About characters shown in the display

When the display shows **PS**, or **RT** signals, the following characters are used.

- The display window cannot differentiate upper case and lower case letters and always uses upper case letters.
- The display window cannot show accented letters, <A,> for instance, may stands for accented <A's> like <À, Á, Â, Ã, Ä and Å.>

## PTY (Program Type) indication and

### PTY-SEARCH function

One of the advantages of the RDS service is that you can locate a particular kind of program from the preset channels by specifying the PTY codes.

### To search for a program using the PTY codes

#### **Before you start!**

- The PTY Search is only applicable to preset stations.
- To stop searching any time during the process, press **PTY SEARCH** button while searching.
- There is a time limit in doing the following steps. If the setting is cancelled before you finish, start from step 1 again.
- When pressing the buttons on the primary remote control, make sure that you have selected the FM station using the primary remote control.



1. Press the **PTY SEARCH** button while listening to an FM station.
2. Press the **PTY-** or **PTY+** button until the PTY code you want appears on the display.
  - The display gives you the PTY codes described to the right.
3. Press the **PTY SEARCH** button again, while the PTY code selected in the previous step is still on the display.
  - The centre unit searches 15 preset FM stations, stops when it finds the one you have selected, and tunes in that station.

## Using an iPod

You can enjoy music, video files from an iPod through the product.

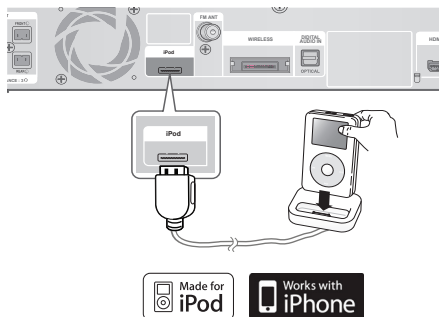

## Listening to Music

You can play music files stored in the iPod player by connecting it to the product.

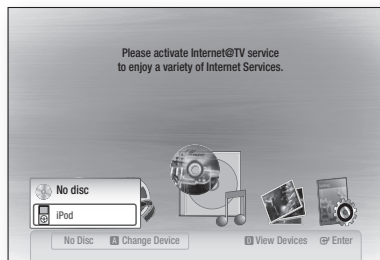

1. Connect the iPod dock connector to the iPod Jack on the rear panel of the product.
2. Place the iPod in the supplied iPod Dock.
  - Your iPod is automatically turned on.
  - "iPod" message appears on the TV screen.
3. Press the **RED(A)** button.
4. Press the **▲ ▼** buttons to select **iPod**, then press the **ENTER** button.
5. Press the **◀ ▶** buttons to select **Music**, then press the **ENTER** button.
6. Select the music file to play.
  - You can use the remote control or product to control simple playback functions such as the **PLAY, PAUSE, STOP, ◀▶, ◀▶▶, ◀▶▶▶** and **REPEAT** buttons. See page 15.

# Basic Functions

## NOTE

- Adjust the volume to a moderate level before you connect your iPod and product.
- When the product is powered on and you connect an iPod, the product will charge your iPod's battery.
- Make sure to connect the dock connector so that the label "SAMSUNG" faces upward.
- "Made for iPod" means that an electronic accessory has been designed to connect specifically to the iPod and has been certified by the developer to meet Apple performance standards.
- "Works with iPhone" means that an electronic accessory has been designed to connect specifically to an iPhone and has been certified by the developer to meet Apple performance standards.

## iPod Music categories

File information including the artist name, album name, music title and genre will be displayed according to the ID3 Tag information on the appropriate music file.

<b>Now Playing</b>	Plays a recently played file or moves to the playback screen of the current file.
<b>Artist</b>	To play by artist.
<b>Songs</b>	To play in numeric or alphabetical order
<b>Playlist</b>	To play by Playlist.
<b>Album</b>	To play by album.
<b>Generic</b>	To play by genre.
<b>Composers</b>	To play by composer.

## NOTE

- The category list may differ, depending on the iPod model.
- **What is an ID3 Tag?**  
This is what is attached to an MP3 to carry information relevant to the file such as the title, artist, album, year, genre and a comment field.

## Watching a Movie

You can play video files stored in the iPod player by connecting it to the product.

1. Connect the iPod dock connector to the iPod Jack on the rear panel of the product.
2. In the iPod screen, move to **Settings** > **Videos**, then set the TV Out option and the TV signal.
3. Place the iPod in the supplied iPod Dock.
  - "iPod" message appears on the TV screen.
4. Press the **RED(A)** button.
5. Press the **▲▼** buttons to select **iPod**, then press the **ENTER** button.
6. Press the **◀▶** buttons to select **Videos**, then press the **ENTER** button.
7. Select the video file to play.
  - You can use the remote control or the product to control simple playback functions such as the **PLAY, PAUSE, STOP, ◀▶/▶▶** and **◀▶/▶▶** buttons. (See page 15.)

## iPod models that can be used with this product

<b>iPod nano</b> 3rd generation (video)	<b>iPod</b> 5th generation (video)	<b>iPod nano</b> 4th generation (video)
<b>iPod touch</b> 1st generation	<b>iPod touch</b> 2nd generation	<b>iPhone 3G</b>
<b>iPod classic</b>	<b>iPhone</b>	

## NOTE

- You must have the VIDEO output (Composite) connected to your TV to view iPod video (See page 24).
- If you want to iPod video via VIDEO output, set Anynet+(HDMI-CEC) to off.
- No other screen than the playback one will appear on the TV screen. Check other screens on the iPod player.
- If the connected iPod does not support video playback, the "Cannot play video files saved on this iPod" message appears when you select the Video menu.
- Apple is not responsible for the operation of this device or its compliance with safety and regulatory standards.



# Network Services

You can enjoy various network services such as Internet@TV or BD-LIVE by connecting the product to the network system.

Check the following instructions before using any network service.

1. Connect the product to the network.  
(see pages 26~27)
2. Configure the network settings.  
(see pages 39~41)

## Using Internet@TV

Connect this product to the network to download various for a fee or free-of-charge applications. Internet@TV brings useful and entertaining content and services directly from the web to your product such as news, weather forecasts, stock market quotes, games, movies and music.

You can also initiate this function by pressing the **INTERNET@** button on the remote control.



## Getting Started with Internet@TV

1. Move to the home menu.

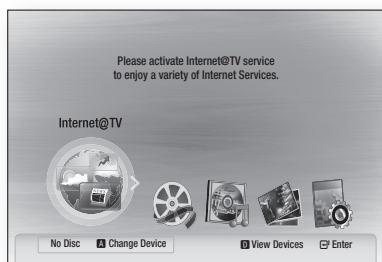

2. Press the ◀▶ buttons to select **Internet@TV** and press the **ENTER** button.
3. In the start screen of the Internet@TV service, you will see the service agreement screen. You must agree to the service terms and conditions before you can use the Internet@TV service.

4. After you have signed off on the service agreement, the Internet@TV service starts updating. It takes several minutes. When the update is complete, you will see the Internet@TV menu screen.

## Internet@TV at a Glance

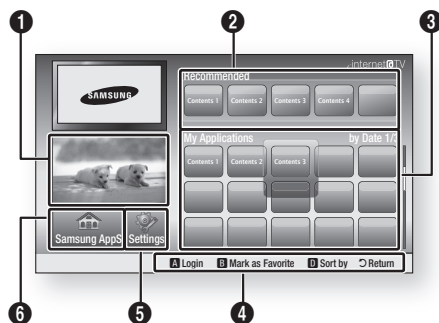

- |   |   |
|---|---|
| 1 | <b>Commercial</b> : Displays Internet@TV Guide, product introduction and new application introduction.  |
| 2 | <b>Recommended</b> : Displays recommended contents managed by Samsung.  |
| 3 | <b>My Application</b> : Displays your personal gallery which can be added and deleted by you.   |
| 4 | <b>Navigation Help</b> : Displays remote control buttons available. <ul style="list-style-type: none"> <li>• <b>RED(A)</b> : To log in to to Internet@TV.</li> <li>• <b>GREEN(B)</b> : To mark the application as a favorite.</li> <li>• <b>BLUE(D)</b> : To sort the applications.</li> <li>• <b>Return</b> : To return to the previous menu.</li> </ul> |
| 5 | <b>Settings</b> : You can set the system setup and create accounts, etc.  |
| 6 | <b>Samsung AppS</b> : You can download various chargeable or free-of-charge application services.   |

# Network Services

## Using the Keypad

Through your remote, you can use the On-Screen Keypad in several Internet@TV applications to enter text.

Pressing the **FULL SCREEN** button on the remote while you are using the Screen Keypad lets you to change the text fields to lower case, upper case, numbers and icons.

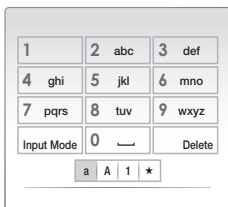

For example, here is how to search an address in Google Maps:

1. Press the **ENTER** button on the remote at the Google Maps icon at the Internet@TV.
2. Press the **GREEN(B)** button to use the SEARCH function.
3. Press the **◀▶** buttons to move to the "Search or address" window.
4. Press the **ENTER** button to use Search or address function.
5. For example, suppose that you want to input "105 Challenger Rd., Ridgefield Park NJ".
6. Press the **FULL SCREEN** button on the remote twice to change the input mode from lower case to numbers.
7. Press '1', '0', '5'.
8. Press the **YELLOW(C)** button on the remote to input a blank space.
9. Press the **FULL SCREEN** button on the remote 3 times to change the input mode from numbers to upper case.
10. Press '2' button on the remote 3 times to input **C**.
11. Press the **FULL SCREEN** button on the remote 3 times to change the input mode from upper case to lower case.
12. Press buttons on the remote to input the rest of 'Challenger Rd., Ridgefield Park NJ'.
13. Press the **ENTER** button.
14. The map and address appear on the screen.

## NOTE

- Samsung Electronics shall take no legal responsibility for any interruption of the Internet@TV service caused by the service provider for any reasons.
- The Internet@TV service is to download and process data via the Internet so that you can enjoy the contents on the TV screen. If the Internet connection is unstable, the service may be delayed or interrupted. Furthermore, the product may be turned off automatically. If this is the case, check the Internet connection and try again.
- The application service may be provided in English only and the contents available may vary, depending on the area.
- For more information about the Internet@TV service, visit the web site of the applicable service provider.
- The services provided are subject to change, depending on the Internet@TV service provider.
- The Internet@TV service contents may differ according to the firmware version.
- For-a-fee DivX contents with copy protection can only be played using HDMI cable. If you have connected your player to your TV using Component or video cables, the DivX video signal can not output or the popup message "Connect with a HDMI cable to play this file." or "Cannot play current file" will be displayed.

## Account Login

For a more enjoyable application experience, register and log in to your account.

To do this, you must create an account first. (For instructions on creating an account, refer to Internet@TV ID on this page)

1. Press the ▲▼◀▶ buttons to select the desired application and press the **RED(A)** button.

2. Enter the user account and password.

## Settings

Create IDs and configure Internet@TV settings from this screen.

## System Setup

### Reset

Resets Internet@TV settings to factory default settings.

### NOTE

- If you forgot your password, press the **STOP** (■) button on the front panel of the product for more than 5 seconds with no disc inserted.

## Internet@TV ID

Use this menu to create or delete an account and enter or delete account information.

You can control your account including contents site's account information.

This account is only for Internet@TV.

### Create

Create an account and link it with desired service applications.

### NOTE

- The account name must be at least 1 character in length but no more than 8.
- You can register up to 10 User Account Names.

### Manager

- **Service Site** : Register login information for service sites.
- **Change Password** : Change account password.
- **Delete** : Delete the account.

# Network Services

## Service Manager

Delete and lock applications installed to Internet@TV.

### Lock

Lock the application. Accessing a locked application requires the password.

### Delete

Delete the application.

## Properties

Display information about Internet@TV. Use the Check the speed of your internet connection option to test your network connection.

## Samsung AppS

Various applications are available from here, organized into different categories. Some applications have a download fee.

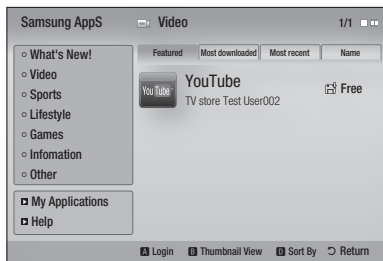

### My Application

Displays the application list.

### Help

If you questions about Internet@TV, check this section first. If none of the tips apply, please visit the help website.

## Using the colour buttons with the Samsung Apps

- **RED(A) (Login)** : To log in to the internet service.
- **GREEN(B) (Thumbnail View)** : To change the view mode.
- **BLUE(D) (Sort By)** : To sort the applications by Featured, Most Downloaded, Most Recent or Name.

## Internet@TV Services Available

- YouTube : You can view video streamed by YouTube.

### NOTE

- The available Internet contents services may be added or deleted.

## BD-LIVE™

Once the product is connected to the network, you can enjoy various movie-related service contents using a BD-LIVE compliant disc.

1. Check the size of the remaining memory.  
The memory device must have at least 1GB of free space to accommodate the BD-LIVE services.
2. Insert a Blu-ray disc that supports BD-LIVE.
3. Select an item from various BD-LIVE service contents provided by the disc manufacturer.

### NOTE

- The way you use BD-LIVE and the provided contents may differ, depending on the disc manufacturer.

## Software Upgrade Notification

In network connection, the product will notice you of any new software version with a popup message.

1. Turn on the product.
2. From the Software Upgrade menu, set Auto Upgrade Notification to **On**. (See page 43)  
If there is a new software version available, the product will notice you with a popup message.
3. To upgrade the firmware, select **Yes**.  
It will turn off automatically before restarting. (Never turn it on manually.)
4. The update progress popup will appear.  
When the update is completed, it will turn back off automatically.
5. Press the **POWER** button to turn on the product.



### NOTE

- Update will be completed when the product turns off after restarting. Press the **POWER** button to turn on the updated product for your use.  
Never turn off or on the product manually during the update process.
- Samsung Electronics shall take no legal responsibility for product malfunction caused by unstable of internet connection or consumer negligence during software upgrade.

## Using the AllShare Function

AllShare enables you to play music, video and photo files in your PC using the product.

To use AllShare, you must connect the product to your PC via the network (See pages 26~27) and install the SAMSUNG PC Share Manager on the PC.

1. Visit the Samsung website at [www.samsung.com](http://www.samsung.com).
2. Download the SAMSUNG PC Share Manager and install it on the PC.
3. When the installation is completed, you will see the SAMSUNG PC Share Manager icon on your desktop.  
Double-click the icon to launch the application.
4. Select a folder to share from the My computer pane, and click the **Share Folder Enabled icon** ().  
(To remove a shared folder : Select a folder to remove from the shared folders, and click the **Share Folder Disabled icon** ().)
5. To apply the updated sharing state to the server, click the **Set Change State icon** ().
6. To enable the product to locate a PC server, click **Share** from the menu bar.  
Click **Set Device Policy** and click **Accept**.

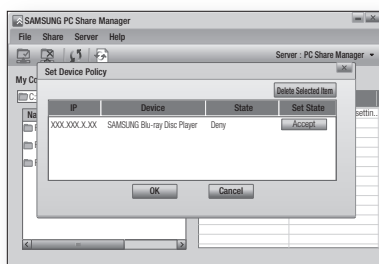

7. Click the **Set Change State icon** () and move to the home menu on the product.

# Network Services

8. To select a device, use the **RED(A)** or **BLUE(D)** button to select a file to play. (For playing back Video, Music or Photos files, see pages 44~52.)



## NOTE

- Depending on the performance of the external modem or router, HD video may not play properly.
- If your system uses a firewall, the product may not locate your PC on the TV screen.
- AllShare does not support the following functions.
  - The Background Music and Background Music Setting functions.
  - Sorting files by preference in the Photo, Music, and Movie folders.
  - The Change Group function.
  - The Safe Remove function.
- The Sorting method may differ depending on the server function.
- The search and skip operation may differ depending on the server function.
- During video playback, play time will not display.
- To use AllShare function, please locate both this product and PC in same subnet.

## Application Program at a Glance

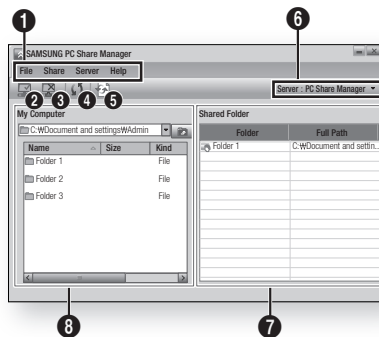

<b>1</b>	<b>Menu Bar</b>
<b>2</b>	<b>Share Folder Enabled icon</b> : Use this if you want to select a folder in your PC to share.
<b>3</b>	<b>Share Folder Disabled icon</b> : Use this if you want to set folder sharing off.
<b>4</b>	<b>Refresh icon</b> : Use this if you want to refresh list of folders and files in My Computer.
<b>5</b>	<b>Update icon</b> : Select a folder to share and don't forget to press this button. The updated state will be applied to the server.
<b>6</b>	<b>Server</b> : Displays the name of the sharing server.
<b>7</b>	<b>Shared Folder</b> : Displays a list of the shared folders.
<b>8</b>	<b>My Computer</b> : Displays a list of the folders and files in the PC.

## Troubleshooting

Refer to the chart below when this product does not function properly. If the problem you are experiencing is not listed below or if the instruction below does not help, turn off the product, disconnect the power cord, and contact the nearest authorized dealer or Samsung Electronics Service Centre.

Symptom	Check/Remedy
I cannot eject the disc.	<ul style="list-style-type: none"> <li>• Is the power cord plugged securely into the outlet?</li> <li>• Turn off the power and then turn it back on.</li> </ul>
The iPod fails to connect.	<ul style="list-style-type: none"> <li>• Check the condition of the iPod connector and Dock.</li> <li>• Keep the iPod S/W version up to date.</li> </ul>
Playback does not start.	<ul style="list-style-type: none"> <li>• Check the region number of the BD/DVD. BD/DVD discs purchased from abroad may not be playable.</li> <li>• CD-ROMs and DVD-ROMs cannot be played on this Product.</li> <li>• Make sure that the rating level is correct.</li> </ul>
Playback does not start immediately when the Play/Pause button is pressed.	<ul style="list-style-type: none"> <li>• Are you using a deformed disc or a disc with scratches on the surface?</li> <li>• Wipe the disc clean.</li> </ul>
Sound is not produced.	<ul style="list-style-type: none"> <li>• No sound is heard during fast playback, slow playback, and step motion playback.</li> <li>• Are the speakers connected properly? Is the speaker setup correctly customized?</li> <li>• Is the disc severely damaged?</li> </ul>
Sound can be heard only from a few speakers and not all 6.	<ul style="list-style-type: none"> <li>• On certain BD/DVD discs, sound is output from the front speakers only.</li> <li>• Check if the speakers are connected properly.</li> <li>• Adjust the volume.</li> <li>• When listening to a CD, radio or TV, sound is output to the front speakers only. Select "PRO LOGIC II" by pressing  PL II (Dolby Pro Logic II) on the remote control to use all six speakers.</li> </ul>
Dolby Digital 5.1 CH Surround Sound is not produced.	<ul style="list-style-type: none"> <li>• Is there "Dolby Digital 5.1 CH" mark on the disc? Dolby Digital 5.1 CH Surround Sound is produced only if the disc is recorded with 5.1 channel sound.</li> <li>• Is the audio language correctly set to Dolby Digital 5.1-CH in the information display?</li> </ul>
The remote control does not work.	<ul style="list-style-type: none"> <li>• Is the remote control being operated within its operation range of angle and distance?</li> <li>• Are the batteries drained?</li> <li>• Have you selected the mode(TV/BD) functions of the remote control (TV or BD) correctly?</li> </ul>
<ul style="list-style-type: none"> <li>• Disc is rotating but no picture is produced.</li> <li>• Picture quality is poor and picture is shaking.</li> </ul>	<ul style="list-style-type: none"> <li>• Is the TV power on?</li> <li>• Are the video cables connected properly?</li> <li>• Is the disc dirty or damaged?</li> <li>• A poorly manufactured disc may not be playable.</li> </ul>
Audio language and subtitles do not work.	<ul style="list-style-type: none"> <li>• Audio language and subtitles will not work if the disc does not contain them.</li> </ul>
Menu screen does not appear even when the menu function is selected.	<ul style="list-style-type: none"> <li>• Are you using a disc that does not contain menus?</li> </ul>

## Other information

Symptom	Check/Remedy
Aspect ratio cannot be changed.	<ul style="list-style-type: none"> <li>You can play 16:9 BD/DVDs in 16:9 Wide mode, 4:3 Letter Box mode, or 4:3 Pan - Scan mode, but 4:3 BD/DVDs can be seen in 4:3 ratio only. Refer to the Blu-ray Disc jacket and then select the appropriate function.</li> </ul>
<ul style="list-style-type: none"> <li>The product is not working. (Example: The power goes out or a strange noise is heard.)</li> <li>The Product is not working normally.</li> </ul>	<ul style="list-style-type: none"> <li>Turn off the power, and press and hold the <b>STOP</b> (■) button on the product for longer than 5 seconds with no disc inserted.               <ul style="list-style-type: none"> <li>- Using the RESET function will erase all stored settings. Do not use this unless necessary.</li> </ul> </li> </ul>
The rating level password has been forgotten.	<ul style="list-style-type: none"> <li>With no disc in the product, press and hold the product's <b>STOP</b> (■) button for longer than 5 seconds. <b>INIT</b> appears on the display and all settings will return to the default values. And then press the <b>POWER</b> button.               <ul style="list-style-type: none"> <li>- Using the RESET function will erase all stored settings. Do not use this unless necessary.</li> </ul> </li> </ul>
Can't receive radio broadcasts.	<ul style="list-style-type: none"> <li>Is the antenna connected properly?</li> <li>If the antenna's input signal is weak, install an external FM antenna in an area with good reception.</li> </ul>
While listening to TV audio through the Product, no sound is heard.	<ul style="list-style-type: none"> <li>If the <b>OPEN/CLOSE</b> (▲) button is pressed while listening to TV audio using the D.IN or AUX functions, the BD/DVD functions are turned on and the TV audio is muted.</li> </ul>
"Not Available" appears on screen.	<ul style="list-style-type: none"> <li>The features or action cannot be completed at this time because:               <ol style="list-style-type: none"> <li>The BD/DVD's software restricts it.</li> <li>The BD/DVD's software doesn't support the feature (e.g., angles)</li> <li>The feature is not available at the moment.</li> <li>You've requested a title or chapter number or search time that is out of range.</li> </ol> </li> </ul>
If the HDMI output is set to a resolution your TV cannot support (for example, 1080p), you may not see a picture on your TV.	<ul style="list-style-type: none"> <li>Press and hold the <b>STOP</b> (■) button on front panel for more than 5 seconds with no disc inserted. All settings will revert to the factory settings.</li> <li>When the factory default settings are restored, all the user data stored in the BD data will be deleted.</li> </ul>
No HDMI output.	<ul style="list-style-type: none"> <li>Check the connection between the TV and the HDMI jack of the Product.</li> <li>Check if your TV supports 576p(480p)/720p/1080i/1080p HDMI input resolution.</li> </ul>
Abnormal HDMI output screen.	<ul style="list-style-type: none"> <li>If random noise appears on the screen, it means that TV does not support HDCP (High-bandwidth Digital Content Protection).</li> </ul>



Symptom	Check/Remedy
<b>PC Share Manager function</b>	
I can see folders shared through the PC Share Manager, but I cannot see the files.	<ul style="list-style-type: none"> <li>• Since it shows only files corresponding to the Image, Music, and Movie categories, files that do not correspond to these categories may not be displayed.</li> </ul>
<b>AllShare function</b>	
Video is played intermittently.	<ul style="list-style-type: none"> <li>• Check if the network is stable.</li> <li>• Check if the network cable is properly connected and if the network is not overloaded.</li> <li>• Wireless connection between the server and the product is unstable. Check the connection.</li> </ul>
AllShare connection between TV and PC is unstable.	<ul style="list-style-type: none"> <li>• IP address under the same subnetwork should be unique, otherwise IP collision can result in such a phenomenon.</li> <li>• Check if you have a firewall enabled. If so, disable the firewall function.</li> </ul>
<b>BD-LIVE</b>	
I cannot connect to the BD-LIVE server.	<ul style="list-style-type: none"> <li>• Check whether the network connection is successful or not by using Network Test menu. (See page 41)</li> <li>• Check whether the USB memory device is connected with product or not.</li> <li>• The memory device must have at least 1GB of free space to accommodate the BD-LIVE service. You can check the available size in BD Data Management. (See page 36)</li> <li>• Please check whether the BD-LIVE Internet Connection menu is set to Allow(All).</li> <li>• If all above fails, contact the contents provider or update the latest firmware.</li> </ul>
When using the BD-LIVE service, an error occurs.	<ul style="list-style-type: none"> <li>• The memory device must have at least 1GB of free space to accommodate the BD-LIVE service. You can check the available size in BD Data Management. (See page 36)</li> </ul>

 **NOTE**

- When the factory default settings are restored, all the user data stored in the BD data will be deleted.

# Other information

## Specifications

General	Weight	3.5 kg	
	Dimensions	430 (W) x 63 (H) x 325 (D) mm	
	Operating Temperature Range	+5°C to +35°C	
	Operating Humidity Range	10 % to 75 %	
FM Tuner	Signal/noise ratio	70 dB	
	Usable sensitivity	10 dB	
	Total harmonic distortion	0.5 %	
Disc	BD (Blu-ray Disc)	Reading Speed : 4.917m/sec	
	DVD (Digital Versatile Disc)	Reading Speed : 3.49 ~ 4.06 m/sec. Approx. Play Time (Single Sided, Single Layer Disc) : 135 min.	
	CD : 12cm (COMPACT DISC)	Reading Speed : 4.8 ~ 5.6 m/sec. Maximum Play Time : 74 min.	
	CD : 8cm (COMPACT DISC)	Reading Speed : 4.8 ~ 5.6 m/sec. Maximum Play Time : 20 min.	
Video Output	Composite Video	1 channel : 1.0 Vp-p (75 Ω load) Blu-ray Disc : 576i(480i)                      DVD : 576i(480i)	
	Component Video	Y : 1.0 Vp-p (75 Ω load) Pr : 0.70 Vp-p (75 Ω load) Pb : 0.70 Vp-p (75 Ω load) Blu-ray Disc : 1080i, 720p, 576p(480p), 576i(480i) DVD : 576p(480p), 576i(480i)	
Video/Audio	HDMI	1080p, 1080i, 720p, 576p(480p) PCM multichannel audio, Bitstream audio, PCM audio	
Amplifier	Front speaker output	165W x 2(3Ω)	
	Centre speaker output	170W(3Ω)	
	Surround speaker output	165W x 2(3Ω)	
	Subwoofer speaker output	170W(3Ω)	
	Frequency response	Analogue input	20Hz~20kHz (±3dB)
		Digital input	20Hz~44kHz (±3dB)
	S/N Ratio	70dB	
	Channel separation	60dB	
Input sensitivity	(AUX)500mV		

## HT-C5500

Speaker	Speaker system	5.1ch speaker system			
		Front	Surround	Centre	Subwoofer
	Impedance	3 Ω	3 Ω	3 Ω	3 Ω
	Frequency range	140Hz~20kHz	140Hz~20kHz	140Hz~20kHz	40Hz ~ 160Hz
	Output sound pressure level	87dB/W/M	87dB/W/M	87dB/W/M	88dB/W/M
	Rated input	165W	165W	170W	170W
	Maximum input	330W	330W	340W	340W
	Dimensions (W x H x D)	Front : 90 x 207.5 x 68.5 mm Surround : 90 x 141.5 x 68.5 mm Centre : 360 x 74.5 x 68.5 mm Subwoofer : 168 x 350 x 295 mm			
	Weights	Front : 0.67 kg, Surround : 0.58 kg Centre : 0.57 kg, Subwoofer : 3.80 kg			

## HT-C5530

Speaker	Speaker system	5.1ch speaker system			
		Front	Surround	Centre	Subwoofer
	Impedance	3 Ω	3 Ω	3 Ω	3 Ω
	Frequency range	140Hz ~ 20kHz	140Hz~20kHz	140Hz~20kHz	40Hz ~ 160Hz
	Output sound pressure level	87dB/W/M	87dB/W/M	87dB/W/M	88dB/W/M
	Rated input	165W	165W	170W	170W
	Maximum input	330W	330W	340W	340W
	Dimensions (W x H x D)	Front : 90 x 1300 x 119 mm (Stand base : 250 x 250 mm) Surround : 90 x 141.5 x 68.5 mm Centre : 360 x 74.5 x 68.5 mm Subwoofer : 168 x 350 x 295 mm			
	Weights	Front : 3.27 kg, Surround : 0.58 kg Centre : 0.57 kg, Subwoofer : 3.80 kg			

## HT-C5550

Speaker	Speaker system	5.1ch speaker system			
		Front	Surround	Centre	Subwoofer
	Impedance	3 Ω	3 Ω	3 Ω	3 Ω
	Frequency range	140Hz ~ 20kHz	140Hz~20kHz	140Hz~20kHz	40Hz ~ 160Hz
	Output sound pressure level	87dB/W/M	87dB/W/M	87dB/W/M	88dB/W/M
	Rated input	165W	165W	170W	170W
	Maximum input	330W	330W	340W	340W
	Dimensions (W x H x D)	Front : 90 x 1300 x 119 mm (Stand base : 250 x 250 mm) Surround : 90 x 1300 x 119 mm (Stand base : 250 x 250 mm) Centre : 360 x 74.5 x 68.5 mm Subwoofer : 168 x 350 x 295 mm			
	Weights	Front : 3.27 kg, Surround : 2.88 kg Centre : 0.57 kg, Subwoofer : 3.80 kg			

\*: Nominal specification

- Samsung Electronics Co., Ltd reserves the right to change the specifications without notice.
- Weight and dimensions are approximate.
- Design and specifications are subject to change without prior notice.
- For the power supply and Power Consumption, refer to the label attached to the product.

## Contact SAMSUNG WORLD WIDE

If you have any questions or comments relating to Samsung products, please contact the SAMSUNG customer care centre.

Area	Contact Centre ☎	Web Site
<b>■ North America</b>		
Canada	1-800-SAMSUNG (726-7864)	www.samsung.com
Mexico	01-800-SAMSUNG (726-7864)	www.samsung.com
U.S.A	1-800-SAMSUNG (726-7864)	www.samsung.com
<b>■ Latin America</b>		
Argentina	0800-333-3733	www.samsung.com
Brazil	0800-124-421 4004-0000	www.samsung.com
Chile	800-SAMSUNG (726-7864)	www.samsung.com
Nicaragua	00-1800-5077267	www.samsung.com
Honduras	800-7919267	www.samsung.com
Costa Rica	0-800-507-7267	www.samsung.com
Ecuador	1-800-10-7267	www.samsung.com
El Salvador	800-6225	www.samsung.com
Guatemala	1-800-299-0013	www.samsung.com
Jamaica	1-800-234-7267	www.samsung.com
Panama	800-7267	www.samsung.com
Puerto Rico	1-800-682-3180	www.samsung.com
Rep. Dominica	1-800-751-2676	www.samsung.com
Trinidad & Tobago	1-800-SAMSUNG (726-7864)	www.samsung.com
Venezuela	0-800-100-5303	www.samsung.com
Colombia	01-8000112112	www.samsung.com
<b>■ Europe</b>		
Austria	0810 - SAMSUNG (7267864, € 0.07/min)	www.samsung.com
Belgium	02-201-24-18	www.samsung.com/ be (Dutch) www.samsung.com/ be_fr (French)
Czech	800 - SAMSUNG (800-726786)	www.samsung.com
Denmark	70 70 19 70	www.samsung.com
Finland	030 - 6227 515	www.samsung.com
France	01 48 63 00 00	www.samsung.com
Germany	01805 - SAMSUNG (726-7864 € 0,14/Min)	www.samsung.com
Hungary	06-80-SAMSUNG (726-7864)	www.samsung.com
Italia	800-SAMSUNG (726-7864)	www.samsung.com
Luxemburg	261 03 710	www.samsung.com
Netherlands	0900-SAMSUNG (0900-7267864) (€ 0,10/Min)	www.samsung.com
Norway	815-56 480	www.samsung.com
Poland	0 801 1SAMSUNG (172678) 022-607-93-33	www.samsung.com
Portugal	80820-SAMSUNG (726-7864)	www.samsung.com
Slovakia	0800-SAMSUNG (726-7864)	www.samsung.com
Spain	902 - 1 - SAMSUNG (902 172 678)	www.samsung.com
Sweden	0771 726 7864 (SAMSUNG)	www.samsung.com
U.K	0845 SAMSUNG (7267864)	www.samsung.com
Eire	0818 717100	www.samsung.com

Area	Contact Centre ☎	Web Site
Switzerland	0848 - SAMSUNG (7267864, CHF 0.08/min)	www.samsung.com/ch www.samsung.com/ ch_fr/ (French)
Lithuania	8-800-77777	www.samsung.com
Latvia	8000-7267	www.samsung.com
Estonia	800-7267	www.samsung.com
<b>■ CIS</b>		
Russia	8-800-555-55-55	www.samsung.com
Georgia	8-800-555-555	
Armenia	0-800-05-555	
Azerbaijan	088-55-55-555	
Kazakhstan	8-10-800-500-55-500	
Uzbekistan	8-10-800-500-55-500	www.samsung.com
Kyrgyzstan	00-800-500-55-500	www.samsung.com
Tadjikistan	8-10-800-500-55-500	www.samsung.com
Ukraine	0-800-502-000	www.samsung.ua www.samsung.com/ ua_ru
Belarus	810-800-500-55-500	
Moldova	00-800-500-55-500	
<b>■ Asia Pacific</b>		
Australia	1300 362 603	www.samsung.com
New Zealand	0800 SAMSUNG (0800 726 786)	www.samsung.com
China	400-810-5858 010-6475 1880	www.samsung.com
Hong Kong	(852) 3698-4698	www.samsung.com/ hk www.samsung.com/ hk_en/
India	3030 8282 1800 110011 1800 3000 8282 1800 266 8282	www.samsung.com
Indonesia	0800-112-8888 021-5699-7777	www.samsung.com
Japan	0120-327-527	www.samsung.com
Malaysia	1800-88-9999	www.samsung.com
Philippines	1-800-10-SAMSUNG (726-7864) 1-800-3-SAMSUNG (726-7864) 1-800-8-SAMSUNG (726-7864) 02-5805777	www.samsung.com
Singapore	1800-SAMSUNG (726-7864)	www.samsung.com
Thailand	1800-29-3232 02-689-3232	www.samsung.com
Taiwan	0800-329-999	www.samsung.com
Vietnam	1 800 588 889	www.samsung.com
<b>■ Middle East &amp; Africa</b>		
Turkey	444 77 11	www.samsung.com
South Africa	0860-SAMSUNG (726-7864)	www.samsung.com
U.A.E	800-SAMSUNG (726-7864)	www.samsung.com
Bahrain	8000-4726	
Jordan	800-22273	

# SAMSUNG



## Correct disposal of batteries in this product

---

(Applicable in the European Union and other European countries with separate battery return systems.)

This marking on the battery, manual or packaging indicates that the batteries in this product should not be disposed of with other household waste at the end of their working life. Where marked, the chemical symbols Hg, Cd or Pb indicate that the battery contains mercury, cadmium or lead above the reference levels in EC Directive 2006/66. If batteries are not properly disposed of, these substances can cause harm to human health or the environment.

To protect natural resources and to promote material reuse, please separate batteries from other types of waste and recycle them through your local, free battery return system.



## Correct Disposal of This Product (Waste Electrical & Electronic Equipment)

---

(Applicable in the European Union and other European countries with separate collection systems)

This marking on the product, accessories or literature indicates that the product and its electronic accessories (e.g. charger, headset, USB cable) should not be disposed of with other household waste at the end of their working life. To prevent possible harm to the environment or human health from uncontrolled waste disposal, please separate these items from other types of waste and recycle them responsibly to promote the sustainable reuse of material resources.

Household users should contact either the retailer where they purchased this product, or their local government office, for details of where and how they can take these items for environmentally safe recycling.

Business users should contact their supplier and check the terms and conditions of the purchase contract. This product and its electronic accessories should not be mixed with other commercial wastes for disposal.



Code No. AH68-02258B