

**SAMSUNG**

# *Instruction Manual*

---

# DVD-V9800

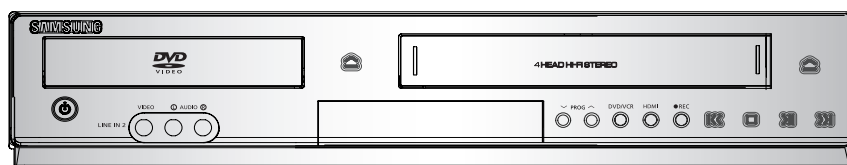

**DVD**  
VIDEO **Hi-Fi**

[www.samsung.com](http://www.samsung.com)

AK68-01623B-01

## Important Safety Instructions

- 1) Read these instructions.
- 2) Keep these instructions.
- 3) Heed all warnings.
- 4) Follow all instructions.
- 5) Do not use this apparatus near water.
- 6) Clean only with a dry cloth.
- 7) Do not block any ventilation openings, Install in accordance with the manufacturer's instructions.
- 8) Do not install near any heat sources such as radiators, heaters, or other apparatus (including amplifiers) that produce heat.
- 9) Do not defeat the safety purpose of the polarized or grounding- type plug. A polarized plug has two blades with one wider than the other. A grounding type plug has two blades and a third grounding prong. The wide blade and the third prong are provided for your safety. If the provided plug does not fit into your outlet, consult an electrician for replacement of the outlet.
- 10) Protect the power cord from being walked on or pinched particularly at plugs, convenience receptacles, and the point where they exit from the apparatus.
- 11) Only use attachments/accessories specified by the manufacturer.
- 12) Use only with a cart, stand, tripod, bracket, or table specified by the manufacturer, or sold with the apparatus.
- 13) When a cart is used, unplug this apparatus and use caution when moving the cart/apparatus combination to avoid injury from tip-over.
- 14) Refer all servicing to qualified service personnel. Servicing is required when the apparatus has been damaged in any way, such as the power-supply cord or plug is damaged, liquid has been spilled or objects have fallen into the apparatus. Service is also required if the apparatus has been exposed to rain or moisture, does not operate normally, or has been dropped.



## SAFETY INSTRUCTIONS

### Precautions



TO REDUCE THE RISK OF ELECTRIC SHOCK, DO NOT REMOVE THE COVER (OR BACK). NO USER-SERVICEABLE PARTS ARE INSIDE. REFER SERVICING TO QUALIFIED SERVICE PERSONNEL.

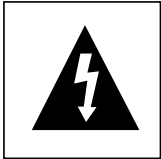

This symbol indicates “dangerous voltage” inside the product that presents a risk of electric shock or personal injury.



This symbol indicates important instructions accompanying the product.

Do not install this equipment in a confined space such as a bookcase or similar unit.

**WARNING :** To prevent damage which may result in fire or electric shock hazard, do not expose this appliance to rain or moisture.

**Note to CATV system installer:** This reminder is provided to call CATV system installer’s attention to Article 820-40 of the National Electrical Code (Section 54 of Canadian Electrical Code, Part I) that provides guidelines for proper grounding and, in particular, specifies that the cable ground shall be connected to the grounding system of the building as close to the point of cable entry as practical.

**Caution:** FCC regulations state that any unauthorized changes or modifications to this equipment may void the user’s authority to operate it.

- Apparatus shall not be exposed to dripping or splashing and no objects filled with liquids, such as vases, shall be placed on the apparatus.
- If this power supply is used at 240V ac, a suitable plug adapter should be used.

#### FCC NOTE (for U.S.A):

This equipment has been tested and found to comply with the limits for a Class B digital device, pursuant to Part 15 of the FCC rules. These limits are designed to provide reasonable protection against harmful interference in a residential installation. This equipment generates, uses and can radiate radio frequency energy and, if not installed and used in accordance with the instructions, may cause harmful interference to radio or television reception, which can be determined by turning the equipment off and on.

The user is encouraged to try to correct the interference by one or more of the following measures.

- Reposition or relocate the receiving antenna.
- Increase the separation between the equipment and receiver.
- Connect this equipment into an outlet on a circuit different from that to which the receiver is connected.
- Consult the dealer or an experienced radio/TV technician for help.

This class B digital apparatus meets all requirements of the Canadian Interference -- Causing Equipment Regulations.

**CLASS 1 LASER PRODUCT**  
**KLASSE 1 LASER PRODUKT**  
**LUOKAN 1 LASER LAITE**  
**KLASS 1 LASER APPARAT**  
**PRODUCTO LÁSER CLASE 1**

## **CAUTION**

THIS PRODUCT UTILIZES A LASER. USE OF CONTROLS OR ADJUSTMENTS OR PERFORMANCE OF PROCEDURES OTHER THAN THOSE SPECIFIED HEREIN MAY RESULT IN HAZARDOUS RADIATION EXPOSURE. DO NOT OPEN COVER AND DO NOT REPAIR YOURSELF. REFER SERVICING TO QUALIFIED PERSONNEL.

### **Note:**

- This unit can be used only where the power supply is AC 120V, 60Hz. It cannot be used elsewhere.
- This DVD player is designed and manufactured to respond to the Region Management Information. If the Region number of a DVD disc does not correspond to the Region number of this DVD player, the DVD player cannot play the disc.
- The product unit accompanying this user manual is licensed under certain intellectual property rights of certain third parties. In particular, this product is licensed under the following US patents: 5,060,220 5,457,669 5,561,649 5,705,762 5,987,417 6,043,912 6,222,983 6,272,096 6,377,524 6,377,531 6,385,587 6,389,570 6,408,408 6,466,532 6,473,736 6,477,501 6,480,829 6,556,520 6,556,521 6,556,522 6,578,163 6,594,208 6,631,110 6,658,588 6,674,697 6,674,957 6,687,455 6,697,307 6,707,985 6,721,243 6,721,493 6,728,474 6,741,535 6,744,713 6,744,972 6,765,853 6,765,853 6,771,890 6,771,891 6,775,465 6,778,755 6,788,629 6,788,630 6,795,637 6,810,201 6,862,256 6,868,054 6,894,963 6,937,552, 6,836,549; 6,381,747; 7,050,698; 6,516,132; and 5,583,936.

This license is limited to private non-commercial use by end-user consumers for licensed contents.

No rights are granted for commercial use. The license does not cover any product unit other than this product unit and the license does not extend to any unlicensed product unit or process conforming to ISO/IEC 11172-3 or ISO/IEC 13818-3 used or sold in combination with this product unit.

The license only covers the use of this product unit to encode and/or decode audio files conforming to the ISO/IEC 11172-3 or ISO/IEC 13818-3. No rights are granted under this license for product features or functions that do not conform to the ISO/IEC 11172-3 or ISO/IEC 13818-3.

## **Handling Cautions**

- Before connecting other components to this player, be sure to turn them all off.
- Do not move the player while a disc is being played, or the disc may be scratched or broken, and the player's internal parts may be damaged.
- Do not put a flower vase filled with water or any small metal objects on the player.
- Be careful not to put your hand into the disc tray.
- Do not place anything other than the disc in the disc tray.
- Exterior interference such as lightning and static electricity can affect normal operation of this player. If this occurs, turn the player off and on again with the POWER button, or disconnect and then reconnect the AC power cord to the AC power outlet. The player will operate normally.
- Be sure to remove the disc and turn off the player after use.
- Disconnect the AC power cord from the AC outlet when you don't intend to use the player for long periods of time.
- Clean the disc by wiping in a straight line from the inside to the outside of the disc.
- The Mains plug is used as a disconnect device and shall stay readily operable at anytime.

## **Disc Storage**

Be careful not to harm the disc because the data on these discs is highly vulnerable to the environment.

- Do not keep under direct sunlight.
- Keep in a cool ventilated area.
- Store vertically.
- Keep in a clean protection jacket.

## **Maintenance of Cabinet**

For safety reasons, be sure to disconnect the AC power cord from the AC outlet.

- Do not use benzene, thinner, or other solvents for cleaning.
- Wipe the cabinet with a soft cloth.

# Before you start

## Accessories



Remote Control  
AK59-00061J



Batteries-2EA  
1.5V(AAA)  
AC43-12002H



Video/Audio Cable  
AC39-00073A

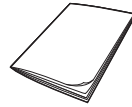

User's Guide  
AK68-01623B

## Install Batteries in the Remote Control

**1**

Open the battery cover on the back of the remote control.

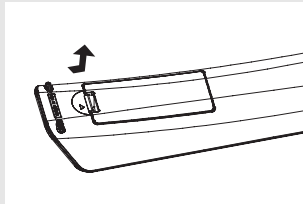

**2**

Insert two AAA batteries. Make sure that the polarities (+ and -) are aligned correctly.

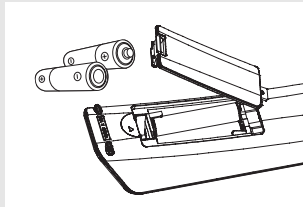

**3**

Replace the battery cover.

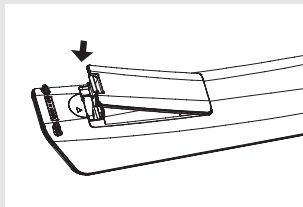

### If the remote control doesn't operate properly:

- Check the polarity +, - of the batteries.
- Check if the batteries are drained.
- Check if the remote control sensor is blocked by obstacles.
- Check if there is any fluorescent lighting nearby.

## Table of Contents

Safety Instructions .....	2
Important Safety Instructions .....	2
Precautions .....	3
Before you start .....	5
Accessories.....	5
Install Batteries in the Remote Control .....	5

### Chapter 1: Setup

General Features.....	8
Disc Type and Characteristics .....	9
Description.....	10
Tour of the Remote Control.....	12

### Chapter 2: Connections

Before Connecting the DVD-VCR .....	13
Connecting a Set-top/Cable/Satellite Box to the DVD-VCR .....	13
Connection to a TV .....	14
Connecting to a TV with an HDMI Jack .....	14
Connecting to a TV (Progressive).....	16
Connecting to a TV (Interlace) .....	17
Connecting to a TV (Video).....	18
Connection to an Audio System .....	19
Connecting to an Audio System (2 Channel Amplifier, Analog) .....	19
Connecting to an Audio System (Dolby digital, MPEG2 or DTS Amplifier).....	20
Connecting the Power Cord .....	21

### Chapter 3: Initial Setup

Selecting a Menu Language .....	22
Setting the Clock .....	23
Setting the Clock Manually .....	23
Setting the Front Panel Display .....	24
Setting the Auto Power Off .....	25

### Chapter 4: DVD Operations

Playing a Disc .....	26
Using the Search and Skip Functions .....	28
Using the Display Function .....	29
Using the Disc and Title Menu (DVD) .....	31
Using the Function Menu (DVD) .....	32
Repeat Play .....	33
Slow Play .....	34
Adjusting the Aspect Ratio (EZ View) .....	35
Selecting the Audio Language .....	37

## TABLE OF CONTENTS

Selecting the Subtitle Language .....	38
Changing the Camera Angle .....	39
Using the Bookmark Function (DVD) .....	39
Using the Zoom Function (DVD) .....	41
Clips Menu for CD Audio/MP3/WMA/JPEG/MPEG4 files .....	42
Folder Selection .....	42
CD Audio/MP3/WMA Playback .....	43
MPEG4 Playback .....	45
Picture CD Playback .....	47
Using the Setup Menu .....	49
Setting Up the Language Features .....	50
Setting Up the Audio Options .....	52
Setting Up the Display Options .....	54
Setting Up the Parental Control .....	58
DivX(R) Registration .....	61

### **Chapter 5: VCR Operations**

Inserting and Ejecting a Video Cassette Tape .....	62
Playing a Pre-Recorded Video Cassette Tape .....	63
Special VCR Playback Features .....	64
Using Automatic Tracking .....	65
Selecting the Cassette Type .....	66
Setting the Auto Play .....	67
Setting the Auto Repeat .....	68
Using the Tape Counter .....	69
Using the Assemble Edit Function .....	70
Selecting the Audio Output Mode .....	71
Searching for a Specific Sequence .....	72
Basic Recording .....	74
Special Recording Features .....	75
Using One-Touch Recording .....	76
Selecting the Recording Speed .....	77
Making a Timer Recording .....	78

### **Chapter 6: Reference**

Using the TV Buttons on the Remote Control .....	80
Troubleshooting .....	81
Technical Specifications .....	83

# Chapter 1

## SETUP

## General Features

### DVD-VCR Features

- Perfect compatibility to play back DVDs, audio CDs or VHS Tapes.
- Composite, Component Video and HDMI outputs.
- On-Screen Program (English/French/Spanish).

### DVD Features

- 10-bit video digital to analog converter and 54MHz advanced digital filter.
- Playback of 96KHz/24-bit sources.
- DTS digital output for DTS-enhanced DVDs.
- This unit can play MPEG4 formats within an avi file.
- Playback MP3-CDs.

### VCR Features

- Hi-Fi Stereo VCR.
- Superior slow motion and stop action (with 4 heads).
- Playback of S-VHS tapes with a better than standard resolution.
- INTRO Scan, Zero Return, and END Search.
- Time remaining counter, real time counter.

#### Note

- Discs which cannot be played with this player.
  - DVD-ROM/DVD-RAM/VCD
  - CDI/CDV
  - Super Audio CD (CD, HD layer)
  - CDGs play audio only, not graphics.
  - DVD-RW (VR mode)
  - Non finalized DVD-RW, -R, DVD+RW, and +R discs.
- Ability to play back may depend on recording conditions.
  - DVD-RW, -R/CD-RW/DVD+RW, +R/CD-ROM
- This DVD-VCR unit does not have a TV tuner. Recording TV broadcasts is possible via Connection to Cable/Satellite boxes and Multi Channel Video Services.

#### Note

This product incorporates copyright protection technology that is protected by U.S. patents and other intellectual property rights. Use of this copyright protection technology must be authorized by Macrovision, and is intended for home and other limited viewing uses only unless otherwise authorized by Macrovision. Reverse engineering or disassembly is prohibited.

## COPY PROTECTION

Many DVD discs are encoded with copy protection. Because of this, you should only connect your DVD-VCR directly to your TV, not to a VCR. Connecting to a VCR results in a distorted picture from copy-protected DVD discs.

This product incorporates copyright protection technology that is protected by methods claims of certain U.S. patents and other intellectual property rights owned by Macrovision Corporation and other rights owners. Use of this copyright protection technology must be authorized by Macrovision Corporation, and is intended for home and other limited viewing uses only unless otherwise authorized by Macrovision Corporation. Reverse engineering or disassembly is prohibited.

## PROGRESSIVE SCAN



### OUTPUT SETTING

PLEASE NOTE THAT NOT ALL HIGH DEFINITION TELEVISION SETS ARE FULLY COMPATIBLE WITH THIS PRODUCT AND MAY CAUSE ARTIFACTS TO BE DISPLAYED IN THE PICTURE. IF PROGRESSIVE SCAN PICTURE PROBLEMS OCCUR, WE RECOMMEND SWITCHING THE CONNECTION TO THE 'STANDARD DEFINITION' OUTPUT. IF THERE ARE QUESTIONS REGARDING YOUR TV SET COMPATIBILITY WITH THIS DVD-VCR, PLEASE CONTACT SAMSUNG'S CUSTOMER SERVICE CENTER.





## Disc Type and Characteristics

This DVD-VCR is capable of playing the following types of discs with the corresponding logos:

Disc Types (Logos)	Recording Types	Disc Size	Max. Playing Time	Characteristics
<b>DVD</b> 	Audio + Video	5"	Single-sided 240 min. Double-sided 480 min.	- DVD contains excellent sound and video due to Dolby Digital and MPEG-2 system. - Various screen and audio functions can be easily selected through the on-screen menu.
		3 1/2"	Single-sided 80 min. Double-sided 160 min.	
<b>AUDIO-CD</b> 	Audio	5"	74 min.	- CD is recorded as a Digital Signal with better audio quality, less distortion and less deterioration of audio quality over time.
		3 1/2"	20 min.	

- CD-R, CD-RW and DVD-RW, -R, DVD+RW, +R discs may not be playable in all cases due to the disc type or condition of the recording.
- Do not run the player with two discs loaded at the same time.

### Disc Markings

	Play Region Number
	NTSC broadcast system in U.S.A, Canada, Korea, Japan, etc.
	Dolby Digital disc
	Stereo disc
	Digital Audio disc
	DTS disc
	MP3 disc

### Region Number

Both the DVD-VCR and the discs are coded by region. These regional codes must match in order for the disc to play. If the codes do not match, the disc will not play.

The Region Number for this player is described on the rear panel of the player.



### DivX Certification

**You must only insert one DVD disc at a time. Inserting two or more discs will not allow playback and may cause damage to the DVD-VCR.**

DivX, DivX Certified, and associated logos are trademarks of DivXNetworks, Inc and are used under license.



# Description

## Front Panel Controls

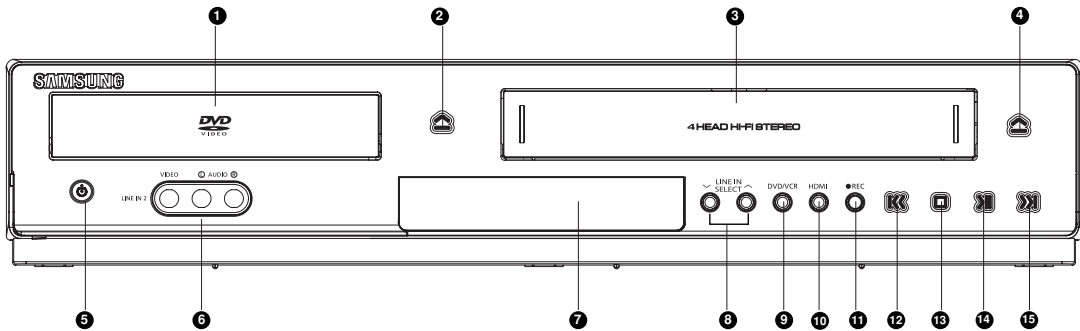

- |  |   |
|--|---|
| <p><b>1 DISC TRAY</b><br/>Place the disc here.</p> <p><b>2 ▲ OPEN/CLOSE</b><br/>Press to open and close the disc tray.</p> <p><b>3 VCR Deck</b><br/>Insert a standard VHS video tape.</p> <p><b>4 ▲ EJECT</b><br/>Press to eject a video tape if the tape is stopped.</p> <p><b>5 ⏻ (POWER)</b><br/>Press to turn the DVD-VCR on and off.</p> <p><b>6 LINE IN 2</b><br/>Connects to the Video/Audio output jack of your external device.</p> <p><b>7 Front Panel Display</b><br/>Operation indicators are displayed here.</p> <p><b>8 LINE IN SELECT</b><br/>Press to select Line Input 1 or 2. These buttons are also used as Tracking buttons for the VCR.</p> | <p><b>9 DVD/VCR</b><br/>Press to select DVD or VCR mode.</p> <p><b>10 HDMI</b><br/>HDMI Output resolution setup.</p> <p><b>11 ● REC (VCR)</b><br/>Press to begin recording.</p> <p><b>12 ◀◀ (Reverse/Rewind)</b><br/>Press to reverse/rewind a disc/video tape.</p> <p><b>13 ■ (STOP)</b><br/>Press to stop a disc/video tape during playback or record (VCR).</p> <p><b>14 ▶▶ (Play/Pause)</b><br/>Press to play or pause the disc/video tape.</p> <p><b>15 ▶▶▶ (Forward/Fast Forward)</b><br/>Press to forward/fast forward a disc/videotape.</p> |
|--|---|

## Front Panel Display

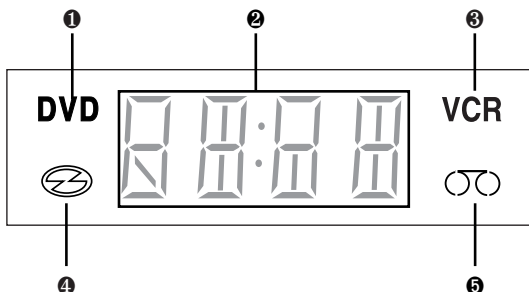

- |   |
|---|
| <p><b>1</b> DVD is activated.</p> <p><b>2</b> The time, counter position, time remaining or current deck status is indicated.</p> <p><b>3</b> VCR is activated.</p> <p><b>4</b> DVD or CD media is loaded.</p> <p><b>5</b> VHS videotape is loaded.</p> |
|---|

## Rear Panel

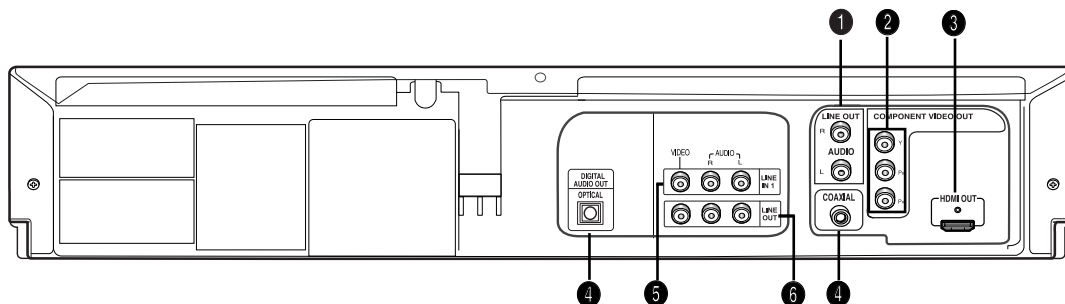

- 1 AUDIO OUT**  
 Connect to the Audio input jacks of your television.
- 2 COMPONENT VIDEO OUT**  
 - Use these jacks if you have a TV with Component Video in jacks.  
 These jacks provide PR, PB and Y video.
- 3. HDMI OUT JACK**  
 - Use an HDMI cable to connect this jack to the HDMI jack on your television for the best quality picture.  
 - If an HDMI cable is connected to an HDMI-compatible TV, HDMI will be output automatically within 10 seconds.  
 - If you want to use the Video or Component Output, unplug the HDMI cable.
- 4 DIGITAL AUDIO OUT (OPTICAL/COAXIAL)**  
 - Use either an optical or coaxial digital audio cable to connect to a compatible Dolby Digital receiver.  
 - Use either an optical or coaxial digital audio cable to connect to an A/V Amplifier that contains a Dolby Digital, MPEG2 or DTS decoder.
- 5 LINE IN 1 (VIDEO/AUDIO)**  
 Connect to the Video/Audio output jack of your external device.
- 6 LINE OUT (VIDEO/AUDIO)**  
 Use a Video/Audio cable to connect to the Video/Audio input jacks on your television. You must have these jacks connected to see video playback from the VCR on your TV.

## DVD/VCR Output Chart

Type of Connection	DVD Output Jacks	VCR Output Jacks
COMPONENT VIDEO OUT	O	X
AUDIO OUT (L,R)	O	X
DIGITAL AUDIO OUT (OPTICAL, COAXIAL)	O	X
LINE OUT (A/V)	O	O
HDMI OUT	O	X

◀ O : Active.  
 X : Inactive.

### Notes

- Consult your TV User's Manual to find out if your TV supports Progressive Scan. If Progressive Scan is supported, follow the TV User's Manual regarding Progressive Scan settings in the TV's menu system.

## Tour of the Remote Control

- 1 **TV button**  
Use to operate the TV.
- 2 **DVD button**  
Use to operate the DVD player.
- 3 **POWER button**  
Press to turn the DVD-VCR on and off.
- 4 **NUMBER Buttons**
- 5 **TV 100+ button**
- 6 **◀◀ Skip button**  
Press to skip a disc backwards. Use to skip a title, chapter or track on a disc.
- 7 **REC button**  
Press to begin recording. (VCR)
- 8 **◀◀ Search button**  
Press to search a disc backwards.
- 9 **■(STOP) button**  
Press to stop a disc/video tape during play or record (VCR).
- 10 **TV VOL (+,-) button**
- 11 **MENU button**  
Brings up the DVD-VCR player's menu.
- 12 **ENTER/▲▼◀▶ buttons**  
This button functions as a toggle switch.
- 13 **DISC MENU button**  
Brings up the Disc menu. (DVD).
- 14 **EZVIEW button**  
The aspect ratio of a picture can easily be adjusted according to the screen size of your TV (16:9 or 4:3).
- 15 **SUBTITLE button**  
Press to display the subtitle language name abbreviation on screen.
- 16 **MODE button**  
Use to select the program or random play.  
**REPEAT button**  
Allows you to repeat play a title, chapter, track, or disc. (DVD)
- 17 **INPUT SEL. button**  
Press to select Line input 1 or 2 in VCR mode.
- 18 **VCR button**  
Use to operate the VCR.

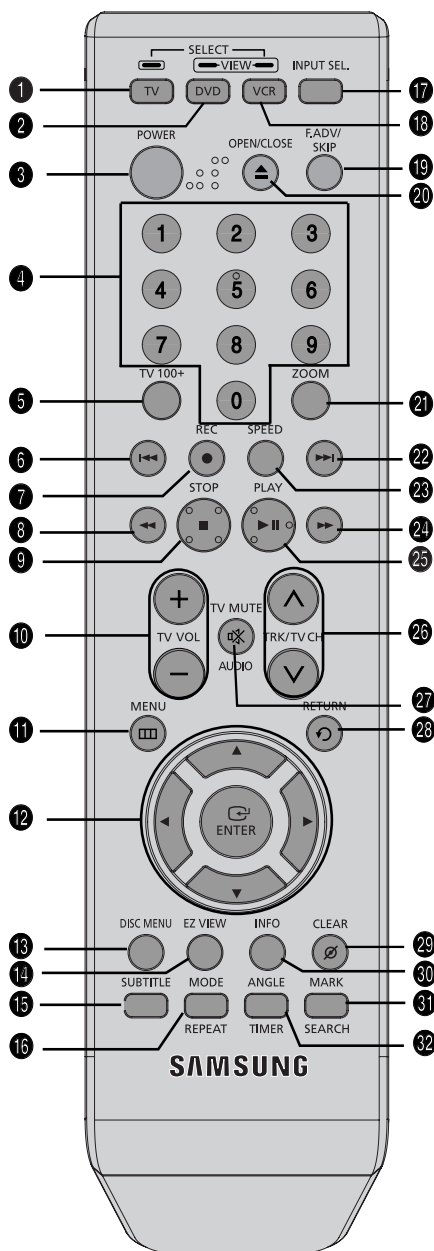

- 19 **F.ADV/SKIP button**  
Press to advance play one frame at a time (DVD and VCR). Press to fast forward a video tape (VCR). Press to select an external signal source.
- 20 **OPEN/CLOSE button**  
Use to open and close the disc tray or eject a video tape.
- 21 **ZOOM button**  
To enlarge the picture.
- 22 **▶▶ Skip button**  
Press to skip a disc forward. Use to skip a title, chapter or track on a disc.
- 23 **SPEED button**  
Use to select the tape recording speed.
- 24 **▶▶ Search button**  
Press to search a disc forward.
- 25 **▶|| (Play/Pause) button**  
Press to play or pause the disc/video tape.
- 26 **TRK/TV CH button**  
Use to change channels. (TV) Use to adjust tape tracking. (VCR)
- 27 **AUDIO/TV MUTE button**  
Use this button to access various audio functions on a disc. (DVD mode)  
This operates as Sound Mute. (TV mode)
- 28 **RETURN button**  
Returns to a previous menu.
- 29 **CLEAR button**  
Use to remove menus or status displays from the screen.
- 30 **INFO. button**  
Displays the current disc mode. (DVD)
- 31 **MARK/SEARCH button**  
Press to memorize scenes for replay. (DVD)  
Displays the VCR Function menu. (VCR)
- 32 **ANGLE/TIMER button**  
Use to access various camera angles on a disc. (DVD) Displays the Timer Program menu (VCR).

# Chapter 2

## CONNECTIONS

### Before Connecting the DVD-VCR

- Always turn off the DVD-VCR, TV, and other components before you connect or disconnect any cables.
- Refer to the user's manual of the additional components (such as a TV) you are connecting for more information on those particular components.

### Connecting a Set-top/Cable/Satellite Box to the DVD-VCR

The following instructions show how to connect a Set-Top Box, TV and Amplifier to the DVD-VCR.

#### 1

Use a TV antenna cable to connect the signal source coming from the antenna or wall to the **ANT IN** jack on the STB.

#### 2

Use the Video/Audio Cable to connect the **LINE OUT** jacks on the STB to the **AUDIO/VIDEO LINE IN 1** jacks on the DVD-VCR..

#### 3

Select **LINE 1** by pressing **LINE IN SELECT** button on the front panel or **INPUT SEL.** button on remote control in VCR mode .

#### 4

Use the Video/Audio Cable to connect the **LINE AUDIO OUT(R/L)/VIDEO OUT** jacks on the DVD-VCR to the Audio & Video jacks on the TV.

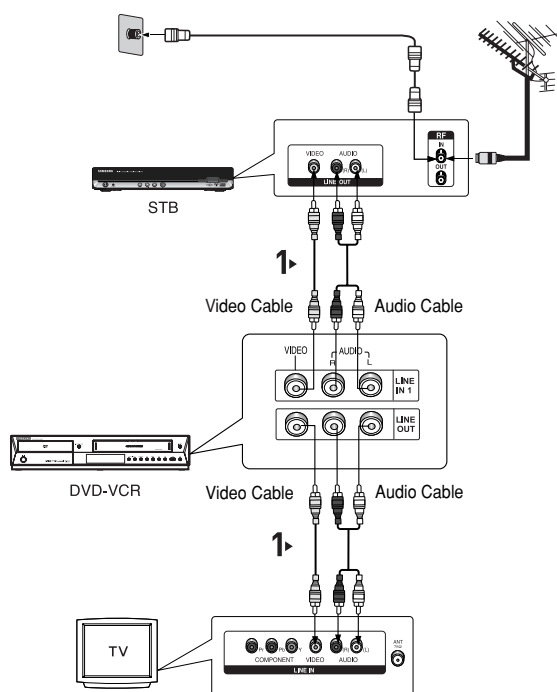

### Tunerless DVD Player & VCR

**This DVD-VCR unit does not have a TV tuner. Recording TV broadcasts is possible via Connection to Cable/Satellite boxes and Multi Channel Video Services.**

#### Notes

- If you want to use other connections to a TV, please refer to the TV connection pages. (See pages 14 to 18)
- If you want to connect to an Amplifier, please refer to the Amplifier connection page. (See pages 19 to 20)
- When you connect a STB through the LINE IN 1 jack of the DVD-VCR, you still can see the picture from the STB on your TV set if the DVD-VCR is turned off.

## Connection to a TV

The following shows examples of connections commonly used to connect the DVD-VCR with a TV and other components.

### Connecting to a TV with an HDMI Jack

**1**

Using an HDMI-HDMI cable, connect the **HDMI OUT** jack on the rear of the DVD player to the **HDMI IN** jack of your TV.

**2**

Press the input selector on your TV remote control until the HDMI signal from the DVD player appears on your TV screen.

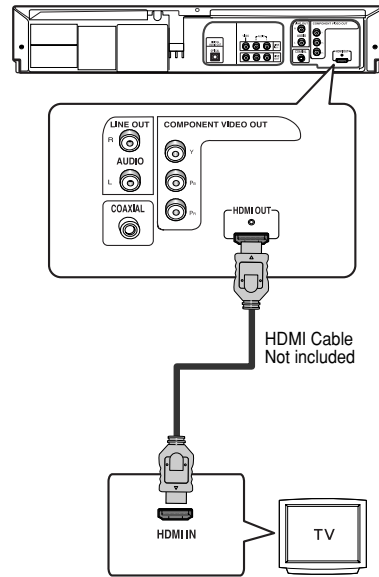

### HDMI VIDEO Specifications

When you press the **HDMI** button on the front panel, 480p, 720p, and 1080p are selected in order.

The first press of the **HDMI** button on the front panel brings up the current resolution.

The second press allows you to change the HDMI output resolution.

- Depending on your TV, certain HDMI output resolutions may not work.
- Please refer to the user's manual of your TV.
- When using an HDMI connection, the DVD player's output is set to HDMI within 10 seconds.
- For better picture quality, set the HDMI output resolution to 720p or 1080p (see page 56).
- If you connect an HDMI cable between Samsung TV and this DVD player, you can operate this DVD player using your TV remote control. This is only available with Samsung TVs that support Anynet+(HDMICEC). (see page 56-57)
- If your TV has an *Anynet+* logo, then it will supports *Anynet+* the Anynet+ function.

## CONNECTIONS

### ● HDMI (High Definition Multimedia Interface)

HDMI is an interface that enables the digital transmission of video and audio data with just a single cable. Using HDMI, the DVD player transmits a digital video and audio signal and displays a vivid picture on a TV having an HDMI input jack.

### ● HDMI connection description

HDMI consists of uncompressed video and digital audio data (LPCM or Bit Stream).

- The player outputs only a pure digital signal to the TV through HDMI.
- If TV does not support HDCP (High-bandwidth Digital Content Protection), snow noise appears on the screen.

### ● Why does Samsung use HDMI?

HDMI provides an interface between any compatible digital audio/video source, such as a set-top box, a DVD player, a PC, a video game system, or an AV receiver and a compatible digital audio and/or video monitor, such as a digital television (DTV).

HDMI supports any TV or PC video format with digital high-definition pictures.

## Connecting to a TV (Progressive)

### 1

Using Component video cables (not included), connect the **COMPONENT VIDEO OUT** jacks on the rear of the DVD-VCR to the **COMPONENT IN** jacks of your TV.

### 2

Using the audio cables, connect from the **AUDIO OUT** or **LINE OUT AUDIO (red and white)** jacks on the rear of the DVD-VCR to the **AUDIO (red and white) IN** jacks of your TV.

Turn on the DVD-VCR and TV.

### 3

With the unit in Stop mode, set the video output to **Progressive Out** in the **Setup Menu**. Then press **ENTER** and progressive will be output. (See pages 55)

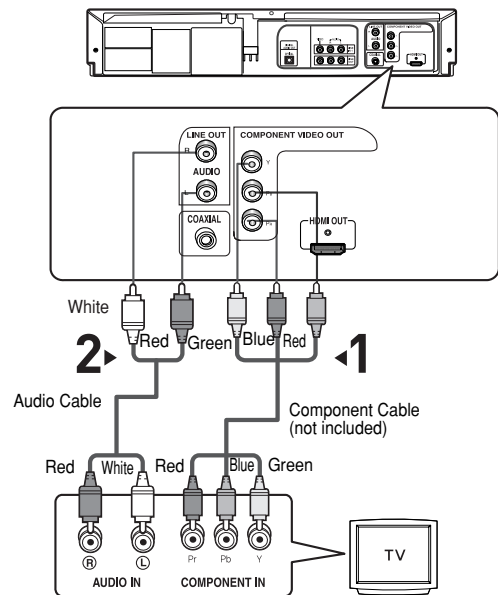

To see the progressive video output,

- Consult your TV User's Manual to find out if your TV supports Progressive Scan. If Progressive Scan is supported, follow the TV User's Manual regarding Progressive Scan settings in the TV's menu system.
- Depending on your TV, the connection method may differ from the illustration above.

#### Note

#### What is "Progressive Scan"?

Progressive scan has twice as many scanning lines as the interlace output method.

Progressive scanning method provides better and clearer picture quality.

The Component Video jacks only output video from the DVD player. To view video from the VCR, you must have the Video/Line Out (yellow) jack connected.

Only the 480p output resolution is possible with Component.



## CONNECTIONS

### Connecting to a TV (Interlace)

- Connecting to your TV using Component video cables.
- You will enjoy high quality and accurate color reproduction images. Component video separates the picture element into black and white(Y), blue(P<sub>B</sub>), red(P<sub>R</sub>) signals to present clear and clean images. (Audio signals are delivered through the audio out or line out audio).

#### 1

Using Component video cables (not included), connect the **COMPONENT VIDEO OUT** jacks on the rear of the DVD-VCR to the **COMPONENT IN** jacks of your TV.

#### 2

Using the audio cables, connect from the **AUDIO OUT** or **LINE OUT AUDIO (red and white)** jacks on the rear of the DVD-VCR to the **AUDIO (red and white) IN** jacks of your TV.

Turn on the DVD-VCR and TV.

#### 3

With the unit in Stop mode, set the video output to **Progressive Out** in the **Setup Menu**. Then press ENTER and Component Interlace will be output. (See pages 55)

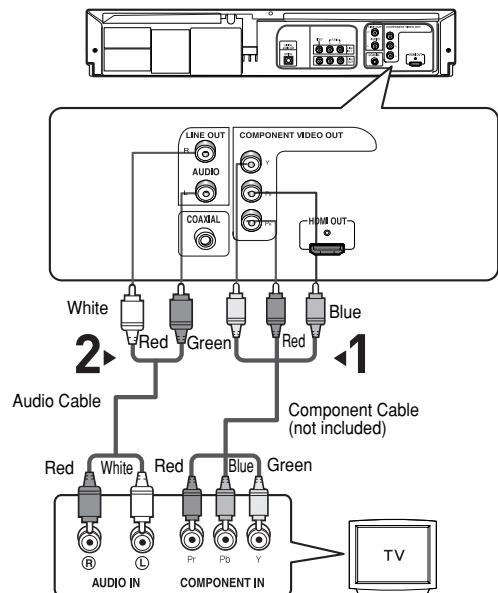

### Notes

- If you want to connect to an Amplifier, please refer to the Amplifier connection page. (See pages 19 to 20)
- The component jack of your TV may be marked "R-Y, B-Y, Y" or "Cr, Cb, Y" instead of "PR, PB, Y" depending on the manufacturer. The number and position of jacks may vary depending on the TV set. Please refer to the user's manual of your TV.
- The Component Video Out jacks only output video from the DVD player. To view video from the VCR, you must have the Video Out (Yellow) jack connected.
- You can hear sound from the LINE OUT AUDIO or AUDIO OUT (red and white) jacks with a Component connection. VCR audio only outputs through Line Out Audio jacks (Red, White).

## CONNECTIONS

### Connecting to a TV (Video)

1

Using video/audio cables, connect the **VIDEO (yellow)/AUDIO (red and white) OUT** jacks on the rear of the DVD-VCR to the **VIDEO (yellow)/AUDIO (red and white) IN** jacks of your TV.

2

Turn on the DVD-VCR and TV.

3

Press the input selector on your TV remote control until the Video signal from the DVD-VCR appears on the TV screen.

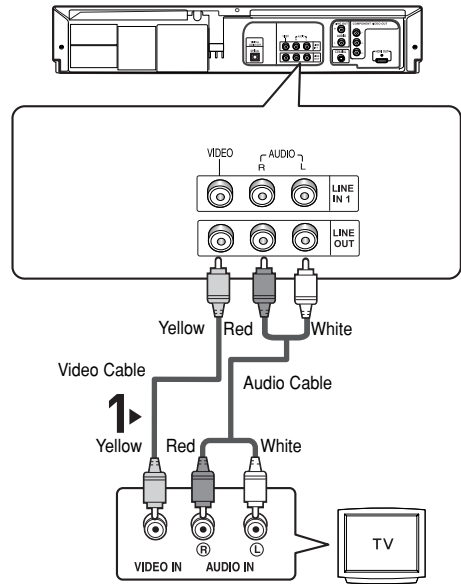

#### Notes

- **Noise may be generated if the audio cable is placed too close to the power cable.**
- If you want to connect to an Amplifier, please refer to the Amplifier connection page. (See pages 19 to 20).
- The number and position of jacks may vary depending on your TV set. Please refer to the user's manual of your TV.
- If there is one audio input jack on the TV, connect it to the LINE OUT AUDIO OUT Left (white) jack of the DVD-VCR.
- When you connect an external device (STB or VCR) and play it through the LINE IN 1 jack of the DVD-VCR, you can still see the display on your TV set although the DVD-VCR set has been turned off.

# Connection to an Audio System

## Connecting to an Audio System (2 Channel Amplifier, Analog)

### 1

Using the audio cables, connect the **(LINE) AUDIO (red and white) OUT** jacks on the rear of the DVD-VCR to the **AUDIO (red and white) IN** jacks of the Amplifier.

### 2

Using the video signal cable(s), connect the **VIDEO** or **COMPONENT OUT** jacks on the rear of the DVD-VCR to the **VIDEO** or **COMPONENT IN** jack of your TV as described on pages 14 to 18.

### 3

Turn on the DVD-VCR, TV, and Amplifier.

### 4

Press the input select button of the Amplifier to select the **External input** in order to hear sound from the DVD-VCR.

Refer to your Amplifier's user manual to set the Amplifier's audio input.

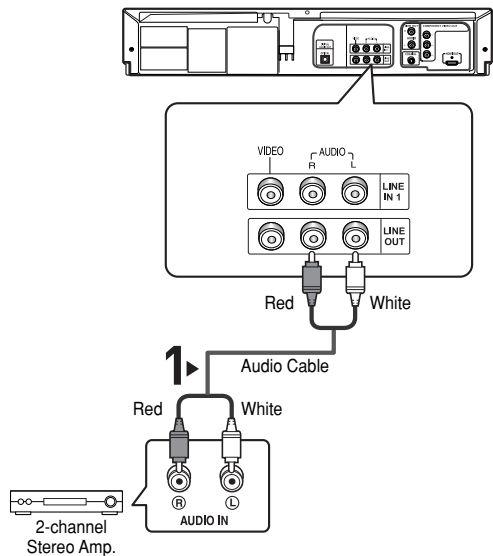

### Notes

- Please turn the volume down when you turn on the Amplifier. Sudden loud sound may cause damage to the speakers and your ears.
- Please set the audio in the menu screen according to the Amplifier. (See pages 52 to 53)
- The position of jacks may vary depending on the Amplifier. Please refer to your Amplifier's user manual .
- You can also connect the amplifier using the AUDIO OUT (red and white) jacks from the DVD-VCR.

## Connecting to an Audio System (Dolby digital, MPEG2 or DTS Amplifier)

### 1

Using a Coaxial cable or an Optical cable (not included), connect the **DIGITAL AUDIO OUT (COAXIAL)** or **DIGITAL AUDIO OUT (OPTICAL)** jack on the rear of the DVD-VCR to the **DIGITAL AUDIO IN (COAXIAL)** or **DIGITAL AUDIO IN (OPTICAL)** jack of the Amplifier.

### 2

Using the video signal cable(s), connect the **VIDEO** or **COMPONENT OUT** jacks on the rear of the DVD-VCR to the **VIDEO** or **COMPONENT IN** jack of your TV as described on pages 14 to 18.

### 3

Turn on the DVD-VCR, TV, and Amplifier.

### 4

Press the input select button of the Amplifier to select external input in order to hear sound from the DVD-VCR.

Refer to your Amplifier's user manual to set the Amplifier's audio input.

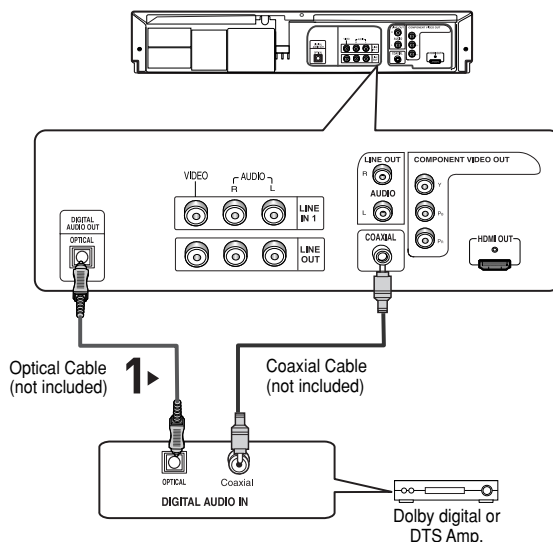

### Notes

- Please turn the volume down when you turn on the Amplifier. Sudden loud sound may cause damage to the speakers and your ears.
- Please set the audio in the menu screen according to the Amplifier. (See pages 52 to 53)
- The jack position may vary depending on the Amplifier. Please refer to the user's manual of the Amplifier.

## Connecting the Power Cord

### 1

Your DVD-VCR's power cord should be plugged into a standard 120V/60Hz wall outlet.

### 2

Turn on the power by pressing the **POWER** button on the remote control or  on the front panel.

### 3

Turn on your TV by pressing the **POWER** button on the TV remote control.

### 4

Press the input selector on your TV remote until the signal from the DVD-VCR appears.

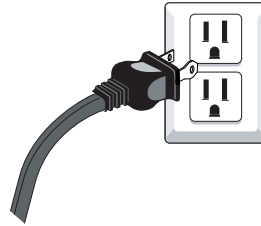

# Chapter 3

## INITIAL SETUP

### Selecting a Menu Language

Follow these steps to change the on-screen MENU language to English, French or Spanish.

**1**

Press the **MENU** button.

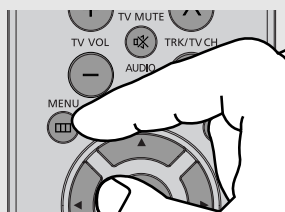

**2**

Press the **▲/▼** buttons to select **Setup**, then press the **▶** or **ENTER** button.

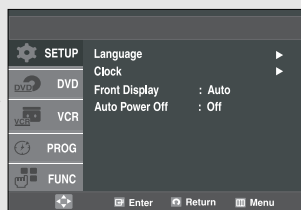

**3**

Press the **▲/▼** buttons to select **Language**, then press the **▶** or **ENTER** button.



**4**

Press the **▲/▼** buttons to select the appropriate language : English, Français or Español.

Press the **ENTER** button.

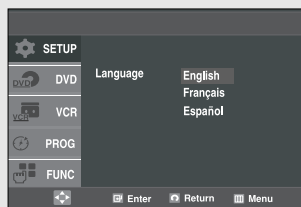

**5**

Press the **MENU** button to exit.

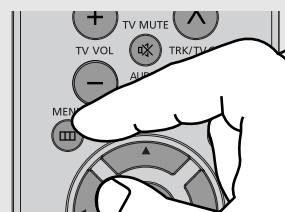

## Setting the Clock

This menu is used to set the current time. You need to set the time to use timer recording.

### Setting the Clock Manually

If Auto Setup fails to set the DVD-VCR's internal clock by locating a local TV station, follow these steps to set the date and time manually.

**Note:** For accurate Timer Recording, your DVD-VCR's internal clock must be set correctly.

**1**

Press the **MENU** button.

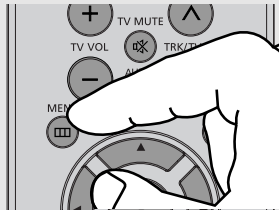

**2**

Press the **▲/▼** buttons to select **Setup**, then press the **▶** or **ENTER** button.



**3**

Press the **▲/▼** buttons to select **Clock**, then press the **▶** or **ENTER** button.

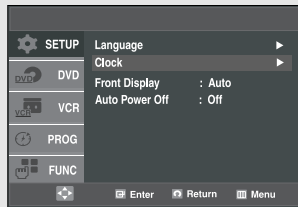

**4**

Use the **◀/▶** buttons to select each of the following options, then use the **▲/▼** buttons to set each option. Press the **ENTER** button to set the clock.

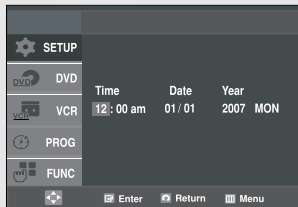

**6**

Press the **MENU** button to exit.

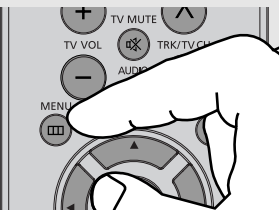

## Setting the Front Panel Display

You can set the Front Panel Display to be bright, dim, or to automatically dim during power off.

**1**

Press the **MENU** button.

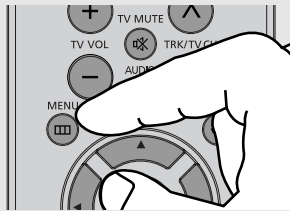

**2**

Press the ▲/▼ buttons to select **Setup**, then press the ► or **ENTER** button.



**3**

Press the ▲/▼ buttons to select **Front Display**, then press the ► or **ENTER** button to select **Auto**, **Bright** or **Dim**.

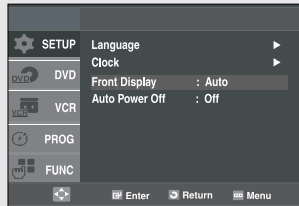

**4**

Press the **MENU** button to exit.

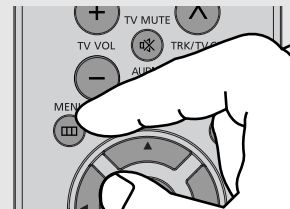

- **Auto:** Front Panel Display will dim automatically during power off.
- **Bright:** Front Panel Display will be bright.
- **Dim:** Front Panel Display will be dim.



## Setting the Auto Power Off

This feature automatically turns off your DVD-VCR if no signal is received and you do not press any buttons for the selected time.

**1**

Press the **MENU** button.

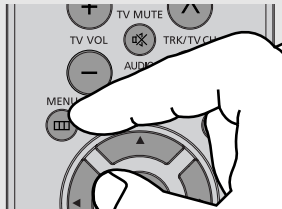

**2**

Press the **▲/▼** buttons to select **Setup**, then press the **▶** or **ENTER** button.



**3**

Press the **▲/▼** buttons to select **Auto Power Off**, then press the **▶** or **ENTER** button to select **Off**, **1Hr** or **2Hr**.

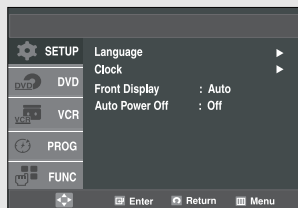

**4**

Press the **MENU** button to exit.

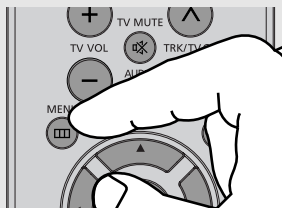

- Off: Auto power off is disabled.
- 1Hr: DVD-VCR will auto shut off 1 hour after the last button is pressed or no signal is received.
- 2Hr: DVD-VCR will auto shut off 2 hours after the last button is pressed or no signal is received.

# Chapter 4

## DVD OPERATIONS

### Playing a Disc

#### Before Play

- Turn on your TV and set it to the correct Video Input on your TV's remote control.
- If you connected an external Audio System, turn on your Audio System and set it to the correct Audio Input.

#### Playback

**1**

Press the **OPEN/CLOSE** (▲) button on the front panel.

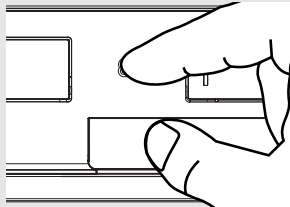

**2**

Place a disc gently into the tray with the disc's label facing up.

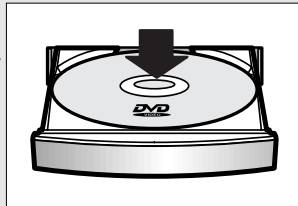

**3**

Press the **▶||** (Play/Pause) button on your remote control or on the front panel.

Most discs will start to play back as soon as the tray closes.



**4**

#### Stopping Play

Press the **■** (Stop) button during play.



#### ◀ Stop/Resume

- Press the **■** (Stop) button once to stop playback. To resume the DVD/CD from the point where the disc stopped, press the **▶||** (Play/Pause) button.
- Press the **■** (Stop) button twice to completely stop playback. The next time you press the **▶||** (Play/Pause), the disc will start over from the beginning.

## DVD OPERATIONS

### 5 Pausing Play

Press the **▶||** (Play/Pause) button on your remote control or on the front panel during play.

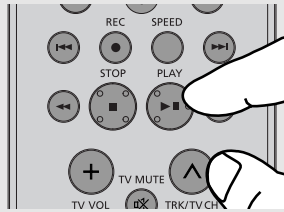

- ▶ - Screen stops, no sound.
- To resume, press the **▶||** (Play/Pause) button once again.

#### Note

If the player is left for about 5 minutes in pause mode, it will stop.

### 6 Step Motion Play (Except CD)

Press the **F.ADV** button on the remote control during play.

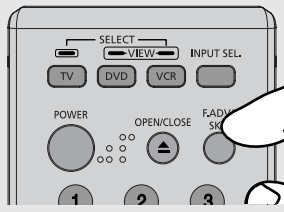

- ▶ - Each time the button is pressed, a new frame will appear.
- No sound is heard during STEP mode.
- Press the **▶||** (Play/Pause) button to resume normal play.
- You can only perform step motion play in the forward direction.

### 7 Slow Motion Play (Except CD)

Press the **◀◀/▶▶** (Search) button to choose the play speed between 1/8, 1/4 and 1/2 of normal during PAUSE or STEP mode.



- ▶ - No sound is heard during slow mode.
- Press the **▶||** (Play/Pause) button to resume normal play.

#### Note

- This (⊘) icon indicates an invalid button press.
- The Slow Motion feature works in both the forward and reverse directions.

### 8 Removing Disc

Press the **OPEN/CLOSE** (▲) button on the front panel.

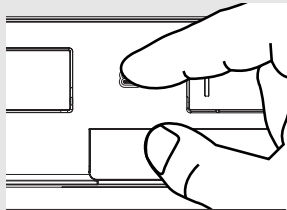

## Using the Search and Skip Functions

During play, you can search quickly through a chapter or track, and use the skip function to jump to the next selection.

### Searching through a Chapter or Track

During play, press the ◀◀/▶▶ (Search) buttons on the remote control for more than one second.



◀ If you want to search at a faster speed on the DVD or CD, press the ◀◀/▶▶ (Search) button repeatedly.

DVD	2X, 4X, 64X, 128X
CD	2X, 4X, 8X

#### Notes

- The speed marked in this function may be different from the actual playback speed.
- No sound is heard during search mode (Except CD).

### Skipping Tracks

During play, press the ◀◀/▶▶ (Skip) buttons.



- When playing a DVD, if you press the ▶▶ (Skip) button, it moves to the next chapter. If you press the ◀◀ (Skip) button, it moves to the beginning of the chapter. Pressing the Skip button twice will make the DVD move to the beginning of the previous chapter.
- When playing a CD, if you press the ▶▶ (Skip) button, it moves to the next track. If you press the ◀◀ (Skip) button, it moves to the beginning of the track. One more press makes it move to the beginning of the previous track.

## Using the Display Function

### When Playing a DVD/MPEG4

**1**

During play, press the **INFO** button on the remote control.



◀ You can select information in the DVD Function menu by pressing the **MENU** button.

**2**

Press the **▲/▼** buttons to select the desired item.

DVD



MPEG4

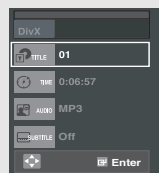

**3**

Press the **◀/▶** buttons to make the desired setup and then press the **ENTER** button.

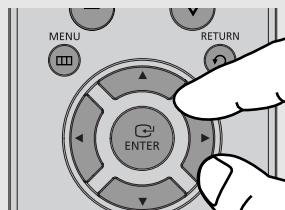

◀ You may use the number buttons of the remote control to directly access a title, chapter or time to start the playback from a desired time.



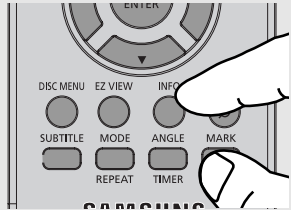

## DVD OPERATIONS

### 4

To exit the menu, press the **INFO** button again.



### Note

	To access the desired title when there is more than one on the disc. For example, if there is more than one movie on a DVD, each movie will be identified.
	Most DVD discs are recorded in chapters so that you can quickly find a specific scene
	Allows playback of the film from a desired time. You must enter the starting time as a reference. The time search function does not operate on some discs.
	Refers to the film's soundtrack language. In the example, the soundtrack is played in English 5.1CH. A DVD disc can have up to eight different soundtracks. The MP3, AC3 and WMA are supported. (DivX)
	Refers to the subtitle languages available in the disc. You will be able to choose the subtitle languages or, if you prefer, turn them off from the screen. A DVD disc can have up to 32 different subtitles.

## Using the Disc and Title Menu (DVD)

**1**

During playback of a DVD disc, press the **MENU** button on the remote control.

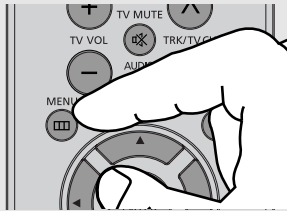

◀ The MENU button can be used to access Disc and title menus on a DVD during playback.

**2**

Press the ▲/▼ buttons to select **Function**, then press the ► or ENTER button.

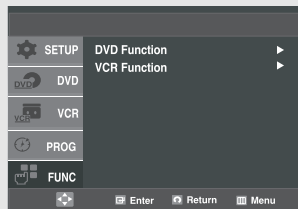

**3**

Press the ▲/▼ buttons to select **DVD Function**, then press the ► or ENTER button.

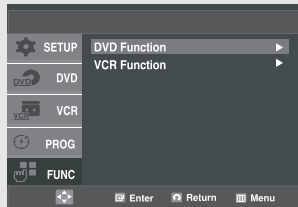

**4**

Press the ▲/▼ buttons to select **Title Menu** or **Disc Menu** then press the ► or ENTER button.

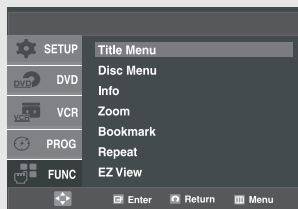

### Notes

- Depending on the disc, the Disc Menu or Title Menu may not work.
- You can also use the Disc Menu by using the DISC MENU button on the remote control.
- The Title Menu will only be displayed if there are at least two titles on the disc.
- The Title Menu works only with DVDs.

## Using the Function Menu (DVD)

**1**

During the playback of a DVD disc, press the **MENU** button on the remote control.

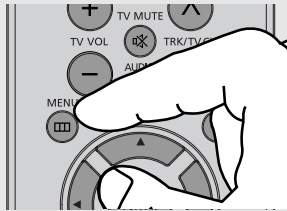

◀ The MENU button can be used to access DVD functions such as Info, Zoom, Bookmark, Repeat and EZ view menu during DVD playback.

**2**

Press the ▲/▼ buttons to select **Function**, then press the ► or ENTER button.

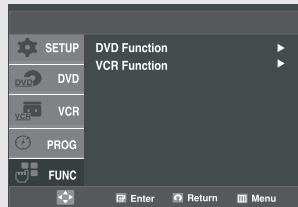

**3**

Press the ▲/▼ buttons to select **DVD Function**, then press the ► or ENTER button.

- Info  
(See pages 29 to 30)
- Zoom (See page 41)
- Bookmark  
(See pages 39 to 40)
- Repeat (See pages 33)
- EZ View  
(See pages 35 to 36)

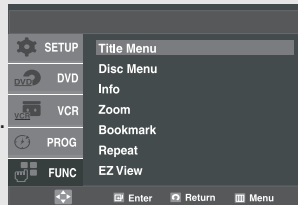

**4**

Press the ▲/▼ buttons to select one of the five functions. Then press the ► or ENTER button to access the function.

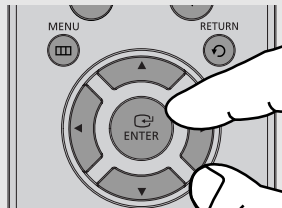

◀ You can also directly select these functions using their respective buttons on the remote control.

- INFO
- MARK
- REPEAT
- ZOOM
- EZ VIEW



## Repeat Play

Repeat the current chapter, title, a chosen section (A-B), or all of the disc.

### When playing a DVD

# 1

During play, press the **REPEAT** button on the remote control. Repeat screen appears.



# 2

Press the ◀/▶ buttons to select **Chapter**, **Title** or **A-B**, then press the **ENTER** button.

DVD

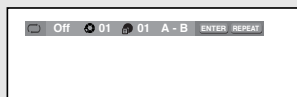

- ◀ - DVD repeats play by chapter or title, and CDs repeat play by disc or.
- Chapter (⌂): repeats the chapter that is playing.
- Title (T): repeats the title that is playing.
- A-B: repeats a segment of the disc that you select.

### Using the A-B Repeat function

1. Press the **REPEAT** button on the remote control.
2. Press the ◀/▶ button to select A-B button.
3. Press the **ENTER** button at the point where you want repeat play to start (A). B is automatically highlighted.
4. Press the **ENTER** button at the point where you want the repeat play to stop (B).
  - To return to normal play, press the **CANCEL** button.

#### Note

A-B REPEAT allows you to set point (B) 5 seconds after point (A) has been set.

# 3

To return to normal play, press **REPEAT** button again, then press the ◀/▶ buttons to select **Off** and press **ENTER** button.

DVD

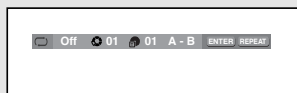

#### Note

- Depending on the disc, the Repeat function may not work.

## Slow Play

This feature allows you to slowly to repeat scenes containing sports, dancing, musical instruments being played etc., so you can study them more closely.

### When playing a DVD

**1**

During play, press the **PLAY/PAUSE** (▶||) button.



**2**

Press the **SEARCH** (◀◀/▶▶) button to choose the play speed between 1/2, 1/4 and 1/8 of normal speed during PAUSE or STEP mode.

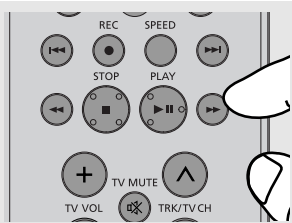

## Adjusting the Aspect Ratio (EZ View)

Set the aspect ratio (length x width) of your TV screen so the DVD-VCR will display movies at the appropriate size for your television.

### To Playback using Aspect Ratio (DVD)

Press the **EZ VIEW** button on the remote control.

- The screen size changes when the button is pressed repeatedly.
- The screen zoom mode operates differently depending on the screen setting in the Display Setup menu.
- To ensure correct operation of the **EZ VIEW** button, you should set the correct aspect ratio in the Display Setup menu.  
(See pages 54 to 57).

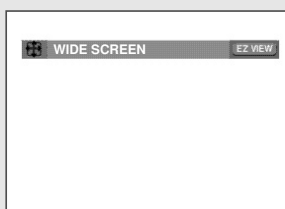

◀ The EZ View feature is not available when the A-B Repeat function is activated.

### If you are using a 16:9 TV

#### For 16:9 aspect ratio discs

##### - WIDE SCREEN

Displays the content of the DVD title in 16:9 aspect ratio.

##### - SCREEN FIT

The top and bottom portions of the screen are cut off. When playing a 2.35:1 aspect ratio disc, the black bars at the top and bottom of the screen will disappear. The picture will look vertically stretched. (Depending on a type of disc, the black bars may not disappear completely.)

##### - ZOOM FIT

The top, bottom, left and right of the screen are cut off and the central portion of the screen is enlarged.

#### For 4:3 aspect ratio discs

##### - NORMAL WIDE

Displays the content of the DVD title in 16:9 aspect ratio. The picture will look horizontally stretched.

##### - SCREEN FIT

The top and bottom portions of the screen are cut off and the full screen appears. The picture will look vertically stretched.

##### - ZOOM FIT

The top, bottom, left and right portions of the screen are cut off and the central portion of the screen is enlarged.

##### - VERTICAL FIT

When a 4:3 DVD is viewed on a 16:9 TV, black bars will appear at the left and right of the screen in order to prevent the picture from looking horizontally stretched.

## If you are using a 4:3 TV

### For 16:9 aspect ratio discs

#### - 4:3 Letter Box

Displays the content of the DVD title in 16:9 aspect ratio. The black bars will appear at the top and bottom of the screen.

#### - 4:3 Pan Scan

The left and right portions of the screen are cut off and the central portion of the 16:9 screen is displayed.

#### - SCREEN FIT

The top and bottom portions of the screen are cut off and a full screen appears. The picture will look vertically stretched.

#### - ZOOM FIT

The top, bottom, left and right of the screen are cut off and the central portion of the screen is enlarged.

### For 4:3 aspect ratio discs

#### - NORMAL SCREEN

Displays the content of the DVD title in 4:3 aspect ratio.

#### - SCREEN FIT

The top and bottom portions of the screen are cut off and the full screen appears. The picture will look vertically stretched.

#### - ZOOM FIT

The top, bottom, left and right portions of the screen are cut off and the central portion of the screen is enlarged.

### Note

This function may work differently depending on the type of disc.

## Selecting the Audio Language

You can select a desired audio language quickly and easily with the AUDIO button.

### Using the **AUDIO** button (DVD/MPEG4)

#### 1

During play, press the **AUDIO** button. Audio languages change when the ◀/▶ button is pressed repeatedly.

The audio languages are represented by abbreviations.

Press the AUDIO button on the remote repeatedly to select the desired Audio (MP3, PCM, WMA, AC3 and MPEG) on MPEG4 discs then press the ENTER .

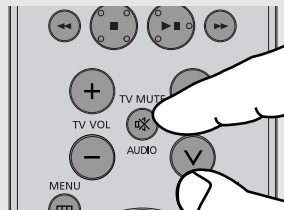

#### DVD

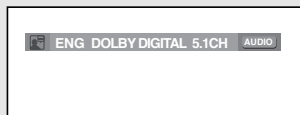

#### MPEG4



#### Notes

- To change the desired audio in the Disc Menu, press the **DISC MENU** button.
- This function depends on what audio languages are encoded on the disc and may not work on all DVDs.
- A DVD disc can contain up to 8 audio languages.
- To have the same audio language come up whenever you play a DVD, see pages 50 to 51.

◀ MPEG4 is a compressed video format designed to deliver DVD quality video at lower data rates and smaller file sizes.

Types of MPEG4 files are DivX or Xdiv. These files have an .avi extension.

#### 2

To remove the AUDIO icon, press the **CLEAR** or **RETURN** button.



# Selecting the Subtitle Language

You can select a desired subtitle quickly and easily with the SUBTITLE button.

## Using the SUBTITLE button (DVD/MPEG4)

### 1

During play, press the **SUBTITLE** button.

The subtitle changes when the button is pressed repeatedly.

The subtitle languages are represented by abbreviations.

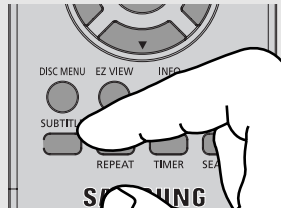

DVD

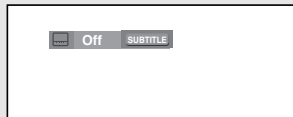

MPEG4

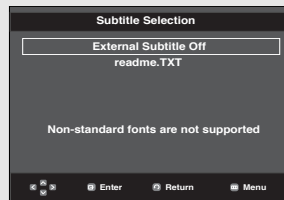

An External subtitle option will appear depending on the DivX Disc.

Press Subtitle button on the remote repeatedly to select the desired subtitle language on an MPEG4 disc.

MPEG4

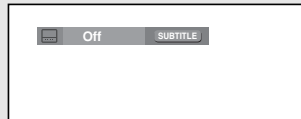

### Notes

- To change the desired subtitle in the Disc Menu, press the **DISC MENU** button.
- This function depends on what subtitles are encoded on the disc and may not work on all DVDs.
- A DVD disc can contain up to 32 subtitle languages.
- To have the same subtitle language come up whenever you play a DVD, see pages 50 to 51.

### 2

To exit the **SUBTITLE** menu, press the **CLEAR** or **RETURN** button.

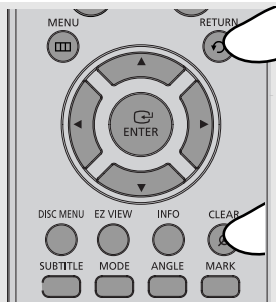

## Changing the Camera Angle

When a DVD contains multiple angles of a particular scene, you can use the ANGLE function.

### Using the ANGLE button (DVD)



If the disc contains multiple angles, the ANGLE (  ) icon appears on the screen.

**1**

Press the **ANGLE** button, then the ANGLE (  ) icon will appear with the current angle number and the number of angles available.



**2**

Press the  button repeatedly to select the desired angle. To remove the ANGLE (  ) icon, press the **CLEAR** or **RETURN** button.

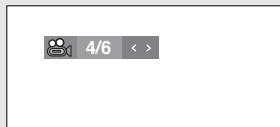

#### Note

If the disc has only one angle, this feature won't work. Currently, very few discs have this feature.

## Using the Bookmark Function

This feature lets you bookmark sections of a DVD so you can quickly find them at a later time.

### Using the MARK button (DVD)

**1**

During play, press the **MARK** button on the remote control.



**2**

When you reach the scene you want to mark, press the **ENTER** button. Up to three scenes may be marked at a time.

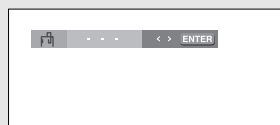

#### Note

Depending on the disc, the Bookmark function may not work.

## DVD OPERATIONS

### Recalling a Marked Scene

**1**

During play, press the **MARK** button on the remote control.



**2**

Press the ◀/▶ buttons to select a marked scene.

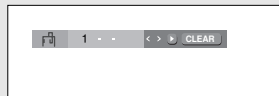

**3**

Press the ▶|| (Play/Pause) button to play the marked scene.



### Clearing a Bookmark

**1**

During play, press the **MARK** button on the remote control.

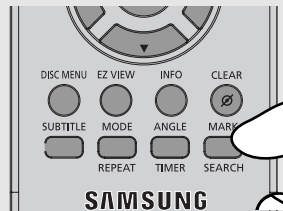

**2**

Press the ◀/▶ buttons to select the bookmark number you want to delete.

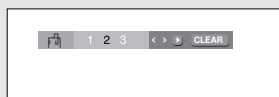

**3**

Press the **CLEAR** button to delete a bookmark number.





## Using the Zoom Function (DVD)

**1**

During the playback of a DVD disc, press the **MENU** button on the remote control.

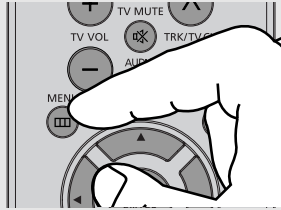

**2**

Press the **▲/▼** buttons to select **Function**, then press the **▶** or **ENTER** button.

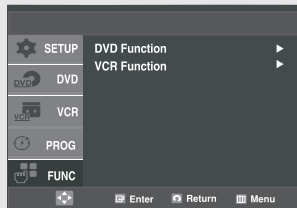

**3**

Press the **▲/▼** buttons to select **DVD Function**, then press the **▶** or **ENTER** button.

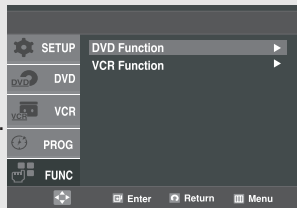

**4**

Press the **▲/▼** buttons to select **Zoom**, then press the **▶** or **ENTER** button.



**5**

Press the **▲/▼** or **◀/▶** buttons to select the part of the screen you want to zoom in on.

Press the **ENTER** button.

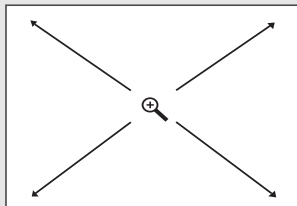

◀ During DVD play, press **ENTER** to zoom in 2X/4X/2X/Normal in order.

You can also select the Zoom function directly using **ZOOM** button on the remote control.

**Note**

Depending on the disc, the Zoom function may not work.

# Clips Menu for CDAudio/ MP3/ WMA/JPEG/ MPEG4

Discs with MP3/WMA/JPEG/MPEG4 contain individual songs and/or pictures that can be organized into folders as shown below. They are similar to how you use your computer to put files into different folders.

**1**  
Open the disc tray.

**2**  
Place the disc on the tray.

**3**  
Close the tray.  
The tray closes and this screen displays.

- : Name of currently playing file.
- : Current Playback Time.
- : Current Playback Mode : There are four modes. They can be selected in order by pressing the REPEAT button.
  - Off: Normal Playback
  - Track: Repeats the current track.
  - Folder: Repeats the current folder.
  - Random: Files on the disc will be played in random order.
- : CD Audio file icon.
- : MP3 file icon.
- : WMA file icon.
- : JPEG file icon.
- : AVI file icon.
- : Folder icon.
- : Current Folder icon.

## Folder Selection

Folder can only be selected in the Stop mode.

- **To select the Parent Folder**  
Press the **RETURN** button to go to the parent folder, or press the **▲/▼** buttons to select “..” and press the **ENTER** button to go to the parent folder.
- **To select the Peer Folder**  
Press the **▲/▼** buttons to select the desired folder, then the **ENTER** button.
- **To select the Sub-Folder**  
Press the **▲/▼** buttons to select the desired folder, then press the **ENTER** button.

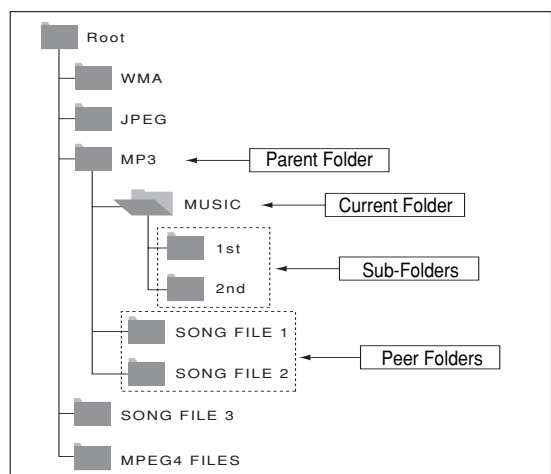

## CD Audio/MP3/WMA Playback

**1**

Open the disc tray.

**2**

Place the disc on the tray.

**3**

Close the tray.



**4**

Press the ▲/▼ buttons to select a song file.

Press the **ENTER** button to begin playback of the song file.



◀ When a disc or a folder contains both MP3 and WMA files, only one type will be played, not both.

## Repeat/Random playback

During play, press the **REPEAT** button to change the playback mode. There are four modes.

**Off, Track, Folder and Random.**



- Off: Normal Playback
- Track: Repeats the current song file.
- Folder: Repeats the song files which have the same extension in the current folder.
- Random: Song files which have the same extension will be played in random order.

To resume normal play, press the **CLEAR** button.

## CD-R MP3/WMA file

When you record MP3 or WMA files on a CD-R, please refer to the following.

- **Your MP3 or WMA files should be ISO 9660 or JOLIET format.**

ISO 9660 format and Joliet MP3 or WMA files are compatible with Microsoft's DOS and Windows, and with Apple's Mac. This format is the most widely used.

- **When naming your MP3 or WMA files, do not exceed 8 characters, and enter ".mp3, .wma" as the file extension.**

General name format : Title.mp3. or Title.wma.  
When composing your title, make sure that you use 8 characters or less, have no spaces in the name, and avoid the use of special characters including: (.,/\,=,+).

- **Use a decompression transfer rate of at least 128 Kbps when recording MP3 files.**

Sound quality with MP3 files basically depends on the rate of compression/decompression you choose. Getting CD audio sound requires an analog/digital sampling rate, that is conversion to MP3 format, of at least 128 Kbps and up to 160 Kbps. However, choosing higher rates, like 192 Kbps or more, only rarely give better sound quality. Conversely, files with decompression rates below 128 Kbps will not be played properly.

- **Use a decompression transfer rate of at least 64Kbps when recording WMA files.**

Sound quality with WMA files basically depends on the rate of compression/decompression you choose.

Getting CD audio sound requires an analog/digital sampling rate, that is conversion to WMA format, of at least 64Kbps and up to 192Kbps.

Conversely, files with decompression rates below 64Kbps or over 192Kbps will not be played properly.

- **Do not try recording copyright protected MP3 files.**

Certain "secured" files are encrypted and code protected to prevent illegal copying. These files are of the following types: Windows Media™ (registered trade mark of Microsoft Inc) and SDMITM (registered trade mark of The SDMI Foundation). You cannot copy such files.

- **Important:**

The above recommendations cannot be taken as a guarantee that the DVD-VCR will play MP3 recordings, or as an assurance of sound quality. You should note that certain technologies and methods for MP3 file recording on CD-Rs prevent optimal playback of these files on your DVD-VCR (degraded sound quality and in some cases, inability of the player to read the files).

- This unit can play a maximum of 500 files and 500 folders per disc.

## MPEG4 Playback

### MPEG4 Play Function

AVI files are used to contain the audio and video data. Only AVI format files with the ".avi" extensions can be played.

**1**

Open the disc tray.  
Place the disc on the tray.  
Close the tray.



**2**

Press the ▲/▼ or ◀/▶ buttons to select an avi file (DivX/XviD), then press the **ENTER** button.

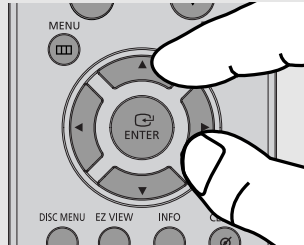

### Repeat Playback

**1**

Press the **REPEAT** button to change playback mode. There are 3 modes, such as **Off**, **Title**, **Folder**

- Off : Normal playback.
- Title : Repeats the title that is playing.
- Folder : Repeats the AVI files which have the same extension in the current folder.



## DVD OPERATIONS

### MPEG4 Function Description

Function	Description	Reference page
Skip (◀◀ or ▶▶)	During play, press the ◀◀ or ▶▶ button, it moves forward or backward 5 minutes.	-
Search (◀◀ or ▶▶)	During play, press the SEARCH (◀◀ or ▶▶) button and press again to search at a faster speed. Allows you to search at a faster speed in an AVI file. (2X, 4X, 8X)	-
Slow Motion Play	Allows you to search at a slower speed in an AVI file. (1/8X, 1/4X, 1/2X)	P 26
Step Motion Play	Each time the STEP button is pressed, a new frame will appear.	P 26
ZOOM	Allows you to zoom in on the screen 2X/4X/2X/Normal in order	P 41

- These functions may not work depending on MPEG4 file.

### CD-R AVI file

This unit can play the following video compression formats within the AVI file format:

- DivX 3.11 contents
- DivX 4 contents (Based on MPEG4 Simple Profile)
- DivX 5 contents (MPEG4 simple profile plus additional features such as bi-directional frames. Qpel and GMC are also supported.)
- XviD MPEG4 compliant Contents.

This unit supports all resolutions up to maximum below.

DivX3.11 & DivX4 & XviD	DivX5
Bitrate may fluctuate: Device may skip decoding the high bitrate portions and begin decoding again when Bitrate returns to normal.	720 x 480 @30fps 720 x 576 @25fps : Maximum bitrate : 4Mbps

### Notes

- Some MPEG4 files created on a personal computer may not be able to be played back. That is why Codec Type, Version and Higher resolution higher than the specifications are not supported.
- This unit supports CD-R/RW written in MPEG4 in accordance with the "ISO9660 format".
- When unsupported AVI file is played, there will be a message "This file format is not supported".

## Picture CD Playback

**1**

Select the desired folder then press the **ENTER** button.



**2**

Press the **▲/▼** buttons to select a Picture file in the clips menu, then press the **ENTER** button.

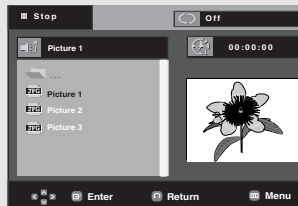

**3**

Press the **INFO.** button to display the menu.

Press the **◀/▶** buttons to select the menu you want to view, then press the **ENTER** button.

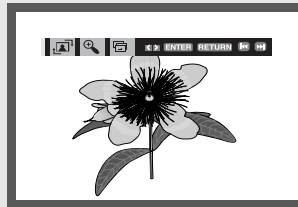

### Notes

- Press the **■** (Stop) button to return to the clips menu.
- When playing a Kodak Picture CD, the unit displays the Photo directly, not the clips menu.

### Rotation

 : Each time the **ENTER** button is pressed, the picture rotates 90 degrees clockwise.





### Zoom

 :- Press the **▲/▼** button to select the part of the screen you want to zoom in on. Press the **ENTER** button. Each time the **ENTER** button is pressed, the picture is enlarged up to 4X. (2X → 4X → 2X → Normal).

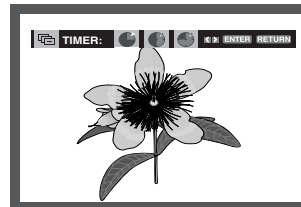
- You can also select the Zoom function by pressing the ZOOM button on the remote control.

### Slide Show



-  : The unit enters slide show mode.
- Before beginning the Slide Show, the picture interval must be set.
-  : When this icon is selected and **ENTER** is pressed, the pictures change automatically with about a 6 second interval.
-  : The pictures change automatically with about a 12 second interval.
-  : The pictures change automatically with about a 18 second interval.

### Notes

- Depending on a file size, the amount of time between each picture may be different from the set interval time.
- If you don't press any button, the slide show will start automatically in about 10 seconds by default.

## CD-R JPEG Discs

- Only files with the “.jpg” and “.JPG” extensions can be played.
- If the disc is not finalized, it will take longer to start playing and not all of the recorded files may be played.
- Only CD-R discs with JPEG files in ISO 9660 or Joliet format can be played.
- The name of the JPEG file may not be longer than 8 characters and should contain no blank spaces or special characters (. / = +).
- Only a consecutively written multi-session disc can be played. If there is a blank segment in the multi-session disc, the disc can be played only up to the blank segment.
- A maximum of 3000 images can be stored on a single CD.
- Kodak Picture CDs are recommended.
- When playing a Kodak Picture CD, only the JPEG files in the pictures folder can be played.
- Kodak Picture CD: The JPEG files in the pictures folder can be played automatically.
- Konica Picture CD: If you want to see the Picture, select the JPEG from the clips menu.
- Fuji Picture CD: If you want to see the Picture, select the JPEG from the clips menu.
- QSS Picture CD: The unit may not play a QSS Picture CD.
- If the number of files on one Disc is over 500, only the first 500 JPEG files can be played.
- If the number of folders on one Disc is over 500, only JPEG files in the first 500 folders can be played.



## Using the Setup Menu

The Setup menu lets you customize your DVD-VCR by allowing you to select various language preferences, set up a parental level, and even adjust the player to the type of television screen you have.

**1**

With the unit in Stop mode, press the **MENU** button on the remote control.

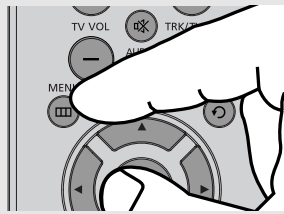

**2**

Press the ▲/▼ buttons to select **DVD**, then press the ► or **ENTER** button.

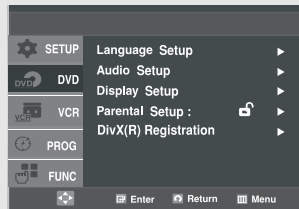

- ❶ Language Setup: Setup of the Language.
- ❷ Audio Setup: Setup of the Audio Options.
- ❸ Display Setup: Setup of the Display Options. Used to select which type of screen you want to watch and several display options.
- ❹ Parental Setup: Setup of the Parental Level. Allows users to set the level necessary to prevent children from viewing unsuitable movies such as those with violence, adult subject matter, etc.
- ❺ DivX(R) Registration: Please use the Registration code to register this player with the DivX(R) Video On Demand format. To learn more go to [www.divx.com/vod](http://www.divx.com/vod). (see page 61)

**3**

Press the ▲/▼ buttons to access the different features. Press the ► or **ENTER** button to access the sub features.

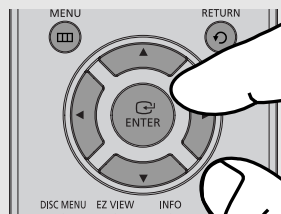

**4**

To make the DVD setup screen disappear after setting up, press the **MENU** button again.

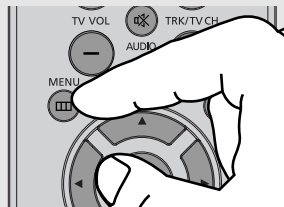

**Note**

Depending on the disc, some DVD Setup menu selections may not work.

## Setting Up the Language Features

If you set the audio and subtitle language in advance, the settings will automatically be applied every time you watch a movie.

**1**

With the unit in Stop mode, press the **MENU** button on the remote control.

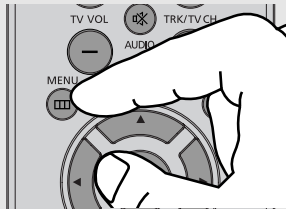

**2**

Press the **▲/▼** buttons to select **DVD**, then press the **▶** or **ENTER** button.

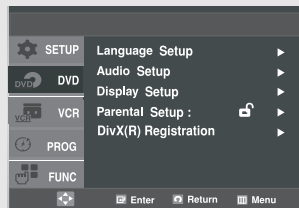

**3**

Press the **▲/▼** buttons to select **Language Setup**, then press the **▶** or **ENTER** button.

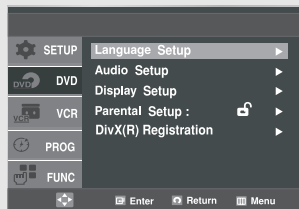

**4**

Press the **▲/▼** buttons to select the desired item, then press the **▶** or **ENTER** button.



**5**

Press the **▲/▼** buttons to select the desired language, then press the **▶** or **ENTER** button.

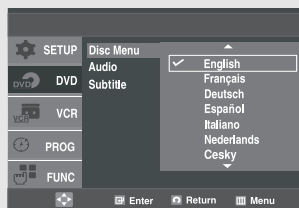

- ◀ - Once the language is selected, the screen returns to the Language Setup menu.
- To make the DVD Setup menu disappear, press the MENU button.

## Language Function

### Disc Menu

To set the Disc Menu Language to your preferred language, follow these steps. If your preferred language is available on a DVD, your Disc Menu Language will automatically be set to the language you selected.



- ◀ - If the selected language is not recorded on the disc, the original pre-recorded language is selected.

### Audio

To set the Audio Language to your preferred language, follow these steps. If your preferred language is available on a DVD, your Audio Language will automatically be set to the language you selected.



- ◀ - Select "Original" if you want the default soundtrack language to be the original language the disc is recorded in.
- If the selected language is not recorded on the disc, the original pre-recorded language is selected.

### Subtitle

To set the Subtitle Language to your preferred language, follow these steps. If your preferred language is available on a DVD, your Subtitle Language will automatically be set to the language you selected.



- ◀ - Select "Automatic" if you want the subtitle language to be the same as the language selected as the audio language.
- Some discs may not contain the language you select as your initial language; in that case the disc will use its original language setting.

## Setting Up the Audio Options

Audio Options allows you to set up sound for use with your external audio system.

**1**

With the DVD in Stop mode, press the **MENU** button on the remote control.

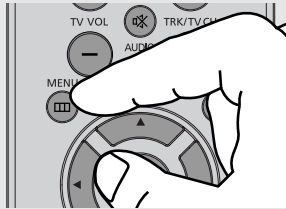

**2**

Press the **▲/▼** buttons to select **DVD**, then press the **▶** or **ENTER** button.

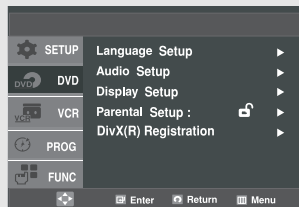

**3**

Press the **▲/▼** buttons to select **Audio Setup**, then press the **▶** or **ENTER** button.



**4**

Press the **▲/▼** buttons to select the desired item, then press the **▶** or **ENTER** button.

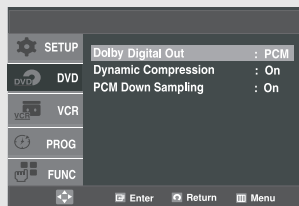

◀ - To make the DVD Setup menu disappear, press the **MENU** button.

## DVD OPERATIONS

### Audio Options

#### Dolby Digital Out

- PCM: Converts to PCM(2CH) audio.
- Bitstream: Outputs Dolby Digital via the digital output.

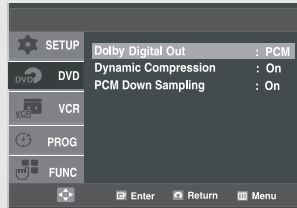

Manufactured under license from Dolby Laboratories. "Dolby" and the double-D symbol are trademarks of Dolby Laboratories. "DTS" and "DTS Digital Out" are trademarks of Digital Theater Systems, Inc.

#### Dynamic Compression

- On: When the movie-soundtracks are played at low volume or from smaller speakers, the system can apply appropriate compression to make low-level content more intelligible and prevent dramatic passages from getting too loud.
- Off: To select the standard range.

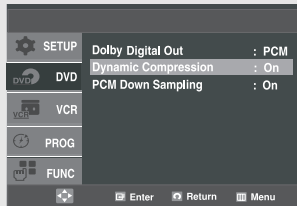

- ◀ - Dynamic compression restrains the dynamic range of the sound, i.e. the difference between the loud and quiet passages of a DVD audio track. This is useful when watching a DVD late at night.

#### PCM Down Sampling

- On: Select this when the Amplifier connected to the player is not 96KHz compatible. In this case, the 96KHz signals will be converted down to 48KHZ.
- Off: Select this when the Amplifier connected to the player is 96KHz compatible. In this case, all signals will be output without any changes.

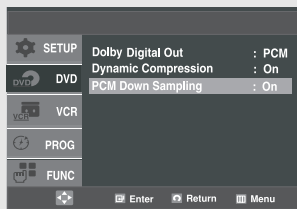

#### Note

Even when PCM Down sampling is Off, some discs will only output down sampled audio through the digital outputs.

## Setting Up the Display Options

Display options enable you to set various video functions of the player.

**1**

With the unit in Stop mode, press the **MENU** button on the remote control.

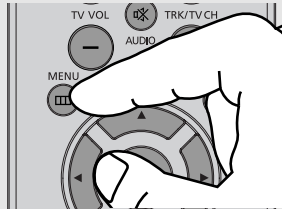

**2**

Press the ▲/▼ buttons to select **DVD**, then press the ► or **ENTER** button.

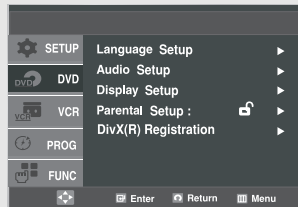

**3**

Press the ▲/▼ buttons to select **Display Setup**, then press the ► or **ENTER** button.

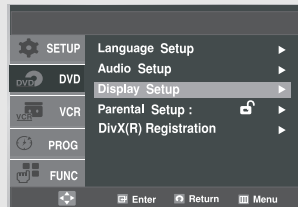

**4**

Press the ▲/▼ buttons to select the desired item, then press the ► or **ENTER** button.

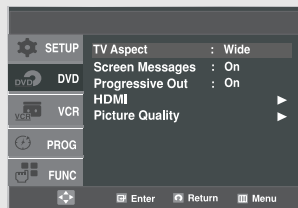

◀ - To make the DVD Setup menu disappear, press the MENU button.

## DVD OPERATIONS

### Display Options

#### TV Aspect

Depending on the type of television you have, you may want to adjust the aspect ratio (screen setting).

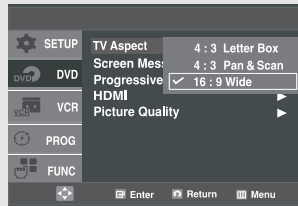

- 4:3 Letter Box: Select when you want to see the total 16:9 ratio screen the DVD supplies, even though you have a TV with a 4:3 ratio screen. Black bars will appear at the top and bottom of the screen.
- 4:3 Pan & Scan: Select this for conventional size TVs when you want to see the central portion of the 16:9 screen. (Extreme left and right side of movie picture will be cut off.)
- 16:9 Wide: You can view the full 16:9 picture on your wide screen TV.

#### Screen Messages

Use to turn on-screen messages On or Off.



#### Progressive Out

- ON : Select when you want to use the Component (480p) or HDMI (480p/720p/1080p) progressive outputs.
- OFF : Select when you want to use Video/Component interlace



## DVD OPERATIONS

### HDMI

This setting is used when the DVD-VCR is connected by HDMI to Display devices (TV, projector, etc).



### Resolution Setting

- Auto : Resolution setting automatically
- Manual : Resolution setting Manually.

### Resolution

- 480p : 720 x 480
- 720p : 1280 x 720
- 1080i : 1920 x 1080
- 1080p : 1920 x 1080



## DVD OPERATIONS

### Picture Quality

- Black Level : Adjusts the brightness of the screen. (On or Off) This function is not available in progressive mode.

- Sharpness : Level 1 ~ Level 5

- Brightness : Level 1 ~ Level 5

- Color Saturation : Level 1 ~ Level 5

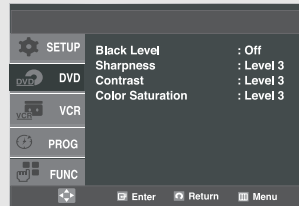

- Consult your TV User's Manual to find out if your TV supports Progressive Scan. If Progressive Scan is supported, follow the TV User's Manual regarding Progressive Scan settings in the TV's menu system.
- If the Video Output is set incorrectly, the screen may not display an image.
- The resolutions available for HDMI output depend on the connected TV or projector. For more details, see the user's manual of your TV or projector.
- When the resolution is changed during playback, it may take a few seconds for a normal image to appear.
- For better picture quality, set the HDMI output resolution to 720p or 1080p.

## Setting Up the Parental Control

The Parental Control function works in conjunction with DVDs that have been assigned a rating, which helps you control the types of DVDs that your family watches. There are up to 8 rating levels on a disc.

### Setting Up the Rating Level

**1**

With the unit in stop mode, press the **MENU** button on the remote control.

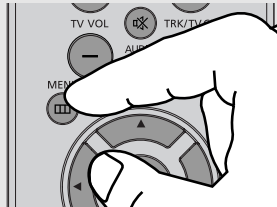

**2**

Press the ▲/▼ buttons to select **DVD**, then press the ► or **ENTER** button.

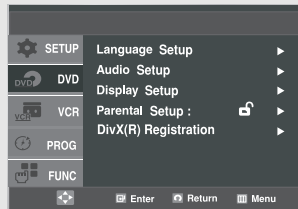

**3**

Press the ▲/▼ buttons to select **Parental Setup**, then press the ► or **ENTER** button.

Enter your password.

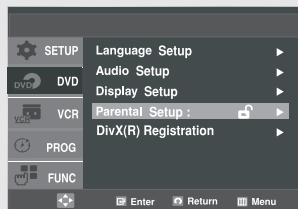

**4**

Press the ► or **ENTER**  
The Enter Password screen appears.

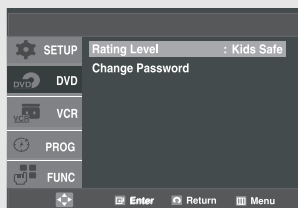

## DVD OPERATIONS

**5**

Press the ► or **ENTER**  
The Enter Password screen appears.

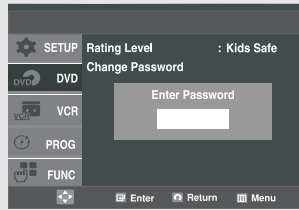

### Note

The default password is 0000.

**6**

Press the ▲/▼ buttons to  
select the Rating Level you  
want, then press the ► or  
**ENTER** button.

e.g) Setting up in Level 6.

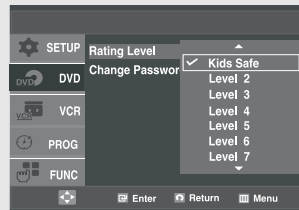

- ◀ - To make the DVD setup menu disappear, press the MENU button.
- For example, if you select up to Level 6, discs that contain Level 7 or 8 will not play.

## Changing the Password

**1**

With the unit in stop mode,  
press the **MENU** button on the  
remote control.

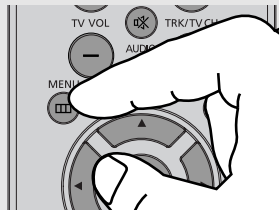

**2**

Press the ▲/▼ buttons to  
select **DVD**, then press the  
► or **ENTER** button.

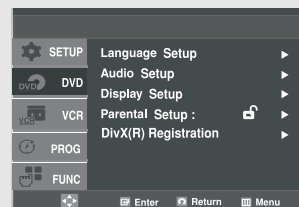

**3**

Press the ▲/▼ buttons to  
select **Parental Setup**, then  
press the ► or **ENTER**  
button.

Enter your password.

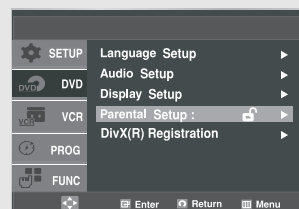

## DVD OPERATIONS

### 4

Press the ▲/▼ buttons to select **Change Password**, then press the ► or **ENTER** button.

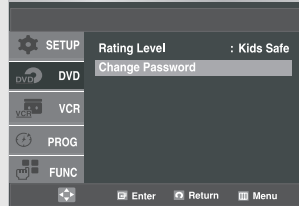

### 5

Enter your password, then press the ► or **ENTER** button.  
Enter your new password, then press the ► or **ENTER** button.

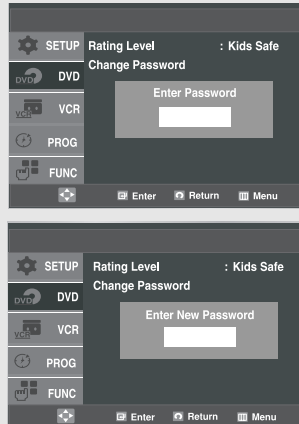

◀ - To make the DVD setup menu disappear, press the MENU button.

#### Note

If you forgot your password, power on the unit with no disc.

Press the ◀◀/▶▶ (Search) buttons simultaneously on the front panel for 5 seconds. The "Reset OK" message will appear. Press the **POWER** button.

## DivX(R) Registration

DivX Registration menu has the Registration Code that enables your DivX Certified Player to play DivX(R) Video On Demand file format.

**1**

With the unit in Stop mode, press the **MENU** button on the remote control.

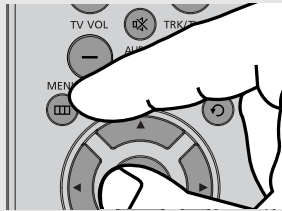

**2**

Press the ▲/▼ buttons to select **DVD**, then press the ► or **ENTER** button.

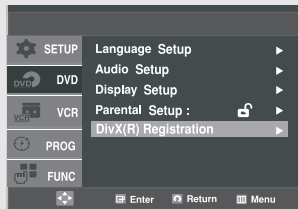

**3**

Press the ▲/▼ buttons to select **DivX(R) Registration**, then press the ► or **ENTER** button.

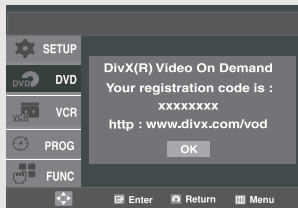

Please use the Registration code to register this player with the DivX(R) Video On Demand format. To learn more go to [www.divx.com/vod](http://www.divx.com/vod).

**4**

Press the **MENU** button to exit.

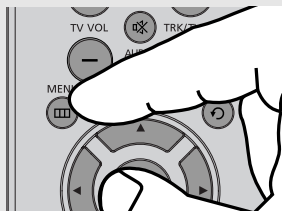

# Chapter 5

## VCR OPERATIONS

In this chapter, you will learn how to play a video cassette tape, how to use the time counter and memory stop features, and how to record a program as you are watching TV.

### Inserting and Ejecting a Video Cassette Tape

#### To Insert a Video Cassette Tape

**1**

Hold the video cassette tape window-side up with the arrow pointing away from you.

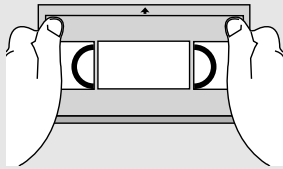

**2**

Gently push the tape through the compartment door until you feel the VCR pull it.

The VCR loads the tape automatically.

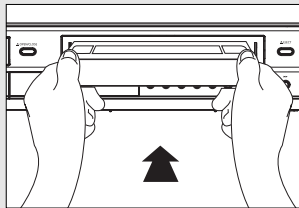

- ◀ - Don't try to insert a tape upside down or backwards.
- Use only video tapes labeled "VHS." European PAL VHS video tapes and S-VHS pre-recorded tapes aren't compatible with this unit. Choose brand name, high quality tapes for best results.
- ◀ - If the safety tab of your video tape has been removed, the tape begins to play automatically. You don't have to press PLAY. For more information on the safety tab, see page 74.

#### To Eject a Video Cassette Tape

**1**

Press the ■ (Stop) button to stop playing the tape.

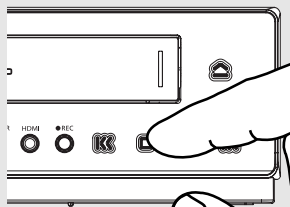

**2**

Press the **EJECT** button on the front panel to eject the tape.

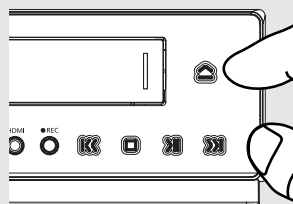

- ◀ When you're finished playing a pre-recorded video tape, it's best to rewind it to the beginning and remove it from the VCR to protect it from wear and tear.
- ◀ After ejecting a tape, you should remove it completely from the compartment and turn off the VCR.

# Playing a Pre-Recorded Video Cassette Tape

## Playing the Tape

**1**

Insert the video cassette tape.

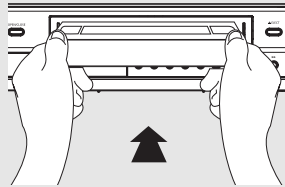

◀ - For more information on the safety tab, see page 74.

**2**

If the tape doesn't begin to play automatically, press the ►|| (Play/Pause) button.



**3**

### Pausing Play

While a tape is playing, press the ►|| (Play/Pause) button when you want to interrupt play. The tape pauses temporarily.

Press the ►|| (Play/Pause) button to resume playing the tape.



- ◀ - The VCR does not play sound while a video tape is paused.
- See "Using Automatic Tracking" on the next page.
- If you see white lines on the screen, see "Using Automatic Tracking" on page 65.

### Note

To view VCR playback, you must connect the Video Out (Yellow) to your TV. The VCR does not output video through the Component jacks.

## Special VCR Playback Features

While a videotape is playing, you can enjoy a variety of special playback features, including Still, Frame Advance, Skip, Repeat, and more. Press the Play/Pause button again to resume normal playback.

### Frame Advance

In the pause mode, press **F.ADV** to advance to the next frame.



### Fps/Rps Review

In Play mode, press **▶▶ / ▶▶▶** (Forward) or **◀◀ / ◀◀◀** (Rewind) to review at two speeds:

- Picture Search: Press and release **▶▶▶** or **◀◀◀** (**SKIP**) buttons to advance the tape forward or backward at 5 times normal speed.
- Jet Search: Press and hold down the **◀◀ / ▶▶** (**SEARCH**) buttons, then release it to play back at the normal speed.

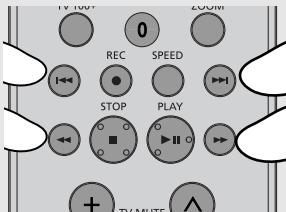

### SKIP

In Play mode, press the **SKIP** button to move ahead exactly 30 seconds. Press the **SKIP** button repeatedly up to 4 times to move ahead 2 minutes.

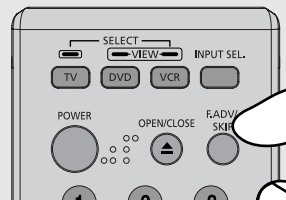

### Repeat

- In Play mode, press the **REPEAT** button to review the last 5 seconds of tape (SP mode).
- In Play mode, press the **REPEAT** button to review the last 15 seconds of tape (SLP mode).

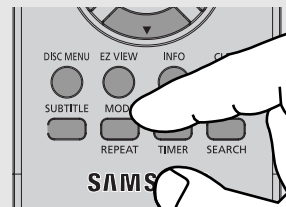



## Using Automatic Tracking

The Tracking adjustment removes the white lines that sometimes appear during playback because of slight differences in recording decks. The TRK button will automatically align the recorded tracks with the playback heads to solve this problem. You may also set tracking manually.

**1**

Insert and play a video cassette tape.

As soon as the tape begins to play, the VCR begins automatic tracking.

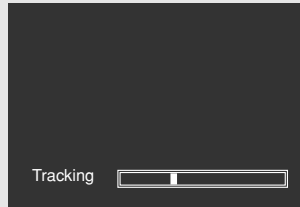

**2**

If automatic tracking doesn't remove the streaks from the picture, press and hold the TRK/TV CH  $\wedge$  or TRK/TV CH  $\vee$  button until the streaks disappear.

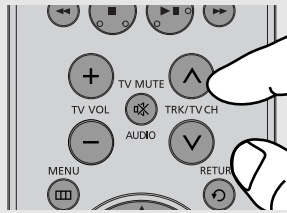

## Selecting the Cassette Type

If you wish to use the tape counter to display the time remaining on a cassette, you must indicate the type of cassette inserted.

**1**

Press the **MENU** button on the remote control.

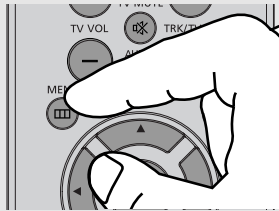

**2**

Press the ▲/▼ buttons to select **VCR**, then press the ► or **ENTER** button.

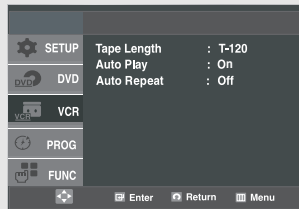

**3**

Press the ▲/▼ buttons to select **Tape Length**, then press the ► or **ENTER** button to select the correct cassette length.

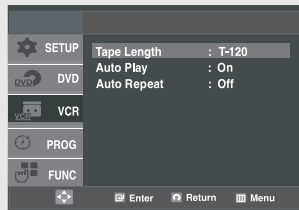

**4**

Press the **MENU** button to exit.

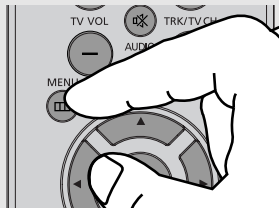

### Note

This information is usually printed on the tape box. The menu cycles through: T-120, T-160 or T-180.

Once the type of cassette is set, the VCR can display the amount of time remaining on the tape when you press the **INFO.** button.

## Setting the Auto Play

If you want your videotapes to play automatically when you insert them, turn on Auto Play.

**1**

Press the **MENU** button on the remote control.

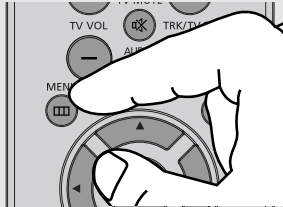

### Note

Only tapes that are missing the Record Safety Tab will play automatically when inserted (See page 74).

**2**

Press the ▲/▼ buttons to select **VCR**, then press the ► or **ENTER** button.

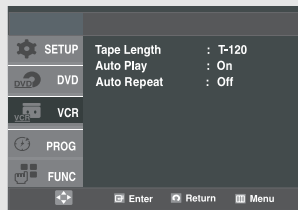

**3**

Press the ▲/▼ buttons to select **Auto Play**, then press the ► or **ENTER** button to select **On** or **Off**.

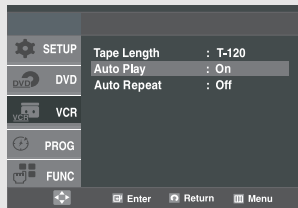

- ◀ - On: The VCR will automatically begin playing a video tape when it is inserted, as long as the safety tab of the cassette has been removed.
- Off: Auto play is disabled.

**4**

Press the **MENU** button to exit.

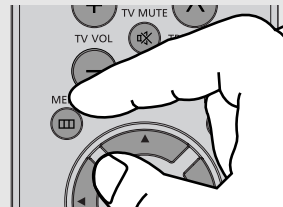

## Setting the Auto Repeat

If you want your videotapes to play repeatedly, turn on Auto Repeat.

**1**

Press the **MENU** button on the remote control.

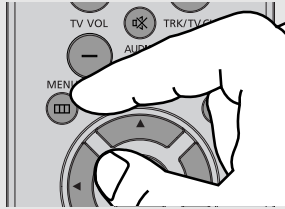

**2**

Press the ▲/▼ buttons to select **VCR**, then press the ► or **ENTER** button.

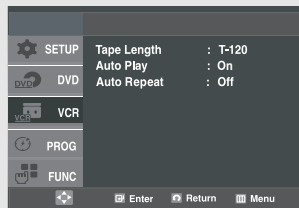

**3**

Press the ▲/▼ buttons to select **Auto Repeat**, then press the ► or **ENTER** button to select **On** or **Off**.

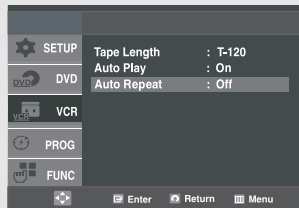

- ◀ - On: The VCR will play a tape repeatedly [unless a tape control is activated (stop, fast forward or rewind)].
- Off: Auto Repeat is disabled.

**4**

Press the **MENU** button to exit.

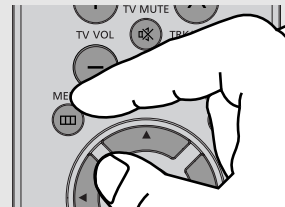

## Using the Tape Counter

The tape counter:

- Indicates the elapsed time in the play and record modes (hours, minutes and seconds).
- Is reset when a cassette is inserted in the DVD-VCR.
- Allows you to easily find the beginning of a sequence.
- If the remaining time is to be calculated correctly, you must indicate the type of cassette being used.

### 1

Insert a cassette in your DVD-VCR. To set the tape counter to zero at the beginning of a sequence:

- Press the **INFO.** button twice to display the counter
- Press the **CLEAR** button when you want to set the tape counter to zero.

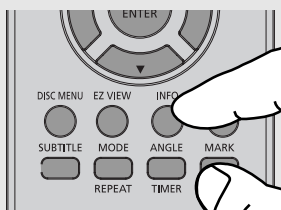

### 2

When you are ready,

- Start playback or recording.
- Press the **■** (Stop) button.
- To fast-forward or rewind to the sequence at which the counter was set to zero, press the the **▶▶▶/▶▶** (Forward) or **◀◀/◀◀** (Rewind) buttons on the remote control.
- Some DVD-VCR information, such as the counter, can be displayed on the television screen.



Press the **INFO.** button:

- Once to display the current function, recording speed and counter.
- Twice to display the counter only.
- Three times to display the time remaining on the cassette.
- Four times to clear the display.

## Using the Assemble Edit Function

This function allows you to start a new recording at a specific position on the cassette while maintaining a very smooth scene change.

**1**

Insert the cassette to be edited in your DVD-VCR.

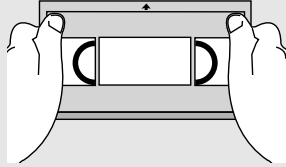

**2**

Press the **▶||** (Play/Pause) button to start playback.



**3**

When you reach the position from which you wish to start the new recording, press the **▶||** (Play/Pause) button.

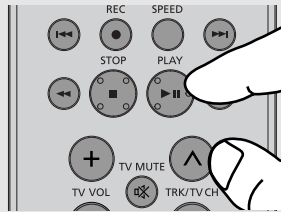

**4**

Press the **F.ADV** button as often as necessary to advance frame by frame, until the exact recording position is located.



**5**

While the DVD-VCR is in pause mode, press the **REC** button. The pause mode is displayed on the screen.



## VCR OPERATIONS

**6**

Select the source from which you wish to record by pressing:

- The **CH**  $\wedge$  or  $\vee$  button for television channel.
- The **INPUT SEL.** button for the **LINE1** or **LINE2** input source.

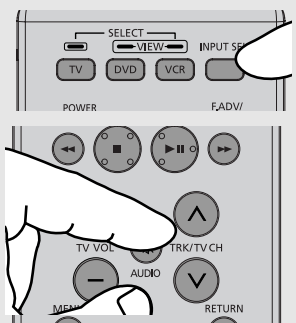

**7**

Press the **REC** button to start recording. When you have finished recording, press the **■** (Stop) button.



## Selecting the Audio Output Mode

You can select the mode in which the sound is reproduced on the loudspeakers and AV outputs. The following options are available.

Press the **AUDIO** button on the remote control until the required option is displayed.



### Audio output Mode

- **Left** : Used to listen to the sound on the left Hi-Fi channel.
- **Right** : Used to listen to the sound on the right Hi-Fi channel.
- **Mono** : Used to listen to the sound on the normal mono channel.
- **Hi-Fi** : Used to listen to Hi-Fi stereo sound on the left and right channels. When playing back tapes recorded in Hi-Fi, the sound switches to Hi-Fi after five seconds of Mono.

## Searching for a Specific Sequence

Each time you record a cassette on this DVD-VCR, an “index” is automatically marked on the tape when recording starts.

The Search function allows you to fast-forward or rewind to a specific index and start playback from that point. Depending on the direction selected, the indexes are numbered as follows:

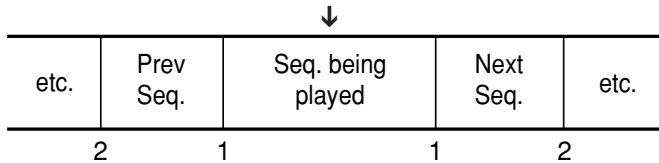

This DVD-VCR uses a standard indexing system (VISS). As a result, it will recognize any indexes marked by other VCRs using the same system and vice versa.

**1**

Press the **MENU** button on the remote control.

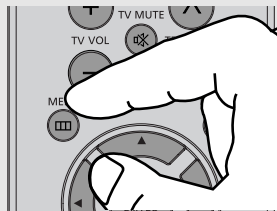

**2**

Press the ▲/▼ buttons to select **Function**, then press the ► or **ENTER** button.

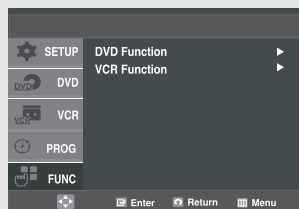

**3**

Press the ▲/▼ buttons to select **VCR Function**, then press the ► or **ENTER** button.

VCR Function can be displayed simply by pressing the **SEARCH** button.

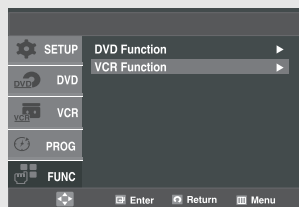

**4**

Press the ▲/▼ buttons to select the desired item, then press the ► or **ENTER** button.

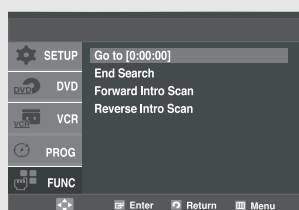



## VCR OPERATIONS

### Variable Search System

#### Go To [0:00:00] Stop

Use this feature when you want to search for the 0:00:00 counter position on a cassette.

Press the **CLEAR** button at the point on the tape where you want to set the counter to [0:00:00].

The VCR will rewind or fast forward, searching for the 0:00:00 counter position, and then automatically stop at that position.

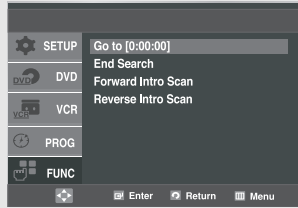

#### End Search

Use this feature when you want to search for a blank position to record a program on a cassette.

The VCR will fast forward, searching for a blank position, and then automatically stop at that position.

If the VCR reaches the end of the tape during end search, the tape will be ejected.

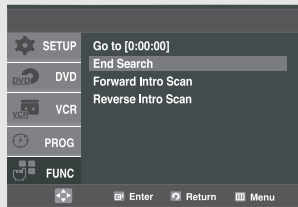

#### Scan and Play

Use scan and play when you don't know exactly where a program is located on a cassette tape.

##### - Forward Intro Scan

Select "Forward Intro Scan", then press the **ENTER** button.

##### - Reverse Intro Scan

Select "Reverse Intro Scan", then press the **ENTER** button.

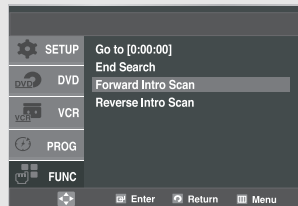

## Basic Recording

You can record a TV show in progress by inserting a blank tape and pressing the REC button. You can even add time in 30-minute increments up to 4 hours by pressing the REC button repeatedly; see page 76.

### Note

Be sure your videotape has a Record Safety Tab. If the tab is missing, you can cover the opening with a small piece of tape. Warning: Do not cover this opening unless you are sure you want to record over the tape.

### Before You Begin...

- Power on the DVD-VCR
- Power on the TV

## Protecting a Recorded Cassette

Video cassettes have a safety tab to prevent accidental erasure. When this tab has been removed, you cannot record on the tape.

If you wish to protect a cassette, break off the tab using a small screwdriver.

To re-record over a protected cassette (safety tab broken), cover the hole with adhesive tape.

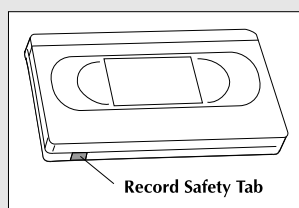

## Recording

**1**

Insert a blank VHS tape into the VCR deck.

Make sure the tape is long enough to record the entire program.

Press the SPEED button to set the record speed.

(See page 77)

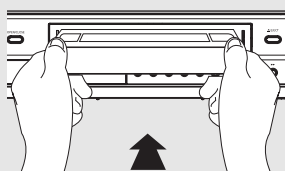

**2**

Press the **INPUT SEL.** or **^ v** button to select **Line 1** or **2** if recording from an external device connected to the front or rear jacks, respectively.

## VCR OPERATIONS

### 3

Press the **REC** button on the remote control or front panel.

For options while recording is in progress, see “Special Recording Features” on this page.



### Note

Recording from the DVD to the VCR is not possible.

### 4

#### Pause/Resume Recording

Press the **▶||** (Play/Pause) button.

Press the **REC** button again to resume.



### 5

#### Stop Recording

Press the **■** (Stop) button.



## Special Recording Features

While a recording is in progress, you can watch a DVD, or add recording time in 30-minute increments.

### To Watch a DVD while Recording

Insert a DVD in the DVD tray and press the **▶||** (Play/Pause). The output will automatically change to the DVD.

### To Add Recording Time

See One-Touch Recording (OTR) on page 76.

## Using One-Touch Recording

One-Touch Recording (OTR) allows you to add recording time in 30-minute increments up to 4 hours at the touch of a button.

**1**

Insert a blank VHS tape into the VCR deck.

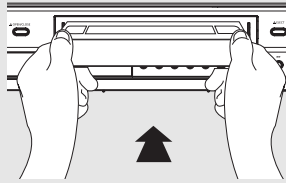

**2**

Use the **CH**  $\wedge$  or  $\vee$  buttons to select the desired TV channel, or press the **INPUT SEL.** button to select **Line 1** or **2** if recording from an external device connected to the front or rear jacks, respectively.

**3**

Press the **REC** button on the remote control or front panel.



**4**

While in Record mode, press the **REC** button again to activate One-Touch Recording (OTR).

**Record length 0:30** appears on the On-screen display and the DVD-VCR will record for exactly 30 minutes.



## VCR OPERATIONS

### 5

#### Add Recording Time

Continue pressing **REC** button to add recording time in 30 minute increments up to 4 hours.

The DVD-VCR stops recording automatically when the time has elapsed. The DVD-VCR will automatically be turned off when the OTR finished.



## Selecting the Recording Speed

You can slow down the recording speed from SP to SLP in order to fit six hours of programming on a T-120 tape.

Press the **SPEED** button on the remote control to select the Record Speed.

- SP: Standard Play, for best quality.
- SLP: Super Long Play, for maximum recording time (3 times SP).

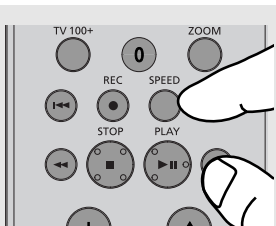

#### Note

The selected Record Speed will appear on the front panel display and on-screen display.

#### Maximum Recording Time - SP vs. SLP

Tape Length	SP (Standard Play)	SLP (Super Long Play)
T-120	2 hrs	6 hrs
T-160	2hrs 40 mins	8 hrs
T-180	3 hrs	9 hrs

# Making a Timer Recording

Insert a blank videotape into the VCR deck. Be sure to leave the Record Safety Tab intact. With the Timer Recording function, you can program up to 7 events at a time to record up to a month in advance.

## To Begin Setting the Timer Recording,

- Power On your DVD-VCR.
- Power On your TV.

**1**

Press the **MENU** button on the remote control.

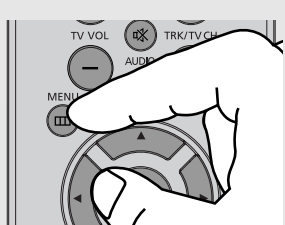

**2**

Press the ▲/▼ buttons to select **PROG**, then press the ► or **ENTER** button.

The Timer Program Screen can be displayed simply by pressing the **TIMER** button.

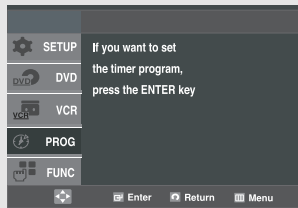

**3**

### Select Line input 1 or 2

Press the ► button, then press the ▲/▼ buttons to select Line in 1 or Line in 2.

Press the ► button to move to the next setting.

No	In	Start	End	Date	Speed
1.	L 1	--:--	--:--	--/--	--
2.	--	--:--	--:--	--/--	--
3.	--	--:--	--:--	--/--	--
4.	--	--:--	--:--	--/--	--
5.	--	--:--	--:--	--/--	--
6.	--	--:--	--:--	--/--	--
7.	--	--:--	--:--	--/--	--

### Note

You can select an external device connected to L1(Line 1) or L2(Line 2) by pressing the **INPUT SEL.** button.

**4**

### Set Time/Date/Speed

Repeat Step 3 above to set start time, end time, date and record speed.

Date can be set for one time, daily or weekly recording.

No	In	Start	End	Date	Speed
1.	L 1	12:01 am	12:30 am	1/01	SP
2.	--	--:--	--:--	--/--	--
3.	--	--:--	--:--	--/--	--
4.	--	--:--	--:--	--/--	--
5.	--	--:--	--:--	--/--	--
6.	--	--:--	--:--	--/--	--
7.	--	--:--	--:--	--/--	--

## VCR OPERATIONS

### Selecting Auto Speed

If the length of the videotape is not long enough for a timer recording in the SP mode, set the recording tape speed to "Auto". Recording will start in the SP mode. If the length is not long enough, the tape speed will automatically change from SP mode to SLP mode.

### Daily/Weekly Date Programming

Weekly [Sun~Sat]: Use this to record TV programs on the same Line In at the same time every week. Daily [Mon, Tue, Wed, Thu, Fri]: Use this to record TV programs on the same channel at the same time every day Monday through Friday.

## 5

### Save Timer Recording

Press the **RETURN** button to finish setting the timer recording.

Stop the DVD-VCR or turn the power off. Then the DVD-VCR will automatically turn on and begin recording at the time you set.

To stop the timer recording, press the **POWER** button or press the **■** (Stop) button twice.



# Chapter 6

## REFERENCE

### Using the TV Buttons on the Remote Control

Your DVD-VCR remote control will work with Samsung televisions and compatible brands.

To determine whether your television is compatible, follow the instructions below.

- 1 Switch your television on.
- 2 Point the remote control towards the television.
- 3 Hold down the TV button and enter the two-figure code corresponding to the brand of your television, by pressing the appropriate numeric buttons.

TV Codes	
BRAND	CODE
SAMSUNG	01, 14, 15, 23
DAEWOO	19
EMERSON	21
HITACHI	10
LG	06, 08, 18
LOEWE	28
MAGNAVOX	04
NEWSAN	27
NOBLEX	25
PANASONIC	12, 24
RCA	07, 29
SANYO	05, 20
SHARP	02, 16, 22
SONY	03
TELEFUNKEN	26
TOSHIBA	09
ZENITH	17

#### Note

- If your television is compatible with the remote control, it will switch off. It is now programmed to operate with the remote control.
- If several codes are indicated for your television brand, try each one in turn until you find one that works.

You can then control the television using the following buttons.

Button	Function
POWER	Used to switch the television on and off.
INPUT SEL.	Used to select an external source.
TV VOL + or -	Used to adjust the volume of the television.
TV CH ( ^ or v )	Used to select the required channel.
TV MUTE	Used to toggle the sound on and off.

The various functions will not necessarily work on all televisions. If you encounter problems, operate the television directly.



## Troubleshooting

Before contacting a Samsung authorized service center, perform the following simple checks.

If you are unable to solve the problem after reading the above instructions, note:

- The model and serial number on the rear of your DVD-VCR
- The warranty information
- A clear description of the problem

Then contact your nearest SAMSUNG service center.

### Identifying DVD Problems

Problem	Action	Page
No operations can be performed with the remote control.	<ul style="list-style-type: none"> <li>• Check the batteries in the remote control. They may need replacing.</li> <li>• Operate the remote control at a distance of no more than 20 feet.</li> <li>• Remove batteries and hold down one or more buttons for several minutes to drain the microprocessor inside the remote control to reset it. Reinstall batteries and try to operate the remote control again.</li> </ul>	P5
Disc does not play.	<ul style="list-style-type: none"> <li>• Ensure that the disc is installed with the label side facing up.</li> <li>• Check the region number of the DVD.</li> </ul>	P9
5.1 channel sound is not being reproduced.	<ul style="list-style-type: none"> <li>• 5.1 channel sound is reproduced only when the following conditions are met.:               <ol style="list-style-type: none"> <li>1) The DVD-VCR is connected with the proper Amplifier</li> <li>2) The disc is recorded with 5.1 channel sound.</li> </ol> </li> <li>• Check whether the disc being played has the "5.1 ch" mark on the outside.</li> <li>• Check if your audio system is connected and working properly.</li> <li>• In a DVD Setup Menu, is the Audio Output set to Bitstream?</li> </ul>	P20
The  icon appears on screen.	<ul style="list-style-type: none"> <li>• The features or action cannot be completed at this time because:               <ol style="list-style-type: none"> <li>1. The DVD's software restricts it.</li> <li>2. The DVD's software doesn't support the feature (e.g., angles).</li> <li>3. The feature is not available at the moment.</li> <li>4. You've requested a title or chapter number or search time that is out of range.</li> </ol> </li> </ul>	-
Disc Menu doesn't appear.	<ul style="list-style-type: none"> <li>• Check if the disc has a Menu.</li> </ul>	-
Play mode differs from the Setup Menu selection.	<ul style="list-style-type: none"> <li>• Some of the functions selected in the Setup Menu may not work properly if the disc is not encoded with the corresponding function.</li> </ul>	-
The screen ratio cannot be changed.	<ul style="list-style-type: none"> <li>• The Screen Ratio is fixed on your DVDs.</li> </ul>	P35-36
No audio.	<ul style="list-style-type: none"> <li>• Make sure you have selected the correct Digital Output in the Audio Options Menu.</li> </ul>	P52~53

## VCR OPERATIONS

Problem	Action	Page
The screen is blocked	<ul style="list-style-type: none"> <li>Press the ◀◀/▶▶ button for more than 5 seconds with no disc in the unit. All settings will revert to the factory settings.</li> </ul>	-
Forgot password	<ul style="list-style-type: none"> <li>From a cold start with no disc in unit, press the ◀◀/▶▶ button simultaneously on the front panel for 5 seconds. All settings including the password will revert to the factory settings. Don't use this unless absolutely necessary.</li> </ul>	P58
If you experience other problems.	<ul style="list-style-type: none"> <li>Go to the contents and find the section of the instruction book that contains the explanations regarding the current problem, and follow the procedure once again.</li> <li>If the problem still cannot be solved, please contact your nearest authorized service center.</li> </ul>	
The picture is noisy or distorted	<ul style="list-style-type: none"> <li>Make sure that the disc is not dirty or scratched.</li> <li>Clean the disc.</li> </ul>	

### Identifying VCR Problems

Problem	Action	Page
No power	<ul style="list-style-type: none"> <li>Check that the power plug is connected to a wall outlet.</li> </ul>	-
You cannot insert a video cassette	<ul style="list-style-type: none"> <li>A video cassette can only be inserted with the window side up and the safety tab facing you.</li> </ul>	P74
The television program was not recorded	<ul style="list-style-type: none"> <li>Check the DVD-VCR antenna/cable connections.</li> <li>Is the DVD-VCR tuner properly set?</li> <li>Check if the safety tab is intact on the cassette.</li> </ul>	-
Timer recording was unsuccessful	<ul style="list-style-type: none"> <li>Re-check the recording start/stop time settings.</li> <li>If there was a power failure or interruption during timer recording, the recording will have been cancelled.</li> </ul>	P78-79
No playback picture or the picture is distorted	<ul style="list-style-type: none"> <li>Check to see if you are using a prerecorded tape.</li> </ul>	P63
You cannot see normal broadcasts	<ul style="list-style-type: none"> <li>Check the tuner or external setting. It should be on tuner.</li> <li>Check the TV or VCR antenna connections.</li> </ul>	-
Noise bars or streaks on playback	<ul style="list-style-type: none"> <li>Press the TRK buttons to minimize this effect.</li> </ul>	P65
When the ▶   button is pressed during playback, the still picture has severe "noise bar" streaks	<ul style="list-style-type: none"> <li>A still picture may have "noise bars", depending on the condition of the tape. Press the TRK buttons during slow motion to minimize this effect.</li> </ul>	-
Video Head Cleaning	<ul style="list-style-type: none"> <li>If poor pictures appear on a variety of cassettes, the video heads may need cleaning. This is not a common problem and unless it appears, the heads should not be cleaned. When cleaning the video heads, read all instructions provided with the head cleaning cassette. Incorrect head cleaning can permanently damage the video heads.</li> </ul>	-

## Technical Specifications

<b>Inputs</b>	AUDIO	2 Stereo audio inputs, RCA Connector, -8dbm, 47K $\Omega$ , front and rear
	VIDEO	2 Composite video inputs, RCA Connector, 75 $\Omega$ , 1Vp-p
<b>Outputs</b>	AUDIO	1 Stereo audio outputs, RCA Connector, -8dbm, 1.5K $\Omega$
	AUDIO (DVD only)	2 Digital audio output (1 coaxial, 1 optical) 1 pair Stereo audio outputs
	VIDEO	1 Composite video output, RCA Connector, 75 $\Omega$ , 1Vp-p
	VIDEO (DVD only)	1 Component video output, 75 $\Omega$ , Y=1.0Vp-p, Pb=0.7Vp-p, Pr=0.7Vp-p
	HDMI	1 HDMI output
<b>VCR</b>	VIDEO SYSTEM	1/2-inch VHS system, 4 rotary head helical scanning; FM azimuth luminance;chrominance: converted sub system phase shift
	AUDIO TRACK	Normal: 1 track; Hi-Fi: 2 track
	PLAY/RECORD TIME	T-180 tape: SP 3 hours, SLP 9 hours
	FF/REW TIME	T-120 tape: <2 minutes
	HEADS	Video: DA 4 rotary
		Audio: 2 rotary heads (Hi-Fi); 1 stationary head (Linear) Control: 1 stationary head Erase: 1 full track, 1 audio track
	WOW & FLUTTER	Less than 0.005% (Hi-Fi)
	FREQ. RESPONSE	20-20,000 Hz (Hi-Fi)
	DISC COMPATIBILITY	CD, CD-R, CD-RW
<b>DVD</b>		DVD-Video, CD-Digital Audio (5" and 3.5")
	FREQ. RESPONSE	96/48 kHz Sampling: 4 Hz-22kHz
	S/N RATIO	110 dB
	DYNAMIC RANGE	96 dB
	THD	0.003 %
	POWER REQUIREMENT	120V AC, 60 Hz, 25 watts
<b>SYSTEM</b>	ENVIRONMENT	41-104°F (5-40°C); 10%-75% humidity
	WEIGHT	13.8 lbs.

- Samsung Electronics Co., Ltd reserves the right to change the specifications with out notice.

- Weight and dimensions are approximate.

MEMO

MEMO

## Contact SAMSUNG WORLD WIDE

If you have any questions or comments relating to Samsung products, please contact the SAMSUNG customer care centre.

Region	Country	Customer Care Center ☎	Web Site
North America	CANADA	1-800-SAMSUNG(726-7864)	www.samsung.com/ca
	MEXICO	01-800-SAMSUNG(726-7864)	www.samsung.com/mx
	U.S.A	1-800-SAMSUNG(726-7864)	www.samsung.com/us
Latin America	ARGENTINE	0800-333-3733	www.samsung.com/ar
	BRAZIL	0800-124-421 , 4004-0000	www.samsung.com/br
	CHILE	800-SAMSUNG(726-7864)	www.samsung.com/cl
	COSTA RICA	0-800-507-7267	www.samsung.com/latin
	ECUADOR	1-800-10-7267	www.samsung.com/latin
	EL SALVADOR	800-6225	www.samsung.com/latin
	GUATEMALA	1-800-299-0013	www.samsung.com/latin
	JAMAICA	1-800-234-7267	www.samsung.com/latin
	PANAMA	800-7267	www.samsung.com/latin
	PUERTO RICO	1-800-682-3180	www.samsung.com/latin
	REP. DOMINICA	1-800-751-2676	www.samsung.com/latin
	TRINIDAD & TOBAGO	1-800-SAMSUNG(726-7864)	www.samsung.com/latin
	VENEZUELA	0-800-100-5303	www.samsung.com/latin
COLOMBIA	01-8000112112	www.samsung.com.co	
Europe	BELGIUM	0032 (0)2 201 24 18	www.samsung.com/be
	CZECH REPUBLIC	844 000 844 Distributor pro Českou republiku : Samsung Zrt., česká organizační složka Vyskočilova 4, 14000 Praha 4	www.samsung.com/cz
	DENMARK	70 70 19 70	www.samsung.com/dk
	FINLAND	030-6227 515	www.samsung.com/fi
	FRANCE	3260 SAMSUNG(726-7864) or 08 25 08 65 65 (€ 0,15/Min)	www.samsung.com/fr
	GERMANY	01805 - 121213 (€ 0,14/Min)	www.samsung.de
	HUNGARY	06-80-SAMSUNG(726-7864)	www.samsung.com/hu
	ITALIA	800-SAMSUNG(726-7864)	www.samsung.com/it
	LUXEMBURG	0035 (0)2 261 03 710	www.samsung.com/be
	NETHERLANDS	0900 20 200 88 (€ 0,10/Min)	www.samsung.com/nl
	NORWAY	815-56 480	www.samsung.com/no
	POLAND	0 801 801 881 , 022-607-93-33	www.samsung.com/pl
	PORTUGAL	80 8 200 128	www.samsung.com/pt
	SLOVAKIA	0800-SAMSUNG(726-7864)	www.samsung.com/sk
	SPAIN	902 10 11 30	www.samsung.com/es
	SWEDEN	0771-400 200	www.samsung.com/se
	U.K	0870-SAMSUNG(726-7864)	www.samsung.com/uk
	Republic of Ireland	0818 717 100	www.samsung.com/ie
	AUSTRIA	0800-SAMSUNG(726-7864)	www.samsung.com/at
	Switzerland	0800-SAMSUNG(726-7864)	www.samsung.com/ch
CIS	RUSSIA	8-800-555-55-55	www.samsung.ru
	KAZAHSTAN	8-10-800-500-55-500	www.samsung.kz
	UZBEKISTAN	8-800-120-0-400	www.samsung.uz
	KYRGYZSTAN	00-800-500-55-500	
	UKRAINE	8-800-502-0000	www.samsung.ua
	LITHUANIA	8-800-77777	www.samsung.lt
	LATVIA	800-7267	www.samsung.com/lv
	ESTONIA	800-7267	www.samsung.ee
Asia Pacific	AUSTRALIA	1300 362 603	www.samsung.com/au
	New zealand	0800SAMSUNG(726-7864)	www.samsung.com/nz
	CHINA	800-810-5858 , 010-6475 1880	www.samsung.com.cn
	HONG KONG	3698-4698	www.samsung.com/hk
	INDIA	3030 8282 , 1800 110011	www.samsung.com/in
	INDONESIA	0800-112-8888	www.samsung.com/id
	JAPAN	0120-327-527	www.samsung.com/jp
	MALAYSIA	1800-88-9999	www.samsung.com/my
	PHILIPPINES	1800-10-SAMSUNG(726-7864)	www.samsung.com/ph
	SINGAPORE	1800-SAMSUNG(726-7864)	www.samsung.com/sg
	THAILAND	1800-29-3232 , 02-689-3232	www.samsung.com/th
	TAIWAN	0800-329-999	www.samsung.com/tw
VIETNAM	1 800 588 889	www.samsung.com/vn	
Middle East & Africa	Turkey	444 77 11	www.samsung.com.tr
	SOUTH AFRICA	0860-SAMSUNG(726-7864 )	www.samsung.com/za
	U.A.E	800-SAMSUNG (726-7864), 8000-4726	www.samsung.com/mea

# Warranty

---

## LIMITED WARRANTY TO ORIGINAL PURCHASER

This SAMSUNG brand product, as supplied and distributed by SAMSUNG ELECTRONICS AMERICA, INC. (SAMSUNG) and delivered new, in the original carton to the original consumer purchaser, is warranted by SAMSUNG against manufacturing defects in materials and workmanship for the following limited warranty period:

### **One (1) Year Parts / Ninety days (90) Labor**

This limited warranty begins on the original date of purchase, and is valid only on products purchased and used in the United States, and does not include transportation, installation, removal or reinstallation.

Warranty repairs must be performed by SAMSUNG'S authorized service center. To receive warranty service, the original dated bill of sale must be presented upon request as proof of purchase to SAMSUNG or SAMSUNG'S authorized service center. Transportation to and from the service center is the responsibility of the purchaser.

SAMSUNG will repair or replace this product, at our option and at no charge with new or reconditioned parts, if found to be defective during the limited warranty period specified above. The product must be returned during the warranty period with transportation charges prepaid to SAMSUNG's designated service center. Prior to returning any product for warranty service, the purchaser must contact SAMSUNG for problem determination and service procedures. SAMSUNG does not warrant uninterrupted or error-free operation of the product.

All replaced parts and products become the property of SAMSUNG and must be returned to SAMSUNG.

Replacement parts and products assume the remaining original warranty, or ninety (90) days, whichever is longer.

This limited warranty covers manufacturing defects in materials and workmanship encountered in normal, noncommercial use of this product and shall not apply to the following, including, but not limited to: damage which occurs in shipment; applications and uses for which this product was not intended; failures or problems which are caused by products or equipment not supplied by SAMSUNG; accidents, misuse, abuse, neglect, misapplication, fire, water, lightning or other acts of nature; incorrect electrical line voltage, fluctuations or surges; damage caused by improper or faulty installation; improper connection with any peripheral; product alteration or modification; improper or unauthorized repair; cosmetic damage or exterior finish; product with altered serial numbers; failure to follow operating instructions, customer adjustments, maintenance and environmental instructions that are covered and prescribed in the instruction book; use of non-SAMSUNG or unauthorized parts, supplies, accessories or equipment which damage this product or result in service problems; failures or problems due to incompatibility with other equipment.



**Contact SAMSUNG WORLD WIDE**

If you have any questions or comments relating to Samsung products,  
please contact the SAMSUNG customer care center.

☎ 1-800-SAMSUNG (7267864) / [www.samsung.com](http://www.samsung.com)

Samsung Electronics America, Inc.  
105 Challenger Road  
Ridgefield Park, NJ 07660-0511

1-800-SAMSUNG (7267864)  
[www.samsung.com](http://www.samsung.com)