

BD-P1500

Blu-ray Disc Player user manual

imagine the possibilities

Thank you for purchasing this Samsung product.
To receive a more complete service, please register
your product at

www.samsung.com/global/register



key features of your new Blu-ray Disc Player

Player Features

Supports a Variety of Disc Types

Supports Blu-ray (BD-ROM, BD-RE, BD-R), DVD Video, DVD-RW/-R (V mode and finalized only) discs and Audio CD.

HDMI (High Definition Multimedia Interface)

HDMI reduces picture noise by allowing a pure digital video/audio signal path from the player to your TV.

DivX Certification

DivX® is a digital video format created by DivX, Inc. This is an official DivX Certified or DivX Ultra Certified device that plays DivX video.



Blu-ray Disc Features

Blu-ray Discs can store 25 GB (single layer) or 50 GB (dual layer) on a single sided disc - about 5 to 10 times the capacity of a DVD. Blu-ray Discs also support the highest quality HD video available in the industry - Large capacity means no compromise on video quality. Furthermore, a Blu-ray Disc has the same familiar size and look as a DVD.

* The following Blu-ray Disc features are disc dependant and will vary.
Appearance and navigation of features will also vary from disc to disc.
Not all discs will have the features described below.

Video highlights

The BD-ROM format supports three highly advanced video codecs, including AVC, VC-1, and MPEG-2.

HD video resolutions are also available:

- 1920 x 1080 High Definition
- 1280 x 720 High Definition

For High-Definition Playback

To view high-definition contents on a Blu-ray Disc, an HDTV (High Definition Television) is required. Some Blu-ray Discs may require using the player's HDMI OUT to view high-definition content. The ability to view high-definition content on Blu-ray Discs may be limited depending on the resolution of your TV.

Graphic planes

Two individual, full HD resolution (1920x1080) video layers are available, on top of the HD video layer.

One layer is assigned to video-related graphics (like subtitles), and the other layer is assigned to interactive elements, such as buttons or menus. Various wipes, fades and scroll effects may be available on both layers.



Menu graphics

Support full color resolution graphics and animation, thereby greatly surpassing the capabilities of DVD-Video. Unlike DVD, Menus can be accessed during video playback.

Menu sounds

When you highlight or select a menu option on a disc, sounds can be heard such as button clicks or a voice-over explaining the highlighted menu choice.

Multi-page/PopUp Menu

Unlike the DVD-Video, playback is not interrupted each time a new menu screen is accessed. Due to Blu-ray Disc's ability to preload data from the disc without interrupting playback, a menu may consist of several pages. You can browse through the menu pages or select different menu paths, while the audio and video continues playing in the background.



Interactivity

Certain Blu-ray Discs may contain Animated menus and Trivia games.

User Browsable Slideshows

With Blu-ray Discs, you can browse through various still pictures while the audio remains playing.

Subtitles



Depending on what is contained on the Blu-ray Disc, you may be able to select different font styles, sizes and colors for the subtitles. Subtitles may also be animated, scrolled or faded in and out.

BD-LIVE

You can use a Blu-ray disc supporting BD-LIVE through network connection to enjoy various contents provided by the disc manufacturer.

WHAT'S INCLUDED

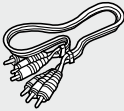
Check for the supplied accessories below.

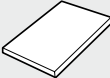
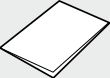
		
Composite (Video), Audio L/R Cable	Batteries for Remote Control (AAA Size)	
		
User Manual	Quick Guide	

safety information

WARNING

TO REDUCE THE RISK OF ELECTRIC SHOCK, DO NOT REMOVE THE COVER(OR BACK).
NO USER-SERVICEABLE PARTS ARE INSIDE. REFER SERVICING TO QUALIFIED SERVICE PERSONNEL.

	CAUTION RISK OF ELECTRIC SHOCK DO NOT OPEN	
This symbol indicates "dangerous voltage" inside the product that presents a risk of electric shock or personal injury.	CAUTION: TO REDUCE THE RISK OF ELECTRIC SHOCK, DO NOT REMOVE COVER (OR BACK) NO USER SERVICEABLE PARTS INSIDE. REFER SERVICING TO QUALIFIED SERVICE PERSONNEL.	This symbol indicates important instructions accompanying the product.

Do not install this equipment in a confined space such as a bookcase or similar unit.

WARNING : To prevent damage which may result in fire or electric shock hazard, do not expose this appliance to rain or moisture.

CAUTION : Blu-ray Disc Player USES AN INVISIBLE LASER BEAM WHICH CAN CAUSE HAZARDOUS RADIATION EXPOSURE IF DIRECTED. BE SURE TO OPERATE Blu-ray Disc Player CORRECTLY AS INSTRUCTED.

CAUTION

THIS PRODUCT UTILIZES A LASER. USE OF CONTROLS OR ADJUSTMENTS OR PERFORMANCE OF PROCEDURES OTHER THAN THOSE SPECIFIED HEREIN MAY RESULT IN HAZARDOUS RADIATION EXPOSURE. DO NOT OPEN COVERS AND DO NOT REPAIR YOURSELF. REFER SERVICING TO QUALIFIED PERSONNEL.

This product satisfies CE regulations when shielded cables and connectors are used to connect the unit to other equipment. To prevent electromagnetic interference with electric appliances, such as radios and televisions, use shielded cables and connectors for connections.

IMPORTANT NOTE

The mains lead on this equipment is supplied with a moulded plug incorporating a fuse. The value of the fuse is indicated on the pin face of the plug.

If it requires replacing, a fuse approved to BS1362 of the same rating must be used.

Never use the plug with the fuse cover omitted if the cover is detachable. If a replacement fuse cover is required, it must be of the same colour as the pin face of the plug. Replacement covers are available from your dealer.

If the fitted plug is not suitable for the power points in your house or the cable is not long enough to reach a power point, you should obtain a suitable safety approved extension lead or consult your dealer for assistance.

However, if there is no alternative to cutting off the plug, remove the fuse and then safely dispose of the plug. Do not connect the plug to a mains jack, as there is a risk of shock hazard from the bared flexible cord.

To disconnect the apparatus from the mains, the plug must be pulled out from the mains socket, therefore the mains plug shall be readily operable.

The product unit accompanying this user manual is licenced under certain intellectual property rights of certain third parties. This licence is limited to private non-commercial use by end-user consumers for licenced contents.

No rights are granted for commercial use.

The licence does not cover any product unit other than this product unit and the licence does not extend to any unlicensed product unit or process conforming to ISO/IEC 11172-3 or ISO/IEC 13818-3 used or sold in combination with this product unit. The licence only covers the use of this product unit to encode and/or decode audio files conforming to the ISO/IEC 11172-3 or ISO/IEC 13818-3. No rights are granted under this licence for product features or functions that do not conform to the ISO/IEC 11172-3 or ISO/IEC 13818-3.

PRECAUTIONS

Important Safety Instructions

Read these operating instructions carefully before using the unit. Follow all the safety instructions listed below. Keep these operating instructions handy for future reference.

- 1) Read these instructions.
- 2) Keep these instructions.
- 3) Heed all warnings.
- 4) Follow all instructions.
- 5) Do not use this player near water.
- 6) Clean only with dry cloth.
- 7) Do not block any ventilation openings, Install in accordance with the manufacturer's instructions.
- 8) Do not install near any heat sources such as radiators, heat registers, or other player (including amplifiers) that produce heat.
- 9) The polarized or the grounding type plug has an important safety purpose. A polarized plug has two blades with one wider than the other. A grounding type plug has two blades and a third grounding prong. The wide blade or the third prong are provided for your safety. If the provided plug does not fit into your outlet, consult an electrician for replacement of the obsolete outlet.
- 10) Protect the power cord from being deformed or pinched particularly at plugs, convenience receptacles, and the point where they exit from the player.
- 11) Only use attachments/accessories specified by the manufacturer.
- 12) Use only with the cart, stand, tripod, bracket, or table specified by the manufacturer, or sold with the player. When a cart is used, use caution when moving the cart/ player combination to avoid injury from tip-over.
- 13) Unplug this player during lightning storms or when unused for long periods of time.
- 14) Refer all servicing to qualified service personnel. Servicing is required when the player has been damaged in any way, such as power-supply cord or plug is damaged, liquid has been spilled or objects have fallen into the player the player has been exposed to rain or moisture, does not operate normally, or has been dropped.



safety information

Handling Cautions

- Before connecting other components to this Blu-ray Disc Player, be sure to turn them all off.
- Do not move the Blu-ray Disc Player while a disc is being played as the disc may be scratched or broken, or the Blu-ray Disc Player's internal parts may be damaged.
- Do not put a flower vase filled with water or any small metal objects on the Blu-ray Disc Player.
- Be careful not to put your hand into the disc tray.
- Do not place anything other than the disc in the disc tray.
- Exterior interferences such as lightning and static electricity can affect the normal operation of this Blu-ray Disc Player. If this occurs, turn the Blu-ray Disc Player off and on again with the **STANDBY/ON** button, or disconnect and then reconnect the AC power cord to the AC power outlet. The Blu-ray Disc Player will operate normally.
- Be sure to remove the disc and turn off the Blu-ray Disc Player after use.
- Disconnect the AC power cord from the AC outlet when you don't intend to use the Blu-ray Disc Player for long periods of time.
- To clean a disc, wipe it in a straight line from the inside to the outside of the disc.
- Do not expose the player to any liquid.
- When the AC plug is connected to a wall outlet, the player will still draw power (standby mode) when it is turned off.
- The player should not be exposed to dripping or splashing of any liquid and no objects filled with liquids, such as vases, should be placed on the player.
- To disconnect the player from the mains, the plug must be pulled out from the mains socket, therefore the mains plug shall be easily accessible.

Maintenance of Cabinet

For safety reasons, be sure to disconnect the AC power cord from the AC outlet.

- Do not use benzene, thinner, or other solvents for cleaning.
- Wipe the cabinet with a soft cloth.

Restrictions on Playback

- This player may not respond to all operating commands because some Blu-ray Disc, DVD, CD discs allow specific or limited operation and features during playback. Please note that this is not a defect in the player.
- Samsung cannot assure that this player will play every disc bearing the Blu-ray Disc, DVD or CD logo because disc formats evolve, and problems and errors may occur during the creation of Blu-ray Disc, DVD, CD software and/or the manufacture of discs. Please contact the SAMSUNG customer care center if you have questions or encounter difficulty in playing Blu-ray Disc, DVD, CD discs in this player. Also, refer to rest of this Manual for additional information on playback restrictions.

contents

KEY FEATURES OF YOUR NEW BLU-RAY DISC PLAYER	2	3	What's included
SAFETY INFORMATION	4	4	Warning
		5	Precautions
GETTING STARTED	9	9	Before using the User's Manual
		10	Disc Type and Characteristics
		13	Disc Storage & Management
DESCRIPTION	14	14	Front Panel
		15	Front Panel Display
		16	Rear Panel
REMOTE CONTROL	17	17	Tour of the Remote Control
		18	Setting the Remote Control
		18	Regarding the battery
		19	Controllable TV Codes
CONNECTIONS	20	20	Connecting to a TV with an HDMI Cable (Best Quality)
		21	HDMI Auto Detection Function
		22	Connecting to a TV with DVI Cable (Best Quality)
		23	Connecting to a TV (Component) (Better Quality)
		24	Connecting to a TV (VIDEO) (Good Quality)
		25	Connecting to an Audio System (2 Channel Amplifier)
		26	Connecting to an Audio System (Dolby Digital, DTS Amplifier)
		27	Connecting to an Audio System (HDMI supported Amplifier)
		28	Connecting to the Network
BASIC FUNCTIONS OF YOUR BLU-RAY DISC PLAYER	29	29	Before Playing
		30	On-Screen Menu Navigation
		30	Playing a Disc
		31	Setting the Power On / Off Melody sound
		31	Using the Search and Skip Functions
		32	Slow Motion Play/Step Motion Play
SYSTEM SETUP	33	33	Setting the Clock
LANGUAGE SETUP	34	34	Setting up the Language Options

contents









AUDIO SETUP	35	Setting up the Audio Options
35		
DISPLAY SETUP	37	Setting up the Display Options
37		
HDMI SETUP	40	Setting up the HDMI setup options
40		
PARENTAL SETUP	42	Setting up the Parental Lock
42		
NETWORK SETUP	44	TCP/IP Setting
44	45	Proxy Setting
	45	NTP server setting (Used to Retrieve Time Information from NTP server)
	46	Mac Address
	46	BD-LIVE Internet Connection
	47	System Device Management
PERSISTENT STORAGE MANAGEMENT		
47		
SYSTEM UPGRADE	48	Firmware Upgrade
48	50	System Information
	50	Firmware Upgrade Notification
WATCHING A MOVIE	51	Using the Display Function
51	52	Using the Disc Menu & Popup/Title Menu
	53	Repeat Play
	54	Selecting the Audio Language
	55	Selecting the Subtitle Language
	55	Changing the Camera Angle
	56	BONUSVIEW Settings
	56	BD-LIVE
	57	Using the Bookmark Function
LISTENING TO MUSIC	59	Playing an Audio CD(CD-DA)
59	59	Audio CD(CD-DA) Screen Elements
	60	Buttons on the Remote Control used for Audio CD (CD-DA) disc playback
	60	Repeat Audio CD(CD-DA)
TROUBLESHOOTING	62	Troubleshooting
62		
APPENDIX	64	Specifications
64		

getting started

BEFORE USING THE USER'S MANUAL

Make sure to check the following terms before using the user's manual.

Icons that will be used in this manual

Icon	Term	Definition
	BD-ROM	This involves a function available on a BD-ROM.
	BD-RE	This involves a function available on the BD-RE.
	BD-R	This involves a function available on the BD-R.
	DVD-VIDEO	This involves a function available on DVD-Video or DVD-R/DVD-RW discs that have been recorded and finalized in Video Mode.
	DVD-RW	This involves a function available on DVD-RW. (V mode and finalized only)
	DVD-R	This involves a function available on DVD-R. (V mode and finalized only)
	Audio CD	This involves a function available on an audio CD-RW/CD-R (CD-DA format).
	DivX	This involves a function available on CD-R/-RW, DVD-R discs.
	Note	This involves tips or instructions on the page that help each function operate.

About the use of this user's manual

- 1) Be sure to be familiar with Safety Instructions before using this product. (See pages 4~6)
- 2) If a problem occurs, check the Troubleshooting section. (See pages 62~63)

Copyright







©2008 Samsung Electronics Co.,Ltd.

All rights reserved; No part or whole of this user's manual may be reproduced or copied without the prior written permission of Samsung Electronics Co.,Ltd.









getting started

DISC TYPE AND CHARACTERISTICS

Disc types that can be played

Disc Types	Disc Logo	Recorded content	Disc Shape	Max. Playing minute
BD-ROM BD-RE/BD-R		AUDIO + VIDEO	Single sided	Playing time depends on the Title
DVD-VIDEO		AUDIO + VIDEO	Single sided (12 cm)	240
			Double sided (12 cm)	480
			Single sided (8 cm)	80
			Double sided (8 cm)	160
DVD-RW (V mode and finalized only)		AUDIO + VIDEO	12 cm (4.7GB)	480 (EX : Extended Play)
DVD-R (V mode and finalized only)		AUDIO + VIDEO	12 cm (4.7GB)	480 (EX : Extended Play)
AUDIO-CD		AUDIO	Single sided (12 cm)	74
			Single sided (8 cm)	20
DivX		DivX Movie	Single sided(12cm)	–
			Single sided(8cm)	–

Logos of Discs that can be played

				
Blu-ray Disc	Dolby Digital Plus	Digital Audio	DivX	BD-LIVE
				
Dolby TrueHD	pal broadcast system in u.k, france, germany, etc.	Stereo	Java	

Discs that cannot be played



- Blu-ray Discs with a region code other than "Region B".
- DVD-Video with a region number other than "2" or "ALL"
- HD DVD
- DVD-RAM
- 3.9 GB DVD-R Disc for Authoring.
- DVD-RW(VR mode)
- DVD-ROM/PD/MV-Disc, etc
- CVD/CD-ROM/CDV/CD-G/CD-I/LD

[Note]

- Some commercial discs and DVD discs purchased outside your region may not be playable with this product. When these discs are played, either “No disc.” or “Please check the regional code of the disc.” will be displayed.
- If a DVD-R/-RW disc has not been recorded properly in DVD video format, it will not be playable.
- The unit cannot play CD-RW/CD-R and DVD-RW/-R recorded content such as mpg, mov, wma, mp3,digital photo view(JPEG) file.
- It supports DivX playback from a disc only.

Region code

Both the Blu-ray Disc Player and the discs are coded by region. These regional codes must match in order to play the disc. If the codes do not match, the disc will not play. The Region Number for this Blu-ray Disc Player is described on the rear panel of the Blu-ray Disc Player.

Disc Type	Blu-ray	DVD-VIDEO
Region code		

Blu-ray Disc Region Code	Area
A	North America, Central America, South America, Korea, Japan, Taiwan, Hong Kong and South East Asia.
B	Europe, Greenland, French territories, Middle East, Africa, Australia and New Zealand.
C	India, China, Russia, Central and South Asia.

DVD Region Code	Area
1	The U.S., U.S. territories and Canada
2	Europe, Japan, the Middle East, Egypt, South Africa, Greenland
3	Taiwan, Korea, the Philippines, Indonesia, Hong Kong
4	Mexico, South America, Central America, Australia, New Zealand, Pacific Islands, Caribbean
5	Russia, Eastern Europe, India, most of Africa, North Korea, Mongolia
6	China

Blu-ray Disc Compatibility

Blu-ray Disc is a new and evolving format. Accordingly, disc compatibility issues are possible. Not all discs are compatible and not every disc will play back. For additional information, refer to the Compliance and Compatibility Notice section of this Manual. If you encounter compatibility problems, please contact the SAMSUNG customer care center.



- Playback may not work for some types of discs, or when specific operations, such as angle change and aspect ratio adjustment, are being performed. Information about the discs is written in detail on the disc box. Please refer to this if necessary.
- Do not allow the disc to become dirty or scratched. Fingerprints, dirt, dust, scratches or deposits of cigarette smoke on the recording surface may make it impossible to use the disc for playback.
- When a BD-J title is played, loading may take longer than a normal title, or some functions may perform slowly.

getting started

Disc Types

❖ **BD-ROM**

Blu-ray Disc Read Only Memory. A BD-ROM disc contains pre-recorded data. Although a BD-ROM may contain any form of data, most BD-ROM discs will contain movies in High Definition format, for playback on Blu-ray Disc Player's. This unit can play back pre-recorded commercial BD-ROM discs.

❖ **BD-RE/BD-R**

Blu-ray Disc Rewritable/Blu-ray Disc Recordable. BD-RE/BD-R is the ideal format for making backups, or recording personal video.

❖ **DVD-Video**

- A digital versatile disc (DVD) can contain up to 135-minutes of images, 8 audio languages and 32 subtitle languages. It is equipped with MPEG-2 picture compression and Dolby Digital surround, allowing you to enjoy vivid and clear theatre quality images.
- When switching from the first layer to the second layer of a dual-layered DVD Video disc, there may be momentary distortion in the image and sound. This is not a malfunction of the unit.
- Once a DVD-RW/-R recorded in Video Mode is finalized, it becomes DVD-Video. Pre-recorded (pre-stamped) commercial DVDs with movies are also referred to as DVD-Videos. This unit can play back pre-recorded commercial DVD discs (DVD-Video discs) with movies.

❖ **Audio CD**

- An audio disc on which 44.1kHz PCM Audio is recorded.
- This unit can play back CD-DA format audio CD-RW and CD-R discs.
- The unit may not be able to play some CD-RW or CD-R discs due to the condition of the recording.

❖ **CD-RW/CD-R**

- Use a 700MB(80 minutes) CD-RW/CD-R disc. If possible, do not use a 800MB(90 minutes) or above disc, as the disc may not play back.
- If the CD-RW/CD-R disc was not recorded as a closed session, you may experience delays when playing back the beginning of the disc or all recorded files may not play.
- Some CD-RW/CD-R discs may not be playable with this unit, depending on the device which was used to burn them. For contents recorded on CD-RW/CD-R media from CDs for your personal use,playability may vary depending on contents and discs.

❖ **DVD-R Disc Playback**

- Once a DVD-R recorded in Video Mode is finalized, it becomes DVD-Video.
- This unit can play back DVD-R discs recorded and finalized with a DVD video recorder. It may not be able to play some DVD-R discs depending on the disc and the condition of the recording.

❖ **DVD-RW Disc Playback**

- Playback can be performed with DVD-RW discs recorded in the Video Mode and finalized.
- Once a DVD-RW recorded in Video Mode is finalized, it becomes DVD-Video. Ability to play back may depend on recording conditions.

Disc Format

❖ **DVD-RW/-R (V)**

- This is a format that is used for recording data on a DVD-RW or DVD-R disc. The disc can be played by this Blu-ray Disc Player once it has been finalized.

❖ **DivX**

- CD-R/-RW, DVD-R
- Video File with following extensions can be played. : .avi, .divx, .AVI, .DIVX
- DivX Video (Codec) Format : DivX 3.11 DivX 4.x
DivX 5.x (without QPEL and GMC)
- DivX Audio (Codec) Format : MP3, MPEG1 Audio Layer 2, AC3, DTS
- Supported subtitle file formats: .smi, .srt, .sub, .psb, .txt, .ass
- You cannot play back the disc that is larger than a 720 x 576 pixel resolution.

❖ AVCHD (Advanced Video Codec High Definition)

- This player can playback AVCHD format discs. These discs are normally recorded and used in camcorders.
- The AVCHD format is a high definition digital video camera format.
- The MPEG-4 AVC/H.264 format is capable of compressing images at higher efficiency than that of the conventional image compressing format.
- Some AVCHD discs use the “x.v.Color” format.
- This player can playback AVCHD discs using “x.v.Color” format.
- “x.v.Color” is a trademark of Sony Corporation.
- “AVCHD” and the AVCHD logo are trademarks of Matsushita Electronic Industrial Co., Ltd. and Sony Corporation.



- Some AVCHD format discs may not play, depending on the recording condition. AVCHD format discs need to be finalized.
- “x.v.Color” offers a wider color range than normal DVD camcorder discs.

DISC STORAGE & MANAGEMENT

Disc Handling

❖ Disc Shape

- Use discs with regular shapes. If an irregular disc (a disc with a special shape) is used, this Blu-ray Disc Player may be damaged.

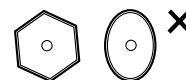

❖ Holding discs

- Avoid touching the surface of a disc where recording is performed.



❖ Blu-ray Discs

- If the player is not used for a long period of time, remove the Blu-ray Disc from the player and store it in its case.
- Be careful not to leave fingerprints or scratches on the surface of the Blu-ray Disc.

❖ DVD-RW and DVD-R

- Clean with an optional PD disc cleaner (LF-K200DCA1 where available). Do not use cleaners or cloths for CDs to clean DVD-RW/-R discs.

❖ DVD-Video, Audio-CD

- Wipe off dirt or contamination on the disc with a soft cloth.

❖ Cautions on handling discs

- Do not write on the printed side with a ball-point pen or pencil.
- Do not use record cleaning sprays or antistatic. Also, do not use volatile chemicals, such as benzene or thinner.
- Do not apply labels or stickers to discs. (Do not use discs fixed with exposed tape adhesive or leftover peeled-off stickers.)
- Do not use scratch-proof protectors or covers.
- Do not use discs printed with label printers available on the market.
- Do not load warped or cracked discs.



Disc Storage

Be careful not to damage the disc because the data on these discs is highly vulnerable to the environment.

- Do not keep under direct sunlight.
- Keep in a cool ventilated area.
- Store vertically.
- Keep in a clean protection jacket.
- If you move your Blu-ray Disc Player suddenly from a cold place to a warm place, condensation may generate on the operating parts and lens and cause abnormal disc playback. If this occurs, wait for two hours before connecting the plug to the power outlet. Then insert the disc and try to play back again.

description

FRONT PANEL

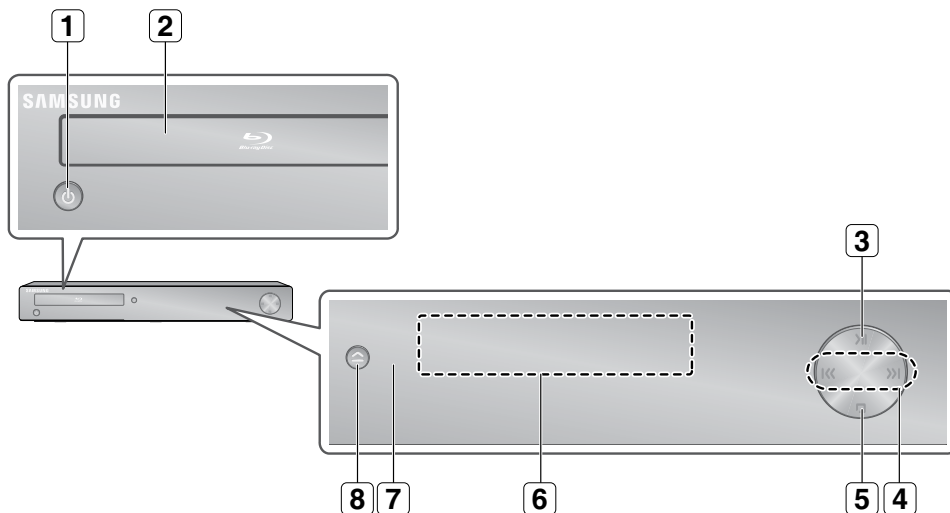

1	STANDBY/ON BUTTON	Turns the Blu-ray Disc Player on and off.
2	DISC TRAY	Opens to accept a disc.
3	PLAY/PAUSE BUTTON	Plays a disc or pauses playback.
4	SEARCH/SKIP BUTTONS	Goes to the next title/chapter/track or goes back to the previous title/chapter/track.
5	STOP BUTTON	Stops disc playback.
6	DISPLAY	Displays the playing status, time, etc.
7	REMOTE CONTROL SENSOR	Detects signals from the remote control.
8	OPEN/CLOSE BUTTON	Opens and closes the disc tray.

FRONT PANEL DISPLAY

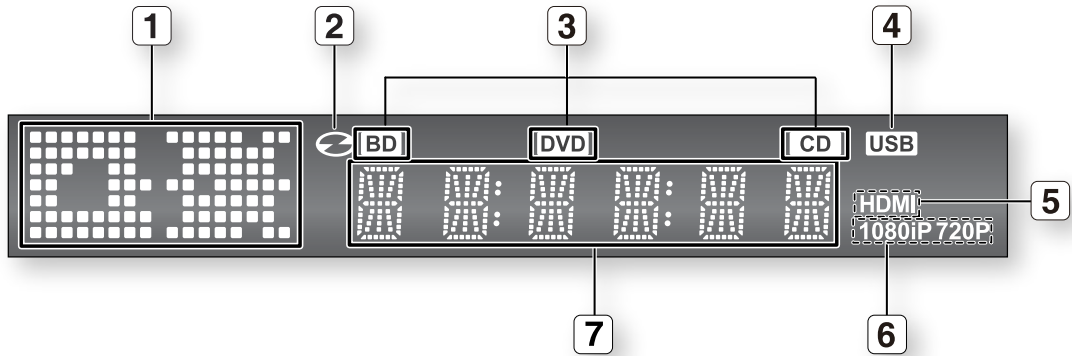

1	Playback-related, Open/Close indicator	Lights when playback-related and open/close buttons are selected.
2	In Disc Indicator	Lights when a disc is in the tray.
3	Disc Type indicators	Lights to indicate the disc type in the tray.
4	USB Indicator	Lights to indicate when USB is connected.
5	HDMI Indicator	Lights to indicate when HDMI is connected.
6	Resolution Indicator	Indicates the 1080p, 1080i or 720p resolution when HDMI or Component is connected.
7	STATUS Indicator	Playing time/current status indicator.

description

REAR PANEL

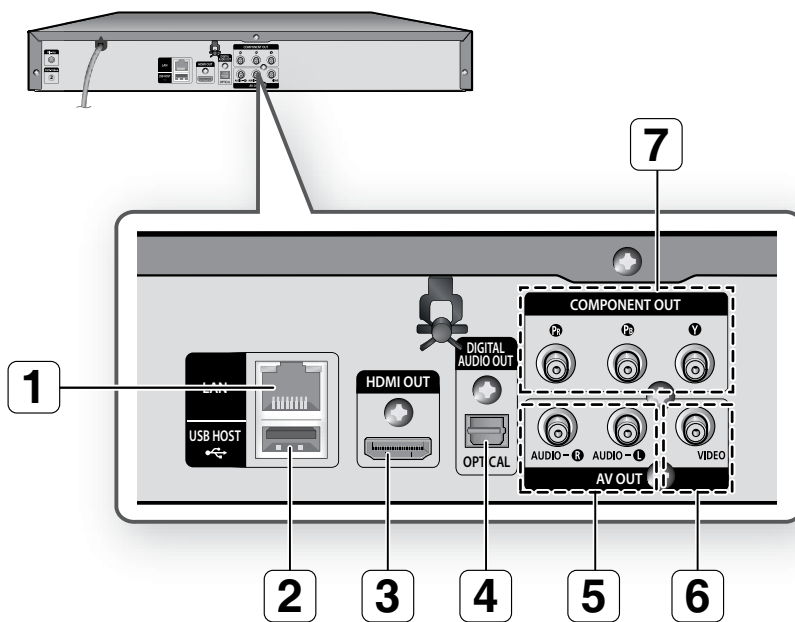

1	LAN	It can be also used for connection to BD-LIVE or firmware upgrade.
2	USB HOST	It can be used as local storage media when connected to BD-LIVE. And it can be also used for firmware upgrade.
3	HDMI OUT	Using a HDMI cable, connect this HDMI output terminal to the HDMI input terminal on your TV for the best quality picture and to your Receiver for the best quality sound.
4	DIGITAL AUDIO OUT (OPTICAL)	Connects to a Receiver.
5	AUDIO OUT	Connects to the audio input of external equipment using audio cables.
6	VIDEO OUT	Connects the input of external equipment using a video cable.
7	COMPONENT VIDEO OUT	Connects to equipment having Component video input.

- Software upgrades using the USB Host jack must be performed with a USB flash drive only.
- Oversized USB drives may not be able to be inserted when a LAN or HDMI cable is connected.

remote control

TOUR OF THE REMOTE CONTROL

Installing batteries in the Remote Control



1. Lift the cover at the back of the remote control upward as shown.



2. Install two AAA size batteries.
Make sure to match the "+" and "-" ends of the batteries with the diagram inside the compartment.

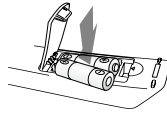

3. Replace the cover.
Assuming typical TV usage, the batteries last for about one year.

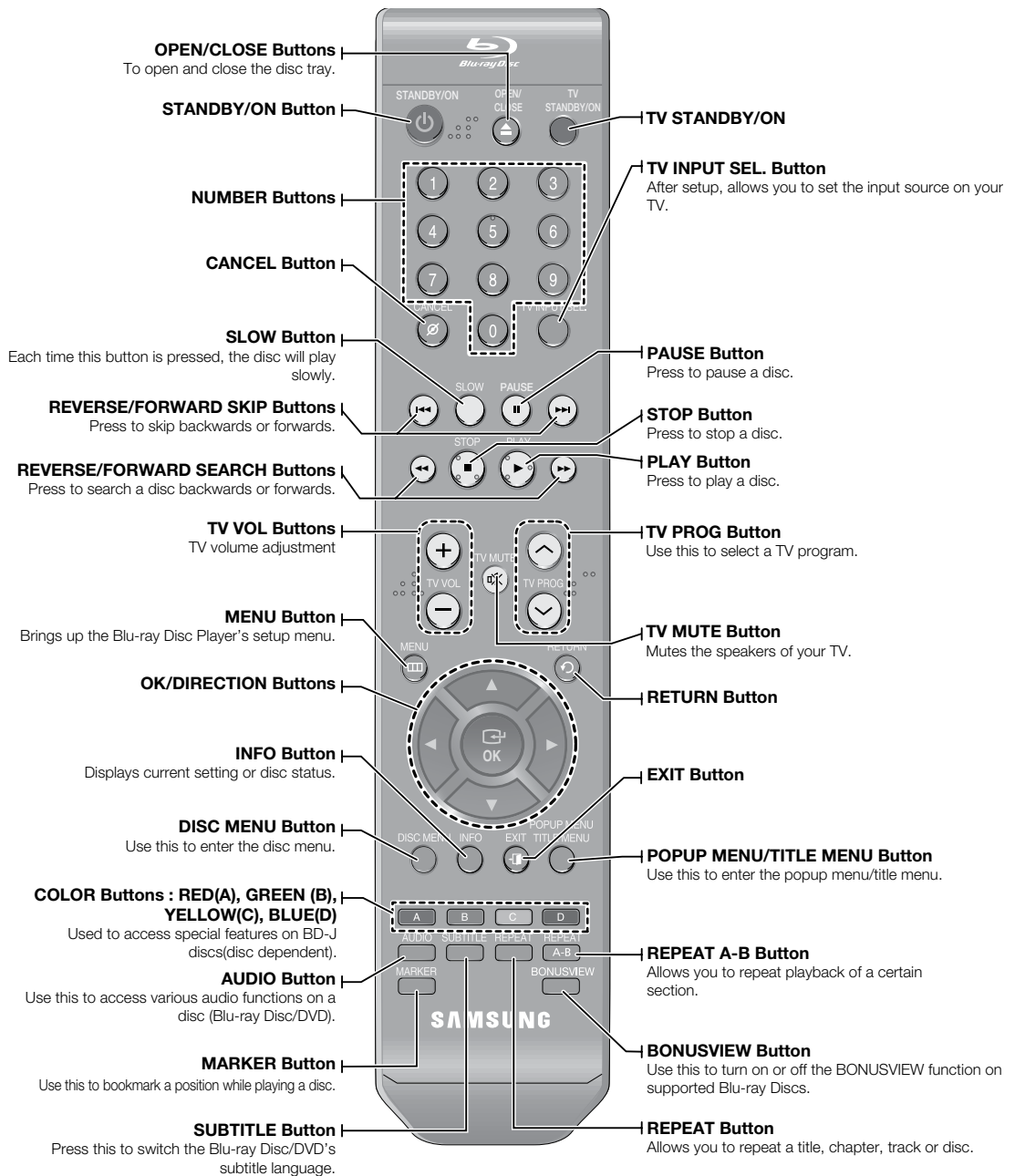

remote control

SETTING THE REMOTE CONTROL

You can control certain functions of your TV with this remote control.

Control function buttons include : **TV STANDBY/ON**, **TV PROG \wedge/\vee** , **TV VOL +/-**, **TV MUTE**, **TV INPUT SEL.** button.

To determine whether your television is compatible, follow the instructions below.

1. Switch your television on.
2. Point the remote control towards the television.
3. Press and hold the **TV STANDBY/ON** button and enter the two-figure code corresponding to the brand of your television, by pressing the appropriate number buttons. (see the next page for the code list).

If your television is compatible with the remote control, it will switch off.
It is now programmed to operate with the remote control.

- ✍ If several codes are indicated for your television brand, try each one in turn until you find one that works.
- ✍ If you replace the remote control's batteries, you must set the brand code again.

You can then control the television using the following buttons after pressing the TV button.

Button	Function
TV STANDBY/ON	Used to switch the television on and off.
TV INPUT SEL.	Used to select an external source.
TV VOL (+/-)	Used to adjust the volume of the television.
TV PROG (\wedge/\vee)	Used to select the desired channel.
TV MUTE	Used to toggle the sound on and off.

- ✍ The functions listed above will not necessarily work on all televisions. If you encounter problems, operate the television directly.

REGARDING THE BATTERY

If the remote does not operate properly:

- Check the polarity +/- of the batteries (Dry-Cell)
- Check if the batteries are drained.
- Check if remote sensor is blocked by obstacles.
- Check if there is any fluorescent lighting nearby.

Dispose of batteries according to local environmental regulations. Do not put them in the household trash.

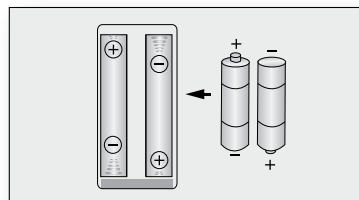

- ⚠ The rechargeable battery incorporated in this product is not user replaceable. For the information on its replacement, go to your service provider.

CONTROLLABLE TV CODES

Brand	Code
SAMSUNG	TV STANDBY/ON+01, +02, +03, +04, +05, +06, +07, +08, +09
AIWA	TV STANDBY/ON+82
ANAM	TV STANDBY/ON+10, +11, +12, +13, +14, +15, +16, +17, +18
BANG & OLUFSEN	TV STANDBY/ON+57
BLAUPUNKT	TV STANDBY/ON+71
BRANDT	TV STANDBY/ON+73
BRIONVEGA	TV STANDBY/ON+57
CGE	TV STANDBY/ON+52
CONTINENTAL EDISON	TV STANDBY/ON+75
DAEWOO	TV STANDBY/ON+19, +20, +23, +24, +25, +26, +27, +28, +29, +30, +31, +32, +33, +34
EMERSON	TV STANDBY/ON+64
FERGUSON	TV STANDBY/ON+73
FINLUX	TV STANDBY/ON+06, +49, +57
FORMENTI	TV STANDBY/ON+57
FUJITSU	TV STANDBY/ON+84
GRADIENTE	TV STANDBY/ON+70
GRUNDIG	TV STANDBY/ON+49, +52, +71
HITACHI	TV STANDBY/ON+60, +72, +73, +75
IMPERIAL	TV STANDBY/ON+52
JVC	TV STANDBY/ON+61, +79
LG	TV STANDBY/ON+06, +19, +20, +21, +22, +78
LOEWE	TV STANDBY/ON+06, +69
LOEWE OPTA	TV STANDBY/ON+06, +57
MAGNAVOX	TV STANDBY/ON+40
METZ	TV STANDBY/ON+57
MITSUBISHI	TV STANDBY/ON+06, +48, +62, +65
MIVAR	TV STANDBY/ON+52, +77
NEC	TV STANDBY/ON+83
NEWSAN	TV STANDBY/ON+68
NOBLEX	TV STANDBY/ON+66
NOKIA	TV STANDBY/ON+74
NORDMENDE	TV STANDBY/ON+72, +73, +75
PANASONIC	TV STANDBY/ON+53, +54, +74, +75
PHILIPS	TV STANDBY/ON+06, +55, +56, +57
PHONOLA	TV STANDBY/ON+06, +56, +57
PIONEER	TV STANDBY/ON+58, +59, +73, +74
RADIOLA	TV STANDBY/ON+06, +56
RADIOMARELLI	TV STANDBY/ON+57
RCA	TV STANDBY/ON+45, +46
REX	TV STANDBY/ON+74
SABA	TV STANDBY/ON+57, +72, +73, +74, +75
SALORA	TV STANDBY/ON+74
SANYO	TV STANDBY/ON+41, +42, +43, +44, +48
SCHNEIDER	TV STANDBY/ON+06
SELECO	TV STANDBY/ON+74
SHARP	TV STANDBY/ON+36, +37, +38, +39, +48
SIEMENS	TV STANDBY/ON+71
SINGER	TV STANDBY/ON+57
SINUDYNE	TV STANDBY/ON+57
SONY	TV STANDBY/ON+35, +48
TELEAVA	TV STANDBY/ON+73
TELEFUNKEN	TV STANDBY/ON+67, +73, +75, +76
THOMSON	TV STANDBY/ON+72, +73, +75
THOMSON ASIA	TV STANDBY/ON+80, +81
TOSHIBA	TV STANDBY/ON+47, +48, +49, +50, +51, +52
WEGA	TV STANDBY/ON+57
YOKO	TV STANDBY/ON+06
ZENITH	TV STANDBY/ON+63

connections

This section involves various methods of connecting the Blu-ray Disc Player to other external components such as a TV.

CONNECTING TO A TV WITH AN HDMI CABLE (BEST QUALITY)

1. Using an HDMI-HDMI cable (not included) connect the **HDMI OUT** terminal on the rear of the Blu-ray Disc Player to the **HDMI IN** terminal of your TV.
2. Press the input selector on your TV remote control until the HDMI signal from the Blu-ray Disc Player appears on your TV screen.
 - If you have set the remote control to operate your TV (see pages 18-19), press the **TV INPUT SEL.** button on the remote control and select HDMI as the external source of the TV.

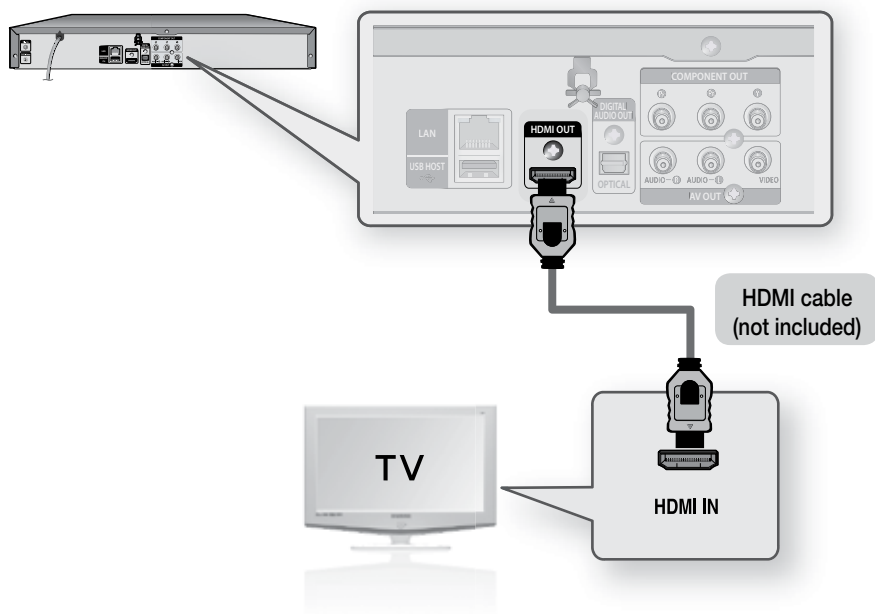

-
- If the HDMI cable is connected or removed during playback of a CDDA, the player will stop playing.
 - If the player is connected to your TV in HDMI 1080p output mode, you must use a High speed(category2) HDMI cable.

HDMI AUTO DETECTION FUNCTION

The player's video output will automatically change to HDMI output resolution when connecting an HDMI cable while power is on (see page 39).



- Depending on your TV, certain HDMI output resolutions may not work. Please refer to the user's manual of your TV.
- If an HDMI cable is connected from the player to a TV, the Blu-ray Disc Player's output is set to HDMI output resolution automatically within 10 seconds.
- If Component and HDMI are both connected, HDMI mode is automatically selected. (See page 39)
- When you connect the player to the TV using the HDMI cable for the first time or to a new TV, the HDMI output resolution will be automatically set to the highest provided by the TV.
- If you connect a Samsung TV to the Blu-ray Disc Player using an HDMI cable, the player can be easily operated using the TV remote control. (This is only available with Samsung TVs that support the Anynet+ feature.) (See pages 40~41)

• HDMI (High Definition Multimedia Interface)

HDMI is an interface that enables the digital transmission of video and audio data with just a single connector.

Using HDMI, the Blu-ray Disc Player transmits a digital video and audio signal and displays a vivid picture on a TV having an HDMI input jack.

• HDMI connection description

HDMI connector - Supports video and digital audio data (LPCM or Bitstream).

- HDMI outputs only a pure digital signal to the TV.
- If your TV does not support HDCP (High-bandwidth Digital Content Protection), random noise appears on the screen.

• Why does Samsung use HDMI?

Analog TVs require an analog video/audio signal. However, when playing a Blu-ray Disc/DVD, the data transmitted to a TV is digital. Therefore either a digital-to-analog converter (in the Blu-ray Disc Player) or an analog-to-digital converter (in the TV) is required. During this conversion, the picture quality is degraded due to noise and signal loss. HDMI technology is superior because it requires no D/A conversion and is a pure digital signal from the player to your TV.

• What is the HDCP?

HDCP (High-band width Digital Content Protection) is a system for protecting Blu-ray Disc/DVD content outputted via HDMI from being copied. It provides a secure digital link between a video source (PC, DVD, etc) and a display device (TV, projector, etc). Content is encrypted at the source device to prevent unauthorized copies from being made.

• What is Anynet+?

Anynet+ is a convenient function that offers linked operation of this unit through Samsung TVs with the Anynet+ feature.

- If your Samsung TV has an **Anynet+** logo, then it supports the Anynet+ function.
- If you turn on the player and insert a disc, the player will start playing the disc, and the TV will turn on automatically and switch to HDMI mode.
- If you turn on the player and press the Play button with a disc already inserted, the TV will immediately turn on and switch to HDMI mode.

connections

CONNECTING TO A TV WITH DVI CABLE (BEST QUALITY)

1. Using the HDMI-DVI cable (not included), connect the **HDMI OUT** terminal on the rear of the Blu-ray Disc Player to the **DVI IN** terminal of your TV.
2. Using the audio cables, connect the **AUDIO (red and white) OUT** terminals on the rear of the Blu-ray Disc Player to the **AUDIO (red and white) IN** terminals of your TV.
Turn on the Blu-ray Disc Player and TV.
3. Press the input selector on your TV remote control until the DVI signal from the Blu-ray Disc Player appears on your TV screen.
 - If you have set the remote control to operate your TV (see pages 18~19), press the **TV INPUT SEL.** button on the remote control and select HDMI as the external source of the TV.

Connecting the HDMI cable while the Blu-ray Disc Player's power is on will result in the player's video output being changed to HDMI mode automatically (see page 39).



- Depending on your TV, certain HDMI output resolutions may not work. Please refer to the user's manual of your TV.
- If an HDMI-DVI cable is plugged into the TV, the Blu-ray Disc Player's output resolution is set to HDMI automatically within 10 seconds.
- If Component and HDMI are both connected, HDMI mode is automatically selected. (See page 39)
- When you connect the player to the TV using the HDMI cable for the first time or to a new TV, the HDMI output resolution will be automatically set to the highest provided by the TV
- If the HDMI cable is connected or removed during playback of a CDDA, the player will stop playing.

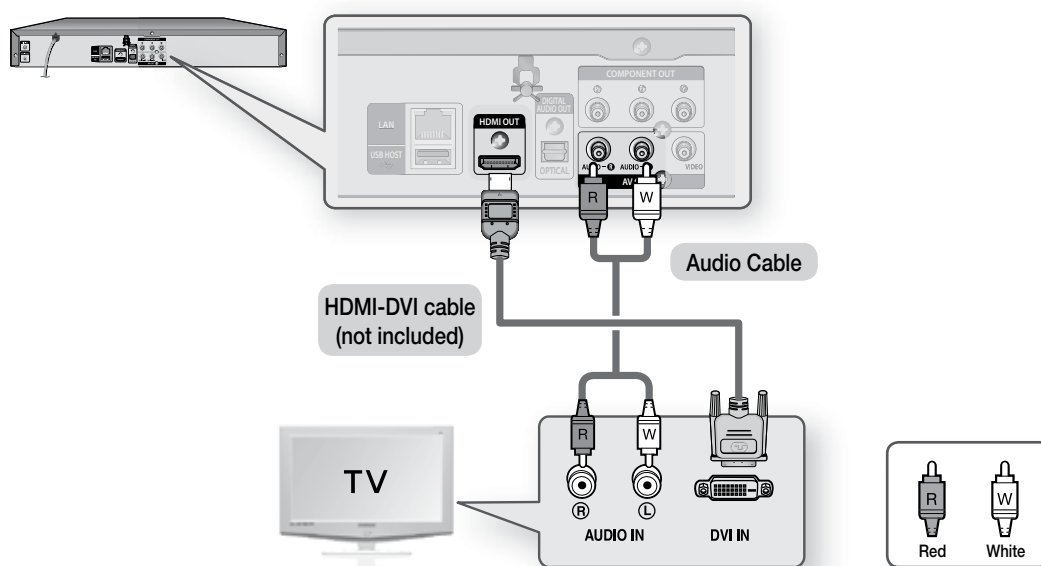

CONNECTING TO A TV (COMPONENT) (BETTER QUALITY)

- Connecting to your TV using Component video cables.
 - You will enjoy high quality images with accurate color reproduction. Component video separates the picture element into black and white(Y), blue(Pb), red(Pr) signals to present clear and clean images. (Audio signals are delivered through the audio output.)
1. Using Component video cables (not included) , connect the **COMPONENT VIDEO OUT** terminals on the rear of the Blu-ray Disc Player to the **COMPONENT IN** terminals of your TV.
 2. Using the audio cables, connect the **AUDIO (red and white) OUT** terminals on the rear of the Blu-ray Disc Player to the **AUDIO (red and white) IN** terminals of your TV. Turn on the Blu-ray Disc Player and TV.
 3. Press the input selector on your TV remote control until the Component signal from the Blu-ray Disc Player appears on the TV screen.
 - If you have set the remote control to operate your TV (see pages 18~19), press the **TV INPUT SEL.** button on the remote control and select COMPONENT as the external source of the TV.

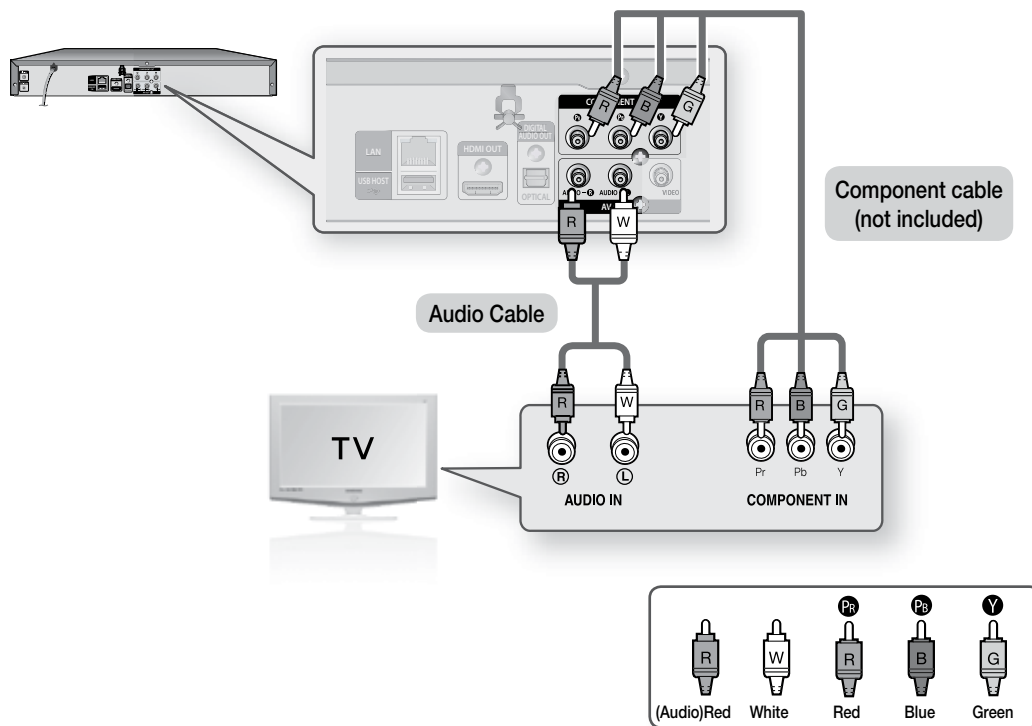

- ✍️ Depending on the manufacturer, the component terminals on your TV may be marked "R-Y, B-Y, Y" or "Cr, Cb, Y" instead of "Pr, Pb, Y". The number and position of terminals may vary depending on the TV set. Please refer to the user's manual of your TV.
- You can select from a variety of resolution settings for Blu-ray Discs such as 1080i, 720p, 576p/480p and 576i/480i, depending on the disc type. (See page 39)
- The actual resolution may differ from the setting in the SETUP menu if both Component and HDMI cables are connected. The resolution may also be different depending on the disc. (See page 39)
- In DVD playback, if both HDMI and Component jacks are connected and you select the Component mode, the Display Setup menu will show the output resolution as 1080p. The resolution is actually 576i/480i.

connections

CONNECTING TO A TV (VIDEO) (GOOD QUALITY)

1. Using video/audio cables, connect the **VIDEO (yellow) / AUDIO (red and white) OUT** terminals on the rear of the Blu-ray Disc Player to the **VIDEO (yellow) / AUDIO (red and white) IN** terminals of your TV.
2. Turn on the Blu-ray Disc Player and TV.
3. Press the input selector on your TV remote control until the Video signal from the Blu-ray Disc Player appears on the TV screen.
 - If you have set the remote control to operate your TV (see pages 18~19), press the **TV INPUT SEL.** button on the remote control and select VIDEO as the external source of the TV.

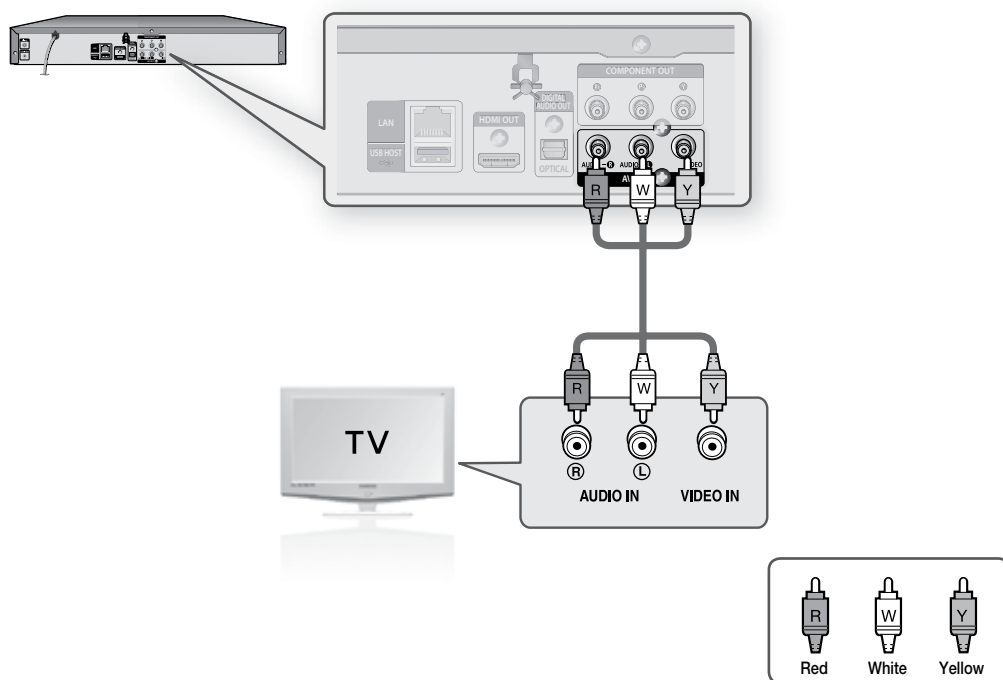

- Noise may be generated if the audio cable is placed too close to the power cable.
- If you want to connect to an Amplifier, please refer to the Amplifier connection pages. (See pages 25~27)
- The number and position of terminals may vary depending on your TV set. Please refer to the user's manual of your TV.
- If there is only one audio input terminal on the TV, connect it to the [AUDIO OUT][left] (white) terminal of the Blu-ray Disc Player.
- The VIDEO source is always output in 576i/480i resolution regardless of the resolution set in the SETUP menu. (See page 39)

CONNECTING TO AN AUDIO SYSTEM (2 CHANNEL AMPLIFIER)

1. Using the audio cables, connect the **AUDIO (red and white) OUT** terminals on the rear of the Blu-ray Disc Player to the **AUDIO (red and white) IN** terminals of your Amplifier.
2. Using the video signal cable(s), connect the **HDMI, COMPONENT** or **VIDEO OUT** terminals on the rear of the Blu-ray Disc Player to the **HDMI, COMPONENT** or **VIDEO IN** terminal of your TV as described on pages 20 to 24.
3. Turn on the Blu-ray Disc Player, TV and Amplifier.
4. Press the input select button of the Amplifier to select the **external input** in order to hear sound from the Blu-ray Disc Player. Refer to your Amplifier's user manual to set the Amplifier's audio input.

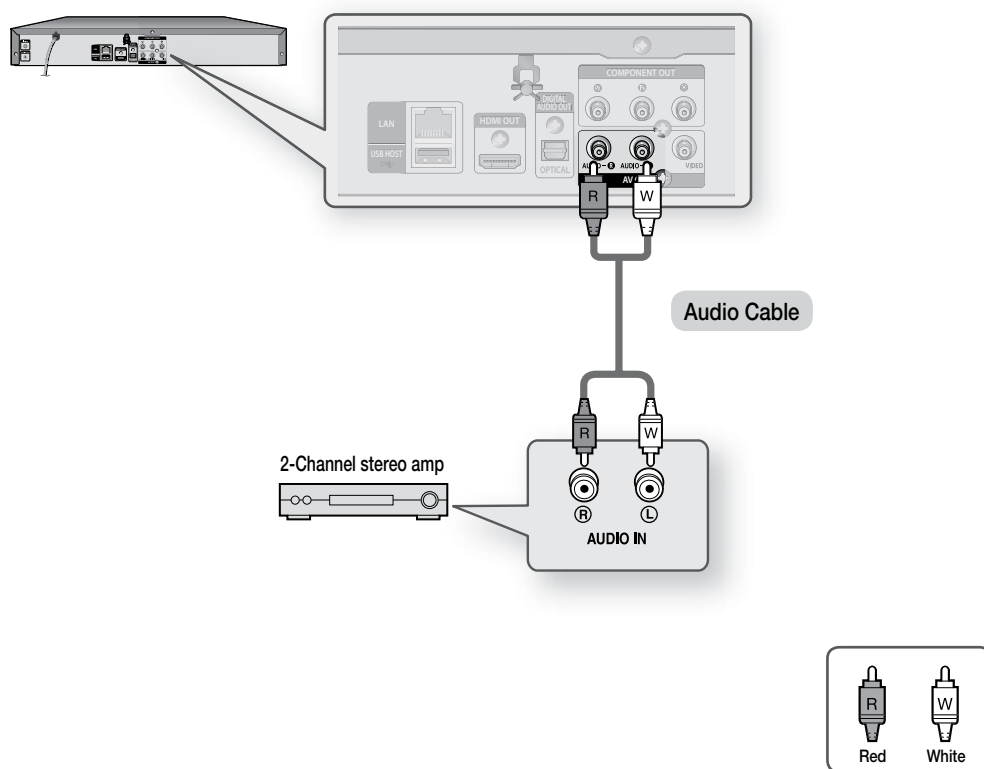

- Manufactured under license from Dolby Laboratories. "Dolby" and the double-D symbol are trademarks of Dolby Laboratories.
- Manufactured under license under U.S. Patent #: 5,451,942; 5,956,674; 5,974,380; 5,978,762; 6,487,535 & other U.S. and worldwide patents issued & pending. DTS is a registered trademark and the DTS logos, Symbol, DTS-HD and DTS-HD Advanced Digital Out are trademarks of DTS, Inc. © 1996-2007 DTS, Inc. All Rights Reserved.

connections

CONNECTING TO AN AUDIO SYSTEM (DOLBY DIGITAL, DTS AMPLIFIER)

1. Using the optical cable (not included), connect the **DIGITAL AUDIO OUT (OPTICAL)** terminal on the rear of the Blu-ray Disc Player to the **DIGITAL AUDIO IN (OPTICAL)** terminal of your Amplifier.
2. Using the video signal cable(s), connect the **HDMI** , **COMPONENT** or **VIDEO OUT** terminals on the rear of the Blu-ray Disc Player to the **HDMI**, **COMPONENT** or **VIDEO IN** terminals of your TV as described on pages 20 to 24.
3. Turn on the Blu-ray Disc Player, TV, and Amplifier.
4. Press the input select button of the Amplifier to select the **external input** in order to hear sound from the Blu-ray Disc Player. Refer to your Amplifier's user manual to set the Amplifier's audio input.

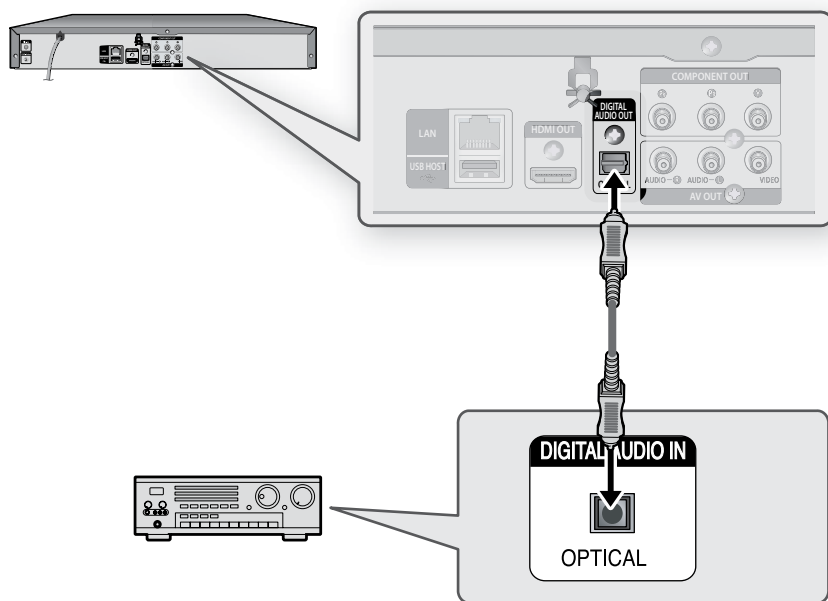

- Please turn the volume down when you turn on the Amplifier. Sudden loud sound may cause damage to the speakers and your ears.
- Please set the audio in the menu screen according to the Amplifier. (See pages 35–36)
- The position of terminals may vary depending on the Amplifier. Please refer to the user's manual of your Amplifier.
- When using this connection, discs with LPCM audio soundtracks will only be heard over the front two channels.

CONNECTING TO AN AUDIO SYSTEM (HDMI SUPPORTED AMPLIFIER)

1. Using the HDMI-HDMI cable (not included), connect the **HDMI OUT** terminal on the rear of the Blu-ray Disc Player to the **HDMI IN** terminal of your Amplifier.
2. Using the HDMI-HDMI cable, connect the **HDMI OUT** terminal of the Amplifier to the **HDMI IN** terminal of your TV.
3. Turn on the Blu-ray Disc Player, TV, and Amplifier.
4. Press the input select button of the Amplifier to select **external input** in order to hear sound from the Blu-ray Disc Player. Refer to your Amplifier's user manual to set the Amplifier's audio input.

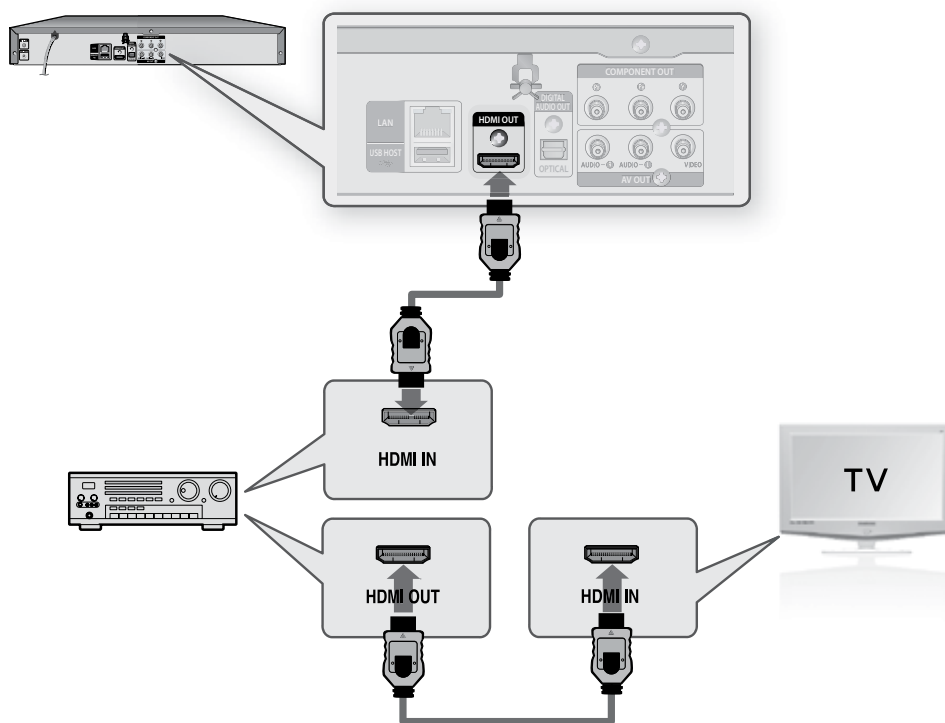

- Please turn the volume down when you turn on the Amplifier. Sudden loud sound may cause damage to the speakers and your ears.
- Please set the audio in the menu screen according to the Amplifier. (See pages 35~36)
- The position of HDMI terminals may vary depending on the Amplifier. Please refer to the user's manual of your Amplifier.

connections

CONNECTING TO THE NETWORK

You can use a LAN adaptor to connect to BD-LIVE or upgrade the current firmware.

1. Using the Direct LAN Cable (UTP cable, not included), connect the LAN terminal on the rear of the Blu-ray Disc Player to the LAN terminal of your modem.
 - Connect to access the BD-LIVE service.
 - Connect for software upgrades from Samsung's update server.

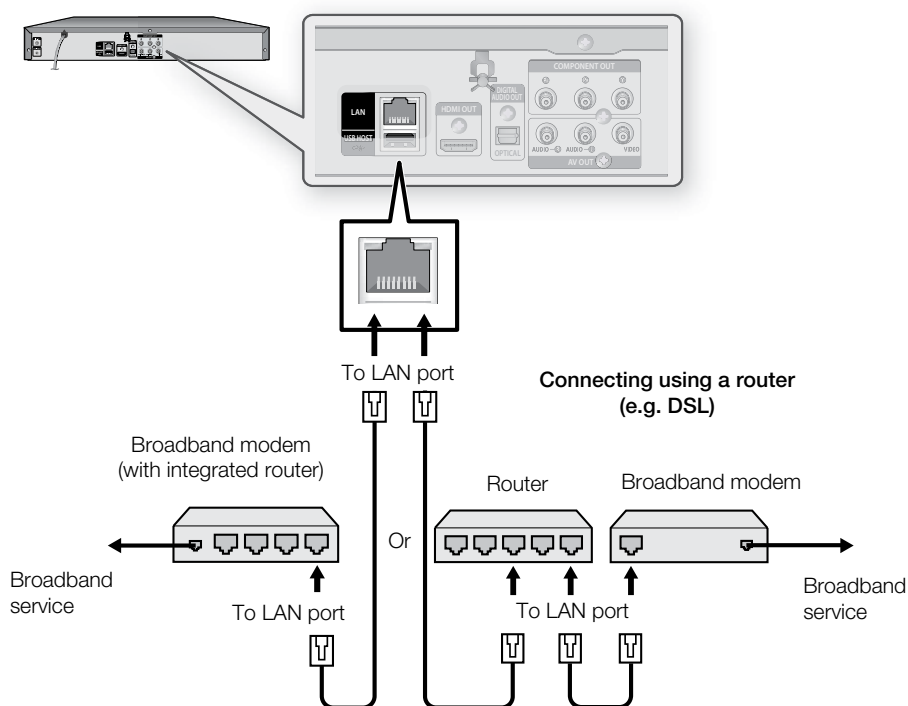

- Internet access to Samsung's update server may not be allowed, depending on the router you use or the ISP's policy. For more information, contact your ISP (Internet Service Provider).
- For DSL users, please use a router to make a network connection.

basic functions of your Blu-ray Disc Player

This section introduces basic playback functions and playback by disc type.

BEFORE PLAYING

- Turn on your TV and set it to the correct Video Input (the input the Blu-ray Disc Player is connected to).
- If you connected an external Audio System, turn on your Audio System and set it to the correct Audio Input.

After plugging in the player, the first time you press the **STANDBY/ON** button, this screen comes up:

If you want to select a language, press a **NUMBER** button. (This screen will only appear when you plug in the player for the first time.) If the language for the startup screen is not set, the settings may change whenever you turn the power on or off. Therefore, make sure that you select the language you want to use. Once you select a menu language, you can change it by pressing the **▶▶** button on the front panel of the unit for more than 5 seconds with no disc in the unit. Then the MENU LANGUAGE SELECTION window appears again where you can reset your preferred language.

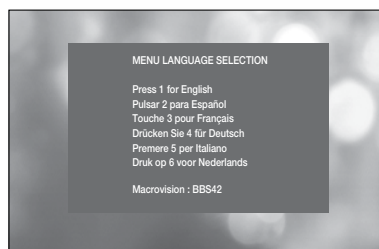

- Discs which can be played on this player (For the following discs, the ability to play back may depend on recording conditions.)
 - BD-ROM
 - BD-RE
 - BD-R
 - DVD-R
 - DVD-RW (V mode)
 - CD-RW/CD-R
 - DivX
 - The unit may not play certain CD-RW/CD-R and DVD-R due to the disc type or recording conditions.
- Discs which cannot be played on this player.
 - HD DVD
 - DVD+RW
 - DVD+R
 - DVD-ROM
 - DVD-RAM
 - CDV
 - CD-ROM
 - CVD
 - CD-I
 - Super Audio CD(except CD layer)
 - CDGs play audio only, not graphics.
- Blu-ray is a new and evolving format. Accordingly, disc compatibility issues with new and existing format discs are possible. Not all discs are compatible and not every disc will playback. For additional information, refer to the Disc Type and Characteristics and Compliance and Compatibility Notice sections of this Manual. If you encounter compatibility problems, please contact SAMSUNG customer care center.
- The unit cannot play CD-RW/CD-R and DVD-RW/-R with recorded content such as mpg, mov, wma, mp3, digital photo view(JPEG) file.

basic functions of your Blu-ray Disc Player

ON-SCREEN MENU NAVIGATION

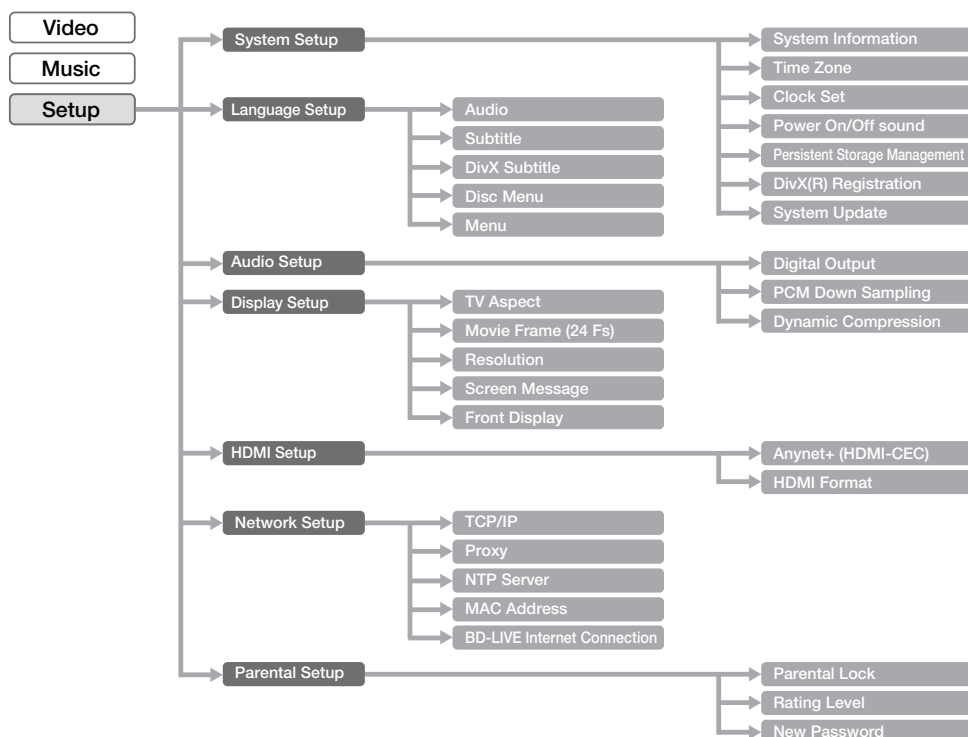

PLAYING A DISC

1. Press the **OPEN/CLOSE** (⏏) button.
The STANDBY indicator light goes out and the tray opens.
2. Place a disc gently into the tray with the disc's label facing up.
3. Press the **PLAY** (▶) button or **OPEN/CLOSE** (⏏) button to close the disc tray.



- When you stop disc play, the player remembers where you stopped, so when you press **PLAY** (▶) button again, it will pick up where you left off.
In some BD discs(BD-J), this function can be prohibited.
- Press the **STOP** (⏏) button twice during playback to disable the Resume function.
- To pause the playback, press the **PAUSE** (⏏) button during playback.
To resume, press the **PLAY** (▶) button.
- If the player is left in the stop mode more than 5 minutes without any user interface, a screen saver will appear on your TV. If the player is left in the screen saver mode for more than 30 minutes, the power will automatically turn off except during playback of an CDDA (Automatic Power-Off Function).
- If no input is entered for more than 5 minutes in pause mode, the operation will stop (except for some Blu-ray discs).

SETTING THE POWER ON / OFF MELODY SOUND

When you turn the player on or off, a melody sound is produced.

1. With the unit in Stop mode, press the **MENU** button.
2. Press the **▲▼** buttons to select **Setup**, then press the **OK** or **▶** button.
3. Press the **▲▼** buttons to select **System Setup**, then press the **OK** or **▶** button.
4. Press the **▲▼** buttons to select **Power On/Off sound**, then press the **OK** or **▶** button.
5. Press the **▲▼** buttons to select **Off** or **On**, then press the **OK** or **▶** button.
6. Press the **MENU** button to exit the setup menu.

USING THE SEARCH AND SKIP FUNCTIONS

During play, you can search quickly through a chapter or track, and use the skip function to jump to the next selection.

Searching through a Chapter or Track



During playback, press the **SEARCH** (**◀▶**) button.

Blu-ray, DVD-Video	▶▶ X 2 → ▶▶ X 4 → ▶▶ X 8 →▶▶ X 16 →▶▶ X 32 →▶▶ X 128
DivX	▶▶ X 2 → ▶▶ X 4 →▶▶ X 8
AUDIO CD (CD-DA)	▶▶ X 2 →▶▶ X 4 →▶▶ X 8

- To return to normal speed playback, press the **PLAY** (**▶**) button.



- No sound is heard during search mode.

Skipping Tracks



During playback, press the **SKIP** (**⏮ ⏭**) button.

When playing a Blu-ray Disc/DVD, if you press the **SKIP** (**⏮**) button, it moves to the next chapter. If you press the **SKIP** (**⏭**) button, it moves to the beginning of the chapter. One more press makes it move to the beginning of the previous chapter.

basic functions of your Blu-ray Disc Player

SLOW MOTION PLAY/STEP MOTION PLAY

Slow Motion Play



During playback, press the **SLOW** button on the remote control.

- If you press the **SLOW** button, the playback speed is reduced to
▶ 1/8 ▶ 1/4 ▶ 1/2
- To return to normal speed playback, press the **PLAY** (▶) button.



- This (⊘) icon indicates an invalid button press.
- No sound is heard during slow mode.
- Slow motion operates only in the forward direction.

Step Motion Play



In pause mode, press the **PAUSE** (⏸) button.

- Each time the **PAUSE** (⏸) button is pressed a new frame will appear.
- To return to normal speed playback, press the **PLAY** (▶) button.



- No sound is heard during step mode.
- Step motion operates only in the forward direction.

system setup

For your convenience, you can set this player's features for the best use in your home environment.

SETTING THE CLOCK

Choose your time zone

1. With the unit in Stop mode, press the **MENU** button.
2. Press the **▲▼** buttons to select **Setup**, then press the **OK** or **▶** button.
3. Press the **▲▼** buttons to select **System Setup**, then press the **OK** or **▶** button.
4. Press the **▲▼** buttons to select **Time Zone**, then press the **OK** or **▶** button.
5. Use the **◀▶** button to place the cursor to the appropriate time zone for your area and press the **OK** button.

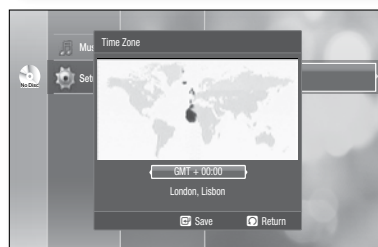
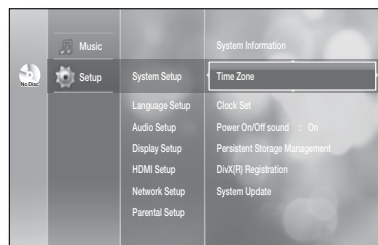

- To set the time automatically, set the NTP server to **On** (see page 45).

Set the clock

To setup, follow steps 1 through 3 above.

4. Press the **▲▼** buttons to select **Clock Set**, then press the **OK** or **▶** button.
5. Press the **◀▶** buttons to move to “**da.**” (date), “**hr**” (hour) and “**min**” (minute). Set the date and time by pressing the **▲▼** buttons, then press the **OK** button.

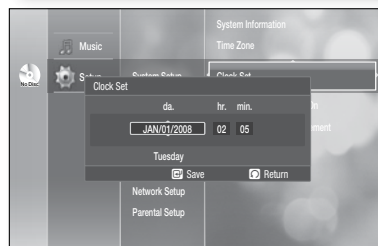
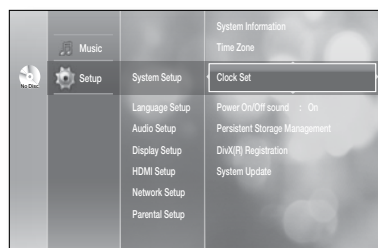

language setup

SETTING UP THE LANGUAGE OPTIONS

Once you set the audio, subtitle, disc menu and player menu language options, they will be applied automatically every time you watch a movie.

- ✍ If you want to choose a different audio and subtitle language while playing a disc, you can also use the disc menu to make the selection.

1. With the unit in Stop mode, press the **MENU** button.
2. Press the **▲▼** buttons to select **Setup**, then press the **OK** or **▶** button.

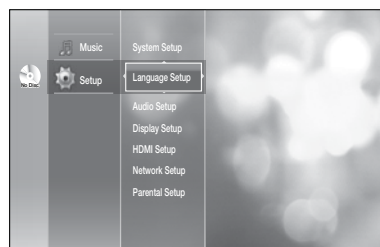

3. Press the **▲▼** buttons to select **Language Setup**, then press the **OK** or **▶** button. Language setup menu will be displayed.

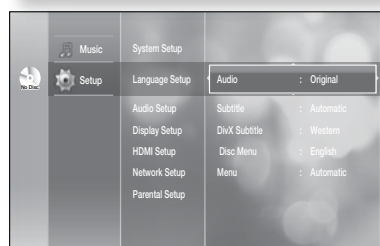

4. Press the **▲▼** buttons to select the desired language option, press the **OK** or **▶** button.
 - **Audio** : For the disc audio language.
 - **Subtitle** : For the disc subtitles.
 - **DivX Subtitle** : For the DivX subtitles.
 - **Disc Menu**: For the disc menu contained on the disc
 - **Menu**: For the on-screen menu of your Blu-ray Disc Player.

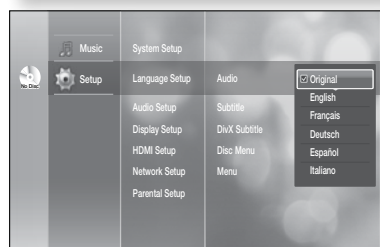

5. Press the **▲▼** buttons to select the desired language, then press the **OK** button.

- ✍ Press the **RETURN** or **◀** button to return to the previous menu. Press the **MENU** button to exit the menu.
 - The selected language will only appear if it is supported on the disc.
 - If the subtitle language is displayed in broken fonts, change DivX Subtitle to the appropriate region. If it still does not work, the format is not supported.

audio setup

SETTING UP THE AUDIO OPTIONS

Allows you to set up the Audio device and sound status depending on the audio system being used with the player.

1. With the unit in Stop mode, press the **MENU** button.
2. Press the **▲▼** buttons to select **Setup**, then press the **OK** or **▶** button.
3. Press the **▲▼** buttons to select **Audio Setup**, then press the **OK** or **▶** button.
4. Press the **▲▼** buttons to select the desired audio option from the options described below, then press the **OK** or **▶** button.
5. Press the **▲▼** buttons to select the desired item, then press the **OK** button.
6. Each audio option is described in detail below.

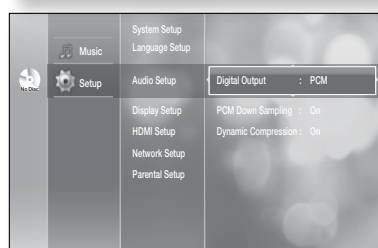
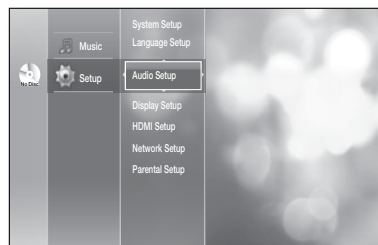

- Press the **RETURN** or **◀** button to return to the previous menu. Press the **MENU** button to exit the menu.

Digital Output

Blu-ray Discs may include three audio streams.

- Primary Audio : Main audio soundtrack of the disc
- Secondary Audio : Provides audio for the BONUSVIEW window of a Blu-ray Disc.
- Effect Audio : You may hear menu prompt sounds (etc.) when selecting menu items (depending on the disc), on a Blu-ray Disc.

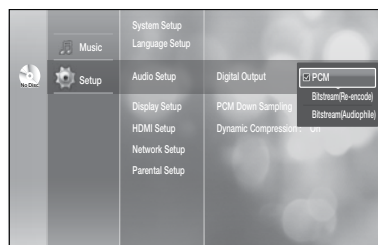

Digital Output Selections

Setup	Definition	Pro	Con	Recommended use
PCM	Decodes Primary, Secondary and Effect audio streams together into PCM audio.	You can enjoy Primary, Secondary and Effect audio together. You can also enjoy Dolby TrueHD sound even if your receiver cannot decode Dolby TrueHD.	You cannot hear DTS-HD Master Audio sound with this setting even if you have an HDMI 1.3 receiver which has DTS-HD Master Audio decoding capability.	Recommended choice if you have an HDMI 1.1 or HDMI 1.2 receiver which cannot decode DTS-HD Master Audio. Also recommended if you are using an optical cable for audio and your receiver cannot decode Dolby Digital or DTS.
Bitstream (Re-encode)	Decodes Primary, Secondary and Effect audio streams together into PCM audio, then re-encodes the PCM audio into DTS bitstream.	You can enjoy Primary, Secondary and Effect audio together.	Audio quality may be lower than PCM or Bitstream (Audiophile) setups.	Recommended choice if you don't have an HDMI supported receiver, but have a receiver with an Optical input that can decode DTS.
Bitstream (Audiophile)	Outputs only the Primary audio soundtrack (main soundtrack of the movie) so that your receiver can decode the audio bitstream.	You can enjoy DTS-HD Master Audio sound if you have HDMI 1.3 receiver which has DTS-HD Master Audio decoding capability.	You will not hear Secondary and Effect audio.	Recommended choice if you have an HDMI 1.3 receiver which has DTS-HD Master Audio decoding capability.

audio setup



- If you have selected a LPCM soundtrack on a disc, the output will automatically be set to PCM.
- Be sure to select the correct Digital Output or you will hear no sound or a loud noise.
- If the HDMI device (Receiver, TV) is not compatible with compressed formats (Dolby digital, DTS), the audio signal outputs as PCM.
- Secondary and Effect audio will not be heard with regular DVDs.
- Some Blu-ray Discs do not have Secondary and Effect audio.
- This Digital Output setup does not effect the analog (L/R) audio or HDMI audio output to your TV. It effects the optical and HDMI audio output when connected to a receiver.
- When the player outputs HD audio bitstream(Dolby TrueHD or DTS-HD Master Audio) from the Optical jack to an HDMI 1.3 receiver, only 2 channel PCM audio will be heard.
- If you play MPEG audio soundtracks, audio signal outputs PCM regardless of Digital Ouput Selections(PCM or Bitstream).

PCM Down Sampling

- **On** : Select this when the Amplifier connected to the player is not 96KHz compatible. 96KHz signals will be down converted to 48KHz
- **Off** : Select this when the Amplifier connected to the player is 96KHz compatible. Signals will be output without any changes.

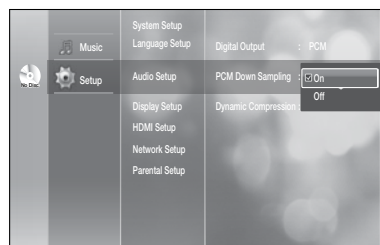

- Even when PCM Down Sampling is set to Off, some discs will only output downsampled audio through the optical digital outputs.

HDMI

- If your TV is not compatible with compressed multi-channel formats (Dolby Digital, DTS), the unit may output PCM 2ch downmixed audio even though you set Bitstream(either Re-encode or Audiophile) on your setup menu.
- If your TV is not compatible with PCM sampling rates over 48kHz, the unit may output 48kHz downsampled PCM audio even though you set "PCM Down Sampling" as "Off".

Dynamic Compression

This is only active when a Dolby Digital signal is detected.

- **Off** : You can enjoy the movie with the standard Dynamic Range.
- **On** : When Movie soundtracks are played at low volume or from smaller speakers, the system can apply appropriate compression to make low-level content more intelligible and prevent dramatic passages from getting too loud.

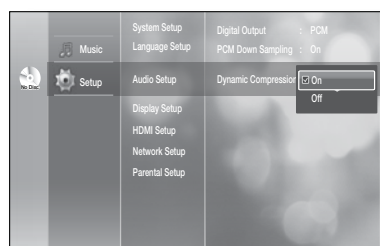

display setup

SETTING UP THE DISPLAY OPTIONS

This function allows you to setup the TV screen settings. This function depends on the disc or TV type. It may not work with some discs or TVs.

1. With the unit in Stop mode, press the **MENU** button.
2. Press the **▲▼** buttons to select **Setup**, then press the **OK** or **▶** button.
3. Press the **▲▼** buttons to select **Display Setup**, then press the **OK** or **▶** button.
Video setup menu will be displayed.
4. Press the **▲▼** buttons to select the desired display option from the options on the following pages.
5. Press the **▲▼** buttons to select the desired sub-menu item from a video display option, then press the **OK** button.
6. Each video option is described in detail below.

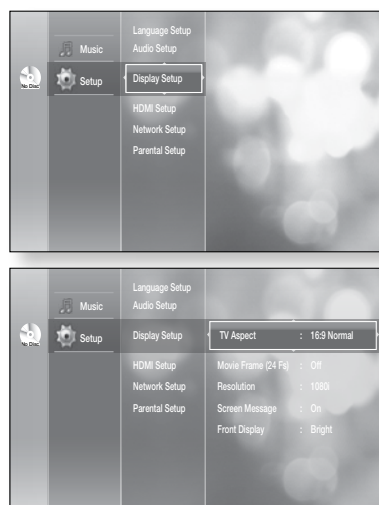

- Press the **RETURN** or **◀** button to return to the previous menu. Press the **MENU** button to exit the menu.

TV Aspect

Depending on the type of television you have, you may want to adjust the screen setting. (aspect ratio)



• 4:3 Letter Box :

Select when you want to see the total 16:9 ratio screen Blu-ray Disc/DVD supplies, even though you have a TV with a 4:3 ratio screen. Black bars will appear at the top and bottom of the screen.



• 4:3 Pan-Scan :

Select when you want to see the 16:9 video supplied by the Blu-ray Disc/DVD without the black bars on top and bottom, even though you have a TV with a 4:3 ratio screen (Extreme left and right portion of the movie picture will be cut off).



• 16:9 Wide :

You can view the full 16:9 picture on your widescreen TV.



• 16:9 Normal :

Certain movies (4:3 source) will be displayed in 4:3 Pillarbox (black bars on sides of picture) if 16:9 normal is selected.



- Depending on the disc type, some aspect ratios may not be available.
- If you select an aspect ratio which is different than the aspect ratio of your TV screen, then the picture might appear to be distorted.

display setup

Movie Frame (24 Fs)

Movies are usually filmed at 24 frames per second. Some Blu-ray discs have the capability of playing back at this frame rate. Setting the Movie Frame (24Fs) feature to ON allows you to adjust the Blu-ray Disc Player's HDMI output to 24 frames per second for improved picture quality.

You can enjoy the Movie Frame (24Fs) feature only on a TV supporting this frame rate.

This menu can only be selected in 1080i or 1080p HDMI output resolution modes.

Depending on the disc, two types of frame rates may be included: Movie material (24 frame) and Video material (30 frame). When the setting switches between Movie (24 frame) and Video (30 frame), the screen may blink for a few seconds.

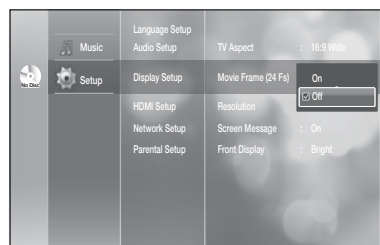

Resolution

Sets the output resolution of the Component and HDMI video signal.

- The number in 576i/480i, 576p/480p, 720p, 1080p and 1080i indicates the number of lines of video. The i and p indicate interlace and progressive scan, respectively.
 - 1080p : Outputs 1080 lines of progressive video(HDMI only).
 - 1080i : Outputs 1080 lines of interlaced video.
 - 720p : Outputs 720 lines of progressive video.
 - 576p/480p : Outputs 576/480 lines of progressive video.
 - 576i/480i : Outputs 576/480 lines of interlaced Video(Component only).



If the connected TV does not support Movie Frame or the selected resolution, you will see the following message:

If you select "Yes" and the resolution is not supported, the TV's screen will be blank. Please wait for 15 seconds and the resolution will be reverted to the previous value automatically.

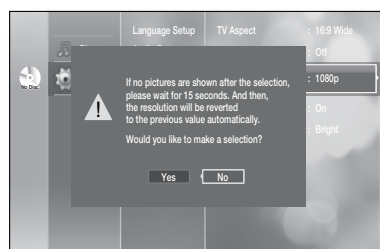

- If the screen is blank, press and hold the ►► button on the front of the player for more than 5 seconds (no disc inserted). All settings are restored to the factory default. Follow the steps on the previous page to access each mode and select the Display Setup that your TV will support.
- When the factory default settings are restored, all the user data stored in the persistent storage will be deleted.

❖ Resolution according to the output mode

- Blu-ray Disc playback

Setup \ Output	HDMI	Component (HDMI&Comp. connected / Comp. connected only)	VIDEO
1080p, Movie Frame(24Fs) off	1080p	1080i	576i (480i)
1080p/1080i, Movie Frame (24Fs) on	1080p@24F	576i (480i) / 1080i	576i (480i)
1080i, Movie Frame (24Fs) off	1080i	1080i	576i (480i)
720p	720p	720p	576i (480i)
576p (480p)	576p (480p)	576i (480i) / 576p (480p)	576i (480i)
576i/480i	576p (480p)	576i (480i)	576i (480i)

- DVD playback

Setup \ Output	HDMI	Component (HDMI&Comp. connected / Comp. connected only)	VIDEO
1080p	1080p	576i (480i) / 576p (480p)	576i (480i)
1080i	1080i	576i (480i) / 576p (480p)	576i (480i)
720p	720p	576i (480i) / 576p (480p)	576i (480i)
576p (480p)	576p (480p)	576i (480i) / 576p (480p)	576i (480i)
576i (480i)	576p (480p)	576i (480i)	576i (480i)



- In DVD playback, if both HDMI and Component jacks are connected but you are currently viewing component output, the Display Setup menu will show the output resolution as 1080p. The resolution is actually 576i/480i.
- This player has the HDMI Auto Detect Feature. When the player is first connected to a TV via HDMI, the player's output will be set automatically to HDMI.
- If the HDMI Auto Detection feature does not work, you can't select the 1080p resolution or Movie Frame (24Fs).
- The Blu-ray Disc must have the 24 frame feature in order to use the Movie Frame (24Fs) mode.

Screen Message

- **On** : Displays messages related to operation mode.
- **Off** : Does not display messages related to operation mode.

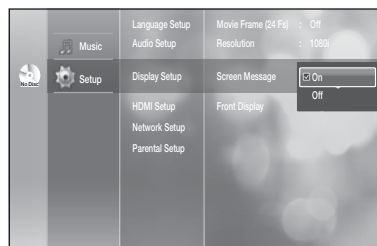

Front Display

- **Automatic** : Display is dim during playback and bright when the unit is in Stop mode.
- **Dim** : Select to dim the display window.
- **Bright** : Select to brighten the display window.

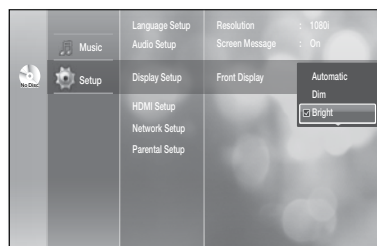

HDMI setup

SETTING UP THE HDMI SETUP OPTIONS

1. With the unit in Stop mode, press the **MENU** button.
2. Press the **▲▼** buttons to select **Setup**, then press the **OK** or **▶** button.
3. Press the **▲▼** buttons to select **HDMI Setup**, then press the **OK** or **▶** button.
HDMI setup menu will be displayed.
4. Press the **▲▼** buttons to select the desired display option (Anynet+ or Format), then press the **OK** or **▶** button.

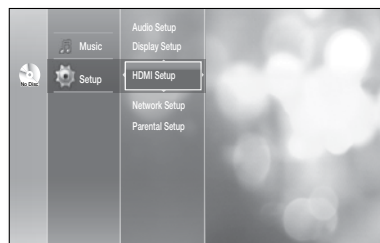

Anynet+ (HDMI-CEC) (Only Samsung products)

When HDMI is set to on, you can operate the Anynet+ function.

- **On** : Anynet+ functions will work.
- **Off** : Anynet+ function will not work.

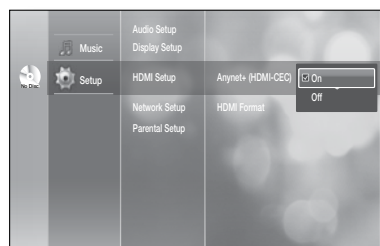

What is Anynet+?

Anynet+ is a convenient function that offers linked operations with other Samsung products with the Anynet+ feature.

You can operate this unit using a Samsung TV remote control or power on your Samsung TV and Home theater and start disc playback simply by pressing the **PLAY** button on the TV's remote.

 This function is not available if the HDMI cable does not support CEC.

To use Anynet+

1. Connect the **Blu-ray Disc Player** to a Samsung TV with an HDMI cable. (See pages 20~21)
2. Set the Anynet+ (HDMI CEC) to "On" on your **Blu-ray Disc Player**.
3. Set the Anynet+ function on your TV. (See the TV instruction manual for more information.)

Anynet+ Functions

- One touch play
You can power on your Samsung TV and Home Theater, and play the disc in this unit simply by pressing the **PLAY** button on the TV's remote.
- One touch watching
Select "Watching Blu-ray Disc Player" or "Connected to Blu-ray Disc Player" (depending on your TV's menu) in the Anynet+ menu on the TV. The Blu-ray Disc Player will automatically turn on and the TV will be switched to HDMI mode.
- Remote control Link
You can operate this player with your Samsung TV remote control.
- Available buttons on the Samsung TV remote: These buttons work the same as this Blu-ray Disc player's remote control.
 - Playback control buttons : ⏮ ⏪ ⏩ ⏭ ⏮
 - Menu operation button : 🗑️ 🗑️ 🗑️ 🗑️ 🗑️
 - Numeric buttons : 0 ~ 9
 - Color buttons : **A B C D**

TV Anynet+ Menu

When you press the Anynet+ button on your Samsung TV's remote control, the following On-Screen Display (OSD) will be shown.



- Blu-ray Disc Player Menu
 - When playing a movie : brings up the disc's menu (same as **DISC MENU** button on the Blu-ray Disc Player's remote control)
 - In Stop mode : brings up the SETUP menu (same as the **MENU** button on the Blu-ray Disc Player's remote control.)
- Blu-ray Disc Player Operation Menu
 - When playing a DVD VIDEO, DVD-RW/-R, BD-ROM, BD-RE : shows INFO OSD (same as **INFO** button on the player's remote control)



▪ These menus may look different depending on your Samsung TV.

HDMI Format

You can optimize the HDMI output for connection to a TV or Monitor.

- **TV** : Select if connected to a TV via HDMI.
- **Monitor** : Select if connected to a Monitor via HDMI.
If the player is connected to a TV, the Monitor option is unavailable.

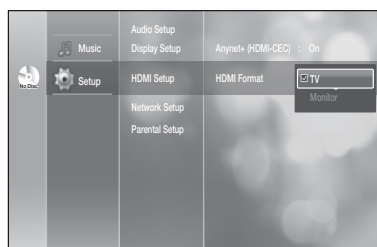

▪ TV or monitor has to be connected to the player before you select this option.

parental setup

SETTING UP THE PARENTAL LOCK

The Parental Lock function works in conjunction with Blu-ray Disc/DVDs that have been assigned a rating which helps you control the types of Blu-ray Disc/DVDs that your family watches. There are up to 8 rating levels on a disc.



1. With the unit in Stop mode, press the **MENU** button.
2. Press the **▲▼** buttons to select **Setup**, then press the **OK** or **▶** button.

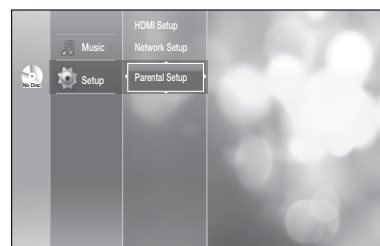

3. Press the **▲▼** buttons to select **Parental Setup**, then press the **OK** or **▶** button.
When you operate your Blu-ray Disc Player for the first time, the “Enter New password” message will be displayed.

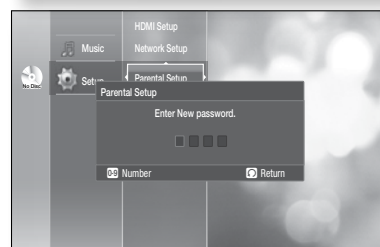

4. Enter the 4-digit password using the number buttons on the remote control.
The “Confirm the password” message will be displayed.
Enter your password again.

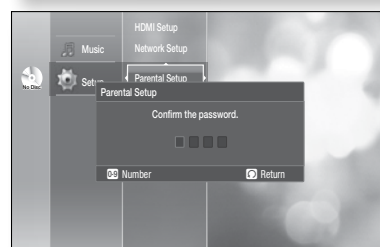

5. Press the **OK** or **▶** button to select **Parental Lock**.

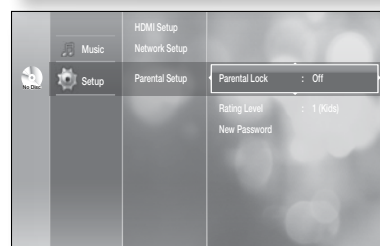

6. Press the **▲▼** buttons to select **On** or **Off**, then press the **OK** button.

 ■ Press the **RETURN** or **◀** button to return to the previous menu. Press the **MENU** button to exit the menu.

If you forgot your password

1. Remove the disc.
2. Press and hold the **▶▶** button on the front panel for 5 seconds or more.
 - All settings will revert to the factory settings.

 ■ When the factory default settings are restored, all the user data stored in the persistent storage will be deleted.

Setting the Rating Level

1. Press the ▲▼ buttons to select **Rating Level**, then press the **OK** or ► button.

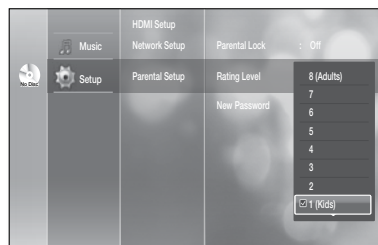

2. Press the ▲▼ buttons to select the rating level you want, then press the **OK** button. For example, if you select up to Level 6, discs that contain Level 7, 8 will not play. A larger number indicates that the program is intended for adult use only. Level 1 is the most restrictive and Level 8 is the least.

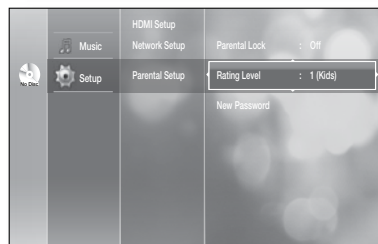

Changing the Password

1. Press the ▲▼ buttons to select **New Password**, then press the **OK** or ► button.

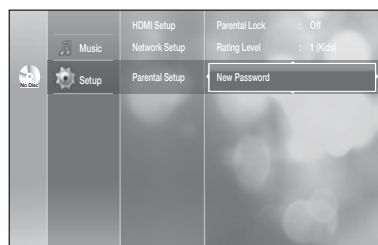

2. Enter the 4-digit password using the number buttons on the remote control. The “Enter New password.” message will be displayed.

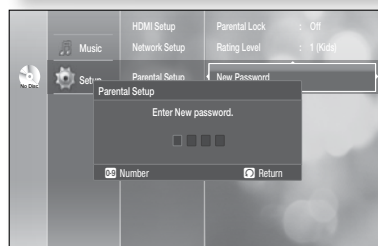

3. Enter your password again using the number buttons on the remote control.

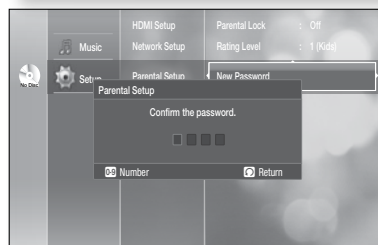

network setup

You can update your player via Samsung's server.

Follow the steps below to ensure the best connection to the Samsung's server for your player.

To obtain information on the proper settings, check the network settings on your computer or contact your Internet provider.

TCP/IP SETTING

1. With the unit in Stop mode/No Disc mode, press the **MENU** button.
2. Press the **▲▼** buttons to select **Setup**, then press the **OK** or **▶** button.
3. Press the **▲▼** buttons to select **Network Setup**, then press the **OK** or **▶** button.
4. Press the **▲▼** buttons to select **TCP/IP**, then press the **OK** or **▶** button.
5. Press the **▲▼** buttons to select **DHCP**, then press the **OK** button.

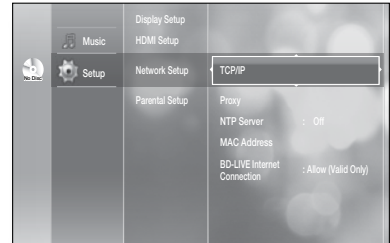

- If DHCP is set to On, you can't select IP Address, Subnet Mask or Gateway.
- If DNS is set to Automatic, you can't select Primary/Secondary DNS.

6. Press the **▲▼** buttons to select a desired item, then press the **OK** button.

- If DHCP is set to Off and, DNS to Manual, enter your IP Address, Subnet Mask, Gateway and Primary DNS settings (Secondary DNS is optional).

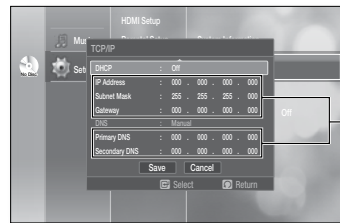

Setup available

- If DHCP is set to On and, DNS to Manual, enter your Primary DNS setting (Secondary DNS is optional).

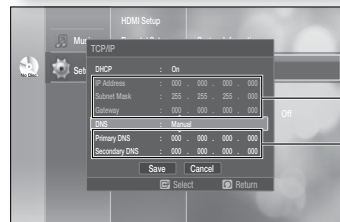

Setup not available

Setup available

- If DHCP is set to On and, DNS to Automatic, you don't need further or additional settings.

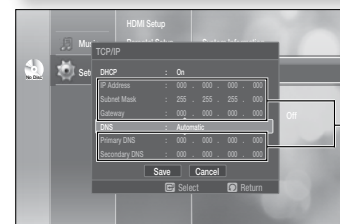

Setup not available

- ✍️ ▪ When you select an item, use the number and ▲▼◀▶ buttons.
- If the automatic settings don't work, contact your ISP.

7. When done, use the ▲▼ buttons to select **Save**, then press the **OK** button.
8. If you don't want to save your work, use the ▲▼◀▶ buttons to select **Cancel**, then press the **OK** button.

- ✍️ ▪ The IP address used in this manual is for illustrative purposes only. You must refer to the your network settings for the actual IP address.
- To obtain settings for IP address, Subnet mask, Gateway and Primary DNS, check the network settings in your computer or contact your internet service provider.

PROXY SETTING

A proxy server services requests by forwarding them to other servers. If you are required to configure the proxy setting, enter the settings specified by the ISP. To setup, follow steps 1 to 3 in "TCP/IP Setting" on page 44.

4. Press the ▲▼ buttons to select **Proxy**, then press the **OK** or ▶ button.
 - **Server**
 - **Port**
 - **User**
 - **Password**

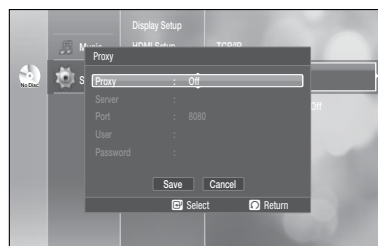

- ✍️ ▪ For more information, contact your ISP (Internet Service Provider).

NTP SERVER SETTING (USED TO RETRIEVE TIME INFORMATION FROM NTP SERVER)

To setup, follow steps 1 to 3 in "TCP/IP Setting" on page 44.

4. Press the ▲▼ buttons to select **NTP Server**, then press the **OK** or ▶ button.
 - **On** : the player automatically connects to the Internet server in order to adjust the time setting.
 - **Off** : the player does not connect to the Internet server to adjust the time setting.

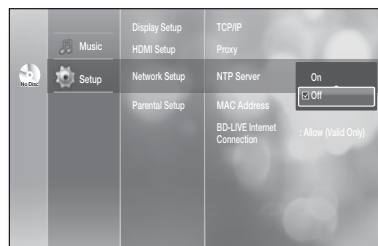

network setup

MAC ADDRESS

Displays the MAC address of the player.

A MAC address(Media Access Control address) is a unique identifier attached to most network adapters. It is a address that acts like a name for a particular network adapter. It cannot be changed.

1. With the unit in Stop mode/No Disc mode, press the **MENU** button.
2. Press the **▲▼** buttons to select **Setup**, then press the **OK** or **▶** button.
3. Press the **▲▼** buttons to select **Network Setup**, then press the **OK** or **▶** button.
4. Press the **▲▼** buttons to select **Mac Address**, then press the **OK** or **▶** button.
The MAC address appears.

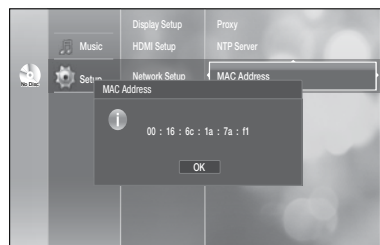

- Samsung shall not be responsible for any malfunction or failed operation due to Internet connection failure or a communication error. Samsung is also not responsible for failure of the user's Internet connection.
- You may not be able to access some Internet services depending on the limitations of your Internet service provider.
- Any fee charged for Internet connection is solely your responsibility.
- A DSL modem is needed to use DSL service. You may have agreed with your ISP (Internet Service Provider) on the number of concurrent internet connection devices. Under the agreement, your PC and Blu-ray Disc Player may not use the network simultaneously.
- You may not be allowed to use a router under your ISP's policy.

BD-LIVE INTERNET CONNECTION

The Internet connection may be restricted while you are using BD-LIVE contents.

1. With the unit in Stop mode/No Disc mode, press the **MENU** button.
2. Press the **▲▼** buttons to select **Setup**, then press the **OK** or **▶** button.
3. Press the **▲▼** buttons to select **Network Setup**, then press the **OK** or **▶** button.
4. Press the **▲▼** buttons to select **BD-LIVE Internet Connection**, then press the **OK** or **▶** button.

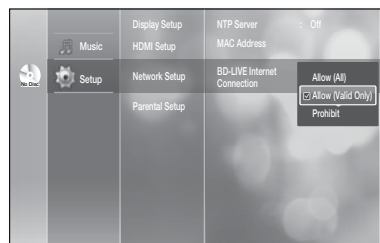

- **Allow (All)** : The Internet connection will be allowed for all BD-LIVE contents.
- **Allow (Valid Only)** : The Internet connection will be allowed only for BD-LIVE contents containing a valid certificate..
- **Prohibit** : No Internet connection will be allowed for any BD-LIVE content.

■

persistent storage management

Persistent Storage (External USB flash memory) is a memory for storing Blu-ray Disc content.

Persistent Storage is where for storing additional content such as trailers and other special features downloaded from BD-LIVE service or Blu-ray Discs.

SYSTEM DEVICE MANAGEMENT

You can manage user data stored in persistent storage.

1. With the unit in Stop mode, press the **MENU** button.
2. Press the **▲▼** buttons to select **Setup**, then press the **OK** or **▶** button.
3. Press the **▲▼** buttons to select **System Setup**, then press the **OK** or **▶** button.
4. Press the **▲▼** buttons to select **Persistent Storage Management**, then press the **OK** or **▶** button.

- To format the flash memory -

Use the **▲▼** button to select an external flash memory that you want to format and press the **YELLOW (C)** button.

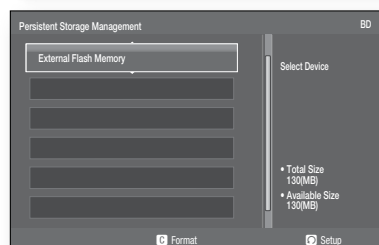
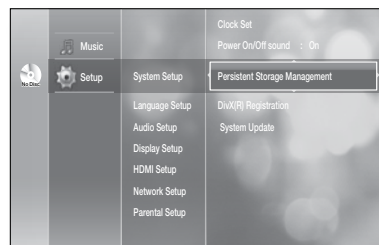

Description of Device(Storage) Information on the Player

- Total Size : Total size of the Device(Storage).
- Available Size : Available size of the Device(Storage).



- Memory size information on the current device(storage) is located to the right of the PSM menu.
- In the external memory mode, disc playback will be stopped if you disconnect the USB device in the middle of the playback.
- It is recommended to use an USB device that supports USB 2.0 protocols, FAT32 format and 4MB or more read / write speed.
- Resume Play function may not work after changing something in Persistent Storage Management.

DivX(R) REGISTRATION

Please use the Registration code to register this Blu-ray Disc Player with the DivX(R) Video On Demand format. For more information, visit www.divx.com/vod

system upgrade

Samsung may offer upgrades to your Blu-ray Disc Player's firmware in the future. To upgrade this firmware you must :

1. Go to samsung.com and refer to the 'SUPPORT' page to download the latest firmware.
You can use a CD-R or a USB flash drive to perform the firmware upgrade. For more information, see "Upgrade Manual" at the website mentioned above.
- or
2. Connect this player's LAN terminal to the LAN terminal on your modem (see page 28) and follow the steps below.

FIRMWARE UPGRADE

1. With the unit in Stop mode, press the **MENU** button.
2. Press the **▲▼** buttons to select **Setup**, then press the **OK** or **▶** button.
3. Press the **▲▼** buttons to select **System Setup**, then press the **OK** or **▶** button.
4. Press the **▲▼** buttons to select **System Update**, then press the **OK** or **▶** button.

5. The player will check the cable or network connection status automatically. The connection checking window will be displayed.

- If the upgrade is possible : You will see information on the current and new versions of firmware in a message box.

- If the upgrade is not possible : You will see the following description in the message box.

- If the cable is not connected :
"Ethernet cable is not connected. Please, check the Ethernet cable"
- If the network connection has failed :
"This system can not connect to internet for update. Please, check the network setup"
- If no latest version is released (the latest version has been already installed) :
"The latest version of the firmware is already installed. There is no need to update."
- If there is a disc in the player :
"Please maintain "No Disc" state for network update."
This indicates that you must remove all discs from the unit to perform the update.
- If the server service is not available :
"Update Server is under maintenance. Please try again later."

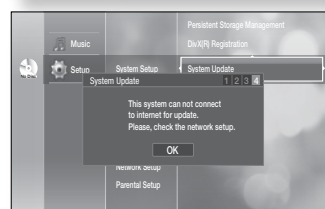
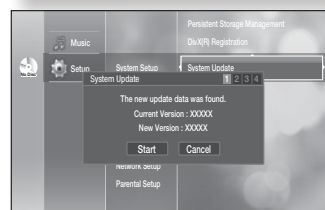
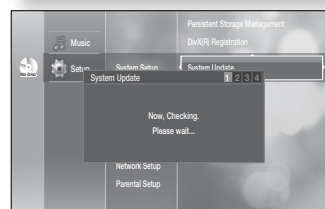
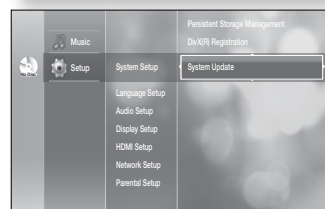
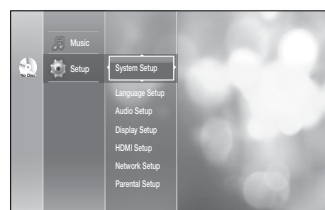

6. To perform the system upgrade, press the ◀▶ buttons to select **Start** and then press the **OK** button.

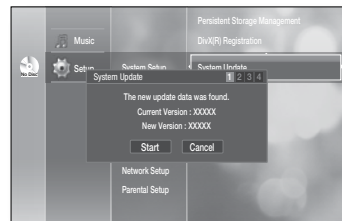

7. The system update gets started.

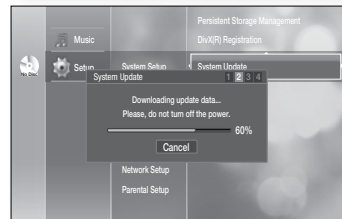

8. If you select **Cancel** during the download process, you are prompted to confirm your selection in a message box. If you want to cancel the download, select **Yes** and press the **OK** button.

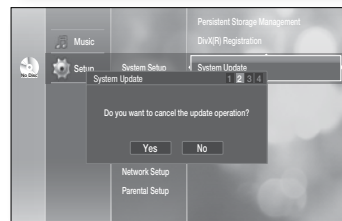

9. Verification will proceed. When download is done, the firmware update process will begin automatically.

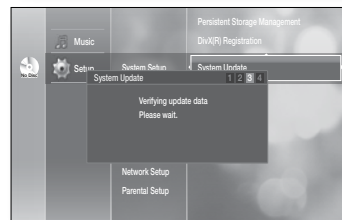

10. When the installation is done, the player will automatically turn off in 5 seconds. All settings will revert to the factory settings the next time you start the system and you will see the menu language selection window.

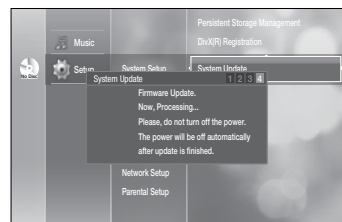

- If you want to cancel the upgrade in the process of downloading the upgrade data, press the **OK** button. You will see a confirmation message. Selecting **"Yes"** will end the upgrade process, and selecting **"No"** will continue the upgrade process.
- When the system upgrade is done, check the firmware details in the System Upgrade menu.
- Do not turn off the player during the System Upgrade, as it may cause the player to not work properly.
- Software upgrades using the USB Host jack supports only a USB flash drive. Other USB devices(ex. MP3 player) are not guaranteed to work.
- There should be only one firmware upgrade file in USB flash drive for the player to perform upgrade properly.
- Oversized USB drives may not be able to be inserted when a LAN or HDMI cable is connected.

system upgrade

SYSTEM INFORMATION

When the firmware upgrade is done, check the firmware details by following the steps below.

1. With the unit in Stop mode/No Disc mode, press the **MENU** button.
2. Press the **▲▼** buttons to select **Setup**, then press the **OK** or **▶** button.
3. Press the **▲▼** buttons to select **System Setup**, then press the **OK** or **▶** button.
4. Press the **▲▼** buttons to select **System Information**, then press the **OK** or **▶** button.
You can see detailed information about the current firmware.
5. Press the **OK** button to select **OK**.
System Setup menu will be displayed.

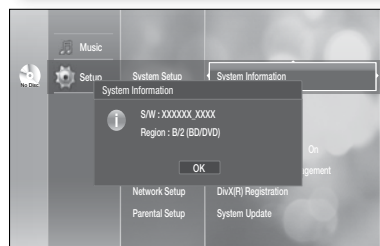
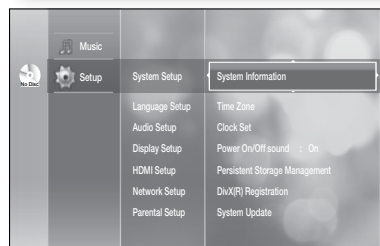
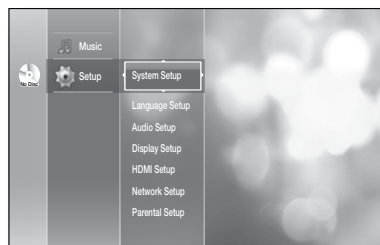

FIRMWARE UPGRADE NOTIFICATION

The popup menu appears when a newer version of the firmware is available from SAMSUNG update server than that of the Blu-ray Disc Player, if the Blu-ray Disc Player is connected to network and powered on.

- **Yes:** Select this to upgrade now.
- **No:** Select this if you plan to upgrade later.

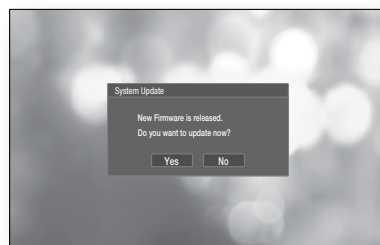

watching a movie

USING THE DISPLAY FUNCTION



1. During playback, press the **INFO** button on the remote control.
 - If the current title of a Blu-ray Disc has the BONUSVIEW feature, press the INFO button in the BONUSVIEW section to display BONUSVIEW-related information.
2. Press the ▲▼ buttons to select the desired item.
3. Press the ◀▶ buttons to make the desired setup change and then press the **OK** button.
 - You may use the number buttons of the remote control to directly access a title, chapter or to start the playback from a desired time.
4. To make the screen disappear, press the **INFO** button again.

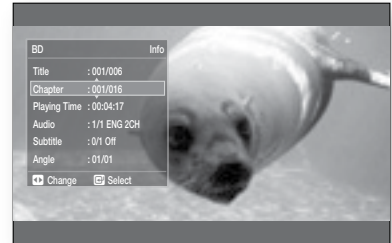

<INFO menu for the BONUSVIEW section>



- If you are playing contents from the info menu, some functions may not be enabled depending on the disc.
- **Title** : To access the desired title when there is more than one in the disc. For example, if there is more than one movie on a Blu-ray Disc/DVD, each movie will be identified as a Title.
- **Chapter** : Most Blu-ray Disc/DVD discs are recorded in chapters so that you can quickly find a specific chapter.
- **Audio** : Refers to the film's soundtrack language. A Blu-ray Disc can contain up to 32 audio languages and a DVD up to 8.
- **Playing Time** : Allows playback of the film from a desired time. You must enter the starting time as a reference. The time search function does not operate on some discs.
- **Subtitle** : Refers to the subtitle languages available in the disc. You will be able to choose the subtitle languages or, if you prefer, turn them off from the screen. A Blu-ray Disc can contain up to 255 subtitle languages, and a DVD up to 32.
- **Angle** : When a Blu-ray Disc/DVD contains multiple angles of a particular scene, you can use the ANGLE function.
- **BONUSVIEW Video/ BONUSVIEW Audio** : You can make BONUSVIEW Video or BONUSVIEW Audio settings if the current title of a Blu-ray Disc appears in the BONUSVIEW section. The BONUSVIEW Video / BONUSVIEW Audio options, however, will be disabled with a Blu-ray Disc that does not support the BONUSVIEW feature.

watching a movie

USING THE DISC MENU & POPUP/TITLE MENU

Using the Disc Menu



1. During playback, press the **DISC MENU** button on the remote control.
2. Press the **▲▼◀▶** buttons to make the desired selection, then press the **▶** or **OK** button.
 - The Disc menu setup items may vary from disc to disc.



-  ■ Depending on the disc, the Disc Menu may not be available.

Using the Title Menu



1. During playback, press the **TITLE MENU** button on the remote control.
2. Press the **▲▼◀▶** buttons to make the desired selection, then press the **OK** button.
 - The Title menu setup options may vary from disc to disc.

-  ■ Depending on the disc, the Title Menu may not be available.
- Title Menu will only be displayed if there are at least two titles in the disc.

Playing the Title List



1. With the unit in Stop mode/Playback mode, press the **DISC MENU** or **TITLE MENU** button.
2. Press the **▲▼** buttons to select an entry you want to play from Title List, then press the **▶** or **OK** button.
The selected entry (title) will be played back.

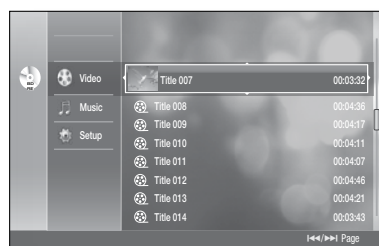

- Go to Playlist -

To go to the Playlist, press the **RED(A)** button

Using the Popup Menu



1. During playback, press the **POPUP MENU** button on the remote control.
2. Press the **▲▼◀▶** buttons or **OK** button to select the desired menu.
 - The Popup menu setup options may vary from disc to disc.



▪ Depending on the disc, the Popup Menu may not be available.

REPEAT PLAY

Repeat the current chapter or title.

Repeat playback



1. During playback, press the **REPEAT** button on the remote control. Repeat screen appears.
2. Press the **▲▼** buttons to select **Chapter** or **Title**.
 - Blu-ray Disc/DVD repeats play by chapter or title.
3. To return to normal play, press the **REPEAT** button again, then press the **▲▼** buttons to select **Off**.

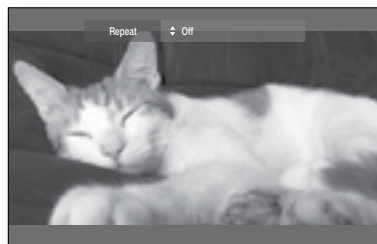

▪ Depending on the disc, the Repeat function may not be available.

Using the A-B Repeat function



1. Press the **REPEAT A-B** button on the remote control during playback.
2. Press the **REPEAT A-B** button at the point where you want repeat play to start (A).
3. Press the **REPEAT A-B** button at the point where you want repeat play to stop (B).
4. To return to normal play, press the **CANCEL** button.



▪ Point B cannot be set until 5 seconds of playback has elapsed from point A.

watching a movie

SELECTING THE AUDIO LANGUAGE



You can select a desired audio language quickly and easily with the **AUDIO** button.

Using the **AUDIO** button

1. Press the **AUDIO** button during playback. The Audio changes when the button is pressed repeatedly.
 - The audio languages are represented by abbreviations.

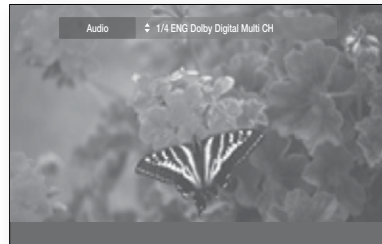

2. To remove the **AUDIO** icon, press the **CANCEL** or **RETURN** button.

Using the **INFO** button

1. During playback, press the **INFO** button on the remote control.
2. Press the **▲▼** buttons to select Audio language.
3. Press the **◀▶** buttons on the remote control to select the desired audio language.



- This function depends on what audio languages are encoded on the disc and may not be available.
- A Blu-ray Disc can contain up to 32 audio languages and a DVD up to 8.
- Depending on the disc type, you can use the Audio button to change the audio soundtrack as well as the audio language.
Some Blu-ray Discs may allow you to select either the multi-channel LPCM or Dolby digital audio soundtrack in English.
- Information about the primary / secondary mode will be also displayed if the Blu-ray Disc has a BONUSVIEW section.
Use the **◀▶** button to switch between primary and secondary audio modes.
- The **◀▶** indicator will not be displayed on the screen if the BONUSVIEW section does not contain any BONUSVIEW audio settings.

SELECTING THE SUBTITLE LANGUAGE

You can select a desired subtitle quickly and easily with the **SUBTITLE** button.

Using the SUBTITLE button

1. Press the **SUBTITLE** button. The subtitle changes when the button is pressed repeatedly. The subtitle languages are represented by abbreviations.
2. To remove the **SUBTITLE** icon, press the **CANCEL** or **RETURN** button.

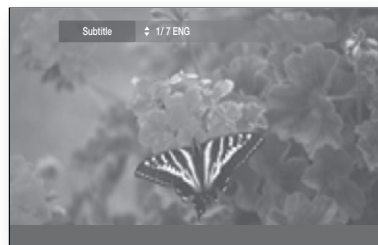

Using the INFO button

1. During playback, press the **INFO** button on the remote control.
2. Press the **▲▼** buttons to select **Subtitle**.
3. Press the **◀▶** buttons on the remote control to select the desired subtitle language.



- Depending on the Blu-ray Disc/DVD, you may be able to change the desired subtitle in the Disc Menu. Press the **DISC MENU** button.
- This function depends on what subtitles are encoded on the disc and may not be available on all Blu-ray Disc /DVDs.
- A Blu-ray Disc can contain up to 255 subtitle languages and a DVD up to 32.
- Information about the primary / secondary mode will be also displayed if the Blu-ray Disc has a BONUSVIEW section.
- This function changes both the primary and secondary subtitles at the same time.
- The number of subtitles is the sum of primary and secondary ones.

CHANGING THE CAMERA ANGLE

When a Blu-ray Disc/DVD contains multiple angles of a particular scene, you can use the **ANGLE** function.

Using the ANGLE function

1. During playback, press the **INFO** button on the remote control.
2. Press the **▲▼** buttons to select **Angle**.
3. Press the **◀▶** buttons or you can use the number buttons on the remote control to select the desired angle.

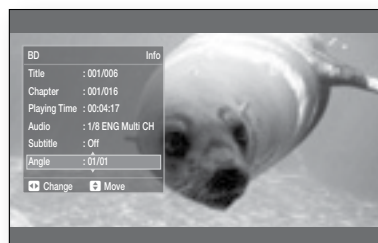

- If the disc has only one angle, this feature won't work. Currently, very few discs have this feature.
- Depending on the disc, these functions may not work.

watching a movie

BONUSVIEW SETTINGS

The Bonusview feature allows you to view additional content (such as commentaries) in a small screen window while the movie is playing.

If the current Blu-ray Disc features the BONUSVIEW function, you can use the **BONUSVIEW** button to turn BONUSVIEW On or Off.

Using the BONUSVIEW button



1. If the current title of a Blu-ray Disc has the BONUSVIEW feature, you will see the BONUSVIEW icon in the BONUSVIEW section on the play screen.
2. Each time you press the **BONUSVIEW** button, you can toggle between BONUSVIEW On and BONUSVIEW Off.

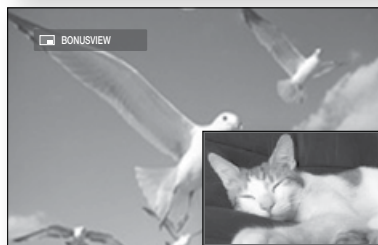
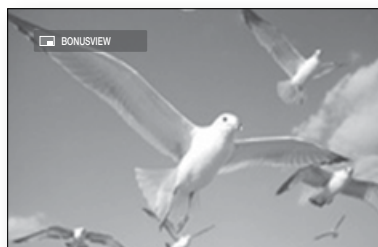

- You can change detailed settings of the BONUSVIEW feature in the INFO menu (see page 51: selection of secondary audio, video stream and subtitle etc.).
- If you switch from BONUSVIEW Video, BONUSVIEW Audio will change automatically in accordance with BONUSVIEW Video.
- If the Blu-ray Disc supports only BONUSVIEW Audio, you can just press the **BONUSVIEW** button to turn the secondary audio on or off.

BD-LIVE™

The Blu-ray player supports BD-LIVE which enables you to enjoy a variety of interactive service contents provided by the disc manufacturer through network connection.

Using the BD-LIVE Disc

1. Connect the LAN adaptor (see page 28) and check the network setup (see pages 44 to 46).
2. Insert a Blu-ray disc that supports BD-LIVE.
3. Select BD-LIVE supported in the disc before you can enjoy various contents.



- The way you use BD-LIVE and the features may differ, depending on the disc.
- To fully support BD-LIVE, you are required to connect a USB memory card with at least 1 GB in size.

USING THE BOOKMARK FUNCTION

This feature lets you bookmark sections of a Blu-ray Disc/DVD, so you can quickly find them at a later time.

Using the MARKER button



1. During playback, press the **MARKER** button on the remote control.
The Bookmark screen appears.
2. Press the **OK** button when the desired scene appears.
The selected scene will be stored.
3. To bookmark another section, press the **◀▶** buttons to move to the next position.
4. Press the **OK** button again when the desired scene appears.
The scene will be stored at the selected position and the bookmark time information will be shown.
 - Repeat above to bookmark other positions.
 - You can bookmark up to 8 scenes.



- When the disc tray is opened and then closed, bookmark information will be lost.
- In some BD discs(BD-J), Bookmark function can be prohibited.

watching a movie

Playing back a bookmark

1. During playback, press the **MARKER** button on the remote control.



2. Press the ◀▶ buttons to select a bookmarked scene.
3. Press the **OK** or **PLAY**(▶) button to start playing from the selected scene.

Clearing a bookmark

1. During playback, press the **MARKER** button on the remote control.

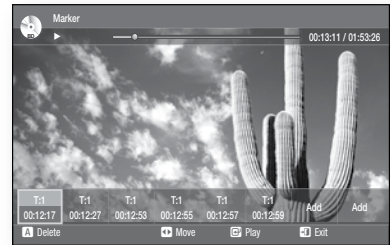

2. Press the ◀▶ buttons to select a bookmarked scene.



3. Press the **RED(A)** button to delete the selected bookmark.



listening to music

PLAYING AN AUDIO CD(CD-DA)



1. Insert an Audio CD(CD-DA) into the disc tray.
The first track will be played automatically.
2. To move to the Music List, press the **STOP** or **RETURN** button.
The Music List screen is displayed on your TV.
3. Press the **▲▼** buttons to select the track you want to play, and then press the **OK** button.

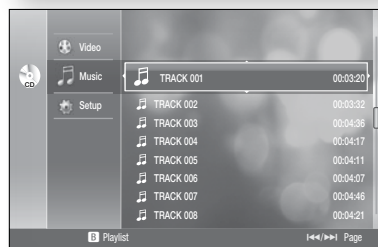
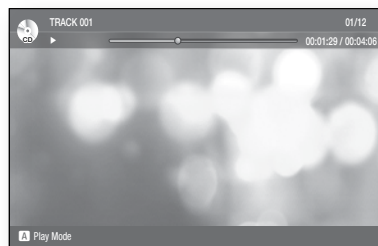

AUDIO CD(CD-DA) SCREEN ELEMENTS



1	Displays the media type.
2	Current track (song) Displays the number of the track currently being played.
3	Play Status Bar.
4	Displays the current play index, total track number.
5	Current /Total Play Time.
6	Displays available COLOR buttons. (see next page for Color button usage).

listening to music

BUTTONS ON THE REMOTE CONTROL USED FOR AUDIO CD (CD-DA) DISC PLAYBACK

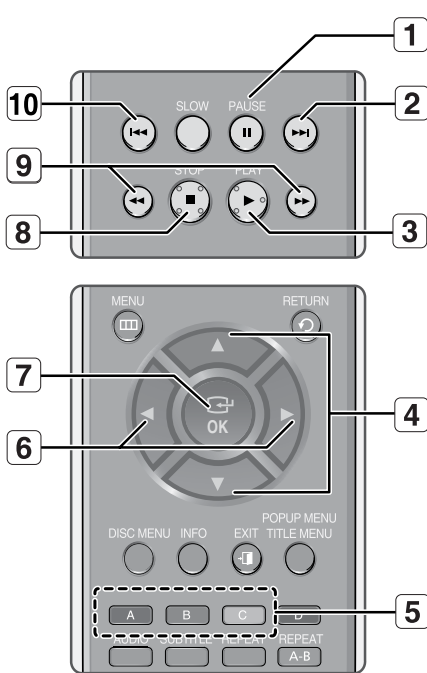

1. **PAUSE** (⏸) button: Pauses playback.
2. **SKIP** (⏭) button: During playback, plays the next track. Moves to the next page in the Music List or the Playlist.
3. **PLAY** (▶) button: Plays the currently selected track.
4. **▲▼** buttons : Selects a track(song) in the Music List or Playlist.
5. **COLOR** buttons: RED(A), GREEN(B), YELLOW(C)
 - RED(A) button : Selects the Play Mode(Repeat) during playback.
 - GREEN(B) button : Go to Playlist from Music List or go to Music list from Playlist.
 - YELLOW(C) button : Playlist play.
6. **◀▶** buttons
 - ▶ : Plays the applicable track, according to the current position.
 - ◀ : Moves to the menu.
7. **OK** button : Plays the selected track (song).
8. **STOP** (⏹) button: Stops a track(song).
9. Press the **SEARCH** (🔍) buttons : Fast Play.
10. **SKIP** (⏮) button: If you pressed this button after three seconds of playback, the current track will be replayed from the beginning. But, if you pressed this button within three seconds after playback starts, the previous track will be played. Also used to move by the page in the Music List or the Playlist.

REPEAT AUDIO CD(CD-DA)

During playback, press the **REPEAT** or **RED(A)** button repeatedly to select the repeat mode you want.
 Normal → → →

- **Normal** : Tracks on a disc are played in the order in which they were recorded on the disc.
- **Repeat Track**
- **Random**
 The random option plays a disc's track in random order.
- **Repeat All** : All tracks are repeated.

- To return to normal playback -

Press the **REPEAT** or **RED(A)** button repeatedly to return to normal playback.

Playlist

You can create a playlist with up to 99 tracks.

1. Insert an Audio CD(CD-DA) into the disc tray.
For an audio CD, the first track will be played automatically.
2. To move to the Music List, press the **STOP** or **RETURN** button.
The Music List screen is displayed.

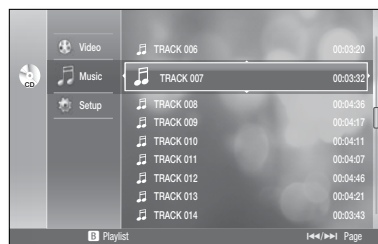

3. Press the **GREEN(B)** button.

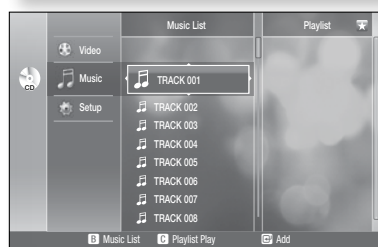

4. Press the **▲▼** buttons to select a track, then press the **OK** button to add it to the Playlist. Repeat this procedure to add additional tracks.

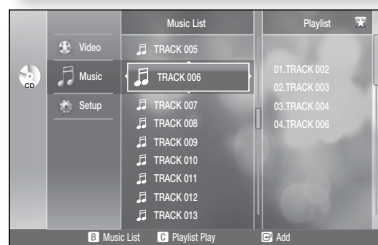

5. If there is an undesired track in the playlist, press the **▲▼** button to select that track, and then press the **OK** button.
 - The selected track will be deleted.

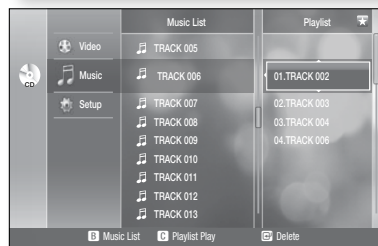

6. Press the **YELLOW(C)** button to play the selected tracks. When the track is finished, the next track will automatically play.

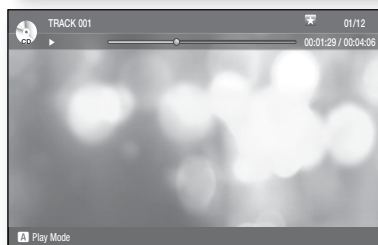

7. To edit the Playlist, press the **STOP** or **RETURN** button.
8. To go to the Music List, press the **Green(B)** or **RETURN** button.



MP3 and JPEG discs cannot be played in this player.

troubleshooting

Before requesting service, please check the following.

PROBLEM	SOLUTION
No operation can be performed with the remote control.	<ul style="list-style-type: none">• Check the batteries in the remote control. They may need replacing.• Operate the remote control at a distance of no more than 6.1m.• Remove batteries and hold down one or more buttons for several minutes to drain the microprocessor inside the remote control to reset it. Reinstall batteries and try to operate the remote control again.
Disc does not play.	<ul style="list-style-type: none">• Ensure that the disc is installed with the label side facing up.• Check the region number of the Blu-ray Disc/ DVD.
Disc Menu does not appear.	<ul style="list-style-type: none">• Check if the disc has a Menu.
The  icon appears on the screen.	<ul style="list-style-type: none">• This icon appears when an invalid button is pressed.• The features or action cannot be completed at this time because :<ol style="list-style-type: none">1. The Blu-ray Disc/ DVD's software restricts it.2. The Blu-ray Disc/ DVD's software doesn't support the feature (e.g., angles)3. The feature is not available at the moment.4. You've requested a title or chapter number or search time that is out of range.
Play mode differs from the Setup Menu selection.	<ul style="list-style-type: none">• Some of the functions selected in the Setup Menu may not work properly if the disc is not encoded with the corresponding function.
The screen ratio cannot be changed.	<ul style="list-style-type: none">• The Screen Ratio is fixed on your Blu-ray Disc/ DVDs.• This is not a problem with the player.
No audio.	<ul style="list-style-type: none">• Make sure you have selected the correct Digital Output in the Audio Options Menu.
The screen is blocked	<ul style="list-style-type: none">• Press the ▶▶ button (in front panel) for more than 5 seconds with no disc inside. All settings will revert to the factory settings.• When the factory default settings are restored, all the user data stored in the persistent storage will be deleted.
If the HDMI output is set to a resolution your TV cannot support (for example, 1080p), you may not see a picture on your TV.	<ul style="list-style-type: none">• Press the ▶▶ button (in front panel) for more than 5 seconds with no disc inside. All settings will revert to the factory settings.• When the factory default settings are restored, all the user data stored in the persistent storage will be deleted.

PROBLEM	SOLUTION
Forgot password	<ul style="list-style-type: none"> • Press the ►► button (in front panel) for more than 5 seconds with no disc inside. All settings including the password will revert to the factory settings. Don't use this unless absolutely necessary. • When the factory default settings are restored, all the user data stored in the persistent storage will be deleted.
If you experience other problems.	<ul style="list-style-type: none"> • Go to the contents and find the section of the instruction manual that contains the explanations regarding the current problem, and follow the procedure once again. • If the problem still cannot be solved, please contact your nearest Samsung authorized service center.
The picture is noisy or distorted	<ul style="list-style-type: none"> • Make sure that the disc is not dirty or scratched. • Clean the disc.
No HDMI output.	<ul style="list-style-type: none"> • Check the connection between the TV and the HDMI jack of the Blu-ray Disc Player. • Check if your TV supports 576p/480p/720p/1080i/1080p HDMI input resolution.
Abnormal HDMI output screen.	<ul style="list-style-type: none"> • If random noise appears on the screen, it means that TV does not support HDCP (High-bandwidth Digital Content Protection).



- When the factory default settings are restored, all the user data stored in the persistent storage will be deleted.

appendix

SPECIFICATIONS

General	Power Requirements	AC 110~240V, 50/60Hz
	Power Consumption	28 W
	Weight	2.85 Kg
	Dimensions	430(W) × 271 (D) × 59 (H) mm
	Operating Temperature Range	+5°C to +35°C
	Operating Humidity Range	10 % to 75 %
Disc	BD (Blu-ray Disc)	Reading Speed : 4.917m/sec
	DVD (Digital Versatile Disc)	Reading Speed : 3.49 ~ 4.06 m/sec. Approx. Play Time (Single Sided, Single Layer Disc) : 135 min.
	CD : 12 cm (COMPACT DISC)	Reading Speed : 4.8 ~ 5.6 m/sec. Maximum Play Time : 74 min.
	CD : 8 cm (COMPACT DISC)	Reading Speed : 4.8 ~ 5.6 m/sec. Maximum Play Time : 20 min.
Video Output	Composite Video	1 channel : 1.0 Vp-p (75 Ω load) Blu-ray/DVD Disc : 576i/480i
	Component Video	Y : 1.0 Vp-p (75 Ω load) Pr : 0.70 Vp-p (75 Ω load) Pb : 0.70 Vp-p (75 Ω load) Blu-ray Disc : 1080i, 720p, 576p/480p, 576i/480i DVD : 576p/480p, 576i/480i
Video/Audio	HDMI	1080p, 1080i, 720p, 576p/480p PCM multichannel audio, Bitstream audio
Audio Output	2 Channel	L(1/L), R(2/R)
	Digital Audio Output	Optical
	*Frequency Response	48 kHz Sampling : 4 Hz to 22 kHz 96 kHz Sampling : 4 Hz to 44 kHz
	*S/N Ratio	110 dB
	*Dynamic Range	100 dB
	*Total Harmonic Distortion	0.003%

*: Nominal specification

- Samsung Electronics Co., Ltd reserves the right to change the specifications without notice.
- Weight and dimensions are approximate.

COPY PROTECTION

- Because AACS (Advanced Access Content System) is approved as content protection system for Blu-ray Disc format, similar to use of CSS (Content Scramble System) for DVD format, certain restrictions are imposed on playback, analog signal output, etc., of AACS protected contents. The operation of this product and restrictions on this product may vary depending on your time of purchase as those restrictions may be adopted and/or changed by AACS after the production of this product. Furthermore, BD-ROM Mark and BD+ are additionally used as content protection system for Blu-ray Disc format, which imposes certain restrictions including playback restrictions for BD-ROM Mark and/or BD+ protected contents. To obtain additional information on AACS, BD-ROM Mark, BD+, or this product, please contact SAMSUNG customer care center.
- Many Blu-ray Disc/DVD discs are encoded with copy protection. Because of this, you should only connect your Blu-ray Disc Player directly to your TV, not to a VCR. Connecting to a VCR results in a distorted picture from copy-protected Blu-ray Disc/DVD discs.
- This product incorporates copyright protection technology that is protected by methods claims of certain U.S. patents and other intellectual property rights owned by Macrovision Corporation and other rights owners. Use of this copyright protection technology must be authorized by Macrovision Corporation and is intended for home and other limited viewing uses only, unless otherwise authorized by Macrovision Corporation. Reverse engineering or disassembly is prohibited.
- Under the U.S. Copyright laws and Copyright laws of other countries, unauthorized recording, use, display, distribution, or revision of television programs, videotapes, Blu-ray Discs, DVDs, and other materials may subject you to civil and/or criminal liability.
- **For Blu-ray Disc Players progressive scan output :** CONSUMERS SHOULD NOTE THAT NOT ALL HIGH DEFINITION TELEVISION SETS ARE FULLY COMPATIBLE WITH THIS PRODUCT AND MAY CAUSE ARTIFACTS TO BE DISPLAYED IN THE PICTURE. IN CASE OF PROGRESSIVE SCAN PICTURE PROBLEMS, IT IS RECOMMENDED THAT THE USER SWITCH THE CONNECTION TO THE 'STANDARD DEFINITION' OUTPUT. IF THERE ARE QUESTIONS REGARDING OUR TV SET COMPATIBILITY WITH THIS PRODUCT, PLEASE CONTACT OUR CUSTOMER SERVICE CENTER.

Compliance and Compatibility Notice

NOT ALL discs are compatible

- Subject to the restrictions described below and those noted throughout this Manual, including the Disc Type and Characteristics section of this Manual, disc types that can be played are: pre-recorded commercial BD-ROM, DVD-Video, and Audio CD discs; BD-RE, BD-R, DVD-RW / DVD-R discs; and CD-RW/CD-R discs.
- Discs other than the above cannot and/or is not intended to be played by this player. And some of the above discs may not play due to one or more reasons provided below.
- Samsung cannot assure that this player will play every disc bearing the BD-ROM, BD-RE, BD-R, DVD-Video, DVD-RW / DVD-R and CD-RW/CD-R logos, and this player may not respond to all operating commands or operate all features of every disc. These and other disc compatibility and player operation issues with new and existing format discs are possible because:
 - Blu-ray is a new and evolving format and this player may not operate all features of Blu-ray Discs because some features may be optional, additional features may have been added to the Blu-ray Disc format after the production of this player, and certain available features may be subject to delayed availability;
 - not all new and existing disc format versions are supported by this player;
 - new and existing disc formats may be revised, changed, updated, improved and/or supplemented;
 - some discs are produced in a manner that allows specific or limited operation and feature during playback;
 - some features may be optional, additional features may have been added after the production of this player or certain available features may be subject to delayed availability;
 - some discs bearing the BD-ROM, BD-RE, BD-R, DVD-Video, DVD-RW/ DVD-R and CD-RW/CD-R logos may still be non-standardized discs;
 - some discs may not be played depending on their physical state or recording conditions;
 - problems and errors can occur during the creation of Blu-ray Disc, DVD software and/or the manufacture of discs;
 - this player operates differently than a standard DVD player or other AV equipment; and/or
 - for reasons noted throughout this Manual and for other reason(s) discovered and posted by SAMSUNG customer care center.
- If you encounter disc compatibility or player operation problems, please contact SAMSUNG customer care center. You may also contact SAMSUNG customer care center for possible updates on this player.
- For additional information on playback restrictions and disc compatibility, refer to the Precautions, Before Reading the User's Manual, Disc Types and Characteristics, and Before Playing sections of this Manual.



UNITED KINGDOM

This Samsung product is warranted for the period of twelve (12) months from the original date of purchase, against defective materials and workmanship. In the event that warranty service is required, you should return the product to the retailer from whom it was purchased.

However, Samsung Authorised Dealers and Authorised Service Centres in other EC Countries will comply with the warranty on the terms issued to purchasers in the country concerned.

In case of difficulty, details of our Authorised Service Centres are available from:

**Samsung Electronics U.K. Ltd.
Customer Care Centre PO Box 17243
Edinburgh, EH11 4YB
United Kingdom**

**Tel: 0845 SAMSUNG (7267864),
Fax: 0845 650 8080**

■ WARRANTY CONDITIONS

1. The warranty is only valid if, when warranty service is required, the warranty card is fully and properly completed and is presented with the original invoice or sales slip or confirmation, and the serial number on the product has not been defaced.
2. Samsung's obligations are limited to the repair or, at its discretion, replacement of the product or the defective part.
3. Warranty repairs must be carried out by Authorised Samsung Dealers or Authorised Service Centres. No re-imbursment will be made for repairs carried out by non Samsung Dealers and, any such repair work and damage to the products caused by such repair work will not be covered by this warranty.



REPUBLIC OF IRELAND

4. This product is not considered to be defective in materials nor workmanship by reason that it requires adaptation in order to conform to national or local technical or safety standards in force in any Country other than the one for which the product was originally designed and manufactured. This warranty will not cover, and no re-imbursment will be made for such adaptation nor any damage which may result.
5. This warranty covers none of the following:
 - a) Periodic check ups, maintenance and repair or replacement of parts due to normal wear and tear.
 - b) Cost relating to transport, removal or installation of the product.
 - c) Misuse, including the failure to use this product for its normal purposes or incorrect installation.
 - d) Damage caused by Lightning, Water, Fire, Acts of God, War, Public Disturbances, incorrect mains voltage, improper ventilation or any other cause beyond the control of Samsung.
6. This warranty is valid for any person who legally acquired possession of the product during the warranty period.
7. The consumers statutory rights in any applicable national legislation whether against the retailer arising from the purchase contract or otherwise are not affected by this warranty. Unless there is national legislation to the contrary, the rights under this warranty are the consumers sole rights and Samsung, its subsidiaries and distributors shall not be liable for indirect or consequential loss or any damage to records, compact discs, videos or audio taper or any other related equipment or material.

SAMSUNG ELECTRONICS (U.K.) LTD.

Contact SAMSUNG WORLD WIDE

If you have any questions or comments relating to Samsung products, please contact the SAMSUNG customer care center.

Region	Country	Contact Center ☎	Web Site
North America	CANADA	1-800-SAMSUNG(726-7864)	www.samsung.com/ca
	MEXICO	01-800-SAMSUNG(726-7864)	www.samsung.com/mx
	U.S.A	1-800-SAMSUNG(726-7864)	www.samsung.com/us
Latin America	ARGENTINE	0800-333-3733	www.samsung.com/ar
	BRAZIL	0800-124-421, 4004-0000	www.samsung.com/br
	CHILE	800-SAMSUNG(726-7864)	www.samsung.com/cl
	NICARAGUA	00-1800-5077267	www.samsung.com/latin
	HONDURAS	800-7919267	www.samsung.com/latin
	COSTA RICA	0-800-507-7267	www.samsung.com/latin
	ECUADOR	1-800-10-7267	www.samsung.com/latin
	EL SALVADOR	800-6225	www.samsung.com/latin
	GUATEMALA	1-800-299-0013	www.samsung.com/latin
	JAMAICA	1-800-234-7267	www.samsung.com/latin
	PANAMA	800-7267	www.samsung.com/latin
	PUERTO RICO	1-800-682-3180	www.samsung.com/latin
	REP. DOMINICA	1-800-751-2676	www.samsung.com/latin
	TRINIDAD & TOBAGO	1-800-SAMSUNG(726-7864)	www.samsung.com/latin
	VENEZUELA	0-800-100-5303	www.samsung.com/latin
Europe	COLOMBIA	01-8000112112	www.samsung.com.co
	BELGIUM	02 201 2418	www.samsung.com/be
	CZECH REPUBLIC	800-726-786 (800 - SAMSUNG)	www.samsung.com/cz
	DENMARK	70 70 19 70	www.samsung.com/dk
	FINLAND	030-6227 515	www.samsung.com/fi
	FRANCE	3260 SAMSUNG (€ 0,15/Min) 08 25 08 65 65 (€ 0,15/Min)	www.samsung.com/fr
	GERMANY	01805 - SAMSUNG(726-7864 € 0,14/Min)	www.samsung.de
	HUNGARY	06-80-SAMSUNG(726-7864)	www.samsung.com/hu
	ITALIA	800-SAMSUNG(726-7864)	www.samsung.com/it
	LUXEMBURG	02 261 03 710	www.samsung.com/lu
	NETHERLANDS	0900-SAMSUNG (726-7864 € 0,10/Min)	www.samsung.com/nl
	NORWAY	815-56 480	www.samsung.com/no
	POLAND	0 801 801 881, 022-607-93-33	www.samsung.com/pl
	PORTUGAL	80820-SAMSUNG(726-7864)	www.samsung.com/pt
	SLOVAKIA	0800-SAMSUNG(726-7864)	www.samsung.com/sk
	SPAIN	902-1-SAMSU(72678)	www.samsung.com/es
	SWEDEN	0771-400 200	www.samsung.com/se
	U.K	0845 SAMSUNG (7267864)	www.samsung.com/uk
	EIRE	0818 717 100	www.samsung.com/ie
	CIS	AUSTRIA	0800-SAMSUNG(726-7864)
SWITZERLAND		0800-SAMSUNG(726-7864)	www.samsung.com/ch
RUSSIA		8-800-555-55-55	www.samsung.ru
KAZAKHSTAN		8-10-800-500-55-500	www.samsung.com/kz_ru
UZBEKISTAN		8-10-800-500-55-500	www.samsung.com/kz_ru
KYRGYZSTAN		00-800-500-55-500	
TADJIKISTAN		8-10-800-500-55-500	
UKRAINE		8-800-502-0000	www.samsung.ua
LITHUANIA		8-800-77777	www.samsung.lt
LATVIA		8000-7267	www.samsung.com/lv
Asia Pacific	ESTONIA	800-7267	www.samsung.ee
	AUSTRALIA	1300 362 603	www.samsung.com/au
	NEW ZEALAND	0800 SAMSUNG (0800 726 786)	www.samsung.com/nz
	CHINA	800-810-5858, 400-810-5858, 010-6475 1880	www.samsung.com/cn
	HONG KONG	3698-4698	www.samsung.com/hk
	INDIA	3030 8282, 1800 110011, 1-800-3000-8282	www.samsung.com/in
	INDONESIA	0800-112-8888	www.samsung.com/id
	JAPAN	0120-327-527	www.samsung.com/jp
	MALAYSIA	1800-88-9999	www.samsung.com/my
	PHILIPPINES	1800-10-SAMSUNG(726-7864)	www.samsung.com/ph
	SINGAPORE	1800-SAMSUNG(726-7864)	www.samsung.com/sg
	THAILAND	1800-29-3232, 02-689-3232	www.samsung.com/th
	TAIWAN	0800-329-999	www.samsung.com/tw
	VIETNAM	1 800 588 889	www.samsung.com/vn
Middle East & Africa	TURKEY	444 77 11	www.samsung.com/tr
	SOUTH AFRICA	0860-SAMSUNG(726-7864)	www.samsung.com/za
	U.A.E	800-SAMSUNG (726-7864), 8000-4726	www.samsung.com/ae



Correct disposal of batteries in this product

(Applicable in the European Union and other European countries with separate battery return systems.)

This marking on the battery, manual or packaging indicates that the batteries in this product should not be disposed of with other household waste at the end of their working life. Where marked, the chemical symbols Hg, Cd or Pb indicate that the battery contains mercury, cadmium or lead above the reference levels in EC Directive 2006/66. If batteries are not properly disposed of, these substances can cause harm to human health or the environment.

To protect natural resources and to promote material reuse, please separate batteries from other types of waste and recycle them through your local, free battery return system.



Correct Disposal of This Product (Waste Electrical & Electronic Equipment)

(Applicable in the European Union and other European countries with separate collection systems)

This marking shown on the product or its literature, indicates that it should not be disposed with other household wastes at the end of its working life. To prevent possible harm to the environment or human health from uncontrolled waste disposal, please separate this from other types of wastes and recycle it responsibly to promote the sustainable reuse of material resources.

Household users should contact either the retailer where they purchased this product, or their local government office, for details of where and how they can take this item for environmentally safe recycling.

Business users should contact their supplier and check the terms and conditions of the purchase contract. This product should not be mixed with other commercial wastes for disposal.