

Register your product and get support at  
[www.philips.com/welcome](http://www.philips.com/welcome)

**Streamium**

MCi298



---

EN User manual

---

**PHILIPS**

Philips Consumer Lifestyle

HK-1013-MCi298

2010

(Report No. / Numéro du Rapport)

(Year in which the CE mark is affixed / Année au cours de laquelle le marquage CE a été apposé)

## EC DECLARATION OF CONFORMITY

(DECLARATION DE CONFORMITE CE)

We / Nous, PHILIPS CONSUMER LIFESTYLE B.V.

(Name / Nom de l'entreprise)

TUSSENDIEPEN 4, 9206 AD DRACHTEN, THE NETHERLANDS

(address / adresse)

Declare under our responsibility that the electrical product(s):

(Déclarons sous notre propre responsabilité que le(s) produit(s) électrique(s))

Philips.....

(brand name, nom de la marque)

.....MCi298/12, /05.....

(Type version or model, référence ou modèle)

Wi-Fi Micro Music System

(product description, description du produit)

To which this declaration relates is in conformity with the following harmonized standards:

(A laquelle cette déclaration se rapporte, est conforme aux normes harmonisées suivantes)

(title, number and date of issue of the standard / titre, numéro et date de parution de la norme)

EN62311 : 2008

EN62301 : 2005

EN55020 : 2007

EN55013 : 2001 + A1:2003 + A2:2006

EN55022 : 2006 + A1:2007

EN55024 : 1998 + A1:2001 + A2:2003

EN301489-1 V1.8.1. : 2008

EN301489-17 V1.3.2. : 2008

EN300328 V1.7.1 :2006

EN60065 : 2002 + A1:2006 +A11:2008

Following the provisions of :

(Conformément aux exigences essentielles et autres dispositions pertinentes de:)

1999/5/EC (R&TTE Directive)

2004/108/EC (EMC Directive)

2009/125/EC (ErP Directive) – EC/1275/2008 & EC/278/2009

And are produced under a quality scheme at least in conformity with ISO 9001 or CENELEC

Permanent Documents

(Et sont fabriqués conformément à une qualité au moins conforme à la norme ISO 9001 ou aux Documents Permanents CENELEC)

The Notified Body ..... Nemko ..... performed .....CB Scheme.....

(L'Organisme Notifié)

(Name and number/ nom et numéro)

(a effectué)

(description of intervention /  
description de l'intervention)

NO56560

And issued the certificate, .....

(et a délivré le certificat)

(certificate number / numéro du certificat)

Remarks:

(Remarques:)

Leuven, March 31, 2010

(place, date / lieu, date)

Frank Dethier

Development Manager, Innovation Lab Leven

Frank Dethier

(signature, name and function / signature, nom et fonction)

# Contents

---

<b>1 Important</b>	<b>5</b>
Safety	5
Environmental notices	6
Recycling	7
Trademark notice	7

---

<b>2 Your MCi298</b>	<b>8</b>
Introduction	8
What's in the box	8
Overview	9
Top and front view	9
Rear view	10
Remote control	11
Touch screen	12
Home screen	12
Text entry on the remote control	13

---

<b>3 Prepare</b>	<b>15</b>
Place the unit	15
Install batteries into the remote control	15

---

<b>4 Turn on/off</b>	<b>16</b>
Connect power supply	16
Turn on/off	16

---

<b>5 First-time setup</b>	<b>17</b>
Connect to home network	17
Wireless connection: One-touch	
Wi-Fi Protected Setup (WPS)	18
Wireless connection: Enter encryption key manually	19
Wired connection	20

---

<b>6 Play from home Wi-Fi/wired network</b>	<b>22</b>
Play Internet radio stations	22
Tune to Internet radio stations	22
Store preset stations	22
Edit favorite stations	22
Manage Internet radio online	24
Manually add stations online	25
Stream from a UPnP server	27
On computers: Set up music sharing	28
Library on the computer or NAS	28
Stream from the computer or NAS	28

---

<b>7 Play from a USB mass storage device</b>	<b>30</b>
Connect a USB mass storage device	30
Play from the USB mass storage device	30

---

<b>8 Play music CDs</b>	<b>31</b>
Basic operations	31
Use the touch screen	31

---

<b>9 Play FM radio</b>	<b>33</b>
Tune to FM radio stations	33
Autostore	33
Manual tuning	33
Edit preset stations	33
Listen to FM radio	33
RDS (Radio Data System)	33

---

<b>10 Play from an external audio device</b>	<b>34</b>
Connect external audio devices	34
Play from an external audio device	34

---

<b>11 Settings</b>	<b>35</b>
Sound settings	35
Dynamic Bass Boost	35
Equalizer	35
Set the volume from the external audio device	35
Incredible Surround	35
Display settings	35
Brightness	35
Clock settings	35
Alarm	35
Date and time	36
Network settings	37
Setup network	37
Location and time zone	37
Language	37
Device information	38
Check for software upgrades	38
Restore factory settings	38

---

<b>12 Register MCI298 with Philips</b>	<b>39</b>
Benefits	39
Register MCI298	39
Register on the web site	39
Register on the device	39
Unregister MCI298	40
Check registration information	40

---

<b>13 Maintenance</b>	<b>41</b>
Cleaning	41

---

<b>14 Technical data</b>	<b>42</b>
--------------------------	-----------

---

<b>15 Troubleshooting</b>	<b>45</b>
---------------------------	-----------

# 1 Important

## Safety

Information for Europe:

Know these safety symbols



The 'exclamation mark' calls attention to features for which you should carefully read the supplied literature to prevent operating and maintenance problems.

The 'lightening bolt' symbol indicates uninsulated components within the product that can cause an electric shock.

To reduce the risk of fire or electric shock, do not expose the product to rain or moisture and do not place any objects filled with liquids, such as vases, on the product.

- ① Read these instructions.
- ② Keep these instructions.
- ③ Heed all warnings.
- ④ Follow all instructions.
- ⑤ Do not use this product near water.
- ⑥ Clean only with dry cloth.
- ⑦ Do not block any ventilation openings. Install in accordance with the manufacturer's instructions.
- ⑧ Do not remove the casing of this product.

- ⑨ Only use this product indoors. Do not expose the product to dripping / splashing water, rain or high humidity.
- ⑩ Keep this product away from direct sunlight, naked flames or heat.
- ⑪ Do not install near any heat sources such as radiators, heat registers, stoves, or other electrical equipment (including amplifiers).
- ⑫ Do not place any other electrical equipment on the product.
- ⑬ Do not place any sources of danger on the product (e.g. objects containing liquids, burning candles).
- ⑭ This product may include batteries. Please refer to safety and disposal instructions for batteries in this user manual.
- ⑮ This product may contain lead and mercury. Disposal of these materials may be regulated due to environmental considerations. Please refer to disposal instructions in this user manual.



### Caution

- Use of controls or adjustments or performance of procedures other than herein may result in hazardous radiation exposure or other unsafe operation.



### Warning

- Never remove the casing of this apparatus.
- Never lubricate any part of this apparatus.
- Never place this apparatus on other electrical equipment.
- Keep this apparatus away from direct sunlight, naked flames or heat.
- Never look into the laser beam inside this apparatus.
- Ensure that you always have easy access to the power cord, plug or adaptor to disconnect this apparatus from the power.
- Where the mains plug or an appliance coupler is used as the disconnect device, the disconnect device shall remain readily operable.



## Modifications

Modifications not authorized by the manufacturer may void user's authority to operate this product.

## Recycling



Your product is designed and manufactured with high quality materials and components, which can be recycled and reused. When you see the crossed-out wheel bin symbol attached to a product, it means the product is covered by the European Directive 2002/96/EC:



Never dispose of your product with other household waste. Please inform yourself about the local rules on the separate collection of electrical and electronic products. The correct disposal of your old product helps prevent potentially negative consequences on the environment and human health.

## Information about the use of batteries:

### ! Caution

- Risk of leakage: Only use the specified type of batteries. Do not mix new and used batteries. Do not mix different brands of batteries. Observe correct polarity. Remove batteries from products that are not in use for a longer period of time. Store batteries in a dry place.
- Risk of injury: Wear gloves when handling leaking batteries. Keep batteries out of reach of children and pets.
- Risk of explosion: Do not short circuit batteries. Do not expose batteries to excessive heat. Do not throw batteries into the fire. Do not damage or disassemble batteries. Do not recharge non-rechargeable batteries.

## Battery disposal information:

Your product contains batteries covered by the European Directive 2006/66/EC, which cannot be disposed of with normal household waste.

Please inform yourself about the local rules on separate collection of batteries. The correct disposal of batteries helps prevent potentially negative consequences on the environment and human health.

## Trademark notice



Windows Media and the Windows logo are trademarks, or registered trademarks of Microsoft Corporation in the United States and/or other countries.



The making of unauthorized copies of copy-protected material, including computer programs, files, broadcasts and sound recordings, may be an infringement of copyrights and constitute a criminal offence. This equipment should not be used for such purposes.

## 2 Your MCi298

Congratulations on your purchase, and welcome to Philips! To fully benefit from the support that Philips offers, register your product at [www.philips.com/welcome](http://www.philips.com/welcome).

### Introduction

#### MCi298 can

- Connect to the existing home network, which can consist of computers and UPnP devices;
- Connect the existing home audio systems and portable media players;
- Connect a USB mass storage device.

#### With such connections, you can

- Play Internet radio stations over the Internet;
- Play music stored on a computer/UPnP device;
- Play music stored on a USB mass storage device through the speakers on **MCi298**;
- Play music CDs;
- Play music from an audio system/portable media player through the speakers on **MCi298**.

The CD player on MCi298 supports these disc/file formats:

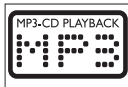

### What's in the box

Check and identify the contents of your package:



- Main unit
- Remote control with batteries
- AC-DC power adapter
- Software suite on a CD-ROM
- Quick Start Guide
- Mounting kit/Mounting instructions



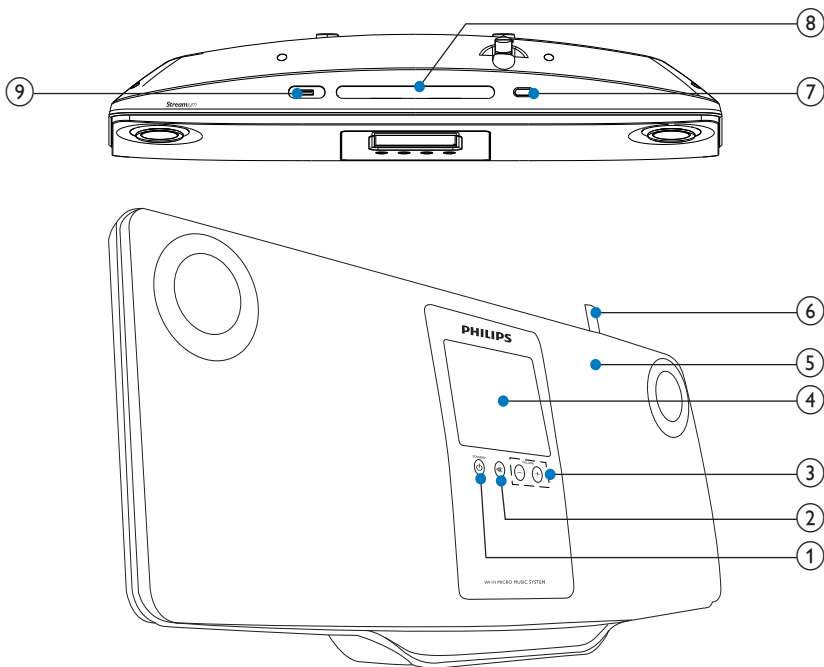

## Overview

### Top and front view



- |    |   |  |
|----|---|--|
| 1. |    | Press to turn on the set;<br>To turn off, press to switch to active standby; or, press and hold to switch to Eco standby.<br>Exit Demo mode. |
| 2. |  | Mute/ unmute sound.  |
| 3. | <b>- VOLUME +</b>   | Increase/decrease volume.  |
| 4. |   | LCD display with touch screen  |
| 5. |   | Loudspeakers   |

- |    |   |  |
|----|---|--|
| 6. |   | Wi-Fi antenna                            |
| 7. |    | Eject the disc.                          |
| 8. |   | Disc slot                                |
| 9. |  | USB port for the USB mass storage device |

## Rear view

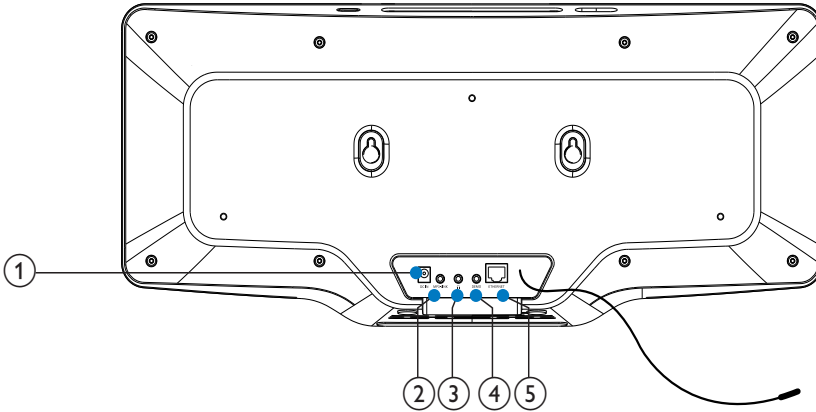

- |    |   |
|----|---|
| 1. | <b>DC IN</b><br>for power cord  |
| 2. | <b>MP3-LINK</b><br>3.5mm audio input jack<br>for a portable media player to<br>play through the speakers on<br>MCI298                         |
| 3. | <br>3.5 mm headphone jack                                    |
| 4. | <b>DEMO</b><br>for the use by dealers only  |
| 5. | <b>ETHERNET</b><br>for the Ethernet cable that<br>connects MCI298 with home<br>network, if you want a wired<br>connection to the home network |
| 6. | <b>FM ANTENNA</b><br>for the supplied FM antenna  |

## Remote control

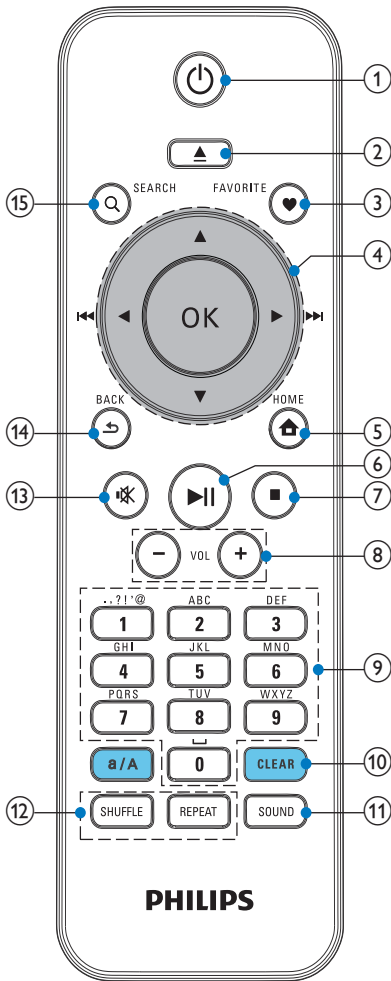

1. Press to turn on the unit; To turn off, press to switch to active standby; or, press and hold to switch to Eco standby.  
Exit Demo mode.
2. Open or close the disc compartment.

### 3. FAVORITE

In **[Internet Radio]** mode:  
Add current station to the list of Favorite Stations.

In **[FM radio]** mode:  
On the play screen, press to add current station to **[Presets]**.

### 4.

Navigation buttons

Press to navigate through menus.



In **[DISC]** mode:

Select an album (for MP3/WMA CDs).



Search buttons on the play screen

In **[Media Library]/[USB]/[DISC]** mode:

Press to skip to the previous/ next track.

In **[FM radio]** mode:

Press and hold to start searching for the next available station;  
Press repeatedly for fine tuning.

**OK**

Confirm selection.

### 5.

**HOME:** Return to Home screen (main menu).

### 6.

Start/pause/resume play.

### 7.

Stop play;

In **[DISC]** mode: Erase a program.

### 8.

Increase/decrease the volume

### 9. **Alphanumeric buttons**

For text entry

### 10. **CLEAR**

Press to delete the previous entry;  
Press and hold to delete all entries.

**a/A**

Press to switch between lower and upper cases;  
In **FM RADIO** mode, press in the list of presets to start editing station name.

11. **SOUND**

Select sound settings.

12. **REPEAT**

Toggle through repeat play options.

**SHUFFLE**

Activate/deactivate random order play.

13. 

Mute/ unmute sound.

14. 

**BACK:** Go back to previous screen.

## Touch screen

MCi298 is equipped with a touch screen.



- If necessary, tap on the screen to show functional buttons;
- Tap on the buttons to select corresponding functions;
- Tap on an option to select.

## Home screen



On **MCi298**, you enter Home screen after the first-time setup is complete.

To select a music source, or enter the [Settings] menu

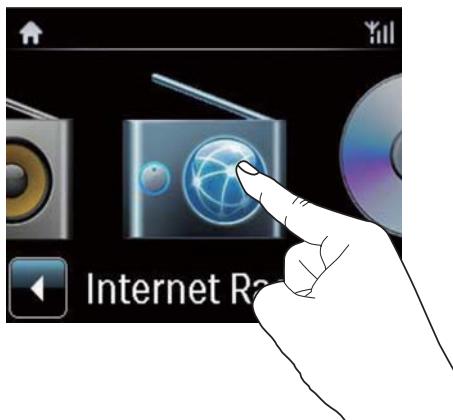

- On Home screen, tap on  to navigate through icons. Tap on the corresponding icon to select.



- Or, press /OK on the remote control to select the desired source.

#### To go back to previous screen

- Press BACK.

#### To return to Home screen

- Press HOME.







## Text entry on the remote control

To enter text and symbols, press corresponding alphanumeric buttons on the remote control.

- To enter letters/numbers/symbols corresponding to the same alphanumeric button, briefly and repeatedly press the button.

English		
	abc...	ABC...
1	1.,?!'@- :./"#\$%& ( ) )*+<=>[ ]^`{  } ~	1.,?!'@- :./"#\$%& ( ) )*+<=>[ ]^`{  } ~
2	abc2	ABC2
3	def3	DEF3
4	ghi4	GHI4
5	jkl5	JKL5
6	mno6	MNO6
7	pqrs7	PQRS7
8	tuv8	TUV8
9	wxyz9	WXYZ9
0	_0	_0

- To enter symbols, press  repeatedly.
- To enter space, press .
- To switch between lower and upper cases, press .
- To delete previous character, press .
- To delete all entries, press and hold .

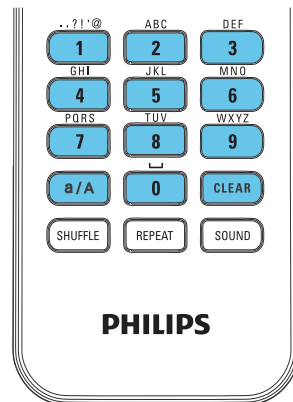

#### Tip

- For languages other than English, letters that an alphanumeric button corresponds to may vary.

Русский	
абв...	АБВ...
1.,?!'@- _::/'#\$%& ( ) *+<=>[ \ ] ^ ` {   } ~ ~	1.,?!'@- _::/'#\$%& ( ) *+<=>[ \ ] ^ ` {   } ~ ~
абвг2abc	АБВГ2ABC
дежз3def	ДЕЖЗ3DEF
ийкл4ghi	ИЙКЛ4GHI
мноп5jkl	МНОП5JKL
рсту6mno	РСТУ6MNO
фхцч7pqrs	ФХЦЧ7PQRS
шщъы8tuv	ШЩЪЫ8TUV
ьэюя9wxyz	ЬЭЮЯ9WXYZ
_0	_0

Other Languages	
abc...	ABC...
1.,?!'@- _::/'#\$%& ( ) *+<=>[ \ ] ^ ` {   } ~ ~	1.,?!'@- _::/'#\$%& ( ) *+<=>[ \ ] ^ ` {   } ~ ~
abc2àáâãäåæ	ABC2ÀÁÂÃÄÅÆ
def3èéêëè	DEF3ÈÉÊËÈ
ghi4íîï	GHI4ÍÎÏ
jkl5	JKL5
mno6ñóôõöø	MNO6ÑÓÔÕÖØ
pqrs7ß	PQRS7ß
tuv8úûü	TUV8ÚÛÜ
wxyz9	WXYZ9
_0	_0

# 3 Prepare

## Place the unit

You can mount **MCi298** on a wall, or put **MCi298** on a surface.

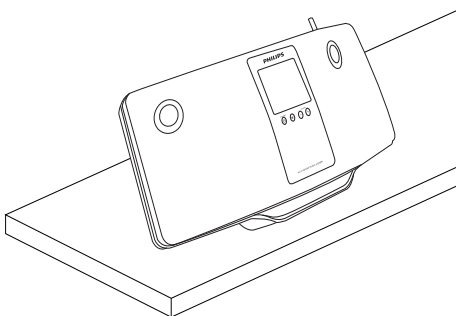
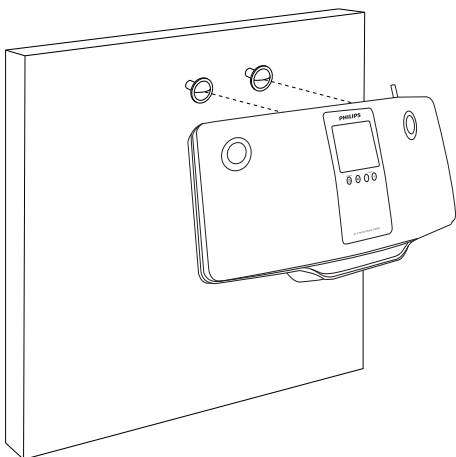

To mount the unit on a wall, see the included separate sheet of wall mounting instructions.

## Install batteries into the remote control



### Caution

- Risk of explosion! Keep batteries away from heat, sunshine or fire. Never discard batteries in fire.
- Risk of decreased battery life! Never mix different brands or types of batteries.
- Risk of product damage! When the remote control is not used for long periods, remove the batteries.

- ① Open the battery compartment.
- ② Insert 2 AAA R03 batteries with correct polarity (+/-) as indicated.
- ③ Close the battery compartment.

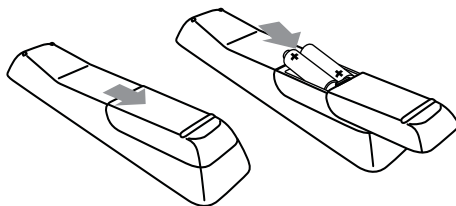

## 4 Turn on/off

### Connect power supply

#### Warning

- Risk of product damage! Ensure that the power supply voltage corresponds to the voltage printed on the back or the underside of the product.

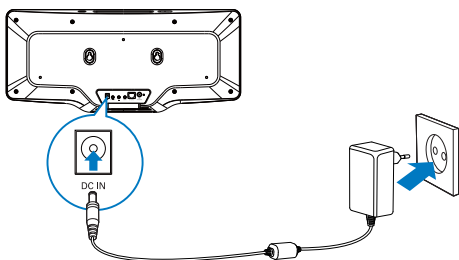

- Connect **MCi298** to the power supply.

#### Note

- The type plate information is located at the back or at the underside of the product.

- The power indicator lights up red;
- Clock time is displayed if you have set clock.

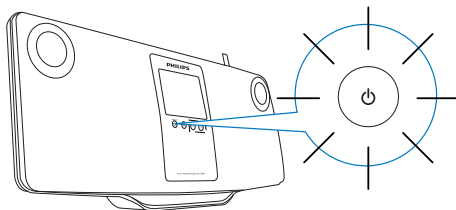

And, the unit is still connected to the Wi-Fi/wired network.



#### Auto active standby

If no activity happens on **MCi298** for 10 minutes, **MCi298** can switch to active standby automatically.

#### Eco standby

Eco standby is an energy-saving mode. In Eco standby, all major functions are switched to a low-power state or off, e.g. micro-processor, Wi-Fi connection, and display.

### Turn on/off

- 1 Press  to turn on the unit.
- 2 To turn off the unit,
  - Press  to switch to active standby;
  - Or, press and hold  to switch to Eco standby (energy-saving mode).

#### Active standby

When in active standby, some major functions of **MCi298** remain in the normal state of power consumption, e.g. Wi-Fi connection, clock display. Thus, **MCi298** can quickly go to the running state when you switch **MCi298** from active standby to on.

In active standby,



## 5 First-time setup

The first time you turn on **MCi298**,

- 1 Select the desired language on the screen as prompted.
- 2 Select your location and time zone from the list as prompted.
- 3 Select **[Yes]**, when asked whether to set up network connection.

---

### Connect to home network

Connect wirelessly

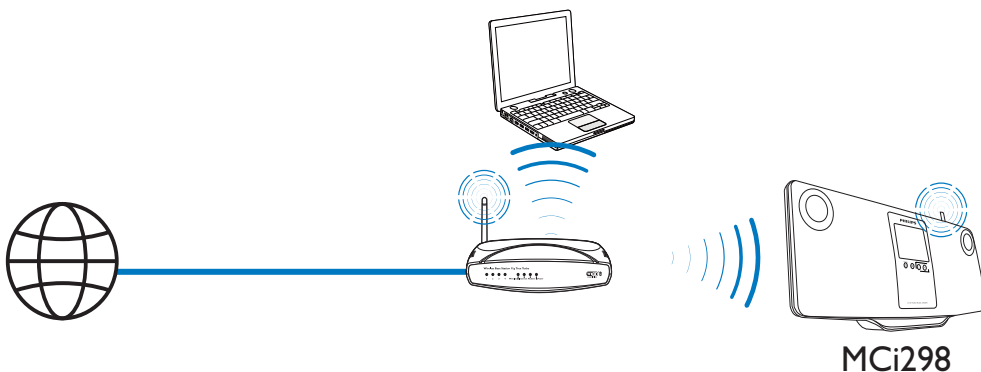

Connect through an Ethernet cable

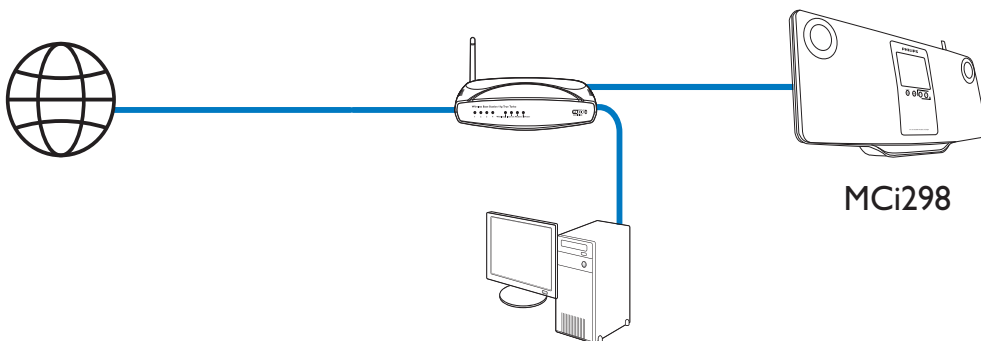

You can connect **MCi298** to home network in different ways, wireless or wired.

- Use a router (or Access Point) for home network. That is, connect computers/ devices to a router.
- Connect **MCi298** to the router wirelessly or through an Ethernet cable.
- To have the unit connected to the Internet over home network, ensure that the router connects to the Internet directly and no dial-up is required on the computer.
- To switch between different connection methods, or switch between different routers, go to **[Settings] > [Network settings] > [Setup network]**.

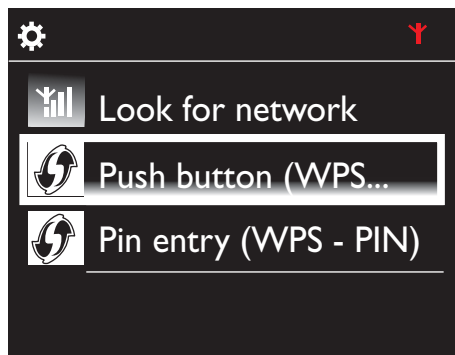

## Wireless connection: One-touch Wi-Fi Protected Setup (WPS)

**MCi298** supports Wi-Fi Protected Setup (WPS). You can quickly and securely connect **MCi298** to a wireless router that also supports the WPS.

You can select one of the two setup methods: PBC (Push Button Configuration), or PIN (Personal Identification Number).

### Tip

- Wi-Fi Protected Setup (WPS) is a standard created by Wi-Fi Alliance for easy establishment of secure wireless home network.

### Turn on WPS-PBC on MCi298

- 1 Select **[Yes]**, when asked whether to set up network connection (see 'First-time setup' on page 17).
- 2 Select **[Wireless (WiFi)] > [Push button (WPS – PBC)]**.

### Add MCi298 on the router

- Consult the user manual of the router to learn how to add a WPS device to the router. For example:
  - press and hold the WPS push button.
  - ↳ The router starts to search for a WPS device.
  - ↳ On MCi298, a message appears when the connection is completed successfully.

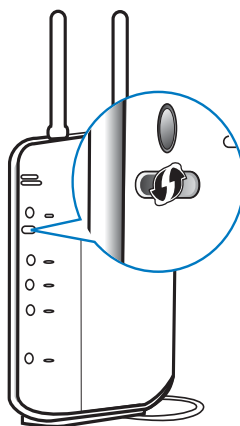

### Tip

- To use PIN (Personal Identification Number) as the setup method: On **MCi298**, select **[Wireless (WiFi)] > [Pin entry (WPS - PIN)]**, and write down the PIN that is displayed on **MCi298**; On the router, enter the PIN.
- Consult the user manual of the router to learn how to enter the PIN the router.

### Connect to the Internet

- Connect to the Internet as prompted.
  - ↳ You enter Home screen after the first-time setup is complete.

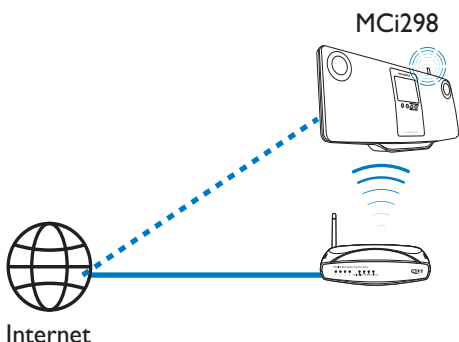

### Tip

- Ensure that the router connects to the Internet directly and no dial-up is required on the computer.

### Wireless connection: Enter encryption key manually

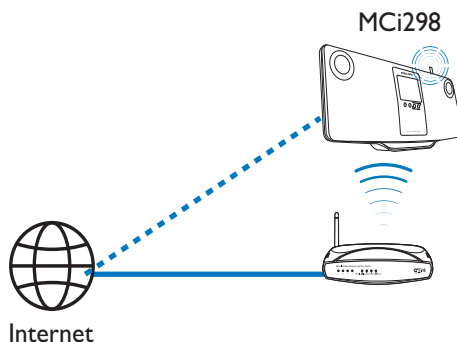

### Tip

- Before you start the network setup, have the encryption key to your router ready.

- 1 Select **[Yes]**, when asked whether to set up network connection (see 'First-time setup' on page 17).
- 2 Select **[Wireless (WiFi)] > [Look for network]**.
  - ↳ The unit starts to search for wireless networks.
  - ↳ A list of available Wi-Fi networks appears.

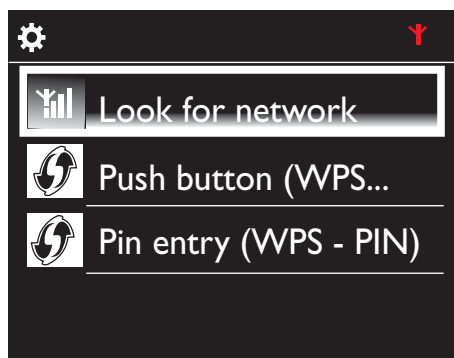

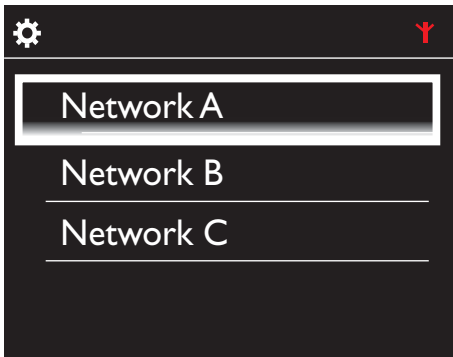

- 3 Select the desired Wi-Fi network.
- 4 As prompted, enter the encryption key to the network.
  - ↳ The unit starts to acquire an IP address assigned by the Wi-Fi network automatically.
  - ↳ A message appears when the connection is completed successfully.

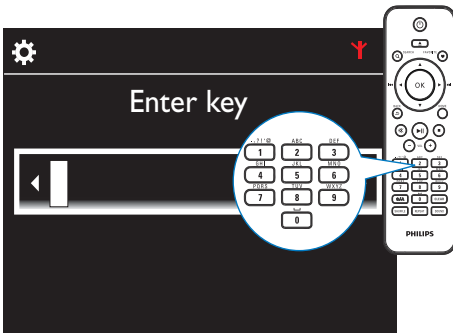

**Note**

- The router may fail to assign an IP address, if the DHCP (Dynamic Host Configuration Protocol) is unavailable or disabled on the router.

### Wired connection



Connect to the router by using the Ethernet cable

- 1 Select **[Yes]**, when asked whether to set up network connection (see 'First-time setup' on page 17).
- 2 Use an Ethernet cable to connect the unit to the router.

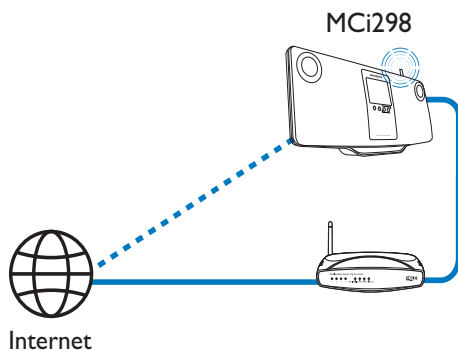
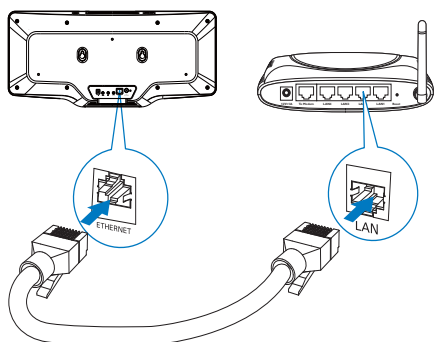

### Connect to the home network

- On the unit, select **[Wired (Ethernet)]**.
  - ↳ The unit starts to acquire an IP address assigned by the network automatically.
  - ↳ A message appears when the connection is completed successfully.

### \* Tip

- Ensure that the router connects to the Internet directly and no dial-up is required on the computer.

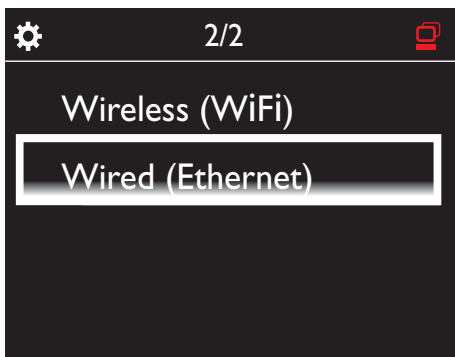

### \* Tip

- The router may fail to assign an IP address, if the DHCP (Dynamic Host Configuration Protocol) is unavailable or disabled on the router.

### Connect to the Internet

- Connect to the Internet as prompted.
  - ↳ You enter Home screen after the first-time setup is complete.

## 6 Play from home Wi-Fi/wired network

### Play Internet radio stations

To play Internet radio stations, ensure that

- **MCi298** is connected to the Internet over the home network.

#### Tip

- Ensure that the router connects to the Internet directly and no dial-up is required on the computer.

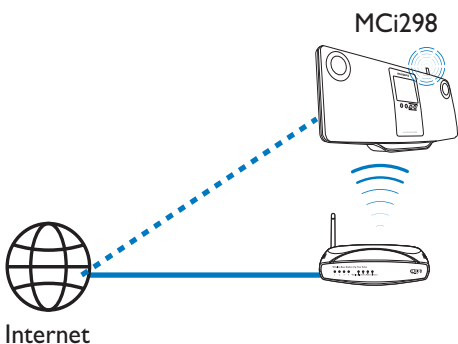

### Tune to Internet radio stations

- 1 Ensure that MCi298 is connected to the Internet.
- 2 On MCi298, tap **[Internet Radio]** on Home screen.
  - Or, on Home screen, press ◀▶ and **OK** on the remote control.
- 3 Select the desired station to start play.

#### Tip

- By default, preset stations are pre-loaded to MCi298 according to the location that you select during the first-time setup. To check or change the location, go to **[Settings]** > **[Location and time zone]**.

### Store preset stations

On **MCi298**, you can store up to 10 preset stations. Each preset station corresponds to a numeric button on the remote control. On the radio play screen, press a numeric button, you quickly switch to the corresponding preset station.

By default, preset stations are pre-loaded to **MCi298** according to the location that you select during the first-time setup. To check or change the location, go to **[Settings]** > **[Location and time zone]**.

#### To store preset station

- 1 Play the desired station.
- 2 On the play screen, press and hold the desired numeric button (0-9).
  - ↳ A message appears, indicating that the station is added to the corresponding location.
  - ↳ The new preset replaces the old one if the location has been filled.

#### To play a preset station

- Go to **[Internet Radio]** > **[Presets]**.
- Or, on the radio play screen, press the corresponding numeric button (0-9).

### Edit favorite stations

On MCi298, you can mark an Internet radio station as favorite. All the stations are added to **[Internet Radio]** > **[Favorite stations]**. In this way, you can quickly access your favorite stations.

### To add a station to [Favorite stations]

- On a list of stations, select the desired station. Press **FAVORITE** on the remote control.
- Or, play the desired station. On the play screen, press **FAVORITE** on the remote control.
  - ↳ A message appears, indicating that the station is added to **[Favorite stations]**.

### To remove a station from [Favorite stations]

- Select the station in the list of stations; or, go to the play screen of the station. Press **FAVORITE** again.

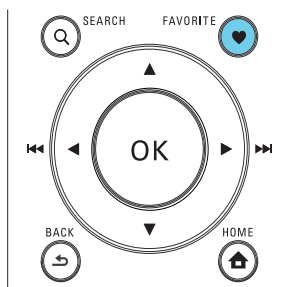

## Manage Internet radio online

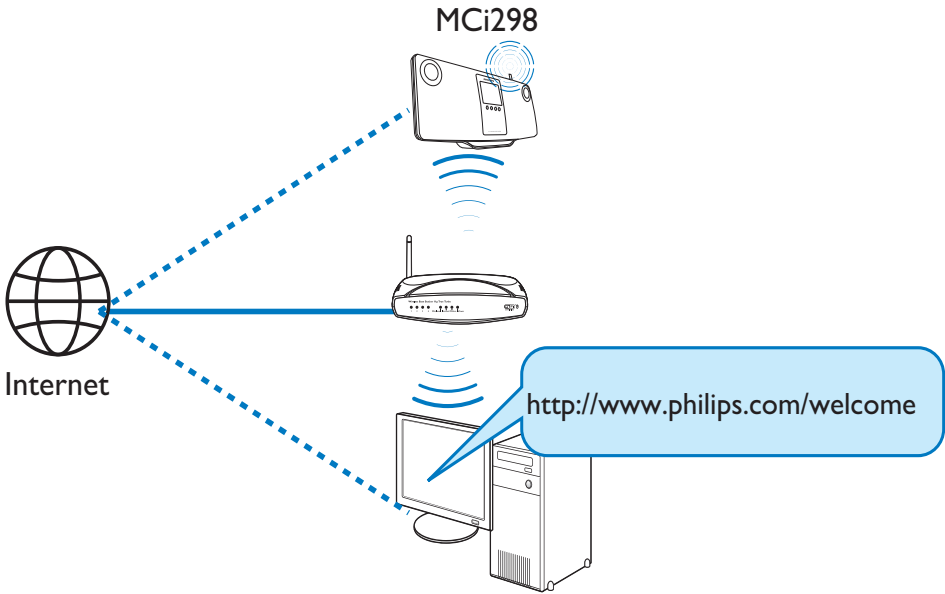

By registering MCI298 on [www.philips.com/welcome](http://www.philips.com/welcome) (see 'Register MCI298 with Philips' on page 39), you can log in to Club Philips. On Club Philips, you can do the following to manage the Internet Radio on a computer:

- Edit favorite stations;
- Manually add stations that you are unable to find on MCI298.

### Edit favorite stations online

Through Club Philips, you can manage the list of favorite stations on a computer. When connecting MCI298 to the Internet, you update the favorite stations on MCI298.

- 1 On a computer, log in to Club Philips (see 'Register MCI298 with Philips' on page 39).
- 2 To mark/unmark stations as favorite:
  - Click [Streamium management] > [Favorites] > [Browse];

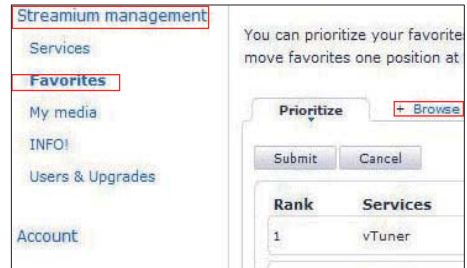

- In [Browse], find the desired stations;





- Under [Favorite], check the box corresponding to the station.  
↳ The station is marked as favorite.
- To unmark, uncheck the box corresponding to a station.



3 To change the order of favorite stations in the list:

- Click [Prioritize];
- Click on the row of the station to be moved;
- Drag and drop the row upward or downward.



- ↳ On MCI298, you can find the stations in the desired order under [Internet Radio] > [Favorite stations], if you have connected MCI298 to the Internet.

## Tip

- In the list of favorite stations, to put a favorite station ahead of the first one, make the station just behind the first one; drag and drop the first station downward.
- To put a station behind the last one, make the station just ahead of the last one; drag and drop the last station upward.

## Manually add stations online

### Manually add stations

Through Club Philips, you can manually add Internet radio stations to MCI298 on a computer.

- 1 On a computer, log in to Club Philips (see 'Register MCI298 with Philips' on page 39).
- 2 To add a station, click [Streamium management] > [My media] > [Music].



- 3 In [Music], enter station information in the text boxes:
  - In [URL], fill in the web site of the station;
  - In [Nickname], fill in a name that appears as station name in [My media];
  - In [Description], fill in one-word description about the station, e.g. music, sports, new. The description is used as a category to sort stations under [My media].

- 4 Click [Save].  
↳ A station is manually added the below the edit boxes.

#### To edit an added station



The screenshot shows a music station editing interface. At the top, there are two tabs: "Music" and "+ Capabilities". Below the tabs, there are four text input fields, each with a red box around it: "\* URL" (containing "http://www.city"), "\* Nickname" (containing "City FM"), "Mimetype" (containing "audio/x-pn-real"), and "\* Description" (containing "Music"). Below these fields is a "Mark as favorite" checkbox, which is checked. Below the form, there is a section titled "Click a stream to select and edit" followed by a table with two columns: "NICKNAME" and "MIMETYPE". The table has one row with a red box around the first cell, which contains "+ City FM".

NICKNAME	MIMETYPE
+ City FM	audio/x-pn-real

- As shown, click the station.  
↳ The text boxes are filled, showing the information about the station.
- Click on the text boxes to edit the information.

## Stream from a UPnP server

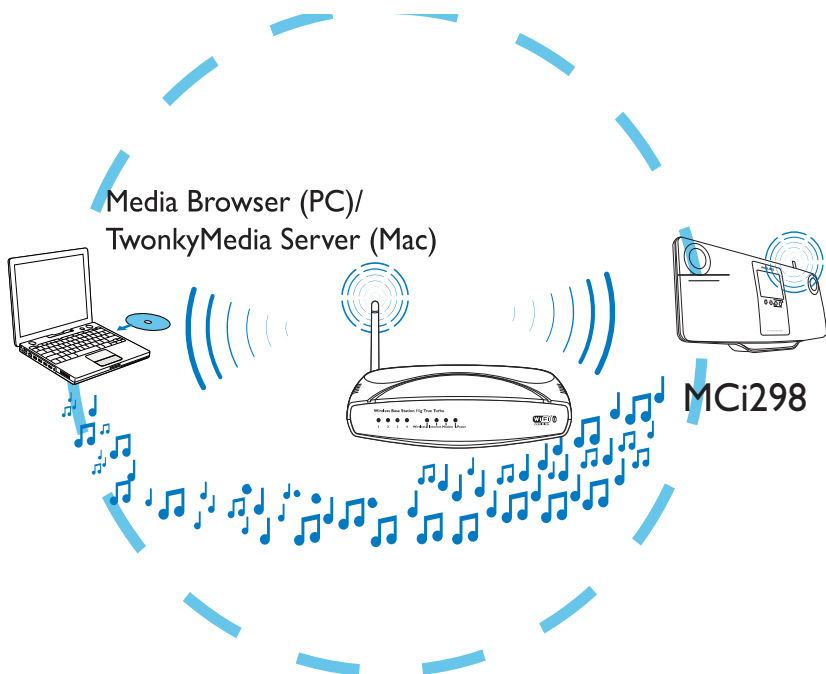

You can stream music from computers or Network-attached storage(NAS) to **MCI298**, when

- **MCI298** is connected to home network;
- Music sharing is set up on the computers that are also connected to the home network, if you want to stream music from the computers;
- The NAS is connected to the home network and can work as \*UPnP media server, if you want to stream music from the NAS.

With the music sharing software (the supplied **Media Browser** and **TwonkyMedia Server**), such computers can work as UPnP media

servers (music libraries) of **MCI298**, if they are turned on.

Through the UPnP (Universal Plug and Play) protocols, a UPnP media server allows music files to be streamed from the server to a UPnP client device (e.g. MCI298). On the UPnP client device, you can play the music from the server.

### Note

- \*Consult the user manual of the NAS to learn if the capability of UPnP media server is available in the NAS.

## On computers: Set up music sharing



### Media Browser (PC)/ TwonkyMedia Server (Mac)

- 1 On the computer, insert the supplied software CD.
- 2 Install the software by following screen instructions.
  - **Media Browser** (on a PC)
  - **TwonkyMedia Server** (on a MAC)
    - ↳ Now, the computer can work as a music server. You can stream music from the computer to a UPnP device on the home Wi-Fi/wired network.

## Library on the computer or NAS

### Library on the computer

On the computers, the supplied software **Media Browser** or **TwonkyMedia Server** can access music libraries that are organized by different media management software, including **Windows Media Player 11** and **iTunes**.

**iTunes** is the a trademark of Apple Inc., registered in the U.S. and other countries.

### Library on the NAS

Consult the user manual of the NAS to learn:

- if the capability of UPnP media server is available on the NAS;
- how to manage music on the NAS by using such UPnP media server software.

## Stream from the computer or NAS

On MCI298, play music libraries that are streamed from a UPnP server (a computer on the home network).

- 1 Ensure that the UPnP server is connected to the home network.
- 2 On MCI298, tap **[Media Library]** on Home screen.
  - Or, on Home screen, press ◀▶ and **OK** on the remote control.
- 3 Select a music library.
  - ↳ You can see the categories by which the music are sorted (e.g. Artist, Album, Genre).
- 4 Select your desired track or album.
- 5 Press ▶|| to start play.
  - Play starts from the beginning of the album, if you press ▶|| on an album.
    - ↳ Play screen appears when play starts.
- 6 To stop play, press ■.

Use the touch screen to select options



On the list of options,

- Tap on the screen to show functional buttons;

- Select options by tapping on corresponding buttons:
  - ▲: Tap to scroll upward;
  - ▼: Tap to scroll downward;
  - ↶: Tap to go back to previous screen.
- Tap on an option to select.

### Use the touch screen during music play

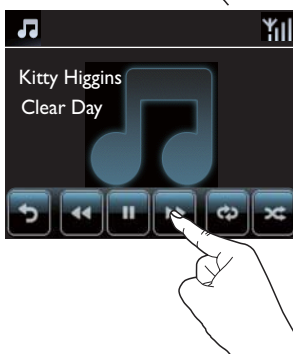

On the music play screen,

- Tap on the screen to show functional buttons;
- Select play options by tapping on corresponding buttons:

⏸: Tap to pause or play current song;

⏮⏭: Tap for fast forwarding/rewinding within current song;

🔄: Tap to play all songs in current folder repeatedly;

🎲: Tap to play all songs in current folder randomly.

↶: Tap to return to the previous screen.

# 7 Play from a USB mass storage device

---

## Connect a USB mass storage device



On **MCi298**, you can play music stored on a USB mass storage device. To do so, do the following:

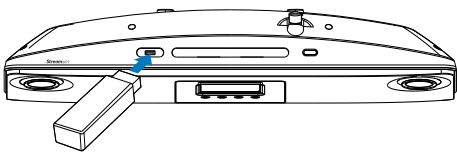

- Connect the USB mass storage device to the  socket on **MCi298**;
- Tap on **[USB]** on the Home screen of **MCi298**.



---

## Play from the USB mass storage device

- 1 On **MCi298**, ensure that the USB mass storage device is properly connected.
- 2 On Home screen, tap on **[USB]**.
  - Or, on Home screen, press   and **OK** on remote control.
    - ↳ The file sorting process may take some time. During file sorting, the file folders are displayed.
    - ↳ Audio files are displayed under different categories (e.g. Artist, Album, Genre), if meta/ID3 tags are edited for the files.

- 3 Select your desired track or album.
- 4 To start play, press .
  - Play starts from the beginning of the album, if you press  on an album.
    - ↳ Play screen appears when play starts.
- 5 To stop play, press .

# 8 Play music CDs

## ! Caution

- Never look at the laser beam inside the unit.
- Risk of product damage! Never play discs with accessories such as disc stabilizer rings or disc treatment sheets.
- Never put any objects other than discs into the disc compartment.

## ☰ Note

- For the supported disc formats, see Introduction (see 'Introduction' on page 8).

## Basic operations

- As shown, slot in a disc.
  - If necessary, press ▲ to remove a disc first.
  - If necessary, tap on **[Disc]** on Home screen.
    - ↳ List of tracks or file folders appears after disc reading is complete.

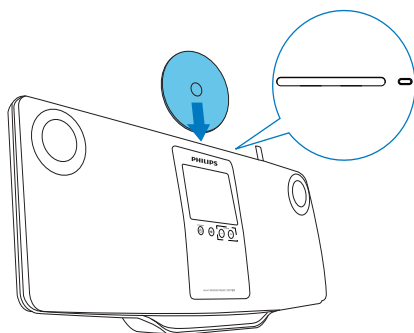

- Press ►► to start play.
- During disc play,

- Press ◀◀▶▶ repeatedly to select a track. For WMA/MP3 files on a CD-R/RW, press ▲▼ to select a file folder.
- Press ◀▶ to search forward/backward.
- Press ►► to pause or resume.
- Press ■ to stop.

## Use the touch screen

### Use the touch screen to select options

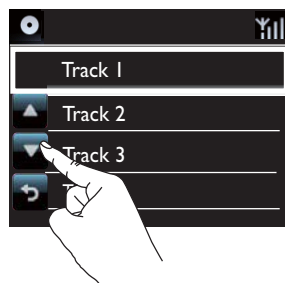
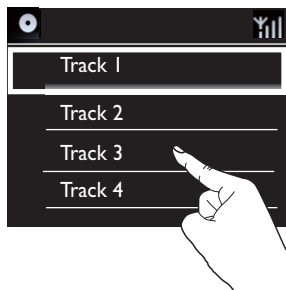

### On the list of options,

- Tap on the screen to show functional buttons;
- Select options by tapping on corresponding buttons:
  - ▲: Tap to scroll upward;
  - ▼: Tap to scroll downward;
  - ↶: Tap to go back to previous screen.
- Tap on an option to select.

## Use the touch screen during CD play



On the CD play screen,

- Tap on the screen to show functional buttons;
- Select play options by tapping on corresponding buttons:

**|| / ▶**: Tap to pause or play current song;

**◀◀ / ▶▶**: Tap to select previous/next song;

**↔**: Tap to play all songs in current folder randomly;

**↺**: Tap to play all songs in current folder repeatedly;

**↶**: Tap to return to the previous screen.



## 9 Play FM radio

### Tune to FM radio stations

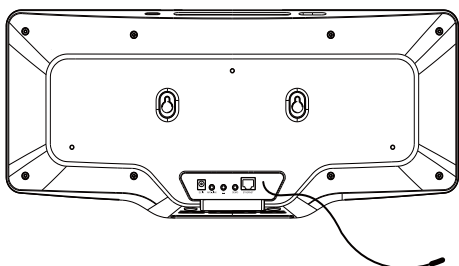

#### Note

- For optimal reception, fully extend and adjust the position of the antenna.

### Autostore

- 1 On MCI298, tap **[FM radio]** on Home screen.
  - Or, on Home screen, press ◀▶ and **OK** on the remote control.
- 2 In **[FM radio]**, select **[Auto store]**.
  - ↳ MCI298 starts to search for available stations automatically.
  - ↳ Radio play starts and a maximum of 20 stations are stored as presets when the auto tune is complete.
  - ↳ The preset stations are listed in the order of reception strength.
- 3 To select a preset station, go to **[Presets]**.

### Manual tuning

- 1 In **[FM radio]**, select **[Manual tuning]**.
- 2 Press and hold ◀▶ to start auto tuning.
  - ↳ You tune to the next available station with sufficient reception.
- 3 Press ◀▶ repeatedly for fine tuning.

### Edit preset stations

#### Edit station information

- 1 In the **FM RADIO** mode, press **FAVORITE** on the radio play screen.
- 2 In the list of preset stations,
  - Select the station to be edited;
  - Press **a/A** to start editing;
  - Press ◀▶ to select the entry location; press ▲▼ repeatedly to select desired letters.
- 3 Press **OK** to confirm. Press **BACK** to discard the changes.

### Listen to FM radio

- 1 On MCI298, tap **[FM radio]** on Home screen.
- 2 Tune to your desired station (see 'Tune to FM radio stations' on page 33).
  - **To select a preset station:** press **FAVORITE** during radio play.
- 3 To mute/unmute the radio play
  - Press **⊗**.

### RDS (Radio Data System)

RDS (Radio Data System) is a service that allows FM stations to show additional information.

When tuning to an RDS station, you can see the following information on the screen:

- Station name;
- Scrolling text (RDS text), if available.

# 10 Play from an external audio device

MCI298 allows you to play an external audio device (e.g. a portable media player; another audio system) through the speakers of MCI298.

## Connect external audio devices

You can listen to an external audio device through the speakers on **MCI298**. To do so, do the following connections, and then, select the **[MP3 link]** mode on **MCI298**.

### To play from a portable media player with 3.5mm headphone jack

Connect a headphone-to-headphone cable (not supplied) to:

- the **MP3-LINK** socket on this unit, and
- the 3.5mm headphone jack on the portable media player.

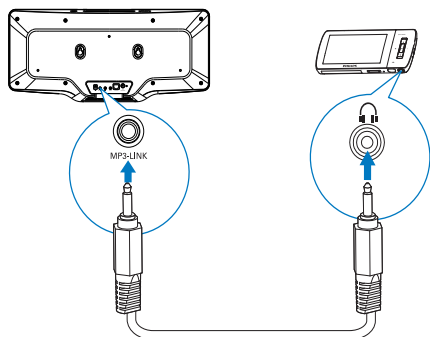

## Play from an external audio device

- 1 Ensure that the external audio device is properly connected to MCI298.
- 2 On MCI298, select the **[MP3 link]** mode.
  - On Home screen, tap **[MP3 link]**.
- 3 On the external audio device, start music play.
  - For the music play, you can use the sound settings on MCI298 (see 'Sound settings' on page 35).

# 11 Settings

## Sound settings

On MCI298, you can select different sound settings in **[Settings]** > **[Sound settings]**.

- 1 From Home screen, go to **[Settings]** > **[Sound settings]**.
- 2 Select the option. Press **OK** to turn it on or off.
  - Or, tap on the check box to select/deselect.

Or,

On the remote control, press **SOUND** to enter the menu of sound settings.

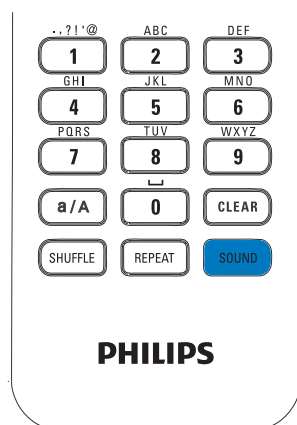

## Dynamic Bass Boost

**[Dynamic Bass Boost]** electronically enhances the low tones.

Turn on or off **[Dynamic Bass Boost]** in **[Settings]** > **[Sound settings]**.

## Equalizer

**[Equalizer]** provides predefined sound settings for different music styles.

- In **[Settings]** > **[Sound settings]** > **[Equalizer]**, Select the equalizer settings: **[Rock]**, **[Pop]**, **[Jazz]**.

## Set the volume from the external audio device

With **[MP3 link volume]**, you can set the volume from a connected portable media player on MCI298.

- In **[Settings]** > **[Sound settings]** > **[MP3 link volume]**, select the desired volume level.

## Incredible Surround

Incredible Surround allows you to experience total surround with greater depth and width of sound, without the use of additional speakers.

- In **[Settings]** > **[Sound settings]** > **[Incredible Surround]**, turn it on or off.

## Display settings

### Brightness

On MCI298, you can adjust the brightness of the display. As desired, the display lights up, dims or turns off when MCI298 is turned on or switched to active standby.

- In **[Settings]** > **[Display settings]** > **[Brightness when on]** or **[Brightness when standby]**, select an option and press **OK**.

## Clock settings

### Alarm

Set the alarm

- 1 Ensure that you have set the clock (see 'Date and time' on page 36).

2 From Home screen, go to **[Settings]** > **[Clock settings]** > **[Alarm]**.

- 3 To set the alarm time,
- Press and hold ▲/▼, or press ▲/▼ repeatedly until you reach the desired digits. Press ◀/▶ to select the entry location. Press **OK** to confirm.
  - Or, enter the desired digits by pressing the numeric buttons.
    - ↳ The alarm icon 📌 appears on the screen.

### Use the alarm

At the set alarm time, the buzzer sounds.

#### Note

- The alarm sounds even if you have switched MCI298 to active standby or Eco standby.
- MCI298 is unmuted if it has been muted.
- The alarm sounds in a higher volume if the volume level is lower than minimum.

### To snooze the alarm

- Press any button on the unit or the remote control (except for the volume buttons).
  - ↳ The alarm sounds again 15 minutes later. The alarm icon remains.

### To stop the alarm

- Press and hold 📌 or ⏸.
  - ↳ The alarm is stopped. The alarm icon disappears.
  - ↳ The alarm sounds again next day.

### To turn off the alarm

- Go to **[Settings]** > **[Clock settings]** > **[Alarm]**. Select **[Alarm off]** and tap on **OK**.

## Date and time

The date and time can be set automatically or manually.

### Automatic setting

For automatic clock setting, use the online service over the Internet, or use the time signal from FM RDS radio.

### Through the online service over the Internet

- 1 Turn on the unit, if necessary.
  - Ensure that the unit is connected to the home network and Internet.
- 2 From Home screen, select **[Settings]** > **[Clock settings]** > **[Date and time]**.
- 3 In **[Date and time]**, select **[Current date and time]** > **[Automatic (Internet)]**.
  - ↳ The unit starts auto time setting over the Internet.
  - ↳ A message appears when the setting is done.

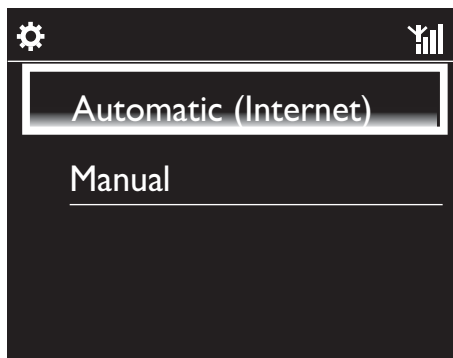

#### Tip

- According to the location and time zone you select, the unit can have the clock time set and adjusted automatically through the online service over the Internet.
- To check and change current location and time zone, go to **[Settings]** > **[Location and time zone]**.

## Manual setting

- 1 Turn on the unit, if necessary.
- 2 From Home screen, select **[Settings]** > **[Clock settings]** > **[Date and time]**.
- 3 In **[Date and time]**, select **[Current date and time]** > **[Manual]**.
- 4 To enter date and time,
  - Press ◀ or ▶ to select the entry location;
  - Enter the desired digits by pressing the numeric buttons;
  - Tap on **OK** to confirm.
  - You can also press ▲ or ▼ repeatedly, or press and hold ▲ or ▼ until the desired digit appears.

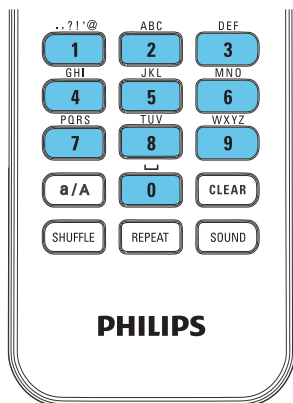

## Set date/time format

Select how date and time are displayed in the clock.

- 1 Follow Step 1-2 under "Manual setting".
- 2 In **[Date and time]**, go to **[Time format]** or **[Date format]** to select options.

## Network settings

### Setup network

After the first-time setup, you can change how **MCi298** connects to home network:

- Switch between different connection methods (wireless or wired, automatic or manual);
- Switch between different routers. To do so, do the following:

- 1 From Home screen, go to **[Settings]** > **[Network settings]** > **[Setup network]**.
- 2 Connect **MCi298** as you did in the first-time setup (see 'Connect to home network' on page 17).

### Location and time zone

After the first-time setup, you can change the selected location and time zone when moving to a new location or time zone.

According to the selected location and time zone, **MCi298** can

- Set clock automatically over the Internet (see 'Date and time' on page 36);
- Pre-load preset Internet radio stations automatically.

### Language

After the first-time setup, you can change the language selection in **[Settings]** > **[Language]**.

---

## Device information

From the home screen, go to **[Settings]** > **[Information]**. You can learn about information about MCI298, including model number, name to be shown on a UPnP server/client, product registration ID, software version and network settings.

---

## Check for software upgrades

On MCI298, you can check for software upgrades online.

- 1 Ensure that the MCI298 is connected to the Internet.
- 2 From Home screen, go to **[Settings]** > **[Check for software upgrades]** > **[Check Online]**.
  - ↳ After you agree to the terms and conditions, the downloading and installation of new upgrades start automatically.



Tip

- The **[Settings]** > **[Check for software upgrades]** > **[Check USB device]** is for the use of Philips service centers.

---

## Restore factory settings

You can restore MCI298 to factory settings. The factory settings are restored and your own settings are cleared, including the settings of network, sound, display, clock, alarm and language.

- 1 Go to **[Settings]** > **[Restore factory settings]**.
- 2 As prompted, select **[Yes]**.
  - ↳ The unit is turned off.
  - ↳ The unit is turned on again automatically when the factory settings are restored.
  - ↳ Start the first-time setup.

# 12 Register MCI298 with Philips

## Benefits

By registering MCI298 on [www.philips.com/welcome](http://www.philips.com/welcome), you can

- Manage your own favorite radio stations;
- Receive Streamium newsletters.

### Note

- Registration of **MCI298** requires a valid email address.

## Register MCI298

Use a valid email address as the account when you register MCI298 on [www.philips.com/welcome](http://www.philips.com/welcome).

You can complete the registration directly on [www.philips.com/welcome](http://www.philips.com/welcome). Or, use an email address to register on the device, and then, complete the registration through the web site link that you received in the email.

### Register on the web site

To register MCI298 directly on [www.philips.com/welcome](http://www.philips.com/welcome), you need to fill in the following information as prompted during registration:

- A valid email address as the registration account;
- Product model number;
- Product registration ID.

### To get the product model number

- Look at the packaging box of the device or the product label. You can always find the model number on

the packaging box or product label (e.g. MCI298).



### To get the product registration ID

- On MCI298, go to **[Settings]** > **[Information]**. Press ▼ repeatedly to find **[Product Registration ID]**.

## Register on the device

Use an email address to register on the device, and then, complete the registration through the web site link that you received in the email.

- 1 Ensure that MCI298 is connected to the Internet.
- 2 To register with [www.philips.com/welcome](http://www.philips.com/welcome),
  - On MCI298, select **[Settings]** > **[User registration]** > **[Register now]** > **[Register on the device]**;
  - As prompted, enter your valid email address.
    - ↳ You receive an email message from [ConsumerCare@Philips.com](mailto:ConsumerCare@Philips.com).
  - On a computer, use the web site link in the email to complete registration.

### Tip

- To log in to Philips online services later, use the web site link in the email, and the password.

---

## Unregister MCI298

When registering with [www.philips.com/welcome](http://www.philips.com/welcome), you can only use one account for one unit (e.g. MCI298). For each account, you can maintain a set of favorite stations and manually added stations.

To use another account for registration, you need to unregister current one.

### To unregister an account

- 1 On MCI298, select **[Settings]** > **[User registration]** > **[Unregister]**.
- 2 As prompted, confirm to start unregistering the account.



### Tip

- When re-registering the account, you can recover the Internet radio stations that you maintained with Club Philips.

---

## Check registration information

You can check whether you have registered the MCI298, and what account you have used for registration. To check the information, go to **[Settings]** > **[User registration]** > **[Registration status]**.



# 13 Maintenance

This chapter tells you how to care for MCI298.

---

## Cleaning



### Note

- Avoid moisture and abrasion.

- 1 Clean MCI298 only with a soft dry cloth.

# 14 Technical data

## General

### AC Power (AC-DC power adapter)

100V~240V 50Hz/60Hz (for /12, /05 /79)

### Dimensions

Main unit: 542.2 × 105.2 × 236.7mm

### Weight (net)

3.25kg ± 0.1kg

## Power consumption

### Active (On)

< 40W (according to IEC60065)

### (Active) Standby

< 15W

### ECO (Passive) Standby

< 1W

## Audio inputs

### MP3 link input

1 × 3.5mm jack

### Input sensitivity

1.0V

### Input impedance

> 10kΩ (Ohms)

## Audio outputs

### Headphones

1 × 3.5mm jack, 30 – 18000Hz, 16 - 150Ω (Ohms)

### Signal to noise ratio (Headphones)

typically 75dBA (IEC)

### Distortion (Headphones)

< 0.10%

## Audio amplifier (Digital)

### Output power

2 × 10W (RMS) (= total power 20W)

### Frequency response

50Hz to 18000Hz (±3dB)

### Signal to noise ratio

typically 72dBA

## Speakers

### Power handling

10W (RMS)

### Impedance

4Ω (Ohms)

### Sensitivity

86dB/ 1m/ W

### Dimensions

3 inches

### Frequency response

110 to 17000Hz

## Sound features

### DSC

Yes (Jazz, Rock, Flat, Pop)

### Bass/ Treble control

+/- 6 steps

### DBB

Yes (on/ off)

### Incredible Sound

Yes (on/ off)

## Wireless

### Wireless standard

802.11b/ g

### Wireless security

WEP (64 or 128 bit),  
WPA / WPA2 (8-63 characters)

### Frequency range

2412 - 2462 MHz (CH1-CH11) (for /79, /37,  
/55, /97)  
2412 - 2472 MHz (CH1-CH13) (for /12, /05)

### Antenna

1 x internal / 1 x external, diversity mode  
enabled

### Wireless protected setup (WPS)

Yes (PBC + PIN)

### Network mode support

Infrastructure

## Wired (LAN / Ethernet)

### Wired standard

802.3 / 802.3 u

### Speed

10 / 100MBit/s

### Mode

half / full duplex

### Crossover detection (Auto MDIX)

Yes



### Note

- The wired and wireless network interfaces cannot be turned on at the same time.

## Internet services

### Internet radio

My Media

## Decoding capabilities (excluding the disc player)

### MP3

8 - 320kbps (CBR / VBR)

### WMA

32 - 192kbps (CBR / VBR)

### AAC (M4A)

16 - 320kbps (CBR / VBR)

### PCM/ WAV

1x (1.4Mbps)

## Playlist support (excluding the disc player)

\*.m3u, \*.wpl

Yes

## FM Tuner

### Frequency range

87.50 to 108.00MHz

### No. of Presets

20

### Signal noise ratio

≥ 50dB

### Tuning grid

50kHz

### RDS

Yes, no RDS clock setting

### Antenna connector

IEC (75 Ohm)

## DISC player

### Supported discs

CD, CD-R, CD-RW, MP3-CD, WMA-CD

### Disc size support

8cm/ 12cm

### Audio decoding

MP3: 112 to 320kbps (Sampling rate: 32, 44.1, 48kHz)

WMA: 48 to 192kbps (Sampling rate: 44.1, 48kHz)

## USB

---

### USB port type

Type A, Host

---

### Supported media

FAT, FAT-32

---

### Supported class

MSC only (no MTP support)

---

### Multi-partition support

No, only first readable partition

---

### Database support

Up to 1000 songs

---

## Display/Clock

---

### Resolution

320 x 240 dots (QVGA), Color TFT

---

### Size

3.5 inches

---

### Backlight

Can be turned on/ off and can be dimmed

---

### Touch screen

Yes

---

### Clock/ Date display

Yes

---

### Automatic time setting via Internet (NTP)

Yes,

---

### Sleep timer enabled

Yes

---

### Internal (key) clicker

Yes

---

## Others

---

### UPnP

DMP (Local Renderer, Local Controlpoint)

---

### DLNA

Yes

---

### Shared drive

No

---



### Note

- Specifications and external appearance are subject to changes without notice.

# 15 Troubleshooting

**I cannot hear any sound or the sound is poor, what do I do?**

- Press + **VOL -** to increase the volume.
- Press the **MUTE** button again to reactivate the sound output.

**Is there a maximum distance of transmission between a wireless router and MCI298 for effective streaming?**

Yes. The maximum distance of Wi-Fi transmission is 250m measured in open spaces. However, in a home environment, where solid obstacles such as walls and doors are present, the effective transmission distance is reduced to 50-100m. Reposition the devices if you experience transmission problems.

**I have not received any registration email from ConsumerCare@Philips.com.**

- Check that the email address that is entered in the user registration section is valid and spelled correctly.
- Check that the PC has an active Internet connection.
- The Internet server may be busy, try again later.
- Check if the email was redirected to the spam folder.

**How do I avoid Wi-Fi interferences from other devices that operate in the same (2.4GHz) frequency spectrum, such as Dect phones or bluetooth devices?**

- Move MCI298 at least 3m away from such devices.
- Use a WEP/WPA encryption key when you create the wireless connection your PC / home network.
- Change the operating channel on the interfering devices.
- Turn the devices in different directions to minimize interference.

# Streamium terms and conditions

## **Terms and Conditions of Use of your Philips Streamium-enabled Device**

Congratulations on your purchase of a Philips Streamium-enabled Device ("Device"). These Terms and Conditions of Use give you the rights to use certain features on your Device relating to the streaming of content. You must agree to these Terms and Conditions of Use before using the Device. Your use of the Device constitutes your agreement to be bound by these Terms and Conditions of Use and will give you the right to access these features. If you do not agree to these Terms and Conditions of Use, you may return your Device to the point of purchase. These Terms and Conditions of Use supplement, and do not replace, any terms, conditions or disclaimers which were provided with your purchase of the Device. All such terms, conditions and disclaimers remain in full force and effect.

## **Eligibility for Registration.**

You must be at least 14 years of age to assume the responsibilities of these Terms and Conditions of Use. If you are under 14 years of age, you may not use the Device unless one of your parents or legal guardians assumes the responsibilities of these Terms and Conditions of Use. Your use of the Device constitutes your representation that you are either 14 years of age or, if you are under 14 years of age, that your parent or legal guardian has assumed the responsibilities of these Terms and Conditions of Use.

## **Restrictions on Modification of your Device**

Your Device provides access to certain streams of content. As a condition of obtaining access to those streams through the Device, you agree not to tamper with or otherwise modify or attempt to modify the Device in any way (including through the use of software or by making physical alterations to the Device). You agree that you will not circumvent or attempt to circumvent technological measures employed to control access to, or the rights in, any content. You agree that you will not circumvent or attempt to circumvent any copy management system by any means. You agree that you will not decipher or attempt to decipher cryptographic keys or otherwise defeat or attempt to defeat any security features implemented in the Device or in the content streams. You agree that you will not use the Device for any unauthorized purpose or in contravention of any law or regulation.

## **Disclaimers Regarding Content**

The streams of content which are accessible through your Device are not controlled or programmed by Philips. Rather, they are provided by third parties. Think of your Device (in addition to its other features) as a form of "tuner" which allows you to receive the content broadcast by many others outside of your local area. Since the content is provided by others, PHILIPS HAS NO EDITORIAL CONTROL OVER ANY OF THAT CONTENT RECEIVED THROUGH YOUR DEVICE AND, THEREFORE IS NOT LIABLE FOR CONTENT OR ITS NATURE OR DELIVERY. PHILIPS DOES NOT ENDORSE ANY OPINIONS EXPRESSED IN ANY CONTENT RECEIVED THROUGH YOUR DEVICE. PHILIPS DOES NOT GUARANTEE THE TRUTHFULNESS, ACCURACY, RELIABILITY, COMPLETENESS OR TIMELINESS OF CONTENT. YOU AGREE THAT ANY RELIANCE ON CONTENT IS AT YOUR OWN RISK.

## **Limitations on Access to Streams.**

Philips does not guarantee access to any particular stream or to the content contained in any stream. Philips may, in its discretion, add or remove access to any specific stream or content at any time. Some streams are accessible through arrangements with online service providers which determine which streams are listed on their directories. Although Philips will strive to provide a good selection of online service providers, Philips does not guarantee continued access to any specific online service provider. Philips may, in its discretion, add or remove access to any specific online service provider.

## **Rights in Content**

Content may be protected by copyright laws or other intellectual property or proprietary laws. In some situations, such as use of the Device in a commercial environment, it may be necessary for you to obtain, at your own risk, a license or other authorization to use such content. You agree that, in the event such a license or

authorization is necessary, it is your responsibility to obtain any such license or authorization. You agree that you are solely liable for any damages you may incur resulting from your failure to obtain the proper license or authorization for use of the content accessible through the Device. You agree that Philips will have no liability to you with regard to your use of the content.

### **Changes in Features**

Philips may, in its discretion, change the features of the Device, including adding features to, or removing features from, the Device. Some new features may require changes to these Terms and Conditions of Use. Your use of those new features will constitute your agreement to the revised Terms and Conditions of Use.

### **Software and Intellectual Property Rights**

You may need to use certain software programs to use or have full access to certain features of the Device. You received certain software with the purchase of the Device and may receive other software from time to time in the future. Most of that software is contained in the Device and is not accessible to you. Some of that software is owned by Philips and some is owned by others. Your use of software owned by Philips is subject to these Terms and Conditions of Use and any applicable license agreement. Your use of software owned by others is governed by their applicable license agreements. Your use of software does not transfer any title or ownership rights in the software to you. Philips retains all its rights in software and other intellectual property, including copyrights, patent rights, and rights in its trademarks and trade names. You agree that you will not disassemble, decompile, create derivative works of, reverse engineer, modify, sublicense, distribute the software or use the software for any unauthorized purpose or in contravention of any law or regulation.

### **Warranty Disclaimer**

PHILIPS MAKES NO REPRESENTATION OR WARRANTY, EXPRESS OR IMPLIED, THAT THE DEVICE WILL MEET YOUR REQUIREMENTS OR THAT THE USE OF THE DEVICE WILL BE UNINTERRUPTED, TIMELY, SECURE OR FREE FROM ERRORS. PHILIPS MAKES NO WARRANTY AS TO THE CONTENT CARRIED IN ANY STREAM. PHILIPS MAKES NO REPRESENTATION OR WARRANTY, EXPRESS OR IMPLIED, AS TO THE INFORMATION OR CONTENT ACCESSED THROUGH YOUR DEVICE OR TO YOUR RELIANCE ON, OR USE OF, ANY INFORMATION OR CONTENT ACCESSED THROUGH YOUR DEVICE. SPECIFIC WARRANTIES WERE PROVIDED WITH YOUR PURCHASE OF YOUR DEVICE AND THOSE WARRANTIES, INCLUDING ANY DISCLAIMERS TO THOSE WARRANTIES, CONTINUE TO APPLY. Because some jurisdictions do not permit the disclaimer of implied warranties, such disclaimers may not apply to you.

### **Limitation of Liability**

PHILIPS WILL NOT BE LIABLE TO YOU OR TO ANY OTHER PARTY FOR ANY INDIRECT, INCIDENTAL, PUNITIVE, SPECIAL OR CONSEQUENTIAL DAMAGES (INCLUDING LOST PROFITS OR LOST SAVINGS) OR FOR LOSS OF DATA OR BUSINESS INTERRUPTION ARISING OUT OF OR RELATING TO YOUR USE OF THE DEVICE WHETHER OR NOT SUCH DAMAGES ARE BASED ON TORT, WARRANTY, CONTRACT OR ANY OTHER LEGAL THEORY - EVEN IF PHILIPS HAS BEEN ADVISED, OR IS AWARE, OF THE POSSIBILITY OF SUCH DAMAGES. IN NO EVENT WILL PHILIPS CUMULATIVE LIABILITY FOR DAMAGE (FROM ANY CAUSE WHATSOEVER) EXCEED THE AMOUNT YOU PAID FOR YOUR DEVICE.

### **Miscellaneous**

“This agreement will be governed by the laws of the jurisdiction in which the Device was sold and you hereby consent to the non-exclusive jurisdiction of courts in the relevant country. If any provision of this agreement is invalid or unenforceable under applicable law, such provision will be deemed modified to the extent necessary to render such provision valid and enforceable and the other provisions of this agreement will remain in full force and effect. These Terms and Conditions of Use will not be governed by the United Nations Convention of Contracts for the International Sale of Goods, the application of which is hereby expressly waived.”

BY USING YOUR DEVICE, YOU REPRESENT THAT YOU HAVE READ AND UNDERSTOOD THESE TERMS AND CONDITIONS OF USE AND THAT YOU ACCEPT THEM.

# NOTICE

## SOFTWARE END USER LICENSE AGREEMENT

THIS SOFTWARE END USER LICENSE AGREEMENT ("THIS AGREEMENT") IS A LEGAL AND BINDING AGREEMENT BETWEEN YOU (EITHER AN INDIVIDUAL OR ENTITY) AND PHILIPS CONSUMER ELECTRONICS B.V.A DUTCH LIMITED LIABILITY COMPANY, WITH ITS PRINCIPAL OFFICE AT GLASLAAN 2, 5616 LW EINDHOVEN, THE NETHERLANDS AND ITS SUBSIDIARY COMPANIES (INDIVIDUALLY AND COLLECTIVELY "PHILIPS"). THIS AGREEMENT GIVES YOU THE RIGHT TO USE CERTAIN SOFTWARE (THE "SOFTWARE") INCLUDING USER DOCUMENTATION IN ELECTRONIC FORM WHICH MAY HAVE BEEN PROVIDED SEPARATELY OR TOGETHER WITH A PHILIPS PRODUCT (THE "DEVICE") OR A PC. BY DOWNLOADING, INSTALLING OR OTHERWISE USING THE SOFTWARE, YOU ACCEPT AND AGREE TO BE BOUND BY ALL OF THE TERMS AND CONDITIONS OF THIS AGREEMENT. IF YOU DO NOT AGREE TO THESE TERMS AND CONDITIONS, DO NOT DOWNLOAD, INSTALL OR OTHERWISE USE THE SOFTWARE. IF YOU ACQUIRED THE SOFTWARE IN TANGIBLE MEDIA E.G. CD WITHOUT THE OPPORTUNITY TO REVIEW THIS LICENSE AND DO NOT ACCEPT THESE TERMS, YOU MAY RECEIVE A FULL REFUND OF THE AMOUNT, IF ANY, THAT YOU PAID FOR THE SOFTWARE IF YOU RETURN THE SOFTWARE UNUSED WITH PROOF OF PAYMENT WITHIN 30 DAYS FROM THE DATE OF PURCHASE.

**1. Grant of License.** This Agreement grants you a non-exclusive, nontransferable, non-sub licensable license to install and use, on the Device or a PC, as applicable, one (1) copy of the specified version of the Software in object code format as set out in the user documentation solely for your personal use. The Software is "in use" when it is loaded into the temporary or permanent memory (i.e. RAM, hard disk, etc.) of the PC or the Device.

**2. Ownership.** The Software is licensed and not sold to you. This Agreement grants you only the right to use the Software, but you do not acquire any rights, express or implied, in the Software other than those specified in this Agreement. Philips and its licensors retain all right, title, and interest in and to the Software, including all patents, copyrights, trade secrets, and other intellectual property rights incorporated therein. The Software is protected by copyright laws, international treaty provisions, and other intellectual property laws. Therefore, other than as expressly set forth herein, you may not copy the Software without prior written authorization of Philips, except that you may make one (1) copy of the Software for your back-up purposes only. You may not copy any printed materials accompanying the Software, nor print more than one (1) copy of any user documentation provided in electronic form, except that you may make one (1) copy of such printed materials for your back-up purposes only.

**3. License Restrictions.** Except as provided otherwise herein, you shall not rent, lease, sublicense, sell, assign, loan, or otherwise transfer the Software. You shall not, and you shall not permit any third party, to reverse engineer, decompile, or disassemble the Software, except to the extent that applicable law expressly prohibits the foregoing restriction. You may not remove or destroy any product identification, copyright notices, or other proprietary markings or restrictions from the Software. All titles, trademarks, and copyright and restricted rights notices shall be reproduced on your back up copy of the Software. You may not modify or adapt the Software, merge the Software into another program or create derivative works based upon the Software.

**4. Termination of certain functionality.** The Software may contain components of certain licensed software including software licensed from Microsoft Corporation ("Microsoft") which implements Microsoft's digital rights management technology for Windows Media. Content providers are using the digital rights management technology for Windows Media ("WM-DRM") to protect the integrity of their content ("Secure Content") so that their intellectual property, including copyright, in such content is not misappropriated. Your Device may also use WM-DRM software to transfer or play Secure Content ("WM-DRM Software"). If the security of such WM-DRM Software is compromised, Microsoft may revoke (either on its own or upon the request of the owners of Secure Content ("Secure Content Owners")) the WM-DRM Software's right to acquire new licenses to copy, store, transfer, display and/or play Secure Content. Revocation does not alter the WM-DRM Software's



ability to play unprotected content. A list of revoked WM-DRM Software is sent to your PC and/or your Device whenever you download a license for Secure Content. Microsoft may, in conjunction with such license, also download revocation lists onto your Device on behalf of Secure Content Owners, which may disable your Device's ability to copy, store, display, transfer, and/or play Secure Content. Secure Content Owners may also require you to upgrade some of the WM-DRM components distributed with this Software ("WM-DRM Upgrades") before accessing their content. When you attempt to play Secure Content, WM-DRM Software built by Microsoft will notify you that a WM-DRM Upgrade is required and then ask for your consent before the WM-DRM Upgrade is downloaded. WM-DRM Software built by Philips may do the same. If you decline the upgrade, you will not be able to access Secure Content that requires the WM-DRM Upgrade; however, you will still be able to access unprotected content and Secure Content that does not require the upgrade. WM-DRM features that access the Internet, such as acquiring new licenses and/or performing a required WM-DRM Upgrade, can be switched off. When these features are switched off, you will still be able to play Secure Content if you have a valid license for such content already stored on your Device. However, you will not be able to use certain of the WM-DRM Software features that require Internet access such as the ability to download content that requires the WM-DRM Upgrade. All title and intellectual property rights in and to the Secure Content is the property of the respective Secure Content owners and may be protected by applicable copyright or other intellectual property laws and treaties. This Agreement grants you no rights to use such Secure Content. **To summarize, if the Software contains Microsoft WM-DRM components – Secure Content you desire to download, copy, store, display, transfer, and/or play is protected by the Microsoft WM-DRM components of the Software. Microsoft, Secure Content Owners, or Secure Content distributors may deny you access, or restrict your access, to Secure Content even after you have paid for, and/or obtained, it. Neither your consent nor the consent or approval of Philips is necessary for any of them to deny, withhold or otherwise restrict your access to Secure Content. Philips does not guaranty that you will be able to download, copy, store, display, transfer, and/or play Secure Content.**

**5. Open Source Software.** (a) This software may contain components that are subject to open-source terms, as stated in the documentation accompanying the Device. This Agreement does not apply to this software as such. (b) Your license rights under this Agreement do not include any right or license to use, distribute or create derivative works of the Software in any manner that would subject the Software to Open Source Terms. "Open Source Terms" means the terms of any license that directly or indirectly (1) create, or purport to create, obligations for Philips with respect to the Software and/or derivative works thereof; or (2) grant, or purport to grant, to any third party any rights or immunities under intellectual property or proprietary rights in the Software or derivative works thereof.

**6. Termination.** This Agreement shall be effective upon installation or first use of the Software and shall terminate (i) at the discretion of Philips, due to your failure to comply with any term of this Agreement; or (ii) upon destruction of all copies of the Software and related materials provided to you by Philips hereunder. Philips's rights and your obligations shall survive the termination of this Agreement.

**7. Upgrades.** Philips may, at its sole option, make upgrades to the Software available by general posting on a website or by any other means or methods. Such upgrades may be made available pursuant to the terms of this Agreement or the release of such upgrades to you may be subject to your acceptance of another agreement.

**8. Support Services.** Philips is not obligated to provide technical or other support ("Support Services") for the Software. If Philips does provide you with Support Services, these will be governed by separate terms to be agreed between you and Philips.

**9. Limited Software Warranty.** Philips provides the Software 'as is' and without any warranty except that the Software will perform substantially in accordance with the documentation accompanying the Software for a period of one year after your first download, installation or use of the Software, whichever occurs first. Philips' entire liability and your exclusive remedy for breach of this warranty shall be, at Philips' option, either (i) return of the price paid by you for the Software (if any); or (b) repair or replacement of the Software that does not

meet the warranty set forth herein and that is returned to Philips with a copy of your receipt. This limited warranty shall be void if failure of the Software has resulted from any accident, abuse, misuse or wrongful application. Any replacement Software will be warranted for the remainder of the original warranty period or thirty (30) days, whichever is longer. This limited warranty shall not apply to you if the Software was provided to you free of charge on an evaluation only basis.

**10. NO OTHER WARRANTIES.** EXCEPT AS SET FORTH ABOVE, PHILIPS AND ITS LICENSORS DO NOT WARRANT THAT THE SOFTWARE WILL OPERATE ERROR FREE OR UNINTERRUPTED, OR WILL MEET YOUR REQUIREMENTS. YOU ASSUME ALL RESPONSIBILITIES FOR SELECTION OF THE SOFTWARE TO ACHIEVE YOUR INTENDED RESULTS, AND FOR THE INSTALLATION OF, USE OF, AND RESULTS OBTAINED FROM THE SOFTWARE. TO THE MAXIMUM EXTENT PERMITTED BY APPLICABLE LAW, PHILIPS AND ITS LICENSORS DISCLAIM ALL WARRANTIES AND CONDITIONS, WHETHER EXPRESS OR IMPLIED, INCLUDING BUT NOT LIMITED TO THE IMPLIED WARRANTIES OF MERCHANTABILITY, FITNESS FOR A PARTICULAR PURPOSE, AND ACCURACY OR COMPLETENESS OF RESULTS WITH RESPECT TO THE SOFTWARE AND THE ACCOMPANYING MATERIALS. THERE IS NO WARRANTY AGAINST INFRINGEMENT. PHILIPS DOES NOT WARRANT THAT YOU WILL BE ABLE TO DOWNLOAD, COPY, STORE, DISPLAY, TRANSFER, AND/OR PLAY SECURE CONTENT.

**11. LIMITATION OF LIABILITY.** UNDER NO CIRCUMSTANCES WILL PHILIPS OR ITS LICENSORS BE LIABLE FOR ANY CONSEQUENTIAL, SPECIAL, INDIRECT, INCIDENTAL OR PUNITIVE DAMAGES WHATSOEVER, INCLUDING, WITHOUT LIMITATION, DAMAGES FOR LOSS OF PROFITS OR REVENUES, BUSINESS INTERRUPTION, LOSS OF BUSINESS INFORMATION, LOSS OF DATA, LOSS OF USE OR OTHER PECUNIARY LOSS, EVEN IF PHILIPS OR ITS LICENSORS HAVE BEEN ADVISED OF THE POSSIBILITY OF SUCH DAMAGES. IN NO EVENT SHALL PHILIPS' OR ITS LICENSORS' AGGREGATE LIABILITY FOR DAMAGES ARISING OUT OF THIS AGREEMENT EXCEED THE GREATER OF THE PRICE ACTUALLY PAID BY YOU FOR THE SOFTWARE OR FIVE TEN POUNDS STERLINGUS DOLLARS (510.00).

**12. Trademarks.** Certain of the product and Philips names used in this Agreement, the Software, and the printed user documentation may constitute trademarks of the Philips, its licensors or other third parties. You are not authorized to use any such trademarks.

**13. Export Administration.** You agree that you will not directly or indirectly, export or re-export the Software to any country for which the United States Export Administration Act, or any similar United States law or regulation requires an export license or other U.S. Government approval, unless the appropriate export license or approval has first been obtained. By downloading or installing the Software you agree to abide by this Export provision.

**14. Governing law.** This Agreement is governed by the laws of your country of residence, without reference to its conflict of laws principles. Any dispute between you and Philips regarding this Agreement shall be subject to the non-exclusive jurisdiction of the courts of your country of residence.-

**15. General.** This Agreement contains the entire agreement between you and Philips and supersedes any prior representation, undertaking or other communication or advertising with respect to the Software and user documentation. If any part of this Agreement is held invalid, the remainder of this Agreement will continue in full force and effect. This Agreement shall not prejudice the statutory rights of any party dealing as a consumer.

## Written Offer

This product contains the following open source software packages, which are subject to their respective licenses. Philips hereby offers to deliver, upon request, a copy of the corresponding source code for the packages for which such offer is requested. This offer is valid up to three years after the product is purchased or firmware is downloaded. Please contact [open.source@philips.com](mailto:open.source@philips.com). If you don't have access to email or if you don't receive confirmation receipt within a week after mailing to this address, please write to

Open Source Team,  
Philips Electronics,  
High Tech Campus Bld HTC-44, 5600 AE Eindhoven,  
The Netherlands.

Linux kernel 2.6.10 <<http://www.kernel.org/pub/linux/kernel/>>, licensed under GPL V2,

BusyBox R1.9.2 <<http://www.busybox.net/>>, licensed under GPL V2,

WPA Supplicant R0.58 <[http://hostap.epitest.fi/wpa\\_supplicant/](http://hostap.epitest.fi/wpa_supplicant/)>, licensed under GPL V2,

NTFS-3G driver r2009.11.14 <<http://www.tuxera.com/community/>>, licensed under GPL V2,

-----  
Das U-Boot r1.1.5 <<http://www.denx.de/wiki/U-Boot>>, with exclusions for user programs.

NOTE! This copyright does *\*not\** cover the so-called "standalone" applications that use U-Boot services by means of the jump table provided by U-Boot exactly for this purpose - this is merely considered normal use of U-Boot, and does *\*not\** fall under the heading of "derived work".

The header files "include/image.h" and "include/asm-\*/u-boot.h" define interfaces to U-Boot. Including these (unmodified) header files in another file is considered normal use of U-Boot, and does *\*not\** fall under the heading of "derived work".

Also note that the GPL below is copyrighted by the Free Software Foundation, but the instance of code that it refers to (the U-Boot source code) is copyrighted by me and others who actually wrote it.

-- Wolfgang Denk

-----  
Linux kernel release 2.6.xx <<http://kernel.org/>>, licensed under GPL V2 with exclusions for user programs.

NOTE! This copyright does *\*not\** cover user programs that use kernel services by normal system calls - this is merely considered normal use of the kernel, and does *\*not\** fall under the heading of "derived work". Also note that the GPL below is copyrighted by the Free Software Foundation, but the instance of code that it refers to (the Linux kernel) is copyrighted by me and others who actually wrote it.

Also note that the only valid version of the GPL as far as the kernel is concerned is this particular version of the license (ie v2, not v2.2 or v3.x or whatever), unless explicitly otherwise stated.

Linus Torvalds

-----  
GPLV2

GNU GENERAL PUBLIC LICENSE  
Version 2, June 1991

Copyright (C) 1989, 1991 Free Software Foundation, Inc.  
51 Franklin St, Fifth Floor, Boston, MA 02110-1301 USA

Everyone is permitted to copy and distribute verbatim copies of this license document, but changing it is not allowed.

Preamble

The licenses for most software are designed to take away your freedom to share and change it. By contrast, the GNU General Public License is intended to guarantee your freedom to share and change free software--to make sure the software is free for all its users. This General Public License applies to most of the Free Software Foundation's software and to any other program whose authors commit to using it. (Some other Free Software Foundation software is covered by the GNU Library General Public License instead.) You can apply it to your programs, too.

When we speak of free software, we are referring to freedom, not price. Our General Public Licenses are designed to make sure that you have the freedom to distribute copies of free software (and charge for this service if you wish), that you receive source code or can get it if you want it, that you can change the software or use pieces of it in new free programs; and that you know you can do these things.

To protect your rights, we need to make restrictions that forbid anyone to deny you these rights or to ask you to surrender the rights. These restrictions translate to certain responsibilities for you if you distribute copies of the software, or if you modify it.

For example, if you distribute copies of such a program, whether gratis or for a fee, you must give the recipients all the rights that you have. You must make sure that they, too, receive or can get the source code. And you must show them these terms so they know their rights.

We protect your rights with two steps: (1) copyright the software, and (2) offer you this license which gives you legal permission to copy, distribute and/or modify the software.

Also, for each author's protection and ours, we want to make certain that everyone understands that there is no warranty for this free software. If the software is modified by someone else and passed on, we want its recipients to know that what they have is not the original, so that any problems introduced by others will not reflect on the original authors' reputations.

Finally, any free program is threatened constantly by software patents. We wish to avoid the danger that redistributors of a free program will individually obtain patent licenses, in effect making the program proprietary. To prevent this, we have made it clear that any patent must be licensed for everyone's free use or not licensed at all.

The precise terms and conditions for copying, distribution and modification follow.

GNU GENERAL PUBLIC LICENSE  
TERMS AND CONDITIONS FOR COPYING, DISTRIBUTION AND MODIFICATION

0. This License applies to any program or other work which contains a notice placed by the copyright holder saying it may be distributed under the terms of this General Public License. The "Program", below, refers to any such program or work, and a "work based on the Program" means either the Program or any derivative work under copyright law: that is to say, a work containing the Program or a portion of it, either verbatim or with modifications and/or translated into another language. (Hereinafter, translation is included without limitation in the term "modification".) Each licensee is addressed as "you".

Activities other than copying, distribution and modification are not covered by this License; they are outside its scope. The act of running the Program is not restricted, and the output from the Program is covered only if its contents constitute a work based on the Program (independent of having been made by running the Program). Whether that is true depends on what the Program does.

1. You may copy and distribute verbatim copies of the Program's source code as you receive it, in any medium, provided that you conspicuously and appropriately publish on each copy an appropriate copyright notice and disclaimer of warranty; keep intact all the notices that refer to this License and to the absence of any warranty; and give any other recipients of the Program a copy of this License along with the Program.

You may charge a fee for the physical act of transferring a copy, and you may at your option offer warranty protection in exchange for a fee.

2. You may modify your copy or copies of the Program or any portion of it, thus forming a work based on the Program, and copy and distribute such modifications or work under the terms of Section 1 above, provided that you also meet all of these conditions:

a) You must cause the modified files to carry prominent notices stating that you changed the files and the date of any change.

b) You must cause any work that you distribute or publish, that in whole or in part contains or is derived from the Program or any part thereof, to be licensed as a whole at no charge to all third parties under the terms of this License.

c) If the modified program normally reads commands interactively when run, you must cause it, when started running for such interactive use in the most ordinary way, to print or display an announcement including an appropriate copyright notice and a notice that there is no warranty (or else, saying that you provide a warranty) and that users may redistribute the program under these conditions, and telling the user how to view a copy of this License. (Exception: if the Program itself is interactive but does not normally print such an announcement, your work based on the Program is not required to print an announcement.)

These requirements apply to the modified work as a whole. If identifiable sections of that work are not derived from the Program, and can be reasonably considered independent and separate works in themselves, then this License, and its terms, do not apply to those sections when you distribute them as separate works. But when you distribute the same sections as part of a whole which is a work based on the Program, the distribution of the whole must be on the terms of this License, whose permissions for other licensees extend to the entire whole, and thus to each and every part regardless of who wrote it.

Thus, it is not the intent of this section to claim rights or contest your rights to work written entirely by you; rather, the intent is to exercise the right to control the distribution of derivative or collective works based on the Program.

In addition, mere aggregation of another work not based on the Program with the Program (or with a work based on the Program) on a volume of a storage or distribution medium does not bring the other work under the scope of this License.

3. You may copy and distribute the Program (or a work based on it, under Section 2) in object code or executable form under the terms of Sections 1 and 2 above provided that you also do one of the following:

- a) Accompany it with the complete corresponding machine-readable source code, which must be distributed under the terms of Sections 1 and 2 above on a medium customarily used for software interchange; or,
- b) Accompany it with a written offer, valid for at least three years, to give any third party, for a charge no more than your cost of physically performing source distribution, a complete machine-readable copy of the corresponding source code, to be distributed under the terms of Sections 1 and 2 above on a medium customarily used for software interchange; or,
- c) Accompany it with the information you received as to the offer to distribute corresponding source code. (This alternative is allowed only for noncommercial distribution and only if you received the program in object code or executable form with such an offer; in accord with Subsection b above.)

The source code for a work means the preferred form of the work for making modifications to it. For an executable work, complete source code means all the source code for all modules it contains, plus any associated interface definition files, plus the scripts used to control compilation and installation of the executable. However, as a special exception, the source code distributed need not include anything that is normally distributed (in either source or binary form) with the major components (compiler, kernel, and so on) of the operating system on which the executable runs, unless that component itself accompanies the executable.

If distribution of executable or object code is made by offering access to copy from a designated place, then offering equivalent access to copy the source code from the same place counts as distribution of the source code, even though third parties are not compelled to copy the source along with the object code.

4. You may not copy, modify, sublicense, or distribute the Program except as expressly provided under this License. Any attempt otherwise to copy, modify, sublicense or distribute the Program is void, and will automatically terminate your rights under this License. However, parties who have received copies, or rights, from you under this License will not have their licenses terminated so long as such parties remain in full compliance.

5. You are not required to accept this License, since you have not signed it. However, nothing else grants you permission to modify or distribute the Program or its derivative works. These actions are prohibited by law if you do not accept this License. Therefore, by modifying or distributing the Program (or any work based on the Program), you indicate your acceptance of this License to do so, and all its terms and conditions for copying, distributing or modifying the Program or works based on it.

6. Each time you redistribute the Program (or any work based on the Program), the recipient automatically receives a license from the original licensor to copy, distribute or modify the Program subject to these terms and conditions. You may not impose any further restrictions on the recipients' exercise of the rights granted herein. You are not responsible for enforcing compliance by third parties to this License.

7. If, as a consequence of a court judgment or allegation of patent infringement or for any other reason (not limited to patent issues), conditions are imposed on you (whether by court order, agreement or otherwise) that contradict the conditions of this License, they do not excuse you from the conditions of this License. If you cannot distribute so as to satisfy simultaneously your obligations under this License and any other pertinent obligations, then as a consequence you may not distribute the Program at all. For example, if a patent license would not permit royalty-free redistribution of the Program by all those who receive copies directly or indirectly through you, then the only way you could satisfy both it and this License would be to refrain entirely from distribution of the Program.

If any portion of this section is held invalid or unenforceable under any particular circumstance, the balance of the section is intended to apply and the section as a whole is intended to apply in other circumstances.

It is not the purpose of this section to induce you to infringe any patents or other property right claims or to contest validity of any such claims; this section has the sole purpose of protecting the integrity of the free software distribution system, which is implemented by public license practices. Many people have made generous contributions to the wide range of software distributed through that system in reliance on consistent application of that system; it is up to the author/donor to decide if he or she is willing to distribute software through any other system and a licensee cannot impose that choice.

This section is intended to make thoroughly clear what is believed to be a consequence of the rest of this License.

8. If the distribution and/or use of the Program is restricted in certain countries either by patents or by copyrighted interfaces, the original copyright holder who places the Program under this License may add an explicit geographical distribution limitation excluding those countries, so that distribution is permitted only in or among countries not thus excluded. In such case, this License incorporates the limitation as if written in the body of this License.

9. The Free Software Foundation may publish revised and/or new versions of the General Public License from time to time. Such new versions will be similar in spirit to the present version, but may differ in detail to address new problems or concerns.

Each version is given a distinguishing version number. If the Program specifies a version number of this License which applies to it and "any later version", you have the option of following the terms and conditions either of that version or of any later version published by the Free Software Foundation. If the Program does not specify a version number of this License, you may choose any version ever published by the Free Software Foundation.

10. If you wish to incorporate parts of the Program into other free programs whose distribution conditions are different, write to the author to ask for permission. For software which is copyrighted by the Free Software Foundation, write to the Free Software Foundation; we sometimes make exceptions for this. Our decision will be guided by the two goals of preserving the free status of all derivatives of our free software and of promoting the sharing and reuse of software generally.

## NO WARRANTY

11. BECAUSE THE PROGRAM IS LICENSED FREE OF CHARGE, THERE IS NO WARRANTY FOR THE PROGRAM, TO THE EXTENT PERMITTED BY APPLICABLE LAW. EXCEPT WHEN OTHERWISE STATED IN WRITING THE COPYRIGHT HOLDERS AND/OR OTHER PARTIES PROVIDE THE PROGRAM "AS IS" WITHOUT WARRANTY OF ANY KIND, EITHER EXPRESSED OR IMPLIED,

INCLUDING, BUT NOT LIMITED TO, THE IMPLIED WARRANTIES OF MERCHANTABILITY AND FITNESS FOR A PARTICULAR PURPOSE. THE ENTIRE RISK AS TO THE QUALITY AND PERFORMANCE OF THE PROGRAM IS WITH YOU. SHOULD THE PROGRAM PROVE DEFECTIVE, YOU ASSUME THE COST OF ALL NECESSARY SERVICING, REPAIR OR CORRECTION.

12. IN NO EVENT UNLESS REQUIRED BY APPLICABLE LAW OR AGREED TO IN WRITING WILL ANY COPYRIGHT HOLDER, OR ANY OTHER PARTY WHO MAY MODIFY AND/OR REDISTRIBUTE THE PROGRAM AS PERMITTED ABOVE, BE LIABLE TO YOU FOR DAMAGES, INCLUDING ANY GENERAL, SPECIAL, INCIDENTAL OR CONSEQUENTIAL DAMAGES ARISING OUT OF THE USE OR INABILITY TO USE THE PROGRAM (INCLUDING BUT NOT LIMITED TO LOSS OF DATA OR DATA BEING RENDERED INACCURATE OR LOSSES SUSTAINED BY YOU OR THIRD PARTIES OR A FAILURE OF THE PROGRAM TO OPERATE WITH ANY OTHER PROGRAMS), EVEN IF SUCH HOLDER OR OTHER PARTY HAS BEEN ADVISED OF THE POSSIBILITY OF SUCH DAMAGES.

## END OF TERMS AND CONDITIONS

### How to Apply These Terms to Your New Programs

If you develop a new program, and you want it to be of the greatest possible use to the public, the best way to achieve this is to make it free software which everyone can redistribute and change under these terms.

To do so, attach the following notices to the program. It is safest to attach them to the start of each source file to most effectively convey the exclusion of warranty; and each file should have at least the "copyright" line and a pointer to where the full notice is found.

```
<one line to give the program's name and a brief idea of what it does.>  
Copyright (C) <year> <name of author>
```

This program is free software; you can redistribute it and/or modify it under the terms of the GNU General Public License as published by the Free Software Foundation; either version 2 of the License, or (at your option) any later version.

This program is distributed in the hope that it will be useful, but WITHOUT ANY WARRANTY; without even the implied warranty of MERCHANTABILITY or FITNESS FOR A PARTICULAR PURPOSE. See the GNU General Public License for more details.

You should have received a copy of the GNU General Public License along with this program; if not, write to the Free Software Foundation, Inc., 51 Franklin St, Fifth Floor, Boston, MA 02110-1301 USA

Also add information on how to contact you by electronic and paper mail.

If the program is interactive, make it output a short notice like this when it starts in an interactive mode:

```
Gnomovision version 69, Copyright (C) year name of author  
Gnomovision comes with ABSOLUTELY NO WARRANTY; for details type `show w'.  
This is free software, and you are welcome to redistribute it under certain conditions; type `show c' for  
details.
```

The hypothetical commands `show w' and `show c' should show the appropriate parts of the General



Public License. Of course, the commands you use may be called something other than `show w' and `show c'; they could even be mouse-clicks or menu items--whatever suits your program.

You should also get your employer (if you work as a programmer) or your school, if any, to sign a "copyright disclaimer" for the program, if necessary. Here is a sample; alter the names:

Yoyodyne, Inc., hereby disclaims all copyright interest in the program `Gnomovision' (which makes passes at compilers) written by James Hacker:

<signature of Ty Coon>, 1 April 1989  
Ty Coon, President of Vice

This General Public License does not permit incorporating your program into proprietary programs. If your program is a subroutine library, you may consider it more useful to permit linking proprietary applications with the library. If this is what you want to do, use the GNU Library General Public License instead of this License.

-----  
uClibc r0.9 <<http://www.uclibc.org/>>, licensed under LGPL V2,

-----  
LGPL V2

GNU LIBRARY GENERAL PUBLIC LICENSE  
Version 2, June 1991

Copyright (C) 1991 Free Software Foundation, Inc.  
675 Mass Ave, Cambridge, MA 02139, USA

Everyone is permitted to copy and distribute verbatim copies of this license document, but changing it is not allowed.

[This is the first released version of the library GPL. It is numbered 2 because it goes with version 2 of the ordinary GPL.]

### Preamble

The licenses for most software are designed to take away your freedom to share and change it. By contrast, the GNU General Public Licenses are intended to guarantee your freedom to share and change free software--to make sure the software is free for all its users.

This license, the Library General Public License, applies to some specially designated Free Software Foundation software, and to any other libraries whose authors decide to use it. You can use it for your libraries, too.

When we speak of free software, we are referring to freedom, not price. Our General Public Licenses are designed to make sure that you have the freedom to distribute copies of free software (and charge for this service if you wish), that you receive source code or can get it if you want it, that you can change the software or use pieces of it in new free programs; and that you know you can do these things.

To protect your rights, we need to make restrictions that forbid anyone to deny you these rights or to ask you to surrender the rights. These restrictions translate to certain responsibilities for you if

you distribute copies of the library, or if you modify it.

For example, if you distribute copies of the library, whether gratis or for a fee, you must give the recipients all the rights that we give you. You must make sure that they, too, receive or can get the source code. If you link a program with the library, you must provide complete object files to the recipients so that they can relink them with the library, after making changes to the library and recompiling it. And you must show them these terms so they know their rights.

Our method of protecting your rights has two steps: (1) copyright the library, and (2) offer you this license which gives you legal permission to copy, distribute and/or modify the library.

Also, for each distributor's protection, we want to make certain that everyone understands that there is no warranty for this free library. If the library is modified by someone else and passed on, we want its recipients to know that what they have is not the original version, so that any problems introduced by others will not reflect on the original authors' reputations.

Finally, any free program is threatened constantly by software patents. We wish to avoid the danger that companies distributing free software will individually obtain patent licenses, thus in effect transforming the program into proprietary software. To prevent this, we have made it clear that any patent must be licensed for everyone's free use or not licensed at all.

Most GNU software, including some libraries, is covered by the ordinary GNU General Public License, which was designed for utility programs. This license, the GNU Library General Public License, applies to certain designated libraries. This license is quite different from the ordinary one; be sure to read it in full, and don't assume that anything in it is the same as in the ordinary license.

The reason we have a separate public license for some libraries is that they blur the distinction we usually make between modifying or adding to a program and simply using it. Linking a program with a library, without changing the library, is in some sense simply using the library, and is analogous to running a utility program or application program. However, in a textual and legal sense, the linked executable is a combined work, a derivative of the original library, and the ordinary General Public License treats it as such.

Because of this blurred distinction, using the ordinary General Public License for libraries did not effectively promote software sharing, because most developers did not use the libraries. We concluded that weaker conditions might promote sharing better.

However, unrestricted linking of non-free programs would deprive the users of those programs of all benefit from the free status of the libraries themselves. This Library General Public License is intended to permit developers of non-free programs to use free libraries, while preserving your freedom as a user of such programs to change the free libraries that are incorporated in them. (We have not seen how to achieve this as regards changes in header files, but we have achieved it as regards changes in the actual functions of the Library.) The hope is that this will lead to faster development of free libraries.

The precise terms and conditions for copying, distribution and modification follow. Pay close attention to the difference between a "work based on the library" and a "work that uses the library". The former contains code derived from the library, while the latter only works together with the library.

Note that it is possible for a library to be covered by the ordinary General Public License rather than by this special one.

GNU LIBRARY GENERAL PUBLIC LICENSE  
TERMS AND CONDITIONS FOR COPYING, DISTRIBUTION AND MODIFICATION

0. This License Agreement applies to any software library which contains a notice placed by the copyright holder or other authorized party saying it may be distributed under the terms of this Library General Public License (also called "this License"). Each licensee is addressed as "you".

A "library" means a collection of software functions and/or data prepared so as to be conveniently linked with application programs (which use some of those functions and data) to form executables.

The "Library", below, refers to any such software library or work which has been distributed under these terms. A "work based on the Library" means either the Library or any derivative work under copyright law: that is to say, a work containing the Library or a portion of it, either verbatim or with modifications and/or translated straightforwardly into another language. (Hereinafter, translation is included without limitation in the term "modification".)

"Source code" for a work means the preferred form of the work for making modifications to it. For a library, complete source code means all the source code for all modules it contains, plus any associated interface definition files, plus the scripts used to control compilation and installation of the library.

Activities other than copying, distribution and modification are not covered by this License; they are outside its scope. The act of running a program using the Library is not restricted, and output from such a program is covered only if its contents constitute a work based on the Library (independent of the use of the Library in a tool for writing it). Whether that is true depends on what the Library does and what the program that uses the Library does.

1. You may copy and distribute verbatim copies of the Library's complete source code as you receive it, in any medium, provided that you conspicuously and appropriately publish on each copy an appropriate copyright notice and disclaimer of warranty; keep intact all the notices that refer to this License and to the absence of any warranty; and distribute a copy of this License along with the Library.

You may charge a fee for the physical act of transferring a copy, and you may at your option offer warranty protection in exchange for a fee.

2. You may modify your copy or copies of the Library or any portion of it, thus forming a work based on the Library, and copy and distribute such modifications or work under the terms of Section 1 above, provided that you also meet all of these conditions:

- a) The modified work must itself be a software library.
- b) You must cause the files modified to carry prominent notices stating that you changed the files and the date of any change.
- c) You must cause the whole of the work to be licensed at no charge to all third parties under the terms of this License.
- d) If a facility in the modified Library refers to a function or a table of data to be supplied by an application program that uses the facility, other than as an argument passed when the facility is invoked, then you must make a good faith effort to ensure that, in the event an application does not supply such function or table, the facility still operates, and performs whatever part of its purpose remains meaningful.

(For example, a function in a library to compute square roots has a purpose that is entirely well-defined independent of the application. Therefore, Subsection 2d requires that any application-supplied function or table used by this function must be optional: if the application does not supply it, the square root function must still compute square roots.)

These requirements apply to the modified work as a whole. If identifiable sections of that work are not derived from the Library, and can be reasonably considered independent and separate works in themselves, then this License, and its terms, do not apply to those sections when you distribute them as separate works. But when you distribute the same sections as part of a whole which is a work based on the Library, the distribution of the whole must be on the terms of this License, whose permissions for other licensees extend to the entire whole, and thus to each and every part regardless of who wrote it.

Thus, it is not the intent of this section to claim rights or contest your rights to work written entirely by you; rather, the intent is to exercise the right to control the distribution of derivative or collective works based on the Library.

In addition, mere aggregation of another work not based on the Library with the Library (or with a work based on the Library) on a volume of a storage or distribution medium does not bring the other work under the scope of this License.

3. You may opt to apply the terms of the ordinary GNU General Public License instead of this License to a given copy of the Library. To do this, you must alter all the notices that refer to this License, so that they refer to the ordinary GNU General Public License, version 2, instead of to this License. (If a newer version than version 2 of the ordinary GNU General Public License has appeared, then you can specify that version instead if you wish.) Do not make any other change in these notices.

Once this change is made in a given copy, it is irreversible for that copy, so the ordinary GNU General Public License applies to all subsequent copies and derivative works made from that copy.

This option is useful when you wish to copy part of the code of the Library into a program that is not a library.

4. You may copy and distribute the Library (or a portion or derivative of it, under Section 2) in object code or executable form under the terms of Sections 1 and 2 above provided that you accompany it with the complete corresponding machine-readable source code, which must be distributed under the terms of Sections 1 and 2 above on a medium customarily used for software interchange.

If distribution of object code is made by offering access to copy from a designated place, then offering equivalent access to copy the source code from the same place satisfies the requirement to distribute the source code, even though third parties are not compelled to copy the source along with the object code.

5. A program that contains no derivative of any portion of the Library, but is designed to work with the Library by being compiled or linked with it, is called a "work that uses the Library". Such a work, in isolation, is not a derivative work of the Library, and therefore falls outside the scope of this License.

However, linking a "work that uses the Library" with the Library creates an executable that is a derivative of the Library (because it contains portions of the Library), rather than a "work that uses the library". The executable is therefore covered by this License. Section 6 states terms for distribution of such executables.

When a "work that uses the Library" uses material from a header file that is part of the Library, the object code for the work may be a derivative work of the Library even though the source code is not.

Whether this is true is especially significant if the work can be linked without the Library, or if the work is itself a library. The threshold for this to be true is not precisely defined by law.

If such an object file uses only numerical parameters, data structure layouts and accessors, and small macros and small inline functions (ten lines or less in length), then the use of the object file is unrestricted, regardless of whether it is legally a derivative work. (Executables containing this object code plus portions of the Library will still fall under Section 6.)

Otherwise, if the work is a derivative of the Library, you may distribute the object code for the work under the terms of Section 6. Any executables containing that work also fall under Section 6, whether or not they are linked directly with the Library itself.

6. As an exception to the Sections above, you may also compile or link a "work that uses the Library" with the Library to produce a work containing portions of the Library, and distribute that work under terms of your choice, provided that the terms permit modification of the work for the customer's own use and reverse engineering for debugging such modifications.

You must give prominent notice with each copy of the work that the Library is used in it and that the Library and its use are covered by this License. You must supply a copy of this License. If the work during execution displays copyright notices, you must include the copyright notice for the Library among them, as well as a reference directing the user to the copy of this License. Also, you must do one of these things:

- a) Accompany the work with the complete corresponding machine-readable source code for the Library including whatever changes were used in the work (which must be distributed under Sections 1 and 2 above); and, if the work is an executable linked with the Library, with the complete machine-readable "work that uses the Library", as object code and/or source code, so that the user can modify the Library and then relink to produce a modified executable containing the modified Library. (It is understood that the user who changes the contents of definitions files in the Library will not necessarily be able to recompile the application to use the modified definitions.)
- b) Accompany the work with a written offer, valid for at least three years, to give the same user the materials specified in Subsection 6a, above, for a charge no more than the cost of performing this distribution.
- c) If distribution of the work is made by offering access to copy from a designated place, offer equivalent access to copy the above specified materials from the same place.
- d) Verify that the user has already received a copy of these materials or that you have already sent this user a copy.

For an executable, the required form of the "work that uses the Library" must include any data and utility programs needed for reproducing the executable from it. However, as a special exception, the source code distributed need not include anything that is normally distributed (in either source or binary form) with the major components (compiler, kernel, and so on) of the operating system on which the executable runs, unless that component itself accompanies the executable.

It may happen that this requirement contradicts the license restrictions of other proprietary libraries that do not normally accompany the operating system. Such a contradiction means you cannot use both them and the Library together in an executable that you distribute.

7. You may place library facilities that are a work based on the Library side-by-side in a single library

together with other library facilities not covered by this License, and distribute such a combined library, provided that the separate distribution of the work based on the Library and of the other library facilities is otherwise permitted, and provided that you do these two things:

- a) Accompany the combined library with a copy of the same work based on the Library, uncombined with any other library facilities. This must be distributed under the terms of the Sections above.
- b) Give prominent notice with the combined library of the fact that part of it is a work based on the Library, and explaining where to find the accompanying uncombined form of the same work.

8. You may not copy, modify, sublicense, link with, or distribute the Library except as expressly provided under this License. Any attempt otherwise to copy, modify, sublicense, link with, or distribute the Library is void, and will automatically terminate your rights under this License. However, parties who have received copies, or rights, from you under this License will not have their licenses terminated so long as such parties remain in full compliance.

9. You are not required to accept this License, since you have not signed it. However, nothing else grants you permission to modify or distribute the Library or its derivative works. These actions are prohibited by law if you do not accept this License. Therefore, by modifying or distributing the Library (or any work based on the Library), you indicate your acceptance of this License to do so, and all its terms and conditions for copying, distributing or modifying the Library or works based on it.

10. Each time you redistribute the Library (or any work based on the Library), the recipient automatically receives a license from the original licensor to copy, distribute, link with or modify the Library subject to these terms and conditions. You may not impose any further restrictions on the recipients' exercise of the rights granted herein. You are not responsible for enforcing compliance by third parties to this License.

11. If, as a consequence of a court judgment or allegation of patent infringement or for any other reason (not limited to patent issues), conditions are imposed on you (whether by court order, agreement or otherwise) that contradict the conditions of this License, they do not excuse you from the conditions of this License. If you cannot distribute so as to satisfy simultaneously your obligations under this License and any other pertinent obligations, then as a consequence you may not distribute the Library at all. For example, if a patent license would not permit royalty-free redistribution of the Library by all those who receive copies directly or indirectly through you, then the only way you could satisfy both it and this License would be to refrain entirely from distribution of the Library.

If any portion of this section is held invalid or unenforceable under any particular circumstance, the balance of the section is intended to apply, and the section as a whole is intended to apply in other circumstances.

It is not the purpose of this section to induce you to infringe any patents or other property right claims or to contest validity of any such claims; this section has the sole purpose of protecting the integrity of the free software distribution system which is implemented by public license practices. Many people have made generous contributions to the wide range of software distributed through that system in reliance on consistent application of that system; it is up to the author/donor to decide if he or she is willing to distribute software through any other system and a licensee cannot impose that choice.

This section is intended to make thoroughly clear what is believed to be a consequence of the rest of this License.

12. If the distribution and/or use of the Library is restricted in certain countries either by patents or by

copyrighted interfaces, the original copyright holder who places the Library under this License may add an explicit geographical distribution limitation excluding those countries, so that distribution is permitted only in or among countries not thus excluded. In such case, this License incorporates the limitation as if written in the body of this License.

13. The Free Software Foundation may publish revised and/or new versions of the Library General Public License from time to time. Such new versions will be similar in spirit to the present version, but may differ in detail to address new problems or concerns.

Each version is given a distinguishing version number. If the Library specifies a version number of this License which applies to it and "any later version", you have the option of following the terms and conditions either of that version or of any later version published by the Free Software Foundation. If the Library does not specify a license version number, you may choose any version ever published by the Free Software Foundation.

14. If you wish to incorporate parts of the Library into other free programs whose distribution conditions are incompatible with these, write to the author to ask for permission. For software which is copyrighted by the Free Software Foundation, write to the Free Software Foundation; we sometimes make exceptions for this. Our decision will be guided by the two goals of preserving the free status of all derivatives of our free software and of promoting the sharing and reuse of software generally.

#### NO WARRANTY

15. BECAUSE THE LIBRARY IS LICENSED FREE OF CHARGE, THERE IS NO WARRANTY FOR THE LIBRARY, TO THE EXTENT PERMITTED BY APPLICABLE LAW. EXCEPT WHEN OTHERWISE STATED IN WRITING THE COPYRIGHT HOLDERS AND/OR OTHER PARTIES PROVIDE THE LIBRARY "AS IS" WITHOUT WARRANTY OF ANY KIND, EITHER EXPRESSED OR IMPLIED, INCLUDING, BUT NOT LIMITED TO, THE IMPLIED WARRANTIES OF MERCHANTABILITY AND FITNESS FOR A PARTICULAR PURPOSE. THE ENTIRE RISK AS TO THE QUALITY AND PERFORMANCE OF THE LIBRARY IS WITH YOU. SHOULD THE LIBRARY PROVE DEFECTIVE, YOU ASSUME THE COST OF ALL NECESSARY SERVICING, REPAIR OR CORRECTION.

16. IN NO EVENT UNLESS REQUIRED BY APPLICABLE LAW OR AGREED TO IN WRITING WILL ANY COPYRIGHT HOLDER, OR ANY OTHER PARTY WHO MAY MODIFY AND/OR REDISTRIBUTE THE LIBRARY AS PERMITTED ABOVE, BE LIABLE TO YOU FOR DAMAGES, INCLUDING ANY GENERAL, SPECIAL, INCIDENTAL OR CONSEQUENTIAL DAMAGES ARISING OUT OF THE USE OR INABILITY TO USE THE LIBRARY (INCLUDING BUT NOT LIMITED TO LOSS OF DATA OR DATA BEING RENDERED INACCURATE OR LOSSES SUSTAINED BY YOU OR THIRD PARTIES OR A FAILURE OF THE LIBRARY TO OPERATE WITH ANY OTHER SOFTWARE), EVEN IF SUCH HOLDER OR OTHER PARTY HAS BEEN ADVISED OF THE POSSIBILITY OF SUCH DAMAGES.

#### END OF TERMS AND CONDITIONS

#### Appendix: How to Apply These Terms to Your New Libraries

If you develop a new library, and you want it to be of the greatest possible use to the public, we recommend making it free software that everyone can redistribute and change. You can do so by permitting redistribution under these terms (or, alternatively, under the terms of the ordinary General Public License).

To apply these terms, attach the following notices to the library. It is safest to attach them to the start of

each source file to most effectively convey the exclusion of warranty; and each file should have at least the "copyright" line and a pointer to where the full notice is found.

<one line to give the library's name and a brief idea of what it does.>  
Copyright (C) <year> <name of author>

This library is free software; you can redistribute it and/or modify it under the terms of the GNU Library General Public License as published by the Free Software Foundation; either version 2 of the License, or (at your option) any later version.

This library is distributed in the hope that it will be useful, but WITHOUT ANY WARRANTY; without even the implied warranty of MERCHANTABILITY or FITNESS FOR A PARTICULAR PURPOSE. See the GNU Library General Public License for more details.

You should have received a copy of the GNU Library General Public License along with this library; if not, write to the Free Software Foundation, Inc., 675 Mass Ave, Cambridge, MA 02139, USA.

Also add information on how to contact you by electronic and paper mail.

You should also get your employer (if you work as a programmer) or your school, if any, to sign a "copyright disclaimer" for the library, if necessary. Here is a sample; alter the names:

Yoyodyne, Inc., hereby disclaims all copyright interest in the library `Frob' (a library for tweaking knobs) written by James Random Hacker:

<signature of Ty Coon>, 1 April 1990  
Ty Coon, President of Vice

That's all there is to it!

-----  
JPEG 6b <<http://www.jpeg.org/>>, licensed as below,

The authors make NO WARRANTY or representation, either express or implied, with respect to this software, its quality, accuracy, merchantability, or fitness for a particular purpose. This software is provided "AS IS", and you, its user, assume the entire risk as to its quality and accuracy.

This software is copyright (C) 1991-2010, Thomas G. Lane, Guido Vollbeding.  
All Rights Reserved except as specified below.

Permission is hereby granted to use, copy, modify, and distribute this software (or portions thereof) for any purpose, without fee, subject to these conditions:

- (1) If any part of the source code for this software is distributed, then this README file must be included, with this copyright and no-warranty notice unaltered; and any additions, deletions, or changes to the original files must be clearly indicated in accompanying documentation.
- (2) If only executable code is distributed, then the accompanying documentation must state that "this software is based in part on the work of the Independent JPEG Group".
- (3) Permission for use of this software is granted only if the user accepts full responsibility for any undesirable consequences; the authors accept NO LIABILITY for damages of any kind.

These conditions apply to any software derived from or based on the IJG code, not just to the unmodified



library. If you use our work, you ought to acknowledge us.

Permission is NOT granted for the use of any IJG author's name or company name in advertising or publicity relating to this software or products derived from it. This software may be referred to only as "the Independent JPEG Group's software".

We specifically permit and encourage the use of this software as the basis of commercial products, provided that all warranty or liability claims are assumed by the product vendor.

-----  
libpng 1.2.8 <<http://www.ijg.org/>>, licensed as below,

This copy of the libpng notices is provided for your convenience. In case of any discrepancy between this copy and the notices in the file png.h that is included in the libpng distribution, the latter shall prevail.

COPYRIGHT NOTICE, DISCLAIMER, and LICENSE:

If you modify libpng you may insert additional notices immediately following this sentence.

This code is released under the libpng license.

libpng versions 1.2.6, August 15, 2004, through 1.4.0, January 3, 2010, are Copyright (c) 2004, 2006-2007 Glenn Randers-Pehrson, and are distributed according to the same disclaimer and license as libpng-1.2.5 with the following individual added to the list of Contributing Authors

Cosmin Truta

libpng versions 1.0.7, July 1, 2000, through 1.2.5 - October 3, 2002, are Copyright (c) 2000-2002 Glenn Randers-Pehrson, and are distributed according to the same disclaimer and license as libpng-1.0.6 with the following individuals added to the list of Contributing Authors

Simon-Pierre Cadieux  
Eric S. Raymond  
Gilles Vollant

and with the following additions to the disclaimer:

There is no warranty against interference with your enjoyment of the library or against infringement. There is no warranty that our efforts or the library will fulfill any of your particular purposes or needs. This library is provided with all faults, and the entire risk of satisfactory quality, performance, accuracy, and effort is with the user.

libpng versions 0.97, January 1998, through 1.0.6, March 20, 2000, are Copyright (c) 1998, 1999 Glenn Randers-Pehrson, and are distributed according to the same disclaimer and license as libpng-0.96, with the following individuals added to the list of Contributing Authors:

Tom Lane  
Glenn Randers-Pehrson  
Willem van Schaik

libpng versions 0.89, June 1996, through 0.96, May 1997, are Copyright (c) 1996, 1997 Andreas Dilger

Distributed according to the same disclaimer and license as libpng-0.88, with the following individuals added to the list of Contributing Authors:

John Bowler  
Kevin Bracey  
Sam Bushell  
Magnus Holmgren  
Greg Roelofs  
Tom Tanner

libpng versions 0.5, May 1995, through 0.88, January 1996, are Copyright (c) 1995, 1996 Guy Eric Schalnat, Group 42, Inc.

For the purposes of this copyright and license, "Contributing Authors" is defined as the following set of individuals:

Andreas Dilger  
Dave Martindale  
Guy Eric Schalnat  
Paul Schmidt  
Tim Wegner

The PNG Reference Library is supplied "AS IS". The Contributing Authors and Group 42, Inc. disclaim all warranties, expressed or implied, including, without limitation, the warranties of merchantability and of fitness for any purpose. The Contributing Authors and Group 42, Inc. assume no liability for direct, indirect, incidental, special, exemplary, or consequential damages, which may result from the use of the PNG Reference Library, even if advised of the possibility of such damage.

Permission is hereby granted to use, copy, modify, and distribute this source code, or portions hereof, for any purpose, without fee, subject to the following restrictions:

1. The origin of this source code must not be misrepresented.
2. Altered versions must be plainly marked as such and must not be misrepresented as being the original source.
3. This Copyright notice may not be removed or altered from any source or altered source distribution.

The Contributing Authors and Group 42, Inc. specifically permit, without fee, and encourage the use of this source code as a component to supporting the PNG file format in commercial products. If you use this source code in a product, acknowledgment is not required but would be appreciated.

A "png\_get\_copyright" function is available, for convenient use in "about" boxes and the like:

```
printf("%s",png_get_copyright(NULL));
```

Also, the PNG logo (in PNG format, of course) is supplied in the files "pngbar.png" and "pngbar.jpg (88x31) and "pngnow.png" (98x31).

Libpng is OSI Certified Open Source Software. OSI Certified Open Source is a certification mark of the

Open Source Initiative.

Glenn Randers-Pehrson  
glennrp at users.sourceforge.net  
January 3, 2010

-----  
OpenSSL 0.9.8b <<http://www.openssl.org/>>, licensed under both OpenSSL License and Original SSLeay license,

OpenSSL License  
-----

```
/* =====  
* Copyright (c) 1998-2008 The OpenSSL Project. All rights reserved.  
*  
* Redistribution and use in source and binary forms, with or without * modification, are permitted  
* provided that the following conditions are met:  
*  
* 1. Redistributions of source code must retain the above copyright notice, this list of conditions and the  
* following disclaimer.  
*  
* 2. Redistributions in binary form must reproduce the above copyright notice, this list of conditions and  
* the following disclaimer in the documentation and/or other materials provided with the distribution.  
*  
* 3. All advertising materials mentioning features or use of this software must display the following  
* acknowledgment:  
* "This product includes software developed by the OpenSSL Project for use in the OpenSSL Toolkit.  
* (http://www.openssl.org/)"  
*  
* 4. The names "OpenSSL Toolkit" and "OpenSSL Project" must not be used to endorse or promote  
* products derived from this software without prior written permission. For written permission, please  
* contact openssl-core@openssl.org.  
*  
* 5. Products derived from this software may not be called "OpenSSL" nor may "OpenSSL" appear in  
* their names without prior written permission of the OpenSSL Project.  
*  
* 6. Redistributions of any form whatsoever must retain the following acknowledgment:  
* "This product includes software developed by the OpenSSL Project for use in the OpenSSL Toolkit  
* (http://www.openssl.org/)"  
*  
* THIS SOFTWARE IS PROVIDED BY THE OpenSSL PROJECT ``AS IS'' AND ANY EXPRESSED OR  
* IMPLIED WARRANTIES, INCLUDING, BUT NOT LIMITED TO, THE IMPLIED WARRANTIES OF  
* MERCHANTABILITY AND FITNESS FOR A PARTICULAR PURPOSE ARE DISCLAIMED. IN NO  
* EVENT SHALL THE OpenSSL PROJECT OR ITS CONTRIBUTORS BE LIABLE FOR ANY DIRECT,  
* INDIRECT, INCIDENTAL, SPECIAL, EXEMPLARY, OR CONSEQUENTIAL DAMAGES (INCLUDING,  
* BUT NOT LIMITED TO, PROCUREMENT OF SUBSTITUTE GOODS OR SERVICES; LOSS OF USE,  
* DATA, OR PROFITS; OR BUSINESS INTERRUPTION) HOWEVER CAUSED AND ON ANY THEORY  
* OF LIABILITY, WHETHER IN CONTRACT, STRICT LIABILITY, OR TORT (INCLUDING NEGLIGENCE  
* OR OTHERWISE) ARISING IN ANY WAY OUT OF THE USE OF THIS SOFTWARE, EVEN IF ADVISED
```

OF THE POSSIBILITY OF SUCH DAMAGE.

```
* =====  
=====
```

\*  
\* This product includes cryptographic software written by Eric Young (eay@cryptsoft.com). This product includes software written by Tim Hudson (tjh@cryptsoft.com).  
\*/

Original SSLeay License  
-----

```
/* Copyright (C) 1995-1998 Eric Young (eay@cryptsoft.com)  
* All rights reserved.  
*  
* This package is an SSL implementation written by Eric Young (eay@cryptsoft.com).  
* The implementation was written so as to conform with Netscapes SSL.  
*  
* This library is free for commercial and non-commercial use as long as the following conditions are  
  aheared to. The following conditions apply to all code found in this distribution, be it the RC4, RSA,  
  lhash, DES, etc., code; not just the SSL code. The SSL documentation included with this distribution is  
  covered by the same copyright terms except that the holder is Tim Hudson (tjh@cryptsoft.com).  
*  
* Copyright remains Eric Young's, and as such any Copyright notices in the code are not to be removed.  
  If this package is used in a product, Eric Young should be given attribution as the author of the parts of  
  the library used. This can be in the form of a textual message at program startup or in documentation  
  (online or textual) provided with the package.  
*  
* Redistribution and use in source and binary forms, with or without modification, are permitted  
  provided that the following conditions are met:  
* 1. Redistributions of source code must retain the copyright notice, this list of conditions and the  
  following disclaimer:  
* 2. Redistributions in binary form must reproduce the above copyright notice, this list of conditions and  
  the following disclaimer in the documentation and/or other materials provided with the distribution.  
* 3. All advertising materials mentioning features or use of this software must display the following  
  acknowledgement:  
* "This product includes cryptographic software written by Eric Young (eay@cryptsoft.com)"  
* The word 'cryptographic' can be left out if the rouines from the library being used are not  
  cryptographic related :-).  
* 4. If you include any Windows specific code (or a derivative thereof) from the apps directory  
  (application code) you must include an acknowledgement:  
* "This product includes software written by Tim Hudson (tjh@cryptsoft.com)"  
*  
* THIS SOFTWARE IS PROVIDED BY ERIC YOUNG ``AS IS'' AND ANY EXPRESS OR IMPLIED  
  WARRANTIES, INCLUDING, BUT NOT LIMITED TO, THE IMPLIED WARRANTIES OF  
  MERCHANTABILITY AND FITNESS FOR A PARTICULAR PURPOSE ARE DISCLAIMED. IN NO  
  EVENT SHALL THE AUTHOR OR CONTRIBUTORS BE LIABLE FOR ANY DIRECT, INDIRECT,  
  INCIDENTAL, SPECIAL, EXEMPLARY, OR CONSEQUENTIAL DAMAGES (INCLUDING, BUT NOT  
  LIMITED TO, PROCUREMENT OF SUBSTITUTE GOODS OR SERVICES; LOSS OF USE, DATA, OR  
  PROFITS; OR BUSINESS INTERRUPTION) HOWEVER CAUSED AND ON ANY THEORY OF
```

LIABILITY, WHETHER IN CONTRACT, STRICT LIABILITY, OR TORT (INCLUDING NEGLIGENCE OR OTHERWISE) ARISING IN ANY WAY OUT OF THE USE OF THIS SOFTWARE, EVEN IF ADVISED OF THE POSSIBILITY OF SUCH DAMAGE.

\*

\* The licence and distribution terms for any publically available version or derivative of this code cannot be changed. i.e. this code cannot simply be copied and put under another distribution licence [including the GNU Public Licence.]

\*/

-----  
FreeType V2 <<http://freetype.sourceforge.net/index2.html>>, licensed as below,

The FreeType Project LICENSE  
-----

2006-Jan-27

Copyright 1996-2002, 2006 by  
David Turner, Robert Wilhelm, and Werner Lemberg

Introduction

=====

The FreeType Project is distributed in several archive packages; some of them may contain, in addition to the FreeType font engine, various tools and contributions which rely on, or relate to, the FreeType Project.

This license applies to all files found in such packages, and which do not fall under their own explicit license. The license affects thus the FreeType font engine, the test programs, documentation and makefiles, at the very least.

This license was inspired by the BSD, Artistic, and IJG (Independent JPEG Group) licenses, which all encourage inclusion and use of free software in commercial and freeware products alike. As a consequence, its main points are that:

- o We don't promise that this software works. However, we will be interested in any kind of bug reports. ('as is' distribution)
- o You can use this software for whatever you want, in parts or full form, without having to pay us. ('royalty-free' usage)
- o You may not pretend that you wrote this software. If you use it, or only parts of it, in a program, you must acknowledge somewhere in your documentation that you have used the FreeType code. ('credits')

We specifically permit and encourage the inclusion of this software, with or without modifications, in commercial products. We disclaim all warranties covering The FreeType Project and assume no liability related to The FreeType Project.

Finally, many people asked us for a preferred form for a credit/disclaimer to use in compliance with this license. We thus encourage you to use the following text:

\*\*\*\*

Portions of this software are copyright ?<year> The FreeType Project (www.freetype.org). All rights reserved.

Please replace <year> with the value from the FreeType version you actually use.

## Legal Terms

### 0. Definitions

Throughout this license, the terms 'package', 'FreeType Project', and 'FreeType archive' refer to the set of files originally distributed by the authors (David Turner, Robert Wilhelm, and Werner Lemberg) as the 'FreeType Project', be they named as alpha, beta or final release.

'You' refers to the licensee, or person using the project, where 'using' is a generic term including compiling the project's source code as well as linking it to form a 'program' or 'executable'. This program is referred to as 'a program using the FreeType engine'.

This license applies to all files distributed in the original FreeType Project, including all source code, binaries and documentation, unless otherwise stated in the file in its original, unmodified form as distributed in the original archive. If you are unsure whether or not a particular file is covered by this license, you must contact us to verify this.

The FreeType Project is copyright (C) 1996-2000 by David Turner, Robert Wilhelm, and Werner Lemberg. All rights reserved except as specified below.

### 1. No Warranty

THE FREETYPE PROJECT IS PROVIDED 'AS IS' WITHOUT WARRANTY OF ANY KIND, EITHER EXPRESS OR IMPLIED, INCLUDING, BUT NOT LIMITED TO, WARRANTIES OF MERCHANTABILITY AND FITNESS FOR A PARTICULAR PURPOSE. IN NO EVENT WILL ANY OF THE AUTHORS OR COPYRIGHT HOLDERS BE LIABLE FOR ANY DAMAGES CAUSED BY THE USE OR THE INABILITY TO USE, OF THE FREETYPE PROJECT.

### 2. Redistribution

This license grants a worldwide, royalty-free, perpetual and irrevocable right and license to use, execute, perform, compile, display, copy, create derivative works of, distribute and sublicense the FreeType Project (in both source and object code forms) and derivative works thereof for any purpose; and to authorize others to exercise some or all of the rights granted herein, subject to the following conditions:

- o Redistribution of source code must retain this license file('FTL.TXT') unaltered; any additions, deletions or changes to the original files must be clearly indicated in accompanying documentation. The copyright notices of the unaltered, original files must be preserved in all copies of source files.

- o Redistribution in binary form must provide a disclaimer that states that the software is based in part of the work of the FreeType Team, in the distribution documentation. We also encourage you to put an URL to the FreeType web page in your documentation, though this isn't mandatory.

These conditions apply to any software derived from or based on the FreeType Project, not just the

unmodified files. If you use our work, you must acknowledge us. However, no fee need be paid to us.

### 3. Advertising

Neither the FreeType authors and contributors nor you shall use the name of the other for commercial, advertising, or promotional purposes without specific prior written permission.

We suggest, but do not require, that you use one or more of the following phrases to refer to this software in your documentation or advertising materials: 'FreeType Project', 'FreeType Engine', 'FreeType library', or 'FreeType Distribution'.

As you have not signed this license, you are not required to accept it. However, as the FreeType Project is copyrighted material, only this license, or another one contracted with the authors, grants you the right to use, distribute, and modify it. Therefore, by using, distributing, or modifying the FreeType Project, you indicate that you understand and accept all the terms of this license.

### 4. Contacts

There are two mailing lists related to FreeType:

- o [freetype@nongnu.org](mailto:freetype@nongnu.org)

Discusses general use and applications of FreeType, as well as future and wanted additions to the library and distribution. If you are looking for support, start in this list if you haven't found anything to help you in the documentation.

- o [freetype-devel@nongnu.org](mailto:freetype-devel@nongnu.org)

Discusses bugs, as well as engine internals, design issues, specific licenses, porting, etc.

Our home page can be found at <http://www.freetype.org>

--- end of FTL.TXT ---

Ogg Vorbis <<http://xiph.org/vorbis/>>, licensed as below,

Copyright (c) 2002, Xiph.org Foundation

Redistribution and use in source and binary forms, with or without modification, are permitted provided that the following conditions are met:

- Redistributions of source code must retain the above copyright notice, this list of conditions and the following disclaimer.
- Redistributions in binary form must reproduce the above copyright notice, this list of conditions and the following disclaimer in the documentation and/or other materials provided with the distribution.
- Neither the name of the Xiph.org Foundation nor the names of its contributors may be used to endorse or promote products derived from this software without specific prior written permission.

THIS SOFTWARE IS PROVIDED BY THE COPYRIGHT HOLDERS AND CONTRIBUTORS ``AS IS'' AND ANY EXPRESS OR IMPLIED WARRANTIES, INCLUDING, BUT NOT LIMITED TO, THE IMPLIED WARRANTIES OF MERCHANTABILITY AND FITNESS FOR A PARTICULAR PURPOSE ARE

DISCLAIMED. IN NO EVENT SHALL THE FOUNDATION OR CONTRIBUTORS BE LIABLE FOR ANY DIRECT, INDIRECT, INCIDENTAL, SPECIAL, EXEMPLARY, OR CONSEQUENTIAL DAMAGES (INCLUDING, BUT NOT LIMITED TO, PROCUREMENT OF SUBSTITUTE GOODS OR SERVICES; LOSS OF USE, DATA, OR PROFITS; OR BUSINESS INTERRUPTION) HOWEVER CAUSED AND ON ANY THEORY OF LIABILITY, WHETHER IN CONTRACT, STRICT LIABILITY, OR TORT (INCLUDING NEGLIGENCE OR OTHERWISE) ARISING IN ANY WAY OUT OF THE USE OF THIS SOFTWARE, EVEN IF ADVISED OF THE POSSIBILITY OF SUCH DAMAGE.

-----

FLAC <<http://flac.sourceforge.net/index.html>>, licensed as below,  
Copyright (C) 2000,2001,2002,2003,2004,2005,2006,2007,2008,2009 Josh Coalson

Redistribution and use in source and binary forms, with or without modification, are permitted provided that the following conditions are met:

- Redistributions of source code must retain the above copyright notice, this list of conditions and the following disclaimer:
- Redistributions in binary form must reproduce the above copyright notice, this list of conditions and the following disclaimer in the documentation and/or other materials provided with the distribution.
- Neither the name of the Xiph.org Foundation nor the names of its contributors may be used to endorse or promote products derived from this software without specific prior written permission.

THIS SOFTWARE IS PROVIDED BY THE COPYRIGHT HOLDERS AND CONTRIBUTORS ``AS IS'' AND ANY EXPRESS OR IMPLIED WARRANTIES, INCLUDING, BUT NOT LIMITED TO, THE IMPLIED WARRANTIES OF MERCHANTABILITY AND FITNESS FOR A PARTICULAR PURPOSE ARE DISCLAIMED. IN NO EVENT SHALL THE FOUNDATION OR CONTRIBUTORS BE LIABLE FOR ANY DIRECT, INDIRECT, INCIDENTAL, SPECIAL, EXEMPLARY, OR CONSEQUENTIAL DAMAGES (INCLUDING, BUT NOT LIMITED TO, PROCUREMENT OF SUBSTITUTE GOODS OR SERVICES; LOSS OF USE, DATA, OR PROFITS; OR BUSINESS INTERRUPTION) HOWEVER CAUSED AND ON ANY THEORY OF LIABILITY, WHETHER IN CONTRACT, STRICT LIABILITY, OR TORT (INCLUDING NEGLIGENCE OR OTHERWISE) ARISING IN ANY WAY OUT OF THE USE OF THIS SOFTWARE, EVEN IF ADVISED OF THE POSSIBILITY OF SUCH DAMAGE.

-----





