

DVDVIDEO DIGITAL SURROUND SYSTEM

LX3900SA • LX3950W



**LX3900SA**



**LX3950W**



**PHILIPS**

## Important notes for users in the U.K.

### Mains plug

This apparatus is fitted with an approved 13 Amp plug. To change a fuse in this type of plug proceed as follows:

- 1 Remove fuse cover and fuse.
- 2 Fix new fuse which should be a BS1362 5 Amp, A.S.T.A. or BSI approved type.
- 3 Refit the fuse cover.

If the fitted plug is not suitable for your socket outlets, it should be cut off and an appropriate plug fitted in its place.

If the mains plug contains a fuse, this should have a value of 5 Amp. If a plug without a fuse is used, the fuse at the distribution board should not be greater than 5 Amp.

*Note: The severed plug must be disposed of to avoid a possible shock hazard should it be inserted into a 13 Amp socket elsewhere.*

### How to connect a plug

The wires in the mains lead are coloured with the following code: blue = neutral (N), brown = live (L).

- As these colours may not correspond with the colour markings identifying the terminals in your plug, proceed as follows:
  - Connect the blue wire to the terminal marked N or coloured black.
  - Connect the brown wire to the terminal marked L or coloured red.
  - Do not connect either wire to the earth terminal in the plug, marked E (or  $\perp$ ) or coloured green (or green and yellow).

Before replacing the plug cover, make certain that the cord grip is clamped over the sheath of the lead - not simply over the two wires.

### Copyright in the U.K.

Recording and playback of material may require consent. See Copyright Act 1956 and The Performer's Protection Acts 1958 to 1972.

## Italia

### DICHIARAZIONE DI CONFORMITA'

Si dichiara che l'apparecchio LX3900SA/ LX3950W, Magnavox risponde alle prescrizioni dell'art. 2 comma 1 del D.M. 28 Agosto 1995 n. 548.

Fatto a Eindhoven

Philips Consumer Electronics  
Philips, Glaslaan 2  
5616 JB Eindhoven, The Netherlands

## Norge

Typeskilt finnes på apparatens underside.

**Observer: Nettbryteren er sekundert innkoplet. Den innebygde nettdelen er derfor ikke frakoplet nettet så lenge apparatet er tilsluttet nettkontakten.**

For å redusere faren for brann eller elektrisk støt, skal apparatet ikke utsettes for regn eller fuktighet.

## CAUTION

**Use of controls or adjustments or performance of procedures other than herein may result in hazardous radiation exposure or other unsafe operation.**

## VAROITUS

**Muiden kuin tässä esitettyjen toimintojen säädön tai asetusten muutto saattaa altistaa vaaralliselle säteilylle tai muille vaarallisille toiminnoille.**

### LASER

Type	Semiconductor laser
GaAIAs	
Wave length	650 nm (DVD) 780 nm (VCD/CD)
Output Power	7 mW (DVD) 10 mW (VCD/CD)
Beam divergence	60 degree

Manufactured under license from Dolby Laboratories. "Dolby", "Pro Logic" and the double-D symbol are trademarks of Dolby Laboratories.

Manufactured under license from Digital Theater Systems, Inc. US Pat. No. 5,451,942, 5,956,674, 5,974,380, 5,978,762 and other world-wide patents issued and pending. "DTS" and "DTS Digital Surround" are registered trademarks of Digital Theater Systems, Inc. Copyright 1996, 2000 Digital Theater Systems, Inc. All Rights Reserved.

This product complies with the radio interference requirements of the European Community.

DivX®, DivX Certified, and associated logos are trademarks of DivX Networks, Inc and are used under license.



### CAUTION

VISIBLE AND INVISIBLE LASER RADIATION WHEN OPEN AVOID EXPOSURE TO BEAM

### ADVARSEL

SYNLIG OG USYNLIG LASERSTRÅLING VED ÅBNING  
UNDGÅ UDSÆTTELSE FOR STRÅLING  
VARNING

SYNLIG OCH OSYNLIG LASERSTRÅLNING NÄR DENNA DEL ÄR ÖPPNAD BETRAKTA EJ STRÅLEN  
VARO!

AVATTAESSA OLET ALTTIINA NÄKYVÄLLE JA NÄKYMÄTTÖMÄLLE LASER SÄTEILYLLE. ÄLÄ KATSO SÄTEESEEN

### VORSICHT

SICHTBARE UND UNSICHTBARE LASERSTRAHLUNG WENN ABDECKUNG GEÖFFNET NICHT DEM STRAHL AUSSETZEN

### ATTENTION

RAYONNEMENT LASER VISIBLE ET INVISIBLE EN CAS D'OUVERTURE EXPOSITION DANGEREUSE AU FAISCEAU



This DVD player is in conformity with the EMC directive and low-voltage directive.

For Customer Use:

Read carefully the information located at the bottom of your DVD VIDEO player and enter below the Serial No. Retain this information for future reference.

Model No. DVD VIDEO LX3900SA/  
LX3950W  
Serial No. \_\_\_\_\_

\*CONSUMERS SHOULD NOTE THAT NOT ALL HIGH DEFINITION TELEVISION SETS ARE FULLY COMPATIBLE WITH THIS PRODUCT AND MAY CAUSE ARTIFACTS TO BE DISPLAYED IN THE PICTURE. IN CASE OF 525 OR 625 PROGRESSIVE SCAN PICTURE PROBLEMS, IT IS RECOMMENDED THAT THE USER SWITCH THE CONNECTION TO THE 'STANDARD DEFINITION' OUTPUT. IF THERE ARE QUESTIONS REGARDING OUR TV SET COMPATIBILITY WITH THIS MODEL 525p AND 625p DVD PLAYER, PLEASE CONTACT OUR CUSTOMER SERVICE CENTRE.

**English**

Hereby, Philips Consumer Electronics, B. U. Peripherals & Accessories, declares that this product is in compliance with the essential requirements and other relevant provisions of Directive 1999/5/EC.

**Français**

Par la présente, Philips Consumer Electronics, B. U. Peripherals & Accessories, déclare que l'appareil est conforme aux exigences essentielles et aux autres dispositions pertinentes de la directive 1999/5/CE.

**Español**

Por medio de la presente, Philips Consumer Electronics, B. U. Peripherals & Accessories, declara que el cumple con los requisitos esenciales y cualesquiera otras disposiciones aplicables o exigibles de la Directiva 1999/5/CE.

**Deutsch**

Hiermit erklärt Philips Consumer Electronics, B. U. Peripherals & Accessories die Übereinstimmung des Gerätes mit den grundlegenden Anforderungen und den anderen relevanten Festlegungen der Richtlinie 1999/5/EG.

**Nederlands**

Hierbij verklaart, Philips Consumer Electronics, B. U. Peripherals & Accessories dat het toestel in overeenstemming is met de essentiële eisen en de andere relevante bepalingen van richtlijn 1999/5/EG.

**Italiano**

Con la presente Philips Consumer Electronics, B. U. Peripherals & Accessories dichiara che questo è conforme ai requisiti essenziali ed alle altre disposizioni pertinenti stabilite dalla direttiva 1999/5/CE.

**Svenska**

Härmed intygar, Philips Consumer Electronics, B. U. Peripherals & Accessories, att denna står i överensstämmelse med de väsentliga egenskapskrav och övriga relevanta bestämmelser som framgår av direktiv 1999/5/EG.

**Dansk**

Undertegnede Philips Consumer Electronics, B. U. Peripherals & Accessories erklærer herved, at følgende udstyr overholder de væsentlige krav og øvrige relevante krav i direktiv 1999/5/EF.

**Finnish**

Philips Consumer Electronics, B. U. Peripherals & Accessories vakuuttaa täten että tyypinen laite on direktiivin 1999/5/EY oleellisten vaatimusten ja sitä koskevien direktiivin muiden ehtojen mukainen.

**Portuguese**

Philips Consumer Electronics, B. U. Peripherals & Accessories declara que este está conforme com os requisitos essenciais e outras disposições da Directiva 1999/5/CE.

**Ελληνικά**

ΜΕ ΤΗΝ ΠΑΡΟΥΣΑ Philips Consumer Electronics, B. U. Peripherals & Accessories ΔΗΛΩΝΕΙ ΟΤΙ ΣΥΜΜΟΡΦΩΝΕΤΑΙ ΠΡΟΣ ΤΙΣ ΟΥΣΙΩΔΕΙΣ ΑΠΑΙΤΗΣΕΙΣ ΚΑΙ ΤΙΣ ΛΟΙΠΕΣ ΣΧΕΤΙΚΕΣ ΔΙΑΤΑΞΕΙΣ ΤΗΣ ΟΔΗΓΙΑΣ 1999/5/ΕΚ.

**DK**

**Advarsel: Usynlig laserstråling ved åbning når sikkerhedsafbrydere er ude af funktion. Undgå udsættelse for stråling.**

**Bemærk: Netafbryderen er sekundært indkoblet og afbryder ikke strømmen fra nettet. Den indbyggede netdel er derfor tilsluttet til lysnettet så længe netstikket sidder i stikkontakten.**

**S****Klass 1 laseraparat**

**Varning! Om apparaten används på annat sätt än i denna bruksanvisning specificerats, kan användaren utsättas för osynlig laserstråling, som överskrider gränsen för laserklass 1.**

**Observera! Stömbrytaren är sekundärt kopplad och bryter inte strömmen från nätet. Den inbyggda nätdelen är därför ansluten till elnätet så länge stickproppen sitter i vägguttaget.**

**SF****Luokan 1 laserlaite**

**Varoitus! Laitteen käyttäminen muulla kuin tässä käyttöohjeessa mainitulla tavalla saattaa altistaa käyttäjän turvallisuusluokan 1 ylittävälle näkymättömälle lasersäteilylle. Oikeus muutoksiin varataan. Laite ei saa olla alttiina tippu- ja roiskevedelle.**

**Huom. Toiminnanvalitsin on kytketty toisipuolelle, eikä se kytke laitetta irti sähköverkosta. Sisäänrakennettu verkko-osa on kytkettynä sähköverkkoon aina silloin, kun pistoke on pistorasiassa.**

## Index

Due to the inconsistency of disc formats provided by various disc manufacturers, your DVD system may require a playability enhancement or upgrade. As DVD technology advances, these enhancement will become common and will be easy to complete. Go to [www.p4c.philips.com](http://www.p4c.philips.com) for software upgrade.

En raison de la diversité des formats utilisés par les fabricants, votre système DVD peut nécessiter l'ajout de périphériques ou une mise à niveau logicielle. Au fur et à mesure des progrès de la technologie DVD, ces périphériques se font de plus en plus courants et aisés à intégrer. Pour télécharger la mise à niveau logicielle, visitez le site [www.p4c.philips.com](http://www.p4c.philips.com).

Debido a los diferentes formatos de discos disponibles en el mercado, es posible que deba realizar mejoras o actualizaciones en el sistema de DVD relativas a las funciones de reproducción. Conforme la tecnología DVD avanza, estas mejoras estarán al alcance de todo tipo de usuarios y se podrán llevar a cabo fácilmente. Visite la página "[www.p4c.philips.com](http://www.p4c.philips.com)" para buscar información sobre actualizaciones de software.

Da das Disk-Format je nach Hersteller verschieden ist, ist für Ihr DVD-System möglicherweise die Erweiterung der Spielbarkeit oder eine Aktualisierung erforderlich. Da die DVD-Technologie sich ständig weiterentwickelt, werden sich diese Erweiterungen durchsetzen und einfach auszuführen sein. Gehen Sie zu für Ihre Software-Aktualisierung zu „[www.p4c.philips.com](http://www.p4c.philips.com)“.

Doordat fabrikanten verschillende schijfindeligen aanbieden, moet uw dvd-systeem mogelijk worden geüpgradet of uitgebreid. Naarmate de dvd-technologie zich verder ontwikkelt, zullen deze uitbreidingen normaal worden en zult u ze gemakkelijk kunnen uitvoeren. Ga naar "[www.p4c.philips.com](http://www.p4c.philips.com)" om uw software te upgraden.

A causa della differenza di formato tra i dischi forniti dai vari produttori, il sistema DVD potrebbe richiedere un potenziamento o aggiornamento della riproducibilità. Col progredire della tecnologia DVD, questi potenziamenti diverranno comuni e facili da implementare. Visitare "[www.p4c.philips.com](http://www.p4c.philips.com)" per scaricare gli aggiornamenti del software.

**English** ..... 6

**Français** ..... 42

**Español** ..... 78

**Deutsch** ..... 114

**Nederlands** ..... 150

**Italiano** ..... 186

English

Français

Español

Deutsch

Nederlands

Italiano

## Contents

### General Information

Supplied accessories .....	8
Care and safety information .....	8

### Connections

Step 1: Placing the speakers and subwoofer .....	9
Step 2: Connecting speakers and subwoofer .....	9
Step 3: Connecting TV .....	10
Using Scart jacks .....	10
Using S-Video jack .....	10
Using Composite Video jack (CVBS) .....	10
Step 4: Connecting FM/MW antennas ..	11
Step 5: Connecting the power cord .....	11

### Connections (optional)

Connecting a VCR or Cable/Satellite Box .....	12
Viewing and listening to the playback .....	12
Using the VCR for recording DVD playback .....	12
Connecting digital audio equipment .....	13
Listening to the playback .....	13

### Functional Overview

Main unit and remote control .....	14
Control buttons available on the remote only .....	14-15

### Getting Started

Step 1: Inserting batteries into the remote control .....	16
Using the remote control to operate the system .....	16
Step 2: Setting the TV .....	16
Selecting the colour system that corresponds to your TV .....	17
Setting the TV Display .....	17
Step 3: Setting language preferences .....	18
On-Screen Display (OSD) language ..	18
Audio, Subtitle and Disc menu languages .....	18
Step 4: Setting the speakers' channels ..	19

### Disc Operations

Playable discs .....	20
Playing discs .....	20
Auto Eco Power standby mode .....	21
Basic playback controls .....	21
Selecting various repeat/shuffle functions .....	21
Repeat play mode .....	21
Repeating a section within a chapter/track .....	21
Other operations for video playback (DVD/VCD/SVCD) .....	22
Using the Disc Menu .....	22
Zooming in .....	22
Using the OSD Menu .....	22
Resuming playback from the last stopped point .....	23
Advancing by frame .....	23
Changing sound track language .....	23
Changing subtitle language (DVD only) .....	23
Viewing from another angle (DVD only) .....	23
Selecting a title (DVD only) .....	23
Playback Control (PBC) (VCD only) ..	24
Preview Function (VCD only) .....	24
Playing MP3/JPEG/DivX/MPEG-4 disc ..	25
Playing MP3 music and JPEG picture simultaneously .....	25
Playing Super Audio CD (SACD) .....	26
Special features for picture disc playback .....	26
Preview Function .....	26
Zoom picture .....	26
Playback with multi-angles .....	26
Scan Effect .....	26

## Contents

English

### DVD Setup Menu Options

General Setup Menu .....	27
Locking/Unlocking the disc for viewing .....	27
Dimming system's display screen.....	27
Programming disc tracks (not for Picture CD/MP3/SACD) .....	27–28
OSD language .....	28
Screen Saver – turning on/off .....	28
DivX(R) VOD registration code .....	28
Audio Setup Menu .....	29
Setting the analogue output.....	29
Speaker Setup .....	29
Night mode – turning on/off .....	29
Video Setup Menu .....	30
TV Type .....	30
TV Display .....	30
Picture Setting.....	30–31
Preference Setup Menu .....	31
Audio, Subtitle, Disc Menu .....	31
Restricting playback by Parental Control .....	31–32
PBC .....	32
MP3/JPEG Navigator – turning on/off .....	32
Changing the Password .....	33
Restoring to original settings .....	33

### Tuner Operations

Tuning to radio stations .....	34
Presetting radio stations .....	34
Using the Plug and Play .....	34
Automatic presetting .....	35
Manual presetting .....	35
Selecting a preset radio station .....	35
Deleting a preset radio station .....	35

### Sound and Volume Controls

Sound Control .....	36
Selecting surround sound .....	36
Selecting digital sound effects .....	36
Volume Control .....	36

### Other Functions

Switching on/off .....	37
Switching to an active mode .....	37
Switching to Eco Power standby mode .....	37
Using the remote to operate your 'Philips' television .....	37
Recording to an external device .....	37
Setting the Sleep timer .....	37

### Troubleshooting .....

38–39
-------

### Specifications .....

40
----

### Glossary .....

41
----

### Language Code .....

223
-----

## General Information

### Supplied accessories

Scart cable (black)



FM wire antenna



MW loop antenna



Remote control  
and two batteries  
(12nc: 3139 258 70031)

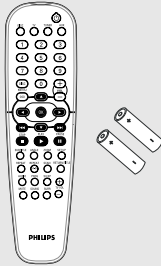

Speaker brackets  
and screws  
(5x)



### Additional accessories (only for LX3950W)

Wireless  
transmitter

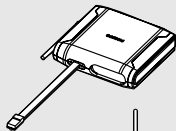

Wireless receiver

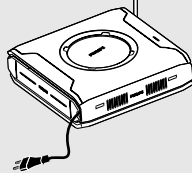
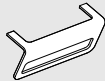

Table stand for  
wireless receiver



### Care and safety information

#### Avoid high temperatures, moisture, water and dust

– Do not expose the system, batteries or discs to humidity, rain, sand or excessive heat (caused by heating equipment or direct sunlight). Always keep the disc tray closed to avoid getting dust on the lens.

#### Avoid condensation problem

– The lens may cloud over when the player is suddenly moved from cold to warm surroundings, making it impossible to play a disc. Leave the player in the warm environment until the moisture evaporates.

#### Do not block the vents

– Do not operate the DVD system in an enclosed cabinet and allow about 10 cm (4 inches) of free space all around the player for adequate ventilation.



#### Care of disc

– To clean a CD, wipe it in a straight line from the centre toward the edge using a soft, lint-free cloth. Do not use cleaning agent, as they may damage the disc.



– Write only on the printed side of a CD-R/CD-RW and only with a soft felt-tipped pen.  
– Handle the disc by its edge, do not touch the surface.

#### Care of the cabinet

– Use a soft cloth slightly moistened with a mild detergent solution. Do not use a solution containing alcohol, spirits, ammonia or abrasives.

#### Finding a suitable location

– Place the player on a flat, hard, stable surface.



## Connections

English

### Step 1: Placing the speakers and subwoofer

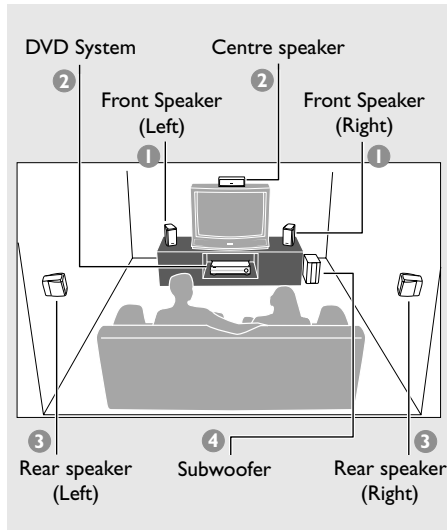

For best possible surround sound, all the speakers (except subwoofer) should be placed at the same distance from the listening position.

- ① Place the front left and right speakers at equal distances from the TV and at an angle of approximately 45 degrees from the listening position.
- ② Place the centre speaker above the TV or the DVD system so that the centre channel's sound is localised.
- ③ Place the surround speakers at normal listening ear level facing each other or hang on the wall.
- ④ Place the subwoofer on the floor near the TV.

#### Helpful Hints:

- To avoid magnetic interference, do not position the front speakers too close to your TV.
- Allow adequate ventilation around the DVD system.

### Step 2: Connecting speakers and subwoofer

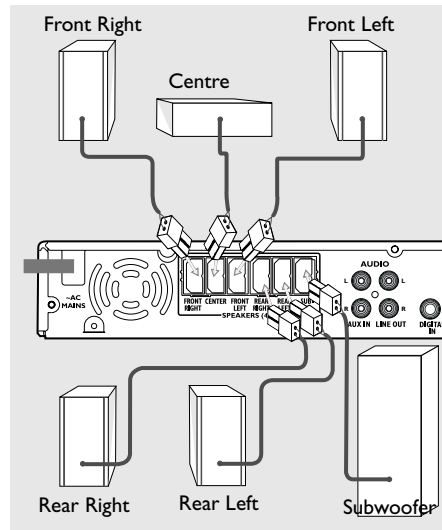

Connect the supplied speaker systems using the fixed speaker cables by matching the colours of the jacks and speaker cables.

#### For LX3950W wireless system connection, please refer to the separate 'Quick Use Guide'.

The wireless transmitter and receiver give you the option for wireless speaker connection.

#### Helpful Hints:

- Ensure that the speaker cables are correctly connected. Improper connections may damage the system due to short-circuit.
- To prevent unwanted noise, do not place the wireless transmitter and receiver too close to the DVD system, AC power adaptor, TV or other radiation sources.

## Connections

### Step 3: Connecting TV

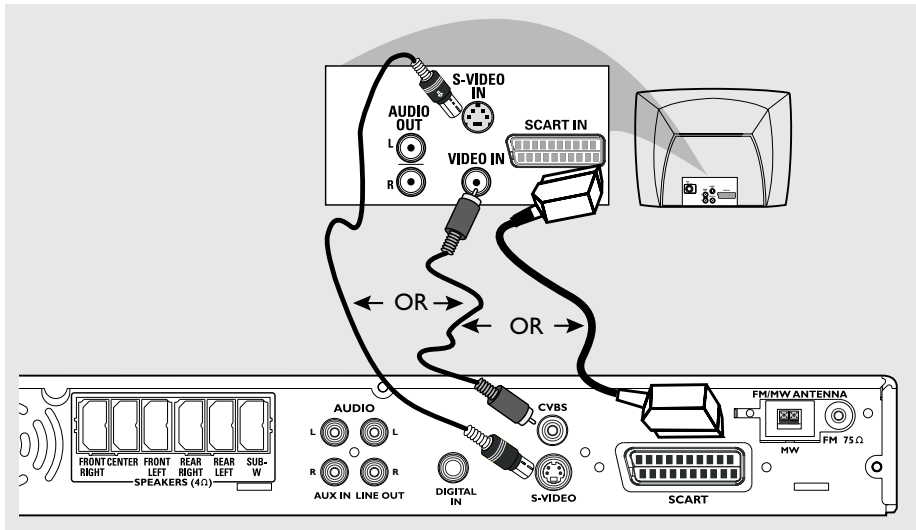

#### IMPORTANT!

- You only need to make **one** video connection from the following options, depending on the capabilities of your TV.
- Connect the DVD system directly to the TV.
- Scart (RGB) Video provides better picture quality than S-Video. These options must be available on your TV.
- If both S-Video and Scart video are used to connect to your TV, the TV signal will detect automatically to SCART when you power up the DVD system.

#### Using Scart jack

- Use the supplied scart video cable (black) to connect the DVD system's **SCART** jack to the corresponding Scart input jacks on the TV.  
OR

#### Using S-Video jack

- Use an S-video cable (not supplied) to connect the DVD system's **S-VIDEO OUT** jack to the S-Video input jack (or labelled as Y/C or S-VHS) on the TV.  
OR

#### Using Composite Video jack (CVBS)

- Use a composite video cable (yellow - not supplied) to connect the DVD system's **CVBS** jack to the video input jack (or labelled as A/V In, Video In, Composite or Baseband) on the TV.

## Connections

English

### Step 4: Connecting FM/MW antennas

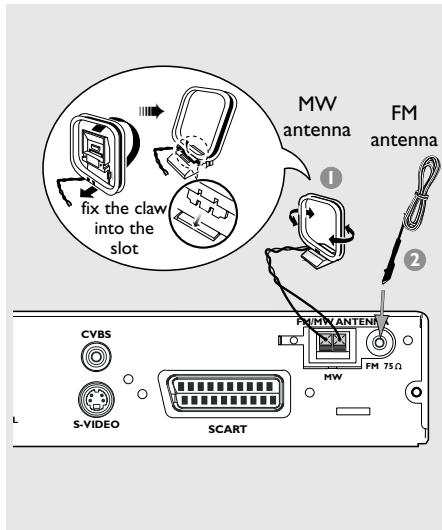

- 1 Connect the supplied MW loop antenna to the **MW** jack. Place the MW loop antenna on a shelf or attach it to a stand or wall.
- 2 Connect the supplied FM antenna to the **FM** jack. Extend the FM antenna and fix its ends to the wall.

For better FM stereo reception, connect an external FM antenna (not supplied).

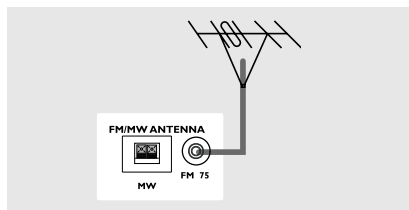

#### Helpful Hints:

- Adjust the position of the antennas for optimal reception.
- Position the antennas as far as possible from your TV, VCR or other radiation source to prevent unwanted interference.

### Step 5: Connecting the power cord

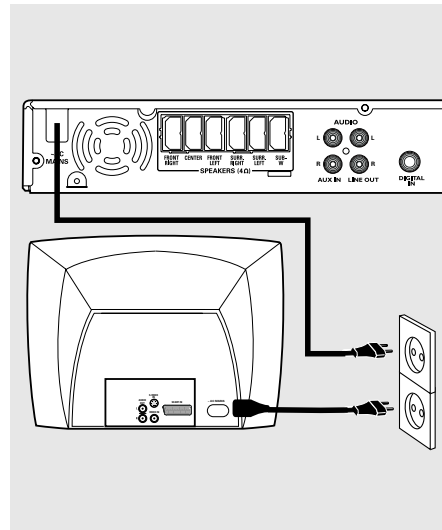

**After everything is connected properly, plug the AC power cord into the power outlet.**

Never make or change any connections with the power switched on.

#### Helpful Hint:

- Refer to the type plate on the rear or bottom of the system for identification and supply ratings.

## Connections (Optional)

### Connecting a VCR or Cable/Satellite Box

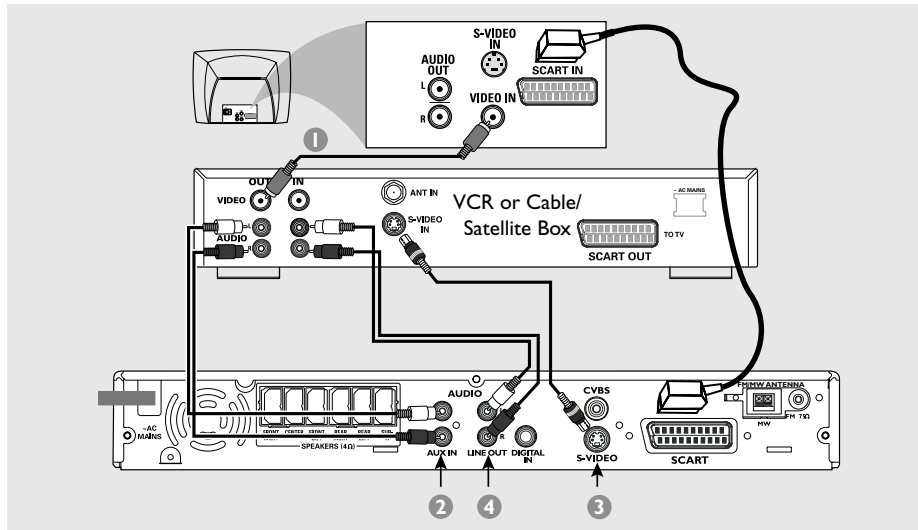

#### Viewing and listening to the playback

- 1 Connect the VCR or Cable/Satellite Box to the TV as shown.
- 2 Connect the DVD system's **AUX IN (R/L)** jacks to the **AUDIO OUT** jacks on the VCR or cable/satellite box.

Before starting operation, press **AUX/DI** on the remote to select "**AUX**" in order to activate the input source.

#### Using the VCR for recording DVD playback

Some DVDs are copy-protected. You cannot record or dub protected discs using a VCR.

- 3 Connect the DVD system's **S-VIDEO** jack to the **S-VIDEO IN** jack on the VCR.
- 4 Connect the DVD system's **LINE OUT (R/L)** jacks to the **AUDIO IN** jacks on the VCR.

This will allow you to make analogue stereo (two channel, right and left) recordings.

#### To view DVD playback while recording,

you must connect the DVD system to your TV using SCART (as shown above) connection.

## Connections (Optional)

### Connecting digital audio equipment

English

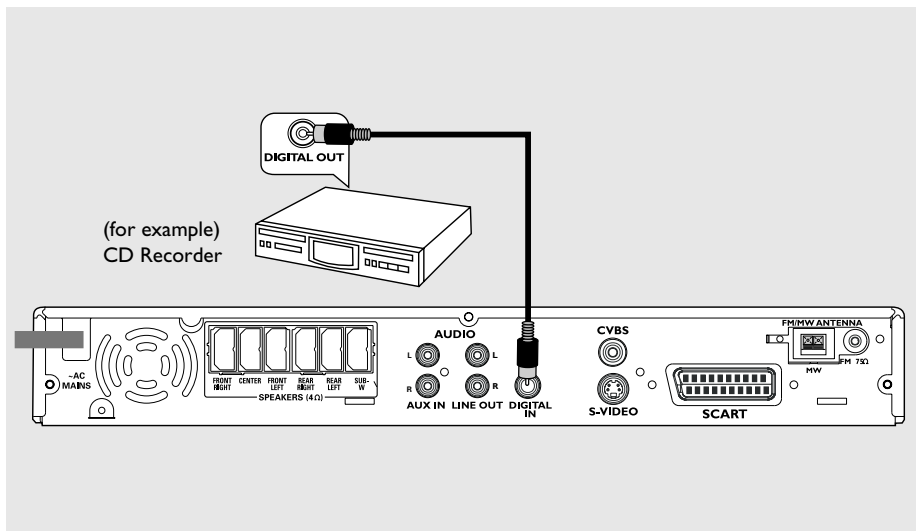

#### Listening to the playback

- Connect the DVD system's **DIGITAL IN** jack to the DIGITAL OUT jack on a digital audio device.

Before starting operation, press **AUX/DI** on the remote to select “DI” in order to activate the input source.

#### Helpful Hints:

- Some DVDs are copy-protected. You cannot record the disc through a VCR or digital recording device.
- You cannot hear or record the SACD or MP3-CD playback if you use the digital connection.
- For your playback through DIGITAL IN connection, set the digital output of that player to PCM format.
- Always refer to the owner's manual of the other equipment for complete connection and use details.

## Functional Overview

### Main unit and remote control

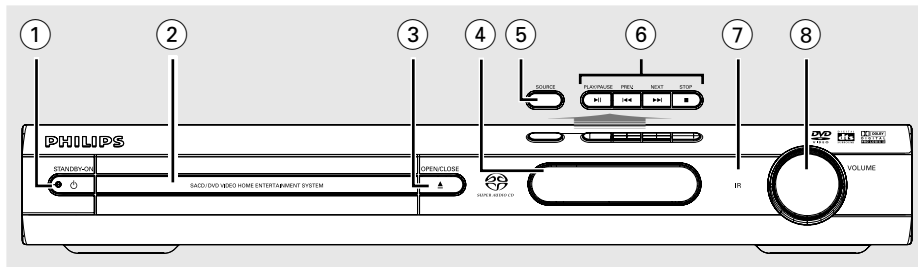

#### ① **STANDBY ON (⏻)**

- Switches to Eco Power standby mode or turns on the system.
- Led ON in Eco Power standby mode.

#### ② **Disc tray**

- Opens/Closes the disc tray.

#### ③ **OPEN•CLOSE ▲**

- Opens/Closes the disc tray.

#### ④ **System display panel**

#### ⑤ **SOURCE**

- Selects the relevant active source mode: DISC, TV, TUNER or AUX/DI.
- DISC: switches to DISC source mode.
- TV: switches to TV source mode and/or \*to turn on the Philips TV (only on the remote control).
- TUNER: toggles between FM and MW band.
- AUX/DI: toggles between AUX and DIGITAL IN source mode.

#### ⑥ **▶ II PLAY•PAUSE**

- DISC: starts/pauses playback.
- TUNER: starts preset radio station installation in Plug & Play mode (only on the main unit).

#### ◀◀ **PREV / NEXT** ▶▶

- DISC: \*searches backward/forward or selects a track.
- TV: selects previous/next channel (Philips TV only).
- TUNER: tunes the radio frequency up/down.

#### ■ **STOP**

- Exits an operation.
- DISC: stops playback.
- TUNER: \*erases a preset radio station.

#### ⑦ **iR**

- Point the remote control towards this sensor.

#### ⑧ **VOLUME (VOL + -)**

- Adjusts the volume level.

#### Control buttons available on the remote only

#### ⑨ **DISC MENU** (DISC source mode only)

- Enters or exits disc contents menu.
- For VCD version 2.0 only; In stop mode, turns on/off playback control (PBC) mode. During playback, returns to main menu.

#### ⑩ **OSD MENU** (DISC source mode only)

- Enters or exits on-screen display.

#### ⑪ **◀▶ ▲▼**

- Selects movement direction in the menu.
- Use ◀▶ to select a preset radio station.
- Use ▲▼ to select auto tuning in Tuner source mode.

\* = Press and hold the button for more than two seconds.

## Functional Overview

English

- ⑫ **ANGLE**
  - Select a DVD disc camera angle (if available).
- ⑬ **SUBTITLE**
  - Selects a subtitle language.
- ⑭ **REPEAT**
  - Selects various repeat modes.
- ⑮ **REPEAT A-B**
  - Repeats a specific section on a disc.
- ⑯ **AUDIO**
  - Selects an audio language (DVD) or an audio channel (CD).
- ⑰ **MUTE**
  - Mutes or restores the volume.
- ⑱ **PROG**
  - DISC: starts programming.
  - TUNER: starts \*automatic/ manual preset programming.
- ⑳ **SLEEP**
  - Sets the sleep timer function.
- ㉑ **SURR**
  - Selects multichannel surround or stereo mode.
- ㉒ **TVVOL** + –
  - Adjusts TV volume (Philips TV only).
- ㉓ **SCAN**
  - Plays the first few seconds of each track/ chapter within a disc.
- ㉔ **RETURN/TITLE**
  - To go back to previous menu.
  - Displays the disc's Title menu (if available).
- ㉕ **SETUP**
  - Enters or exits system setup menu.
- ㉖ **ZOOM**
  - Enlarges a picture on the TV screen.

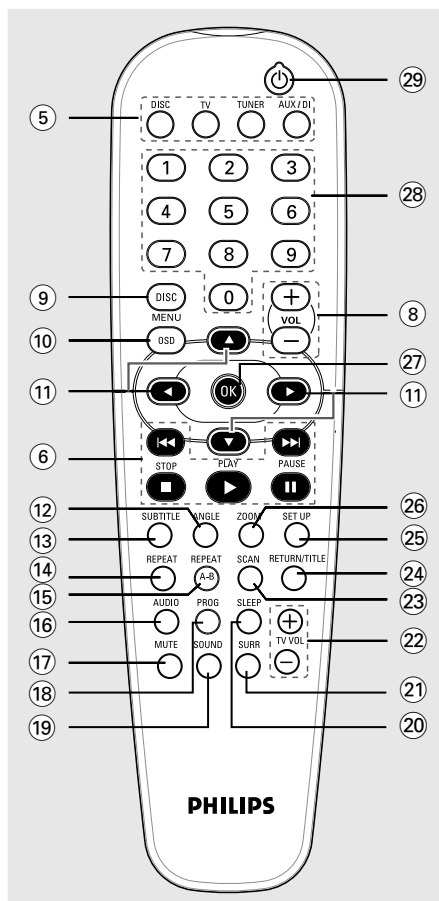

- ㉗ **OK**
  - Confirms a selection.
- ㉘ **Numeric Keypad (0-9)**
  - Enters a track/title number of the disc.
  - Enters a number of a preset radio station.
- ㉙ **⏻**
  - Switches to Eco Power standby mode.
  - In TV mode, \*switches Philips TV on/off.

\* = Press and hold the button for more than two seconds.

## Getting Started

### Step 1: Inserting batteries into the remote control

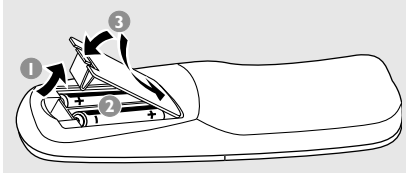

- 1 Open the battery compartment.
- 2 Insert two batteries type R06 or AA, following the indications (+ -) inside the compartment.
- 3 Close the cover.

### Using the remote control to operate the system

- 1 Aim the remote control directly at the remote sensor (iR) on the front panel.
- 2 Select the source you wish to control by pressing one of the source select buttons on the remote control (for example TV, TUNER).
- 3 Then select the desired function (for example ► ||, |◀◀, ▶▶▶).

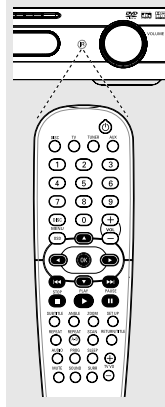

### Step 2: Setting the TV

#### IMPORTANT!

Make sure you have completed all the necessary connections. (See page 10 "Connecting TV").

- 1 Press **SOURCE** control until "DISC" appears on the display panel (or press DISC on the remote).
- 2 Turn on the TV and set to the correct video-in channel. You should see the blue DVD background screen on the TV.  
→ Usually this channel is between the lowest and highest channels and may be called FRONT, A/V IN, VIDEO. See your TV manual for more details.  
→ Or, you may go to channel 1 on your TV, then press the Channel down button repeatedly until you see the Video In channel.  
→ Or, the TV remote control may have a button or switch that chooses different video modes.

#### CAUTION!

- Remove batteries if they are exhausted or if the remote is not to be used for a long time.
- Do not use old and new or different types of batteries in combination.
- Batteries contain chemical substances, so they should be disposed of properly.



## Getting Started

### Selecting the colour system that corresponds to your TV

In order for a DVD to play on this DVD system, the colour system of the DVD, the TV and the DVD player should match. Before changing the TV system, determine the colour system of your TV.

- 1 In disc mode, press **SETUP**.
- 2 Press **▶** repeatedly to select {VIDEO SETUP PAGE}.
- 3 Press **▲▼** to highlight {TV TYPE}, then press **▶**.

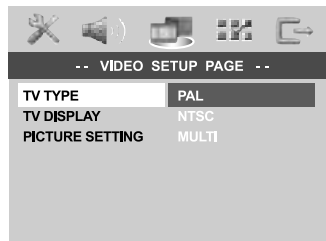

- 4 Press **▲▼** to highlight one of the options below:

**PAL** – Select this if the connected TV has the PAL colour system. It will change the video signal of an NTSC disc and output it to PAL format.

**NTSC** – Select this if the connected TV has the NTSC colour system. It will change the video signal of a PAL disc and output it to NTSC format.

**MULTI** – Select this if the connected TV is compatible with both NTSC and PAL (multi-system). The output format will be in accordance with the video signal of the disc.

- 5 Select a setting and press **OK**.
  - Follow the instructions show on the TV to confirm the selection (if any).
  - If a blank/distorted TV screen appears, wait for 15 seconds for auto recovery.

### Setting the TV Display

Set the aspect ratio of the DVD Player according to the TV you have connected. The format you select must be available on the disc. If it is not, the setting for TV display will not affect the picture during playback.

- 1 In disc mode, press **SETUP**.
- 2 Press **▶** repeatedly to select {VIDEO SETUP PAGE}.
- 3 Press **▲▼** to highlight {TV DISPLAY}, then press **▶**.

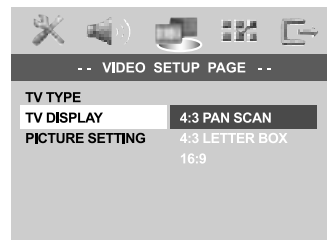

- 4 Press **▲▼** to highlight one of the options below:

#### 4:3 PAN SCAN –

Select this if you have a conventional TV and want both sides of the picture to be trimmed or formatted to fit your TV screen.



#### 4:3 LETTER BOX –

Select this if you have a conventional TV. In this case, a wide picture with black bands on the upper and lower portions of the TV screen will be displayed.



**16:9** – Select this if you have a wide-screen TV.



- 5 Select a setting and press **OK**.

**TIPS:** To return to the previous menu, press **◀**.  
To remove the menu, press **SETUP**.

## Getting Started

### Step 3: Setting language preferences

You can select your preferred language settings so that this DVD system will automatically switch to the language for you whenever you load a disc. If the language selected is not available on the disc, the disc's default setting language will be used instead. The OSD (on-screen display) language for the system menu will remain as you set it, regardless of various disc languages.

#### On-screen display (OSD) language

- 1 In disc mode, press **SETUP**.
- 2 Press **▶** to select {GENERAL SETUP PAGE}.
- 3 Press **▲▼** to highlight {OSD LANGUAGE}, then press **▶**.

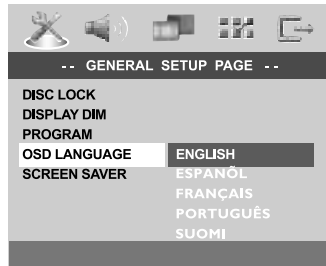

- 4 Press **▲▼** to select a language and press **OK** to confirm.

#### Audio, Subtitle and Disc menu languages

- 1 Press **■** twice to stop playback (if any), then press **SETUP**.
- 2 Press **▶** repeatedly to select {PREFERENCE PAGE}.
- 3 Press **▲▼** to highlight one of the options below at a time, then press **▶**.
  - {AUDIO} (disc's soundtrack)
  - {SUBTITLE} (disc's subtitles)
  - {DISC MENU} (disc's menu)



- 4 Press **▲▼** to select a language and press **OK** to confirm.

**If the language you want is not in the list, then select {OTHERS}.**

Use the **numeric keypad (0-9)** on the remote to enter the 4-digit language code 'XXXX' (see page 223 "Language Code") and press **OK** to confirm.

- 5 Repeat steps 3~4 for other settings.

**TIPS:** To return to the previous menu, press **◀**.  
To remove the menu, press **SETUP**.

## Getting Started

English

### Step 4: Setting the speakers' channels

You can adjust the delay times (centre and surround only) and volume level for individual speakers. These adjustments let you optimise the sound according to your surroundings and setup.

#### IMPORTANT!

Press **SURR** button on the remote to select **Multi-channel surround mode** before adjusting the speaker settings.

- 1 Press **■** to stop playback, then press **SETUP**.
- 2 Press **▶** repeatedly to select {AUDIO SETUP PAGE}.
- 3 Press **▲▼** to highlight {SPEAKER SETUP}, then press **▶**.

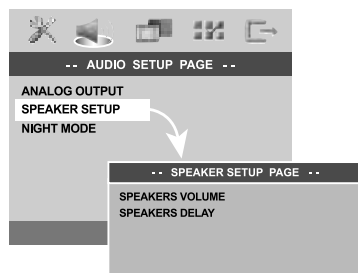

- 4 Enter its submenu by pressing **▶**.

- 5 Press **▲▼** to highlight one of the options below at a time, then press **▶**.

{SPEAKERS VOLUME} – Volume level setting for individual speakers (-6dB ~ +6dB).

SPEAKERS VOLUME SETUP		
FRONT LEFT	<input type="text"/>	0dB
FRONT RIGHT	<input type="text"/>	0dB
CENTER	<input type="text"/>	0dB
SUBWOOFER	<input type="text"/>	0dB
REAR LEFT	<input type="text"/>	0dB
REAR RIGHT	<input type="text"/>	0dB

{SPEAKERS DELAY} – Delay times setting in relation to the listening position/distance for center and surround speakers (1m ~ 10m).

SPEAKERS DELAY SETUP		
CENTER	<input type="text"/>	1.0m
REAR LEFT	<input type="text"/>	1.0m
REAR RIGHT	<input type="text"/>	1.0m

- 6 Press **◀▶** to adjust the setting that best suit your surround sound needs.
- 7 Press **OK** to confirm.

#### Helpful Hints:

- Use the longer delay time settings when the surround speakers are closer to the listener than the front speakers.
- The test tone will be automatically generated to help you judge the sound level of each speaker.

**TIPS:** To return to the previous menu, press **◀**.  
To remove the menu, press **SETUP**.

## Disc Operations

### IMPORTANT!

- If the inhibit icon (ø or X) appears on the TV screen when a button is pressed, it means the function is not available on the current disc or at the current time.
- DVD discs and players are designed with regional restrictions. Before playing a disc, make sure the disc is for the same zone as your player.
- Do not push on the disc tray or put any objects other than discs on the disc tray. Doing so may cause the disc player to malfunction.

### Playable discs

Your DVD home cinema system will play:

- Digital Versatile Discs (DVDs)
- Video CDs (VCDs)
- Super Video CDs (SVCDs)
- Super Audio CDs (SACDs)
- Finalised Digital Video Discs + Recordable[Rewritable] (DVD+R[W])
- Audio Compact Discs (CDs)
- MP3 discs, picture (Kodak, JPEG) files on CD-R(W).
  - JPEG/ISO 9660 format
  - Maximum 30 characters display
  - Supported sampling frequencies : 32 kHz, 44.1 kHz, 48 kHz
  - Supported Bit-rates : 32~256 (kbps), variable bit rates
- MPEG-4 files on CD-R[W]:
  - Simple profile
  - Advanced simple profile (640-480)
- DivX disc on CD-R[W]/DVD+R[W]:
  - DivX 3.11, 4.x and 5.x
  - GMC (Global Motion Compensation) and QP (Quarter Pixel) not supported.



**TIPS:** The operating features described here might not be possible for certain discs. Always refer to the instructions supplied with the discs.

### Region Codes

DVDs must be labelled for **ALL** regions or **Region 2** in order to play on this DVD system. You cannot play discs that are labelled for other regions.



#### Helpful Hints:

- It may not be possible to play CD-R/RW or DVD-R/RW in all cases due to the type of disc or condition of the recording.
- If you are having trouble playing a certain disc, remove the disc and try a different one. Improperly formatted discs will not play on this DVD system.

### Playing discs

- 1 Press **SOURCE** control until “DISC” appears on the display panel (or press **DISC** on the remote).
- 2 Turn on the TV power and set to the correct Video In channel. (See page 16 “Setting the TV”).
  - You should see the blue DVD background screen on the TV.
- 3 Press **OPEN•CLOSE** once to open the disc tray and load a disc, then press the same button again to close the disc tray.
  - Make sure the disc label is facing up. For double-sided discs, load the side you want to play face up.
- 4 Playback will start automatically.
  - If a disc menu shows on the TV, see page 22 “Using the Disc Menu”.
  - If the disc is locked by parental control, you must enter your six-digit password. (See page 31-32).

## Disc Operations

### Auto Eco Power standby mode

This is a power-saving feature, the system will automatically switch to Eco Power standby mode if you do not press any buttons within 30 minutes after a disc has stopped playing.

### Basic playback controls

#### Pausing playback

- During playback, press **II (▶II)**.  
→ To resume normal playback, press **PLAY ▶ (▶II)**.

#### Selecting another track/chapter

- Press **◀◀ / ▶▶** or use the **numeric keypad (0-9)** to key in a track/chapter number.  
→ If repeat mode is active, pressing **◀◀ / ▶▶** will replay the same track/chapter.

#### Searching backward/forward

- Press and hold **◀◀ / ▶▶**. To resume normal playback, press **PLAY ▶ (▶II)**.  
→ While searching, pressing **◀◀ / ▶▶** again will decrease/increase the search speed.

#### Stopping playback

- Press **■**.

### Selecting various repeat/shuffle functions

#### Repeat play mode

- While playing a disc, press **REPEAT** continuously to choose a 'Play Mode'.

#### DVD

- RPT ONE (repeat chapter)
- RPT TT (repeat title)
- SHUFFLE (random play)
- RPT SHF (repeat shuffling)
- RPT OFF (repeat off)

#### VCD/SVCD/CD

- RPT ONE (repeat track)
- RPT ALL (repeat disc)
- SHUFFLE (random play)
- RPT SHF (repeat shuffling)
- RPT OFF (repeat off)

#### MP3/SACD/DivX

- RPT FLD (repeat folder)
- RPT ONE (repeat track)
- SHUFFLE (random play)
- RPT OFF (repeat off)

#### Helpful Hint:

– For VCD, repeat playback is not possible if the PBC mode is switched on.

#### Repeating a section within a chapter/track

- 1 While playing a disc, press **REPEAT A-B** at your chosen starting point.
- 2 Press **REPEAT A-B** again at your chosen end point.  
→ The section A and B can be set only within the same chapter/track.  
→ The section will now repeat continuously.
- 3 To exit the sequence, press **REPEAT A-B**.

**TIPS:** The operating features described here might not be possible for certain discs. Always refer to the instructions supplied with the discs.

## Disc Operations

### Other operations for video playback (DVD/VCD/SVCD)

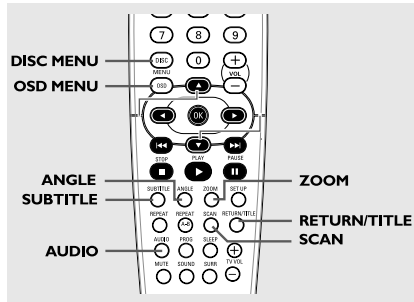

### Using the Disc Menu

Depending on the disc, a menu may appear on the TV screen once you load in the disc.

#### To select a playback feature or item

- Use ◀▶▲▼ keys or **numeric keypad (0-9)** on the remote, then press **OK** to start playback.

#### To access or remove the menu

- Press **DISC MENU** on the remote.

### Zooming in

This function allows you to enlarge the picture on the TV screen and to pan through the enlarged picture.

- 1 During playback, press **ZOOM** repeatedly to select different zoom factor.
  - Use ◀▶▲▼ keys to move through the zoomed image.
  - Playback will continue.
- 2 Press **ZOOM** repeatedly to return to the original size.

**TIPS:** The operating features described here might not be possible for certain discs. Always refer to the instructions supplied with the discs.

### Using the OSD menu

OSD menu shows the disc playback information (for example, title or chapter number, elapsed playing time, audio/subtitle language), a number of operations can be done without interrupting disc playback.

- 1 During playback, press **OSD MENU**.
  - A list of available disc information appears on the TV screen.

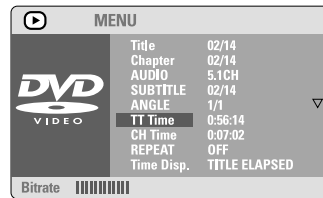

- 2 Press ▲▼ to view the information and press **OK** to access.
- 3 Use the **numeric keypad (0-9)** to input the number/time or press ▲▼ to make the selection, then press **OK** to confirm.
  - Playback will change to the chosen time or to the selected title/chapter/track.

## Disc Operations

English

### Resuming playback from the last stopped point

Resume playback of the last 10 discs is possible, even if the disc was ejected or the power switched off.

- 1 Load one of the last played 10 disc.  
→ "LOADING" appears.
- 2 Press **PLAY** ► (►||) and the disc will be played back from the last stop point.

#### To cancel the resume mode

- In stop mode, press ■ again.

### Advancing by frame

- 1 During playback, press || on the remote.  
→ Play will pause and sound will be mute.
- 2 Press || again to select the next picture frame.
- 3 To resume normal playback, press **PLAY** ►.

### Changing sound track language

This operation works only on DVDs with multiple soundtrack language, you can change the language you want while playing DVD.

- Press **AUDIO** repeatedly to select the available audio languages.

#### For VCD - changing the audio channel

- Press **AUDIO** repeatedly to select the available audio channels provided by the disc (STEREO, LEFT MONO, RIGHT MONO or MIX MONO).

### Changing subtitle language (DVD only)

This operation works only on DVDs with multiple subtitle languages, you can change the language you want while playing DVD.

- Press **SUBTITLE** repeatedly to select different subtitle languages.

### Viewing from another angle (DVD only)

If the disc contains sequences recorded from different camera angles, this allows you to view the picture from different angles. The selections of angle are depending on the disc format.

- Press **ANGLE** repeatedly to select a desired angle.  
→ Playback changes to the selected angle.

### Selecting a title (DVD only)

Some DVDs may contain several titles. If the disc has a title menu recorded on it, you can start playback from the selected movie title.

- 1 Press **RETURN/TITLE**.  
→ The disc title menu appears on the TV screen.
- 2 Use ◀▶ ▲▼ keys or **numeric keypad (0-9)** to select a play option.
- 3 Press **OK** to confirm.

**TIPS:** The operating features described here might not be possible for certain discs. Always refer to the instructions supplied with the discs.

## Disc Operations

### Playback Control (PBC) (VCD only)

PBC playback allows you to play Video CDs interactively, following the menu on the display. This function can also be accessed via the 'PREFERENCE PAGE' menu (see page 32).

#### For VCDs with Playback Control (PBC) feature (version 2.0 only)

- When play is stopped, press **DISC MENU** to toggle between 'PBC ON' and 'PBC OFF'.
  - If you select 'PBC ON', the disc menu (if available) will appear on the TV. Use **◀◀ / ▶▶** or numeric keypad (0-9) to select a play option and press **OK** to confirm.
  - If you select 'PBC OFF', the VCD will skip the index menu and playback directly from the beginning.

### Preview Function (VCD only)

- 1 Press **SCAN**.
- 2 Press **▲▼** to highlight {TRACK DIGEST}, {DISC INTERVAL} or {TRACK INTERVAL}.
- 3 Press **OK** to open one option.

SELECT DIGEST TYPE:  
 TRACK DIGEST  
 DISC INTERVAL  
 TRACK INTERVAL

### Track Digest

This function will minimise the picture of every track in order to display every six of these tracks on the screen to help you know the content of every track on the disc.

### Disc Interval

This function is used to divide a disc into six parts by regular intervals and display them on one page to preview the whole disc.

### Track Interval

This function is used to divide a single track into six parts by regular intervals and display them on one page to help you preview the selected track.

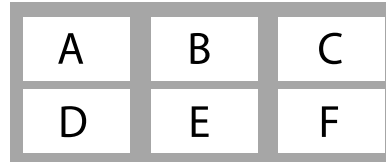

(example for 6 thumbnail pictures display)

- 4 Use **◀▶ ▲▼** keys to select a track or use **numeric keypad (0-9)** to input the selected track number next to {SELECT}.
- 5 Press **◀◀ / ▶▶** to open the previous or next page.
- 6 Press **OK** to confirm.

#### To quit preview function

- Use **◀▶ ▲▼** keys to highlight {EXIT} and press **OK** to confirm.

#### To return to preview menu

- Use **◀▶ ▲▼** keys to highlight {MENU} and press **OK** to confirm.

**TIPS:** The operating features described here might not be possible for certain discs. Always refer to the instructions supplied with the discs.



## Disc Operations

### Playing MP3/JPEG/DivX/MPEG-4 disc

This player can playback DivX, MPEG-4, MP3, JPEG, VCD & SVCD files on a personally recorded CD-R/RW disc or commercial CD.

#### IMPORTANT!

You have to turn on your TV and set to the correct Video In channel. (See page 16 "Setting the TV").

- 1 Load a disc.
  - The disc reading time may exceed 30 seconds due to the complexity of the directory/file configuration.
  - The disc menu appears on the TV screen.



- 2 Press ▲▼ to select a desired folder and press **OK** to open the folder.
- 3 Press ▲▼ to select a track/file.
- 4 Press **OK** to confirm.
  - Playback will start from the selected file to the end of the folder.

During playback, you can;

- Press |◀◀ / ▶▶| to select another track/file in the current folder.
- To select another folder from the current disc, press ◀ to return to the root menu, then press ▲▼ to make your selection and press **OK** to confirm.

- Press **REPEAT** continuously to access different 'Play Mode'.
  - **REPEAT FOLDER**: all files in one folder being played repeatedly.
  - **REPEAT ONE**: one file being played repeatedly.
  - **SHUFFLE**: all files in the current folder being played at random order.
- Press **II** to pause or **PLAY ▶** to resume playback.

### Playing MP3 music and JPEG picture simultaneously

- 1 Load a MP3 disc that contains music and picture.
  - The disc menu appears on the TV screen.
- 2 Select a MP3 track and press **PLAY ▶** (▶II) to start playback.
- 3 During MP3 music playback, select a picture folder from the TV screen and press **PLAY ▶** (▶II).
  - The picture files will be played back until end of the folder.
- 4 To quit simultaneous playback, press **DISC MENU** followed by ■.

#### Helpful Hints:

- It may not be possible to play certain MP3/JPEG/DivX/MPEG-4 disc due to the configuration and characteristics of the disc or condition of the recording.
- It is normal to experience an occasional "skip" while listening to your MP3 disc.
- It is normal to experience an occasional pixelation during MPEG-4/DivX playback due to poor clarity of digital contents during internet downloading.
- For multi-session discs with different formats, only the first session will be available.

**TIPS:** The operating features described here might not be possible for certain discs. Always refer to the instructions supplied with the discs.

## Disc Operations

### Playing Super Audio CD (SACD)

There are three types of SACD discs : single layer, double layer or hybrid disc. The hybrid disc contains both Super Audio CD and standard audio CD layers, only the SACD layer is possible to playback on this DVD player.

- 1 Load a SACD.  
→ The disc menu appears on the TV screen.
- 2 Playback will start automatically.  
→ If the SACD consists of multi-channel and stereo tracks, multi-channel tracks will have the priority for playback.  
→ To playback stereo tracks, use ▲ ▼ keys to make your selection from the disc menu, then press **PLAY ▶** (or **▶II**).

*Helpful Hint*  
– Programme SACD tracks is not possible.

### Special features for picture disc playback

#### IMPORTANT!

You have to turn on your TV and set to the correct Video In channel. (See page 16 "Setting the TV").

- Load a Picture disc (Kodak Picture CD, JPEG).  
→ For Kodak disc, the slide show will begin.  
→ For JPEG disc, the picture menu appears on the TV screen. Press **PLAY ▶** (**▶II**) to start the slide-show playback.

### Preview Function

This function shows the content of the current folder or the whole disc.

- 1 During playback, press ■.  
→ 12 thumbnail pictures will appear on the TV screen.



- 2 Press **◀◀ / ▶▶** to display the other pictures on the previous/next page.
- 3 Use **◀ ▶ ▲ ▼** keys to highlight one of the picture and press **OK** to start playback.
- 4 Press **DISC MENU** to return to Picture CD menu.

### Zoom picture

- 1 During playback, press **ZOOM** repeatedly to select different zoom factor.
- 2 Use **◀ ▶ ▲ ▼** keys to move through the zoomed image.

### Playback with multi-angles

- During playback, use **◀ ▶ ▲ ▼** keys to rotate/flip the picture on the TV screen.
  - ▲ : flip the picture vertically
  - ▼ : flip the picture horizontally
  - ◀ : rotate the picture anti-clockwise
  - ▶ : rotate the picture clockwise

### Scan Effect

- Press **ANGLE** repeatedly to choose a different scan effect.  
→ Various scan effects appear in the top left corner of the TV screen.

**TIPS:** The operating features described here might not be possible for certain discs. Always refer to the instructions supplied with the discs.

## DVD Setup Menu Options

This DVD system setup is carried out via the TV, enabling you to customise the DVD system to suit your particular requirements.

### General Setup menu

- 1 In disc mode, press **SETUP**.
- 2 Press **◀▶** to select 'General Setup' icon.
- 3 Press **OK** to confirm.

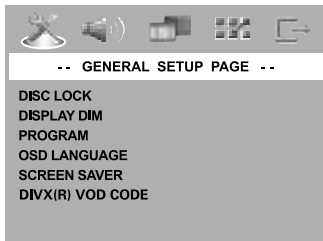

### Locking/Unlocking the disc for viewing

Not all discs are rated or coded by the disc maker. You can prevent a specific disc from playing by locking the disc. Up to 40 discs can be locked.

- 1 In 'GENERAL SETUP PAGE', press **▲▼** to highlight {DISC LOCK}, then press **▶**.

#### **LOCK**

Select this to block the playback of the current disc. Subsequent access to a locked disc requires six-digit password. The default password is '136900' (see page 33 "Changing the password").

#### **UNLOCK**

Select this to unlock the disc and allow future playback.

- 2 Press **▲▼** to select a setting and press **OK** to confirm.

### Dimming system's display panel

You can select different levels of brightness for the display screen.

- 1 In 'GENERAL SETUP PAGE', press **▲▼** to highlight {DISPLAY DIM}, then press **▶**.  
**100%** – Select this for full brightness.  
**70%** – Select this for medium brightness.  
**40%** – Select this for dimming the display.
- 2 Press **▲▼** to select a setting and press **OK** to confirm.

### Programming disc tracks (not for Picture CD/MP3/SACD)

You can play the contents of the disc in the order you want by programming the tracks to be played. Up to 20 tracks can be stored.

- 1 Press **PROG** on the remote.  
**OR**  
 In 'GENERAL SETUP PAGE', press **▲▼** to highlight {PROGRAM}, then press **▶** to select {INPUT MENU}.
- 2 Press **OK** to confirm.

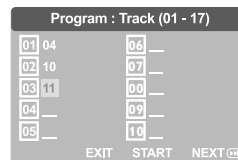

### To programme your favourite tracks/ chapter

- 3 Use the **numeric keypad (0-9)** to enter a valid track/chapter number.
- 4 Use **◀▶▲▼** keys to move the cursor to the next position.  
 → If the number of tracks is more than ten, press **▶▶|** to open the next page and proceed with programming or,  
 → Use **◀▶▲▼** keys to highlight {NEXT} on the programme menu, then press **OK**.

**TIPS:** To return to the previous menu, press **◀**.  
 To remove the menu, press **SETUP**.

## DVD Setup Menu Options

- 5 Repeat steps 3~4 to input another track/chapter number.

### If you want to remove a track

- 6 Use ◀▶ ▲▼ keys to move the cursor to the track you want to remove.
- 7 Press **OK** to remove this track from the programme menu.

### To start programme playback

- 8 Use ◀▶ ▲▼ keys to highlight {START} on the programme menu, then press **OK**.  
→ Playback will start with the selected tracks under the programmed sequence.

### To exit programme playback

- 9 Use ◀▶ ▲▼ keys to highlight {EXIT} on the programme menu, then press **OK**.

### OSD Language

This menu contains various language options for display language on the screen. For details, see page 18.

### Screen Saver - turning on/off

The screen saver will help to prevent your TV display device from becoming damaged.

- 1 In 'GENERAL SETUP PAGE', press ▲▼ to highlight {SCREEN SAVER}, then press ▶.

#### **ON**

Select this if you wish to turn off the TV screen when play is stopped or paused for more than 15 minutes.

#### **OFF**

Select this to disable the screen saver function.

- 2 Press ▲▼ to select a setting and press **OK** to confirm.

### DivX® VOD registration code

Philips provide you the DivX® VOD (Video On Demand) registration code that allows you to rent and purchase videos using the DivX® VOD service. For more information, visit us at [www.divx.com/vod](http://www.divx.com/vod).

- 1 In 'GENERAL SETUP PAGE', press ▲▼ to highlight {DIVX(R) VOD CODE}, then press ▶.  
→ The registration code will appear.
- 2 Press **OK** to exit.
- 3 Use the registration code to purchase or rent the videos from DivX® VOD service at [www.divx.com/vod](http://www.divx.com/vod). Follow the instructions and download the video onto a CD-R/RW for playback on this DVD system.

#### Helpful Hints:

- All the downloaded videos from DivX® VOD can only be played back on this DVD system.
- Time search feature is not available during DivX® movie playback.

**TIPS:** To return to the previous menu, press ◀.  
To remove the menu, press **SETUP**.

## DVD Setup Menu Options

### Audio Setup Menu

- 1 In disc mode, press **SETUP**.
- 2 Press ◀▶ to select 'Audio Setup' icon.
- 3 Press **OK** to confirm.

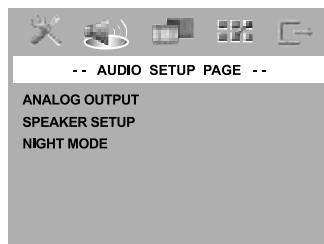

### Setting the analogue output

Set Analogue Output to match your DVD home cinema system's playback capability. This function can also be accessed via the **SURR.** button on the remote.

- 1 In 'AUDIO SETUP PAGE', press ▲▼ to highlight {ANALOG OUTPUT}, then press ▶.

#### **STEREO**

Select this to change channel output to stereo which delivers sound from only the two front speakers and subwoofer.

#### **MULTI-CHANNEL**

Select this to enable Multi-channel output.

- 2 Press ▲▼ to select a setting and press **OK** to confirm.

### Speaker Setup

This menu contains setup options for your audio output which makes the speaker setup system reproduce high quality surround sound. For details, see page 19.

### Night Mode - turning on/off

When night mode is activated, the high volume outputs are softened and low volume outputs are brought upward to an audible level. It is useful for watching your favourite action movie without disturbing others at night.

- 1 In 'AUDIO SETUP PAGE', press ▲▼ to highlight {NIGHT MODE}, then press ▶.

#### **ON**

Select this to level out the volume. This feature is only available for movies with Dolby Digital mode.

#### **OFF**

Select this when you want to enjoy the surround sound with its full dynamic range.

- 2 Press ▲▼ to select a setting and press **OK** to confirm.

**TIPS:** To return to the previous menu, press ◀.  
To remove the menu, press **SETUP**.

## DVD Setup Menu Options

### Video Setup Menu

- 1 In disc mode, press **SETUP**.
- 2 Press ◀▶ to select 'Video Setup' icon.
- 3 Press **OK** to confirm.

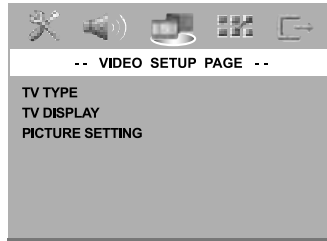

### TV Type

This menu contains the options for selecting the colour system that matches the connected TV. For details, see page 17.

### TV Display

This menu contains the options for setting the aspect ratio of the DVD system according to the connected TV. For details, see page 17.

### Picture Setting

This DVD system provides three predefined sets of picture colour settings and one personal setting which you can define yourself.

- 1 In 'VIDEO SETUP PAGE', press ▲▼ to highlight {PICTURE SETTING}, then press ▶.

#### **STANDARD**

Select this for standard picture setting.

#### **BRIGHT**

Select this will make the TV picture brighter.

#### **SOFT**

Select this will make the TV picture softer.

#### **PERSONAL**

Select this to personalise your picture colour by adjusting the brightness, contrast, tint and colour (saturation).

- 2 Press ▲▼ to select a setting and press **OK** to confirm.
- 3 If you select {PERSONAL}, then proceed to steps 4~7.  
→ The 'PERSONAL PICTURE SETUP' menu appears.

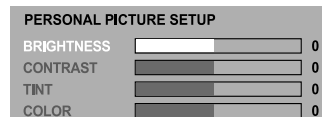

- 4 Press ▲▼ to highlight one of the following options.

#### **BRIGHTNESS**

Increase the value will brighten the picture or vice versa. Choose zero (0) for average setting.

**TIPS:** To return to the previous menu, press ◀.  
To remove the menu, press **SETUP**.

## DVD Setup Menu Options

### **CONTRAST**

Increase the value will sharpen the picture or vice versa. Choose zero (0) to balance the contrast.

### **TINT**

Increase the value will darken the picture or vice versa. Choose zero (0) for average setting.

### **COLOUR**

Increase the value will enhance the colour in your picture or vice versa. Choose zero (0) to balance the colour.

- 5 Press ◀▶ to adjust the setting that best suit your personal preference.
- 6 Repeat steps 4~5 for adjusting other colour features.
- 7 Press **OK** to confirm.

### **Preference Setup Menu**

- 1 Press **■** twice to stop playback (if any), then press **SETUP**.
- 2 Press ◀▶ to select the 'Preference Setup' icon.
- 3 Press **OK** to confirm.

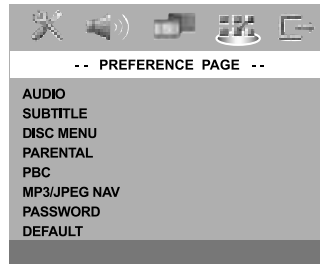

### **Audio, Subtitle, Disc Menu**

These menus contain various language options for audio, subtitle and disc menu which may be recorded on the DVD. For details, see page 18.

### **Restricting playback by Parental Control**

Some DVDs may have a parental level assigned to the complete disc or to certain scenes on the disc. This feature lets you set a playback limitation level. The rating levels are from 1 to 8 and are country dependent. You can prohibit the playing of certain discs that are not suitable for your children, or have certain discs played with alternative scenes.

**TIPS:** To return to the previous menu, press ◀.  
To remove the menu, press **SETUP**.

## DVD Setup Menu Options

- In 'PREFERENCE PAGE', press ▲▼ to highlight {PARENTAL}, then press ►.

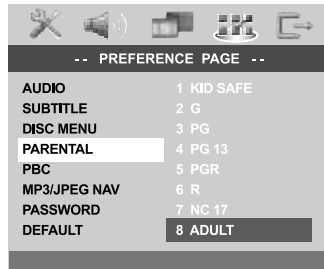

- Press ▲▼ to highlight a rating level for the disc inserted and press **OK**.  
→ To disable Parental controls and allow all discs to play, select {1 KID SAFE}.
- Use the **numeric keypad (0-9)** to enter the six-digit password (see page 33 "Changing the password").  
→ DVDs that are rated above the level you selected will not play unless you enter your six-digit password.

### Rating explanations

#### 1 KID SAFE – 2 G

– General Audience; recommended as acceptable for viewers of all ages.

#### 3 PG

– Parental Guidance suggested.

#### 4 PG13

– Material is unsuitable for children under age 13.

#### 5 PGR – 6 R

– Parental Guidance - Restricted; recommended that parents restrict children under 17 from viewing or allow to view only when supervised by a parent or adult guardian.

#### 7 NC-17

– No children under age 17; not recommended viewing for children under age 17.

#### 8 ADULT

– Mature material; should be viewed only by adults due to graphic sexual material, violence or language.

### Helpful Hints:

- VCD, SVCD, CD have no level indication, so parental control has no effect on these type of discs. This also applies to most illegal DVDs.
- Some DVDs are not encoded with a rating though the movie rating may be printed on the Disc cover. The rating level feature does not prohibit play of such Discs.

### PBC

You can set the PBC to ON or OFF. This feature is available only on Video CD 2.0 with playback control (PBC) feature. For details, see page 24.

### MP3/JPEG Menu - turning on/off

MP3/JPEG Navigator can be set only if the disc is recorded with menu. It allows you to select different display menus for easy navigation.

- In 'PREFERENCE PAGE', press ▲▼ to highlight {MP3/JPEG NAV}, then press ►.

### WITHOUT MENU

Select this to display all the files contained in the MP3/Picture CD.

### WITH MENU

Select this to display only the folder menu of the MP3/Picture CD.

- Press ▲▼ to select a setting and press **OK** to confirm.

**TIPS:** To return to the previous menu, press ◀.  
To remove the menu, press **SETUP**.



# DVD Setup Menu Options

## Changing the Password

The same password is used for both Parental Control and Disc Lock. Enter your six-digit password to play a prohibited disc or if prompted for a password. The default password is **136900**.

- In 'PREFERENCE PAGE', press ▲▼ to highlight {PASSWORD}, then press ► to select {CHANGE}.

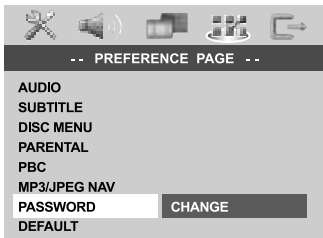

- Press **OK** to enter the 'Password Change Page'.



- Use the **numeric keypad (0-9)** to enter your old six-digit password.
  - When doing this for the first time, key in '136900'.
  - If you forget your old six-digit password, key in '136900'.
- Enter the new six-digit password.
- Enter the new six-digit password a second time to confirm.
  - The new six-digit password will now take effect.
- Press **OK** to confirm.

## Restoring to original settings

Setting the DEFAULT function will reset all options and your personal settings to the factory defaults, except your password for Parental Control and Disc Lock.

- In 'PREFERENCE PAGE', press ▲▼ to highlight {DEFAULT}, then press ► to select {RESET}.
- Press **OK** to confirm.
  - All settings will now reset to factory defaults.

## Tuner Operations

**IMPORTANT!**  
Make sure the FM and MW antennas are connected.

### Tuning to radio stations

- 1 Press **TUNER** on the remote (or press **SOURCE** control on front panel) to select "FM" or "MW".
- 2 Press **▲▼** briefly on the remote.  
→ "SEARCH" appears.  
→ The next radio station will tune automatically.
- 3 To tune a weak station, press **◀◀ / ▶▶** briefly and repeatedly until an optimal reception is found.

*Helpful Hint:*

– If the FM radio station is transmitting RDS (Radio Data System) data, the RDS name will be displayed and stored.

### Presetting radio stations

You can store up to 20 FM and 10 MW preset radio stations in the memory.

*Helpful Hints:*

- The system will exit presetting mode if no button is pressed within 20 seconds.
- If no valid frequency is detected during Plug and Play, "CHECK ANTENNA" appears.

### Using the Plug and Play

Plug and Play allows you to store all available radio stations automatically.

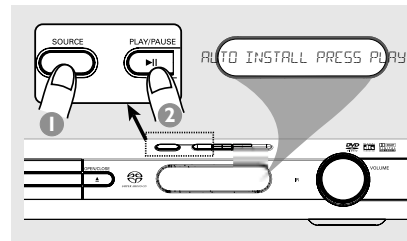

- 1 For first time setup, press **SOURCE** on front panel to select TUNER mode.  
→ "AUTO INSTALL PRESS PLAY" appears.
- 2 Press **▶||** on the front panel to start installation.  
→ "INSTALL TUNER" appears.  
→ Once completed, the last tuned radio station will play.  
→ FM followed by MW bands will be stored.

## Tuner Operations

### Automatic presetting

You can start the automatic presetting from a selected preset number.

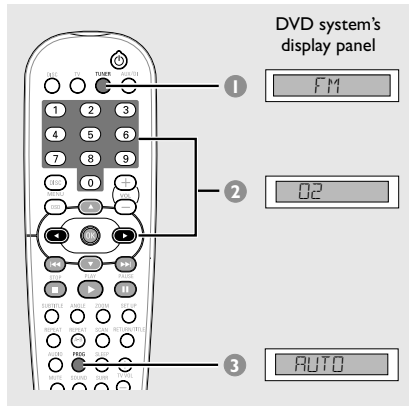

- 1 Press **TUNER** on the remote to select "FM" or "FM".
- 2 Press ◀ ▶ or use the **numeric keypad (0-9)** to select a preset number to begin.
- 3 Press and hold **PROG** until "AUTO" appears.
  - If a radio station is stored in one of the earlier presets, the same radio station will not store under another preset number.
  - If no preset number is selected, automatic preset will begin from preset (1) and all your former presets will be overridden.

### Manual presetting

You can choose to store only your favourite radio stations.

- 1 Tune to your desired radio station (see "Tuning to radio stations").
- 2 Press **PROG**.
- 3 Press ◀ ▶ to select a preset number.
- 4 Press **PROG** again to store.

### Selecting a preset radio station

- Press ◀ ▶ or use the **numeric keypad (0-9)** to select a preset number.
  - The waveband, preset number follow by radio frequency will appear.

### Deleting a preset radio station

- Press and hold ■ until "FMXX DELETED" or "FMXX DELETED" appears.
  - The current preset radio station will be deleted.

## Sound and Volume Controls

### Sound Control

#### IMPORTANT!

**For proper surround sound, make sure the speakers and subwoofer are connected (see page 9).**

#### Selecting surround sound

- Press **SURR** to select :  
MULTI-channel or STEREO.
  - The availability of the various surround sound modes depends on the number of speakers used and the sound available on the disc.
  - The centre and surround speakers operate only in Multi-channel surround mode.
  - The available output modes for Multi-channel include: Dolby Digital, DTS (Digital Theatre Systems) Surround and Dolby Pro Logic II.
  - Stereo broadcasts or recordings will produce some surround channel effects when played in a surround mode. However, mono (single channel sound) sources will not produce any sound from the surround speakers.

#### Helpful Hints:

- *SURR button is not functional for SACD playback. You have to access to the disc menu in order to select between multi-channel and stereo tracks, see page 26.*
- *You are not able to select the surround sound mode if the system setup menu is turned on.*

#### Selecting digital sound effects

Select a preset digital sound effects that matches your disc's content or that optimises the sound of the musical style you are playing.

- Press **SOUND** on the remote.

When playing movie discs or in TV mode, you can select :  
CONCERT, DRAMA, ACTION or SCI-FI.

When playing music discs or while in TUNER or AUX/DI mode, you can select :  
ROCK, DIGITAL, CLASSIC or JAZZ.

#### Helpful Hint:

- *For flat sound output, select CONCERT or CLASSIC.*

### Volume control

- Adjust **VOLUME** control (or press **VOL +/–** on the remote) to increase or decrease the volume level.
  - "VOL MIN" is the minimum volume level and "VOL MAX" is the maximum volume level.
- To turn off the volume temporarily**
- Press **MUTE** on the remote.
  - Playback will continue without sound and "MUTE" appears.
  - To restore the volume, press **MUTE** again or increase the volume level.

## Other Functions

### Switching on/off

#### Switching to active mode

- Press the **SOURCE** control to select :  
DISC → FM → MW → TV → AUX → DI → DISC ....  
OR  
Press **DISC, TV, TUNER** or **AUX/DI** on the remote.

#### Switching to Eco Power standby mode

- Press **STANDBY ON** (⏻).  
→ The display screen will go blank.

### Using the remote to operate your 'Philips' television

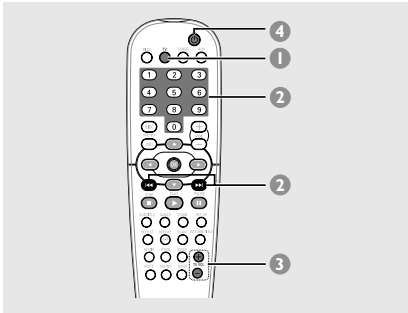

- 1 Press and hold **TV** to turn on your TV.
- 2 Press **◀▶** or use the **numeric keypad (0-9)** to select the TV's channel.
- 3 Press **TVVOL +/−** to adjust the TV's volume level.
- 4 Press and hold **⏻** to turn off your TV.

*Helpful Hint:*  
– When listening to TV or AUX/DI programmes, press the respective TV or AUX/DI button on the remote in order for the sound to be heard.

### Recording to an external device

- 1 Connect the external recording device to **LINE OUT (R/L)** (see page 12 "Connections-optional").
- 2 Select the source to record from your DVD system (DISC, TUNER, TV or AUX/DI) and start playback (if necessary).
- 3 For ultimate recording, press **SOUND** to select 'CLASSIC' or 'CONCERT' and press **SURR** to select 'STEREO'.
- 4 Start recording on the external recording device.

*Helpful Hint:*  
– Refer to the owner's manual of the connected equipment for details.

### Setting the Sleep timer

The sleep timer enables the system to switch to Eco Power standby mode automatically at a preset time.

- Press **SLEEP** on the remote repeatedly until it reaches the desired preset turn-off time.  
→ The selections are as follows (time in minutes):  
15 → 30 → 45 → 60 → OFF → 15...  
→ **SLEEP** will show on the display panel, except if "OFF" is selected.  
→ Before the system switches to Eco Power standby mode, a countdown of 10 seconds is displayed.  
"SLEEP 10" → "SLEEP 9".... →  
"SLEEP 1" → "SLEEP"

#### To cancel the sleep timer

- Press **SLEEP** repeatedly until "OFF" appears or press the **STANDBY ON** (⏻) button.

## Troubleshooting

### WARNING

Under no circumstances should you try to repair the system yourself, as this will invalidate the warranty. Do not open the system as there is a risk of electric shock.

If a fault occurs, first check the points listed below before taking the system for repair. If you are unable to remedy a problem by following these hints, consult your dealer or Philips for help.

Problem	Solution
<b>No power.</b>	<ul style="list-style-type: none"> <li>– Check if the AC power cord is properly connected.</li> <li>– Press the STANDBY ON on the front of the DVD system to turn on the power.</li> </ul>
<b>No picture.</b>	<ul style="list-style-type: none"> <li>– Refer to your TV's manual for correct Video In channel selection. Change the TV channel until you see the DVD screen.</li> <li>– Press DISC on the remote.</li> </ul>
<b>Completely distorted picture or black/white picture.</b>	<ul style="list-style-type: none"> <li>– If this happens when you changing the setting of the 'TV TYPE', wait for 15 seconds for auto recovery.</li> <li>– Check the video connection.</li> <li>– Sometimes a small amount of picture distortion may appear. This is not a malfunction.</li> <li>– Clean the disc.</li> </ul>
<b>The aspect ratio of the screen cannot be changed even though you have set the TV display.</b>	<ul style="list-style-type: none"> <li>– The aspect ratio is fixed on the DVD disc.</li> <li>– Depending on the TV, it may not be possible to change the aspect ratio.</li> </ul>
<b>No sound or distorted sound.</b>	<ul style="list-style-type: none"> <li>– Adjust the volume.</li> <li>– Check the speaker connections and settings.</li> <li>– Press the correct source button on the remote (TV or AUX/DI, for example) to choose the equipment that you want to hear through the DVD system.</li> </ul>
<b>The DVD player does not start playback.</b>	<ul style="list-style-type: none"> <li>– Insert a readable disc with the playback side facing down. The DVD+R/CD-R must be finalised.</li> <li>– Check the disc type, colour system (PAL or NTSC) and region code.</li> <li>– Check for any scratches or smudges on the disc.</li> <li>– Press SETUP to turn off the setup menu screen.</li> <li>– You may need to enter the password in order to change the parental control rating level or to unlock the disc for playback.</li> <li>– Moisture has condensed inside the system. Remove the disc and leave the system turned on for about an hour.</li> </ul>

Visit us at [www.p4c.philips.com](http://www.p4c.philips.com) for service support

## Troubleshooting

Problem	Solution
<b>Cannot activate some features such as Angles, Subtitles, or multi-language Audio.</b>	<ul style="list-style-type: none"> <li>– The features may not be available on the DVD.</li> <li>– Changing the language for the sound or subtitle is prohibited on the DVD.</li> </ul>
<b>No able to select some Items in the setup/system menu.</b>	<ul style="list-style-type: none"> <li>– Press STOP button twice before selecting the setup/system menu.</li> <li>– Depending on the disc availability, some menu items cannot be selected.</li> </ul>
<b>There is no sound from the centre and surround speakers.</b>	<ul style="list-style-type: none"> <li>– Make sure the centre and surround speakers are connected correctly.</li> <li>– Press SURR button to select a correct surround sound setting.</li> <li>– Make sure the source you are playing is recorded or broadcast in surround sound (DTS, Dolby Digital, etc.).</li> <li>– The wireless transmitter and receiver must using the same transmission frequency.</li> </ul>
<b>Radio reception is poor.</b>	<ul style="list-style-type: none"> <li>– If the signal is too weak, adjust the antenna or connect an external antenna for better reception.</li> <li>– Increase the distance between the system and your TV or VCR.</li> <li>– Tune in to the correct frequency.</li> <li>– Place the antenna farther away from any equipment that may be causing the noise.</li> </ul>
<b>The remote control does not function properly.</b>	<ul style="list-style-type: none"> <li>– Select the source (DISC or TUNER, for example) before pressing the function button (▶  , ◀◀◀, ▶▶▶).</li> <li>– Reduce the distance between the remote control and the system.</li> <li>– Replace the batteries with new ones.</li> <li>– Point the remote control directly toward the IR sensor.</li> <li>– Check that the batteries are loaded correctly.</li> </ul>
<b>Low hum or buzz sound.</b>	<ul style="list-style-type: none"> <li>– Place the DVD system as far away as possible from electrical devices that may be causing interference.</li> </ul>
<b>Unable to play DivX movies.</b>	<ul style="list-style-type: none"> <li>– Check that the DivX file is encoded in 'Home Theatre' mode with DivX 5.x encoder.</li> </ul>
<b>The DVD system does not work.</b>	<ul style="list-style-type: none"> <li>– Disconnect the power cord from the power outlet for a few minutes. Reconnect the power cord and try to operate again as usual.</li> </ul>

Visit us at [www.p4c.philips.com](http://www.p4c.philips.com) for service support

English

## Specifications

### AMPLIFIER SECTION

Output power	
- Front	50 W RMS / channel
- Rear	50 W RMS / channel
- Centre	50 W RMS
- Subwoofer	75 W RMS
Frequency Response	20 Hz – 20 kHz / –3 dB
Signal-to-Noise Ratio	> 65 dB (CCIR)
Input Sensitivity	
- AUX In	900 mV
- DIGITAL In	450 mV

### TUNER SECTION

Tuning Range	FM 87.5 – 108 MHz (50 kHz) MW 531 – 1602 kHz (9 kHz)
26 dB Quieting Sensitivity	FM 20 dB MW 4 $\mu$ V/m
Image Rejection Ratio	FM 25 dB MW 28 dB
IF Rejection Ratio	FM 60 dB MW 24 dB
Signal-to-Noise Ratio	FM 60 dB MW 40 dB
AM Suppression Ratio	FM 30 dB
Harmonic Distortion	FM Mono 3% FM Stereo 3% MW 5%
Frequency Response	FM 180 Hz – 10 kHz / $\pm$ 6 dB
Stereo Separation	FM 26 dB (1 kHz)
Stereo Threshold	FM 23.5 dB

### DISC SECTION

Laser Type	Semiconductor
Disc Diameter	12cm / 8cm
Video Decoding	MPEG-1 / MPEG-2 / MPEG-4 / DivX 3.11, 4.x & 5.x
Video DAC	12 Bits
Signal System	PAL / NTSC
Video Format	4:3 / 16:9
Video S/N	56 dB (minimum)
Composite Video Output	1.0 Vp-p, 75 $\Omega$
S-Video Output	Y - 1.0 Vp-p, 75 $\Omega$ C - 0.286 Vp-p, 75 $\Omega$
Audio DAC	24 Bits / 96 kHz
Frequency Response	4 Hz – 20 kHz (44.1 kHz) 4 Hz – 22 kHz (48 kHz) 4 Hz – 44 kHz (96 kHz)
PCM	IEC 60958
Dolby Digital	IEC 60958, IEC 61937
DTS	IEC 60958, IEC 61937
SACD D/A converter	DSD
SACD cut-off frequency	30 kHz

### MAIN UNIT

Power Supply Rating	220 – 240 V; 50 Hz
Power Consumption	80 W
Dimensions (w x h x d)	360 mm x 55 mm x 325 mm
Weight	3 kg

### FRONT SPEAKERS

System	2-way, closed box system
Impedance	4 $\Omega$
Speaker drivers	18mm cone dome tweeter,
Frequency response	120 Hz – 20 kHz
Dimensions (w x h x d)	92 mm x 170 mm x 64 mm
Weight	0.73 kg/each

### REAR SPEAKERS

System	2-way, closed box system
Impedance (LX3900SA)	4 $\Omega$
Impedance (LX3950W)	8 $\Omega$
Speaker drivers	18mm cone dome tweeter,
Frequency response	120 Hz – 20 kHz
Dimensions (w x h x d)	92 mm x 170 mm x 64 mm
Weight	0.73 kg/each

### CENTRE SPEAKER

System	3-way, closed box system
Impedance	4 $\Omega$
Speaker drivers	18mm cone dome tweeter,
Frequency response	120 Hz – 20 kHz
Dimensions (w x h x d)	245 mm x 92 mm x 68 mm
Weight	1.3 kg

### PASSIVE SUBWOOFER

System	Bass Reflex System
Impedance	4 $\Omega$
Speaker driver	6 1/2" woofer
Frequency response	20 Hz – 120 Hz
Dimensions (w x h x d)	154 mm x 361 mm x 350 mm
Weight	4.2 kg

### WIRELESS SYSTEM (ONLY FOR LX3950W)

Power supply	220 – 240V; 50Hz/60Hz
Transmission frequency	863.3 MHz – 864.5 MHz
Transmission channel	4
Dimension (w x h x d)	
-Transmitter	131 mm x 34 mm x 130 mm
- Receiver	207 mm x 55 mm x 186 mm
Weight	1.12kg

Specifications subject to change without prior notice



## Glossary

**Analogue:** Sound that has not been turned into numbers. Analogue sound varies, while digital sound has specific numerical values. These jacks send audio through two channels, the left and right.

**Aspect ratio:** The ratio of vertical and horizontal sizes of a displayed image. The horizontal vs. vertical ratio of conventional TVs. is 4:3, and that of wide-screens is 16:9.

**AUDIO OUT Jacks:** Red and white jacks on the back of the DVD System that send audio to another system (TV, Stereo, etc.).

**Bit Rate:** The amount of data used to hold a given length of music; measured in kilobits per second, or kbps. Or, the speed at which you record. Generally, the higher the bit rate, or the higher the recording speed, the better the sound quality. However, higher bit rates use more space on a Disc.

**Chapter:** Sections of a picture or a music piece on a DVD that are smaller than titles. A title is composed of several chapters. Each chapter is assigned a chapter number enabling you to locate the chapter you want.

**Disc menu:** A screen display prepared for allowing selection of images, sounds, subtitles, multi-angles, etc recorded on a DVD.

**DivX 3.11/4.x/5.x:** The DivX code is a patent-pending, MPEG-4 based video compression technology, developed by DivXNetworks, Inc., that can shrink digital video to sizes small enough to be transported over the internet, while maintaining high visual quality.

**Dolby Digital:** A surround sound system developed by Dolby Laboratories containing up to six channels of digital audio (front left and right, surround left and right, centre and subwoofer).

**Dolby Pro Logic II:** It creates five full-bandwidth output channels from two-channel sources. Decode only systems that derive 5.1 channels instead of the conventional 4 channels of Dolby Pro Logic surround sound.

**DTS:** Digital Theatre Systems. This is a surround sound system, but it is different from Dolby Digital. The formats were developed by different companies.

**JPEG:** A very common digital still picture format. A still-picture data compression system proposed by the Joint Photographic Expert Group, which features small decrease in image quality in spite of its high compression ratio.

**MP3:** A file format with a sound data compression system. "MP3" is the abbreviation of Motion Picture Experts Group 1 (or MPEG-1) Audio Layer 3. By using the MP3 format. One CD-R or CD-RW can contain about 10 times more data than a regular CD.

**Multichannel:** DVDs are formatted to have each sound track constitute one sound field. Multichannel refers to a structure of sound tracks having three or more channels.

**Parental control:** Limits Disc play according to the age of the users or the limitation level in each country. The limitation varies from disc to disc; when it is activated, playback will be prohibited if the software's level is higher than the user-set level.

**Playback control (PBC):** Refers to the signal recorded on video CDs or SVCDs for controlling playback. By using menu screens recorded on a Video CD or SVCD that supports PBC, you can enjoy interactive playback and searching.

**Plug and Play:** First time power up to the Tuner mode, the system will prompt the user to proceed with the automatic installation of radio stations by simply pressing the PLAY button on the main unit.

**Region code:** A system allowing discs to be played only in the region designated. This unit will only play discs that have compatible region codes. You can find the region code of your unit by looking on the product label. Some discs are compatible with more than one region (or ALL regions).

**S-Video:** Produces a clear picture by sending separate signals for the luminance and the colour. You can use S-Video only if your TV has an S-Video In jack.

**Super Audio CD (SACD):** This audio format is based upon the current CD standards but includes a greater amount of information that provides higher quality sound. There are three types of discs: single layer, double layer and hybrid discs. The hybrid disc contains both standard audio CD and Super Audio CD information.

**Surround:** A system for creating realistic three-dimensional sound fields full of realism by arranging multiple speakers around the listener.

**Title:** The longest section of a movie or music feature on DVD. Each title is assigned a title number, enabling you to locate the title you want.

**VIDEO OUT jack:** Yellow jack on the back of the DVD system that sends the DVD picture video to a TV.



LX3900SA



PHILIPS

12nc: 3139 115 22861

**First connect ...**

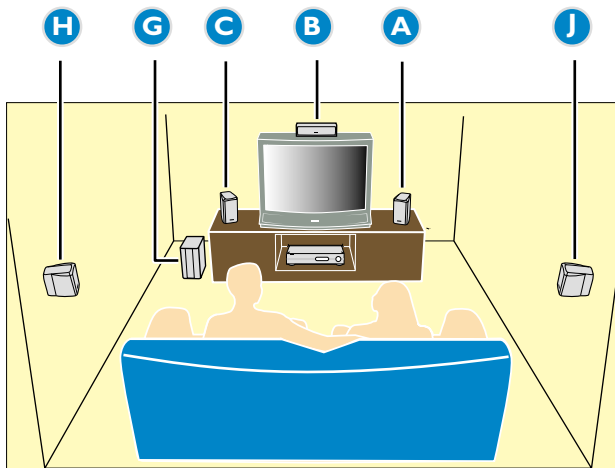
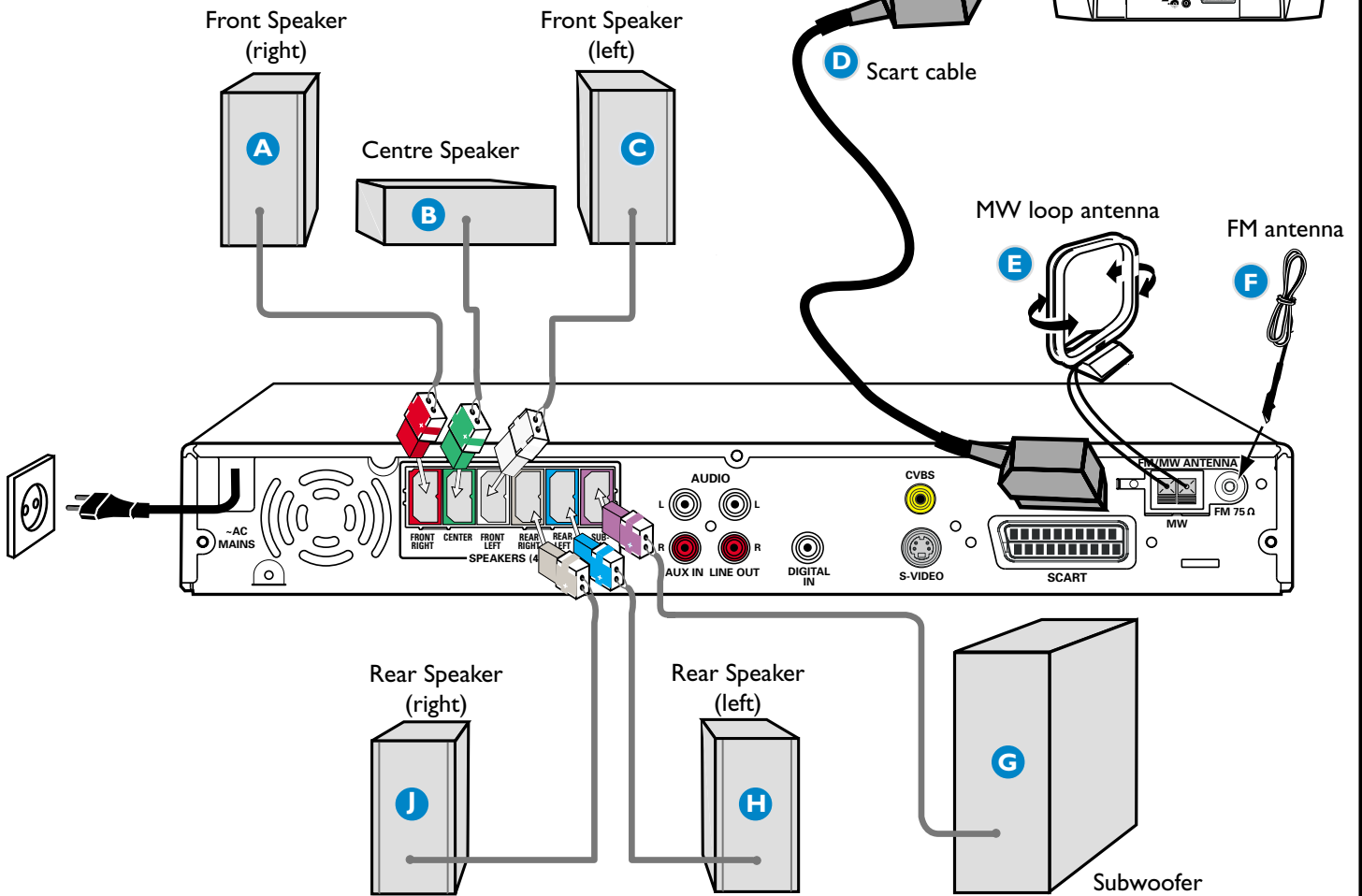
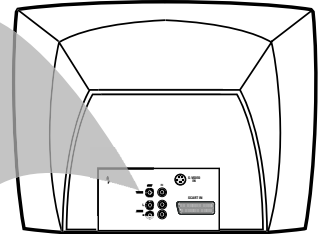
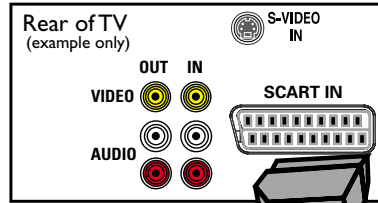

**Helpful Hints**

You only need to make one video connection to your TV in order to view the DVD playback.

	Use this video cable(s)	If your TV has this video input jack(s)
1		
2		

If your TV is not equipped with a SCART connector, connect your TV through the corresponding video connection 1 or 2 (cables not supplied).

**... then play**  
(see next page)



# Guide de démarrage rapide

## Commencez par connecter ...

- (A) Enceinte avant (droite)
- (B) Enceinte centrale
- (C) Enceinte avant (gauche)
- (D) Câble SCART (Péritel)
- (E) Antenne-cadre AM
- (F) Antenne filaire FM
- (G) Caisson de basses
- (H) Enceinte arrière (surround gauche)
- (J) Enceinte arrière (surround droite)

### Conseils utiles

Il vous suffit de faire une seule connexion vidéo entre votre téléviseur et le lecteur de DVD pour voir le DVD.

**Si votre téléviseur n'est pas équipé d'un connecteur SCART (PÉRITEL), connectez votre téléviseur par la connexion vidéo correspondante 1 ou 2 (câbles non fournis).**

## ... puis démarrez la lecture

**Vérifiez que votre système DVD et votre téléviseur sont connectés et sous tension!**

### Lire un disque

#### 1 Appuyez sur la touche DISC de la télécommande.

Vous pouvez aussi faire appuyez sur SOURCE de la façade jusqu'à ce que "DISC" apparaisse à l'écran.

#### 2 Allumez le téléviseur et sélectionnez le mode d'entrée vidéo adéquat.

Vous devriez voir l'écran bleu d'arrière-plan DVD sur le téléviseur (si aucun disque ne se trouve dans le lecteur).

#### 3 Appuyez sur OPEN/CLOSE ▲ à l'avant du lecteur de DVD et insérez un disque, puis appuyez à nouveau sur OPEN/CLOSE ▲ pour fermer le tiroir de disque.

Veillez à ce que le côté étiquette soit sur le dessus. Pour les CD double-face, chargez la face que vous voulez lire vers le haut.

#### 4 La lecture commencera automatiquement.

Si un menu de disque apparaît, utilisez les boutons ▲▼◀▶ de la télécommande pour faire la sélection nécessaire, puis appuyez sur OK pour confirmer. Ou utilisez le clavier numérique de la télécommande pour sélectionner les fonctions. Suivez les instructions données dans le menu de disque.

#### 5 Pour arrêter la lecture, appuyez sur STOP ■.

### Pas les images !!

#### Vérifiez le mode AV (audiovisuel) sur votre téléviseur.

\* Généralement, ces canaux se trouvent entre les canaux les plus hauts et les plus bas et s'appellent FRONT, A/V IN ou VIDEO.



\* Vous pouvez aussi sélectionner le canal 1 de votre téléviseur et appuyer à plusieurs reprises sur le bouton de chaîne suivante, jusqu'à ce que le canal d'entrée vidéo apparaisse.

\* D'autre part, la télécommande du téléviseur peut avoir un bouton ou un commutateur permettant de choisir différents modes vidéo.

\* Pour en savoir plus, reportez-vous au mode d'emploi du téléviseur.

### Utilisation du menu configuration du lecteur de DVD

Appuyez sur  pour accéder au sous-menu.

Appuyez sur   pour mettre en surbrillance la sélection.

Appuyez sur  pour confirmer.

Appuyez sur  pour retourner au menu précédent.

Appuyez sur  pour quitter le menu.

**Les programmes de lecture détaillés et les fonctions supplémentaires sont décrits dans le manuel d'utilisation fourni.**

# Guía de utilización rápida

## En primer lugar conecte ...

- (A) Altavoz delantero (derecha)
- (B) Altavoz central
- (C) Altavoz delantero (izquierdo)
- (D) Cable Scart
- (E) Antena de cuadro MW
- (F) Antena de alambre FM
- (G) Subwoofer
- (H) Altavoz trasero (surround izquierdo)
- (J) Altavoz trasero (surround derecho)

### Consejos útiles

Solamente necesita realizar una conexión de vídeo a su televisor para ver la reproducción de DVD.

**Si su televisor no está equipado con un conector SCART, conecte su televisor a través de la conexión de vídeo correspondiente 1 ó 2 (cables no suministrados).**

## ... y después reproduzca

**¡Asegúrese de que su sistema de DVD y su televisor estén conectados y encendidos!**

### Reproducción de un disco

#### 1 Pulse DISC en el control remoto.

También puede pulse SOURCE en el panel delantero hasta que en el panel de visualización aparezca "DISC".

#### 2 Encienda el televisor y seleccione el modo de entrada de video correcto.

Debería ver la pantalla de fondo azul de DVD (si no hay disco en el sistema DVD).

#### 3 Pulse OPEN/CLOSE ▲ en la parte delantera del sistema DVD y coloque un disco, y vuelva pulsar el botón OPEN/CLOSE ▲ correspondiente para cerrar la bandeja de discos.

Asegúrese de que la etiqueta del disco esté cara arriba. En el caso de discos de dos caras, coloque el disco con la cara que quiere reproducir hacia arriba.

#### 4 La reproducción se inicia automáticamente.

Si aparece un menú de disco, utilice los botones ▲▼◀▶ del control remoto para realizar la selección necesaria y después pulse OK para confirmarla. O utilice el teclado numérico del control remoto para seleccionar funciones. Siga las instrucciones dadas en el menú del disco.

#### 5 Para detener la reproducción, pulse STOP ■.

### ¿No imagen!!

#### Compruebe el modo (AV/Audio/Video) en su televisor.

\* Normalmente, estos canales se encuentran entre los canales más altos y más bajos y pueden llamarse FRONT, A/V IN o VIDEO.

\* O, puede ir al canal 1 de su televisor y pulsar el botón de reducción de número de canal hasta que vea el canal de entrada de vídeo.

\* O, el control remoto de su televisor puede tener un botón o interruptor que seleccione diferentes modos de vídeo.

\* Para más detalles, consulte el manual de su televisor.

### Utilización del menú de configuración de DVD

Pulse  para acceder al submenú.

Pulse   para resaltar la selección.

Pulse  para confirmarla.

Pulse  para volver al menú anterior.

Pulse  para retirar el menú.

**En el manual del propietario adjunto se describen funciones de reproducción detalladas y funciones adicionales.**

# Kurzanleitung

## Erst anschließen ...

- (A) Lautsprecher vorne (rechts)
- (B) Center-Lautsprecher
- (C) Lautsprecher vorne (links)
- (D) Scart-Kabel
- (E) MW-Antenne
- (F) FM-Antenne
- (G) Subwoofer
- (H) Surround-Lautsprecher (links)
- (J) Surround-Lautsprecher (rechts)

### Hilfreiche Tipps:

Sie müssen nur einen Video-Anschluss an Ihr Fernsehgerät vornehmen, um sich die DVD-Wiedergabe anschauen zu können.

**Wenn Ihr Fernsehgerät nicht einem SCART-Verbinder ausgerüstet ist, schließen Sie Ihr Fernsehgerät durch den entsprechenden Videoanschluss 1 oder 2 an (Kabel nicht mitgeliefert).**

## ... dann abspielen

**Vergewissern Sie sich, dass Ihr DVD-System und Fernsehgerät angeschlossen und eingeschaltet sind!**

### Abspielen einer Disk

#### 1 Drücken Sie DISC auf der Fernbedienung.

Oder, drücken Sie SOURCE auf dem vorderen Bedienfeld justieren, bis „DISC“ im Anzeigefeld erscheint.

#### 2 Schalten Sie das Fernsehgerät ein und stellen Sie den richtigen Videoeingangskanal ein.





Sie sollten den blauen DVD-Hintergrundbildschirm auf dem Fernsehgerät sehen (wenn keine Disk im DVD-System befindlich ist).

#### 3 Drücken Sie die Taste OPEN/CLOSE einmal, um die Disk-Lade zu öffnen und eine Disk einzulegen.

Anschließend drücken Sie dieselbe Taste erneut, um die Disk-Lade zu schließen.

Achten Sie darauf, dass die Disk-Beschriftung nach oben zeigt. Bei doppelseitigen Disks legen Sie die Seite, die Sie abspielen wollen, nach oben zeigend ein.

#### 4 Die Wiedergabe beginnt automatisch.

Wenn ein CD-Menü erscheint, benutzen Sie    , um die notwendige Auswahl zu treffen, dann drücken Sie OK. Oder benutzen Sie die numerische Tastatur auf der Fernbedienung zur Wahl von Funktionen. Folgen Sie den Anweisungen im CD-Menü.

#### 5 Zum Anhalten der Wiedergabe drücken Sie STOP .



### Aber kein Bild!!

#### Überprüfen Sie den AV- (Audio/ Video) Modus an Ihrem Fernsehgerät.

- \* In der Regel befindet sich dieser Kanal zwischen den niedrigsten und höchsten Kanälen und kann als FRONT, AV IN oder VIDEO bezeichnet sein.
- \* Oder Sie können zu Kanal 1 auf Ihrem Fernsehgerät gehen; anschließend drücken Sie die Kanal-nach-unten-Taste wiederholt, bis Sie den Videoeingangskanal sehen.
- \* Oder: die Fernsehgerät-Fernbedienung könnte eine Taste oder einen Schalter haben, womit verschiedene Videomodi gewählt werden.
- \* Nähere Angaben sind Ihrem Fernsehgerät-Handbuch zu entnehmen.

### Benutzung des DVD Setup-Menüs

Drücken Sie  um auf das Untermenü zuzugreifen.

Drücken Sie   um die Auswahl hervorzuheben.

Drücken Sie  zur Bestätigung.

Drücken Sie  zur Rückkehr zum vorigen Menü.

Drücken Sie  zum Entfernen des Menüs.

**Detaillierte Wiedergabe-Funktionen und zusätzliche Funktionen sind im begleitenden Benutzerhandbuch erläutert.**

# Verkorte handleiding

## Eerst aansluiten ...

- (A) Voorluidspreker (rechts)
- (B) Middenluidspreker
- (C) Voorluidspreker (links)
- (D) Scart-kabel
- (E) MW-antenne
- (F) FM-antenne
- (G) Subwoofer
- (H) Surround-luidspreker (links)
- (J) Surround-luidspreker (rechts)

### Handige tips:

U hoeft slechts één videoaansluiting te maken op uw tv om het afspelen van de dvd's te kunnen zien.

**Als uw tv geen SCART-aansluiting heeft, sluit uw tv dan aan via de overeenkomstige videoaansluiting 1 of 2 (kabels niet bijgeleverd).**

## ... dan afspelen

**Controleer of uw dvd-systeem en uw tv aangesloten en ingeschakeld zijn!**

### Afspelen van een disk

#### 1 Druk op DISC op de afstandsbediening.

U kunt druk op SOURCE op de voorkant draaien tot in het display "DISC" verschijnt.





#### 2 Zet de tv aan en kies het juiste video-ingangskanaal.

U moet nu het blauwe dvd-achtergrondschermbild op uw tv (als er geen disk in het dvd-systeem zit).

#### 3 Druk eenmaal op de toets OPEN/CLOSE om de disklade te openen, plaats er een disk in en druk vervolgens opnieuw op dezelfde toets om de disklade te sluiten.

Let erop dat de disk met het etiket naar boven geplaatst is. Bij tweezijdige disks, plaatst u de disk met de zijde die u wilt afspelen naar boven.

#### 4 Het afspelen gaat automatisch van start.

Als er een diskmenu verschijnt, gebruik dan     om de gewenste keuze te maken en druk vervolgens op OK. Of gebruik de cijfertoetsen op de afstandsbediening om een functie te kiezen. Volg de aanwijzingen die in het diskmenu gegeven worden.

#### 5 Om het afspelen te beëindigen, drukt u op STOP .



### Geen beeld!!

#### Controleer het AV (audio/video)-kanaal op uw tv.

- \* Dit kanaal bevindt zich normaal gezien tussen het laagste en het hoogste kanaal en kan de naam FRONT, AV IN of VIDEO hebben.
- \* U kunt ook naar kanaal 1 op uw tv gaan en vervolgens herhaaldelijk op de toets Volgend kanaal drukken tot u het video-ingangskanaal ziet.
- \* Het kan ook zijn dat de afstandsbediening van de tv een toets of schakelaar heeft waarmee u de verschillende videokanalen kunt kiezen.
- \* Zie de gebruiksaanwijzing van uw tv voor meer details.

### Gebruik van het dvd-instellingenmenu

Druk op  om het submenu te openen.

Druk op   om uw keuze te laten oplichten.

Druk op  om te bevestigen.

Druk op  om terug te keren naar het vorige menu.

Druk op  om het menu af te sluiten.

**Meer afspeelfuncties en overige functies staan beschreven in de bijbehorende gebruiksaanwijzing.**

## Guida d'uso rapido

### Prima collegare ...

- (A) Altoparlante anteriore (destra)
- (B) Altoparlante centrale
- (C) Altoparlante anteriore (sinistra)
- (D) Cavo Scart
- (E) Antenna MW
- (F) Antenna FM
- (G) Subwoofer
- (H) Altoparlante surround (sinistra)
- (J) Altoparlante surround (destra)

#### Suggerimenti di aiuto:

Basta effettuare un collegamento video alla TV per poter visualizzare la riproduzione del DVD.

Se la TV non è munita di un connettore SCART, collegarla tramite il corrispondente collegamento video 1 o 2 (cavo non fornito).

### ... quindi riprodurre

**Assicurarsi che il sistema DVD e la TV siano collegati ed accesi!**

#### Come riprodurre un disco

##### 1 Premere il tasto DISC sul telecomando.

Oppure, premere il pulsante SOURCE sul pannello anteriore fino a quando "DISC" appare sul pannello del display.

##### 2 Accendere la TV ed impostare il corretto canale video.

Si deve visualizzare lo schermo blu di sfondo del DVD sulla TV (se nessun disco è presente nel sistema DVD).

##### 3 Premere una volta il pulsante OPEN/CLOSE ▲ per aprire la piastra del disco e caricarvi un disco, quindi premere lo stesso pulsante un'altra volta per chiudere la piastra del disco.

Assicurarsi che l'etichetta del disco sia rivolta verso l'alto. Per dischi a doppio lato, caricare il disco col lato che si vuole riprodurre rivolto in alto.

##### 4 La riproduzione inizierà automaticamente.

Se appare un menu del disco, usare ▲▼◀▶ per effettuare la dovuta selezione, quindi premere OK. Oppure, usare la tastierina numerica sul telecomando per selezionare le funzioni. Seguire le istruzioni che appaiono sul menu del disco.

##### 5 Per arrestare la riproduzione, premere STOP ■.

### Assenza di immagine!!

#### Controllare il modo AV (audio/ video) della TV.

- \* Normalmente questo canale si trova tra il canale più alto e quello più basso e potrebbe essere denominato FRONT, A/V IN o VIDEO.
- \* Oppure, si potrebbe andare al canale 1 della TV, quindi premere ripetutamente il pulsante giù del canale fino a quando si vede il canale d'ingresso video.
- \* Oppure, il telecomando della TV potrebbe avere un pulsante o un interruttore che seleziona diverse modalità video.
- \* Per ulteriori dettagli consultare il manuale della TV.

#### Utilizzazione del menu setup

Premere  per accedere al submenu.

Premere   per evidenziare la selezione.

Premere  per confermare.

Premere  per ritornare al menu precedente.

Premere  per eliminare il menu.

**Le funzioni di riproduzione dettagliate ed altre funzioni sono descritte nell'accluso manuale dell'utente.**

## Snabbguide

### Anslut först.....

- (A) Fronthögtalare (höger)
- (B) Centerhögtalare
- (C) Fronthögtalare (vänster)
- (D) SCART-kabel
- (E) MV-antenn
- (F) FM-antenn
- (G) Subwoofer
- (H) Surroundhögtalare (vänster)
- (J) Surroundhögtalare (höger)

#### Nyttiga tips:

Du behöver bara göra en enda videoanslutning till din TV för att titta på DVD-skivor.

Om TV:n saknar SCART-kontakt, anslut då TV:n via motsvarande videokontakt 1 eller 2 (kablar medföljer inte).

### ... Spela sedan

**Guide Kontrollera att DVD-systemet och TV:n är anslutna och påslagna!**

#### Spela en skiva

##### 1 Tryck DISC på fjärrkontrollen.

Eller, tryck SOURCE på spelarens framsida tills "DISC" visas på teckenfönstret.

##### 2 Sätt på TV:n och ställ in den på korrekt videoingångskanal.

Du bör se den blå Philips DVD-bakgrundsbilden på TV:n (om det inte sitter någon skiva i DVD-spelaren).

##### 3 Tryck på knappen OPEN/CLOSE ▲ en gång för att öppna skivfacket och sätt i en skiva. Tryck sedan på samma knapp igen för att stänga facket.

Se till att etikettsidan är vänd uppåt. För dubbelsidiga skivor, ska du vända den sida du vill spela uppåt.

##### 4 Spelningen kommer att startas automatiskt.

Om en skivmeny visas, gör då nödvändigt val med hjälp av ▲▼◀▶, och tryck sedan på OK. Eller, använd sifvertangenterna på fjärrkontrollen till att välja funktioner. Följ anvisningarna som ges på skivmenyn.

##### 5 För att stoppa spelningen, tryck på STOP ■.

### Ingen bild !!

#### Kontrollera AV-läget (Audio/Video) på din TV.

- \* Vanligtvis ligger denna kanal mellan de lägsta och de högsta kanalerna och kan heta FRONT, A/V IN eller VIDEO.
- \* Eller gå till kanal 1 på din TV och tryck sedan på knappen för att gå till lägre kanal upprepade gånger tills du får fram videoingångskanalen.
- \* Eller så har TV-apparatens fjärrkontroll en knapp eller omkopplare för att välja mellan olika videolägen.
- \* Se bruksanvisningen för din TV för närmare information.

#### Använda DVD-inställningsmenyn

Trycka på  så att undermenyn visas.

Trycka på   så att valet markeras.

Trycka på  så att valet bekräftas.

Trycka på  så att återgå till föregående meny genom.

Trycka på  så att stäng menyn genom.

**För detaljer om avspelnings- och andra funktioner, se den medföljande bruksanvisningen.**

# Hurtigbrugsguide

## Tilslut først....

- A Fronthøjtaler (højre)
- B Midterhøjtaler
- C Fronthøjtaler (venstre)
- D Scart-kabel
- E MW-antenne
- F FM-antenne
- G Subwoofer
- H Surround-højtaler (venstre)
- J Surround-højtaler (højre)

### Nyttige tips:

For at se DVD-afspilning er det kun nødvendigt at foretage én videotilslutning til TV'et.

Hvis dit tv ikke er udstyret med en **SCART-stikforbindelse**, tilsluttes tv'et via den tilsvarende videotilslutning **1** eller **2** (kabler medfølger ikke).

## ... og spil derefter

**Sørg for at DVD-anlægget og TV'et er forbundet, og at der er tændt for apparaterne!**

### Afspilning af discs

#### 1 Tryk på DISC på fjernbetjeningen.

Eller, tryk på SOURCE knappen på frontpanelet indtil displaypanelet viser "DISC".



#### 2 Tænd for TV'et og stil det ind på den rigtige videokanal.

Den blå DVD-baggrund skal ses på TV-skærmen (uden lagt disc i DVD-systemet).

#### 3 Tryk én gang på OPEN/CLOSE knappen for at lukke disc-skuffen op og lægge en disc. Tryk igen på samme knap for at lukke disc-skuffen i.

Sørg for at disc'ens trykte side vender opad. Hvis det er en dobbeltsidet disc, skal den side, der skal afspilles, vende opad.

#### 4 Afspilningen starter automatisk.

Hvis der ses en disc-menu på skærmen, foretages det nødvendige valg ved at trykke på    tastene. Tryk derefter på OK. Eller brug cifertasterne på fjernbetjeningen til at vælge det ønskede. Følg de instruktioner der ses i disc-menuen.

#### 5 Afspilningen stoppes ved at trykke på STOP .

## Ingen billede!!

### Kontrollér AV (Audio/Video) indstillingen i TV'et.

\* Denne kanal ligger normalt mellem den laveste og den højeste kanal og kaldes for FRONT, AV IN, eller VIDEO.

\* Eller: Vælg kanal 1 på TV'et og tryk derefter gentagne gange på "kanal ned" knappen indtil videokanalen ses.

\* Eller: Fjernbetjeningen har en tast eller en omskifterknap, som vælger mellem forskellige videostillinger.

\* Angående flere detaljer se i TV'ets brugervejledning.

### Brug af menuen til DVD-opsætning

Tryk på  for at åbne undermenuen.

Tryk på   for at fremhæve valget.

Tryk på  for at bekræfte.

Tryk på  for at vende tilbage til foregående menu.

Tryk på  for at fjerne menuen.

**Detaljerede afspilningsfinesser og yderligere funktioner er beskrevet i den medfølgende brugsanvisning.**

# Pikakäyttöohje

## Yhdistä ensin ...

- A Etukaiutin (oikea)
- B Keski-kaiutin
- C Etukaiutin (vasen)
- D Scart-johto
- E KA-antenni
- F ULA-antenni
- G Subwoofer
- H Surround-kaiutin (vasen)
- J Surround-kaiutin (oikea)

### Hyödyllisiä vinkkejä:

Sinun tarvitsee tehdä vain yksi kytkentä television voidaksesi katsoa DVD-levyjä.

Jos televisiossa ei ole **SCART**-liitäntää, yhdistä televisio vastaavan videoliitäntään **1** tai **2** (johtoja ei ole mukana).

## ... toista sitten

**Varmista, että DVD-järjestelmä ja tv on yhdistetty ja virta on kytketty!**

### Levyn toisto

#### 1 Paina kauko-ohjaimesta painiketta DISC.

Tai, paina painiketta SOURCE, kunnes näyttöpaneeliin ilmestyy "DISC".



#### 2 Kytke televisio toimintaan ja valitse oikea videokanava.

Televisiosta tulisi näkyä sininen DVD -taustakuva (jos levyä ei ole sisällä).

#### 3 Avaa levykelkka painamalla kerran painiketta OPEN/CLOSE ja syötä levy, sulje sitten levykelkka painamalla samaa painiketta uudelleen.

Aseta levy etiketti ylöspäin. Aseta kaksipuolisista levyistä ylöspäin se puoli, jonka haluat toistaa.

#### 4 Toisto alkaa automaattisesti.

Jos näytetään levyvalikko, valitse painikkeilla    ja paina sitten painiketta OK. Tai valitse käyttämällä kauko-ohjaimen numeropainikkeita. Noudata levyvalikossa annettuja ohjeita.

#### 5 Pysäytä toisto painikkeella STOP .

## Ei kuvaa !!

### Tarkista television AV-toiminto (Audio/Video).

\*Yleensä tämä kanava on alimman ja ylimmän kanavan välillä ja sen nimenä voi olla FRONT, AV IN tai VIDEO.

\*Tai, voit valita televisiosta kanavan 1; paina sen jälkeen kanavan pienentävää painiketta toistuvasti, kunnes videokanava näkyy.

\*Tai, television kauko-ohjaimessa voi olla painike, jolla valitaan eri videotoinnot.

\*Katso tarkemmat ohjeet television käyttöohjeesta.

### DVD-asetusvalikon käyttäminen

Siirry alivalikkoon painamalla  -painiketta.

Korosta valinta painamalla   -painiketta.

Vahvista valinta painamalla  -painiketta.

Voit palata edelliseen valikkoon painamalla  -painiketta .

Voit poistaa valikon näytöstä painamalla  -painiketta.

**Toisto-ominaisuudet ja muut toiminnot on selostettu tarkemmin mukana tulevassa käyttöohjeessa.**





# Skeócona instrukcja obsługi

## Najpierw podłącz ...

- (A) Przedni głośnik (prawy)
- (B) Głośnik środkowy
- (C) Przedni głośnik (lewy)
- (D) Przewód Scart
- (E) Antena MW
- (F) Antena FM
- (G) Subwoofer
- (H) Głośnik satelitarny (lewy)
- (J) Głośnik satelitarny (prawy)

### Wskazówki:







Do odtwarzania płyt DVD potrzebne jest tylko jedno połączenie video z odbiornikiem TV.

**Jeśli odbiornik TV nie jest wyposażony w złącze SCART,** należy go podłączyć za pośrednictwem odpowiedniego gniazda video [1] lub [2] (kable nie należą do wyposażenia).

## ... potem odtwarzaj

**Zestaw DVD i odbiornik TV muszą być połączone i włączone!**

### Odtwarzanie płyty







- 1 Naciśnij przycisk DISC na pilocie zdalnego sterowania.**  
Naciśnij przycisk SOURCE aż na wyświetlaczu pojawi się wskazanie "DISC" (Płyta).
- 2 Włącz odbiornik TV i ustaw prawidłowy kanał Video In.**  
Na ekranie odbiornika TV powinien wyświetlić się niebieski ekran odtwarzacza DVD (jeżeli w odtwarzaczu nie ma płyt).
- 3 Naciśnij jeden raz przycisk OPEN/CLOSE  w celu otwarcia szuflady odtwarzacza, włóż płytę, a następnie ponownie naciśnij ten przycisk w celu zamknięcia szuflady.**  
Należy sprawdzić, czy płyta została ułożona nadrukiem do góry. W przypadku płyt dwustronnych, strona, która ma być odtwarzana powinna być zwrócona do góry.
- 4 Odtwarzanie rozpocznie się automatycznie.**  
Jeśli wyświetlone zostanie menu płyty, dokonaj odpowiedniego wyboru za pomocą przycisków     i naciśnij OK. Wybór funkcji umożliwiają również przyciski numeryczne na pilocie. Postępuj zgodnie z instrukcjami w menu płyty.
- 5 Aby zatrzymać odtwarzanie, naciśnij przycisk STOP .**

### Brak obrazu!!

#### Sprawdź tryb AV (audio/wideo) odbiornika TV.

- \* Zazwyczaj kanał ten znajduje się pomiędzy najniższym i najwyższym kanałem i może być oznaczony jako FRONT, A/V IN lub VIDEO.
- \* Można również przejść do kanału 1 odbiornika TV, a następnie naciskać przycisk zmiany kanałów w dół do momentu znalezienia kanału wideo.
- \* Także pilot zdalnego sterowania odbiornika TV może być wyposażony w przycisk lub przełącznik pozwalający na wybór różnych trybów wideo.
- \* Więcej informacji znajduje się w instrukcji obsługi odbiornika TV.

### Korzystanie z menu ustawień DVD

- Naciśnij  aby przejść do podmenu.
- Naciśnij   aby wybrać pozycję.
- Naciśnij  aby potwierdzić.
- Naciśnij  aby powrócić do poprzedniego menu.
- Naciśnij  aby usunąć menu.

# Краткое руководство

## Сначала подключите ...

- (A) Передняя колонка (Правая)
- (B) Центральная колонка
- (C) Передняя колонка (Левая)
- (D) Кабель Scart
- (E) Рамочная антенна MW
- (F) Проводная антенна FM
- (G) Низкочастотная колонка
- (H) Колонка объемного звучания (Левая)
- (J) Колонка объемного звучания (Правая)

### Полезные советы

Для воспроизведения дисков DVD необходимо выполнить только одно видеосоединение с телевизором.

**Если у телевизора нет разъема SCART,** подсоединит телевизор чрез соответствующий видо содинни [1] или [2] (кабели не прилагаются).

## ...затем воспроизводите

**Убедитесь, что микросистема DVD и телевизор соединены и включены!**

### Воспроизведение диска

- 1 На пульте ДУ нажмите кнопку DISC.**  
Также можно нажимать кнопку SOURCE на передней панели до появления на экране дисплея надписи "DISC".
- 2 Включите телевизор и выберите соответствующий режим видеовхода.**  
На телевизоре должен появиться фоновый экран (если в системе DVD нет диска).
- 3 На передней панели системы DVD нажмите OPEN/CLOSE  и загрузите диск, затем снова нажмите соответствующую кнопку OPEN/CLOSE  чтобы закрыть лоток для диска.**  
Убедитесь, что диск вставлен этикеткой вверх. Диски, записанные с обеих сторон, вставляйте вверх стороной, которая будет проигрываться.
- 4 Воспроизведение начнется автоматически.**  
Если появилось меню диска, при помощи кнопок     сделайте нужный выбор, для подтверждения нажмите OK. Можно также использовать цифровую клавиатуру на пульте ДУ. Следуйте инструкциям, приведенным в меню диска.
- 5 Для остановки воспроизведения нажмите STOP .**

### Нет изображения !!

#### Проверьте, находится ли телевизор в режиме AV (Аудио/Видео).

- \* Обычно этот канал находится между самым нижним и самым высоким каналами и обычно называется FRONT, A/V IN, или VIDEO.
- \* Можно также перейти к каналу 1 телевизора и нажимать кнопку канала вниз до тех пор, пока вы не появится канал видеовхода.
- \* На пульте ДУ может находиться специальная кнопка или переключатель для выбора различных видеорежимов.
- \* Подробности смотрите в руководстве своего телевизора.

### Использование меню настройки DVD

- Нажмите  для входа в подменю.
- Нажмите  , чтобы выбрать выбранный пункт.
- Нажмите  для подтверждения выбора.
- Нажмите , чтобы вернуться к предыдущему меню.
- Нажмите , чтобы убрать меню.

**Zaawansowane funkcje odtwarzania oraz funkcje dodatkowe opisano w dołączonej do zestawu instrukcji obsługi.**

**Детальное описание функций воспроизведения и описание дополнительных функций содержится в прилагаемом руководстве пользователя.**