

Always there to help you

Register your product and get support at
www.philips.com/support



HTL5140B



User manual

PHILIPS

Contents

1	Important	2
	Safety	2
	Care for your product	3
	Care of the environment	3
	Compliance	3
	Help and support	3

2	Your SoundBar	4
	Main unit	4
	Remote control	4
	Connectors	5
	Wireless subwoofer	6

3	Connect and set up	6
	Pair up with the subwoofer	6
	Placement	7
	Connect to TV	7
	Connect digital devices through HDMI	7
	Connect audio from TV and other devices	8

4	Use your SoundBar	9
	Adjust the volume	9
	Choose your sound	9
	Play audio through Bluetooth	10
	Connect Bluetooth via NFC	10
	MP3 player	11
	USB storage devices	11
	Auto standby	11
	Set display brightness	11
	Apply factory settings	12

5	Update software	12
	Check software version	12
	Update software via USB	12

6	Wall mount	13
----------	-------------------	----

7	Product specifications	14
----------	-------------------------------	----

8	Troubleshooting	15
----------	------------------------	----

1 Important

Read and understand all instructions before you use your product. If damage is caused by failure to follow instructions, the warranty does not apply.

Safety

Risk of electric shock or fire!

- Never expose the product and accessories to rain or water. Never place liquid containers, such as vases, near the product. If liquids are spilt on or into the product, disconnect it from the power outlet immediately. Contact Consumer Care to have the product checked before use.
- Never place the product and accessories near naked flames or other heat sources, including direct sunlight.
- Never insert objects into the ventilation slots or other openings on the product.
- Where the mains plug or an appliance coupler is used as the disconnect device, the disconnect device shall remain readily operable.
- Disconnect the product from the power outlet before lightning storms.
- When you disconnect the power cord, always pull the plug, never the cable.

Risk of short circuit or fire!

- Before you connect the product to the power outlet, ensure that the power voltage matches the value printed on the back or bottom of the product. Never connect the product to the power outlet if the voltage is different.

Risk of injury or damage to this product!

- Never place the product or any objects on power cords or on other electrical equipment.

- If the product is transported in temperatures below 5°C, unpack the product and wait until its temperature matches room temperature before connecting it to the power outlet.
- Parts of this product can be made of glass. Handle with care to avoid injury and damage.

Risk of overheating!

- Never install this product in a confined space. Always leave a space of at least four inches around the product for ventilation. Ensure curtains or other objects never cover the ventilation slots on the product.

Risk of contamination!

- Do not mix batteries (old and new or carbon and alkaline, etc.).
- Danger of explosion if batteries are incorrectly replaced. Replace only with the same or equivalent type.
- Remove batteries if they are exhausted or if the remote control is not to be used for a long time.
- Batteries contain chemical substances, they should be disposed of properly.

Risk of swallowing batteries!

- The product/remote control may contain a coin/button type battery, which can be swallowed. Keep the battery out of reach of children at all times! If swallowed, the battery can cause serious injury or death. Severe internal burns can occur within two hours of ingestion.
- If you suspect that a battery has been swallowed or placed inside any part of the body, seek immediate medical attention.
- When you change the batteries, always keep all new and used batteries out of reach of children. Ensure that the battery compartment is completely secure after you replace the battery.
- If the battery compartment cannot be completely secured, discontinue use of the product. Keep out of reach of children and contact the manufacturer.



This is CLASS II apparatus with double insulation, and no protective earth provided.

Care for your product

Use only microfiber cloth to clean the product.

Care of the environment



Your product is designed and manufactured with high quality materials and components, which can be recycled and reused.



When this crossed-out wheeled bin symbol is attached to a product it means that the product is covered by the European Directive 2002/96/EC. Please inform yourself about the local separate collection system for electrical and electronic products.

Please act according to your local rules and do not dispose of your old products with your normal household waste.

Correct disposal of your old product helps to prevent potential negative consequences for the environment and human health.



Your product contains batteries covered by the European Directive 2006/66/EC, which cannot be disposed with normal household waste. Please inform yourself about the local rules on separate collection of batteries because correct disposal helps to prevent negative consequences for the environmental and human health.

Compliance

CE 0560

This product complies with the radio interference requirements of the European Community.

Hereby, WOOX Innovations declares that this product is in compliance with the essential requirements and other relevant provisions of Directive 1999/5/EC. You can find the Declaration of Conformity on www.p4c.philips.com.

Help and support

For extensive online support, visit www.philips.com/support to:

- download the user manual and the quick start guide
- watch video tutorials (available only for selected models)
- find answers to frequently answered questions (FAQs)
- email us a question
- chat with our support representative.

Follow the instructions on the website to select your language, and then enter your product model number.

Alternatively, you can contact Consumer Care in your country. Before you contact, note down the model number and serial number of your product. You can find this information on the back or bottom of your product.

2 Your SoundBar

Congratulations on your purchase, and welcome to Philips! To fully benefit from the support that Philips offers, register your SoundBar at www.philips.com/support.

Main unit

This section includes an overview of the main unit.

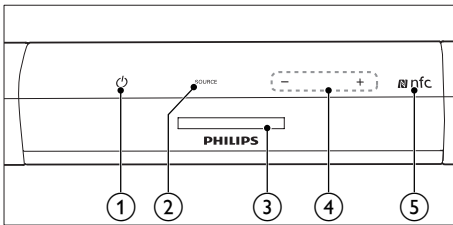

- ① **⏻ (Standby-On/Standby indicator)**
 - Switch the SoundBar on or to standby.
 - When the SoundBar is in standby, the standby indicator turns red.
- ② **SOURCE**
Select an input source for the SoundBar.
- ③ **Display panel**
- ④ **+/- (Volume)**
Increase or decrease volume.
- ⑤ **NFC tag**
Tap the NFC-enabled device on the tag for Bluetooth connection.

Remote control

This section includes an overview of the remote control.

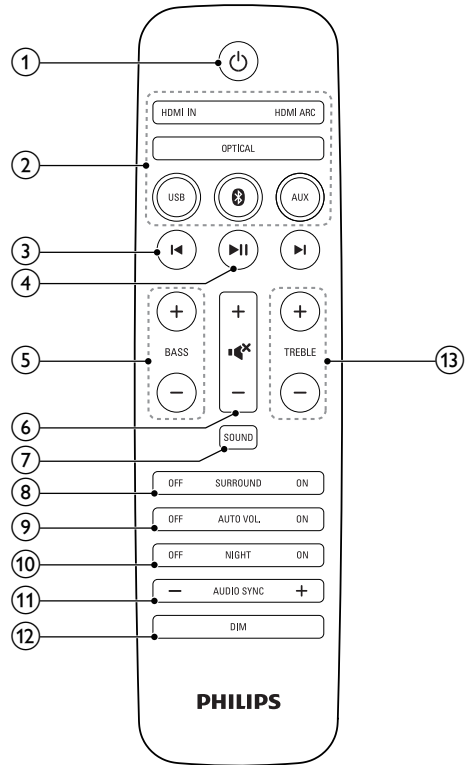



- ① **⏻ (Standby-On)**
Switch the SoundBar on or to standby.
- ② **Source buttons**
 - **HDMI ARC:** Switch your source to HDMI ARC connection.
 - **HDMI IN:** Switch your source to the HDMI IN connection.
 - **Bluetooth:** Switch to Bluetooth mode.
 - **USB:** Switch to USB mode.
 - **OPTICAL:** Switch your audio source to the optical connection.
 - **AUX:** Switch your audio source to the AUDIO IN or AUX connection (3.5mm jack).

- ③ **⏮ / ⏭ (Previous/Next)**
Skip to the previous or next track in USB mode.
- ④ **⏸ (Play/Pause)**
 - Start, pause or resume play in USB mode.
- ⑤ **BASS +/-**
Increase or decrease bass.
- ⑥ **Volume control**
 - +/-: Increase or decrease volume.
 - : Mute or restore volume.
- ⑦ **SOUND**
Select a sound mode.
- ⑧ **SURROUND ON/OFF**
Select surround or stereo sound.
- ⑨ **AUTO VOL ON/OFF**
Turn auto volume on or off.
- ⑩ **NIGHT ON/OFF**
Turn night mode on or off.
- ⑪ **AUDIO SYNC +/-**
Increase or decrease audio delay.
- ⑫ **DIM**
Set the brightness of SoundBar display panel.
- ⑬ **TREBLE +/-**
Increase or decrease treble.

Connectors

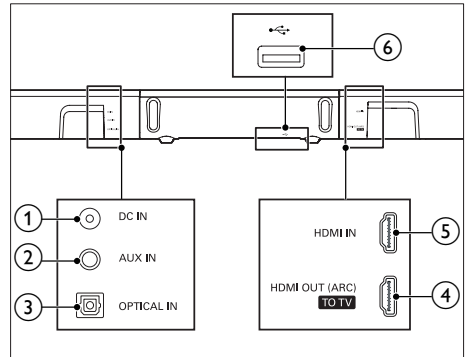
This section includes an overview of the connectors available on your SoundBar:



- ① **DC IN**
Connect to the power supply.
- ② **AUX IN**
Connect to an audio output on a device via AUDIO IN or AUX source (by pressing repeatedly **AUX** on the remote control).
- ③ **OPTICAL IN**
Connect to an optical audio output on the TV or a digital device.
- ④ **HDMI OUT (ARC) - TO TV**
Connect to the HDMI input on the TV.
- ⑤ **HDMI IN**
Connect to the HDMI output on a digital device.
- ⑥ 
 - Audio input from a USB storage device.
 - Upgrade software of this product.
 - Charge a USB device.

Wireless subwoofer

The SoundBar comes with a wireless subwoofer.

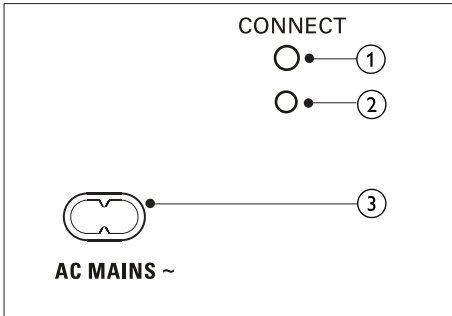

- ① **CONNECT (connect)**
Press to enter the pairing mode for the subwoofer.
- ② **Subwoofer indicator**
 - When the power is turned on, the indicator lights up.
 - During wireless pairing between the subwoofer and the main unit, the indicator blinks white quickly.
 - When the pairing succeeds, the indicator lights up white.
 - When the pairing fails, the indicator blinks white slowly.
 - When wireless connection is disconnected for one minute, the indicator turns off.
- ③ **AC MAINS~**
Connect to the power supply.

3 Connect and set up

This section helps you connect your SoundBar to a TV and other devices, and then set it up. For information about the basic connections of your SoundBar and accessories, see the quick start guide.

Note

- For identification and supply ratings, see the type plate at the back or bottom of the product.
- Before you make or change any connections, make sure that all devices are disconnected from the power outlet.

Pair up with the subwoofer

The wireless subwoofer automatically pairs up with the SoundBar for wireless connection when you turn on the SoundBar and the subwoofer.

If no audio from the wireless subwoofer can be heard, manually pair up the subwoofer:

- 1 Turn on the SoundBar and the subwoofer.
 - ↳ If the connection to the SoundBar is lost, the indicator on the subwoofer blinks white slowly.
- 2 Press the **CONNECT (connect)** button on the subwoofer to enter the pairing mode.
 - ↳ The indicator on the subwoofer blinks white quickly.
- 3 On the remote control, within six seconds press **◀** twice then **BASS +** once, and then hold down **SURROUND ON**.
 - ↳ If the pairing succeeds, the indicator on the subwoofer lights up white.
 - ↳ If the pairing fails, the indicator on the subwoofer blinks white slowly.
- 4 If the pairing fails, repeat the steps above.

Placement

Place the subwoofer at least 1 meter (3 feet) away from your SoundBar, and ten centimeters away from the wall.

For best results, place your subwoofer as shown below.

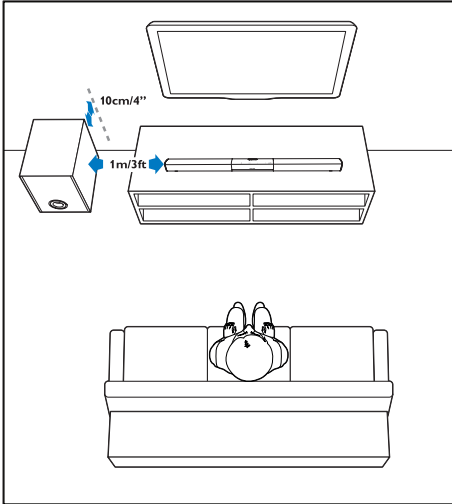

Connect to TV

Connect your SoundBar to a TV. You can listen to audio from TV programs through your SoundBar. Use the best quality connection available on your SoundBar and TV.

Connect to TV through HDMI (ARC)

Your SoundBar supports HDMI with Audio Return Channel (ARC). If your TV is HDMI ARC compliant, you can hear the TV audio through your SoundBar by using a single HDMI cable.

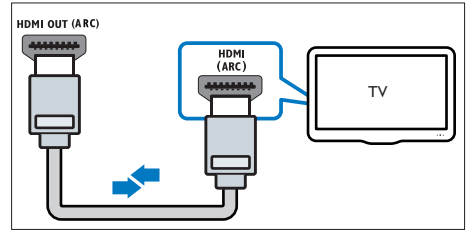

- 1 Using a High Speed HDMI cable, connect the **HDMI OUT (ARC)-TO-TV** connector on your SoundBar to the **HDMI ARC** connector on the TV.
 - The **HDMI ARC** connector on the TV might be labeled differently. For details, see the TV user manual.
- 2 On your TV, turn on HDMI-CEC operations. For details, see the TV user manual.

Note

- If your TV is not HDMI ARC compliant, connect an audio cable to hear the TV audio through your SoundBar (see 'Connect audio from TV and other devices' on page 8).
- If your TV has a DVI connector, you can use an HDMI/DVI adapter to connect to TV. However, some of the features may not be available.

Connect digital devices through HDMI

Connect a digital device such as a set-top box, DVD/Blu-ray player, or games console to your SoundBar through a single HDMI connection. When you connect the devices in this way and play a file or game, the

- video is automatically displayed on your TV, and
- audio is automatically played on your SoundBar.

- 1 Using a High Speed HDMI cable, connect the **HDMI OUT** connector on your digital device to the **HDMI IN** on your SoundBar.
- 2 Connect your SoundBar to TV through **HDMI OUT (ARC)**.
 - If the TV is not HDMI CEC compliant, select the correct video input on your TV.
- 3 On the connected device, turn on HDMI-CEC operations. For details, see the user manual of the device.

Connect audio from TV and other devices

Play audio from TV or other devices through your Soundbar speakers. Use the best quality connection available on your TV, Soundbar, and other devices.

Note

- When your Soundbar and TV are connected through HDMI ARC, an audio connection is not required. (see 'Connect to TV through HDMI (ARC)' on page 7)

Option 1: Connect audio through a digital optical cable

Best quality audio

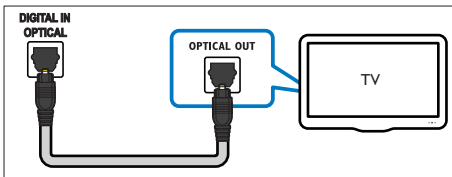

- 1 Using an optical cable, connect the **OPTICAL IN** connector on your SoundBar to the **OPTICAL OUT** connector on the TV or other device.
 - The digital optical connector might be labeled **SPDIF** or **SPDIF OUT**.

Option 2: Connect audio through analog audio cables

Basic quality audio

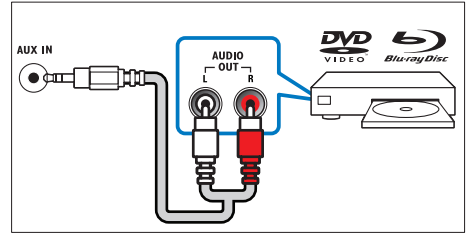

- 1 Using an analog cable, connect the **AUX IN** (3.5mm jack) on your SoundBar to the **AUDIO OUT** connectors (red and white) on the TV or other device.
- 2 Press repeatedly **AUX** on the remote control until **AUX** is displayed on the display panel.



4 Use your SoundBar

This section helps you use the SoundBar to play audio from connected devices.

Before you start

- Make the necessary connections described in the quick start guide and the user manual.
- Switch the SoundBar to the correct source for other devices.

Adjust the volume

- 1 Press +/- (**Volume**) to increase or decrease a volume level.
 - To mute sound, press  (**Mute**).
 - To restore the sound, press  (**Mute**) again or press +/- (**Volume**).

Choose your sound

This section helps you choose the ideal sound for your video or music.

Sound mode

Select predefined sound modes to suit your video or music.

- 1 Press **SOUND** to select a sound option from the display panel.
 - **AUTO**: Automatically select a sound setting based on the sound stream.
 - **POWERFUL**: Enjoy thrilling arcade sounds, ideal for action-packed videos and loud parties.
 - **BALANCED**: Experience the original sound of your movies and music, without added sound effects.

- **BRIGHT**: Spice up your dull movies and music with added sound effects.
- **CLEAR**: Hear every detail in your music and clear voices in your movies.
- **WARM**: Experience spoken words and music vocals in comfort.
- **PERSONAL**: Personalize the sound based on your preferences.

Surround sound mode

Experience an immersive audio experience with surround sound modes.

- 1 Press **SURROUND ON/OFF** to turn surround mode on or off.
 - **On**: Create a surround listening experience.
 - **Off**: Two-channel stereo sound. Ideal for listening to music.

Equalizer

Change the high frequency (treble) and low frequency (bass) settings of the SoundBar:

- 1 Press **TREBLE +/-** or **BASS +/-** to change the frequency.

Synchronize video and sound

If the audio and video are not synchronized, delay the audio to match the video.

- 1 Press **AUDIO SYNC +/-** to synchronize the audio with the video.

Auto volume

Turn the auto volume on to keep the volume constant when you switch to a different source.

- 1 Press **AUTO VOL ON/OFF** to turn auto volume on or off.

Night mode

For quiet listening, night mode decreases the volume of loud sounds when audio is played. Night mode is only available for Dolby Digital soundtracks.

- 1 Press **NIGHT ON/OFF** to turn night mode on or off.

Note

- If auto volume is set to turned on, you cannot enable the night mode.

Play audio through Bluetooth

Through Bluetooth, connect the SoundBar with your Bluetooth device (such as an iPad, iPhone, iPod touch, Android phone, or laptop), and then you can listen to the audio files stored on the device through your SoundBar speakers.

What you need

- A Bluetooth device which supports Bluetooth profile A2DP, AVRCP and with Bluetooth version as 3.0 + EDR.
- The maximum operational range between the SoundBar and a Bluetooth device is approximately 10 meters (30 feet).

- 1 Press **0** on the remote control to switch the SoundBar to Bluetooth mode.
 - ↳ **BT** is displayed on the display panel, blinking.
- 2 On the Bluetooth device, switch on Bluetooth, search for and select **PHILIPS HTL5140** to start connection (see the user manual of the Bluetooth device on how to enable Bluetooth).
 - ↳ During connection, **BT** on the display panel blinks.

- 3 Wait until the SoundBar beeps.
 - ↳ When the Bluetooth connection succeeds, **BT** is displayed on the display panel.
 - ↳ If the connection fails, **BT** on the display panel blinks continuously.
- 4 Select and play audio files or music on your Bluetooth device.
 - During play, if a call is coming, music play is paused. Play resumes when the call ends (this feature is dependent on the connected mobile device).
 - If your Bluetooth device supports AVRCP profile, on the remote control you can press **◀/▶** to skip to a track, or press **▶||** to pause/resume play.
- 5 To exit Bluetooth, select other source.
 - When your switch back to Bluetooth mode, Bluetooth connection remains active.

Note

- The music streaming may be interrupted by obstacles between the device and SoundBar, such as wall, metallic casing that covers the device, or other devices nearby that operate in the same frequency.
- If you want to connect your SoundBar with another Bluetooth device, press and hold **0** on the remote control to disconnect the currently connected Bluetooth device.

Connect Bluetooth via NFC

NFC (Near Field Communication) is a technology that enables short-range wireless communication between NFC-enabled devices, such as mobile phones.

What you need

- A Bluetooth device with NFC function.
 - For pairing, tap the NFC device on the **NFC** tag of the SoundBar.
- 1 Enable NFC on the Bluetooth device (see the device's user manual for details).

- 2 Tap the NFC device onto the **NFC** tag of the SoundBar until the SoundBar beeps.
 - For first time connection, on some mobile devices prompt for pair-up appears, select "YES" for connection.
 - ↳ When the Bluetooth connection succeeds, **BT** is displayed on the display panel.
 - ↳ If the connection fails, **BT** on the display panel blinks continuously.
- 3 Select and play audio files or music on your NFC device.
 - To break the connection, tap again the NFC device onto the **NFC** tag on the SoundBar.

MP3 player

Connect your MP3 player to play your audio files or music.

What you need

- An MP3 player.
- A 3.5mm stereo audio cable.

- 1 Using the 3.5mm stereo audio cable, connect the MP3 player to the **AUX IN** connector on your SoundBar.
- 2 Press repeatedly **AUX** on the remote control until **AUDIO IN** is displayed on the display panel.
- 3 Press the buttons on the MP3 player to select and play audio files or music.



USB storage devices

Enjoy audio on a USB storage device, such as an MP3 player and USB flash memory, etc.

What you need

- A USB storage device that is formatted for FAT or NTFS file systems, and complies with the Mass Storage Class.
- An MP3 or WMA file on a USB storage device

- 1 Connect a USB storage device to this product.
- 2 Press **USB** on the remote control.
- 3 Use the remote control to control play.

Button	Action
	Start, pause or resume play.
	Skip to the previous or next track.
USB	During USB play, press repeatedly to select a repeat or shuffle mode, or turn off a play mode.

Note

- This product supports WMA files which are converted via Windows Media Player (WMA files converted via other file format converters may not work).
- If a USB storage device has a large media library, it takes some time to load those contents.
- This product may not be compatible with certain types of USB storage device.
- If you use a USB extension cable, USB HUB, or USB multi-reader, the USB storage device may not be recognized.
- Digital camera PTP and MTP protocols are not supported.
- Do not remove the USB storage device while it is being read.
- DRM-protected music files (MP3, WMA) are not supported.
- Support a USB port: 5V --- 1A.

Auto standby

When playing media from a connected device, the SoundBar automatically switches to standby after 15 minutes of button inactivity and no audio/video play from a connected device.

Set display brightness

You can press **DIM** repeatedly to select a different brightness level of the display panel on this product.

Apply factory settings

You can reset this product to the default settings programmed at the factory.

- 1 In any source mode, on the remote control press **Volume -**, **BASS -**, and **TREBLE -** in sequence within three seconds.
 - ↳ When the factory settings restore is complete, the product automatically switches off and restarts.



5 Update software

To get the best features and support, update your product with the latest software.

Check software version

In HDMI ARC source, on the remote control press **TREBLE -**, **BASS -**, and **Volume -** in sequence.

Update software via USB

- 1 Check the latest software version on www.philips.com/support.
 - Search for your model and click on "Software and drivers".
- 2 Download the software into a USB storage device.
 - ① Unzip the download if zipped, and make sure that the unzipped file is named "HTL5140.BIN".
 - ② Put the "HTL5140.BIN" file in the root directory.
- 3 Connect the USB storage device to the  (USB) connector on this product.
- 4 Switch this product to HDMI ARC source.
- 5 On the remote control, within six seconds press  twice then **Volume +** once, and then hold down **SURROUND ON**.
 - ↳ "UPGRADE" (upgrade) blinks on the display panel.
- 6 Press  to start the upgrade.
 - ↳ Then "UPGRADE" (upgrade) is displayed on the display panel.
- 7 Wait until the upgrade is completed.
 - ↳ If the upgrade is complete, this product automatically turns off and on again.



Caution

- Do not turn off the power or remove the USB storage device when the software update is in progress because you might damage this product.

6 Wall mount



Note

- Improper wall mounting may result in accident, injury or damage. If you have any query, contact Consumer Care in your country.
- Before wall mounting, make sure the wall can support the weight of your SoundBar.
- Before wall mount, you need not remove the four rubber feet at the bottom of the SoundBar; otherwise the rubber feet cannot be fixed back.

Screw length/diameter

Depending on the type of wall mounting your SoundBar; make sure that you use screws of a suitable length and diameter:

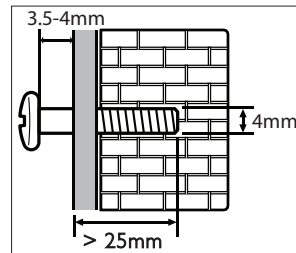

See the illustration in the quick start guide on how to wall mount the SoundBar:

- 1) Drill two holes on the wall.
- 2) Secure the dowels and screws in the holes.
- 3) Hang the SoundBar on the fastening screws.

7 Product specifications

Note

- Specifications and design are subject to change without notice.

Amplifier

- Total output power: 320W RMS (+/- 0.5 dB, 10% THD)
- Frequency response: 20 Hz-20 kHz / ± 3 dB
- Signal-to-noise ratio: > 65 dB (CCIR) / (A-weighted)
- Input sensitivity:
 - AUX: 500 mV
 - AUDIO IN: 200 mV

Audio

- S/PDIF Digital audio input:
 - Optical: TOSLINK

USB

- Compatibility: Hi-Speed USB (2.0)
- Class support: USB Mass Storage Class (MSC)
- File system: FAT16, FAT32, NTFS
- Supports MP3 and WMA file formats
- Sampling frequency:
 - MP3: 8 kHz, 11 kHz, 12 kHz, 16 kHz, 22 kHz, 24 kHz, 32 kHz, 44.1 kHz, 48 kHz
 - WMA: 44.1 kHz, 48 kHz
- Constant bit rate:
 - MP3: 8 kbps-320 kbps
 - WMA: 32 kbps-192 kbps
- Version:
 - WMA: V7, V8, V9

Note

- This product supports WMA files which are converted via Windows Media Player (WMA files converted via other file format converters may not work).

Bluetooth

- Bluetooth profiles: A2DP, AVRCP
- Bluetooth version: 3.0 + EDR

Main unit

- Power supply:
 - Model (Philips branded AC power adapter): DYS602-210309W; AS650-210-AA309
 - Input: 100-240 V~, 50/60 Hz 1.5 A
 - Output: 21V \equiv , 3.09A
- Standby power consumption: ≤ 0.5 W
- Speaker impedance
 - Woofer: 8 ohm
 - tweeter: 8 ohm
- Speaker drivers: 4 x (90mm/3.5" x 34mm/1.3") woofer + 2 x 31mm/1.2" tweeter
- Dimensions (WxHxD): 1045 x 49 x 72 mm
- Weight: 2.0 kg

Subwoofer

- Power supply: 220-240 V~, 50-60 Hz
- Power consumption: 60 W
- Standby power consumption: ≤ 0.5 W
- Impedance: 3 ohm
- Speaker drivers: 1 x 203 mm (8") woofer
- Dimensions (WxHxD): 208 x 301 x 403 mm
- Weight: 5.8 kg

Remote control batteries

- 2 x AAA-R03-1.5 V

Standby information

- When the product remains inactive for 15 minutes, it automatically switches to standby or networked standby.
- The power consumption in standby or networked standby is less than 0,5W.
- To deactivate Bluetooth connection, press and hold the Bluetooth button on the remote control.
- To activate Bluetooth connection, enable Bluetooth connection on your Bluetooth device, or enable Bluetooth connection via the NFC tag (if available).

8 Troubleshooting



Warning

- Risk of electric shock. Never remove the casing of the product.

To keep the warranty valid, never try to repair the product yourself.

If you have problems using this product, check the following points before you request service. If you still have a problem, get support at www.philips.com/support.

Main unit

The buttons on the SoundBar do not work.

- Disconnect the SoundBar from the power supply for a few minutes, then reconnect.

Sound

No sound from SoundBar speakers.

- Connect the audio cable from your SoundBar to your TV or other devices. However, you do not need a separate audio connection when:
 - the SoundBar and TV are connected through **HDMI ARC** connection, or
 - a device is connected to the **HDMI IN** connector on your SoundBar.
- Reset your SoundBar to its factory settings.
- On the remote control, select the correct audio input.
- Make sure that the SoundBar is not muted.

No sound from the wireless subwoofer.

- Wirelessly connect the subwoofer to the SoundBar (see 'Pair up with the subwoofer' on page 6).

Distorted sound or echo.

- If you play audio from the TV through the SoundBar, make sure that the TV is muted.

Audio and video are not synchronized.

- Press **AUDIO SYNC +/-** to synchronize the audio with the video.

Error message is displayed on the display panel.

- When "ERROR" is displayed, it indicates that an input audio format is not supported.
- When "USB ERROR" is displayed, it indicates that the connected USB device is not supported.
- When "HDMI ARC" blinks, it indicates that the connected TV is not HDMI ARC compliant or an unsupported audio format is detected.

Bluetooth

A device cannot connect with the SoundBar.

- The device does not support the compatible profiles required for the SoundBar.
- You have not enabled the Bluetooth function of the device. See the user manual of the device on how to enable the function.
- The device is not correctly connected. Connect the device correctly.
- The SoundBar is already connected with another Bluetooth device. Disconnect the connected device, then try again.

Quality of audio play from a connected Bluetooth device is poor.

- The Bluetooth reception is poor. Move the device closer to the SoundBar; or remove any obstacle between the device and the SoundBar.

The connected Bluetooth device connects and disconnects constantly.

- The Bluetooth reception is poor. Move the device closer to the SoundBar; or remove any obstacle between the device and the SoundBar.
- Turn off Wi-Fi function on the Bluetooth device to avoid interference.

- For some Bluetooth, the Bluetooth connection can be deactivated automatically to save power. This does not indicate any malfunction of the SoundBar.

NFC

A device cannot connect with the SoundBar via NFC.

- Make sure that the device is supported by NFC.
- Make sure that NFC is enabled on the device (see the device's user manual for details).
- For pairing, tap the NFC device on the **NFC** tag of the SoundBar.



Manufactured under license from Dolby Laboratories. Dolby and the double-D symbol are trademarks of Dolby Laboratories.



Manufactured under license under U.S. Patent Nos: 5,956,674; 5,974,380; 6,487,535 & other U.S. and worldwide patents issued & pending. DTS, the Symbol, & DTS and the Symbol together are registered trademarks & DTS Digital Surround and the DTS logos are trademarks of DTS, Inc. Product includes software. © DTS, Inc. All Rights Reserved.



The terms HDMI and HDMI High-Definition Multimedia Interface, and the HDMI Logo are trademarks or registered trademarks of HDMI Licensing LLC in the United States and other countries.



The Bluetooth® word mark and logos are registered trademarks owned by Bluetooth SIG, Inc. and any use of such marks by WOOX Innovations is under license. Other trademarks and trade names are those of their respective owners.



The N Mark is a trademark or registered trademark of NFC Forum, Inc. in the United States and in other countries.



© 2013 CSR plc and its group companies. The aptX® mark and the aptX logo are trade marks of CSR plc or one of its group companies and may be registered in one or more jurisdictions.



Specifications are subject to change without notice

2014 © WOOX Innovations Limited. All rights reserved.

Philips and the Philips' Shield Emblem are registered trademarks of Koninklijke Philips N.V. and are used by WOOX Innovations Limited under license from Koninklijke Philips N.V.

HTL5140B_12_UM_V3.0

