



# PRECAUTIONS

Return your Product Registration Card or register online at [www.philips.com/welcome](http://www.philips.com/welcome) today to get the very most from your purchase.

Registering your model with PHILIPS makes you eligible for all of the valuable benefits listed below, so don't miss out. Complete and return your Product Registration Card at once, **or register online at [www.philips.com/welcome](http://www.philips.com/welcome)** to ensure:

## \*Proof of Purchase

Returning the enclosed card guarantees that your date of purchase will be on file, so no additional paperwork will be required from you to obtain warranty service.

## \*Product Safety Notification

By registering your product, you'll receive notification - directly from the manufacturer - in the rare case of a product recall or safety defect.

## \*Additional Benefits

Registering your product guarantees that you'll receive all of the privileges to which you're entitled, including special money-saving offers.

# PHILIPS

***Congratulations on your purchase, and welcome to the "family!"***

**Dear PHILIPS product owner:**

Thank you for your confidence in PHILIPS. You've selected one of the best-built, best-backed products available today. We'll do everything in our power to keep you happy with your purchase for many years to come.

As a member of the PHILIPS "family," you're entitled to protection by one of the most comprehensive warranties and outstanding service networks in the industry. What's more, your purchase guarantees you'll receive all the information and special offers for which you qualify, plus easy access to accessories from our convenient home shopping network.

Most importantly, you can count on our uncompromising commitment to your total satisfaction.

All of this is our way of saying welcome - and thanks for investing in a PHILIPS product.

**P.S. To get the most from your PHILIPS purchase, be sure to complete and return your Product Registration Card at once, or register online at: [www.philips.com/welcome](http://www.philips.com/welcome)**

Know these **safety symbols**



**CAUTION**

**RISK OF ELECTRIC SHOCK  
DO NOT OPEN**



**CAUTION:** TO REDUCE THE RISK OF ELECTRIC SHOCK, DO NOT REMOVE COVER (OR BACK). NO USER-SERVICEABLE PARTS INSIDE. REFER SERVICING TO QUALIFIED SERVICE PERSONNEL.



This "bolt of lightning" indicates uninsulated material within your unit may cause an electrical shock. For the safety of everyone in your household, please do not remove product covering.



The "exclamation point" calls attention to features for which you should read the enclosed literature closely to prevent operating and maintenance problems.

**WARNING:** To reduce the risk of fire or electric shock, this apparatus should not be exposed to rain or moisture, and objects filled with liquids, such as vases, should not be placed on this apparatus.

**CAUTION:** To prevent electric shock, match wide blade of plug to wide slot, fully insert.

**ATTENTION:** Pour éviter les chocs électriques, introduire la lame la plus large de la fiche dans la borne correspondante de la prise et pousser jusqu'au fond.

### For Customer Use

Enter below the Model and Serial numbers which are located on the rear of the cabinet. Retain this information for future reference.

Model No. \_\_\_\_\_  
Serial No. \_\_\_\_\_

**PHILIPS** Visit our World Wide Web Site at <http://www.philips.com/welcome>

## IMPORTANT SAFETY INSTRUCTIONS

### Read before operating equipment

1. Read these instructions.
2. Keep these instructions.
3. Heed all warnings.
4. Follow all instructions.
5. Do not use this apparatus near water.
6. Clean only with a dry cloth.
7. Do not block any of the ventilation openings. Install in accordance with the manufacturers instructions.
8. Do not install near any heat sources such as radiators, heat registers, stoves, or other apparatus (including amplifiers) that produce heat.
9. Do not defeat the safety purpose of the polarized or grounding type plug. A polarized plug has two blades with one wider than the other. A grounding type plug has two blades and third grounding prong. The wide blade or third prong are provided for your safety. When the provided plug does not fit into your outlet, consult an electrician for replacement of the obsolete outlet.
10. Protect the power cord from being walked on or pinched particularly at plugs, convenience receptacles, and the point where they exit from the apparatus.
11. Only use attachments/accessories specified by the manufacturer.
12.  Use only with a cart, stand, tripod, bracket, or table specified by the manufacturer, or sold with the apparatus. When a cart is used, use caution when moving the cart/apparatus combination to avoid injury from tip-over.
13. Unplug this apparatus during lightning storms or when unused for long periods of time.
14. Refer all servicing to qualified service personnel. Servicing is required when the apparatus has been damaged in any way, such as power-supply cord or plug is damaged, liquid has been spilled or objects have fallen into apparatus, the apparatus has been exposed to rain or moisture, does not operate normally, or has been dropped.
15. This product may contain lead and mercury. Disposal of these materials may be regulated due to environmental considerations. For disposal or recycling information, please contact your local authorities or the Electronic Industries Alliance: [www.eiae.org](http://www.eiae.org)
16. **Damage Requiring Service** - The appliance should be serviced by qualified service personnel when:
  - A. The power supply cord or the plug has been damaged; or
  - B. Objects have fallen, or liquid has been spilled into the appliance; or
  - C. The appliance has been exposed to rain; or
  - D. The appliance does not appear to operate normally or exhibits a marked change in performance; or
  - E. The appliance has been dropped, or the enclosure damaged.
17. **Tilt/Stability** - All televisions must comply with recommended international global safety standards for tilt and stability properties of its cabinet design.

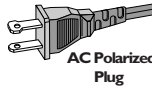

- Do not compromise these design standards by applying excessive pull force to the front, or top, of the cabinet which could ultimately overturn the product.
  - Also, do not endanger yourself, or children, by placing electronic equipment/toys on the top of the cabinet. Such items could unspectacularly fall from the top of the set and cause product damage and/or personal injury.
18. **Wall or Ceiling Mounting** - The appliance should be mounted to a wall or ceiling only as recommended by the manufacturer.
  19. **Power Lines** - An outdoor antenna should be located away from power lines.
  20. **Outdoor Antenna Grounding** - If an outside antenna is connected to the receiver, be sure the antenna system is grounded so as to provide some protection against voltage surges and built up static charges. Section 810 of the National Electric Code, ANSI/NFPA No. 70- 1984, provides information with respect to proper grounding of the mast and supporting structure, grounding of the lead-in wire to an antenna discharge unit, size of grounding connectors, location of antenna-discharge unit, connection to grounding electrodes, and requirements for the grounding electrode. See Figure below.
  21. **Object and Liquid Entry** - Care should be taken so that objects do not fall and liquids are not spilled into the enclosure through openings.
    - a) **Warning:** To reduce the risk of fire or electric shock, this apparatus should not be exposed to rain or moisture and objects filled with liquids, such as vases, should not be placed on this apparatus.
  22. **Battery Usage CAUTION** - To prevent battery leakage that may result in bodily injury, property damage, or damage to the unit:
    - Install all batteries correctly, with + and - aligned as marked on the unit.
    - Do not mix batteries (old and new or carbon and alkaline, etc.).
    - Remove batteries when the unit is not used for a long time.
  23. **Overloading** - Do not overload wall outlets, extension cords, or integral convenience receptacles as this can result in a risk of fire or electric shock.
  24. **Object and Liquid Entry** - Never push objects of any kind into this product through openings as they may touch dangerous voltage points or short-out parts that could result in a fire or electric shock. Never spill liquid of any kind on the product.
  25. **Replacement Parts** - When replacement parts are required, be sure the service technician has used replacement parts specified by the manufacturer or have the same characteristics as the original part. Unauthorized substitutions may result in fire, electric shock, or other hazards.
  26. **Safety Check** - Upon completion of any service or repairs to this product, ask the service technician to perform safety checks to determine that the product is in proper operating condition.

**Note to the CATV system installer:** This reminder is provided to call the CATV system installer's attention to Article 820-40 of the NEC that provides guidelines for proper grounding and, in particular, specifies that the cable ground shall be connected to the grounding system of the building, as close to the point of cable entry as practical.

### Example of Antenna Grounding as per NEC - National Electric Code

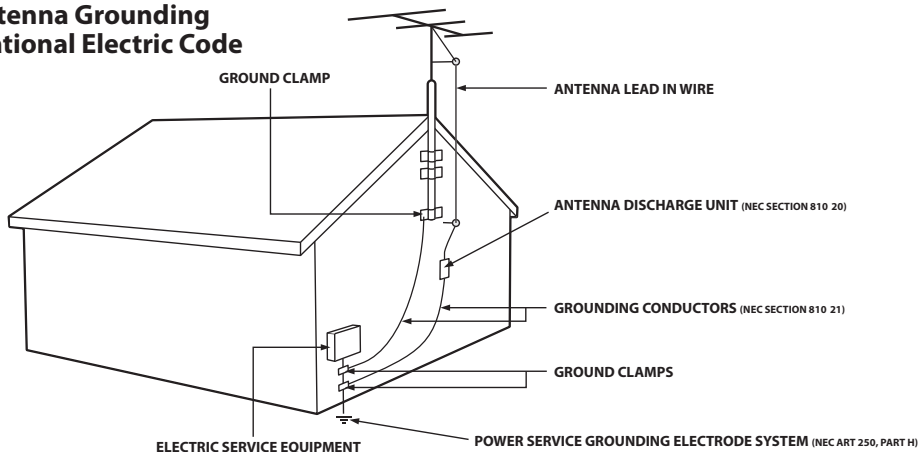

# PRECAUTIONS

## Welcome!

**Congratulations on your purchase, and welcome to Philips!**

**To fully benefit from the support that Philips offers, register your product at [www.philip.com/welcome](http://www.philip.com/welcome).**

This product lets you record on DVD and cassette tape and play back DVD/CD/cassette tape. Read this user manual carefully to learn how to use the features described in this manual.

## Safety Precautions

**Warning:** To prevent fire or shock hazard, do not expose this device to rain or moisture.

**Federal Communications Commission (FCC) Warning:** Any unauthorized changes or modifications to this device void the user's authority to operate it.

- Do not stand the unit up vertically. Install the unit in a horizontal and stable position.
- Be sure to remove the disc and unplug the AC power cord from the outlet before carrying the unit.

**Department of Health and Human Services (DHHS) Certification:** Complies with 21 Center for Radiation (CFR) chapter 1 subchapter J applicable at time of manufacture.

**Laser Safety:** This unit employs a laser. Only a qualified service person should remove the cover or attempt to service this device, due to possible eye injury.

CAUTION: USE OF CONTROLS OR ADJUSTMENTS OR PERFORMANCE OF PROCEDURES OTHER THAN THOSE SPECIFIED HEREIN MAY RESULT IN HAZARDOUS RADIATION EXPOSURE.

CAUTION: VISIBLE AND INVISIBLE LASER RADIATION WHEN OPEN AND INTERLOCK DEFEATED. DO NOT STARE INTO BEAM. THE BEAM IS LOCATED INSIDE, NEAR THE DECK MECHANISM.

**Special Information for Canadian Users:** This Class B digital apparatus complies with Canadian ICES-003. Cet appareil numérique de la classe B est conforme à la norme NMB-003 du Canada.

**Radio/TV Interference:** This device has been tested and found to comply with the limits for a Class B digital device, pursuant to Part 15 of the FCC Rules. These limits are designed to provide reasonable protection against harmful interference in a residential installation. This device generates, uses, and can radiate radio frequency energy and, if not installed and used in accordance with the instructions, may cause harmful interference to radio communications.

However, there is no guarantee that interference will not occur in a particular installation. If this device does cause harmful interference to radio or television reception, which can be determined by turning the device off and on, the user is encouraged to try to correct the interference by one or more of the following measures:

- 1) Reorient or relocate the receiving antenna.
- 2) Increase the separation between the device and the receiver.
- 3) Connect the device into an outlet on a circuit different from that to which the receiver is connected.
- 4) Consult the dealer or an experienced radio/TV technician for help.

**Copyright Notice:** The making of unauthorized copies of copy-protected material, including computer programs, files, broadcasts and sound recordings, may be an infringement of copyrights and constitute a criminal offence. This device should not be used for such purposes.

**Copyright Protection:** Unauthorized copying, broadcasting, public performance, and lending of Discs are prohibited.

This product incorporates copyright protection technology that is protected by U.S. patents and other intellectual property rights. Use of this copyright protection technology must be authorized by Macrovision, and is intended for home and other limited viewing uses only unless otherwise authorized by Macrovision. Reverse engineering or disassembly is prohibited.

**Notice for Progressive Scan Use:** Consumers should note that not all high definition television sets are fully compatible with this product and may cause artifacts to be displayed in the picture. In case of picture problems with 525 (480) progressive scan output, it is recommended that the user switch the connection to the 'standard definition' output. If there are questions regarding your TV set compatibility with this 525p (480p) DVD player, please contact our customer service center.

## Declaration of Conformity

Model Number: DVDR3545V

Trade Name: Philips

Responsible Party: P&F USA, Inc.

P.O. Box 672768 Marietta, Georgia 30006

1-866-771-4018

Copyright 2009 Philips. All rights reserved.

# PRECAUTIONS

## Supplied Accessories

remote control with batteries (AAx2)



user manual

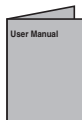

RF coaxial cable



quick start guide



RCA audio/video cables

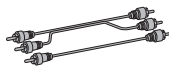

## Auto head cleaning

- Automatically cleans video heads as you insert or remove a cassette, so you can see a clear picture.
- Playback picture may become blurred or interrupted while the TV program reception is clear. Dirt accumulated on the video heads after a long period of use, or the usage of rental or worn tapes can cause this problem. If a streaky or snowy picture appears during playback, the video heads in your unit may need to be cleaned.

1. Please visit your local Audio/Video store and purchase a good quality VHS video head cleaner.
2. If a video head cleaner does not solve the problem, please consult your dealer or an Authorized Service Center.

### Note

- Remember to read the instructions along with the video head cleaner before use.
- Clean video heads only when problems occur.

## Maintenance

### Servicing

- Please refer to relevant topics on "TROUBLESHOOTING" on pages 107-111 before returning the product.
- If you need to call a customer service representative, please know the model number and serial number of your product before you call. This information is displayed on the back of the product. Also, please take a moment to identify the problem you are having, and be prepared to explain this to the representative. If you believe the representative will need to help you with operations, please stay near the product. Our representatives will be happy to assist you. For online reference, please visit our web site at <http://www.philips.com/welcome>

### Cleaning the cabinet

- Wipe the front panel and other exterior surfaces of the unit with a soft, slightly damp cloth.
- Never use a solvent, thinner, benzene or alcohol to clean the unit. Do not spray insecticide liquid near the unit. Such chemicals may discolor the surface or damage the unit.

### Cleaning discs

- When a disc becomes dirty, clean it with a cleaning cloth. Wipe the disc from the center to out. Do not wipe in a circular motion.
- Do not use solvents such as benzene, thinner, commercially available cleaners, detergent, abrasive cleaning agents or antistatic spray intended for analog records.

### Cleaning the disc lens

- If this unit still does not perform properly although you refer to the relevant sections and to "TROUBLESHOOTING" in this user manual, the laser optical pickup unit may be dirty. Consult your dealer or an Authorized Service Center for inspection and cleaning of the laser optical pickup unit.

### Disc handling

- Handle the discs so that fingerprints and dust do not adhere to the surfaces of the discs.
- Always store the disc in its protective case when it is not used.

## Installation Location

For safety and optimum performance of this unit:

- Install the unit in a horizontal and stable position. Do not place anything directly on top of the unit. Do not place the unit directly on top of the TV.
- Shield it from direct sunlight and keep it away from devices of intense heat. Avoid dusty or humid places. Avoid places with insufficient ventilation for proper heat dissipation. Do not block the ventilation holes on the sides of the unit. Avoid locations subject to strong vibration or strong magnetic fields.

## Moisture Condensation Warning

Moisture condensation may occur inside the unit when it is moved from a cold place to a warm place or after heating a cold room or under conditions of high humidity. Do not use this unit at least for 2 hours until its inside gets dry.



Manufactured under license from Dolby Laboratories. "Dolby" and the double-D symbol are trademarks of Dolby Laboratories.



HDMI, the HDMI logo and High-Definition Multimedia Interface are trademarks or registered trademarks of HDMI Licensing LLC.

## Dolby Digital Recording

"Dolby® Digital Recording enables consumers to record high-quality video with stereo sound on recordable DVD discs. The technology, when utilized instead of PCM recording, also saves recordable disc space, allowing for higher video resolution or extended recording time on each DVD. DVDs created using Dolby Digital Recording will play back on all DVD-video players."

**Note:** This is true when the players are compatible with actual recordable DVD discs.



# CONTENTS

## Introduction

<b>PRECAUTIONS</b> .....	<b>2</b>
<b>FEATURES</b> .....	<b>8</b>
Symbols Used in this User Manual .....	9
<b>FUNCTIONAL OVERVIEW</b> .....	<b>10</b>
Front Panel .....	10
Rear Panel .....	11
Remote Control .....	12
Front Panel Display .....	14

## Connections

<b>ANTENNA CABLE CONNECTION</b> .....	<b>15</b>
<b>RF MODULATOR CONNECTION</b> .....	<b>16</b>
<b>CONNECTION TO A CABLE / SATELLITE BOX</b> .....	<b>17</b>
<b>CONNECTION TO A TV</b> .....	<b>18</b>
<b>CONNECTION TO AN AUDIO SYSTEM</b> .....	<b>20</b>

## Basic Setup

<b>BEFORE YOU START</b> .....	<b>21</b>
Finding the Viewing Channel on Your TV .....	21
On-Screen Display / Menu .....	22
Main Menu .....	24
Switching VCR / DVD Mode .....	25
How to Insert a Disc / Cassette Tape .....	25
<b>INITIAL SETTING</b> .....	<b>26</b>
<b>CHANNEL SETTING</b> .....	<b>27</b>
Auto Channel Scan .....	27
Adding / Deleting Channels .....	28
<b>SETTING THE CLOCK</b> .....	<b>30</b>
Auto Clock Setting .....	30
Manual Clock Setting .....	31
Daylight Saving Time .....	31
<b>TUNER SETTINGS</b> .....	<b>32</b>
Switching Analog Mode / Digital Mode .....	32
Channel Selection .....	32
Selecting TV Audio .....	33
DTV Closed Caption .....	35
Closed Caption Style .....	36

## Recording

<b>INFORMATION ON DVD RECORDING</b> .....	<b>38</b>
<b>BEFORE RECORDING</b> .....	<b>39</b>
Make Recording Compatible .....	39
Setting for Auto Chapter .....	39
<b>BASIC RECORDING &amp; ONE-TOUCH TIMER RECORDING</b> .....	<b>40</b>
<b>TIMER RECORDING</b> .....	<b>42</b>
Hints for Timer Recording .....	45
<b>OVERWRITING UNNECESSARY TITLE</b> .....	<b>46</b>
Overwriting from the Beginning of the Title .....	46
Overwriting in the Middle of the Title .....	46
Hints for Overwriting .....	47
<b>SETTINGS FOR AN EXTERNAL DEVICE</b> .....	<b>48</b>
Connection to an External Device .....	48
Recording from an External Device .....	49
<b>DV DUBBING</b> .....	<b>50</b>
Guide to DV and On-Screen Display .....	50
DVC to DVD Dubbing .....	51
DVC to VCR Dubbing .....	52
<b>BI-DIRECTIONAL DUBBING</b> .....	<b>53</b>
<b>SETTING A DISC TO PROTECT</b> .....	<b>55</b>
<b>PLAYING THE DISCS ON OTHER DVD PLAYERS</b> .....	<b>56</b>
Finalizing a Disc .....	56
Auto Finalizing .....	57

## Playback

<b>INFORMATION ON PLAYBACK</b> .....	<b>58</b>
<b>BASIC PLAYBACK</b> .....	<b>60</b>
Direct Playback .....	60
Playback from the Title List .....	61
Playing Back an Audio CD and a CD-RW/-R with MP3/Windows Media™ Audio/JPEG Files .....	63
Playing Back a DivX® .....	64
Using the Title / Disc Menu .....	66
Pause .....	66
<b>SPECIAL PLAYBACK</b> .....	<b>67</b>
Resume Playback .....	67
Fast Forward / Fast Reverse Playback .....	67
Skipping TV Commercials During Playback .....	67
Rapid Playback .....	68
Step by Step Playback .....	68
Slow Forward / Slow Reverse Playback .....	68
Zoom .....	69
Marker Setting .....	69
Repeat Playback .....	70
Random Playback .....	70
Program Playback .....	71
Slide Show .....	71
<b>SEARCH</b> .....	<b>72</b>
Title / Chapter Search .....	72
Track Search .....	72
Time Search .....	73
<b>SELECTING THE FORMAT OF AUDIO AND VIDEO</b> ..	<b>74</b>
Switching Subtitles .....	74
Switching Audio Soundtrack .....	74
Switching Virtual Surround System .....	75
Switching Camera Angles .....	75
Reducing Block Noise .....	75

## Editing

<b>INFORMATION ON DISC EDITING</b> .....	<b>76</b>
Guide to a Title List .....	76
Editing Discs .....	76
<b>EDITING DISCS</b> .....	<b>77</b>
Deleting Titles .....	77
Putting Names on Titles .....	78
Setting Chapter Marks .....	79
Clearing Chapter Marks .....	80
Hiding Chapters .....	82
Setting Pictures for Thumbnails .....	83
Dividing a Title .....	84
Putting Name on Disc .....	85
Setting or Releasing Disc Protect .....	86
Erasing Disc .....	87
Making Edits Compatible .....	88

## Function Setup

<b>LIST OF SETTINGS</b> .....	<b>89</b>
<b>SETUPS</b> .....	<b>92</b>
Playback .....	92
Display .....	96
Video .....	98
DivX® .....	100
HDMI .....	101
Reset All .....	103

## VCR Functions

<b>VCR FUNCTIONS</b> .....	<b>104</b>
Playback .....	104
Recording .....	104
One-touch Timer Recording (OTR) .....	105
Index Search .....	105
Time Search .....	106
Other Operations .....	106

## Others

<b>TROUBLESHOOTING</b> .....	<b>107</b>
Frequently Asked Questions .....	111
<b>LANGUAGE CODE</b> .....	<b>112</b>
<b>GLOSSARY</b> .....	<b>113</b>
<b>SPECIFICATIONS</b> .....	<b>114</b>
<b>LIMITED WARRANTY</b> .....	<b>115</b>

# FEATURES

This unit not only plays back DVD, CD and VCR but also offers features for you to record on DVD and edit them after that. The following features are offered with this unit.

## Recording

This unit is compatible with DVD+RW/DVD-RW, which are rewritable repeatedly and DVD+R/DVD-R, which are available for recording once. Even if you choose DVD-RW/DVD-R, these discs will automatically be recorded in the DVD+VR mode. Also, this unit allows you to record to the cassette tape. You can choose either one for your convenience.

### DVD mode VCR mode

#### Up to 12 program recording:

You can program the unit to record up to 12 programs within a one-month period. Daily or weekly program recordings are also available.

#### One-touch timer recording (OTR):

You can easily set a recording time as you prefer. Every time [REC ●] is pressed during recording, the recording time will be increased by 30 minutes up to 6 hours for DVD, and 8 hours for VCR. The recording automatically stops when the recording time you set is reached or the disc is full.

#### Dubbing mode:

You can copy a DVD to a cassette tape or copy a cassette tape to a DVD. This function will be possible only if the DVD or a cassette tape is not copy protected.

You cannot record on a cassette tape when its erase-protection tab is removed.

#### DV dubbing:

This function helps you to easily dub the contents of the DVC (digital video camcorder) to DVD or cassette tape.

#### Left channel stereo recording:

This unit can record the sound of the left channel monaural input as left and right channels automatically (the input from the E1 and E2 only).

### DVD mode

#### Automatic chapter mark setting:

Chapter marks will be put on recordings as you set before attempting to record.

#### Automatic title list making:

The unit makes a title list with the index automatically.

## Playback

### DVD mode

#### Theater surround sound in your home:

When connecting the unit to an amplifier or a decoder which is compatible with Dolby Digital, you can experience the theater surround sound from discs with surround sound system.

#### Quick search for what you want to watch:

You can easily find the part you want to watch using the search function. Search for a desired point on a disc by title, chapter or time.

#### Virtual surround system:

You can enjoy stereophonic space through your existing 2 channel stereo system.

#### Playing back MP3/Windows Media™ Audio/JPEG/DivX® files:

You can enjoy MP3/Windows Media™ Audio/JPEG/DivX® files which are recorded on CD-RW/-R.

DivX® files can also be recorded on DVD+RW/+R or DVD-RW/-R.

### VCR mode

#### Quick search for what you want to watch:

You can easily find the part you want to watch using the index search/time search functions. An index mark will be assigned at the beginning of each recording you make.

For time search function, you can go to a specific point on a cassette tape by entering the exact amount of time you wish to skip.

## Editing

#### Deleting titles:

You can delete titles which you do not need anymore.

#### Putting names on titles:

You can put your favorite names on titles.

#### Setting / clearing chapter marks:

You can set / clear chapter marks on titles.

#### Hiding chapters:

To keep others from playing back some chapters without permission, you can hide chapters.

#### Setting pictures for thumbnails:

You can change pictures for thumbnails.

#### Dividing titles:

You can divide a title into 2 or more.

#### Putting name on disc:

You can put your favorite disc name.

## Compatibility

#### Available for playing back discs on a regular DVD player:

Recorded discs can be played back on regular DVD players, including computer DVD drives compatible with DVD-video playback. Although DVD+R are playable on other units without finalization in most cases, it is recommended to finalize in order to stabilize the performance. For DVD-RW/-R, you need to finalize the recorded discs to play on other DVD players.

## Others

### DVD mode

#### Progressive scan system

Unlike conventional interlace scanning, the progressive scan system provides less flickering and images in higher resolution than that of traditional television signals.

#### HDMI (High-Definition Multimedia Interface)













You can enjoy clearer audio/video output when connecting this unit to a display device with an HDMI-compatible port.



## Symbols Used in this User Manual

To specify for what disc type each function is, we put the following symbols at the beginning of each item to operate.

- \* DVD-RW/-R recorded in VR mode or non compatible recording format are not playable.
- \* DVD-RW recorded in the mode other than +VR is not recordable on this unit unless you erase all contents in the disc (refer to page 87).
- \* DVD-R recorded in the mode other than +VR is not recordable on this unit.

Symbol	Description
<b>For Recording, Playing Back, and Editing</b>	
	Description refers to DVD+RW
	Description refers to DVD+R
	Description refers to DVD-RW
	Description refers to DVD-R
<b>For Recording and Playing Back</b>	
	Description refers to VHS tapes Use only cassettes marked VHS (VHS)
<b>For Playback only</b>	
	Description refers to DVD+R DL
	Description refers to DVD-video
	Description refers to audio CD
	Description refers to CD-RW/-R with MP3 files
	Description refers to CD-RW/-R with Windows Media™ Audio files
	Description refers to CD-RW/-R with JPEG files
	Description refers to DVD+RW/+R, DVD-RW/-R and CD-RW/-R with DivX® files

If you do not find any of the symbols listed above under the function heading, the operation is applicable to all media.

# FUNCTIONAL OVERVIEW

## Front Panel

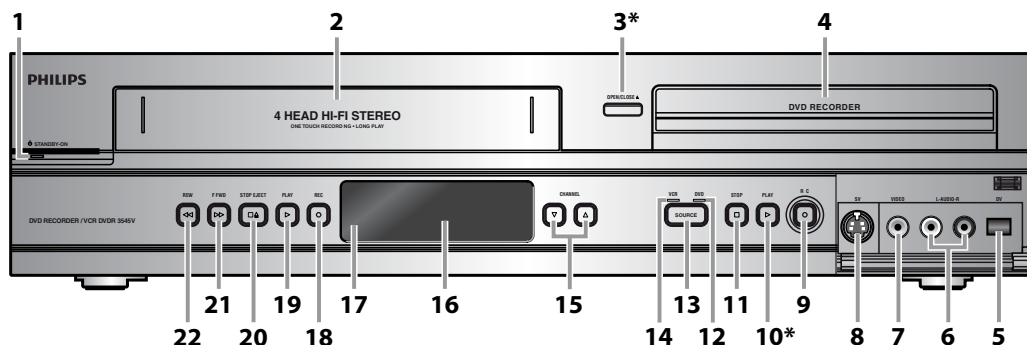

(\*) The unit can also be turned on by pressing these buttons or inserting a cassette tape.

- 1. STANDBY-ON button (DVD/VCR)**  
Press to turn on and off the unit.  
Red LED lights up when power is on.
- 2. Cassette compartment (VCR)**  
Insert a cassette tape here.
- 3. OPEN/CLOSE button (DVD)\***  
Press to open or close the disc tray.
- 4. Disc tray (DVD)**  
Place a disc when it is open.
- 5. DV input jack (E3) (DVD/VCR)**  
Use to connect the DV output of external device with a DV cable.
- 6. AUDIO input jacks (E2) (DVD/VCR)**  
Use to connect external device with an RCA audio cable.
- 7. VIDEO input jack (E2) (DVD/VCR)**  
Use to connect external device with an RCA video cable.
- 8. SV input jack (E2) (DVD/VCR)**  
Use to connect the S-video output of external device with an S-video cable.
- 9. DVD REC button (DVD)**  
Press once to start a recording.  
Press repeatedly to start the one-touch timer recording.
- 10. DVD PLAY button (DVD)\***  
Press to start or resume playback.
- 11. STOP button (DVD)**  
Press to stop playback or recording.  
Press to stop the proceeding timer recording in DVD.
- 12. DVD indicator**  
Lights up when the DVD output mode is selected.
- 13. SOURCE button (DVD/VCR)**  
Press to select the component you wish to operate.
- 14. VCR indicator**  
Lights up when the VCR output mode is selected.
- 15. CHANNEL / buttons (DVD/VCR)**  
Press to change the channel up and down.
- 16. Display**  
Refer to "Front Panel Display" on page 14.
- 17. Infrared sensor window (DVD/VCR)**  
Receive signals from your remote control so that you can control the unit from a distance.
- 18. VCR REC button (VCR)**  
Press once to start a recording. Press repeatedly to start the one-touch timer recording.
- 19. VCR PLAY button (VCR)**  
Press to start playback.
- 20. STOP/EJECT button (VCR)**  
Press to remove the cassette tape from the cassette compartment.  
Press to stop cassette tape playback or recording.  
Press to stop the proceeding timer recording in VCR.
- 21. F.FWD button (VCR)**  
Press to rapidly advance the cassette tape, or view the picture rapidly in forward during playback (forward search).
- 22. REW button (VCR)**  
Press to rewind the cassette tape, or to view the picture rapidly in reverse during playback (rewind search).

## Rear Panel

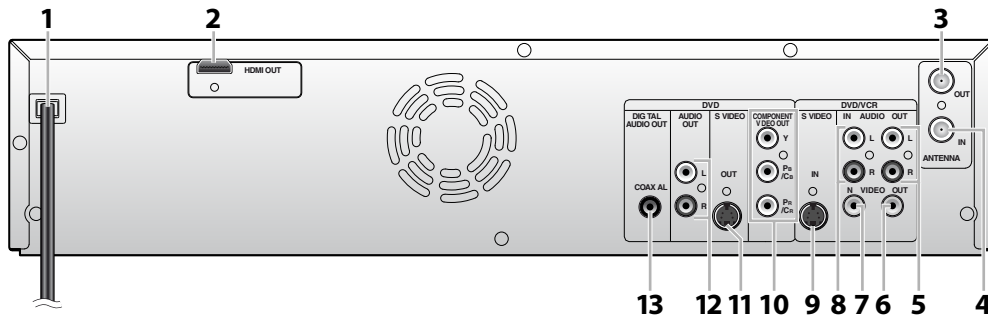

### 1. AC Power Cord (DVD/VCR)

Connect to a standard AC outlet to supply power to this unit.

### 2. HDMI OUT jack (DVD only)

Use an HDMI cable to connect to a display with an HDMI compatible port.

### 3. ANTENNA OUT jack (DVD/VCR)

Use to connect an RF coaxial cable to pass the signal from the ANTENNA IN to your TV monitor.

### 4. ANTENNA IN jack (DVD/VCR)

Use to connect an antenna.

### 5. AUDIO OUT jacks (DVD/VCR)

Use to connect a TV monitor, AV receiver or other device with an RCA audio cable.

### 6. VIDEO OUT jack (DVD/VCR)

Use to connect a TV monitor, AV receiver or other device with an RCA video cable.

### 7. VIDEO IN jack (E1) (DVD/VCR)

Use to connect external device with an RCA video cable.

### 8. AUDIO IN jacks (E1) (DVD/VCR)

Use to connect external device with an RCA audio cable.

### 9. S-VIDEO IN jack (E1) (DVD/VCR)

Use to connect the S-video output of external device with an S-video cable.

### 10. COMPONENT VIDEO OUT jacks (DVD only)

Use to connect a TV monitor with component video inputs with a component video cable.

### 11. S-VIDEO OUT jack (DVD only)

Use to connect the S-video input of a TV monitor, AV receiver or other device with an S-video cable.

### 12. AUDIO OUT jacks (DVD only)

Use to connect a TV monitor, AV receiver or other device with an RCA audio cable.

### 13. COAXIAL DIGITAL AUDIO OUT jack (DVD only)

Use to connect an AV receiver, Dolby Digital decoder or other device with a digital audio coaxial input jack with a digital audio coaxial cable.

### Note

- Do not touch the inner pins of the jacks on the rear panel. Electrostatic discharge may cause permanent damage to the unit.
- This unit does not have the RF modulator.

# FUNCTIONAL OVERVIEW

## Remote Control

### Installing the Batteries in the Remote Control

Install the batteries (AAAx2) matching the polarity indicated inside battery compartment of the remote control.

#### 1 Open the cover.

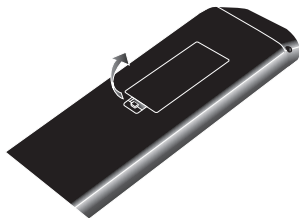

#### 2 Insert batteries.



Make sure to match + and - on the batteries to the marks indicated in the battery compartment.

#### 3 Close the cover.

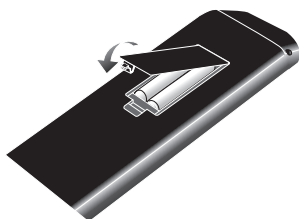

#### Note

Incorrect use of batteries can result in hazards such as leakage and bursting. Please observe the following:

- Do not mix new and old batteries together.
- Do not use different kinds of batteries together. Although they may look similar, different batteries may have different voltages.
- Make sure that the + and - ends of each battery match the indications in the battery compartment.
- Remove batteries from battery compartment that is not going to be used for a month or more.
- When disposing of used batteries, please comply with governmental regulations or environmental public instruction's rules that apply in your country or area.
- Do not recharge, short-circuit, heat, burn or disassemble batteries.

### Using a Remote Control

Keep in mind the following when using the remote control:

- Make sure that there are no obstacles between the remote control and the infrared sensor window on the unit.
- Remote operation may become unreliable if strong sunlight or fluorescent light is shining on the infrared sensor window of the unit.
- Remote control for different devices can interfere with each other. Avoid using remote control for other device located close to the unit.
- Replace the batteries when you notice a fall off in the operating range of the remote control.
- The maximum operable ranges from the unit are as follows.
  - **Line of sight:** approx. 23 feet (7m)
  - **Either side of the center:** approx. 16 feet (5m) within 30°
  - **Above:** approx. 16 feet (5m) within 15°
  - **Below:** approx. 10 feet (3m) within 30°

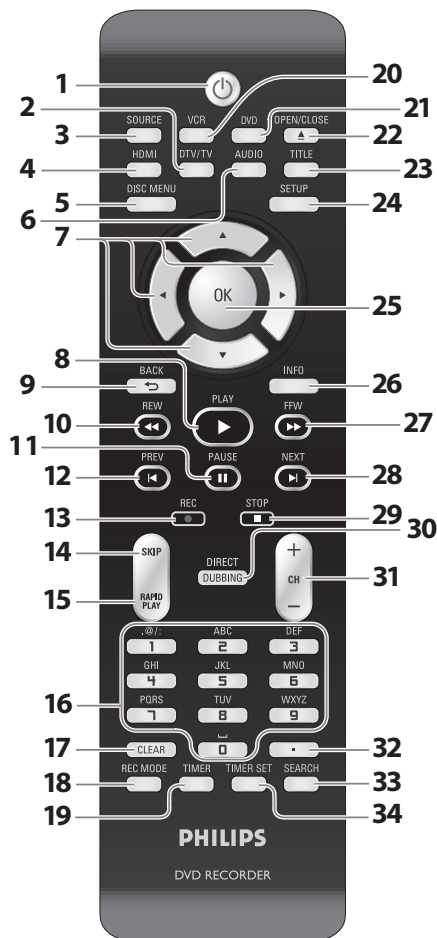
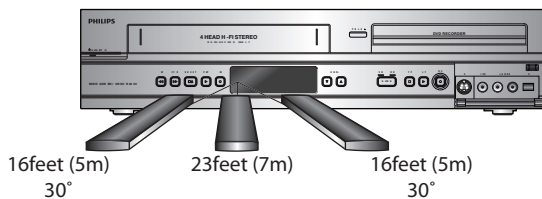

- 1. STANDBY-ON  button (DVD/VCR)**
  - Press to turn the unit on and off.
- 2. DTV/TV button (DVD/VCR)**
  - Press to switch between digital TV (DTV) mode and analog TV (TV) mode.
- 3. SOURCE button (DVD/VCR)**
  - Press to select the appropriate input.
- 4. HDMI button (DVD)**
  - Press to set the HDMI connector's video signal output mode.
- 5. DISC MENU button (DVD)**
  - Press to display the disc menu.
- 6. AUDIO button (DVD/VCR)**







**DTV mode:**

  - Press to switch the audio language for digital TV.

**DVD mode:**

  - Press to display the audio menu during playback.



**VCR mode:**

  - During playback of a Hi-Fi videotape, press to change the audio out setting.
- 7. Cursor  /  /  /  buttons (DVD/VCR)**
  - Press to select items or settings.
- 8. PLAY  button (DVD/VCR)**
  - Press to start playback or resume playback.
- 9. BACK  button (DVD/VCR)**
  - Press to return to the previously displayed menu screen.
- 10. REW  button (DVD/VCR)**

**DVD mode:**

  - During playback, press to fast reverse playback.
  - When playback is paused, press to slow reverse playback.

**VCR mode:**

  - During playback, press to rewind the cassette tape or to view the picture rapidly in reverse.
- 11. PAUSE  button (DVD/VCR)**
  - Press to pause playback or recording.
- 12. PREV  button (DVD)**
  - During playback, press to return to the beginning of the current chapter, track or file.
  - When playback is in pause, press repeatedly to reverse the playback step by step.
- 13. REC  button (DVD/VCR)**
  - Press once to start a recording.
  - Press repeatedly to start the one-touch timer recording.
- 14. SKIP button (DVD)**
  - During playback, press to skip 30 seconds.
- 15. RAPID PLAY button (DVD)**
  - During playback, press to play back in a slightly faster/slower mode with keeping the audio quality.
- 16. Number/Character buttons (DVD/VCR)**
  - Press to select channel numbers.
  - Press to select a title/chapter/track/file on display.
  - Press to enter values for the settings in the main menu.
  - Press to enter title names.
  - Press to start the index/time search in VCR mode.
- 17. CLEAR button (DVD/VCR)**

**DVD mode:**

  - Press to clear the password once entered or to cancel the programming for CD or to clear the selected marker number, etc.

**VCR mode:**

  - Press to reset the tape counter.
- 18. REC MODE button (DVD/VCR)**
  - Press to switch the recording mode.
- 19. TIMER button (DVD/VCR)**
  - Press to display the timer programming list.
- 20. VCR button**
  - Press to select the VCR output mode.
- 21. DVD button**
  - Press to select the DVD output mode.
- 22. OPEN/CLOSE  button (DVD/VCR)**

**DVD mode:**

  - Press to open or close the disc tray.



**VCR mode:**

  - Press to remove the cassette tape from the cassette compartment.
- 23. TITLE button (DVD)**
  - Press to display the title list.
- 24. SETUP button (DVD/VCR)**
  - Press to display the main menu.
  - During DVD playback, press and hold for more than 3 seconds to switch the progressive scanning mode to the interlace mode.
- 25. OK button (DVD/VCR)**
  - Press to confirm or select menu items.
- 26. INFO button (DVD/VCR)**
  - Press to display the display menu on or off.
- 27. FFW  button (DVD/VCR)**



**DVD mode:**

  - During playback, press to fast forward playback.
  - When playback is paused, press to slow forward playback.

**VCR mode:**

  - During playback, press to rapidly advance the cassette tape or view the picture rapidly in forward.
  - When playback is paused, press to view the cassette tape in slow motion.
- 28. NEXT  button (DVD)**
  - During playback, press to skip to the next chapter, track or file.
  - When playback is in pause, press repeatedly to forward the playback step by step.
- 29. STOP  button (DVD/VCR)**
  - Press to stop playback or recording.

**DVD mode:**

  - Press to exit from the title list.
- 30. DIRECT DUBBING button (DVD/VCR)**
  - Press to start VCR to DVD (DVD to VCR) duplication which you set in the main menu.
- 31. CH  /  buttons (DVD/VCR)**

**DVD mode:**

  - Press to change the channel up and down.

**VCR mode:**

  - Press to change the channel up and down.
  - Press to adjust the tracking during playback or in slow motion of the cassette tape.
  - While playback is in still mode, you can adjust the picture blurred vertically.
- 32. Confirm (  ) button (DVD/VCR)**





**Analog mode:**

  - Press to confirm the channel selection made by [the Number buttons].

**Digital mode:**

  - Press to confirm the major / minor channel selection made by [the Number buttons].
- 33. SEARCH button (VCR)**
  - Press to call up the index or time search menu.
- 34. TIMER SET button (DVD/VCR)**
  - Press to set the unit in the timer standby mode. In the timer standby mode, press to cancel the mode and to turn the unit on.

## Note

- If you turn off this unit, [OPEN/CLOSE ] on the remote control is not available. Be sure to use [OPEN/CLOSE ] or [STOP/EJECT  ] on the unit.

# FUNCTIONAL OVERVIEW

## Front Panel Display

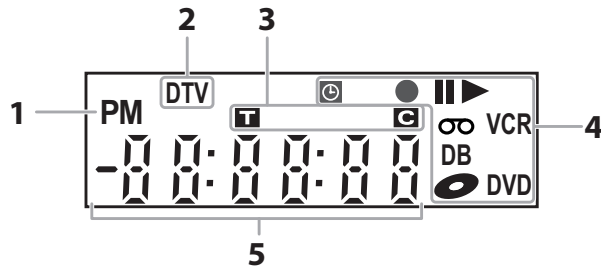

### 1.

**PM** : Appears in the afternoon with the clock display.

### 2.

**DTV** : Appears when the channel is in DTV mode.

### 3. Title / track / file and chapter mark

**T** : Appears when indicating a title / track / file number.

**C** : Appears when indicating a chapter number.

### 4. Current status of the unit

**||** : Appears when playback is in pause, or in step by step playback.

**▶** : Appears when playing back a disc, or a cassette tape.

**||▶** : Appears during slow forward / reverse playback.



: Appears when the timer programming or OTR has been set or is proceeding.

: Flashes when all timer recordings have been finished.  
: Flashes when there is an error in programming.



: Appears during recording process.  
: Flashes when a recording is in pause.



: Appears when this unit is in DVD output mode and a disc is in the unit.  
: Appears during duplication process.



: Appears when this unit is in VCR output mode and a cassette tape is in the unit.  
: Appears during duplication process.

**VCR**

: Appears when this unit is in VCR output mode.  
: Appears when the timer recording is proceeding in VCR.  
: Appears when VCR is in the timer recording standby mode.  
: Flashes when a program cannot be performed for some reasons.

**DVD** : Appears when this unit is in DVD output mode.

: Appears when the timer recording is proceeding in DVD.

: Appears when DVD is in the timer recording standby mode.

: Flashes when a program cannot be performed for some reasons.

**DB** : Appears during VCR to DVD duplication process.

: Appears during DVD to VCR duplication process.

### 5. Displays the following

- Elapsed playback time
- Current title / chapter / track / file number
- Recording time / remaining time
- Clock
- Selected channel number
- Remaining time for one-touch timer recording
- Selected HDMI OUTPUT mode
- VCR tape counter

## Display Message



Appears when the disc tray is opening.



Appears when the disc tray is closing.



Appears when a disc is loaded on the disc tray.



Appears when data is being written on a disc.



Appears when HDMI output mode (480p) is selected.



Appears when HDMI output mode (720p) is selected.



Appears when HDMI output mode (1080i) is selected.



Appears when HDMI output mode (1080p) is selected.



# ANTENNA CABLE CONNECTION

This section describes how to connect your unit to an antenna, cable box, etc.

- 1 **Disconnect the power cord of your TV from the AC outlet.**
- 2 **Disconnect RF coaxial cable from antenna input jack of your TV.**

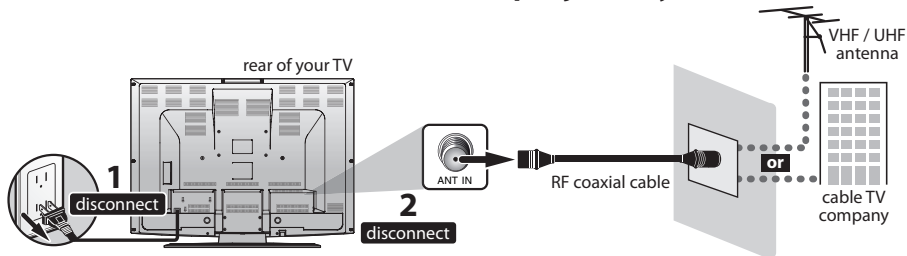

- 3 **Connect cables to the unit.**  
**Make the basic connection as illustrated below.**

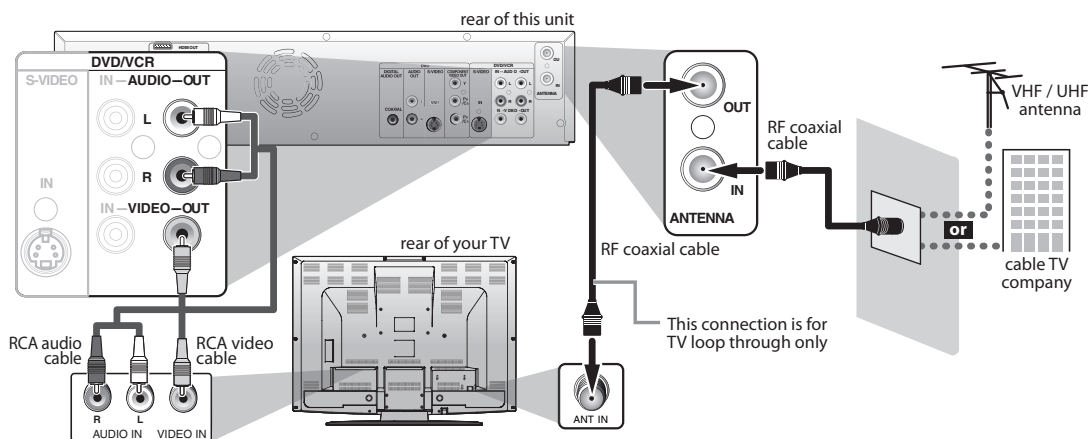

- 4 **Plug in the power cord of this unit and your TV to the AC outlet.**

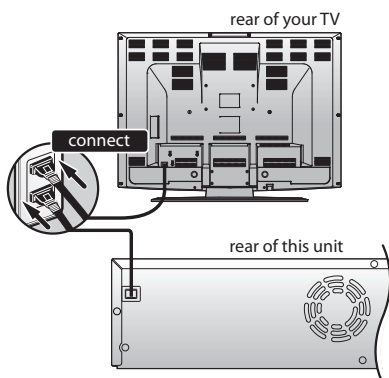

## Supplied cables used in this connection are as follows:

- RF coaxial cable x 1
  - RCA audio cable (L/R) x 1
  - RCA video cable x 1
- Please purchase the rest of the necessary cables at your local store.

\*Once connections are completed, turn on the TV and begin initial setting. Channel scanning is necessary for the unit to memorize all available channels in your area. (Refer to "INITIAL SETTING" on page 26.)

## Note

- For your safety and to avoid damage to the device, please unplug the RF coaxial cable from the ANTENNA IN jack before moving the unit.
- If you use an antenna to receive analog TV, it should also work for DTV reception. Outdoor or attic antennas will be more effective than set-top versions.
- Antenna out is for tuner pass through only. DVD playback through the RF is not possible.



# CONNECTION TO A CABLE / SATELLITE BOX

- 1) Disconnect the power cords of the devices from the AC outlet.
- 2) Make the connection as illustrated below.
- 3) Plug in the power cords of the devices to the AC outlet.

e.g.)

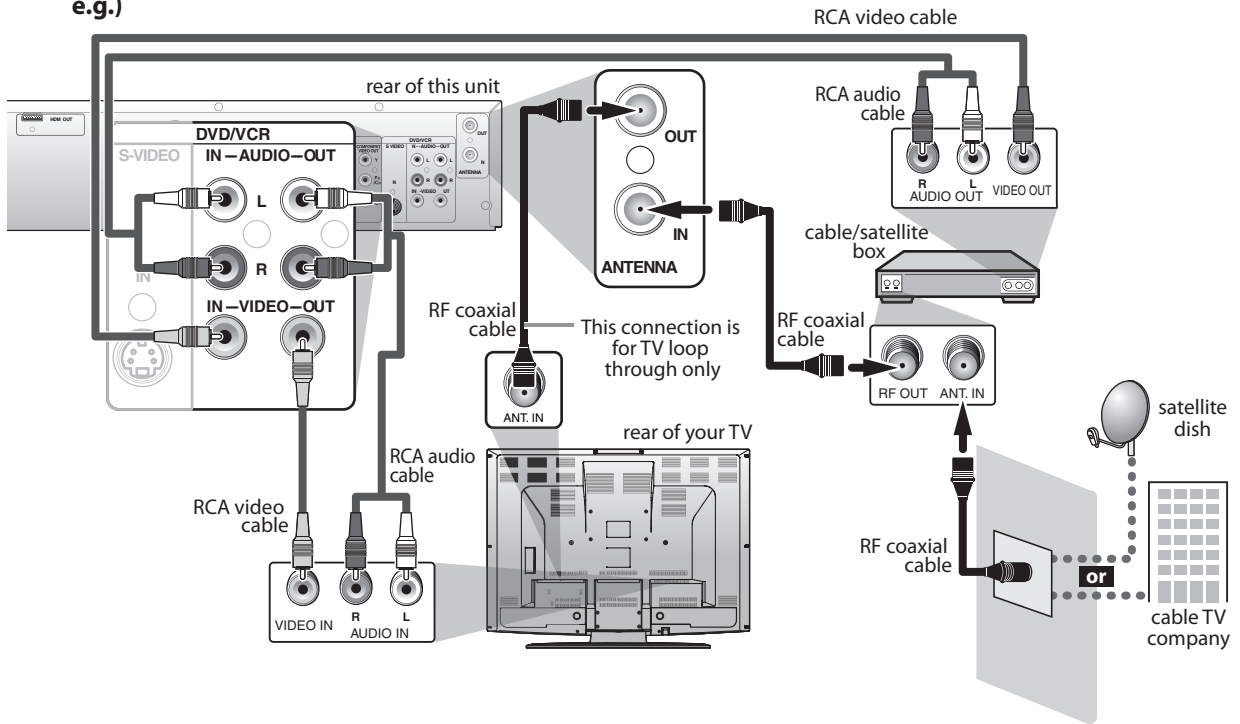

## Supplied cables used in this connection are as follows:

- RF coaxial cable x 1
- RCA audio cable (L/R) x 1
- RCA video cable x 1

Please purchase the rest of the necessary cables at your local store.

## Note

- Required cables and connecting methods differ depending on the cable/satellite box. For more information, please contact your cable/satellite provider.
- Instead of using video out jack of this unit, you can also use S-VIDEO OUT jack, COMPONENT VIDEO OUT jack, or HDMI OUT jack (DVD only)(no audio out jack connection required) for connecting to your TV.

## With this setup:

- You can record any unscrambled channel by selecting the channel on the cable/satellite box. Be sure that the cable/satellite box is turned on.
- **You cannot record one channel while watching another channel.**

# CONNECTION TO A TV

Make one of the following connections, depending on the capabilities of your existing device.

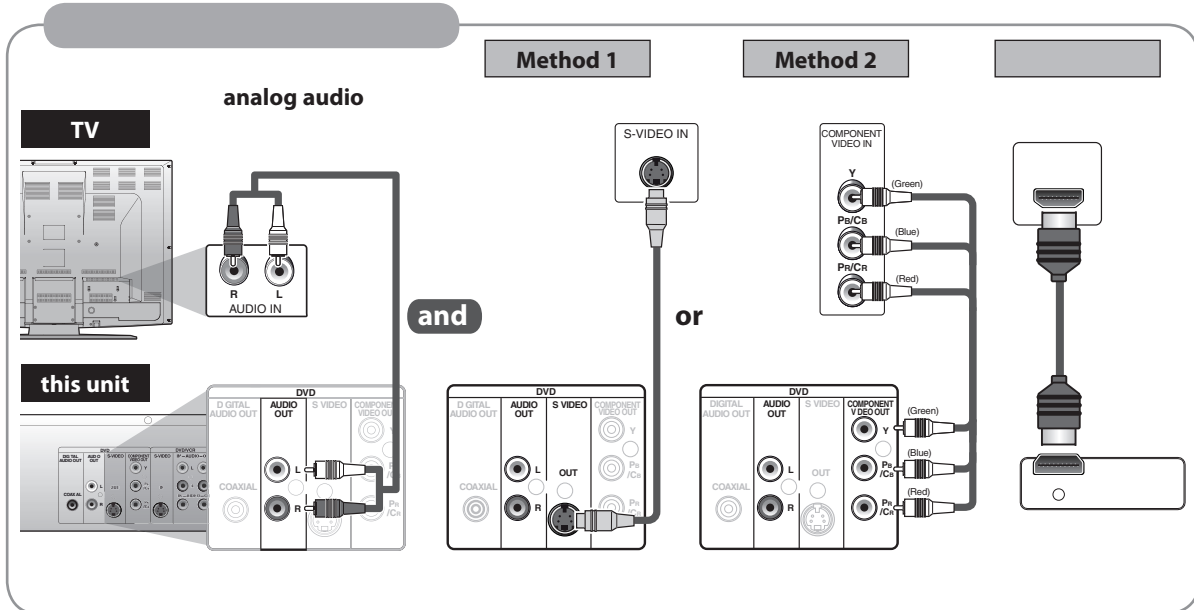
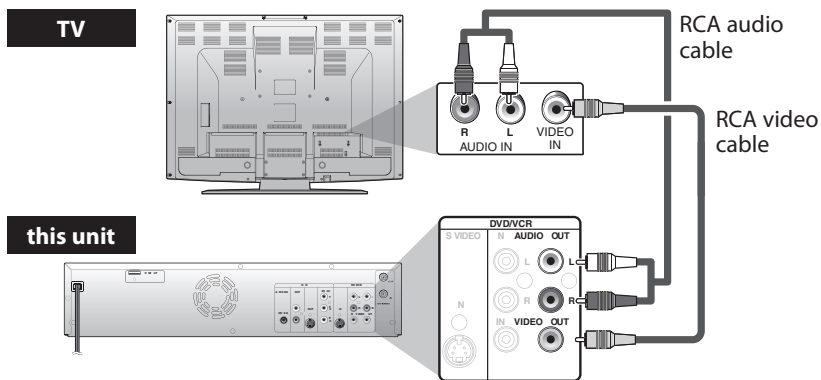

## Supplied cables used in this connection are as follows:

- RCA audio cable (L/R) x 1
  - RCA video cable x 1
- Please purchase the rest of the necessary cables at your local store.

## Note for HDMI connection

- A simple 1-cable connection with a device having an HDMI (high-definition multimedia interface) connector allows digital transfer of the digital images of DVD-video and other devices.
- When connecting with an HDMI cable, the audio signal will be output as the digital audio signal simultaneously, so you do not need the analog audio connection described above.

## Note

- Connect this unit directly to the TV. If the RCA audio/video cables are connected to a VCR, pictures may be distorted due to the copy protection system.
- You will not be able to hear the sound being output from DVD if you are not connecting DVD AUDIO OUT when you made either S-video or component video out connection.

## To set progressive scan mode, refer to page 99

- This unit is compatible with the progressive scan system. The feature provides you with the higher quality images than the traditional output system does. To utilize this feature, you must set "Progressive Scan" to "ON".

# CONNECTION TO A TV

## HDMI Mode and Actual Output Signals

Press [HDMI] to select the HDMI output mode. The output mode changes as follows every time [HDMI] is pressed.

Front Panel Display	Video Output Signal
400P	480 Progressive
Press [HDMI]	↓
720P	720 Progressive
Press [HDMI]	↓
1000i	1080 interlaced
Press [HDMI]	↓
1000P	1080 Progressive
Press [HDMI]	

- The HDMI mode that is not supported by display device will be skipped.

## Actual Output Modes by Media

Audio recording format of the disc		Dolby Digital setting of this unit	Actual output
DVD-video	Dolby Digital	PCM	2channel PCM
		Stream	Dolby Digital
	LPCM	PCM	2channel PCM
		Stream	
DivX®	Dolby Digital	PCM	2channel PCM
		Stream	Dolby Digital
	MP3 / MP2	PCM	2channel PCM
		Stream	

For audio CD, and MP3 / Windows Media™ Audio files, 2 channel PCM will be output regardless of the “Dolby Digital” setting.

- \*1 If the connected device is not compatible with HDMI BITSTREAM, audio will be output as PCM even if you select “Stream” in “Dolby Digital” setting.  
Refer to pages 101-102 for “HDMI” setting.

### Copyright protection system

To play back the digital video images of a DVD via an HDMI connection, it is necessary that both the player and the display device (or an AV amplifier) support a copyright protection system called HDCP (high-bandwidth digital content protection system). HDCP is copy protection technology that comprises data encryption and authentication of the connected AV device. This unit supports HDCP. Please read the operating instructions of your display device (or AV amplifier) for more information.

\*HDMI: High Definition Multimedia Interface

### Note

- When using HDCP-incompatible display device, the image will not be viewed properly.
- Among the devices that support HDMI, some devices can control other devices via the HDMI connector; however, this unit cannot be controlled by another device via the HDMI connector.
- The audio signals from the HDMI connector (including the sampling frequency, the number of channels and bit length) may be limited by the device that is connected.
- Among the monitors that support HDMI, some do not support audio output (for example, projectors). In connections with device such as this unit, audio signals are not output from the HDMI output connector.
- When this unit's HDMI connector is connected to a DVI-D compatible monitor (HDCP compatible) with an HDMI-DVI converter cable, the signals are output in digital RGB.

# CONNECTION TO AN AUDIO SYSTEM

- When you change the connections, all devices should be turned off.
- Refer to the manual accompanying external devices for more information.

## 2 Channel Analog Audio Connection

## Digital Audio Connection

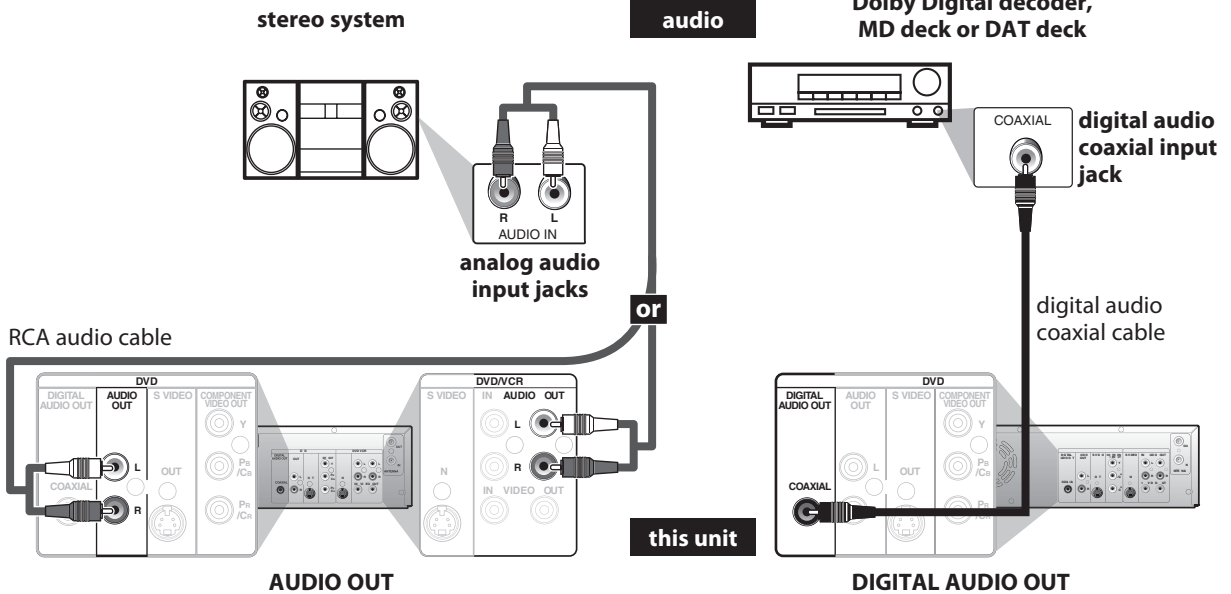

### Supplied cables used in this connection are as follows:

- RCA audio cable (L/R) x 1
- Please purchase the rest of the necessary cables at your local store.

Connection	Setting	Setup >General Setting >Playback >Disc Audio >Dolby Digital
If output is Dolby Digital encoded audio, connect to a Dolby Digital decoder.		Stream
Connecting to an MD deck or DAT deck.		PCM
If not connected to any external devices.		PCM

\* To complete these settings, refer to page 94.

### Note

- The audio source on a disc in a Dolby Digital multi channel surround format cannot be recorded as digital sound by an MD or DAT deck.
- By connecting this unit to a Dolby Digital decoder, you can enjoy high-quality Dolby Digital multi channel surround sound as heard in the movie theaters.
- Playing back a DVD using incorrect settings may generate noise distortion and may also damage the speakers.



# BEFORE YOU START

After you have completed all the connections, you must find the viewing channel (external input channel) on your TV.

## Finding the Viewing Channel on Your TV



**1** After you have made all the necessary connections, press [STANDBY-ON ] to turn on the unit.

**2** Turn on your TV.  
• If connected to your VCR make sure it is switched off or in standby mode before proceeding.

**3** Press “2” on the TV’s remote control, then press channel down button repeatedly until you see the “Initial Setup” menu.

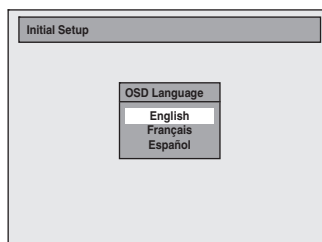

This is the correct viewing channel (external input channel) for the recorder.

- For some TVs, there may be a button on the TV’s remote control that accesses the external input channel. It may be labeled “SOURCE”, “AV”, or “SELECT”. In such case, press it repeatedly. Refer to your TV’s user manual for details.
- If more than 10 minutes have past since you have turned on the unit, you may see the PHILIPS screen saver instead of “Initial Setup” menu.

PHILIPS screen saver:



**4** Proceed to step 2 in “INITIAL SETTING” on page 26.

### Note

- Video input selection varies for different brand’s models of TVs.
- Consult your TV manufacturer if none of the above is successful.

# BEFORE YOU START

This unit uses the following on-screen displays and menus to guide you to the easy operations. The on-screen displays give you the information on the loaded disc, the disc/file in playback, or the HDMI status, etc. The menus allow you to change the various kinds of settings for playing back, recording, or editing to suite your preference.

## Guide to On-Screen Display / Menu

The on-screen display changes in the following order as you press [INFO].

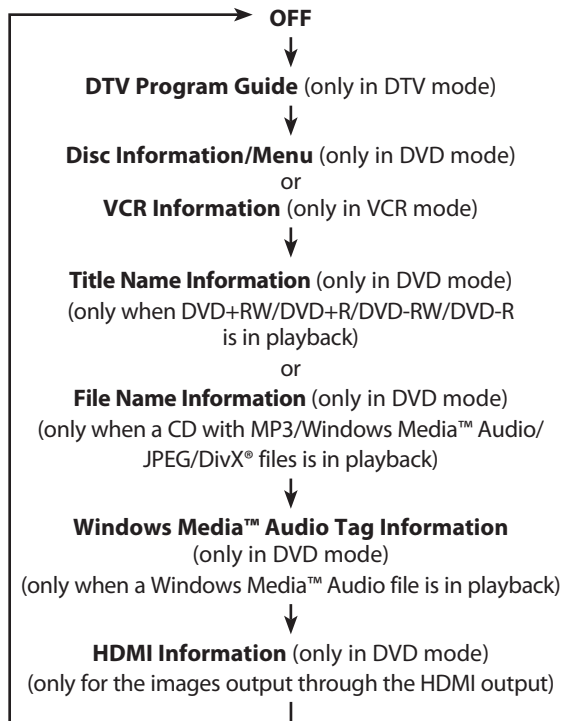

## DTV Program Guide

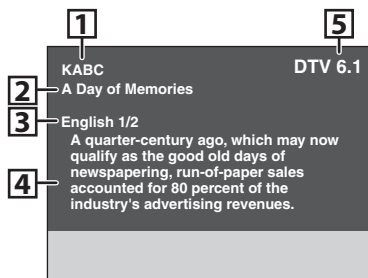

1. Broadcast station
2. Program title (max. 2 lines displayed)
3. Audio language ("Other" is displayed when the audio language cannot be acquired, or the acquired languages are other than English, Spanish or French.)
4. Program guide (max. 6 lines displayed)
5. Channel number

### Note

- When the program guide is displayed in more than 7 lines, use [▲ / ▼] to scroll.
- "No description provided" is displayed when the program guide is not provided.

## Disc Information / Menu

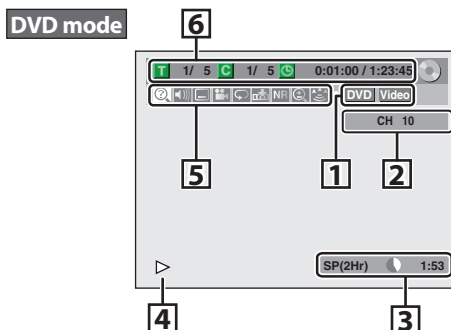

\* This is an example screen only for explanation. Displayed items vary depending on the disc you inserted.

1. Indicates a disc type and format mode.
2. Indicates a channel number or selected external input channel.
3. Indicates a recording mode and possible recording time left.

4. Indicates an operation status.

5. Each icon means:

- |            |                   |
|------------|-------------------|
| : Search   | : Marker          |
| : Audio    | : Noise Reduction |
| : Subtitle | : Zoom            |
| : Angle    | : Surround        |
| : Repeat   |                   |

6. Indicates the current title number/total number of titles, the current chapter number/total number of chapters, and time lapse of the current title playback/total duration of the title.

## VCR Information

### VCR mode

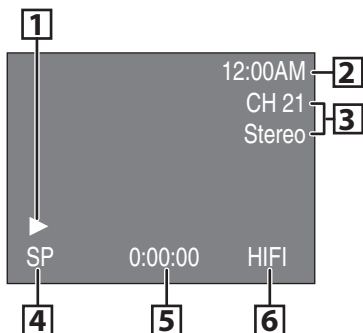

\* This is an example screen only for explanation. Displayed items vary depending on the cassette tape you inserted.

1. Indicates current video status.
2. Indicates the current time.
3. Indicates a current channel number (or selected external input channel) and an audio status of the program.
4. Indicates a recording or playing back mode.
5. Indicates a tape counter.
6. Audio status of the current cassette tape.

## HDMI Information

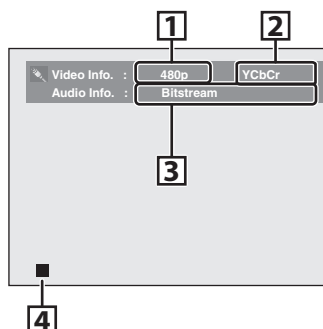

\* This is an example screen only for explanation.

1. Indicates the resolution of the HDMI output image.
2. Indicates the HDMI video format.
3. Indicates the HDMI audio format.
4. Indicates an operation status.

## Title/File Name Information

### Title Name Information

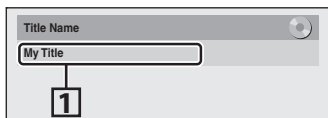

### File Name Information

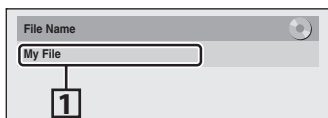

1. Displays title/file name.

## Windows Media™ Audio Tag Information

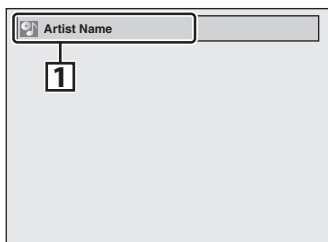

1. Indicates artist/title information (only when available)
  - First, artist name will be displayed.

↓

  - If you press [INFO] one more time, title name will be displayed.

# BEFORE YOU START

## Main Menu

Press [SETUP] to display the main menu. Then use [▲ / ▼] to select a menu and press [OK] to display the menu. These menus provide entries to all main functions of the unit.

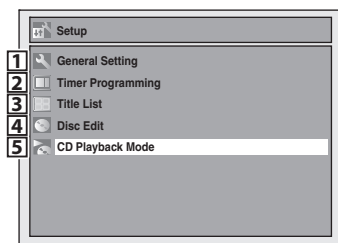

### 1. General Setting:

To go to general setting menu.

### 2. Timer Programming:

To program a timer recording.

### 3. Title List:

To call up the title list.

### 4. Disc Edit:

To set up the DVD setting.

### 5. CD Playback Mode:

To set up the CD playback setting.

- "CD Playback Mode" is available only when an audio CD, a CD-RW/-R with MP3 / Windows Media™ Audio / JPEG files is inserted into the unit.

## General Setting Menu

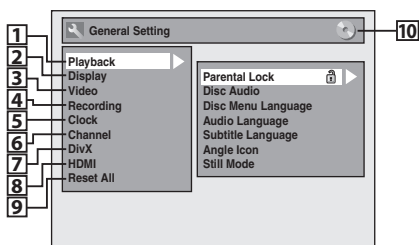

### 3. Video:

To set up the video setting.

### 4. Recording:

To set up the unit to record to discs as you prefer.

### 5. Clock:

To set up the clock of the unit as you need.

### 6. Channel:

To adjust the channel setting of the unit as you prefer.

### 7. DivX:

To set up the setting for the DivX® playback.

### 8. HDMI:

To set up the HDMI connection setting.

### 9. Reset All:

To reset the setting to the factory default.

### 10. DVD

VCR

Indicates the available mode for the selected function.

### 1. Playback:

To set up the unit to play back discs as you prefer.

### 2. Display:

To set up the OSD screen as you prefer.

## Disc Edit / CD Playback Mode

<Disc Edit menu (DVD+RW)>

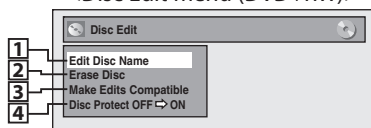

<Disc Edit menu (DVD-RW)>

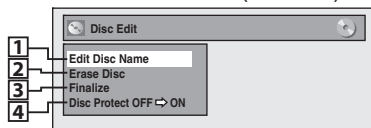

<Disc Edit menu (DVD+R/DVD-R)>

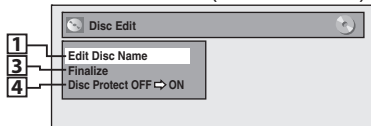

<CD Playback Mode menu>

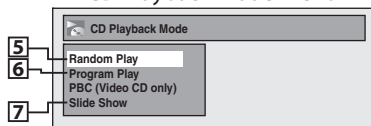

### 1. Edit Disc Name:

Allows you to rename the disc.

### 2. Erase Disc: (DVD+RW/DVD-RW only)

Allows you to erase all contents in the disc and format it.

### 3. Make Edits Compatible: (DVD+RW only)

Allows you to memorize the editing status on the disc if you have added or deleted chapters, or made chapters hidden on this unit, and to effect it when playing back on the other unit.

### Finalize: (DVD+R/DVD-RW/-R only)

Allows you to finalize a disc containing recorded titles.

### 4. Disc Protect :

Allows you to protect a disc from accidental editing or recording.

### 5. Random Play:

Allows you to activate the random playback feature.

### 6. Program Play: (audio CD only)

Allows you to activate the program playback feature.

### 7. Slide Show: (JPEG files only)

Allows you to select the display time of the slide show mode.

# BEFORE YOU START

## Switching DVD / VCR Mode

Because this product is a combination of a VCR and a DVD recorder, you must select first which component you wish to operate.

### DVD mode

Press **[SOURCE]** on the front panel, or press **[DVD]** on the remote control.

(Verify that the DVD indicator is lit.)

### VCR mode

Press **[SOURCE]** on the front panel, or press **[VCR]** on the remote control.

(Verify that the VCR indicator is lit.)

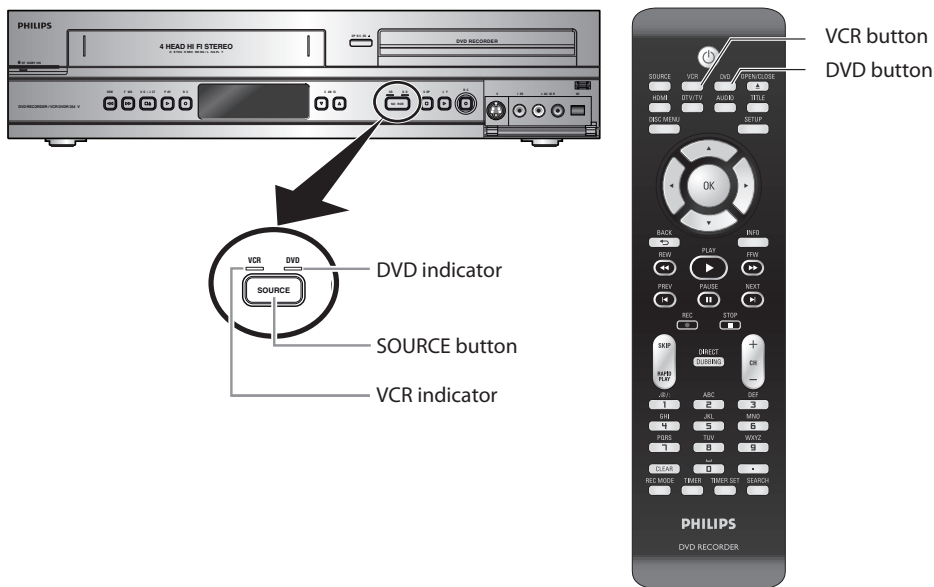

### Note

- You cannot switch the mode while in the timer-standby mode.

## How to Insert a Disc / Cassette Tape

### How to Insert a Disc

- 1) Press **[OPEN/CLOSE ▲]** to open the disc tray.
- 2) Place the disc on the disc tray with its label side facing up.



- 3) Press **[OPEN/CLOSE ▲]** to close the disc tray.

**It may take a while to load the disc.**

### To eject the disc:

Press **[OPEN/CLOSE ▲]** to open the disc tray, then remove the disc before turning off the unit.

### How to Insert a Cassette Tape

- 1) Insert a cassette tape as illustrated below.

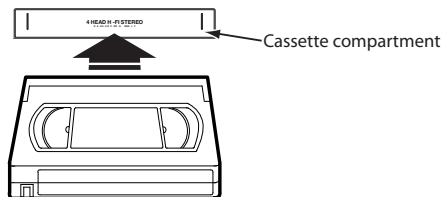

- Insert from the flap side first with the window side facing up.

### To eject the cassette tape:

Press **[STOP/EJECT ■ ▲]** on the front panel or press **[OPEN/CLOSE ▲]** on the remote control.

# INITIAL SETTING

You need to follow these steps when you turn on this unit for the first time.



**1** Follow the procedure in “Finding the Viewing Channel on Your TV” on page 21 to display the “Initial Setup” menu.

**2** Use [▲ / ▼] to select your desired language, then press [OK].

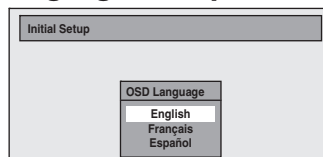

**3** Use [▲ / ▼] to select the type of broadcasting signal, then press [OK].

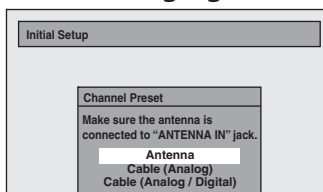

The unit will start getting channels available in your area.

#### **Antenna:**

(When using antenna)

The channels broadcasted in analog TV and digital TV are automatically scanned and memorized. Only the receivable channels in the area will be memorized.

#### **Cable (Analog):**

(When using basic cable)

The channels broadcasted in analog CATV are automatically scanned and memorized.

#### **Cable (Analog / Digital):**

(When using basic cable)

The channels broadcasted in analog CATV and digital CATV are automatically scanned and memorized.

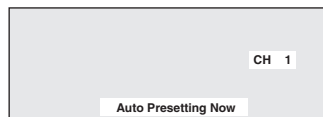

**4** Press [OK] to activate “Clock Setting”.

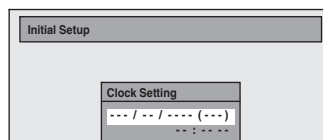

**5** Proceed to step 5 in “Manual Clock Setting” on page 31.

- If a PBS (public broadcasting station) is available in your area, follow “Auto Clock Setting” on page 30.



# CHANNEL SETTING

If you have changed antenna connection, we recommend that you program available channels in your area with the following procedures.

## Auto Channel Scan



**1** Press [SETUP] and use [▲ / ▼] to select “General Setting”, then press [OK].

“General Setting” menu will appear.

**2** Use [▲ / ▼] to select “Channel”, then press [OK].

“Channel” menu will appear.

**3** Use [▲ / ▼] to select “Auto Channel Preset”, then press [OK].

**4** Use [▲ / ▼] to select the type of broadcasting signal, then press [OK].

### Auto Channel Preset

Antenna  
Cable (Analog)  
Cable (Analog / Digital)

The unit will start getting channels available in your area.

- When aerial antenna is connected, select “Antenna”.
- When connected to CATV, select “Cable (Analog)” or “Cable (Analog/Digital)”.

**To cancel the auto channel preset during scanning:**

Press [BACK ↶] or [SETUP] to cancel.

**5** When scanning is over, press [SETUP] to exit.

To cycle through only the memorized channels, use [CH + / -].

To select a channel directly (including the ones not memorized), use [the Number buttons].

### Note

- If the auto channel preset is canceled during presetting, some channels not yet preset may not be received.
- You cannot change the channel when either VCR or DVD is in any recording mode (basic recording, one-touch timer recording or timer recording).

# CHANNEL SETTING

## Adding / Deleting Channels

You may want to add or delete TV channels if your channel lineup changes or if you no longer watch some channels.

**Adding channel is only available for the analog TV channels.**

### Make sure

- You perform "Auto Channel Scan" before adding or deleting the channels.



**1** Press [DTV/TV] to select the mode (DTV or TV) to/from which you want to add/delete channels.

**2** Press [SETUP] and use [▲ / ▼] to select "General Setting", then press [OK].

"General Setting" menu will appear.

**3** Use [▲ / ▼] to select "Channel", then press [OK].

"Channel" menu will appear.

**4** Use [▲ / ▼] to select "Manual Channel Preset", then press [OK].

Auto Channel Preset  
Manual Channel Preset  
TV Audio Select

- If you are adding or deleting analog TV/CATV channels, go to **ANALOG** to continue.
- If you are deleting digital TV/CATV channels, go to **DIGITAL** to continue.

## ANALOG

### 5 Select the channel number to add or delete.

- Use [CH + / -] to cycle through only the memorized channels.
- Use [◀ / ▶] to cycle through all the channels including the ones not memorized.
- Use [the Number buttons] to select a channel directly.
- When a memorized channel is selected, "Add" is checked and highlighted as a default.
- When an unmemorized channel is selected "Delete" is checked and highlighted as a default.

### 6 Use [▲ / ▼] to select "Add" or "Delete", then press [OK].



Your setting will be activated and it will automatically switch to the next channel so that you can continue adding or deleting channels.

### 7 Press [SETUP] to exit.

## DIGITAL

### 5 Select the channel number to delete.

- Only the major channel is displayed in "Manual Channel Preset" menu. (The channel number displayed in the parenthesis is a virtual channel number)
- Use [CH + / -] to cycle through only the memorized channels.
- You cannot use [◀ / ▶] for the digital TV channel selection.
- Use [the Number buttons] to select a channel directly.
- When a memorized channel is selected, "Add" is checked and highlighted as a default.
- When an unmemorized channel is selected "Delete" is checked and highlighted as a default.

### 6 Use [▲ / ▼] to select "Delete", then press [OK]. Then select the next channel to delete.

- If the setting is complete, press [BACK ↵] to activate "Manual Channel Preset".

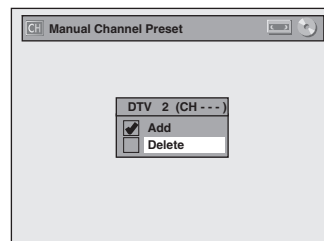

Your setting will be activated.

#### WARNING:

- For the digital TV channels, you cannot recover the deleted channels once they are deleted unless you perform the auto channel preset again.

### 7 Press [SETUP] to exit.

# SETTING THE CLOCK

Set the clock before you try the timer programming. If a PBS (public broadcasting station) is available in your area, follow "Auto Clock Setting" below. If not, follow "Manual Clock Setting" on page 31.

## Auto Clock Setting

This unit can set the time and date automatically by referring to a PBS station.

### Make sure

- The antenna/cable TV connections are correct.
- Channels are set. (Refer to page 27.)
- If this unit is connected to a cable/satellite box, select the local PBS station on them to set the clock automatically.



**1** Press [SETUP] and use [▲ / ▼] to select "General Setting", then press [OK].

"General Setting" menu will appear.

**2** Use [▲ / ▼] to select "Clock", then press [OK].

"Clock" menu will appear.

**3** Use [▲ / ▼] to select "Auto Clock Setting", then press [OK].

**4** Use [▲ / ▼] to select "Auto", then press [OK].

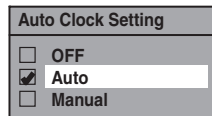

**5** Press [SETUP] to exit.

**6** Press [STANDBY-ON ⏻] to turn off the unit.

This unit will search for the time only when the power is off. Leave it off for several minutes to give this unit time to set the clock.

If the unit chooses an incorrect PBS channel, set the PBS channel manually by following the steps below.

**1** Select "Manual" at step 4, then press [OK].

**2** Use [the Number buttons] or [▲ / ▼] to enter your PBS channel number, then press [OK].

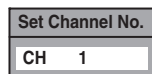

**3** Press [SETUP] and turn off the unit.

### Note

- The clock may set itself automatically after you connect the antenna/cable signal and plug in the power cord.
- Only the analog PBS channel signal is effective for auto clock setting.
- The unit receives the clock data at 12:00 a.m. / p.m. from the PBS channel when the power is off.

# SETTING THE CLOCK

## Manual Clock Setting

**1** Press [SETUP] and use [▲ / ▼] to select "General Setting", then press [OK].

"General Setting" menu will appear.

**2** Use [▲ / ▼] to select "Clock", then press [OK].

"Clock" menu will appear.

**3** Use [▲ / ▼] to select "Clock Setting", then press [OK].

**4** Use [▲ / ▼] to select calendar or time, then press [OK].

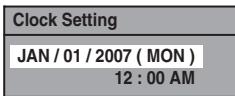

**5** Use [◀ / ▶] to select an item to set, and use [▲ / ▼] to select the contents to suit your preference, then press [OK] when you finish setting all the contents.

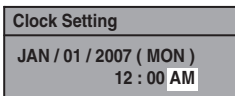

Your setting will be activated.

The clock start counting when you press [OK].

**6** Press [SETUP] to exit.

## Daylight Saving Time

When "Daylight Saving Time" is "ON", the unit clock will automatically adjust the time in order to fit the daylight saving time.

"ON (MAR - NOV)" has been selected as the default.

**1** Press [SETUP] and use [▲ / ▼] to select "General Setting", then press [OK].

"General Setting" menu will appear.

**2** Use [▲ / ▼] to select "Clock", then press [OK].

"Clock" menu will appear.

**3** Use [▲ / ▼] to select "Daylight Saving Time", then press [OK].

**4** Use [▲ / ▼] to select "ON (MAR - NOV)", "ON (APR - OCT)" or "OFF", then press [OK].

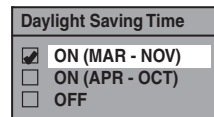

**ON (MAR - NOV):**

Move forward one hour on the second Sunday in March and move back one hour on the first Sunday in November.

**ON (APR - OCT):**

Move forward one hour on the first Sunday in April and move back one hour on the last Sunday in October.

**5** Press [SETUP] to exit.

### Note

- Your setting will be canceled if you press [BACK ↵] before pressing [OK] at step 5.
- Your clock setting will be lost if either there is a power failure or this unit has been unplugged for more than 30 seconds when you set the clock manually.
- For setting the day, year, hour, and minute, [the Number buttons] can also be used.
- You can set the built-in calendar from the year 2007 up to 2056.

# TUNER SETTINGS

## Switching Analog Mode / Digital Mode

You can easily switch the analog TV (NTSC) and digital TV (ATSC) with the remote control.

Press **[DTV/TV]** on the remote control.

- The analog mode and digital mode switch alternately.

### Note

- When you switch the analog mode to the digital mode, it may take about 10 seconds until the digital channel selection is completed. The following screen is displayed while switching the mode.



## Channel Selection

Select channels by using **[CH + / -]** or **[the Number buttons]** found on remote control.

**[CH + / -]**

Use **[CH + / -]** to change the channel.

**[the Number buttons]**

Press the channel number with **[the Number buttons]** to select a channel you want to watch.

**<Analog TV Channels>**

Enter the channel number with **[the Number buttons]** to select a channel you want to watch.

**For 1-digit number**

e.g.) 2 ch: **[0] + [2], [2] + [•]** or **[2] + leave it for 2 seconds.**

**For 2-digit number**

e.g.) 12ch: **[1] + [2]**

**<Digital TV Channels>**

Enter the major and minor channel number with **[the Number buttons]** to select a channel you want to watch.

**For 1-digit number**

e.g.) 2-2 ch:

major channel **[0] + [2]** or **[2] + [•]**

minor channel **[0] + [2], [2] + [•]** or

**[2] + leave it for 2 seconds.**

**For 2-digit number**

e.g.) 35-16ch:

major channel **[3] + [5]**

minor channel **[1] + [6]**

- If you enter 1 digit for major channel and leave it for 2 seconds, the number will be taken as the major channel and lowest minor channel of the major channel will be displayed.

- If there is no minor channel input, lowest minor channel of the major channel will be displayed.

### Note

- It may take up to 5 to 7 seconds to switch the digital TV channels.
- In digital TV broadcasting, 2 or more channels, called minor channels, are simultaneously broadcast on one main channel, called major channel.

**About digital TV broadcasting:**

With its high definition broadcast, digital broadcasting far surpasses analog broadcasting in both its picture and sound quality.

**What is the minor channel?**

By using high compression technology, digital broadcasting offers a service that enables multiple signals to send simultaneously.

Therefore, you can select more than one program per major channel since digital broadcasting technology distinguishes between multiple channels broadcast by a signal network.

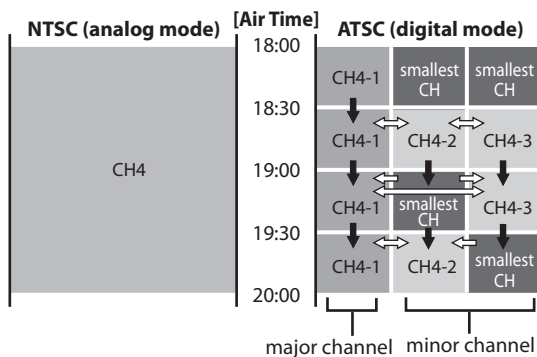

➡ : change automatically

⇔ : change manually by using **[CH + / -]**

# TUNER SETTINGS

This section describes how to switch the TV audio. When you record a TV program, only the audio selected here will be recorded.

## Selecting TV Audio

### Digital TV



# 1

Press **[AUDIO]** to cycle through available audio languages.

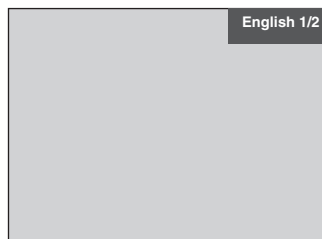

- When you press **[AUDIO]**, selected language will be displayed on the TV screen.
- Every time you press **[AUDIO]**, the language will be switched.  
e.g.) English 1/3 → Spanish 2/3 → Other 3/3
- Available languages differ depending on the broadcast.
- The language information display will automatically disappear.
- When you record digital TV broadcasting, the audio language you have selected will be recorded.

### Note

- You cannot change the audio language for the timer recording of digital TV broadcasting.
- Pressing **[AUDIO]** does not control external device audio.
- When there is only one audio channel on the broadcast, pressing **[AUDIO]** does not display anything.



# TUNER SETTINGS

## Selecting TV Audio (cont'd)

### Analog TV



**1** Press [SETUP] and use [▲ / ▼] to select “General Setting”, then press [OK].

“General Setting” menu will appear.

**2** Use [▲ / ▼] to select “Channel”, then press [OK].

“Channel” menu will appear.

**3** Use [▲ / ▼] to select “TV Audio Select”, then press [OK].

**4** Use [▲ / ▼] to select “Stereo” or “SAP”, then press [OK].

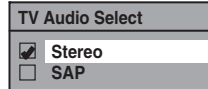

**Stereo:**

Outputs main-audio.

**SAP (secondary audio program):**

Outputs sub-audio.

**5** Press [SETUP] to exit.

**Note on recording analog TV audio**

- When you record an analog TV program available in second audio or stereo, you have to select either “Stereo” or “SAP” in “General Setting” menu beforehand. Refer to the following table to check an appropriate setting.

Selected audio	Broadcast audio	Disc recording	Audio output
Stereo	STEREO+SAP	STEREO	STEREO
	STEREO	STEREO	STEREO
	MONO+SAP	MONO	MONO
	MONO	MONO	MONO
SAP	STEREO+SAP	SAP	SAP
	STEREO	STEREO	STEREO
	MONO+SAP	SAP	SAP
	MONO	MONO	MONO

# TUNER SETTINGS

## DTV Closed Caption

### Digital TV

Digital TV has its own closed captions called DTV CC. Use this menu to change the settings for DTV CC.



**1** Press [SETUP] and use [▲ / ▼] to select “General Setting”, then press [OK].

“General Setting” menu will appear.

**2** Use [▲ / ▼] to select “Display”, then press [OK].

**3** Use [▲ / ▼] to select “CC Style”, then press [OK].

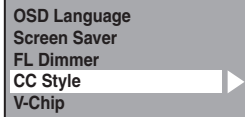

**4** Use [▲ / ▼] to select “DTV CC”, then press [OK].

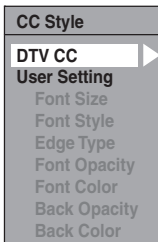

**5** Use [▲ / ▼] to the desired DTV closed caption, then press [OK].

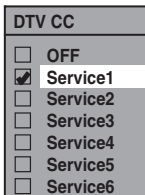

#### OFF:

Select if you do not want DTV CC. This is the default.

#### Service 1 to Service 6:

Select one of these before changing any other item in the closed caption menu. Choose “Service 1” under normal circumstances.

**6** Press [SETUP] to exit.

#### Note

- Even if you set “DTV CC” to anything other than “OFF”, its effect will temporarily be canceled while recording.

# TUNER SETTINGS

## Closed Caption Style

### Digital TV

Digital TV can also change the style of its closed caption such as font, color or size, etc.



- 1** Press [SETUP] and use [▲ / ▼] to select "General Setting", then press [OK].  
"General Setting" menu will appear.

- 2** Use [▲ / ▼] to select "Display", then press [OK].

- 3** Use [▲ / ▼] to select "CC Style", then press [OK].

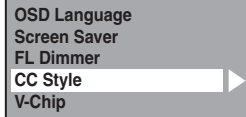

- 4** Use [▲ / ▼] to select "User Setting", then press [OK].

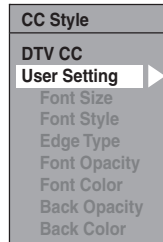

- 5** Use [▲ / ▼] to select "ON", then press [OK].

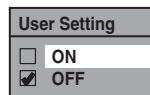

## 6 Use [▲ / ▼] to select the item and switch the setting for each item you want to set, then press [OK].

- When "User Setting" is set to "ON", you can set the following items. CC style set by "User Setting" will be displayed.
- The setting description for each item is shown below.

### <Font Size>

Font size of the displayed caption can be switched as below.

Font Size	
<input checked="" type="checkbox"/>	Middle
<input type="checkbox"/>	Large
<input type="checkbox"/>	Small

### <Font Style>

Font style of the displayed caption can be switched as below.

Font Style	
<input checked="" type="checkbox"/>	Style1
<input type="checkbox"/>	Style2
<input type="checkbox"/>	Style3
<input type="checkbox"/>	Style4
<input type="checkbox"/>	Style5
<input type="checkbox"/>	Style6
<input type="checkbox"/>	Style7
<input type="checkbox"/>	Style8

### <Edge Type>

Edge type of the displayed caption can be switched as below.

Edge Type	
<input checked="" type="checkbox"/>	None
<input type="checkbox"/>	Raised
<input type="checkbox"/>	Depressed
<input type="checkbox"/>	Uniform
<input type="checkbox"/>	L.Shadow
<input type="checkbox"/>	R.Shadow

### <Font Opacity>

Font opacity of the displayed caption can be switched as below.

Font Opacity	
<input checked="" type="checkbox"/>	Solid
<input type="checkbox"/>	Translucent
<input type="checkbox"/>	Flash

### <Font Color>

Font color of the displayed caption can be switched as below.

Font Color	
<input type="checkbox"/>	Transparent
<input checked="" type="checkbox"/>	White
<input type="checkbox"/>	Black
<input type="checkbox"/>	Red
<input type="checkbox"/>	Green
<input type="checkbox"/>	Blue
<input type="checkbox"/>	Yellow
<input type="checkbox"/>	Magenta
<input type="checkbox"/>	Cyan

### <Back Opacity>

Background opacity of the displayed caption can be switched as below.

Back Opacity	
<input checked="" type="checkbox"/>	Solid
<input type="checkbox"/>	Translucent
<input type="checkbox"/>	Flash

### <Back Color>

Background color of the displayed caption can be switched as below.

Back Color	
<input type="checkbox"/>	Transparent
<input type="checkbox"/>	White
<input checked="" type="checkbox"/>	Black
<input type="checkbox"/>	Red
<input type="checkbox"/>	Green
<input type="checkbox"/>	Blue
<input type="checkbox"/>	Yellow
<input type="checkbox"/>	Magenta
<input type="checkbox"/>	Cyan







## 7 Press [SETUP] to exit.

# INFORMATION ON DVD RECORDING

Before you make a recording, read the following information.

## Recordable Discs

This unit can record to DVD+RW, DVD+R, DVD-RW and DVD-R.  
 DVD+R/DVD-R can only be recorded to once. DVD+RW/DVD-RW can be recorded to and erased many times.  
**DVD-RW/-R will be recorded in the DVD+VR mode automatically in this unit.**

Logo	Attributes
 DVD+ReWritable	8cm/12cm, single-sided, single layer disc Approx. max. recording time (SLP mode): 360 minutes (4.7GB) (for 12cm) 108 minutes (1.4GB) (for 8cm)
 DVD+R	
 DVD-RW	
 DVD-R	
 DVD-RW	
 DVD-R	

- Following discs are recommended for good recording quality and are proven to be compatible with this unit. However, depending on the media condition the unit may not read the disc properly.

Verbatim	DVD+R 8x,	DVD+RW 4x,
	DVD-R 8x,	DVD-RW 2x
JVC	DVD-RW 4x	
Maxell	DVD+R 4x/8x/16x,	DVD-R 8x/16x
SONY	DVD+R 4x/8x/16x,	DVD+RW 4x
TDK	DVD+R 4x/8x/16x	

Performance of any other discs are not guaranteed.

- **You can play back DVD+RW on most DVD players without finalizing. However, if you have added or deleted chapters, or made chapters hidden, you must perform "Make Edits Compatible" before being able to see those effects on other units. (Refer to page 88 for more details.) To play back discs other than DVD+RW on other DVD players, you will need to finalize.**

## Unrecordable Discs

- DVD-RW recorded in the mode other than +VR is not recordable on this unit unless you erase all contents in the disc (refer to page 87).
- DVD-R recorded in the mode other than +VR is not recordable on this unit.

## Recording Mode

You can select a recording mode among 6 options, and the recording time will depend on the recording mode you select as follows.

Disc size	Recording mode	Recording time	Video/sound quality
8cm Disc	HQ (1Hr)	18 min	☆☆☆☆☆☆ (good)
	SP (2Hr)	36 min	☆☆☆☆☆
	SPP (2.5Hr)	45 min	☆☆☆☆
	LP (3Hr)	54 min	☆☆☆
	EP (4Hr)	72 min	☆☆
	SLP (6Hr)	108 min	☆ (poor)
12cm Disc	HQ (1Hr)	60 min	☆☆☆☆☆☆ (good)
	SP (2Hr)	120 min	☆☆☆☆☆
	SPP (2.5Hr)	150 min	☆☆☆☆
	LP (3Hr)	180 min	☆☆☆
	EP (4Hr)	240 min	☆☆
	SLP (6Hr)	360 min	☆ (poor)

- The recording time is only an estimate. The actual recording time may differ.
- The audio and video quality gets poorer as the recording time becomes longer.
- Each time [REC MODE] is pressed, recording mode and its allowed recording time will be displayed.

## Note

- **This unit cannot record to CD-RW or CD-R.**
- All high definition pictures will be down converted to the standard definition pictures when they are recorded on this unit.
- DVD+RW/+R, DVD-RW/-R and CD-RW/-R recorded on a personal computer or a DVD or CD recorder may not be played back if the disc is damaged or dirty or if there is condensation on the player's lens.
- If you record a disc using a personal computer, even if it is recorded in a compatible format it may not be played back because of the settings of the application software used to create the disc. (Check with the software publisher for more detailed information.)
- Since the recording is made by the VBR (variable bit rate) method, depending on the picture you are recording, the actual remaining time for recording may be a little shorter than the remaining time displayed on the TV screen.
- You cannot record copy-protected program using this unit. (Copy-protected signal is included in DVD-video or some satellite broadcasts.)
- You cannot record "copy-once only" program on DVD.

# BEFORE RECORDING

## Make Recording Compatible



Use this feature to make the unfinalized +VR mode discs recorded on other unit recordable on this unit. When you make an additional recording on this unit with "Make Recording Compatible" set to "ON", the title list is automatically converted to our style.

- 1) Press [SETUP] and use [▲ / ▼] to select "General Setting", then press [OK].  
"General Setting" menu will appear.
- 2) Use [▲ / ▼] to select "Recording", then press [OK].  
"Recording" menu will appear.
- 3) Use [▲ / ▼] to select "Make Recording Compatible", then press [OK].
- 4) Use [▲ / ▼] to select "ON" or "OFF", then press [OK].

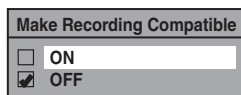

- ON:** Title list will be replaced when you make additional recordings to the discs recorded by other units.
- OFF:** Prohibiting additional record to the disc that has a title list created by other units.

- 5) Press [SETUP] to exit.

## Setting for Auto Chapter

You can set a specified time for chapter marks.

- 1) Press [SETUP] and use [▲ / ▼] to select "General Setting", then press [OK].  
"General Setting" menu will appear.
- 2) Use [▲ / ▼] to select "Recording", then press [OK].  
"Recording" menu will appear.
- 3) Use [▲ / ▼] to select "Auto Chapter", then press [OK].
- 4) Use [▲ / ▼] to select a desired time option, then press [OK].

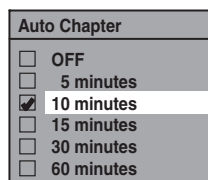

- 5) Press [SETUP] to exit.

### Note

- The interval for auto chapter marks may slightly differ.
- A blank chapter may be created depending on the remaining time of the disc.

# BASIC RECORDING & ONE-TOUCH TIMER RECORDING

Follow the steps to record TV programs.



# 1

**Press [DVD] first.**

**Insert a recordable disc (refer to page 25 on how to insert a disc).**

\* Make sure the disc is compatible with this unit. (Refer to page 38 for the list of compatible discs.)

**It may take a while to load the disc.**

- When inserting a brand-new DVD+RW/DVD-RW, the unit automatically starts to format.
- If titles have been recorded on the disc, the title list is displayed. Press **[STOP ■]** to exit the title list.

# 2

**Press [REC MODE] to select a recording mode.**

Refer to "Recording Mode" on page 38.

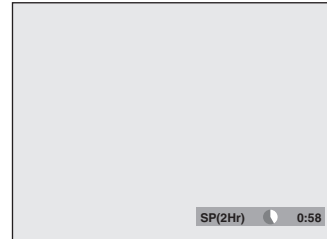

# 3

**Select the appropriate external input channel by pressing [SOURCE] or [CH + / -].**

**Press [DTV/TV] to select analog TV or digital TV, then use [CH + / -] or [the Number buttons] to select a desired channel to record.**

Refer to "Switching Analog Mode/Digital Mode" and "Channel Selection" on page 32.

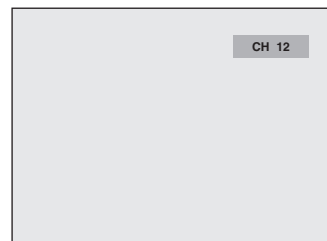



## 4 Press [REC ●] to start recording. "●" will be displayed for 5 seconds.

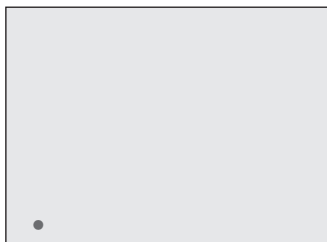

Press [PAUSE II] to pause recording.  
Press [PAUSE II] or [REC ●] again to restart recording.

## 5 Press [STOP ■] to stop recording. The recorded title will appear in the title list. (Refer to "Guide to a Title List" on page 76.) e.g.) DVD+R

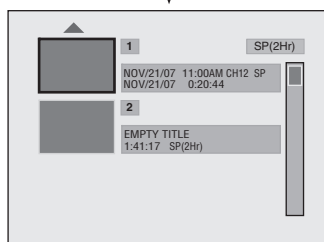
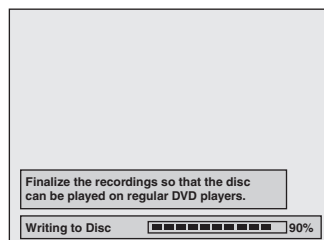

• Press [STOP ■] to exit the title list.

### To set one-touch timer recording (OTR)...

This is a simple way to set the recording time in blocks of 30 minutes.

Press [REC ●] repeatedly until the desired recording time (30 minutes to 6 hours) appears on the TV screen. One-touch timer recording will start.

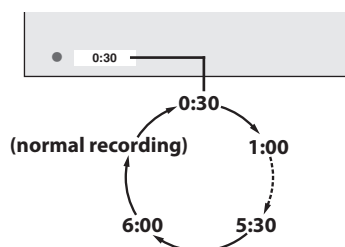

### To change the recording length during the one-touch timer recording:

Press [REC ●] repeatedly until the desired length appear.

### To cancel the one-touch timer recording within the specified time:

Press [STOP ■].

### Note

- When you press [REC ●], recording starts immediately and continues until the disc is full or you stop recording.
- This unit cannot record images as aspect ratio of 16:9. The 16:9 images will be recorded as 4:3.
- When the unit clock has not been set, the space for a date and time of title names will be blank.
- When you record a TV program, you have to select the TV channel audio beforehand. Only the selected channel audio will be recorded. Refer to "Selecting TV Audio" on pages 33-34 for more details.
- This unit cannot record in both stereo and SAP (secondary audio program) at the same time.
- You cannot change the recording mode during the recording pause mode.
- You can change a channel to be recorded during the recording pause mode.

### Note for one-touch timer recording

- The remaining recording time will be displayed on the front panel display during one-touch timer recording. Press [INFO] to see it on the TV screen.
- Unlike the timer recording, you can perform the following operations during one-touch timer recording.
  - Turning off the power to stop one-touch timer recording.
  - Using [REC ●].
- You cannot use the pause function during one-touch timer recording.
- When one-touch timer recording is finished and the power is turned off, the unit will switch to the timer-standby mode automatically if a timer recording has been programmed. Press [TIMER SET] to cancel the timer-standby mode to use the unit continuously.

# TIMER RECORDING

You can program the unit to record up to 12 programs within a month in advance. Daily or weekly program recordings are also available.

## Before recording, make sure

- Set the clock before setting a timer programming.
- Insert a recordable disc with enough recordable space.



## Guide to Timer Programming Display

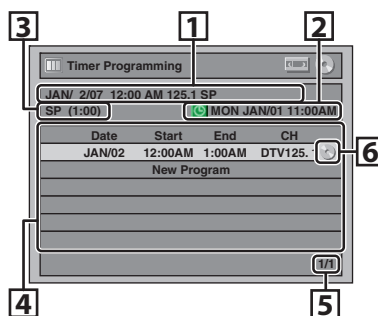

- 1 Title of a timer program (Contains date, time, channel, recording mode of the program)
- 2 Current date and time
- 3 Recording mode, and length of the recording
- 4 Timer program list
- 5 Total number of pages and current page (2 pages maximum)
- 6 Recording media

**1** Press [TIMER].

**2** Use [▲ / ▼] to select "New Program", then press [OK].

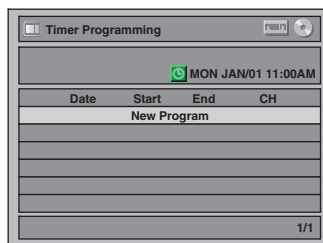

**3** Use [▲ / ▼] to enter the date, then press [▶].

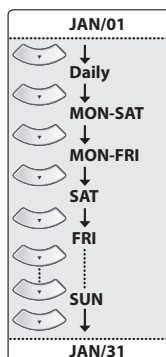
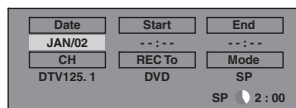

When pressing [▼] at the current date, the date will change as follows.

e.g.) January 1st

## Note

### • If you have not set the clock yet:

Entry screen for the clock setting will appear instead of the timer programming list at step 1. Continue with the step 4 in "Manual Clock Setting" on page 31 before setting a timer programming.

- Use [◀ / ▶] to move the cursor to the left and the right in the entry screen for the timer programming.
- If a basic recording or one-touch timer recording is in progress on one component (e.g., VCR) and the timer recording set for the other component (e.g., DVD) is about to begin, the unit automatically switches to the programmed channel for timer recording 2 minutes before the programmed starting time, and the recording in progress (for VCR) will be canceled UNLESS their recording channels are the same. If their recording channels are the same, the timer recording will start without canceling the recording currently in progress. In this case, the recording of the same channel will be made on both DVD and VCR.
- Cancel the timer-standby mode by pressing [TIMER SET] before operation for either DVD or VCR. When finished operating, press [TIMER SET] to resume the timer-standby mode.
- In the timer-standby mode, you can turn on the power and use the component (VCR or DVD) which is not currently timer-programmed.

**4** Use [▲ / ▼ / ◀ / ▶] or [the Number buttons] to enter the start and end time, then press [▶].

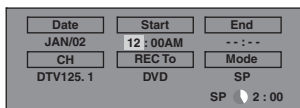

**5** Use [▲ / ▼ / ◀ / ▶] to select analog (" - - ") / digital ("DTV") mode or external input (E1 / E2), then press [▶].

e.g.) external input mode

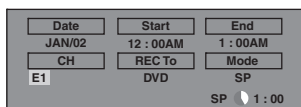

To record from external input (e.g., cable/satellite box), select E1 or E2.

Use [▲ / ▼] or [the Number buttons] to select the channel number to record, then press [▶].

For digital mode, select both major and minor channels. Refer to "How to select a channel number for the timer recording" on page 44 for more details.

e.g.) analog mode

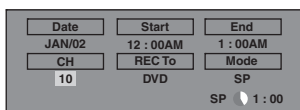

e.g.) digital mode

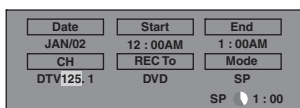

**6** Use [▲ / ▼] to select the recording media ("DVD" or "VCR"), then press [▶].

e.g.) recording to DVD



**7** Use [▲ / ▼] to select a recording mode.



Refer to "Recording Mode" on page 38.

- When recording to DVD, you can check the remaining recordable space of the disc when you select the recording mode.



### Auto recording mode select...

When "Auto" is selected as a recording mode, the unit calculates how much time is available on the disc and selects the best recording mode available automatically to complete recording the program.



- "Auto" is only available for one program in the timer program list.
- The recording may be cut short when the available recording space of the disc is too limited.

**8** Press [OK] when all items are entered.

After displaying a warning message for 10 seconds, timer program list will appear.

Press TIMER SET to Timer Standby mode.  
When Timer set on DVD or VCR,  
it is not available in the standby mode.  
Press TIMER SET to cancel the Standby mode.

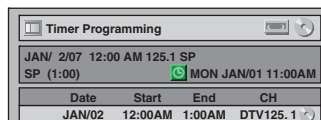

Your program setting is now stored.

- To set another program, repeat steps 2 to 8.
- To exit, press [TIMER] or [SETUP].
- When 2 or more programs are overlapped, "Timer program overlapped" appears, and the overlapped program will be displayed in blue.
- To correct the timer program refer to "Checking, canceling, or correcting the timer programming information" on page 44.

**9** Press [TIMER SET] to set a timer programming.

⌚ will appear on the front panel display.

# TIMER RECORDING

## How to select a channel number for the timer recording

Analog TV	For channel number 2-6 press, press [▶] or [•] to decide the channels. For other channels (7-69), the channel will be decided as soon as you enter the channel number.
Analog CATV	For channel number 1-12 press, press [▶] or [•] to decide the channels. For other channels (13-125), the channel will be decided as soon as you enter the channel number.
Digital TV	For channel number 1-9 press, press [▶] or [•] to decide the channels. For other channels (10-99), the channel will be decided as soon as you enter the channel number.
Digital CATV	For channel number 1-13 press, press [▶] or [•] to decide the channels. For other channels (14-135), the channel will be decided as soon as you enter the channel number.
minor channels	For channel number 1-9 press, press [▶] or [•] to decide the channels. For other channels (10-99), the channel will be decided as soon as you enter the channel number.

### <Hint>

- You can decide the 1-digit channel number by pressing 0 first, then enter desired 1-digit channel number. e.g.) "5": [0]+[5]
- For selecting the channels with [▲ / ▼] you need to press [▶] or [•] to decide the channel number.
- For selecting the minor channels with [▲ / ▼], please make sure the minor channel your are selecting is existed. [▲ / ▼] does not skip the non-existed minor channels.

## To stop the timer recording in progress

Press [STOP ■] to stop the timer recording in progress.

If the timer program did not complete correctly, the error number appears in the timer programming list.

## Checking, canceling, or correcting the timer programming information

- 1) Press [TIMER SET].
- 2) Press [TIMER].
- 3) Check the information.

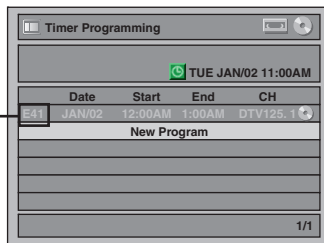
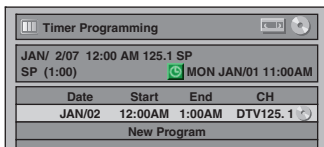

### 4-A) To delete the timer program:

- 1 Use [▲ / ▼] to select the program you want to delete, then press [OK].
- 2 Use [▲ / ▼] to select "Delete", then press [OK]. Confirmation window will appear.
- 3 Use [▲ / ▼] to select "Yes", then press [OK].

### 4-B) To correct the timer program:

- 1 Use [▲ / ▼] to select the program you want to correct, then press [OK].
- 2 Use [▲ / ▼] to select "Program Change", then press [OK].
- 3 Correct the timer program by using [▲ / ▼ / ◀ / ▶], then press [OK].

### 5) Press [TIMER] to exit.

### 6) Press [TIMER SET] to return to the timer standby mode.

### Each error number means:

E1-22 E37-39	Recording error other than below	E41	Power failed
E24	Unrecordable disc	E42	No disc when recording
E25-26	Copy prohibited program	E43	Already 49 titles recorded
E29	Disc protected	E44	Already 254 chapters recorded
E30	Disc full	E45	Copy prohibited program
E35	PCA full *1	E46	It is impossible to record additionally on a disc recorded by other units when setting "Make Recording Compatible" to "OFF".
E36	Already finalized video format disc		
E40	Some portion has not been recorded because of program overlapping. Recording did not start at the start time.		



- E23, E27, E28, E31, E32, E33 and E34 are not displayed.
- A program with the error number is grayed in the timer programming list.
- Once the timer programming list with error line(s) is displayed, or after canceling and setting again the timer standby mode, the program line(s) with error will be cleared.

\*1 PCA is a disc's space reserved for recording test.

### Note

- Press [TIMER] to check the timer recording in progress. When the timer recording is proceeding, that program will be highlighted with red. In this case, you cannot select any other program.

## Hints for Timer Recording

- If there is a power failure or this unit has been unplugged for more than 30 seconds, the clock setting and all timer programming will be lost.
- If a disc is not inserted, "DVD" on the front panel display flashes and timer recording cannot be performed. In some cases,  will appear momentarily around the start time as the unit attempts to record. Please insert a recordable disc.
- If a cassette tape with an erase-protection tab is not in the cassette compartment or there is no cassette tape in the cassette compartment, "VCR" on the front panel display flashes and timer recording cannot be performed. Please insert a recordable cassette tape.
- If a cassette tape ends during the timer recording, the unit will automatically stop, eject the cassette tape, and turn itself off. To continue recording, insert a recordable tape.
- When all the timer recordings are completed,  flashes. Press **[TIMER SET]** to release the unit from the timer standby mode.
- If both DVD and VCR are timer programmed, you cannot use any functions for either unit during timer standby or timer recording. If you want to use functions other than recording under such condition, cancel timer recording by pressing **[TIMER SET]** during timer standby or stop recording by pressing **[STOP ■]** during timer recording.
- To cancel the timer standby mode, press **[TIMER SET]**.
- When the starting and the ending time are the same, the length of the recording will be set for 24 hours. When the disc or cassette tape becomes full during the recording, the unit turns itself off.
- If the starting time is earlier and the ending time is later than the current time, the recording will start right after you press **[TIMER SET]** at step 9 on page 43.
- You cannot change the audio language for the timer recording of digital TV broadcasting.
- The timer recording cannot be performed in DVD and VCR at the same time. If you set 2 programmings with the same channel and time in both devices, the program which is set first will have the priority.

## The Priority of Overlapped Settings

- Timer program which has the earlier start time will be placed first in the timer program list, and be given priority over the programs with the later start time when timer programs overlap.
- When timer programs overlap, the first 2 minutes (at the longest) of the later recording will be cut off.
- When 2 or more timer programs have the same start time, the program set first will be given priority.
- A timer recording of lower priority will be canceled or start from the middle.
- Check the overlapped timer programmings and change the priority if necessary.

### ■ When the starting time is the same:

A program set previously (PROG. A) has priority.

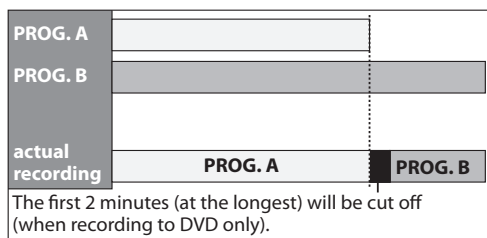

## Note for DVD recording

- When the recording time of 2 programs are overlapped, or the end time of a program and the start time of another program is the same, the first 2 minutes (at the longest) of the subsequent program will be cut off.
- If the cut-off portion comes up to 3 minute or more, this program will be displayed with error number E40 in the timer programming list.

### ■ When the end time of the programming currently being recorded and the start time of the subsequent program are same:

The beginning of the PROG. B may be cut off.

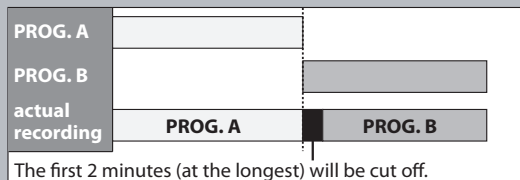

# OVERWRITING UNNECESSARY TITLE

## Overwriting from the Beginning of the Title



You can overwrite the existing title from the beginning.

### 1) Press [STANDBY-ON ].

Make sure that the TV input is set on the unit.

### 2) Load the disc that includes a title to be overwritten.

**It takes a while to display the title list.**

Title list will appear.

If the title list does not appear, press [TITLE].

### 3) Press [REC MODE] to select a recording mode.

Refer to "Recording Mode" on page 38.

### 4) Use [▲ / ▼] to select a title to be overwritten, then press [OK].

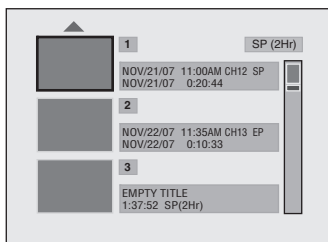

### 5) Use [▲ / ▼] to select "Overwrite", then press [OK].

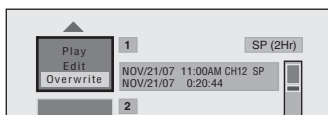

### 6) Select the channel you want to record.

(Refer to page 32 on how to select a channel.)

e.g.) DVD+RW

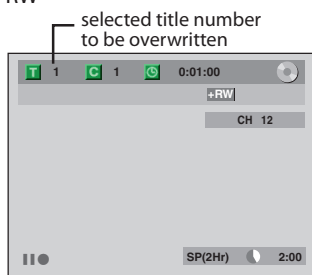

### 7) Press [REC ].

Overwriting recording starts.

The elapsed-time counter starts running.

### 8) Press [STOP ] to stop recording.

Title name is also overwritten.

**This operation may take a while to be completed.**

## Note

- The remaining recording time is displayed on the bottom right corner of the TV screen during overwriting.

## Overwriting in the Middle of the Title



You can overwrite the existing title from the selected position.

### 1) Follow the steps 1, 2 and 4 on the left.

### 2) Use [▲ / ▼] to select "Play", then press [OK].

Playback will start.

### 3) Press [PAUSE ] at the point from which you want to start overwriting.

### 4) Press [REC ].

"", display menu, channel, and the time lapse will be displayed as illustrated on the left.

### 5) Select the channel you want to record.

(Refer to page 32 on how to select a channel.)

### 6) Press [REC ] again.

Overwriting recording starts.

### 7) Press [STOP ] to stop recording.

**This operation may take a while to be completed.**

## Note

- Recording mode of the overwriting title is the same as that of the original (overwritten) title when overwriting in the middle of the title.
- Title name will not be overwritten.

# OVERWRITING UNNECESSARY TITLE

## Hints for Overwriting

When you overwrite on the unnecessary title, there were various circumstances such as follows. Please note that following cases only describe the overwriting without any recording mode discrepancy. To avoid accidental deletion please check if there is no important title after the overwriting point.

- When overwriting title is shorter than the existing title:**  
(overwriting from the beginning of the title)

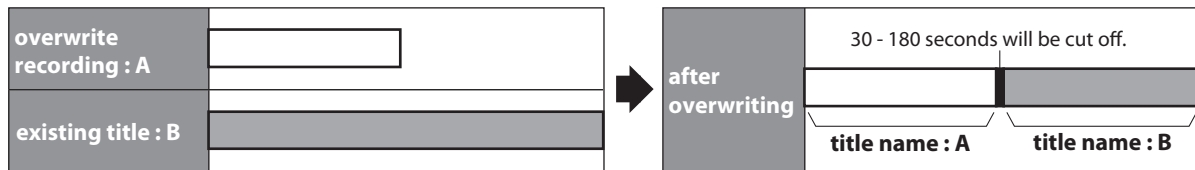

- When overwriting title is longer than the existing title:**  
(overwriting from the beginning of the title)

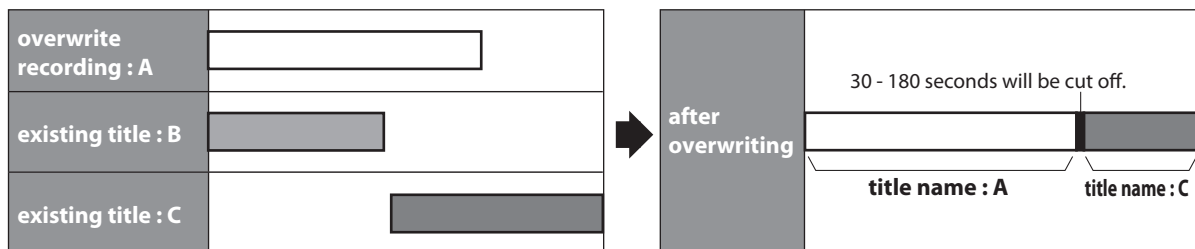
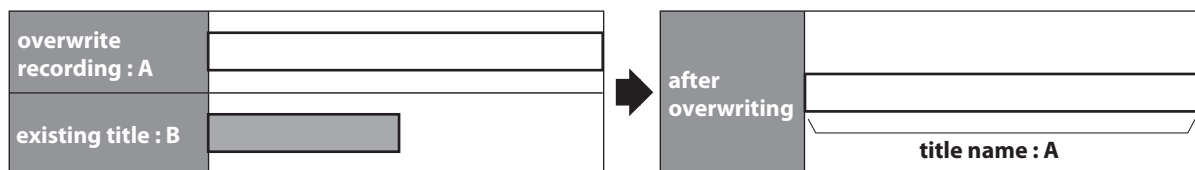

- When overwriting in the middle of the title:**

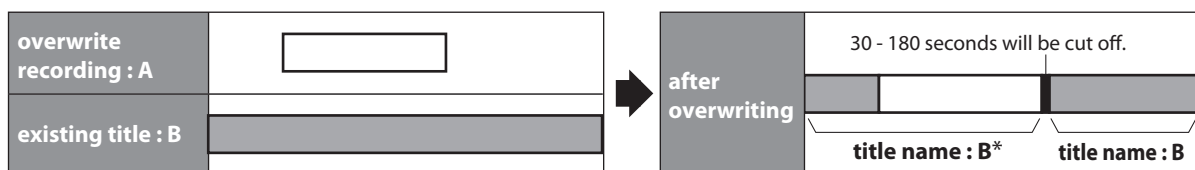

\*Overwritten section and the rest of the sections will have the same title name as the original existing title (B).

### Note

- When a title name is overwritten, its thumbnail is also overwritten.
- "Auto Chapter" interval time is reset at the overwriting start point.
- A chapter mark is put the beginning of the overwrite title when overwriting in the middle of the title.



# SETTINGS FOR AN EXTERNAL DEVICE

## Connection to an External Device

Connect the external device properly to the unit by using input jacks either E2 and E3 (Front) or E1 (Rear).  
 When connecting an external device of monaural output to this unit, use AUDIO L jack of E2 (Front).  
 Use S-video or the RCA audio/video cables for this connection.  
 When connecting a DV-camcorder, use DV input jack of E3 (Front) instead of S-VIDEO IN or VIDEO IN jack.

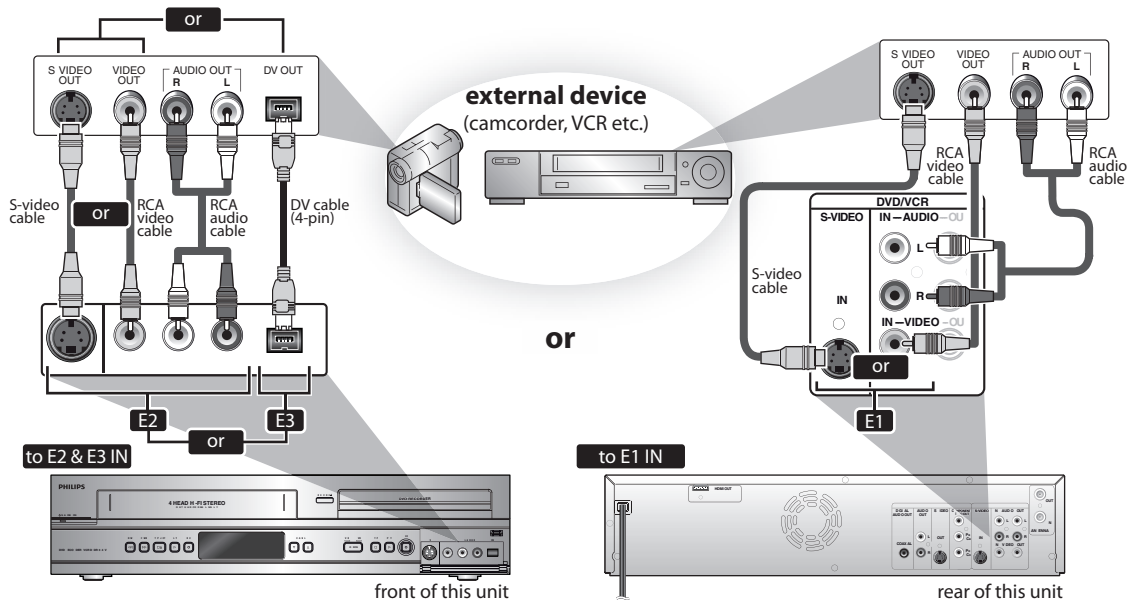

### Supplied cables used in this connection are as follows:

- RCA audio cable (L/R) x 1
  - RCA video cable x 1
- Please purchase the rest of the necessary cables at your local store.



**1** Press [SETUP] and use [▲ / ▼] to select "General Setting", then press [OK].  
 "General Setting" menu will appear.

**2** Use [▲ / ▼] to select "Video", then press [OK].  
 Submenu will appear.

**3** Use [▲ / ▼] to select "Video Input", then press [OK].

**4** Use [▲ / ▼] to select desired external input, then press [OK].

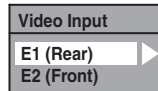

**5** Use [▲ / ▼] to select the input jack type to connect, then press [OK].  
 If you want to use VIDEO IN jack, select "Video In".  
 If you want to use S-VIDEO IN jack, select "S-Video In".

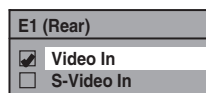

**6** Press [SETUP] to exit.

# SETTINGS FOR AN EXTERNAL DEVICE

## Recording from an External Device

Before recording from an external device, refer to the instructions for the connection on page 48.

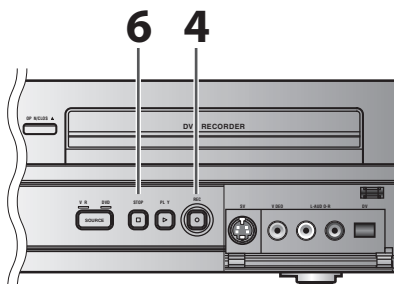
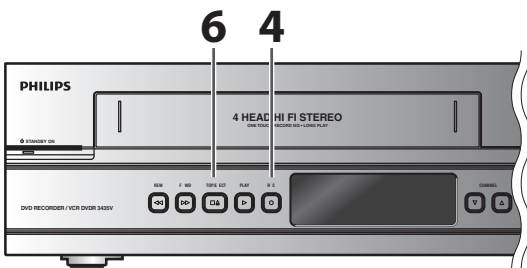
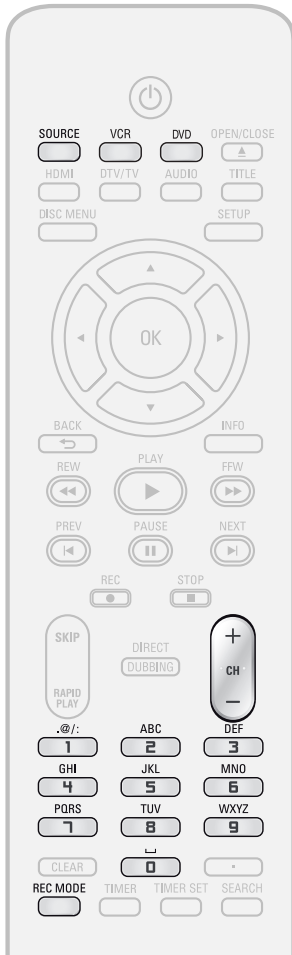

# 1

### Recording to a DVD

Press [DVD].

Insert a recordable disc (refer to page 25 on how to insert a disc).

It takes a while to load the disc.

### Recording to a Cassette Tape

Press [VCR].

Insert the cassette tape with an erase-protection tab intact.

# 2

Select the appropriate external input channel (E1 or E2) by pressing [SOURCE] or [CH + / -].

- If the external device is connected to the rear of this unit, select E1.
- If the external device is connected to the front of this unit, select E2.
- If you are connecting the digital video camcorder to the DV-IN jack of this unit, refer to "DV DUBBING" on pages 50-52.
- You can also select E1 or E2 channel by using [the Number buttons].  
e.g.) For E1, press [0], [0], [1].

# 3

Press [REC MODE] to select a recording mode.

Refer to "Recording Mode" on page 38 for DVD, or "Recording" on page 104 for VCR.

# 4

Press [DVD REC ●] or [VCR REC ●] on the unit to start recording.

# 5

Start playback on the external device to record from.

# 6

For disc:

Press [STOP ■] on the unit to stop recording.

For cassette tape:

Press [STOP/EJECT ■ ▲] on the unit to stop recording.

This operation may take a while to be completed.

# DV DUBBING

This function helps you to easily dub the contents in the DVC (digital video camcorder) to DVD or cassette tape. You can control basic operations of the DVC from the remote control of this unit if the DVC is in video mode.

## Guide to DV and On-Screen Display

- 1) Connect your DVC to the DV input jack on the front panel using a DV cable. (Use the DV cable that has 4-pin input jack and is compliance with the IEEE1394 standards.)
- 2) Press **[SOURCE]** repeatedly to select the appropriate external input channel for DV input (E3).
- 3) Press **[INFO]** to display the DVC information on the screen.

### DVD mode

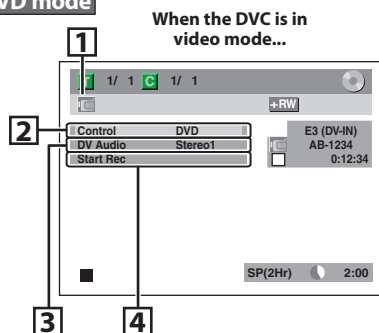

The menu changes according to what mode of DVC. Switch the mode on the DVC to video mode for the dubbing information.

### When the DVC is in camera mode...

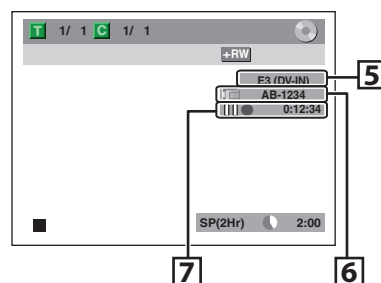

### VCR mode

For VCR mode on-screen display, refer to page 23.

The following instructions are described with the operations using the remote control of this unit.

#### 1. DV icon

#### 2. Indicator of active device

- With "Control" highlighted, press **[OK]** to display the available devices to control with the remote control of this unit. Use **[▲ / ▼]** to select the device you wish to operate, then press **[OK]**.
- Select "DVD" to control this unit with the remote control of this unit.
- Select "DV Input" to control your DVC with the remote control of this unit.

#### 3. Recording audio mode

- "DV Audio" can be changed. With "DV Audio" selected, press **[OK]** to display the "DV Audio" menu. Use **[▲ / ▼]** to select the audio you wish to output, then press **[OK]**.
- Select "Stereo1" to dub the stereo sound.
- Select "Stereo2" to dub the sound with after recording sound.
- Select "Mix" to dub the stereo1 and stereo2.

#### 4. Command menu

- "Start Rec" or "Pause Rec" will appear.

#### 5. External input channel

#### 6. Product name of your DVC

- If the unit cannot recognize the input signal from the DVC or if it is the unknown product, "No Device" or "\*\*\*\*\*" will appear instead.

#### 7. Status of the current operation and the time counter

Each icon means (Available icons may vary depending on the DVC):

- |                          |   |     |  |
|--------------------------|---|-----|--|
| <input type="checkbox"/> | DVC is in stop mode.                        | ⏩   | DVC is fast forwarding. (in stop mode)     |
| ▶                        | DVC is in playback mode.                    | ⏪   | DVC is fast reversing. (in stop mode)      |
| ⏸                        | DVC is in pause mode.                       | ⏮   | DVC is fast reversing. (standard speed)    |
| ▶▶                       | DVC is fast forwarding. (standard speed)    | ⏭   | DVC is fast reversing. (faster than above) |
| ▶▶▶                      | DVC is fast forwarding. (faster than above) | ⏭⏭  | DVC is fast reversing. (faster than above) |
| ▶▶▶▶                     | DVC is fast forwarding. (faster than above) | ⏭⏭⏭ | DVC is in slow reverse playback.           |
| ▶▶▶                      | DVC is slow forwarding. (standard speed)    | ●   | DVC is in recording.                       |
| ▶▶▶▶                     | DVC is slow forwarding. (faster than above) | ⏸●  | DVC is in recording pause mode.            |
| ▶▶▶▶▶                    | DVC is slow forwarding. (faster than above) |     |  |

Please also read the operating instructions of your DVC for more information.

## DVC to DVD Dubbing

Before recording from DVC, refer to page 48 for connection instructions.



**Press [DVD] first.**

### Preparing for DV to DVD dubbing:

- Insert a recordable disc and make sure your DVC is in video mode.

**1** Use [SOURCE] or [CH + / -] to select "E3 (DV-IN)".

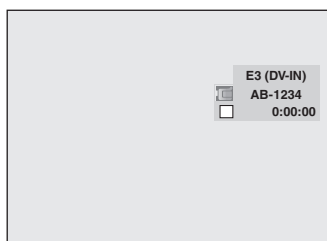

**2** Press [REC MODE] to select a recording mode.  
(Refer to page 38.)

**3** Press [INFO].

**4** With "Control" highlighted, press [OK] to display the available devices to control with the remote control of this unit. Use [▲ / ▼] to select "DV Input", then press [OK].

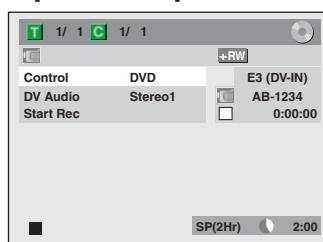

Now you can operate your DVC with the remote control of this unit.

**5** Press [PLAY ►] to start playing back the DVC, and find the point where you wish to start dubbing. Then, press [STOP ■] when you come to the desired start point.

**6** Use [▲ / ▼] to select "Start Rec", then press [OK].  
The dubbing will start.

**7** To stop dubbing;  
Use [▲ / ▼] to select "Control", then press [OK].  
Use [▲ / ▼] to select "DVD", then press [OK].  
Then press [STOP ■].

## DVC to VCR Dubbing



Before recording from DVC, refer to page 48 for connection instructions.



**Press [VCR] first.**

### Preparing for DV to VCR dubbing:

- Insert a recordable cassette tape and make sure your DVC is in video mode.

**1** Repeat the steps 1 and 2 on page 51.

**2** Press the **PLAY** button on your DVC to find the point where you wish to start dubbing. Then, press the **PAUSE** button on the DV camcorder when you come to the desired start point.

**3** Press **[REC ●]** to start recording.

**4** Press the **PLAY** button or the **PAUSE** button on your DVC to resume the playback.

The dubbing will start.

**To pause the recording:**

Press **[PAUSE II]** once.

"REC" will flash.

**To resume recording:**

Press **[REC ●]** or press **[PAUSE II]** again.

"REC" will reappear.

**5** To stop recording, press **[VCR]** then press **[STOP ■]**.

### Note for DV dubbing

- With regard to DVC to DVD dubbing, if you press **[PAUSE II]** at step 5, the tape will rewind to the point a few seconds preceding the paused point when you press **[OK]** at step 6, then, it will start dubbing when it comes to the paused point.
- The unit does not send out the output signal to DV camcorder.
- For the proper operation, connect DVC to the unit directly. Do not connect this unit and DVC via any other unit.
- Do not connect more than one DVC.
- The unit can only accept DVC. Other DV device such as cable / satellite box or D-VHS VCR cannot be recognized.
- If no video signal is detected from the DVC during DVC to DVD dubbing, the recording will be paused and "●" will flash on the TV screen. The recording will resume when the unit detects the video signal again.
- When the DVC is in Camera mode, refer to "Guide to DV and On-Screen Display" on page 50.
- You cannot dub from DVC to the both DVD and VCR at the same time.
- You cannot change the output mode during DVC to VCR dubbing. If you want to switch to the DVD mode, stop the VCR first.
- During DVC to VCR dubbing, you cannot change channels while paused.
- When output is in DVD mode while playing back a DVD using E3(DV-IN), you cannot switch to the VCR mode.
- If you are using anything other than E3(DV-IN) to playback DVD, you can switch to the VCR mode, but cannot select E3(DV-IN) channel. (You can select E3(DV-IN) after switching to the DVD mode during VCR playback.)
- You cannot dub from DVC during timer standby mode.
- During timer standby of either component, you cannot select E3(DV-IN) even on the component which is not in timer standby.
- Date / time and cassette memory data will not be recorded.
- Pictures with a copy-guard signal cannot be recorded.
- A DV terminal is a terminal that can use the transmission mode conforming to the IEEE 1394 standards called "Fire Wire". It enables digital dubbing between DV devices with little degradation.

# BI-DIRECTIONAL DUBBING

You can copy contents in a DVD to a cassette tape, or do vice versa. This function is available only when the contents are not copy-protected. (Before you start, refer to page 38 for the list of compatible discs.)



## Preparing for dubbing (cassette tape to DVD):

- Insert a cassette tape to be dubbed.
- Insert a recordable DVD.
- Make sure there is enough space on the DVD.

## Preparing for dubbing (DVD to cassette tape):

- Insert a disc to be dubbed.
- Insert a cassette tape with an erase-protection tab in tact.
- Make sure there is enough recordable length on the tape.

**1** Press [SETUP] and use [▲ / ▼] to select "General Setting", then press [OK].

"General Setting" menu will appear.

**2** Use [▲ / ▼] to select "Recording", then press [OK].

"Recording" menu will appear.

**3** Use [▲ / ▼] to select "Dubbing Mode", then press [OK].

Selection menu will appear.

### Note for dubbing

- Dubbing direction setting in "Dubbing Mode" menu is always reset to "VCR → DVD" whenever you turn off the power.
- You cannot change the output mode during VCR to DVD or DVD to VCR duplication.

### Note for recording to a tape:

Make sure

- the cassette tape's erase-protection tab is intact.
- the cassette tape is long enough.

### Note for recording to a disc:

Make sure

- the disc is compatible (refer to page 38).

Instructions continue on the next page.

# BI-DIRECTIONAL DUBBING

## VCR to DVD

**4** Use [**▲** / **▼**] to select “VCR → DVD”, then press [OK].

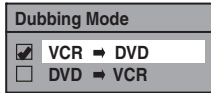

Press [SETUP] to exit.

**5** Press [VCR], then press [PLAY ►] to find the point where you wish to start dubbing.

**6** Press [PAUSE ||] when you come to the desired start point.

**7** Press [DVD], then press [REC MODE] repeatedly to select the desired recording mode.

**8** Press [DIRECT DUBBING].  
VCR to DVD duplication will start.

**9** Press [STOP ■] to stop the dubbing.

## DVD to VCR

**4** Use [**▲** / **▼**] to select “DVD → VCR”, then press [OK].

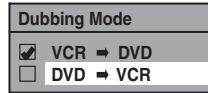

Press [SETUP] to exit.

**5** Press [DVD], then press [PLAY ►] to find the point where you wish to start dubbing.

**6** Press [PAUSE ||] when you come to the desired start point.

**7** Press [VCR], then press [REC MODE] repeatedly to select the desired recording mode.

Rewind or fast forward the tape to the point where you want to start recording.

**8** Press [DIRECT DUBBING].  
DVD to VCR duplication will start.

**9** Press [STOP ■] to stop the dubbing.

### Note for VCR to DVD duplication

- After starting VCR to DVD duplication, the picture may be distorted because of the auto tracking function. This is not a malfunction. Be advised to play back the tape until the picture is stabilized, then set the starting point which you wish to start recording, and start VCR to DVD duplication.
- This unit will automatically stop the duplication if playback with no image is detected for more than 3 minutes during VCR to DVD duplication.
- Playback sound mode of the dubbed contents is determined by the playback sound mode of the VCR at the point of dubbing.
- This function is available for audio CD, but not with MP3, Windows Media™ Audio or DivX® files.



# SETTING A DISC TO PROTECT

To prevent accidental recording, editing or erasing the titles, you can protect them from "Disc Edit" menu.



**1** Press [SETUP].

**2** Use [▲ / ▼] to select "Disc Edit", then press [OK].

**3** Use [▲ / ▼] to select "Disc Protect OFF ➔ ON", then press [OK].  
e.g.) DVD+RW

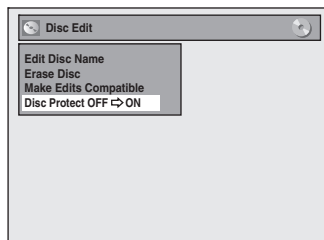

**4** Use [▲ / ▼] to select "Yes", then press [OK].

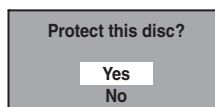

A disc will be protected.

**This operation may take a while to be completed.**

## Note

### To cancel the disc protect:

- When you insert a disc protected with this unit, "Disc Protect ON ➔ OFF" will appear instead of "OFF ➔ ON" at step 3.

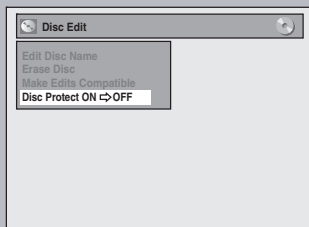

To release the protect for the disc, select "Yes" at step 4.

# PLAYING THE DISCS ON OTHER DVD PLAYERS

## Finalizing a Disc



You will need to finalize DVD+R, DVD-RW or DVD-R to play them back on other DVD players.

Finalizing may take several minutes up to an hour.

A shorter recording period on the disc will require a longer time period for finalization. Do not unplug the power cord during finalization.



### Note

- Once you have finalized a DVD+R/ DVD-R, you cannot edit or record anything on that disc.
- There is no need to finalize DVD+RW.
- When you insert a DVD-RW finalized with this unit, "Undo Finalize" will appear instead of "Finalize".

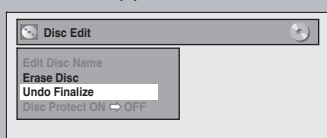

To release the finalizing for the disc, select "Undo Finalize" at step 3.

\* DO NOT power off during finalization, this will result in malfunction.

- 1 Press [SETUP].**  
If you are in the title list, you need to exit from the list by pressing [STOP ■] before you are able to access the main menu.
- 2 Use [▲ / ▼] to select "Disc Edit", then press [OK].**  
"Disc Edit" menu will appear.
- 3 Use [▲ / ▼] to select "Finalize", then press [OK].**
- 4 Use [▲ / ▼] to select "Yes", then press [OK].**  
e.g.) DVD+R, DVD-R

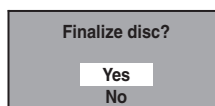

Finalizing will start.



### To cancel finalizing... (DVD-RW only)

- To cancel finalizing at step 4, press [STOP ■], select "Yes" with [▲ / ▼], then press [OK]. Finalizing is canceled and the unit will be in stop mode.

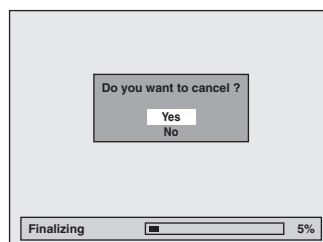

- If Ⓞ appears when pressing [STOP ■], you cannot cancel finalizing because the finalizing has been in certain progress.
- When selecting "No" and press [OK] or [BACK ↵], finalizing will be continued.
- You cannot cancel finalizing the DVD+R/DVD-R once it has started.

This operation may take a while to be completed.

- 5 Finalizing is completed.**

## Auto Finalizing



You can finalize discs automatically using this function. You can use this function to finalize discs after finishing all timer recordings and at the end of the disc space.



**1** Press [SETUP] and use [▲ / ▼] to select **“General Setting”**, then press [OK].

“General Setting” menu will appear.

**2** Use [▲ / ▼] to select **“Recording”**, then press [OK].

“Recording” menu will appear.

**3** Use [▲ / ▼] to select **“Auto Finalize”**, then press [OK].

**4** Use [▲ / ▼] to select **“Disc Full”** or **“End of Timer Rec”**, then press [OK].

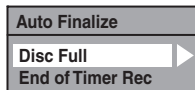

**5** Use [▲ / ▼] to select **“ON”**, then press [OK].

e.g.) “Disc Full”

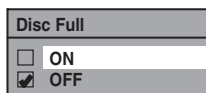

Your setting will be activated.









**6** Press [SETUP] to exit.

# INFORMATION ON PLAYBACK

Before you play back DVD, read the following information.

## Playable Discs and Files

This unit is compatible to play back the following discs. To play back a DVD, make sure that it meets the requirements for region codes and color systems as described below. You can play back discs that have the following logos will play back on the unit. Other disc types are not guaranteed to play back.

Playable discs	Logos
DVD-video	
DVD+RW	
DVD+R	
DVD+R Double Layer	
DVD-RW (Finalized video mode discs only)	
DVD-R (Finalized video mode discs only)	
CD-DA (audio CD)	
CD-RW	
CD-R	

Playable files	Media
CD-DA	
MP3	CD-RW/-R
Windows Media™ Audio	
JPEG	CD-RW/-R
DivX®	DVD+RW/+R DVD-RW/-R

 is a trademark of DVD Format/Logo Licensing Corporation.



DivX, DivX Certified, and associated logos are trademarks of DivX, Inc. and are used under license.

- Official DivX® Certified product; Plays DivX® 6.0, DivX® 5, DivX® 4, DivX® 3, and DivX® VOD video content (in compliance with DivX Certified™ technical requirements).
- Discs containing the DivX® files with the DivX® GMC (Global Motion Compensation) playback feature, which is DivX® supplemental function, cannot be played back on this unit.

\* This unit cannot play back the disc contents protected by Windows Media Digital Rights Management (DRM).

## Unplayable Discs

The following discs will not play back on this unit.

- CD-ROM
- DVD-RAM
- DVD-ROM
- Unfinalized disc
- DVD contains MP3/Windows Media™ Audio/JPEG files
- DVD-R or DVD-RW recorded in VR mode or non compatible recording format
- Compact Disc-Interactive (CD-I)
- Video Single Disc (VSD)
- DVD-audio

On the following disc, the sound may not be heard.

- Super audio CD - Only the sound on the CD layer can be heard. The sound on the high-density super audio CD layer cannot be heard.

## Color Systems

DVD is recorded in different color systems throughout the world. The most common color system is NTSC (which is used primarily in the United States and Canada). This unit uses NTSC, so DVD you play back must be recorded in the NTSC system. You cannot play back DVD recorded in other color systems.

## Region Codes

This unit has been designed to play back DVD with region 1. DVD must be labeled for ALL regions or for region 1 in order to play back on the unit. You cannot play back DVD that are labeled for other regions. Look for the symbols on the right on your DVD. If these region symbols do not appear on your DVD, you cannot play back the DVD in this unit.



The number inside the globe refers to region of the world.

A DVD labeled for a specific region can only play back on the unit with the same region code.

## Hint for DVD Playback

The contents of DVD are generally divided into titles. Titles may be further subdivided into chapters.

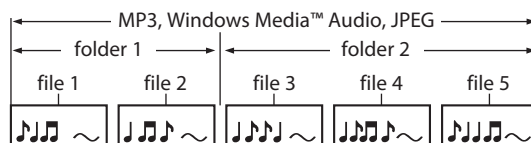
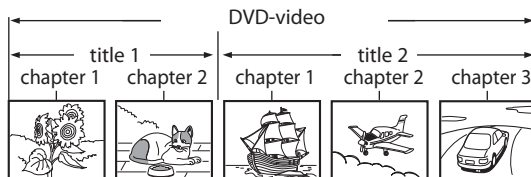

# BASIC PLAYBACK

## Direct Playback



1

**Press [DVD] first.**  
Insert a playable disc (refer to page 25 on how to insert a disc).

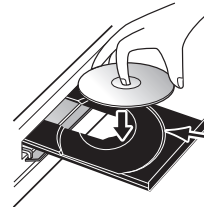

Align the disc to the disc tray guide.

\* Make sure the disc is compatible with this unit.  
(Refer to page 58 for the list of compatible discs.)

**It may take a while to load the disc.**

2

**Press [PLAY ►] to start playback.**  
If you are playing back a DVD-video, a menu may appear.

Refer to "Using the Title / Disc Menu" on page 66.

3

**Press [STOP ■] once to stop playback temporarily.**

• Refer to "Resume Playback" on page 67.

### Note

- Some discs may start playback automatically.

## Playback from the Title List



# 1

**Press [DVD] first.**

**Insert a playable disc (refer to page 25 on how to insert a disc).**

\* Make sure the disc is compatible with this unit.  
(Refer to page 58 for the list of compatible discs.)

**It may take a while to load the disc.**

- Title list will appear automatically.
- To exit the title list, press **[STOP ■]**.
- To resume the title list, press **[TITLE]**.

### Note

- Some discs may start playback automatically.
- You can also start playback by pressing **[PLAY ►]** instead of **[OK]** at step 2.

Instructions continue on the next page.

# BASIC PLAYBACK

**2** Use [▲ / ▼] to select a desired title, then press [OK].

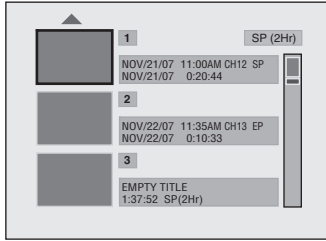

- Press [▶] to display the next page, and press [◀] to display the previous page.

**3** Use [▲ / ▼] to select "Play", then press [OK].

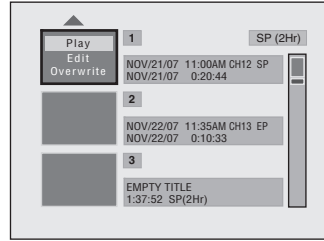

Playback will start.

**4** Press [STOP ■] once to stop playback temporarily.

- Refer to "Resume Playback" on page 67.

If you want to see disc information, press [◀] when the first page of the title list is displayed or press [▲] when the first title is selected but not when "Play", "Edit" or "Overwrite" is highlighted.

e.g.) DVD+RW

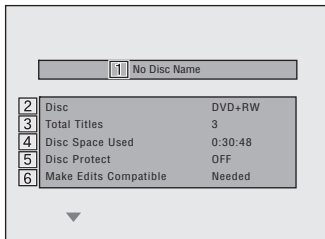

e.g.) DVD+R

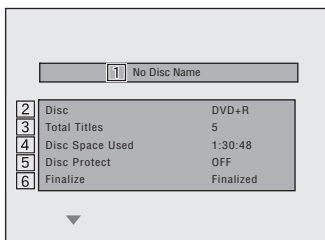

1. Disc name  
(Default "No Disc Name")
2. Disc type  
(DVD+RW/DVD+R/ DVD-RW/DVD-R)
3. Total number of title  
(include "EMPTY TITLE")
4. Total time of recorded disc space
5. Status of disc protection  
(“ON” is protected disc.)
6. Making edits compatible/finalize
  - When DVD+RW is inserted:  
If the disc needs to be set "Make Edits Compatible", "Needed" is displayed. Otherwise, "Not Needed" is displayed. (Refer to page 88.)
  - When DVD+R, DVD-RW or DVD-R is inserted:  
If "Finalize" is done, "Finalized" is displayed. Otherwise, "Unfinalized" is displayed.



# BASIC PLAYBACK

## Playing Back an Audio CD and a CD-RW/-R with MP3/Windows Media™ Audio/JPEG Files



# 1

**Press [DVD] first.  
Insert a playable disc (refer to page 25 on how to insert a disc).**

\* Make sure the disc is compatible with this unit.  
(Refer to page 58 for the list of compatible discs.)

**It may take a while to load the disc.**

When an audio CD is inserted, track list will appear.

When a CD-RW/-R with MP3/Windows Media™ Audio/JPEG files is inserted, file list will appear.

- To exit the track/file list, press **[STOP ■]**.
- To resume the track/file list, press **[TITLE]**.

# 2

**Use [▲ / ▼] to select a desired folder or track/file, then press [OK].**  
e.g.) File list

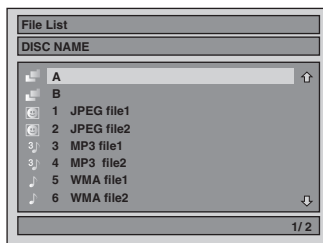

### When selecting track/file:

Playback will start.





### When selecting the folder (Not available for audio CD):

The files in the folder will appear.

Use [▲ / ▼] to select the file or folder you want to play back, then press **[OK]**.

- Press **[PLAY ▶]**, **[OK]** or **[▶]** to move to any lower hierarchies.
- Press **[◀]** or **[BACK ◀]** to move back to the previous hierarchy.

### Hints for audio CD tracks and MP3 / Windows Media™ Audio / JPEG files:

- Folders are shown by .
- Audio CD tracks are shown by .
- MP3 files are shown by .
- Windows Media™ Audio files are shown by .
- JPEG files are shown by .
- The system can recognize up to 255 folders, up to 99 tracks/999 files.
- Letters of a file/folder name overflowing the given space will be displayed as "...". Unrecognizable characters will be replaced with asterisks.
- If there are no files in the folder, "No Files" will be displayed.

**It is recommended that files to be played back in this unit are recorded under the following specifications:**

#### <MP3 / Windows Media™ Audio>

- Sampling frequency : 44.1 kHz or 48 kHz.
- Constant bit rate : 112 kbps - 320 kbps (MP3), 48 kbps - 192 kbps (Windows Media™ Audio).

#### <JPEG>

- Upper limit : 6,300 x 5,100 dots.
- Lower limit : 32 x 32 dots.
- File size of image maximum : 12 MB.

### Note

- The audio source of MP3 files cannot be recorded as digital sound by an MD or DAT deck.
- Files whose extension is other than ".mp3(MP3)" ".wma(Windows Media™ Audio)" or ".jpg / .jpeg(JPEG)" will not be listed.
- Some unplayable folders or files may be listed due to the recording status.
- High-resolution JPEG files take longer to be displayed.
- Progressive JPEG files (JPEG files saved in progressive format) cannot be played back on this unit.

## Playing Back a DivX®



- Press [DVD] first.**

**Insert a playable disc (refer to page 25 on how to insert a disc).**

\* Make sure the disc is compatible with this unit. (Refer to page 58 for the list of compatible discs.)

**It may take a while to load the disc.**

File list will appear automatically.

- To exit the file list, press [STOP ■].
- To resume the file list, press [TITLE].

- Use [▲ / ▼] to select the desired folder or file, then press [OK].**

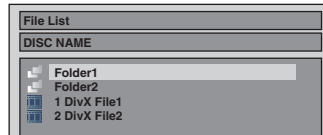

### When selecting file:

Playback will start.

### When selecting folder:

The files in the folder will appear.

Use [▲ / ▼] to select the file you want to play back, then press [OK].

- Press [PLAY ►], [OK] or [▶] to move to any lower hierarchy.
- Press [◀] or [BACK ↶] to move back to the folder above.

### **To play back the DivX® subtitle created by the user...**

The subtitle created by the user can be displayed during DivX® playback.

- 1) After selecting the DivX® file, the "Subtitle List" will appear when "DivX Subtitle" is set to anything other than "OFF". (Refer to page 100.)
- 2) Use [▲ / ▼] to select the desired extension you want to display, then press [OK].

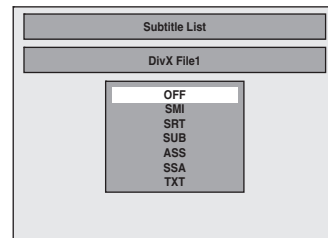

DivX® with the subtitle starts playback. The subtitle cannot be displayed when the setting is "OFF".

- If there is more than one extension, the extension selection appears in the subtitle list.

# BASIC PLAYBACK

**It is recommended that files to be played back in this unit are recorded under the following specifications:**

Official DivX® Certified product

- Playable codec of AVI files : DivX®3.x, DivX®4.x, DivX®5.x
- Maximum size of image : 720 x 480 @30 fps  
720 x 576 @25 fps
- Sampling frequency of audio: 8 kHz - 48 kHz
- Audio type : MPEG1 audio layer 3(MP3),  
MPEG1 audio layer 2,  
Dolby Digital

**Hint for the purchased or rental official DivX® Certified product**

- When you purchased or rental a DivX® file through the official site of DivX® video which is called DivX® Video-On-Demand (VOD) services, a registration code is required every time you get the new file from the DivX® VOD services. Refer to "DivX® VOD" on page 100.

- Some DivX® VOD files are restricted with the limited playable times (you cannot play them back beyond the limit). If your DivX® VOD file has such limit, the playback confirmation screen will appear.

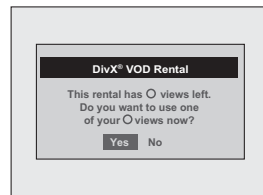

- Use [◀/▶] to select "Yes" if you want to play back the file, or to select "No" if you do not wish to play it back. Then, press [OK] to confirm the selection.

- You cannot play back the DivX® VOD files, of which rental period has been expired. In such case, press [TITLE] and select other files that can be played back.

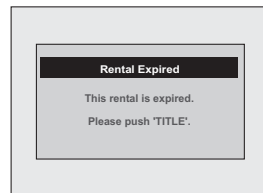

## Note for DivX®

- DivX® is a codec (compression/decompression) that can compress images to a very small amount of data. The software can compress video data from almost any devices to the size that can be sent on the Internet without compromising visual quality of the images.
- A file with an extension of ".avi" and ".divx" is called an DivX® file. All files with the ".avi" extension are recognized as MPEG4.
- Files whose extension other than ".avi" and ".divx" will not be listed on the DivX® menu. However, unplayable folders and files may be displayed, depending on the recording conditions.
- Even if the file has an extension of either ".avi" and ".divx", this unit cannot play it back if it is recorded in the format other than DivX®.
- A symbol of  is shown on the top of the file name.
- A maximum of 255 folders or 999 files may be recognized in a disc.
- Up to 8 hierarchies can be recognized in a folder. Files in the 9th or deeper hierarchies cannot be played back.
- When there are 9 or more files, a down arrow "▼" appears, indicating that the user can view another part on the previous page. The current page number and the number of total pages are shown below the down arrow "▼".
- Letters of a file/folder name overflowing the given space will be displayed as "...". Unrecognizable characters will be replaced with asterisks.
- You can play back the disc recorded in multi-session.
- It may take a while for audio and images to be output after you inserted a disc and pressed [PLAY ▶].
- When playing back the files recorded in high bit rates, the images can be interrupted in some occasions.
- Although DivX® logo has been obtained for this unit, it may not be able to play back some data, depending on the characteristics, bit rates, or audio format settings, etc.
- A DivX® file whose file size exceeds 2 GB cannot be played back.
- If a large-sized DivX® file is selected, it may take a while to start the playback (over 20 seconds sometimes).
- If you try to playback the DivX® file that has the screen resolution which this unit does not support, the playback will be stopped and error message will appear.

- If DivX® files written on a CD-RW/-R cannot be played back, rewrite them on a DVD+RW/+R or DVD-RW/-R and try to play back.

- For more information for DivX®, please visit <http://www.divx.com>.

- If you insert a CD-RW/-R with DivX® files that are mixed with MP3/Windows Media™ Audio/JPEG files, the playback media selection screen will be displayed. Please select "Video" and proceed to next step.

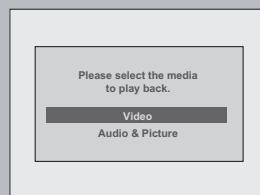

- Press [DISC MENU] to call up the playback media selection screen in stop mode.
- If you select "Audio & Picture", instead of "Video" on the playback media selection screen, this unit can play back MP3/Windows Media™ Audio/JPEG files.
- Some DivX® files cannot be played back on this unit due to the configuration and characteristics of the disc, or due to the condition of recording and authoring software.
- You cannot play back the DivX® VOD files obtained with different registration codes on this unit. Press [TITLE] and select other files that can be played back.

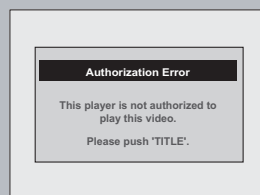

## Note for DivX® Subtitle

- To utilize this function, the following conditions must meet.
  - "DivX Subtitle" must be activated in "DivX" menu. (Refer to "DivX Subtitle" on page 100.)
  - Playback file and the subtitle file must have the same name.
  - Playback file and the subtitle file must locate in the same folder.
  - Only the subtitle files with the following extensions are supported; .smi (.SMI), .srt (.SRT), .sub (.SUB), .ass (.ASS), .ssa (.SSA), .txt (.TXT). (.sub (.SUB) and .txt (.TXT) files may not be recognized.)
  - The subtitles that exceeds the playback time of the DivX® file will not be displayed.

# BASIC PLAYBACK

## Using the Title / Disc Menu



Press [DVD] first.

1) Insert a playable disc (refer to page 25 on how to insert a disc).

\* Make sure the disc is compatible with this unit. (Refer to page 58 for the list of compatible discs.)

**It may take a while to load the disc.**

2) Press [TITLE] or [DISC MENU] to call up the title list or disc menu.

3) Use [▲ / ▼ / ◀ / ▶] to make a selection, and then press [OK] to enable your selection.

4) Press [STOP ■] to exit.

### Note

- You can select a numbered menu with **[the Number buttons]** also.
- Menus vary among discs. Refer to the information accompanying the disc for details.
- [TITLE] or [DISC MENU] will not always be active with all DVD.

## Pause

1) During playback, press [PAUSE ||].

Playback will be paused and sound will be muted.

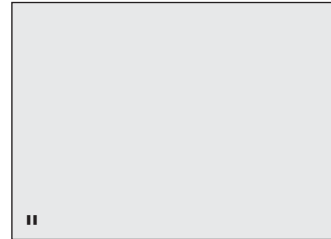

2) Press [PLAY ▶] to return to the normal playback.

### Note

- On DVD, set "Still Mode" to "Field" in "Playback" menu if pictures in the pause mode are blurred. (Refer to page 95.)

# SPECIAL PLAYBACK

## Resume Playback

You can play back from where you stopped playing back the disc last.

### 1) During playback, press [STOP ■].

The resume message will appear.



### 2) Press [PLAY ►].

In a few seconds, playback will resume from the point at which it stopped last. You can resume playback at the same point even if you turn off the unit.

To cancel the resume playback and start playing back the disc from the beginning, press [STOP ■] again while the playback is stopped.

### Note

- For MP3/Windows Media™ Audio/JPEG files, playback will resume from the beginning of the file at which playback was stopped.

## Fast Forward / Fast Reverse Playback



### 1) During playback, press [FFW ►►] or [REW ◀◀].

Every time you press [FFW ►►] or [REW ◀◀], approximate speed will be changed as follows.

Fast forward or fast reverse playback across titles (for DVD) or files (for MP3 / Windows Media™ Audio files) is not possible.



For audio CD, MP3/Windows Media™ Audio files, approximate speed is fixed at 8x with sound (indicated with ►►►► / ◀◀◀◀).

Picture quality of DivX® files in fast reverse is lower than that in fast forward.

For some DivX® files, fast forward/fast reverse may not function.

### 2) Press [PLAY ►] to return to the normal playback.

### Note

- Forward/reverse speed will be indicated with icons as follows.

forward (approx. speed)

2x: ►►

20x: ►►►►

40x: ►►►►►►

reverse (approx. speed)

5x: ◀◀

20x: ◀◀◀◀

40x: ◀◀◀◀◀◀

## Skipping TV Commercials During Playback



You can skip TV commercials to enjoy the recorded programs without interrupting.

### During playback, press [SKIP].

Normal playback will start at 30 seconds ahead from the point you press [SKIP].

Every time you press [SKIP], the searching point will be extended by 30 seconds ahead.

You can press [SKIP] up to 6 times (180 seconds).

e.g.) Press [SKIP] once.

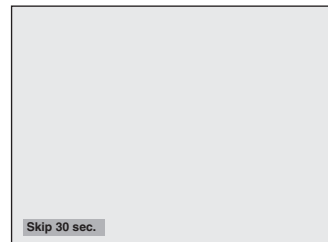

(forwarding 30 seconds)

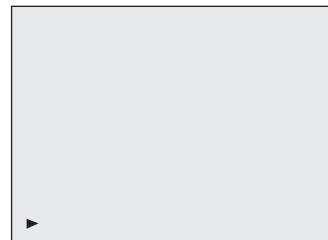

Playback will return to the normal playback.

# SPECIAL PLAYBACK

## Rapid Playback



Rapid playback function is available only during playback.

This function is available only on discs recorded in the Dolby Digital format, and plays back in a slightly faster/slower speed while keeping the sound quality just as normal playback.

1) During playback, press [RAPID PLAY].

- ▶ : Press [RAPID PLAY] once during playback. Plays back approximately at 0.8 times of normal playback.
- ▶ : Press [RAPID PLAY] twice during playback. Plays back approximately at 1.3 times of normal playback.
- ▶ : Press [RAPID PLAY] 3 times to play back in normal speed. No effects.

2) Press [PLAY ►] to continue the normal playback.

### Note

- Audio (language) setting cannot be changed while using this mode.
- This feature may not work at some point in a disc.
- Audio is PCM during rapid playback mode except when using digital audio connection.
- When using digital audio connection (COAXIAL or HDMI), the LPCM sound (2 channel) will be output.

## Step by Step Playback



1) During playback, press [PAUSE ■■].

Playback will be paused and sound will be muted.

2) Press [NEXT ►] repeatedly.

Playback will advance one frame (or step) at a time when you press [NEXT ►] with the sound muted.

To play back step by step backward:

Press [PREV ◀] repeatedly.

Every time you press the button, the playback will go backward by one frame.

- Press and hold [PREV ◀] / [NEXT ►] to reverse/advance continuously.

3) Press [PLAY ►] to continue the normal playback.

### Note

- Only step by step forward playback is available for playing back DivX® files.

## Slow Forward / Slow Reverse Playback



1) During playback, press [PAUSE ■■]. Then press [FFW ►►] or [REW ◀◀].

Every time you press [FFW ►►] or [REW ◀◀], approximate speed will be changed as follows. (The sound will remain muted.)

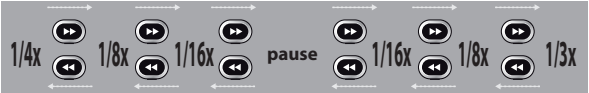

To return to the normal playback, press [PLAY ►].

### Note

- Forward/reverse speed will be indicated with icons as follows.  
forward (approx. speed)  
1/16x:   
1/8x:   
1/3x:   
reverse (approx. speed)  
1/16x:   
1/8x:   
1/4x:
- For some DivX® files, slow forward/slow reverse may not function.
- Only slow forward is available when playing back DivX® files.

## Zoom



1) During playback, press [INFO].

2) Use [◀/▶] to select , then press [OK] within 1 second or wait for 1 second to display the selection menu.

e.g.) DVD-video

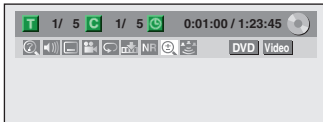

3) Use [▲/▼] to select a desired zoom factor to zoom, then press [OK].

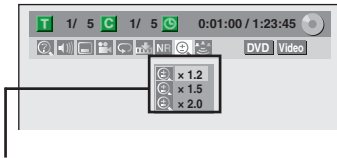

Zoom menu will appear.

There are four options (x1.0, x1.2, x1.5 and x2.0), these are displayed excluding the current zoom rate.

Zoom area will be displayed.

4) Use [▲/▼/◀/▶] to select a desired zoom position, then press [OK].

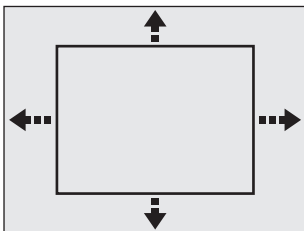

Zoom playback will start.

### Note

- When selecting a smaller factor than the current one, the zoom area will not be displayed.
- To exit the zoom menu, press [INFO] again at step 1.
- To cancel the zoom function, select "x1.0" using [▲/▼], then press [OK].
- You cannot slide the zoomed picture on some JPEG files.

## Marker Setting



This feature allows you to assign a specific point on a disc to be called back later.

1) During playback, press [INFO].

2) Use [◀/▶] to select , then press [OK] within 1 second or wait for 1 second to display the marker list.

e.g.) DVD-video

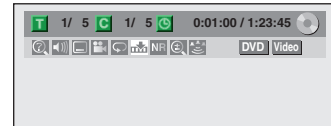

3) Use [▲/▼] to select a desired marker number. When it reaches the desired point, press [OK].

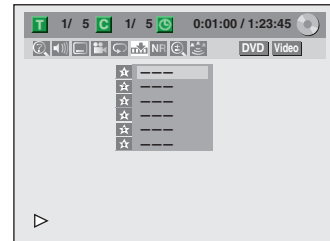

The title (track) number and the time will be displayed.

4) To return to the marker later:

Use [▲/▼] to select the desired marker number, then press [OK].

### Note

- To clear a marker, select the marker number to be cleared, then press [CLEAR].
- All markers will be erased when you operate these operations listed below.
  - Opening the disc tray
  - Turning off the power
  - Record on a recordable disc
- You can mark up to 6 points.

## Repeat Playback

Available repeat function may vary depending the discs.

1) During playback press [INFO].

2) Use [◀/▶] to select , then press [OK] within 1 second or wait for 1 second to display the selection menu.

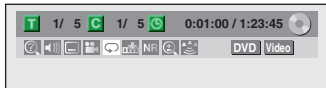

3) Use [▲/▼] to select a desired repeat type, then press [OK].

e.g.) DVD-video

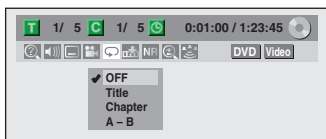

e.g.) audio CD

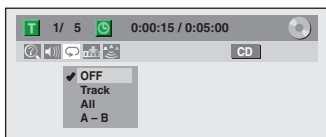

e.g.) MP3/Windows Media™ Audio/JPEG files

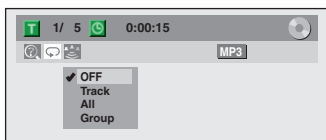

The selected repeat playback will start.

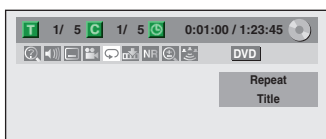

### Title:

The current title will be played back repeatedly.

### Chapter:

The current chapter will be played back repeatedly.

### All:

The current disc will be played back repeatedly.

### A-B:

Desired section can be played back repeatedly.

- 1) Use [▲/▼] to select "A-B", then press [OK].
- 2) Press [OK] at the desired starting point A.
- 3) Press [OK] at the desired ending point B.

### Track:

The current track or file will be played back repeatedly.

### Group:

The current folder will be played back repeatedly.

## Note

- Point B for the repeat A-B playback should be set within the same title or track as point A.
- To cancel the repeat playback, select "OFF" at step 3. The repeat setting will also be canceled when you stop playback.
- You cannot select "Group" during the random playback.
- For some DivX® files, A-B repeat playback may not function.

## Random Playback



You can play back a disc randomly instead of playing back in the original order.

1) Press [SETUP].

2) Use [▲/▼] to select "CD Playback Mode", then press [OK].

"CD Playback Mode" menu will appear.

3) Use [▲/▼] to select "Random Play", then press [OK].

Random playback will start.

## Note

- To cancel random playback, press [STOP ■] twice during random playback. "OFF" appears on the TV screen.



# SPECIAL PLAYBACK

## Program Playback



You can program the disc to play back in your desired order.

- 1) Press [SETUP].
- 2) Use [▲ / ▼] to select "CD Playback Mode", then press [OK].  
"CD Playback Mode" menu will appear.
- 3) Use [▲ / ▼] to select "Program Play", then press [OK].
- 4) Use [▲ / ▼] to select a desired track, then press [OK] or [▶].

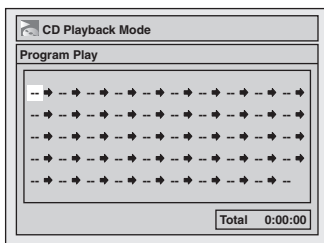

Repeat this step until you program all the desired tracks.

- 5) Press [PLAY ▶].

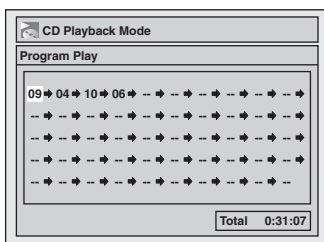

Program playback will start.

### Note

- To erase tracks you selected, press [CLEAR] at step 4.
- You can make program settings up to 50 tracks.
- To cancel program playback, press [STOP ■] twice during program playback. "OFF" appears on the TV screen.
- You may also select a desired track using [the Number buttons] at step 4.

## Slide Show



You can select the display time between 5 seconds and 10 seconds.

- 1) Follow steps 1 and 2 in "Random Playback" on page 70.
- 2) Use [▲ / ▼] to select "Slide Show", then press [OK].
- 3) Use [▲ / ▼] to select the display time, then press [OK].
- 4) Press [SETUP] to exit.

### Note

- Large-size JPEG files take a few moments to be displayed.

# SEARCH

## Title / Chapter Search



### Using [PREV ◀] / [NEXT ▶]

- 1) During playback, press [NEXT ▶] to skip the current title or chapter and move to the next.

The title or chapter will move forward by one at a time.

- If there is no chapter in one title, the current title will be skipped.

To go back to the beginning of the current title or chapter, press [PREV ◀].

Press it repeatedly to go to the previous title or chapter. The title or chapter will move backward one at a time.

### Using [INFO]

- 1) During playback, press [INFO].

- 2) Use [◀ / ▶] to select , then press [OK].

e.g.) DVD-video

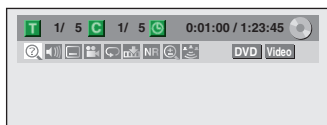

The number next to **T** will be highlighted.

### 3) Title:

Use [▲ / ▼] or [the Number buttons] to enter a desired title number to search, then press [OK].

Title search will start.

### Chapter:

Press [▶] to move to the number next to **C** for chapter.

Use [▲ / ▼] or [the Number buttons] to enter a desired chapter number to search, then press [OK].

After the search, playback will start automatically.

### Note

- In search mode display, total numbers of each search contents (title/chapter/time) are shown as a denominator.

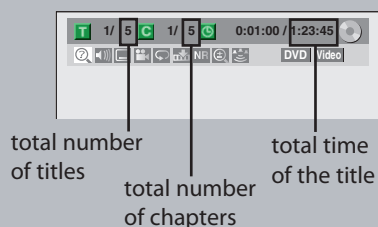

## Track Search



### Using [PREV ◀] / [NEXT ▶]

- 1) During playback, press [NEXT ▶] to skip the current track/file and move to the next.

The track/file will move forward one at a time.

To go back to the beginning of the current track/file, press [PREV ◀].

Press it repeatedly to go to the previous track/file. The track/file will move backward one at a time.

### Using [INFO]

- 1) During playback, press [INFO].

- 2) Use [◀ / ▶] to select , then press [OK].

e.g.) audio CD

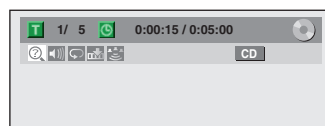

e.g.) MP3 files

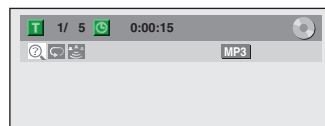

The number next to **T** will be highlighted.

- 3) Use [▲ / ▼] or [the Number buttons] to enter a desired track/file number to search, then press [OK].

After the search, playback will start automatically.

### Note

- During CD playback you can enter a track number directly using [the Number buttons] for track search without displaying the menu.

## Time Search



1) During playback, press [INFO].

2) Use [◀/▶] to select , then press [OK].

e.g.) DVD-video

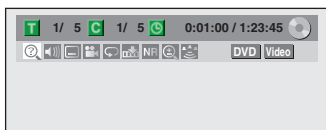

e.g.) audio CD

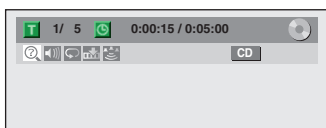

The number next to  will be highlighted.

To move to the number next to , press [▶].

When time search is not available,  and time counter are not displayed.

3) Use [▲ / ▼ / ◀ / ▶] or [the Number buttons] to enter a desired time to search, then press [OK].

After the search, playback will start automatically.

**Note**

- Time search is available only in the same track, file or title.

# SELECTING THE FORMAT OF AUDIO AND VIDEO

You can select the format of audio and video as you prefer depending on the contents of the disc you are playing back.

## Switching Subtitles



DVD-video may have subtitles in 1 or more languages. Available subtitle languages can be found on the disc case. You can switch subtitle languages anytime during playback.

1) During playback, press [INFO].

2) Use [◀/▶] to select , then press [OK] within 1 second or wait for 1 second to display the selection menu.

e.g.) DVD-video

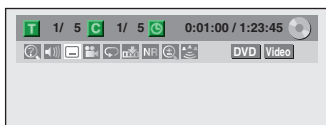

3) Use [▲/▼] to select a desired subtitle language, then press [OK].

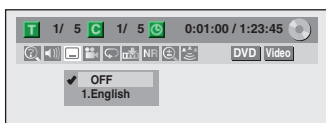

Subtitle will be displayed in the selected language. When selecting "OFF", subtitle will disappear.

### Note

- Some discs will only allow you to change the subtitle from the disc menu. Press [TITLE] or [DISC MENU] to display the disc menu.
- If a 4-digit language code appears in the subtitle menu, refer to the "LANGUAGE CODE" on page 112.
- For disc with DivX® files, the TV screen only displays the number of subtitle languages and "\_\_\_\_" next to the numbers.

## Switching Audio Soundtrack



When playing back a DVD-video recorded with 2 or more soundtracks (these are often in different languages), you can switch them during playback.

When playing back audio CD you can switch "L/R"(stereo), "L"(left) or "R"(right).

1) During playback press [INFO], then proceed to step 2), or press [AUDIO] then proceed to step 3).

2) Use [◀/▶] to select , then press [OK] within 1 second or wait for 1 second to display the selection menu.

3) Use [▲/▼] to select a desired audio soundtrack or audio channel, then press [OK].

For DVD-video, DivX® files

- Audio soundtrack will switch.

e.g.) DVD-video

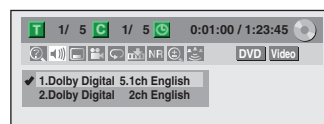

- If the title contains both main and sub audio, you can further select "L" (main), "R" (sub), or "L/R" (mixed of main and sub).

For audio CD

- Audio channel will switch.

e.g.) audio CD

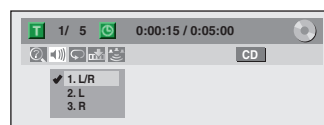

### Note

- Some discs will only allow you to change the soundtrack from the disc menu. Press [TITLE] or [DISC MENU] to display the disc menu.

# SELECTING THE FORMAT OF AUDIO AND VIDEO

## Switching Virtual Surround System



You can enjoy stereophonic virtual space through your existing 2 channel stereo system.

- 1) During playback, press [INFO].
- 2) Use [◀/▶] to select , then press [OK] within 1 second or wait for 1 second to display the selection menu.

e.g.) DVD-video

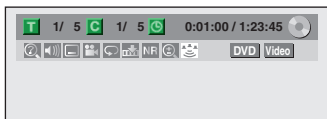

- 3) Use [▲/▼] to select "OFF", "Type 1" or "Type 2", then press [OK].

e.g.) DVD-video

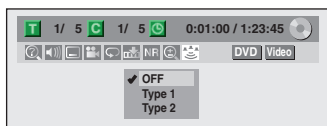

- OFF** : no effect  
**Type 1** : natural effect  
**Type 2** : emphasized effect

### Note

- Select "OFF" in a case sound is distorted.
- The setting will be kept even when the unit is turned off.

## Switching Camera Angles



Some DVD-video have scenes shot from 2 or more angles. Angle information should be on the disc case if the disc contains multi-angle scenes.

- 1) During playback, press [INFO].
- 2) Use [◀/▶] to select , then press [OK].

e.g.) DVD-video

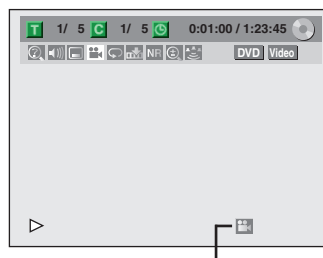

Angle icon appears when a switching camera angle is available.

Angle will switch each time you press [OK].

### Note

- Angle icon does not appear on the TV screen in a case you set "Angle Icon" to "OFF" in "Playback" menu. Refer to page 95.

## Reducing Block Noise



This function reduces noise in the playback picture.

- 1) During playback, press [INFO].
- 2) Use [◀/▶] to select **NR**, then press [OK] within 1 second or wait for 1 second to display the selection menu.

e.g.) DVD-video



- 3) Use [▲/▼] to select a desired option, then press [OK].

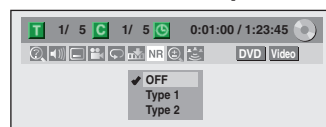

Your setting will be activated.

- OFF** : When playing back titles with a few noises such as DVD-video discs.
- Type 1** : For the titles recorded in long time mode such as SLP or SEP mode.
- Type 2** : Same as type 1, only more effective.

# INFORMATION ON DISC EDITING

## Guide to a Title List

Title list allows you to check the titles recorded on the disc easily. You can choose a title to play back from this list and easily edit the titles as you prefer.

Press [DVD], then press [TITLE].

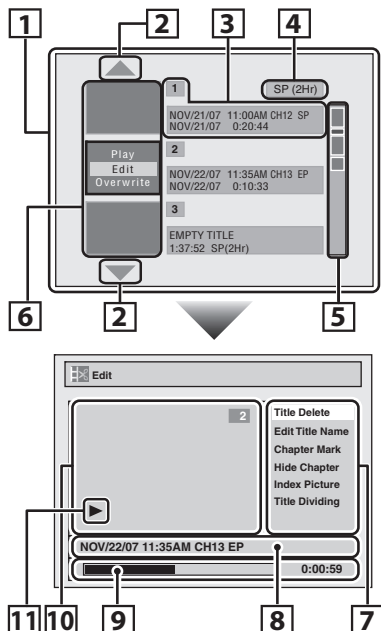

- 1. Title list:** List of the titles recorded on the disc, and their information.
- 2. Arrow:** Indicating there is a previous / next page.
- 3. Title information:** On the first line, title name (editable) is displayed. On the second line, the length of the title is displayed.  
**Empty title:** The portion of the disc where there is no recordings are made. As for the empty title, available recording time by the selected recording mode is displayed on the second line.
- 4. Recording mode:** Currently selected recording mode is displayed here.
- 5. Capacity indicator:** Indicating the position and the amount of each title in the disc. The portion for the selected title is highlighted.
- 6. Thumbnails:** A cut from the recorded content is displayed here.
- 7. Submenu:** Submenus for the selected menu are displayed here.
- 8. Title name (editable):** If you do not name the title, the recorded date, time, channel, and the recording mode are displayed here.
- 9. Progress bar:** Indicating the progress of the playback.
- 10. Preview window:** Preview of the selected title is displayed here.
- 11. Playback status:** Indicating the current playback status of the selected title.

Press [STOP ■] to exit the title list.

## Editing Discs

You can edit discs for the following items. Be sure that once you edit titles, they will not remain as original.

- Deleting Titles (Refer to page 77.)
- Putting Names on Titles (Refer to page 78.)
- Setting Chapter Marks (Refer to page 79.)
- Clearing Chapter Marks (Refer to pages 80-81.)
- Hiding Chapters (Refer to page 82.)
- Setting Pictures for Thumbnails (Refer to page 83.)
- Dividing a Title (DVD+RW/DVD-RW only) (Refer to page 84.)
- Putting Name on Disc (Refer to page 85.)
- Setting or Releasing Disc Protect (Refer to page 86.)
- Erasing Disc (Refer to page 87.)
- Making Edits Compatible (Refer to page 88.)

### Note

- When selecting "Edit" on pop-up menu of the title list and edit the title, the title list is displayed after writing the edited contents onto the disc.
- The capacity indicator in the right side of the title list may not indicate the precise capacity in the disc.
- The capacity indicator may not indicate the capacity for the titles of which recording time is short.
- Once you have finalized a DVD+R/ DVD-R, you cannot edit or record anything on that disc.

## Deleting Titles

You can delete titles which you do not need anymore. Please be advised that the titles once deleted cannot be brought back to the disc.

For DVD+RW/DVD-RW, when the last recorded title in the title list is deleted, the available disc space to record on will be increased. For DVD+R/DVD-R, the disc space to record on will not be changed.



**1** Press [DVD] first.  
Press [TITLE].

**2** Use [▲ / ▼] to select a desired title, then press [OK].

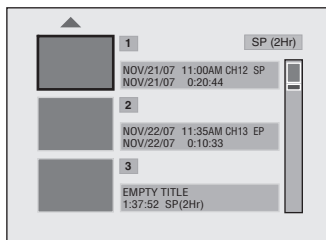

### Note

- Deleted part of the titles in the capacity indicator changes in color.
- As for DVD+RW/DVD-RW if you delete the title, deleted title will be displayed as "EMPTY TITLE".

**3** Use [▲ / ▼] to select "Edit", then press [OK].

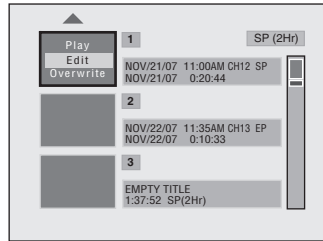

**4** Use [▲ / ▼] to select "Title Delete", then press [OK].

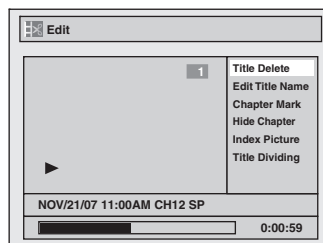

**5** Use [▲ / ▼] to select "Yes", then press [OK].

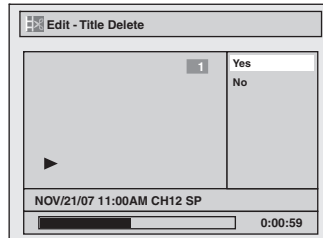

After that, "Are you sure?" will appear, select "Yes" and then press [OK].

Title will be deleted.

Data will be written onto the disc momentarily.



**This operation may take a while to be completed.**

After editing is complete, the title list will appear. e.g.) DVD+RW/DVD-RW

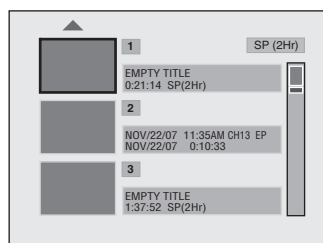

## Putting Names on Titles

You can put title names on the titles and change the names from this menu.



**1** Follow steps 1 to 3 in "Deleting Titles" on page 77 to display "Edit" menu.

**2** Use [▲ / ▼] to select "Edit Title Name", then press [OK].

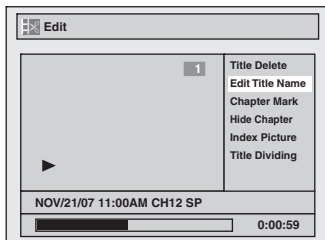

**3** To enter a title name, follow the steps of "Guide to Edit Title Name" on this page.

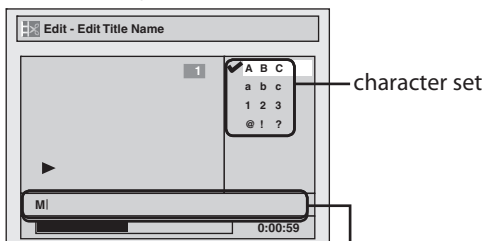

area for entering title names

When you finish entering a title name, press [OK].

**4** Use [▲ / ▼] to select "Yes", then press [OK].

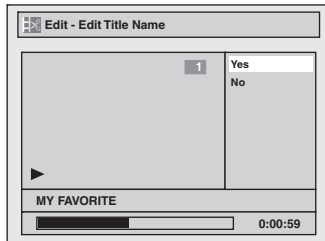

The name you entered will be activated for the title.

**5** After this operation is completed, press [BACK ↵] to exit. Data will be written onto the disc momentarily.

This operation may take a while to be completed.

### Guide to Edit Title Name

1) Use [▲ / ▼] to select a desired character set, then press [OK].

2) Follow the list below, use [the Number buttons] repeatedly until the desired letter appears.

Select Press	ABC	abc	123	@ ! ?
[0]	<space>	<space>	0	<space>
[1]	(*1)	(*1)	1	! " # \$ % & ' ( ) * + , - . / : ; < = > ? @ [ ] ^ _ {   }
[2]	ABC	abc	2	(*2)
[3]	DEF	def	3	(*2)
[4]	GHI	ghi	4	(*2)
[5]	JKL	jkl	5	(*2)
[6]	MNO	mno	6	(*2)
[7]	PQRS	pqrs	7	(*2)
[8]	TUV	tuv	8	(*2)
[9]	WXYZ	wxyz	9	(*2)

\*1 Press [1], character set will be changed to the "@!?" mode automatically.

\*2 Press [2] to [9], character set will be changed to the previous input mode automatically.

- To delete letters, press [CLEAR] repeatedly. Holding [CLEAR] to delete all letters.
- Use [◀ / ▶] to move the cursor to the left and right.
- You can enter up to 30 letters.

### Note

- Undefined letters in a title name are shown by "x". If you delete them, adjoining letters may change to "x" or other.



## Setting Chapter Marks

You can put chapter marks in each title. Once a chapter is marked, you can use it for the chapter search feature.



### Note

- When the number of chapter marks in a title is 99 and the number of chapter marks in a disc is 254, chapter marks cannot be added.
- Besides the above-mentioned, it is not likely to be able to add according to recorded time and number of chapters.
- Remaining time of the disc may decrease when adding chapter marks or increase when clearing chapter marks depending on the recording time or edited contents.

**1** Follow steps 1 to 3 in “Deleting Titles” on page 77 to display “Edit” menu.

**2** Use [▲ / ▼] to select “Chapter Mark”, then press [OK].  
Submenu will appear.

**3** Press [PLAY ►] and then [PAUSE ■] to decide the point at which you will create a new chapter mark.

- It is convenient to use [PREV ◀], [NEXT ▶], [REW ◀◀] and [FFW ▶▶] for finding the point to add a new chapter mark.

**4** Use [▲ / ▼] to select “Add”, then press [OK].

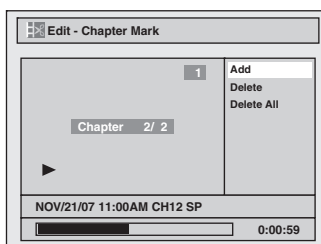

**5** Use [▲ / ▼] to select “Yes”, then press [OK].

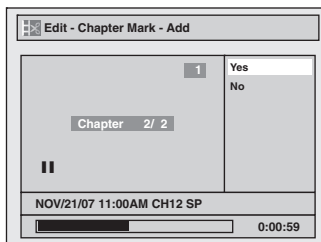

A new chapter mark will be added.

**6** Press [BACK ↵] twice to exit.  
Data will be written onto the disc momentarily.

**This operation may take a while to be completed.**

## Clearing Chapter Marks



- 1** Follow steps 1 to 3 in “Deleting Titles” on page 77 to display “Edit” menu.

---

  - 2** Use [▲ / ▼] to select “Chapter Mark”, then press [OK].  
Submenu will appear.

---

  - 3** Use [PREV ◀] / [NEXT ▶] to select a chapter mark to be deleted.

---

  - 4** Use [▲ / ▼] to select “Delete”, then press [OK].

---

  - 5** Use [▲ / ▼] to select “Yes”, then press [OK].
- 
- The selected chapter mark will be deleted.
- 
- 6** Press [BACK ↵] twice to exit.  
Data will be written onto the disc momentarily.
- This operation may take a while to be completed.**

### Note

- Remaining time of the disc may decrease when adding chapter marks or increase when clearing chapter marks depending on the recording time or edited contents.

## Clearing Chapter Marks (cont'd)



To delete all chapter marks:

- 1** Follow steps 1 to 3 in “Deleting Titles” on page 77 to display “Edit” menu.
- 2** Use [▲ / ▼] to select “Chapter Mark”, then press [OK].  
Submenu will appear.
- 3** Use [▲ / ▼] to select “Delete All”, then press [OK].
- 4** Use [▲ / ▼] to select “Yes”, then press [OK].
- 5** Use [▲ / ▼] to select “Yes”, then press [OK].

All chapter marks will be deleted.

- 6** Press [BACK ↵] twice to exit.  
Data will be written onto the disc momentarily.

**This operation may take a while to be completed.**

### Note

- Remaining time of the disc may decrease when adding chapter marks or increase when clearing chapter marks depending on the recording time or edited contents.

## Hiding Chapters

You can hide chapters from the title list.  
Hidden chapters are skipped during playback.



**1** Follow steps 1 to 3 in “Deleting Titles” on page 77 to display “Edit” menu.

**2** Use [▲ / ▼] to select “Hide Chapter”, then press [OK].  
Submenu will appear.

**3** Use [PREV ◀] / [NEXT ▶] to decide the chapter to be hidden.

**4** Use [▲ / ▼] to select “Hidden”, then press [OK].

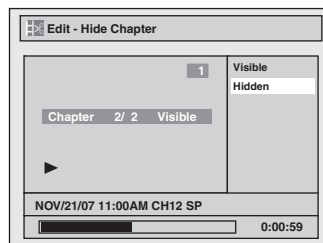

**5** After this operation is completed, press [BACK ↶] twice to exit.  
Data will be written onto the disc momentarily.

**This operation may take a while to be completed.**

If you want hidden chapters to be “Visible”, select the chapter to be shown. Then use [▲ / ▼] to select “Visible” at the step 4 on this page.

Data will be written onto the disc momentarily.  
After that, title list is displayed.

### Note

- “Hidden” will be displayed in the preview window while previewing the hidden chapter.
- When you make all chapters in the title “Hidden”, “Hidden” is displayed in a thumbnail of the title list.

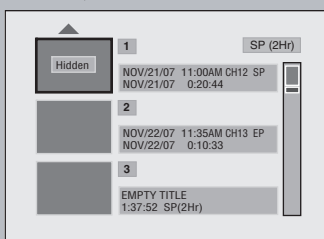

## Setting Pictures for Thumbnails

You can set your desired scene as a thumbnail for each title.



- 1** Follow steps 1 to 3 in “Deleting Titles” on page 77 to display “Edit” menu.
- 2** Use [PREV ◀], [NEXT ▶], [REW ◀◀], [FFW ▶▶], [PAUSE ||] and [PLAY ▶] to decide the picture you want to select as a thumbnail.
- 3** Use [▲ / ▼] to select “Index Picture”, then press [OK].
- 4** Use [▲ / ▼] to select “Yes”, then press [OK].

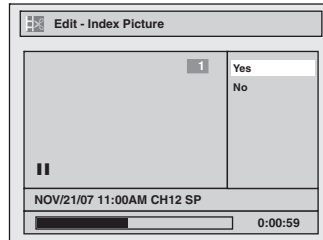

A picture for thumbnail will be set.

- 5** Press [BACK ↵] to exit.  
Data will be written onto the disc momentarily.

**This operation may take a while to be completed.**

### Note

- If the selected picture for a thumbnail is overwritten, the index picture is reset to the first scene of the title.

## Dividing a Title



You can divide one title into 2 new titles.



**1** Follow steps 1 to 3 in “Deleting Titles” on page 77 to display “Edit” menu.

**2** Use [PREV ◀], [NEXT ▶], [REW ◀◀], [FFW ▶▶], [PAUSE ||] and [PLAY ▶] to decide the point at which you will divide the title.

**3** Use [▲ / ▼] to select “Title Dividing”, then press [OK].

**4** Use [▲ / ▼] to select “Yes”, then press [OK].

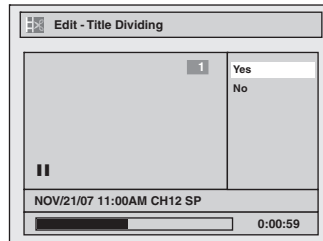

The title will be divided into 2 new titles. Both title names are identical, and index pictures are reset to the first scene at this point.

Data will be written onto the disc momentarily.

**This operation may take a while to be completed.**

### Note

- You cannot divide a title of the disc when the number of recording titles reaches the maximum of 49, and the number of recording chapters reaches the maximum of 254.

## Putting Name on Disc

You can put a name on the disc and change it from this menu.



Press **[STOP ■]** if you are playing back a disc.

**1** Press **[SETUP]**.

**2** Use **[▲ / ▼]** to select **"Disc Edit"**, then press **[OK]**.

**3** Use **[▲ / ▼]** to select **"Edit Disc Name"**, then press **[OK]**.  
e.g.) DVD+RW

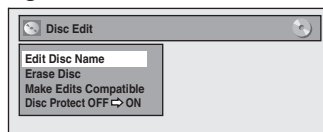

A window for entering a title name will appear.

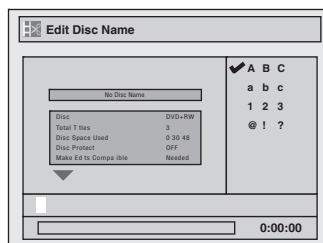

**4** To enter a disc name, follow the steps of **"Guide to Edit Title Name"** on page 78.

When you finish entering a title name, press **[OK]**.

**5** Use **[▲ / ▼]** to select **"Yes"**, then press **[OK]**.

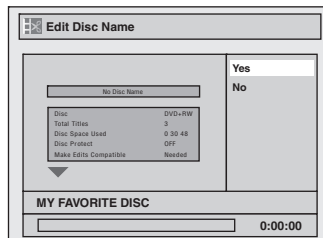

The name you entered will be activated for the title. Data will be written onto the disc momentarily.

**This operation may take a while to be completed.**

### Note

- You cannot select "Disc Edit" when finalized DVD+R or DVD-R is inserted.

## Setting or Releasing Disc Protect

To prevent accidental editing, or erasing the titles, you can protect them.



**1** Follow steps 1 to 2 in “Putting Name on Disc” on page 85 to display “Disc Edit” menu.

**2** Use [▲ / ▼] to select “Disc Protect OFF → ON”, then press [OK].  
e.g.) DVD+RW

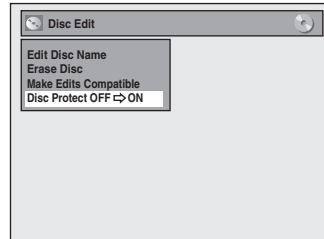

- If the disc is already protected, “Disc Protect ON → OFF” will appear instead of “Disc Protect OFF → ON”.

**3** Use [▲ / ▼] to select “Yes”, then press [OK].

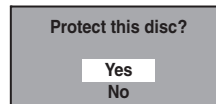

Data will be written onto the disc momentarily.

**This operation may take a while to be completed.**



## Erasing Disc



You can erase all titles on a disc.



Press **[STOP ■]** if you are playing back a disc.

**1** Follow steps 1 to 2 in “Putting Name on Disc” on page 85 to display “Disc Edit” menu.

**2** Use **[▲ / ▼]** to select “Erase Disc”, then press **[OK]**.  
e.g.) DVD+RW

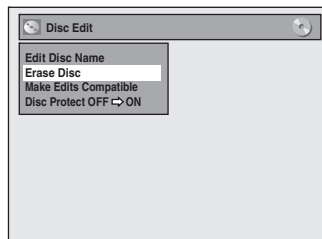

**3** Use **[▲ / ▼]** to select “Yes”, then press **[OK]**.

When you press “Yes”, all the contents in the disc will be erased.  
Are you sure to erase the disc?

Yes  
No

Data will be written onto the disc momentarily.

**This operation may take a while to be completed.**

### Note

- When you select “Yes” at step 3, all contents of the disc will be erased.

## Making Edits Compatible



If you have added or deleted chapters, or made chapters hidden, you must perform "Make Edits Compatible" to see those effects on other unit.



Press **[STOP ■]** if you are playing back a disc.

**1** Follow steps 1 to 2 in "Putting Name on Disc" on page 85 to display "Disc Edit" menu.

**2** Use **[▲ / ▼]** to select "Make Edits Compatible", then press **[OK]**.

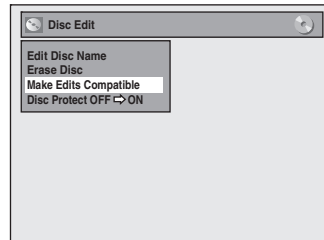

**3** Use **[▲ / ▼]** to select "Yes", then press **[OK]**.

Activate the Make Edits Compatible?

Yes  
No

Data will be written onto the disc momentarily.

**This operation may take a while to be completed.**

# LIST OF SETTINGS

The following table is the contents which you can set and the default setting.  
Refer to the following table for useful operation.

Setup	Items (highlight is the default)	Contents		
General Setting Playback → Pages 92-95	Parental Lock	OFF level 8 [Adult] to 1 [Kid Safe]	Set the parental level for DVD playback.	
	Disc Audio	Dynamic Range Control	ON OFF	Compressing the range of sound volume.
		PCM	48kHz 96kHz	Set whether the sound recorded in 96kHz will be down sampled in 48kHz.
		Dolby Digital	PCM Stream	Set the type of sound signal which outputs from the digital audio output jack.
	Disc Menu Language	English French Spanish Other	Set the language for disc menu language.	
	Audio Language	Original English French Spanish Other	Set the language for audio.	
	Subtitle Language	OFF English French Spanish Other	Set the language for subtitles.	
	Angle Icon	ON OFF	Set whether or not to display the angle icon.	
	Still Mode	Auto Field Frame	Set the type of still image in pausing playback.	
	General Setting Display → Pages 96-97	OSD Language	English Français Español	Set the language for OSD (on-screen display).
Screen Saver		OFF 5minutes 10minutes 15minutes 30minutes	Set the idling time before the screen saver starts.	
FL Dimmer		Auto Bright Dark	Set the brightness of the front panel display.	
CC Style → Pages 35-37		DTV CC	OFF Service1 Service2 Service3 Service4 Service5 Service6	Set the type of the DTV closed caption.
		User Setting	ON OFF	Set the whether or not CC style setting is effective.
		Font Size	Middle Large Small	Set font size of the displayed caption.
		Font Style	Style1 Style2 Style3 Style4 Style5 Style6 Style7 Style8	Set font style of the displayed caption.

Introduction

Connections

Basic Setup

Recording

Playback

Editing

Function Setup

VCR Functions

Others

# LIST OF SETTINGS

Setup	Items (highlight is the default)			Contents	
General Setting	Display → Pages 96-97	CC Style → Pages 35-37	Edge Type	None Raised Depressed Uniform L.Shadow R.Shadow	Set edge type of the displayed caption.
			Font Opacity	Solid Translucent Flash	Set the font opacity of the displayed caption.
			Font Color	Transparent White Black Red Green Blue Yellow Magenta Cyan	Set the font color of the displayed caption.
		Back Opacity	Solid Translucent Flash	Set back opacity of the displayed caption.	
		Back Color	Transparent White Black Red Green Blue Yellow Magenta Cyan	Set back color of the displayed caption.	
		V-Chip	Downloadable Rating Change Password	Set the downloadable rating.	
	Video → Pages 98-99	Progressive Scan		ON OFF	Set to the progressive scan mode (set to "ON") or to the interlace scan mode (set to "OFF").
		TV Aspect		4:3 Letter Box 4:3 Pan & Scan 16:9 Wide	Set a picture size according to aspect ratio of your TV.
		Video Input → Page 48	E1(Rear)	Video In S-Video In	Set the video input type for the external input.
	E2(Front)		Video In S-Video In		
Recording	Auto Chapter → Page 39		OFF 5 minutes 10 minutes 15 minutes 30 minutes 60 minutes	Insert chapter marks at even time interval.	
	Auto Finalize → Page 57	Disc Full	ON OFF	Set the unit to finalize the disc automatically.	
		End of Timer Rec	ON OFF		
	Dubbing Mode → Pages 53-54		VCR → DVD DVD → VCR	Set the dubbing direction.	
Make Recording Compatible → Page 39		ON OFF	Set to prohibiting additional recording (OFF) or to replace the title list after recording (ON).		
Clock → Pages 30-31	Clock Setting			Set the clock.	
	Auto Clock Setting		OFF Auto Manual	Set the clock automatically.	
	Daylight Saving Time		ON(MAR-NOV) ON(APR-OCT) OFF	Set the clock for the daylight saving time.	

# LIST OF SETTINGS

Setup	Items (highlight is the default)	Contents		
General Setting	Channel → Pages 27-29	Auto Channel Preset	Antenna Cable (Analog) Cable (Analog/Digital)	Tune the channels automatically.
		Manual Channel Preset TV Audio Select → Pages 33-34	Stereo SAP	Tune the channels manually. Set the analog TV audio type for output and recording.
	DivX → Page 100	DivX®VOD	OFF	Provide DivX®VOD registration code.
		DivX Subtitle	English French Spanish German Italian Swedish Dutch Russian1 Russian2 Hungarian Polish Czech	Set the language for DivX® Subtitle.
	HDMI → Pages 101-102	Format	RGB YCbCr	Set the color space for the HDMI output.
		HDMI Audio	ON OFF	Set whether or not to output the HDMI audio signal.
		RGB Range	Normal Enhanced	Set the black-white contrast level for HDMI RGB output.
	Reset All → Page 103	Yes No	Set to the default setting.	

Introduction

Connections

Basic Setup

Recording

Playback

Editing

Function Setup

VCR Functions

Others

## Note

- Your change to each settings stays on even when the power is off.
- An item which is not currently available is grayed in the settings.

# SETUPS

## Playback



Press [STOP ■] if you are playing back a disc.

**1** Press [SETUP] and use [▲ / ▼] to select "General Setting", then press [OK].  
"General Setting" menu will appear.

**2** Use [▲ / ▼] to select "Playback", then press [OK].

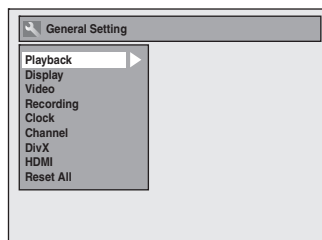

**3** Use [▲ / ▼] to select a desired item, then press [OK].

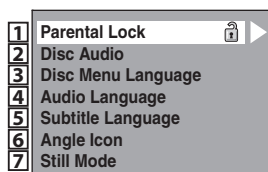

Submenu will appear.

**4** Refer to **1** to **7** on pages 93-95 and set the selected item.

**5** When you finish with setting, press [SETUP] to exit.

## Playback (cont'd)

### 1 Parental Lock (Default: OFF)

Some DVD-video feature a parental lock level. Playback will stop if the ratings exceed the levels you set, it will require you to enter a password before the disc will playback. This feature prevents your children from viewing inappropriate material.

Use [▲ / ▼] to select the desired level, then press [OK].

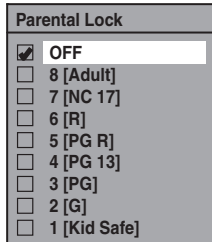

If a password has not been set yet, proceed to **A**.

If a password has been set already, proceed to **B**.

#### Note

- Parental lock function may not be available to some discs.
- With some DVD, it may be difficult to find if they are compatible with parental lock. Be sure to check if the parental lock function operates in the way that you have set.
- Record the password in case you forget it.
- If there is a DVD in the unit when you set up the parental lock, press [OPEN/CLOSE ▲] to activate the parental lock level.

**A** A password has not been set yet.

Use [▲ / ▼] to select "Yes". Use [the Number buttons] to enter a new password except for 4737, then press [OK].

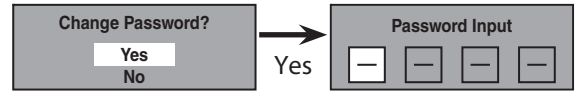

Your setting will be activated.

**B** A password has been set already.

• Use [the Number buttons] to enter the current password.



Your setting will be activated.

• If you want to change password, use [▲ / ▼] to select "Yes". Use [the Number buttons] to enter a new password, then press [OK].

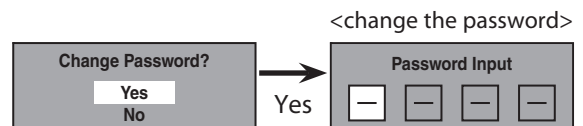

Your setting will be activated.

#### Note

- Press [CLEAR] to erase numbers entered incorrectly.
- When you forget the password or you want to clear all settings in "Parental Lock" menu, enter 4,7,3,7 using [the Number buttons] in password input window. Password will be cleared and parental levels will be set to "OFF".

## Playback (cont'd)

### 2 Disc Audio

Choose the appropriate audio setting for your external device.

**It will only affect a disc playback.**

Use [▲ / ▼] to select a desired item, then press [OK].

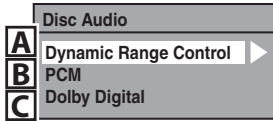

#### A Dynamic Range Control (Default : ON)

Set to "ON" to compress the range between soft and loud sounds.

Use [▲ / ▼] to select a setting, then press [OK].

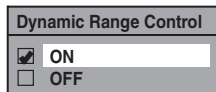

Your setting will be activated.

#### Note

- Dynamic range control function is available only on the discs which are recorded in the Dolby Digital format.

#### B PCM (Default : 48kHz)

Use [▲ / ▼] to select a setting, then press [OK].

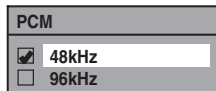

Your setting will be activated.

**48kHz** : If your amplifier/decoder is NOT compatible with 96kHz PCM, select "48kHz". 96kHz sound will be output in 48kHz.

**96kHz** : If your amplifier/decoder is compatible with 96kHz PCM, select "96kHz". 96kHz sound will be output.

#### Note

#### When playing back disc with copyright protection

- Even if you select "96kHz", the sound will be down sampled at 48kHz.

#### C Dolby Digital (Default : Stream)

Use [▲ / ▼] to select a setting, then press [OK].

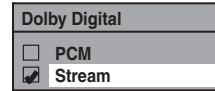

Your setting will be activated.

**PCM** : Converts the Dolby Digital into PCM (2 channel). When your amplifier/decoder is NOT compatible with Dolby Digital, set to "PCM".

**Stream** : Outputs Dolby Digital signals. When your amplifier/decoder is compatible with Dolby Digital, set to "Stream".



## Playback (cont'd)

### 3 Disc Menu Language (Default : English)

Set the language for disc menu.

Use **[▲ / ▼]** to select a setting, then press **[OK]**.

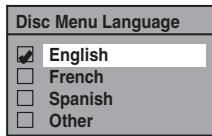

Your setting will be activated.

### 4 Audio Language (Default : Original)

Set the audio language.

Use **[▲ / ▼]** to select a setting, then press **[OK]**.

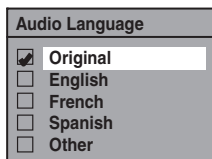

Your setting will be activated.

- When "Original" is selected, the audio language will be in the disc's default language.

### 5 Subtitle Language (Default : OFF)

Set the subtitle language.

Use **[▲ / ▼]** to select a setting, then press **[OK]**.

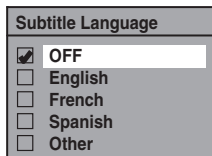

Your setting will be activated.

If "Other" is selected for **3** to **5**, press 4-digit code using **[the Number buttons]**.

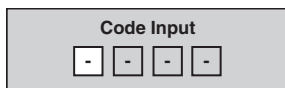

- When you finish entering the code, press **[OK]**. Refer to the language code table on page 112.

#### Note

- Only the languages supported by the disc can be selected.
- Audio language setting may not be available to some discs.
- You can change or switch off the subtitles on a DVD also from the disc menu if it is available.
- Press **[CLEAR]** or **[◀]** to erase numbers entered incorrectly.

### 6 Angle Icon (Default : ON)

Set to "ON" to show the angle icon during the playback.

Use **[▲ / ▼]** to select a setting, then press **[OK]**.

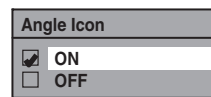

Your setting will be activated.

### 7 Still Mode (Default : Auto)

Select "Auto" usually.

Use **[▲ / ▼]** to select a setting, then press **[OK]**.

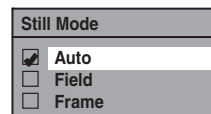

Your setting will be activated.

**Auto** : Optimum resolution setting ("Field" or "Frame") will be selected.

**Field** : Images in the still mode will be stabilized.

**Frame** : Images in the still mode will be highly defined.

#### Note

- Frame is 1 completed video image made up of 2 fields (There are 30 frames per second of NTSC video).

## Display



Press [STOP ■] if you are playing back a disc.

**1** Press [SETUP] and use [▲ / ▼] to select "General Setting", then press [OK].

**2** Use [▲ / ▼] to select "Display", then press [OK].

**3** Use [▲ / ▼] to select a desired item, then press [OK].

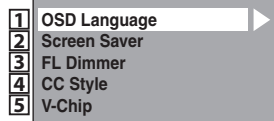

Selection menu will appear.

**4** Refer to **1** to **5** on page 97 and set the selected item.

• For **4** refer to pages 35-37.

**5** When you finish with setting, press [SETUP] to exit.

## Display (cont'd)

### 1 OSD Language (Default : English)

Set the language for the on-screen display.

Use **[▲ / ▼]** to select a setting, then press **[OK]**.



Your setting will be activated.

### 2 Screen Saver (Default : 10 minutes)

Set the time to activate the screen saver function on the TV screen.

Use **[▲ / ▼]** to select a setting, then press **[OK]**.

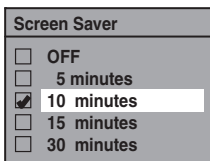

Your setting will be activated.

### 3 FL Dimmer (Default: Bright)

Set the front panel display brightness.

Use **[▲ / ▼]** to select a setting, then press **[OK]**.

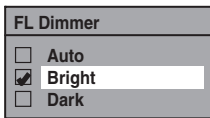

You can choose one from "Auto", "Bright" and "Dark". If "Auto" is selected, the display gets dark when the power is off.

### 5 V-Chip

You can set the viewing limitation for the digital TV programs to prevent your children from watching inappropriate programs.

**This feature is available only after the digital TV ratings have been downloaded**

- The ratings can be downloaded by the unit automatically if it is available in your area.

**1) Use [the Number buttons] to enter the access password.**

If you have not set the password, first, use **[the Number buttons]** to set the access password, then press **[OK]**. The number you entered will be stored as the access password.



**2) Use [▲ / ▼] to select a desired item, then press [OK].**

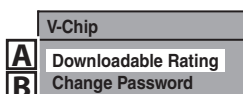

### A Downloadable Rating

Set the rating system via digital broadcasting, or clear the downloaded ratings.

**If the broadcasting signal does not have the downloadable rating information, the message below will appear.**

Downloadable Rating is currently not available.

- This message will also appear when you try to access "DOWNLOADABLE RATING" after you have cleared the downloadable rating information, and the new information has not been downloaded since.

**To set the rating:**

Use **[▲ / ▼]** to select "BLOCK SETTING" then press **[OK]** to show the various types of ratings. Use **[▲ / ▼]** to select a desired rating to set, then press **[OK]** to show the levels for the rating. Use **[▲ / ▼]** to select a level, then press **[OK]** to switch "VIEW" or "BLOCK". If you set one level to "BLOCK", all the higher levels will be turned to "BLOCK" automatically.

**To clear the downloadable rating information and its setting:**

Use **[▲ / ▼]** to select "CLEAR DOWNLOADABLE RATING", then press **[OK]**.

### B Change Password

Change the current password.

**Use [the Number Buttons] to enter new access password.**

#### Note

- When you forget the access password at step 1), enter 4,7,3,7 using **[the Number buttons]** in the password input window. Password will be cleared.
- Depending on the type of rating system, you may set the levels individually.



Press [STOP ■] if you are playing back a disc.

**1** Press [SETUP] and use [▲ / ▼] to select "General Setting", then press [OK].

**2** Use [▲ / ▼] to select "Video", then press [OK].

**3** Use [▲ / ▼] to select a desired item, then press [OK].

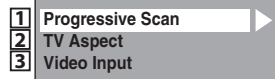

Submenu will appear.

**4** Refer to **1** to **2** on page 99 and set the selected item.

• For **3** refer to page 48.

**5** When you finish with setting, press [SETUP] to exit.

## Video (cont'd)

### 1 Progressive Scan (Default : OFF)

This unit is compatible with the progressive scan system. The feature provides you with the higher definition images than the traditional output system does. To utilize this feature, you must set progressive scan mode to "ON".

1) Use [▲ / ▼] to select "ON", then press [OK].

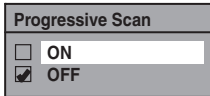

2) Use [◀ / ▶] to select "Yes", then press [OK].

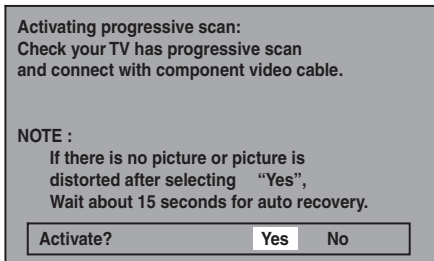

3) Use [▲ / ▼] to select "Yes" within 15 seconds, then press [OK].

Your setting will be activated.

#### Note

- If your TV is compatible with progressive scan (525p / 480p), you are recommended to use the HDMI or component video cable (commercially available) to connect this unit to the TV. (Refer to "Method 2" or "Method 3" on page 18.) If not, use the RCA video cable and set the progressive scan to "OFF" or press and hold [SETUP] for more than 3 seconds during DVD playback.
- When selecting "No" or not pressing any buttons on the unit or remote control within 15 seconds at step 3, progressive scan remains to be "OFF" (interlace scan).

### 2 TV Aspect (Default: 4:3 Letter Box)

You can select the TV aspect ratio to match the formats of what you are playing back with the unit and your TV screen (4:3 standard or 16:9 widescreen TV).

Use [▲ / ▼] to select a setting, then press [OK].

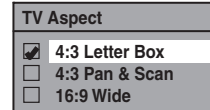

**If you have a standard TV:**

Select "4:3 Letter Box", so that black bars appear on the top and bottom of the TV screen when playing back a wide-screen picture. Select "4:3 Pan & Scan" for a full height picture with both sides trimmed when playing back wide-screen picture.

**If you have a widescreen TV:**

Select "16:9 Wide".



**1** Press [SETUP] and use [▲ / ▼] to select "General Setting", then press [OK].

"General Setting" menu will appear.

**2** Use [▲ / ▼] to select "DivX", then press [OK].

**3** Use [▲ / ▼] to select a desired item, then press [OK].



**4** Refer to **1** and **2** on this page and set the selected item.

**5** When you finish with setting, press [SETUP] to exit.

## 1 DivX® VOD

This unit allows you to play back the files purchased or rented from DivX® VOD (video-on-demand) services. The files are available on the internet. When you purchase or rent DivX® VOD files on the internet, you will be asked to enter an activation/registration code. This menu item provides you with the activation/registration code.

On how to activate this unit for the DivX® VOD file playback, visit [www.divx.com/vod](http://www.divx.com/vod).



## 2 DivX Subtitle (Default : OFF)

Set the DivX® subtitle.

Use [▲ / ▼] to select a setting, then press [OK].

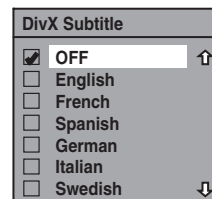

Your setting will be activated.

### Note

- Only the languages supported by the disc can be selected.
- Audio language setting may not be available to some discs.
- You can change or switch off the subtitles on a DVD also from the disc menu if it is available.
- One registration code is only valid for one DivX® VOD file.
- The registration code will be displayed in 8 characters which consist of numbers between 0 to 9 and capital letters chosen randomly.
- You must first download the file from the internet and play it back on this unit before you are able to get another code.
- You must follow this step every time you purchase or rent a DivX® VOD file from the internet.
- For more information for DivX®, please visit <http://www.divx.com/vod>.



**1** Press [SETUP] and use [▲ / ▼] to select "General Setting", then press [OK].

"General Setting" menu will appear.

**2** Use [▲ / ▼] to select "HDMI", then press [OK].

**3** Use [▲ / ▼] to select a desired item, then press [OK].

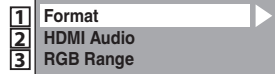

**4** Refer to **1** to **3** on page 102 and set the selected item.

**5** When you finish with setting, press [SETUP] to exit.

## HDMI (cont'd)

### 1 Format (Default : RGB)

You can select the color space for HDMI output.  
Set the appropriate color space for your display device.

**Use [▲ / ▼] to select a setting, then press [OK].**

- When the connected device is not compatible with the Y/Cb/Cr, HDMI signal is output as RGB regardless of the setting.

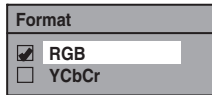

Your setting will be activated.

### 2 HDMI Audio (Default : ON)

If you do not want to output the audio through HDMI (when you digitally output the audio through the COAXIAL DIGITAL AUDIO OUT jack to your audio system, etc.), you can set the HDMI audio output off.

**Use [▲ / ▼] to select a setting, then press [OK].**

- Set to "OFF" when not outputting the HDMI sound.

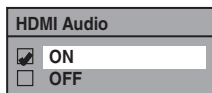

Your setting will be activated.

### 3 RGB Range (Default : Normal)

You can adjust the RGB range to make the dark areas of the HDMI images brighter.

**Use [▲ / ▼] to select a setting, then press [OK].**

- Select "Enhanced" if the black-white contrast is not clear.
- This setting is effective only for HDMI RGB output.

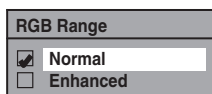

Your setting will be activated.



## Reset All

Reset the setting to default.



**1** Press [SETUP] and use [▲ / ▼] to select "General Setting", then press [OK].  
"General Setting" menu will appear.

**2** Use [▲ / ▼] to select "Reset All", then press [OK].

**3** Select "Yes" using [▲ / ▼], then press [OK].

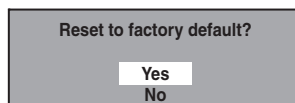

**4** Select "Yes" again using [▲ / ▼], then press [OK].

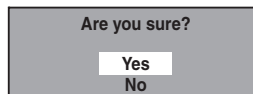

Your setting in recording will be initialized.

### Note

- The settings listed below will remain unchanged even after resetting to the factory default.
- OSD language setting
- Channel setting
- Clock setting
- Parental lock setting
- V-Chip setting
- Timer programming information
- DivX® registration code

# VCR FUNCTIONS

## Playback



Press [VCR] first.

- 1) Insert a prerecorded tape (refer to page 25 on how to insert a cassette tape).
- 2) Press [PLAY ►] to start playback.
- 3) Press [STOP ■] to stop playback.

### To pause playback:

Press [PAUSE II].  
Playback will pause and sound will be muted.

### To resume playback:

Press [PLAY ►].

### Note

- When a cassette tape without erase-protection tab is inserted, the unit will start playback automatically.
- Tracking will be automatically adjusted upon playback. To adjust the tracking manually, press [CH + / -] on the remote control.
- S-VHS cassette tape is not available on this unit.

## Recording



Press [VCR] first.

- 1) Insert a recordable tape with an erase-protection tab intact.

### Accidental erasure prevention

To prevent accidental recording on a recorded cassette tape, remove its erase-protection tab. To record on it later, cover the hole with cellophane tape.

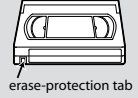

- 2) Select the recording mode using [REC MODE].

- The desired recording mode is selected in SP (standard play) or SLP (super long play) mode by pressing [REC MODE].

### Recording mode:

Tape speed	Recording / playback time		
Type of tape	T60	T120	T160
SP mode	1 hour	2 hours	2-2/3 hours
SLP mode	3 hours	6 hours	8 hours

- 3) Select stereo or SAP. Refer to page 34.

- 4) Select the desired channel to record using [CH + / -] or [the Number buttons].

- 5) Press [REC ●] to start recording.

Press [STOP ■] to stop the recording.

### To pause recording:

Press [PAUSE II].

### To resume recording:

Press [PAUSE II] or [REC ●].

After the unit has been in pause mode for 5 minutes, it will stop automatically to protect the tape and the video head from damage.

- Refer to pages 42-45 for instructions on timer recording.

## One-touch Timer Recording (OTR)



This feature allows you to set the recording length simply by pressing [REC ●] on the remote control.

Press [VCR] first.

- 1) Insert a recordable tape with an erase-protection tab intact.
- 2) Select the recording mode using [REC MODE].  
(Refer to "Recording" on page 104.)
- 3) Select stereo or SAP. Refer to page 34.
- 4) Select the desired channel to record using [CH + / -] or [the Number buttons].
- 5) Press [REC ●] to begin the one-touch timer recording.

You can select a fixed recording time by pressing [REC ●] repeatedly.



When the one-touch timer recording is finished, the unit will turn off automatically.

To change the recording length during the one-touch timer recording:

Press [REC ●] repeatedly until the desired length appear.

To cancel the one-touch timer recording within the specified time:

Press [STOP ■].

### Note

- The remaining recording time will be displayed on the front panel display during one-touch timer recording. Press [INFO] to see it on the TV screen.
- **You cannot pause the one-touch timer recording.**
- If VCR one-touch timer recording is completed during DVD playback or recording, the VCR will be in stop mode and the DVD keeps the current mode.
- Unlike a timer recording, you can perform the following operations during the one-touch timer recording.
  - Turning off the power to stop one-touch timer recording.
  - Using [REC ●].
- When the one-touch timer recording is finished and the power is turned off, the unit will switch to the timer standby mode automatically if a timer recording has been programmed. Press [TIMER SET] to cancel the timer standby mode for using the unit continuously.

## Index Search



An index mark will be assigned at the beginning of each recording you make. You may skip to a specific marked point by following the steps below.

Press [VCR] first.

- 1) Press [SEARCH] so that "INDEX SEARCH" menu appears.
- 2) Using [the Number buttons], enter the number of recordings you wish to skip within 30 seconds.

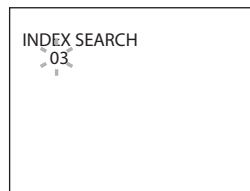

3) Press [REW ◀◀], [FFW ▶▶] to start index search.

If you want to go in the forward direction, press [FFW ▶▶].

If you want to go in the reverse direction, press [REW ◀◀].

After index search, the VCR will play back the cassette tape automatically.

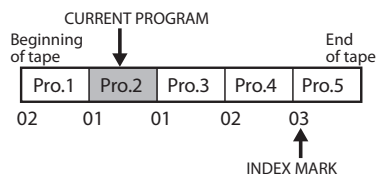

### Note

- You can make the index mark up to 20.

# VCR FUNCTIONS

## Time Search



This feature allows you to go to a specific point on a cassette tape by entering the exact amount of time you wish to skip in order to reach the point.

### Press [VCR] first.

1) Press [SEARCH] repeatedly so that "TIME SEARCH" menu appears.

2) Using [the Number buttons], enter your desired time to skip within 30 seconds.

You can set the time up to 9:59.

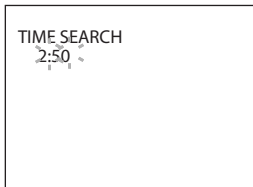

3) Press [REW ◀◀], [FFW ▶▶] to start time search.

If you want to go in the forward direction, press [FFW ▶▶].

If you want to go in the reverse direction, press [REW ◀◀].

After time search, the unit will play back the cassette tape automatically.

### Note

- Index search and time search are not available during recording.
- Press [STOP ■] to stop the search.
- If the end of the cassette tape is reached during search, this unit will cancel the search and rewind the cassette tape.

## Other Operations



### Press [VCR] first.

#### Fast forward:

When the unit is in stop mode, press [FFW ▶▶] to fast forward the cassette tape.

#### Rewind:

When the unit is in stop mode, press [REW ◀◀] to rewind the cassette tape.

#### To cue or review picture during playback (picture search):

Press [REW ◀◀], [FFW ▶▶] during playback.

Press it again and the unit will search in super high speed. (in the SLP mode only)

#### To freeze the picture on TV screen during playback (still mode):

Press [PAUSE ■]. Each time you press the button, the picture will be forwarded by one frame.

If the picture begins to vibrate vertically during the still mode, stabilize the picture by pressing [CHANNEL + / -] on remote control.

If the picture is distorted or rolling vertically, adjust the vertical hold control on your TV, if equipped.

#### Counter reset:

Press [CLEAR] to reset the counter to "0:00:00".

#### To playback in slow motion:

Press [PAUSE ■] during playback, then press [FFW ▶▶].

Press [FFW ▶▶] or [REW ◀◀] repeatedly to select the desired speed.

#### Automatic rewind:

When a cassette tape is played back or fast forwarded to its end, the cassette tape will rewind to the beginning, stop and eject itself.

#### When you playback a cassette tape recorded in Hi-Fi stereo:

Press [AUDIO] on the remote control to select Hi-Fi or MONO for playback sound mode.

- If you have connected a stereo TV to this unit, select "HIFI".
- If you have connected a monaural TV to this unit, select "MONO".

Your Selection Type of recorded tape	HIFI		MONO
	L-channel	R-channel	
non Hi-Fi tapes	Monaural	Monaural	Monaural
Hi-Fi tapes recorded in Hi-Fi stereo	L	R	L+R
Hi-Fi tapes recorded main audio program	Main audio program	Main audio program	Main audio program
Hi-Fi tapes recorded second audio program	Second audio program	Second audio program	Second audio program

### Note

- Still/slow mode will stop after 5 minutes to prevent damage to the cassette tape and the video head.
- To return to playback from the picture search/still/slow mode, press [PLAY ▶].

# TROUBLESHOOTING

Before requesting service for this unit, check the table below for a possible cause of the problem you are experiencing. Some simple checks or a minor adjustment on your part may eliminate the problem and restore proper operation.

Symptom	Remedy
The power does not turn on.	<ul style="list-style-type: none"> <li>• Check that the AC power cord is connected securely.</li> <li>• Check the breaker (in case of power failure).</li> <li>• Press <b>[TIMER SET]</b> to cancel the timer standby mode.</li> </ul>
There is no picture.	<ul style="list-style-type: none"> <li>• Re-connect the connecting cords securely.</li> <li>• Check if the connecting cords are damaged.</li> <li>• Check the connection to your TV (page 18).</li> <li>• Switch the input selector on your TV (such as to "E1") so that the signal from the unit appears on the TV screen.</li> </ul>
TV program reception does not fill the TV screen.	<ul style="list-style-type: none"> <li>• Try to set the channels with "Auto Preset" or "Manual Preset" in "Channel" menu (pages 27-29).</li> <li>• Select a channel of any TV program using <b>[CH + / -]</b>.</li> </ul>
TV program pictures are distorted.	<ul style="list-style-type: none"> <li>• Adjust TV antenna.</li> <li>• Adjust the picture. (Refer to the TV's instruction manual.)</li> <li>• Place the unit and TV farther apart.</li> <li>• Place the TV and any bunched RF coaxial cables farther apart.</li> </ul>
TV channels cannot be changed.	<ul style="list-style-type: none"> <li>• Switch the input to TV.</li> <li>• Connect the RF coaxial cable correctly (pages 15-17).</li> </ul>
There is no sound or the sound is distorted.	<ul style="list-style-type: none"> <li>• Re-connect all connections securely.</li> <li>• Check if the connecting cord is damaged.</li> <li>• Check the connections to the amplifier input.</li> <li>• Check if the input device setting on the amplifier is correct.</li> <li>• When the unit is in pause mode or in slow-motion playback mode, sound is not output. This is not a malfunction.</li> <li>• When the unit is in fast forward or fast reverse mode, sound is not output. This is not a malfunction.</li> <li>• If using the HDMI connection, sound is not output when "HDMI Audio" is set to "OFF".</li> <li>• Check the RCA audio cable connection. If you are using HDMI-DVI conversion cable, you must connect the RCA audio cable, too.</li> <li>• If using the HDMI connection, check whether the output format of this unit (HDMI FORMAT) matches the supported input format of other connected device.</li> </ul>
The remote control does not function.	<ul style="list-style-type: none"> <li>• Batteries are weak.</li> <li>• There are obstacles between the remote control and the unit.</li> <li>• The remote control is far from the unit.</li> <li>• There are no batteries in the remote control.</li> <li>• Check if the unit is turned on.</li> <li>• Check if you are pointing the remote control at the recorder and NOT the TV.</li> </ul> <p>If you have a plasma TV, it may interfere with the IR signal. Try the remote with the plasma off. If the remote works, you may need to move the unit away from the plasma TV.</p> <ul style="list-style-type: none"> <li>• Press <b>[DVD]</b> or <b>[VCR]</b>, whichever you need. Then, try again.</li> <li>• Press <b>[TIMER SET]</b> to cancel the timer standby mode.</li> </ul>
The unit does not operate properly.	<ul style="list-style-type: none"> <li>• When static electricity, etc., causes the unit to operate abnormally, unplug the unit and then plug it in again.</li> </ul>
No analog TV closed captions are output.	<ul style="list-style-type: none"> <li>• If you are using HDMI connection to watch the TV programs through this unit's tuner, analog TV closed caption cannot be output. Try using other connection.</li> </ul>

GENERAL

Introduction

Connections

Basic Setup

Recording

Playback

Editing

Function Setup

VCR Functions

Others

# TROUBLESHOOTING

	Symptom	Remedy
DVD • VCR	Playback picture is distorted.	<ul style="list-style-type: none"> <li>Keep the device which may cause electrical disturbances, such as a cellular phone, away.</li> </ul>
	The channel cannot be changed from the channel you are recording.	<ul style="list-style-type: none"> <li>Set the TV's input to "TV."</li> </ul>
	Nothing was recorded even though you set the timer setting correctly.	<ul style="list-style-type: none"> <li>There was a power failure during recording.</li> <li>The unit's internal clock stopped due to a power failure that lasted for more than 30 seconds. Reset the clock (pages 30-31).</li> <li>The program contains copy protection signals that restricts copying.</li> <li>The timer setting overlapped with another setting that has priority.</li> </ul>
	Timer recording is not complete or did not start from the beginning.	<ul style="list-style-type: none"> <li>The timer setting overlapped with another setting that has priority (page 45).</li> <li>Disc space was not enough.</li> </ul>
	Timer recording is impossible.	<ul style="list-style-type: none"> <li>Make sure  appears on the front panel display of this unit. If not, press <b>[TIMER SET]</b>.</li> </ul>
DVD	There is no picture.	<ul style="list-style-type: none"> <li>If the main menu appears on the TV screen, press <b>[BACK ↵]</b> to exit.</li> <li>Check if the progressive scan mode is set correctly according to your TV (page 99).</li> </ul>
	Picture noise appears.	<ul style="list-style-type: none"> <li>Clean the disc with a cleaning cloth.</li> </ul>
	There is no sound.	<ul style="list-style-type: none"> <li>If you are using DIGITAL AUDIO OUTPUT (COAXIAL) jack, check the setting in "Disc Audio" (page 94).</li> <li>Clean the disc with a cleaning cloth.</li> </ul>
	Sound is noisy.	<ul style="list-style-type: none"> <li>Clean the disc with a cleaning cloth.</li> </ul>
	No DTS sound is output.	<ul style="list-style-type: none"> <li>This unit is not compatible with DTS sound.</li> </ul>
	The disc does not play back.	<ul style="list-style-type: none"> <li>No disc is inserted.</li> <li>A blank disc is inserted.</li> <li>The disc is upside down. Insert the disc with the labeled side facing up.</li> <li>The disc is not correctly inserted.</li> <li>The unit cannot play back certain discs (such as a CD-ROM) (page 59).</li> <li>The region code on the DVD-video does not match the unit (page 59).</li> <li>Moisture has condensed inside the unit. Remove the disc and leave the unit turned on for about 2 hours until the moisture evaporates (page 5).</li> <li>If the disc was recorded on another recorder, the unit cannot play back the disc if it was not finalized.</li> </ul>
	Discs recorded on this unit cannot be played back on other DVD players.	<ul style="list-style-type: none"> <li>If you are using DVD-RW/-R, please ensure you finalized the disc after recording (pages 56-57).</li> </ul>
	The disc does not start playback from the beginning.	<ul style="list-style-type: none"> <li>Resume playback was activated (page 67). Press <b>[STOP ■]</b> twice.</li> <li>You have inserted a disc whose title menu or DVD menu automatically appears on the TV screen when it is first inserted.</li> </ul>
	The unit starts playing back the disc automatically.	<ul style="list-style-type: none"> <li>The DVD-video features an auto playback function.</li> </ul>
	Some functions such as stop, search, or slow-motion playback cannot be performed.	<ul style="list-style-type: none"> <li>Depending on the disc, you may not be able to do some of the operations. Refer to the instruction manual supplied with the disc.</li> </ul>
	The language for the sound track cannot be changed.	<ul style="list-style-type: none"> <li>The title does not have the multilingual audio tracks.</li> <li>The DVD-video prohibits the changing of the language for the sound track.</li> </ul>
	The subtitle language cannot be changed or turned off.	<ul style="list-style-type: none"> <li>Multilingual subtitle are not recorded on the DVD-video.</li> </ul>
	The angles cannot be changed.	<ul style="list-style-type: none"> <li>Multi-angles are not recorded on the DVD-video being played back.</li> <li>The angle-change operation is whenever possible as long as the disc contains a multi-angle portion. Actual change will be performed when the portion has come up.</li> <li>The DVD-video prohibits changing angles.</li> <li>Try changing the angle using the DVD-video's menu.</li> </ul>
	Recording does not stop immediately after you press <b>[STOP ■]</b> .	<ul style="list-style-type: none"> <li>It may take a few seconds for the unit to input disc data before recording stops.</li> </ul>
	The disc tray does not open when you press <b>[OPEN/CLOSE ▲]</b> .	<ul style="list-style-type: none"> <li>It may take a few seconds for the disc tray to open after you have recorded or edited a disc. This is because the unit is adding disc data to the disc.</li> </ul>

# TROUBLESHOOTING

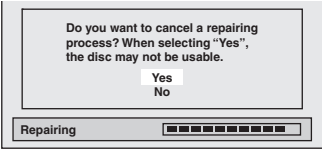
	Symptom	Remedy
DVD	<p>Playback image freezes for a second.</p> <p>“Repairing” appears on the TV screen.</p>  <p>In a case you intend to cancel the repairing process.</p> 	<ul style="list-style-type: none"> <li>• During the playback of 2 layered disc, picture may freeze for a moment when the 1st layer switches to the 2nd layer. This is not a malfunction.</li> <li>• If there is a power failure or unplugging during recording, finalizing, formatting or editing (even after “Repairing” disappears), a repairing process will begin automatically just after turning the unit on again. It may take several minutes up to about several hours.</li> <li>• If you intend to cancel the repairing process, press <b>[OPEN/CLOSE ▲]</b> on the front panel, then select “Yes” and press <b>[OK]</b>. After that, press <b>[OPEN/CLOSE ▲]</b> to take out the disc. <b>The disc canceled during the repairing process MAY NOT work.</b></li> </ul>
	<p>Picture noise appears.</p> <p>The cassette tape does not play back.</p>	<ul style="list-style-type: none"> <li>• Head cleaning for VCR may be necessary. Refer to “Auto head cleaning” (page 5).</li> <li>• Adjust tracking control for better picture by pressing <b>[CH + / -]</b> while you are playing back a cassette tape.</li> <li>• No cassette tape is inserted.</li> </ul>
VCR	<p>Recording does not start after you press <b>[REC ●]</b>.</p> <p>The remote control does not function.</p> <p>The motor rotates even when playback / recording is stopped.</p>	<ul style="list-style-type: none"> <li>• Make sure the cassette tape has an erase-protection tab when you record to a cassette tape. If needed, cover the hole with cellophane tape.</li> <li>• Check if a cassette tape is in this unit.</li> <li>• The motor may rotate for the duration of approximately 5 minutes for efficient operation. This is not a malfunction.</li> </ul>
	<p>DV signal cannot be input.</p> <p>The DVC cannot be operated with this unit.</p> <p>Certain functions of the DVC cannot operate.</p>	<ul style="list-style-type: none"> <li>• Before connection, turn on the power supplies for both this unit and the DVC, and make sure that these units have stopped.</li> <li>• Only a “DVC-SD” signal can be input from the DVC to this unit. Other types of signals are not supported.</li> <li>• Do not connect any device other than the DVC. Even if a recorder or PC with another DV terminal is connected, the DV function will not operate.</li> <li>• If the DVC is not recognized after connection, turn off the power supply for the unit and re-connect the DVC.</li> <li>• Signal input or DVC operation from this unit may be disabled depending on the type of DVC.</li> <li>• If a DVC signal cannot be input, use an external input (E1/E2) for analog connection via audio/video cables.</li> <li>• DVC control may be disabled depending on the type of DVC, even in a mode other than camera mode. In this case, switch to DVD control and execute the normal recording procedure while operating the DVC.</li> <li>• Some functions may not operate depending on the type of DVC. For example, if the DVC does not support slow playback mode, the slow playback function is disabled.</li> <li>• With E3(DV-IN), the disc display menu does not appear unless disc playback is executed.</li> </ul>
OTHER	<p>DV audio signal cannot be switched.</p> <p>No image from HDMI connection.</p>	<ul style="list-style-type: none"> <li>• For recording with the DVC, the recording audio signal can be set to 12 bits or 16 bits. However, when 16-bit recording mode is selected, audio signal cannot be switched. To record an audio signal, set it to 12 bits.</li> <li>• Check the HDMI connection. (Check the status of the HDMI related indications.)</li> <li>• Check whether the connected monitor device or other device supports HDCP. (This unit will not output a video signal unless the other device supports HDCP.)</li> <li>• Check the setting of HDMI.</li> <li>• Check whether the output format of this unit (HDMI FORMAT) matches the supported input format of other connected device.</li> </ul>

# TROUBLESHOOTING

Disc Error message	Cause	Solution
Disc Error — Please eject the disc. — Playback feature may not be available on this Disc.	<ul style="list-style-type: none"> <li>Unplayable disc is inserted in the unit.</li> <li>The disc is upside down.</li> </ul>	<ul style="list-style-type: none"> <li>Insert the standardized disc which bear the marks on page 58.</li> <li>Insert the disc with the labeled side facing up.</li> </ul>
Region Error — Please eject the disc. — Playback is not authorized in your region.	<ul style="list-style-type: none"> <li>Playback is not authorized in the region of the DVD-video which you inserted in the unit.</li> </ul>	<ul style="list-style-type: none"> <li>Insert the DVD-video with region codes 1 or ALL.</li> </ul>
Parental Lock On The current selected parental level prohibits playback.	<ul style="list-style-type: none"> <li>The current selected parental level prohibits playback.</li> </ul>	<ul style="list-style-type: none"> <li>Check "Parental Lock" setting in "Playback" menu (page 93).</li> </ul>
Recording Error This program is not allowed to be recorded.	<ul style="list-style-type: none"> <li>The recording function encountered the copy prohibited program.</li> </ul>	<ul style="list-style-type: none"> <li>You cannot record copy prohibited programs.</li> </ul>
Recording Error This program is not recordable in +VR mode.	<ul style="list-style-type: none"> <li>You are trying to record the copy-once program.</li> </ul>	<ul style="list-style-type: none"> <li>You cannot record the copy-once program.</li> </ul>
Recording Error Can not record on this disc.	<ul style="list-style-type: none"> <li>You are trying to record onto the disc which is unrecordable, or the disc status is unable to record.</li> <li>The disc is dirty.</li> <li>The disc is damaged.</li> </ul>	<ul style="list-style-type: none"> <li>Insert the recordable disc, and ensure the disc status satisfies the recording requirements (page 38).</li> <li>Clean the disc with a cleaning cloth.</li> <li>Replace the disc.</li> </ul>
Recording Error This disc is protected and not recordable.	<ul style="list-style-type: none"> <li>You are trying to record on to the protected disc which is set in "Disc Edit" menu.</li> </ul>	<ul style="list-style-type: none"> <li>Release the disc protect setting in "Disc Edit" menu (page 86).</li> </ul>
Recording Error Disc is full. (No area for new recording)	<ul style="list-style-type: none"> <li>You are trying to record onto the disc which has no space for recording.</li> </ul>	<ul style="list-style-type: none"> <li>Insert the recordable disc with enough recording space.</li> </ul>
Recording Error You cannot record more than 49 titles on one disc. (The maximum is 49)	<ul style="list-style-type: none"> <li>You are trying to record onto the disc on which the number of recording titles comes up to the maximum (49).</li> </ul>	<ul style="list-style-type: none"> <li>Delete unnecessary titles (page 77).</li> </ul>
Recording Error You cannot record more than 254 chapters on one disc. (The maximum is 254)	<ul style="list-style-type: none"> <li>You are trying to record onto the DVD+RW or DVD-RW on which the number of recording chapters comes up to the maximum (254).</li> </ul>	<ul style="list-style-type: none"> <li>Delete unnecessary chapter marks (pages 80-81).</li> </ul>
Recording Error You cannot record on this disc as Power Calibration Area is full.	<ul style="list-style-type: none"> <li>When recordings are performed repeatedly onto an unstable disc, this area may come up to be full.</li> <li>Every time you insert a disc for recording, the disc's working area will be taken up. And if you repeat this frequently, it will be used up sooner and you may not be able to record full 49 titles.</li> </ul>	<ul style="list-style-type: none"> <li>Insert a new disc.</li> </ul>
Recording Error This disc is already finalized.	<ul style="list-style-type: none"> <li>You are trying to record onto the disc already finalized.</li> </ul>	<ul style="list-style-type: none"> <li>Release the finalizing for this disc (page 56).</li> </ul>
Recording Error The disc has no recording compatibility. Set "Make Recording Compatible" to "ON" to convert the disc.	<ul style="list-style-type: none"> <li>You are trying to record onto the disc that had been recorded by other recorders.</li> </ul>	<ul style="list-style-type: none"> <li>Set "Make Recording Compatible" to "ON" to rewrite the menu, after that you will record to disc (page 39).</li> </ul>

\* If you are still having trouble with the unit after checking "TROUBLESHOOTING", write down the error code and the error description for calling our help line mentioned on the front page to locate an Authorized Service Center.



## Frequently Asked Questions

- Can I record to CD-RW/-R? No, this unit records only DVD.
- Can I play back DVD-video that is bought in another country? Possible when the region code of the disc is 1 and All.
- Can I connect the unit to my PC? No, you cannot control the unit by PC.
- Can I program a timer recording with cable/satellite box? Yes, you can. Select “E1” or “E2” as your recording channel, and leave the cable / satellite box on (pages 17, 42-45).
- Can I record one channel while watching another channel using a cable / satellite box? It depends on your connection configurations. For more details, please kindly contact your cable / satellite provider.
- Can I connect this unit directly to a TV which only has an antenna in jack using an RF coaxial cable? No. You need an RF modulator (commercially available) to connect this unit to a TV which only has an antenna in jack (page 16). This unit does not have an RF modulator.
- Can I change the channels on the cable / satellite box using the remote control of this unit? No. Changing the channels on the cable / satellite box using this unit’s remote control is not possible. You need to use the remote control supplied with the cable / satellite box to change the channels on the cable / satellite box.

## Note for Output Jacks on the Rear Panel

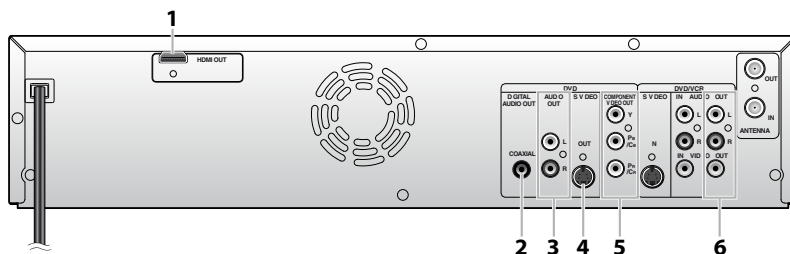

Output Jacks	Available for	
	DVD mode only	VCR mode
1 (HDMI OUT)	✓	✓
2 (COAXIAL DIGITAL AUDIO OUT)	✓	
3 (AUDIO OUT)	✓	
4 (S-VIDEO OUT)	✓	
5 (COMPONENT VIDEO OUT - interlace)	✓	
5 (COMPONENT VIDEO OUT - progressive)	✓	
6 (AUDIO/VIDEO OUT)	✓	✓

✓ : Available

■ : Not available

# LANGUAGE CODE

Language	Code
Abkhazian	4748
Afar	4747
Afrikaans	4752
Albanian	6563
Amharic	4759
Arabic	4764
Armenian	5471
Assamese	4765
Aymara	4771
Azerbaijani	4772
Bashkir	4847
Basque	5167
Bengali; Bangla	4860
Bhutani	5072
Bihari	4854
Bislama	4855
Breton	4864
Bulgarian	4853
Burmese	5971
Byelorussian	4851
Cambodian	5759
Catalan	4947
Chinese	7254
Corsican	4961
Croatian	5464
Czech	4965
Danish	5047
Dutch	6058
English	5160
Esperanto	5161
Estonian	5166
Faroese	5261
Fiji	5256
Finnish	5255
French	5264
Frisian	5271
Galician	5358
Georgian	5747
German	5051
Greek	5158
Greenlandic	5758
Guarani	5360
Gujarati	5367
Hausa	5447
Hebrew	5569
Hindi	5455

Language	Code
Hungarian	5467
Icelandic	5565
Indonesian	5560
Interlingua	5547
Interlingue	5551
Inupiak	5557
Irish	5347
Italian	5566
Japanese	5647
Javanese	5669
Kannada	5760
Kashmiri	5765
Kazakh	5757
Kinyarwanda	6469
Kirghiz	5771
Kirundi	6460
Korean	5761
Kurdish	5767
Laothian	5861
Latin	5847
Latvian; Lettish	5868
Lingala	5860
Lithuanian	5866
Macedonian	5957
Malagasy	5953
Malay	5965
Malayalam	5958
Maltese	5966
Maori	5955
Marathi	5964
Moldavian	5961
Mongolian	5960
Nauru	6047
Nepali	6051
Norwegian	6061
Occitan	6149
Oriya	6164
Oromo (Afan)	6159
Panjabi	6247
Pashto; Pushto	6265
Persian	5247
Polish	6258
Portuguese	6266
Quechua	6367
Rhaeto-Romance	6459
Romanian	6461

Language	Code
Russian	6467
Samoaan	6559
Sangho	6553
Sanskrit	6547
Scots Gaelic	5350
Serbian	6564
Serbo-Croatian	6554
Sesotho	6566
Setswana	6660
Shona	6560
Sindhi	6550
Singhalese	6555
Siswat	6565
Slovak	6557
Slovenian	6558
Somali	6561
Spanish	5165
Sundanese	6567
Swahili	6569
Swedish	6568
Tagalog	6658
Tajik	6653
Tamil	6647
Tatar	6666
Telugu	6651
Thai	6654
Tibetan	4861
Tigrinya	6655
Tonga	6661
Tsonga	6665
Turkish	6664
Turkmen	6657
Twi	6669
Ukrainian	6757
Urdu	6764
Uzbek	6772
Vietnamese	6855
Volapuk	6861
Welsh	4971
Wolof	6961
Xhosa	7054
Yiddish	5655
Yoruba	7161
Zulu	7267

## **Analog Audio**

An electrical signal that directly represents sound. Compare this to digital audio which can be an electrical signal, but is an indirect representation of sound. See also "Digital Audio".

## **Aspect Ratio**

The width of a TV screen relative to its height. Conventional TVs are 4:3 (in other words, the TV screen is almost square); widescreen models are 16:9 (the TV screen is almost twice as wide as it is high).

## **Chapter**

Just as a book is split up into several chapters, a title on a DVD is usually divided into chapters. See also "Title".

## **Component Video Out**

Each signal of luminance (Y) and component (P<sub>B</sub>/C<sub>B</sub>, P<sub>R</sub>/C<sub>R</sub>) is independent to output so that you can experience picture color as it is.

Also, due to compatibility with progressive video (525p/480p), you can experience higher-density picture than that in interlace (525i/480i).

## **Digital Audio**

An indirect representation of sound by numbers. During recording, the sound is measured at discrete intervals (44,100 times a second for CD audio) by an analog-to-digital converter, generating a stream of numbers. On playback, a digital-to-analog converter generates an analog signal based on these numbers. See also "Sampling Frequency" and "Analog Audio".

## **DivX®**

DivX® is a codec (compression/decompression) that can compress images to a very small amount of data.

## **Dolby Digital**

The system to compress digital sound developed by Dolby Laboratories. It offers you sound of stereo(2ch) or multi channel audio.

## **Finalize**

To make DVD, which have been recorded on, possible to play back in DVD players. With this unit, it is possible to finalize DVD+R, DVD-RW, and DVD-R.

## **HDMI (high definition multimedia interface)**

A digital interface between audio and video source. It can transmit component video, audio, and control signal with one cable connection.

## **JPEG (joint photographic experts group)**

JPEG is a method of compressing still image files. You can copy JPEG files on CD-RW/-R from a computer and play back the files on this unit.

## **MP3 (MPEG audio layer 3)**

MP3 is a method of compressing files. You can copy MP3 files on CD-RW/-R from the computer and play back the files on this unit.

## **PCM (pulse code modulation)**

The most common system of encoding digital audio, found on CD and DAT. Excellent quality, but requires a lot of data compared to formats such as Dolby Digital and MPEG audio. For compatibility with digital audio recorders (CD, MD and DAT) and AV amplifiers with digital inputs, this unit can convert Dolby Digital and MPEG audio to PCM. See also "Digital Audio".

## **Progressive Scan (525p/480p)**

A type of display that does not split each frame into fields, and instead scans directly through all the scanlines of each frame in order. Progressive scan provides less flickering and higher image resolution than traditional (525i/480i) TV signals. Refer to page 99 for instructions on selective progressive scan mode.

## **Region Code**

Regions associate discs and players with particular areas of the world. This unit will only play back discs that have compatible region codes. You can find the region code of your unit by looking on the rear panel. Some discs are compatible with more than one region (or all regions).

## **Sampling Frequency**

The rate which sound is measured by a specified interval to turn into digital audio data. The numbers of sampling in one second defines as sampling frequency. The higher the rate, the better the sound quality.

## **SAP (secondary audio program)**

Sub-audio channel which is delivered separately from main-audio channel. This audio channel is used as an alternate in bilingual broadcasting.

## **S-Video Output**

It delivers independently each signal of color(C) and luminance(Y) to TV as video signals, so that higher-quality picture will be gained.

## **Title (DVD only)**

A collection of chapters on DVD. See also "Chapter".

## **Track**

Audio CD use tracks to divide up the content of a disc. The DVD equivalent is called a chapter. See also "Chapter".

## **Windows Media™ Audio**

Windows Media™ Audio is the audio compressing technology developed by Microsoft. You can copy Windows Media™ Audio files on CD-RW/-R from a computer and play them back on this unit.

# SPECIFICATIONS

## General

System	DVD+RW/+R, DVD-RW/-R, DVD-video, CD-DA, CD-RW/-R
Power requirements	120V AC +/-10%, 60Hz +/-5%
Power consumption	30W (standby: 3.5W)
Dimensions (width x height x depth)	17.1 x 3.9 x 10.2 inches (435 x 99.5 x 260mm)
Weight	9.5 lbs. ( 4.3kg )
Operating temperature	41°F (5°C) to 104°F (40°C)
Operating humidity	Less than 80% (no condensation)
TV format	ATSC / NTSC-M TV standard

## Recording

Recording format	+VR (video recording) format
Recording discs	DVD+Rewritable, DVD+Recordable DVD-Rewritable, DVD-Recordable (+VR mode only)

### Video recording format

Sampling frequency	13.5 MHz
Compression format	MPEG

### Audio recording format

Sampling frequency	48 kHz
Compression format	Dolby Digital

## Tuner

Tuning system	Channel frequency synthesized tuning system
---------------	---

### Channel coverage (ATSC / NTSC)

Terrestrial	VHF 2~13, UHF 14~69
CATV	2~13, A~W, W+1~W+94 (analog W+1~W+84), A-5~A1, 5A

## Terminals

Front	<b>Audio input</b> RCA jack x 2	2V rms (input impedance: more than 22kΩ)		
	<b>Video input</b> RCA jack x 1	1Vp-p (75Ω)		
	<b>S-video input</b> Mini DIN 4-pin x 1	Y: 1Vp-p (75Ω)	C: 286mVp-p (75Ω)	
	<b>DV input</b> DV 4-pin jack x 1	IEEE 1394		
	<b>VHF/UHF/CATV input and output</b> F-type	75Ω unbalanced		
Rear	<b>Audio input</b> RCA jack x 2	2V rms (input impedance: more than 22kΩ)		
	<b>Audio output</b> RCA jack x 4	2V rms (output impedance: more than 1kΩ)		
	<b>Video input</b> RCA jack x 1	1Vp-p (75Ω)		
	<b>Video output</b> RCA jack x 1	1Vp-p (75Ω)		
	<b>S-video input</b> Mini DIN 4-pin x 1	Y: 1Vp-p (75Ω)	C: 286mVp-p (75Ω)	
	<b>S-video output</b> Mini DIN 4-pin x 1	Y: 1Vp-p (75Ω)	C: 286mVp-p (75Ω)	
	<b>Component video out</b> RCA jack x 3	Y: 1Vp-p (75Ω)	PB/Cb: 700mVp-p (75Ω)	PR/CR: 700mVp-p (75Ω)
	<b>Coaxial digital audio out</b> RCA jack x 1	500mVp-p (75Ω)		
	<b>HDMI output</b> HDMI jack x 1	Video: 480p, 720p, 1080i, 1080p Audio: 2 channel linear PCM 32, 44.1 and 48kHz		

### Note

- The specifications and design of this product are subject to change without notice.

# LIMITED WARRANTY

## ONE (1) YEAR LIMITED WARRANTY

### WARRANTY COVERAGE:

This warranty obligation is limited to the terms set forth below.

### WHO IS COVERED:

This product is warranted to the original purchaser or the person receiving the product as a gift against defects in materials and workmanship as based on the date of original purchase ("Warranty Period") from an Authorized Dealer. The original sales receipt showing the product name and the purchase date from an authorized retailer is considered such proof.

### WHAT IS COVERED:

This warranty covers new products if a defect in material or workmanship occurs and a valid claim is received within the Warranty Period. At its option, the company will either (1) repair the product at no charge, using new or refurbished replacement parts, or (2) exchange the product with a product that is new or which has been manufactured from new, or serviceable used parts and is at least functionally equivalent or most comparable to the original product in current inventory, or (3) refund the original purchase price of the product.

The Company warrants replacement products or parts provided under this warranty against defects in materials and workmanship from the date of the replacement or repair for ninety (90) days or for the remaining portion of the original product's warranty, whichever provides longer coverage for you. When a product or part is exchanged, any replacement item becomes your property and the replaced item becomes the company's property. When a refund is given, your product becomes the company's property.

**Note: Any product sold and identified as refurbished or renewed carries a ninety (90) day limited warranty.**

**Replacement product can only be sent if all warranty requirements are met. Failure to follow all requirements can result in delay.**

### WHAT IS NOT COVERED - EXCLUSIONS AND LIMITATIONS:

This Limited Warranty applies only to the new products that can be identified by the trademark, trade name, or logo affixed to it. This Limited Warranty does not apply to any non-Philips hardware product or any software, even if packaged or sold with the product. Non-Philips manufacturers, suppliers, or publishers may provide a separate warranty for their own products packaged with the bundled product.

The Company is not liable for any damage to or loss of any programs, data, or other information stored on any media contained within the product, or any non-Philips product or part not covered by this warranty. Recovery or reinstallation of programs, data or other information is not covered under this Limited Warranty.

This warranty does not apply (a) to damage caused by accident, abuse, misuse, neglect, misapplication, or non-Philips product, (b) to damage caused by service performed by anyone other than an Authorized Service Location, (c) to a product or

a part that has been modified without written permission, or (d) if any serial number has been removed or defaced, or (e) product, accessories or consumables sold "AS IS" without warranty of any kind by including refurbished Philips product sold "AS IS" by some retailers.

### This Limited Warranty does not cover:

- Shipping charges to return defective product.
- Labor charges for installation or setup of the product, adjustment of customer controls on the product, and installation or repair of antenna/signal source systems outside of the product.
- Product repair and/or part replacement because of improper installation or maintenance, connections to improper voltage supply, power line surge, lightning damage, retained images or screen markings resulting from viewing fixed stationary content for extended periods, product cosmetic appearance items due to normal wear and tear, unauthorized repair or other cause not within the control of the company.
- Damage or claims for products not being available for use, or for lost data or lost software.
- Damage from mishandled shipments or transit accidents when returning product.
- A product that requires modification or adaptation to enable it to operate in any country other than the country for which it was designed, manufactured, approved and/or authorized, or repair of products damaged by these modifications.
- A product used for commercial or institutional purposes (including but not limited to rental purposes).
- Product lost in shipment and no signature verification receipt can be provided.
- Failure to operate per Owner's Manual.

### TO OBTAIN ASSISTANCE IN THE U.S.A., PUERTO RICO, OR U.S. VIRGIN ISLANDS...

Contact Philips Customer Care Center at:  
1-866-771-4018

### TO OBTAIN ASSISTANCE IN CANADA...

1-800-661-6162 (French Speaking)  
1-866-771-4018 (English or Spanish Speaking)

REPAIR OR REPLACEMENT AS PROVIDED UNDER THIS WARRANTY IS THE EXCLUSIVE REMEDY FOR THE CONSUMER. PHILIPS SHALL NOT BE LIABLE FOR ANY INCIDENTAL OR CONSEQUENTIAL DAMAGES FOR BREACH OF ANY EXPRESS OR IMPLIED WARRANTY ON THIS PRODUCT. EXCEPT TO THE EXTENT PROHIBITED BY APPLICABLE LAW, ANY IMPLIED WARRANTY OF MERCHANTABILITY OR FITNESS FOR A PARTICULAR PURPOSE ON THIS PRODUCT IS LIMITED IN DURATION TO THE DURATION OF THIS WARRANTY.

Some states do not allow the exclusions or limitation of incidental or consequential damages, or allow limitations on how long an implied warranty lasts, so the above limitations or exclusions may not apply to you.

*This warranty gives you specific legal rights. You may have other rights which vary from state/province to state/province.*

P&F USA, Inc.  
P.O.Box 672768 Marietta, Georgia 30006

Introduction

Connections

Basic Setup

Recording

Playback

Editing

Function Setup

VCR Functions

Others

**P&F USA, Inc.**  
P.O. Box 672768 Marietta, Georgia 30006

Meet Philips at the Internet  
<http://www.philips.com/welcome>



**DVDR3545V**



Printed in China  
JpnHF-0918/F7-3  
1VMN27297A ★★★★★  
E9H91UD\_E9H9TUD