

User manual

Manuale d'utilizzo

Käyttäjän opas

Bruksanvisning

Manual del usuario

Benutzerhandbuch



PHILIPS

WELCOME TO DIGITAL TELEVISION

Congratulations on choosing the Philips DTR 6610 digital terrestrial receiver. This receiver will allow you to access free-to-view digital terrestrial television, radio interactive and dedicated scrambled channels. The embedded MHP feature makes your receiver compatible with the MHP interactive television applications that are carried on some of the channels.

Note: "Decoder" is used in all the menu screens. The term "decoder" also stands for "STB (Set Top Box)", "Receiver" or "Digital receiver". In the user manual all descriptions refer to "receiver".

BENVENUTI NEL MONDO DELLA TELEVISIONE DIGITALE

Congratulazioni per avere acquistato un ricevitore digitale terrestre Philips DTR 6610, che vi consentirà di accedere gratuitamente a una vasta gamma di programmazioni su emittenti digitali terrestri, radio, canali interattivi e canali criptati dedicati. La funzione MHP integrata rende il ricevitore compatibile con le applicazioni televisive interattive MHP presenti su alcuni canali.

Nota: in tutte le schermate dei menu è utilizzato il termine "decoder". "Decoder" è anche sinonimo di "STB (Set Top Box)", "Ricevitore" o "Ricevitore digitale". Nel manuale di istruzioni tutte le descrizioni utilizzano invece la parola "ricevitore".

TERVETULOA DIGITAALISEN TELEVISION MAAILMAAN

Kiitos, että olet valinnut Philipsin digitaalisen ETR 6610 -vastaanottimen. Laitteella voit vastaanottaa maanpäällisen verkon maksuttomia digitaalisia tv- ja radiokanavia sekä interaktiivisia ja salattuja erikoiskanavia. Vastaanottimen MHP-toiminta mahdollistaa tiettyjen tv-kanavien lähettämien vuorovaikutteisten MHP-sovellusten käytön.

Huomautus: Kaikissa valikkoteksteissä esiintyy termi "dekooderi". Dekooderi tarkoittaa samaa kuin "STB (Set Top Box)", "vastaanotin" tai "digivastaanotin". Tässä käyttöohjeessa laitteesta käytetään nimitystä "vastaanotin".

VÄLKOMMEN TILL DEN DIGITALA TELEVISIONEN

Grattis till ditt köp av den digitala markmottagaren DTR 6610 från Philips. Denna mottagare ger dig tillgång till gratis digitala markbunden television, radio, interaktiva och utvalda kodade kanaler. Den inbyggda MHP-funktionen gör din mottagare kompatibel med de interaktiva MHP-applikationer som finns i vissa kanaler.

Observera: "Dekoder" används i alla menybilder. Termen "dekooder" är liktydig med "STB" ("Set Top Box" - "digitaldekooder"), "Mottagare" eller "Digital mottagare". I bruksanvisningen står i alla beskrivningar "digitalmottagare".

BIENVENIDO A LA TELEVISIÓN DIGITAL

Enhorabuena por su elección del receptor digital terrestre DTR 6610 de Philips, con el que podrá acceder en abierto a programas de televisión y radio interactiva, así como a canales codificados especializados. Al incluir la característica MHP, el receptor es compatible con las aplicaciones MHP de televisión interactiva que ofrecen algunos canales.

Nota: El término "decodificador" aparece en todas las pantallas de menú. Este término también hace referencia al "STB (Dispositivo convertidor-decodificador)", "Receptor" o "Receptor digital". En el manual de usuario todas las descripciones harán referencia al "receptor".

WILLKOMMEN IN DER WELT DES DIGITALEN FERNSEHENS

Herzlichen Glückwunsch zum Kauf digitaler terrestrischer Receiver DTR 6610 von Philips. Mit dem Receiver können Sie frei zugängliche digitale Fernseh- und Radioprogramme sowie interaktive und spezielle verschlüsselte Sender empfangen. Dank der eingebauten MHP-Funktion ist Ihr Receiver kompatibel mit den interaktiven MHP-Fernsehanwendungen, die über bestimmte Kanäle übertragen werden.

Hinweis: In den Menüfenstern wird jeweils der Begriff "Decoder" benutzt. Darunter fallen auch die Bezeichnungen "STB" (Set Top Box), "Receiver" und "Digital Receiver". In der Bedienungsanleitung wird für diese Begriffe durchgängig die Bezeichnung "Receiver" verwendet.

Safety Instructions

All the safety and operating Instructions should be read and understood before the receiver is operated.

For best results, position your receiver away from radiators or other heat sources. Leave a space of at least 3 cm around the receiver for ventilation making sure that the ventilation holes are not obstructed.

This receiver is intended for use in a domestic environment only and should never be operated or stored in excessively hot, humid or damp conditions.

Make sure no objects or fluids enter the housing through the ventilation slots. Should this happen, disconnect your receiver from the mains and consult your retailer.

For cleaning, use damp chamois leather. Never use any abrasive cloth, sponge or cleaner.

When connecting or disconnecting cables to the receiver always ensure the receiver is disconnected from the mains.

Do not disassemble the equipment. There are no user serviceable parts.

Mains connection

Before connecting the receiver to the mains, check that the mains supply voltage corresponds to the voltage printed on the rear of the receiver. If the mains voltage is different, consult your dealer.

Please wait before connecting your receiver - read on.

Unpacking

As you unpack your digital receiver, please make sure the following accessories are included:

- Remote control with separately packed Philips alkaline batteries
- Mains cord
- One SCART cable
- One Phone cord (adapter not supplied)
- One RF coaxial cable
- User Manual

- Philips guarantee card
- Stand for using the receiver in the upright position.

Warning: Plastic bags can be dangerous. To avoid suffocation keep the bag away from babies and children.



The symbol  on the packaging and user manual means that the materials are recyclable.

Receiver in upright position

Your receiver can be integrated in different ways within your existing Audio-Video setup. The receiver can be used in the horizontal or vertical position. If you decide to use your receiver in the upright position, follow the instructions below:

- Unpack the stand, place it on a horizontal surface with click fit side on the left and lug side on the right.
- Position the receiver as shown below (rear panel on the left side / coaxial connectors on the bottom side).

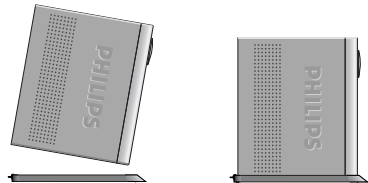

- Insert the stand lug in the slot located on the front of the receiver, close to the Philips badge.
- Rock the receiver to insert the stand lug fully in the slot until it is locked by the click fit.

Then your receiver can be used in the upright position, rotating the rotary display for use in this position.

Note: to remove the stand, unlock the click fit at the rear side of the stand, rocking and pulling back the receiver to extract it from the stand lug.

Quick installation guide



Please refer to the safety section before connecting your receiver.

- 1 Integrate your receiver in your existing installation as shown below.

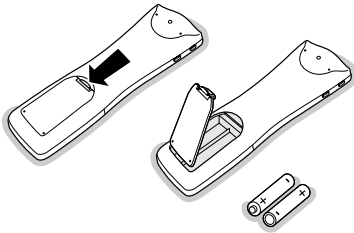
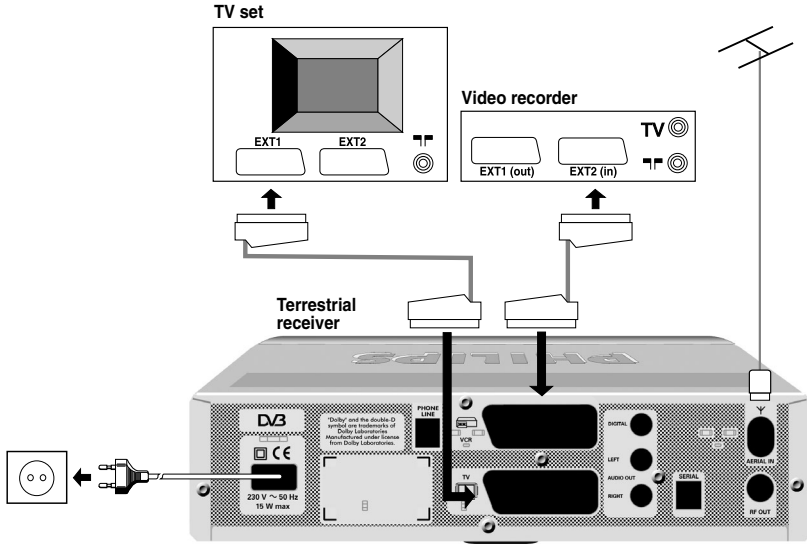

- 2 Insert the two batteries supplied in your remote control.



- 3 Switch on the TV set and select a channel.
- 4 Plug the receiver's power supply cord to the mains. The receiver front panel LED gets on, then the display.
- 5 Now you should see the **Welcome** screen on your TV screen. After a few seconds, the **Welcome** screen disappears.



- 6 Then, a screen appears that allows you to select the language. Highlight the desired language by pressing ▲/▼ and then press **OK**.

You are prompted to confirm your choice by pressing **OK** again.

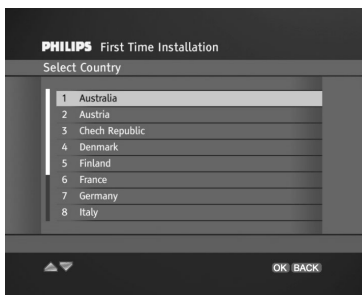

- 7 Next, highlight the country where you operate the receiver by pressing ▲/▼ and then press **OK**.

You are prompted to confirm your choice by pressing **OK** again.

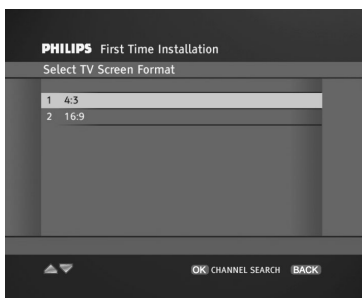

- 8 A screen appears that allows you to select the TV screen format corresponding to your TV set. Highlight the appropriate format by pressing ▲/▼. Press **OK** to initiate the channel search.

Search operation is indicated by segments moving around the display.

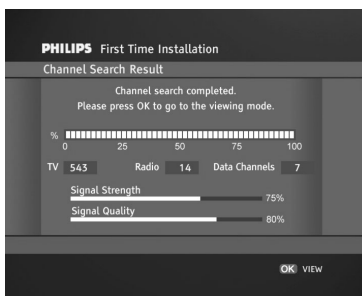

- 9 Once it has been completed, follow the prompts displayed on the screen.

Press **OK** to store any found channels and tune the box to the first found TV channel.

Now you are ready to enjoy viewing your terrestrial receiver. Refer to chapter 4 Day to Day operation to learn more about using your receiver.

Contents

Safety Instructions	1
----------------------------	----------

Unpacking	1
------------------	----------

Receiver in upright position	1
-------------------------------------	----------

Quick installation guide	2
---------------------------------	----------

Contents	4
-----------------	----------

1 Product description	6
------------------------------	----------

1.1 Front view	6
----------------	---

1.2 Rear view	8
---------------	---

1.3 Smart card reader	9
-----------------------	---

2 Preparing, setting and using your Remote Control	9
-----------------------------------------------------------	----------

2.1 Installation of batteries	9
-------------------------------	---

2.2 Setting of your remote control	9
------------------------------------	---

2.2.1 Mode setting	9
--------------------	---

2.2.2 Volume and mute control setting	10
---------------------------------------	----

2.2.3 Changing the brand setting of your remote control for TV, VCR, DVD or Amplifier-Tuner	10
---------------------------------------------------------------------------------------------	----

2.3 Using the remote to control your digital receiver –The remote control is set to STB mode	11
----------------------------------------------------------------------------------------------	----

3 Connection and Installation	12
--------------------------------------	-----------

3.1 Connections	12
-----------------	----

3.1.1 Connect the receiver to your TV and VCR	12
-----------------------------------------------	----

3.1.2 Connect your HiFi appliance	13
-----------------------------------	----

3.1.3 Connect your receiver to the telephone line	13
---------------------------------------------------	----

3.2 Receiver installation	13
---------------------------	----

3.3 Installation error	14
------------------------	----

4 Day to Day operation	14
-------------------------------	-----------

4.1 Connecting your receiver to the mains	14
-------------------------------------------	----

4.2 Turn ON your receiver or switch to low power	14
--------------------------------------------------	----

4.3 Wake up your receiver or Switch to standby	15
------------------------------------------------	----

4.4 Select TV or Radio mode	15
-----------------------------	----

4.5 How to switch between channels in the list	15
------------------------------------------------	----

4.6 How to use the channel Banner	16
-----------------------------------	----

4.6.1 Channel Banner Icons	16
----------------------------	----

4.6.2 How to Select Current / Next Programs	17
---------------------------------------------	----

4.6.3 How to Select Channels	17
------------------------------	----

4.7 How to Change momentarily the current Program Options	17
-----------------------------------------------------------	----

4.8 How to Display More Program Info	18
--------------------------------------	----

4.9 MHP Interactive Applications	18
----------------------------------	----

4.9.1 How to run MHP Applications	18
-----------------------------------	----

4.9.2 Country specifics	19
-------------------------	----

4.10 Reminders and Timers	20
---------------------------	----

4.10.1 Difference Between Reminder and Timer	20
----------------------------------------------	----

4.10.2 Viewing and Recording Reminders/ Timers	20
------------------------------------------------	----

4.10.3 Reminder/Timer Conflicts	21
---------------------------------	----

4.10.4 Timer Manager	21
----------------------	----

4.11 Program Guide	22
--------------------	----

5 Main Menu _____ 23

6 Change the setting of your receiver _____ 24
6.1 Channel Manager _____ 24
6.1.1 How to skip a channel _____ 24
6.1.2 How to move a channel _____ 24
6.1.3 How to rename a channel _____ 25
6.1.4 How to lock a channel _____ 25
6.2 Specially for parents _____ 25
6.2.1 Decoder Lock _____ 25
6.2.2 Parental Control _____ 26
6.2.3 Change PIN code _____ 26
6.3 Your Preferences _____ 26
6.3.1 Display Options _____ 26
6.3.2 Language Options _____ 27
6.4 Installation _____ 28
6.4.1 Local Time _____ 28
6.4.2 Settings _____ 28
6.4.3 Installation / Signal Meter _____ 31
6.4.4 Installation / Channel Search _____ 32
6.4.5 Installation / Decoder Status _____ 32
6.4.6 Installation / Factory Reset _____ 32

7 Advanced Settings _____ 33
7.1 Easy Recording _____ 33
7.2 Change the Remote Control and receiver "Device" Settings _____ 34

8 Programming the Remote Control for your STB, TV, Video Recorder, DVD and Tuner - Amplifier. _____ 35
8.1 Setting up your remote control _____ 35
8.2 Using your remote control for your TV _____ 36
8.3 Using your remote control for your VCR _____ 37
8.4 Using Remote Control For Your DVD Player _____ 38
8.5 Using Remote Control For Your Tuner / Amplifier _____ 39

9 Troubleshooting guide _____ 40

10 Technical Specifications _____ 41

I Product description

I.1 Front view

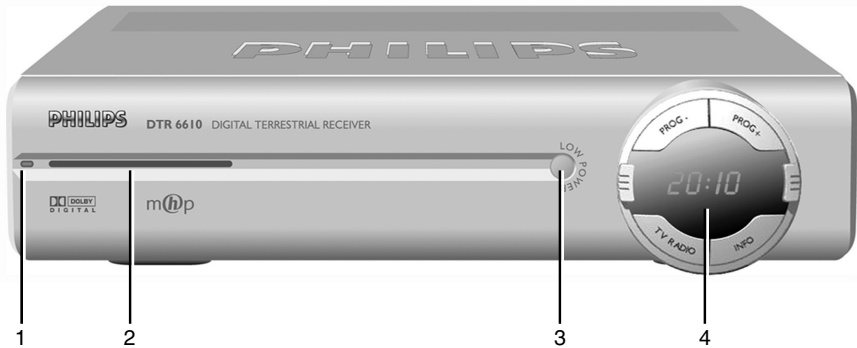

I Slot for stand positioning:

See Receiver in upright position on page I.

2 Smart Card slot: See section I.3.

3 LOW POWER button with red indicator:

Switch the receiver ON or to low power. Indicate low power when lit.

4 Rotating display, including the following buttons:

PROG-/PROG+

In standby, wake up the receiver.

In normal viewing, Channel Banner, or Program Guide, switch channels up/down.

From the Menu system, exit to normal viewing, and then switch channels.

TV/RADIO

In standby, wake up the receiver.

In normal viewing, Channel Banner, or Program Guide, switch between digital TV and Radio.

From the Menu system, exit to normal viewing, and then switch between digital TV and Radio.









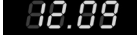

INFO

Display the channel banner, then program details, and then return to normal viewing.

Front Panel Display

The front panel LED display gives you information about the current state of your receiver. Refer to the table below.

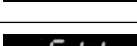
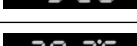
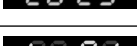
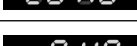
Status indicator table

	First installation setting.
	Channel installation is in progress.
	Current time displayed in 24-hour format when the box is in the standby mode.
	Receiver is tuned to one of the TV channels.
	Receiver is tuned to one of the radio channels.
	Recording is in progress.
	The VCR connected to the VCR SCART of your receiver is playing back a tape. Stop VCR play back to return to the viewing mode.
	Your decoder is switched into the TV mode. Press the TV/STB remote control key to return to the STB mode.
	Your decoder is switched into the STB mode.
	Dot on the right-hand side blinks when you press remote control keys.
	Receiver update is in progress.
	On the currently tuned channel, there is an interactive application available. This icon blinks during mhp applications loading.
	"c" letter on the left part of display indicates a modem connection. It blinks during initialization of connection.

1.2 Rear view

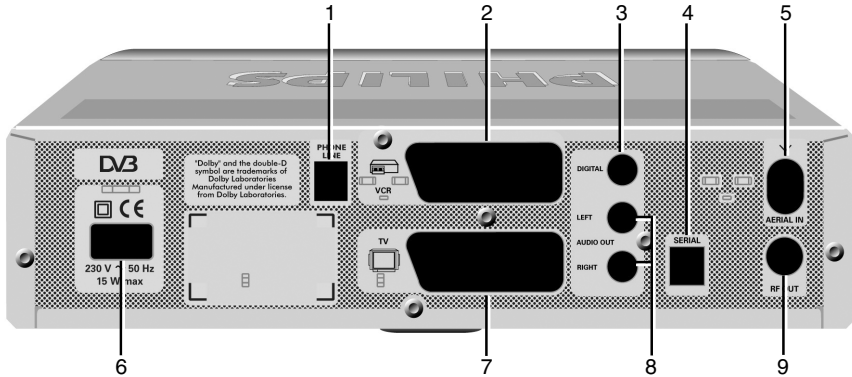

- 1 Telephone Line***** To connect the supplied telephone cord to be connected to your telephone line using the appropriate adapter (adapter not supplied).
- 2 VCR SCART* (1)** To connect a SCART lead to be connected to the SCART socket input (EXT1) of your VCR or DVD Recorder.
- 3 Digital Audio*** To connect to one of the digital audio input of your HiFi /audio receiver system.
- 4 Serial*** Data interface used during servicing.
- 5 Aerial In*** To connect the plug of your aerial cable.
- 6 230V~50Hz 15W max.**** To connect the supplied mains cord to be connected to the power socket.
- 7 TV SCART* (1)(2)** To connect the supplied SCART lead to be connected to the SCART socket input of your TV set.
- 8 L/R Audio Output*** To connect to the Left/Right audio Cinch* of your HiFi/audio receiver system.
- 9 RF Out*** To connect the supplied RF coaxial cable to be connected to the aerial input socket of your TV or VCR.

* SELV: Safety Extra Low Voltage.

** HV: Hazardous Voltage.

*** TNV 3: Telecommunication Network Voltage 3.

(1) SCART is also called Euroconnector or Peritel.

(2) The supply SCART lead is suited for RGB format which allows the best picture quality. Consult the user manual of your TV set to select its RGB capable SCART socket input.

Note: The label showing the type and the serial number is underneath your receiver.

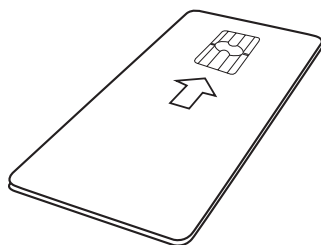

1.3 Smart card reader

Your receiver is fitted with a smart card reader. The smart card is intended for Pay TV channels or for future applications. Inserting your smart card shall be done on the front panel left side.

Note: the smart card golden or Silver contacts shall be facing up at card insertion.

2 Preparing, setting and using your Remote Control

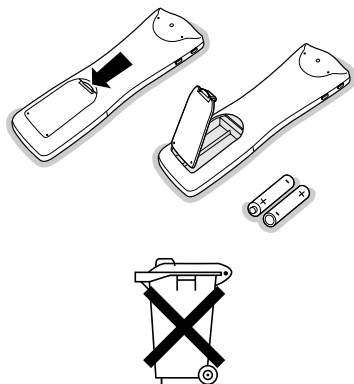

2.1 Installation of batteries

- Remove the remote control back cover.
- Insert the two batteries (type R06 /AA –1.5 V) supplied.
- Position them as shown in the diagram in the battery compartment.
- Replace the cover.

The Philips batteries supplied with your receiver's remote control do not contain heavy metals such as Mercury or Nickel Cadmium.

Nevertheless in many countries exhausted batteries may not be disposed of with your household waste. Please ensure you dispose of exhausted batteries according to local regulations.

2.2 Setting of your remote control

2.2.1 Mode setting

Your 5 in 1 Remote control allows the control of most of your Audio /Video equipment through various modes, which are: Terrestrial receiver mode so called STB (Set Top Box), TV, VCR, DVD and Amplifier-Tuner.

Pressing the MODE button once will remind you the mode you are in through blinking lights: left for STB, middle for TV, right for VCR, left-middle for DVD and middle-right for Amplifier-Tuner.

To set a given mode press the MODE button several times until the desired mode is signalled by the light(s). The setting sequence is STB → TV → VCR → DVD → Amplifier-Tuner.



2.2.2 Volume and mute control setting

When the remote control is set to STB mode the Volume +/Volume -/Mute buttons can either control the corresponding functions of your TV sets or the corresponding function of your digital receiver. Refer to chapters 2.2.2.1 or 2.2.2.2.

Note: we recommend Volume and mute control via your digital receiver. Refer to chapter 2.2.2.1 for setting.

2.2.2.1 You want the remote to control the volume and mute via your digital receiver (recommended).

To set the volume/mute control to STB.

- 1 Select the STB mode.
- 2 Press simultaneously 1 and 9 buttons until the LED blinks twice then release the buttons.
- 3 Enter code 993, the LED is blinking once after each digit entry.
- 4 Press the "green" button, the LED shall blink twice to acknowledge the new setting.

2.2.2.2 You want the remote to control the volume and mute of your TV set /Set volume control to TV.

The factory setting of your remote is set to allow the control of the volume /mute of a Philips TV set. If your TV set has a different brand check in the TV brand list what code(s) might apply then change the setting of your remote control according to the method described in chapter 9.1.

Note: to set or reset the volume/mute control to TV follow procedure below:

- 1- Select the STB mode.
- 2- Press simultaneously 1 and 9 buttons until the LED blinks twice then release the buttons.
- 3- Enter code 993, the LED is blinking once after each entry.
- 4- Press the "yellow" button, the LED shall blink twice to acknowledge the new setting.

2.2.3 Changing the brand setting of your remote control for TV, VCR, DVD or Amplifier-Tuner

Refer to chapter 9 for brand setting procedure.

2.3 Using the remote to control your digital receiver –The remote control is set to STB mode

Standby

Switches your receiver into the standby mode.

MODE

Selects the remote control mode (STB, TV, VCR, DVD, AMP-TUNER).

RED, GREEN, YELLOW, BLUE

Contextual buttons used in MHP applications.

FAV

Open / close the current channel list.

GUIDE

Open / close the Program Guide

RADIO

Toggle between **TV** and **Radio** modes. Wake up from standby.

MENU

Opens / Closes the **Menu**.

II

Open the **Options** menu to change momentarily soundtrack / subtitles / teletext / display format setting.

▲ ▼

- Switches the **Channel Banner** in the browsing mode.
- Scrolls selection up/down in a menu or channel list.

◀ ▶

- In **Channel Banner**, switch between the current and next program.

OK key

Confirms your choices.

REC

Open the **Setting a Timer** screen.

↔ +/-

Change the volume level on your TV or Digital Receiver (refer to 2.2.2.2 for setting).

WHITE/TEXT

TXT button used in MHP applications.

EXIT

Returns to normal viewing mode. If **[EXIT]** is pressed and held for at least 2 seconds, the currently launched application is killed and normal viewing is resumed. After that the "autostart" status is switched off temporarily as long as the box is tuned to this channel.

P+ / P-

- In viewing mode: Tunes to the higher/lower channel within the same channel list.
- scrolls one page up or down in channel list
- In standby Wakes up the Digital Receiver.

BACK

- In viewing mode: Returns to the previously tuned channel
- In menu mode returns to the previous screen.

MUTE

Mutes the sound on your TV or Digital Receiver (refer to 2.2.2.2 for setting).

0-9

- In viewing mode: Selects channels
- In menu; Selects directly menu item or Sets new parameter value
- In standby Wakes up the Digital Receiver.

Switches between viewing mode, **Channel Banner**, and **Channel Banner** with **Extended Info**.

TV/STB

Toggles between watching terrestrial digital programs via your receiver and standard analogue programs via your TV set.

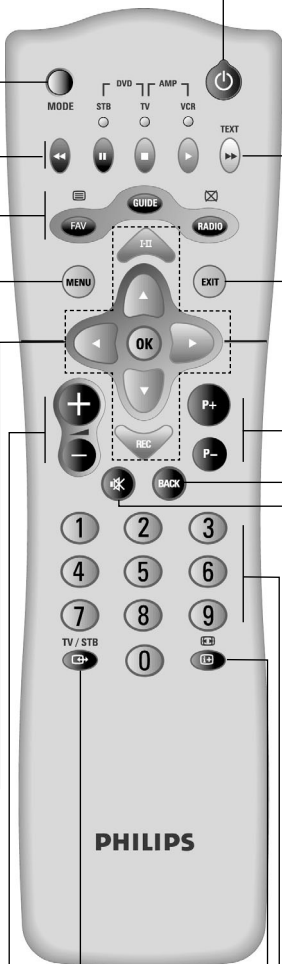

3 Connection and Installation

3.1 Connections

3.1.1 Connect the receiver to your TV and VCR

Incorporate the receiver in your existing installation as shown below / decoder receiver.

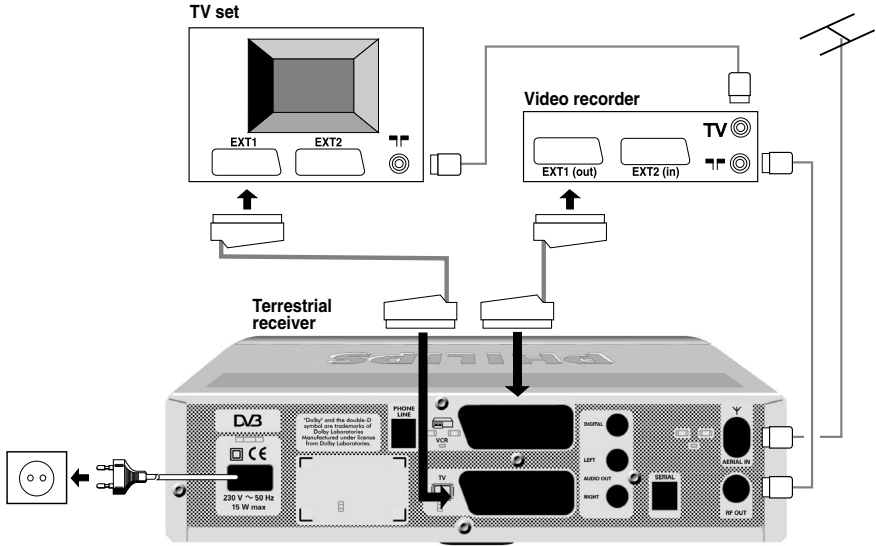

- 1 Plug your aerial lead plug into the "AERIAL IN" socket of your digital receiver.
- 2 Connect the "RF OUT" socket of your digital receiver to the "Aerial input" socket of your VCR by means of the RF coaxial lead supplied with your digital receiver.
- 3 Connect the "RF OUT" socket of your VCR to the "Aerial input" socket of your TV set by means of a RF coaxial lead.
- 4 Connect the "TV" SCART socket of your digital receiver to the RGB capable SCART socket of your TV set by means of the SCART lead supplied with your digital receiver.
- 5 Connect the "VCR" SCART socket of your digital receiver to the "EXT1" SCART socket of your VCR (so called OUT) by means of a SCART lead.
- 6 Plug all your equipment, excluding your digital receiver, into the mains.
- 7 Go to chapter 3.2 to proceed with the channel scan of your digital receiver.

Notes:

- 1- This connection also applies if your VCR has one SCART socket.
- 2- With this connection set up you can:
 - Watch digital TV while you record analogue TV.
 - Watch analogue TV while you record digital TV.
 - Record the digital TV channel you are watching.
 - Watch Play Back from your VCR.

3.1.2 Connect your HiFi appliance

Depending on your HiFi /Audio receiver equipment, you might have several options to connect your digital receiver.

- **Analogue connection**

Connect the L/R audio output sockets to the relevant L/R audio input sockets of your audio equipment by means of a double CINCH cable (not supplied). Consult the user manual of your HiFi/Audio receiver equipment to choose the proper analogue audio inputs.

Note: With this connection set up you can control the audio volume up/down and mute with the remote control of your digital receiver and alternatively with your HiFi's remote control.

- **Digital connection**

Connect the audio "DIGITAL OUTPUT" socket to the relevant digital audio input socket of your audio equipment by means of an appropriate connection (not supplied). Consult the user manual of your HiFi/Audio receiver equipment to choose the proper digital audio input.

Note: With this connection set up you can only control the audio volume Up/Down and mute with your HiFi /audio receiver remote control, refer to its User Manual.

3.1.3 Connect your receiver to the telephone line

Connect the Telephone Line socket to the wall telephone outlet by means of the supplied telephone cord and appropriate adapter (adapter not supplied).

Note: The equipment has been approved pursuant to Commission Decision 99/303/EC for pan-European connection to the public switched telephone network (PSTN). However, due to differences between the individual PSTNs provided for in different countries, the approval does not, of itself, give an unconditional assurance of successful operation on every PSTN network termination point.

In the event of problems, you should contact your equipment supplier in the first instance.

3.2 Receiver installation

- 1 Switch on the TV set and select a channel.
- 2 Plug the Receiver's power supply cord to the mains. The receiver front panel LED gets on, then the display.
- 3 Now you should see the **Welcome** screen on your TV screen. After a few seconds, the **Welcome** screen disappears.
- 4 Then, a screen appears that allows you to select the language. Highlight the desired language by pressing **▼/▲** and then press **OK**.
You are prompted to confirm your choice by pressing **OK** again.
- 5 Next, highlight the country where you operate the receiver by pressing **▼/▲** and then press **OK**.
You are prompted to confirm your choice by pressing **OK** again.
- 6 A screen appears that allows you to select the TV screen format corresponding to your TV set. Highlight the appropriate format by pressing **▼/▲**. Press **OK** to initiate the channel search.
Search operation is indicated by segments moving around the display.
- 7 Once it has been completed, follow the prompts displayed on the screen.
Press **OK** to store any found channels and tune the box to the first found TV channel.
Now you are ready to enjoy viewing your terrestrial receiver. Refer to chapter 4 Day to Day operation to learn more about using your receiver.

Note : If any of the WELCOME, Language selection or Country selection screen is not displayed, press two times the TV/STB button to get the screen displayed.

3.3 Installation error

Scanning failed. Before starting a new scanning, check:

- the aerial cable;
- the aerial cable connection to your digital receiver. Refer to the connection diagrams in chapter 3.1.1;
- channel(s) availability in the region corresponding to your area;
- signal quality, from the Signal Meter screen:
 - press Menu from the First Time Installation screen to access the Main Menu;
 - select the Installation submenu, and then the Signal Meter item. The Signal Meter;
 - select the appropriate channel number (tuner **Locked**) using the ◀ or ▶ buttons and check the corresponding signal strength and quality levels. If the signal is good enough, press **BACK** three times to return to the First Time Installation screen, and then **OK** to launch a new scanning. When scanning ends successfully, press **OK**.

Note: if you could still not install the channels after checking the quality of the signal delivered by your aerial, either your aerial is not pointing properly at the digital TV transmitter or your aerial installation needs to be upgraded, or you are not in the coverage area to correctly receive digital television.

For a proper diagnosis, call your electrical retailer.

4 Day to Day operation

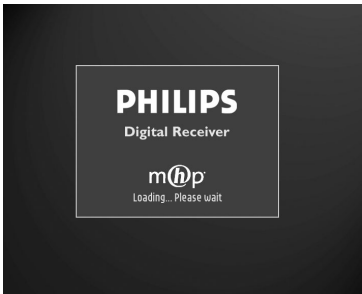

4.1 Connecting your receiver to the mains

When you connect your receiver to the mains, the receiver front panel indicator gets on, after a few seconds the **Welcome** screen is shortly shown then after few tenth of seconds the receiver is either in standby or in viewing mode.

4.2 Turn ON your receiver or switch to low power

You watch TV or listen to the radio; press the **LOW POWER** button on the front panel to switch your receiver to low power.

Your receiver is in low power. The only way to turn it on is to press the **LOW POWER** button on the front panel.

4.3 Wake up your receiver or Switch to standby

- You watch TV or listen to radio, press the standby button to switch your receiver to standby.
- Your receiver is in standby, to wake it up:
 - Either press the **P+**, **P-**, **RADIO** or any digit button on the remote control.
 - Or press one digit button.
 - Alternatively, press the **PROG-/PROG+** or **TV/RADIO** button on the front panel.

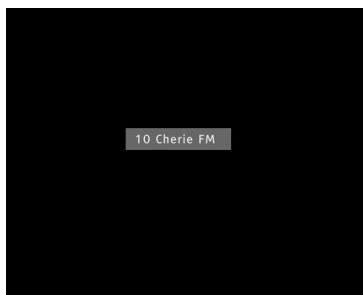

Radio Label

4.4 Select TV or Radio mode

Your receiver may work in two modes: **TV** or **radio**. To switch between these two modes, press the **RADIO** key. If you are watching one of the TV channels, pressing **RADIO** tunes to the last tuned radio channel belonging to the previously selected channel list. Pressing **RADIO** again returns to the TV mode -to the last tuned TV channel. Alternatively, use the **TV/RADIO** front panel button.

On switching the mode, the **Channel Banner** appears for its timeout. In the radio mode, the radio label appears/disappears at random positions on the screen to avoid damaging your TV screen.

4.5 How to switch between channels in the list

Your receiver gives you access to TV Channel List and to **Radio Channel List**.

To display the currently selected channel list, press the **FAV** key. To change the channel list press **◀** or **▶** keys. Then select the channel by pressing **▲** or **▼**, or number keys. Each time you highlight a non-current channel, the **OK** icon appears in the **Channel Banner**. To tune to this channel, press **OK**.

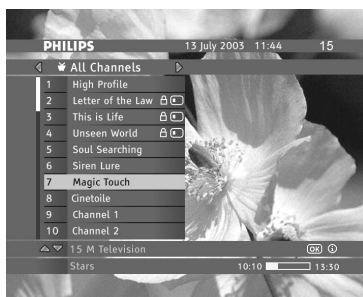

TV Channel List







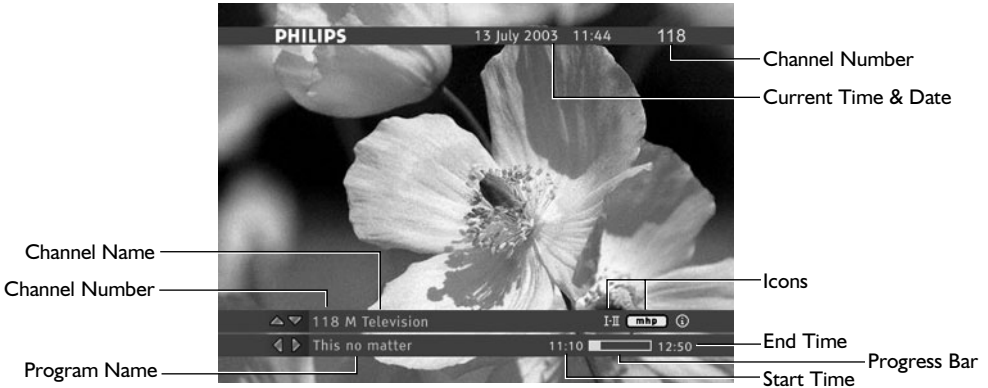







Note: Channels lists allow you to work in so-called browsing mode. In this mode, the box remains tuned to the same channel, while you browse through channels and programs.

4.6 How to use the channel Banner

Channel Banner appears at the bottom of the screen when you tune your receiver to a new channel or when you press the **INFO** key. It offers you basic information about individual programs and facilitates surfing through channels and programs. When you are in the **Channel Banner**, you can only browse through channels belonging to the currently selected channel list. The **Channel Banner** disappears automatically after a few seconds, or when you press **EXIT**.



4.6.1 Channel Banner Icons

	This icon informs that some program information is available for the program displayed in Channel Banner .
	This icon informs that the current channel is locked.
	This icon informs that a viewing reminder has been set for a particular program.
	This icon informs that a recording reminder has been set for a particular program.
	This icon informs that a program with more than one soundtrack is broadcast.
	This icon informs you that pressing OK tunes to the channel that the Channel Banner refers to, or sets/cancels a reminder.
	This icon informs you that the program is broadcast with AC3/Dolby Digital sound.
	This icon informs you that the particular program is parentally locked.
	This symbol informs that you may launch external applications by pressing OK .
	This icon informs you that an mhp application is loading.
	This icon informs that teletext is broadcast on the currently tuned channel.
	This icon informs that you may select subtitles for the current program.
	This icon informs that you may select subtitles intended for deaf or hard-of-hearing viewers for the current program.
	This icon informs you that the current channel is scrambled.



Current Program Info



Channel Number Entry Box



Option Menu

4.6.2 How to Select Current /Next Programs

The **Channel Banner** allows you to display information concerning the current program and the next program broadcast on the selected channel. Press ◀/▶ to see what is broadcast next on the currently selected channel. If you select one of the future programs, pressing **OK** allows you to set/cancel a reminder. For more information on setting reminders, see the Reminders and Timers section later in this manual.

4.6.3 How to Select Channels

There are three different ways of changing channels:

- When the banner is activated, press ▲ or ▼ to scroll through the current channel list. Please note that your receiver remains tuned to the current channel. Press **OK** to confirm.

Note: In case of a list containing only one channel, ▼ and ▲ do not appear.

- When you press **P+/P-**, your receiver tunes to the next higher/lower channel from the currently selected channel list. Alternatively, use the **PROG-/PROG+** button on the front panel.
- You can also select channels by entering their numbers directly. Once you press a number key, the channel number entry box appears in the upper right corner of the screen.

- Please note that pressing **BACK** allows you to switch between two channels: the current channel and the previously tuned channel within the selected channel list.

Note:

- 1- Skipped channel cannot be watched using **P+** or **P-** button channel selection.
- 2- Skipped channels can only be selected either using the digit buttons or from the channel list.

4.7 How to Change momentarily the current Program Options

Press the **III** key to gain access to the **Options** menu. This menu allows you to change the Audio Language, Subtitle Language, or the Display Format for the currently broadcast program, and the Teletext Language for the currently tuned channel.

Audio Language

If available, you can select among different audio languages.

Subtitle Language

If available, you can select among different subtitle languages.

Teletext Language

If available, you can select among different teletext languages.

Display Format

For information on available formats, refer to chapter 6.4.2.1.



Program Info Window

4.8 How to Display More Program Info

The **i** icon displayed in the **Channel Banner** informs that pressing the **INFO** key displays some additional information about the currently selected program. If there are more pages of program info, pressing **INFO** displays consecutive pages of program info. To remove the **Program Info** window from the screen, press either **EXIT** or **INFO** when the last page of program info is displayed, or change channel.

4.9 MHP Interactive Applications

4.9.1 How to run MHP Applications

Your receiver supports downloading and running MHP interactive applications. Some applications are run automatically on tuning to a respective channel. Other applications need to be launched manually.

If you tune to a channel on which interactive applications are broadcast, you will see the **mhp** icon on the **Channel Banner**. This icon is displayed alternately with the **LOAD** icon if applications are run automatically or with the **OK** icon otherwise. Simultaneously the front panel will display the MHP indication.



Interactive Applications Icon

In case of manual applications pressing **OK** brings up the **Applications** window allowing you to select the application you want to run. Once you select the application, press **OK** again. However, if you are not interested in running interactive applications, press **EXIT** to remove the **Applications** window from the screen.



Applications Window

Once the application is running follow the instruction given by the application played on screen.

To quit the interactive application, press and hold the **EXIT** key for at least 2 seconds. You can also quit the application by following the on-screen descriptions brought to you by the application itself or tuning to a different channel by pressing **P+ / P-**

Please note that if you do not want any interactive applications to be run automatically, set the **Application AutoSTART** option in the **Display Options** screen to **NO**.

4.9.2 Country specifics

4.9.2.1 Finland

LAUNCHING / STOPPING MHP APPLICATION

- After selection of a program, if an MHP application is available **MHP** will be shown on the receiver front panel display.
- Press the **BLUE** button to show list of available applications.
- Select desired application with arrow keys and press **OK** to start application, then follow the instructions given by the application played on screen.
- Alternatively, you can access directly to some applications by pressing the following coloured keys:
 - **WHITE / TEXT** key to access the **SuperTeletext** application,
 - **YELLOW** key to access the **Program Guide** application,
 - **RED** key to access interactive applications related to current program. In that case, a red icon shall be displayed on screen to inform viewer that an interactive application is present.
- Pressing again the coloured key will hide the application.
- If you want to remove the application, press the **EXIT** button for more than 2 seconds or change program.

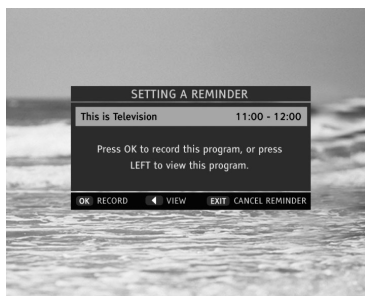

Setting a Reminder



Setting a Timer

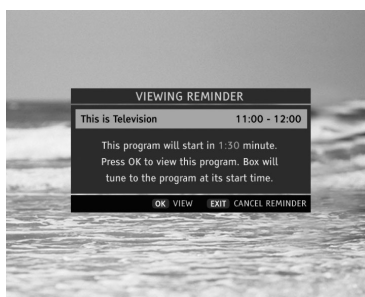

Viewing Timer Pop-up



Recording Interruption Pop-up

4.10 Reminders and Timers

4.10.1 Difference Between Reminder and Timer

The aim of the reminder/timer is to remind you that the program you scheduled for viewing is about to start. The main difference between a reminder and a timer is that you set reminders from the **Channel Banner** or **Program Guide**. To set a reminder, select one of the future programs of the **Channel Banner** or **Program Guide**, and press **OK**. Then you are prompted to decide whether you want to set a viewing or a recording reminder.

Timers are independent from the broadcast schedule. You will set timers from the **Timer Manager**. To get access to the **Timer Manager**, either press the **REC** button or select the **Timer Manager** item from the **Main Menu**. **Timer Manager** contains all timers and reminders defined so far. It allows you not only to set timers but also to delete or modify selected timers/reminders. You will be asked to enter **Timer Manager** each time any conflicts between reminders/timers occur. You will find more information on **Timer Manager** later in this manual.

4.10.2 Viewing and Recording Reminders/Timers

There are two types of reminders/timers: a **viewing reminder/timer** and a **recording reminder/timer**. If you have set a reminder/timer, its pop-up appears 1.5 minute before the program starts. If you do not respond to the viewing reminder/timer pop-up, the reminder/timer is canceled. If you do not respond to the recording reminder/timer pop-up, the receiver tunes to the appropriate channel at specified start time.

Please note that when you set a recording reminder/timer, the recording is protected from being interrupted, which is indicated on the rotary display. If you want to interrupt the recording, press **EXIT**. This brings up a pop-up informing you how long the recording will last. Then, you will be asked to press **OK** to interrupt the recording or press **EXIT** to dismiss the pop-up from the screen.

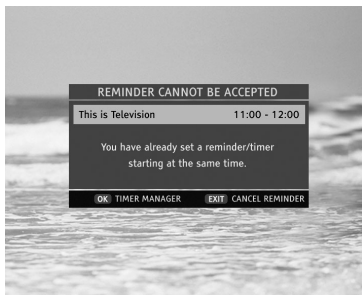

Reminder Conflict Pop-up



Timer Manager



Modifying a Timer

4.10.3 Reminder/Timer Conflicts

Your receiver allows you to set up to 8 reminders/timers. Each subsequent reminder/timer is checked against any conflicts with the previously set reminders/timers. If you set a reminder or timer and such a conflict occurs, a conflict pop-up appears. You will be prompted to press **EXIT** to cancel the current reminder, or to press **OK** to get access to **Timer Manager**. The currently set reminder will be listed in the **Timer Manager** as a disabled reminder (marked with the "?" sign).

This reminder can only be accepted if you delete any conflicting timers/reminders or you change some of its data.

For more info, see the **Timer Manager** section below.

4.10.4 Timer Manager

Timer Manager contains a list of all reminders and timers defined so far. In the **Timer Manager** you can perform the following operations.

Setting a Timer

Press **OK** to set a new timer. This will bring up the **Setting a Timer** screen. Fill in any required data and press **OK** to confirm. If the data are valid and there are no conflicts with the previous reminders/timers, you return to the **Timer Manager** screen. The newly defined timer appears in the **Timer Manager** list.

Modifying Reminders/Timers

In the **Timer Manager** screen, highlight the timer/reminder you want to modify and then press **►**. This will bring up either **Modifying a Timer** or **Modifying a Reminder** screen. Change the reminder/timer data and then press **OK** to confirm.

Deleting Timers/Reminders

Highlight the reminder/timer you are not interested in and press **◀**. Then you will be prompted to confirm the delete operation.



Program Guide

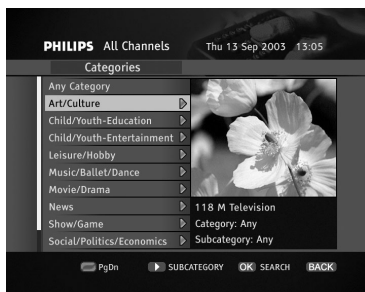

Category selection

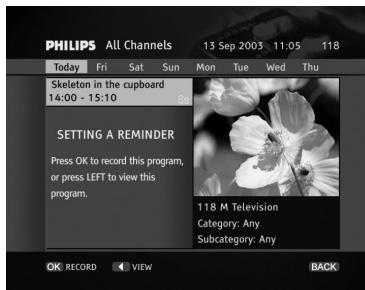

Setting a reminder in Program Guide

4.11 Program Guide

Your receiver gives you access to a Program Guide.

To display all programs broadcast on the currently tuned channel press the **GUIDE** key. The displayed list contains all programs of the current day and highlight is on the currently broadcast program.

You can scroll through the program list using the **▲/▼** or the **RED / GREEN** keys.

To display the program list of the next days, press the **◀/▶** keys. Program list will be updated.

Pressing **P+ / P-** allows you to display the program list of subsequent channels from the currently selected channel list. If no information are available it will be reported by an "On Screen" message.

You can also filter the program list to display only programs that belong to a selected category. Pressing the **YELLOW** key allows you to access to the Category filtering menu. Once you have selected the desired Category and sub-category, press **OK** to update the current program list accordingly.

To set a viewing or recording reminder on one of the future program, bring the highlight on the selected program using the **▲/▼** keys. Then press **OK** to display the setting/canceling reminder menu. The procedure of setting a reminder in the Program Guide is the same as for a program selected in the **Channel Banner**. Refer to chapter 4.10 of this manual.

5 Main Menu

Your receiver offers **Menu System** that allows you to change the way many of the features of your receiver operate. To gain access to the **Menu**, press the **MENU** key. The **Main Menu** consists of 7 submenus. To evoke one of the submenus, highlight its name using **▲** or **▼** keys and then press **OK**. You may also press the number key to directly access the respective menu item. To return to the **Main Menu** from one of its submenus, press **BACK**. To exit the **Menu System** immediately, press **MENU** or **EXIT**.

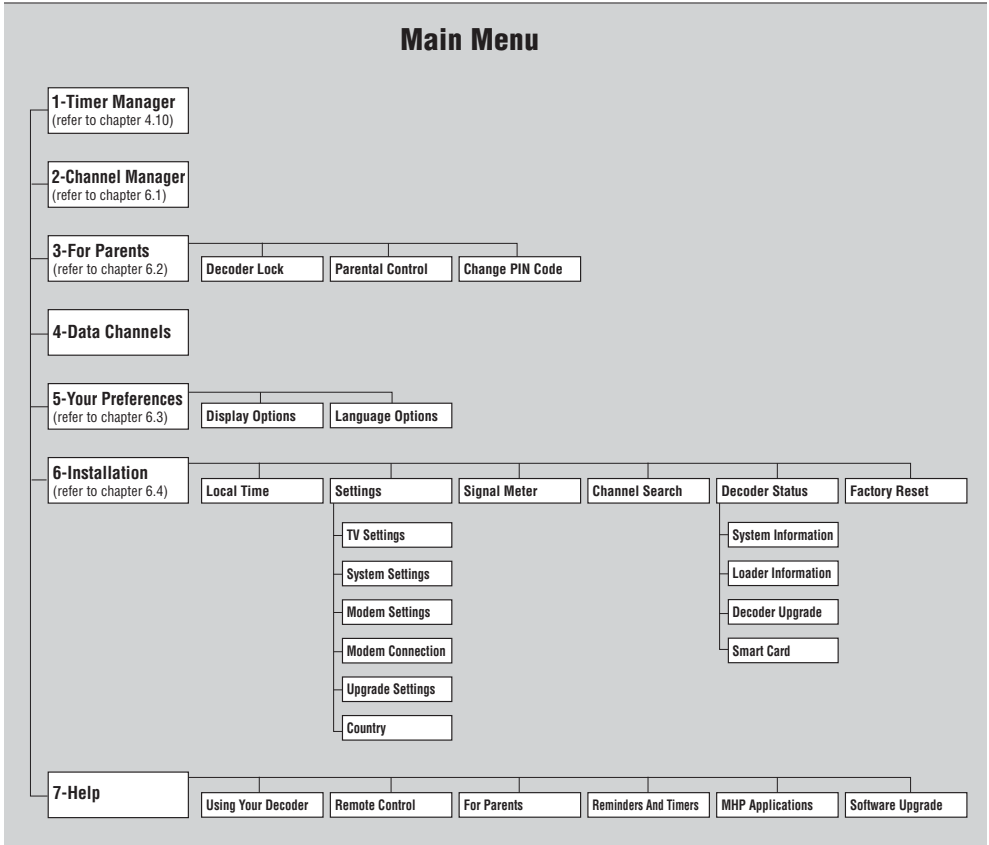

6 Change the setting of your receiver



Channel Manager



Skipping a Channel



Moving a Channel Within a List

6.1 Channel Manager

Allows you to change the organization of the TV and Radio channel lists. You will be able to skip, move, lock and rename selected channels.

When you select the **Channel Manager** item from the **Main Menu**, you get access to **Channel Manager** submenu.

- 1 Select **TV** or **RADIO** respectively for TV and radio channel lists.
- 2 Select the subset channel list you want to modify.
- 3 Select the **Modify** option you want to use.
- 4 Press **OK** to confirm.

6.1.1 How to skip a channel

The **Skip Channels** command allows you to mark any channel to be skipped in the zapping and browsing mode. Once you select the **Skip Channels** command in the **Modify** option, the selected list of channels appears with the highlight on the currently tuned channel. Simply select the channel you want to skip and then press **OK**. This marks the channel with  symbol. You can remove the "skipped" status by pressing **OK** on the skipped channel.

Note:

- 1- Skipped channel cannot be watched using **P+** or **P-** button channel selection.
- 2- Skipped channels can only be watched using the digit button channel selection.

6.1.2 How to move a channel

The **Move Channels** command allows you to mark any channel to be moved. Once you select the **Move Channels** command in the **Modify** option, the selected list of channels appears. Simply select the channel you want to move and then press **OK**. This marks the channel with  symbol. Then you can move this channel by pressing **▲ / ▼**, **P+ / P-**, number buttons and then press **OK** again to confirm its new position.



Renaming a Channel



Locking a Channel

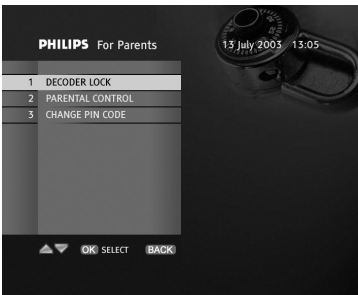

For parents Submenu



Receiver lock

6.1.3 How to rename a channel

The **Rename Channels** command allows you to rename any channel on the list. Once you select the **Rename Channels** command in the **Modify** option, the selected list of channels appears. Simply select the channel you want to rename and then press **OK**. This brings up the virtual keyboard pop-up where you will be able to find any characters you need. When you rename the selected channel, pressing **OK** will confirm the change and close the virtual keyboard pop-up.

6.1.4 How to lock a channel

The **Lock Channels** command allows you to mark any channel to be locked. Once you select the **Lock Channels** command in the **Modify** option, the selected list of channels appears. Simply select the channel you want to lock and then press **OK**. This marks the channel with  symbol. You can remove the "locked" status by pressing **OK** on the locked channel.

*Note: channel locking is only enabled if the **Decoder Lock** option is activated.*

6.2 Specially for parents

The **For Parents** submenu allows you restrict access to your receiver using protection by PIN code. Here, you can also change your current PIN code.

Press the **MENU** key and then select the **For Parents** submenu to bring up a list of protection items. The following protection levels are available:

- prevent access to locked channels (refer to 6.1.4);
- prevent access to programs unsuitable for the audience younger than the selected **Parental Control** setting;
- prevent access to the **Installation** menu.

6.2.1 Decoder Lock

This item is used to enable the various locking features of your receiver. If you switch the **Decoder Lock option** to **No**, you disable all locking features, and thus you will not be prompted to enter your PIN code. If you switch the **Decoder Lock option** to **Yes**, you enable all locking features, i.e. channel locks, Parental Control, and Installation, and thus you will be prompted to enter your PIN code.



Parental Level



Enter PIN Code

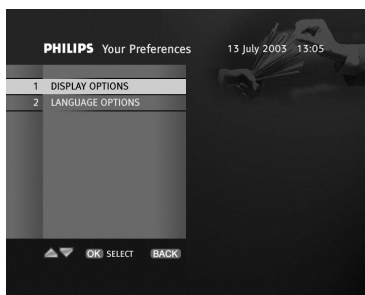

Your preferences Submenu

6.2.2 Parental Control

The **Parental Level** option allows you to set the current parental level, for example **13 Years**. Then any programs unsuitable for the audience younger than 13 years will be blocked from viewing.

6.2.3 Change PIN code

Your PIN code is your personal 4-digit.

Initially, Your PIN code is assigned the value 1234. You can change it using the **Change PIN code** item for the **For Parents** submenu. Choose a value you can easily remember. If you happen to forget your PIN code, refer to the Troubleshooting chapter of this manual.

6.3 Your Preferences

Allows you to define your preferences concerning on-screen display as well as audio and subtitle languages.

Your Preferences submenu contains two items: **Display Options** and **Language Options**.

6.3.1 Display Options

The **Display Options** screen allows you to define some options related to displaying information on the screen.

Time and Date

Blocks the current time and date from being displayed in the Channel Banner.

Channel Number

Blocks the channel number from being displayed in the Channel Banner.

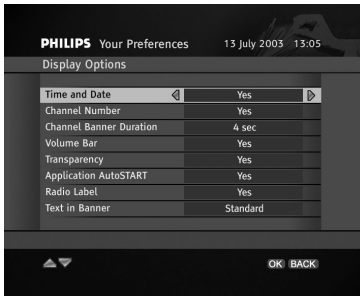

Display Option Screen

Channel Banner Duration

Specifies how long the Channel Banner remains displayed.

Volume Bar

Blocks the volume bar from being displayed.

Transparency

Changes the transparency of the on-screen display.

Application AutoSTART

Defines whether MHP applications are to be launched automatically once you tune to a channel on which external applications are broadcast.

Radio Label

Defines whether "radio labels" shall be displayed when the box is tuned to one of the radio channels.

Text in Banner

Defines the font size used to display channel name and program name as well as program info.



Language Options Screen

6.3.2 Language Options

The **Language Options** screen allows you to define some options related to the menu language, audio languages, subtitle languages, and teletext language. Change any languages according to your preferences and then press **OK** to confirm them.



Installation Submenu



Local Time Submenu



Settings Submenu

6.4 Installation

Allows you to configure your system, set up your modem, search for existing channels, check receiver's status, set up local time, and restore factory settings of your receiver.

Once your terrestrial receiver has been properly installed and configured, you will rarely use the **Installation** submenu. However, the **Installation** submenu will be useful, if for example, you buy a new TV and you want to make sure your receiver makes the best use of the new TV's features, or if you change your antenna setup.

Below, you will find description of some of the **Installation** submenu screens.

*Note: When the decoder is locked, access to the **Installation** menu is protected by PIN code.*

6.4.1 Local Time

You may need to adjust your local time. Use the ◀ / ▶ keys to change the **Time Zone** until the **Local Time** setting corresponds to your local time. Then press the **OK** key to confirm any changes.

6.4.2 Settings

The **Settings** submenu allows you to change TV/system/modem/upgrade/country settings.



TV Settings Screen

6.4.2.1 Installation / Settings / TV Settings

The **TV Settings** screen contains two options: **TV Screen Format** and **Display Format**.

The **TV Screen Format** allows you to adapt your receiver output to the aspect ratio of your TV set (4:3 or 16:9).

You can also modify the Display Format value to adapt the way the video is transformed in case the broadcast aspect ratio is different from your TV aspect ratio.

In such a case:

Aspect ratio / Display format	TV screen format = 4:3 broadcast format = 16:9	TV screen format = 16:9 broadcast format = 4:3
Letter-box	full picture with black bars at the top and bottom	full picture with black bars on the left and right
Pan-Scan	picture cut-off on the left and right	picture cut-off at the top and bottom
Full screen	full picture squeezed to fit	full picture squeezed to fit



System Settings Screen

6.4.2.2 Installation / Settings / System Settings

The **System Settings** screen contains some of the configuration parameters you may change.

Video Standard

This option is preconfigured depending on the **Country** selection. There are two possible standards: PAL and SECAM.

TV SCART Output, VCR SCART Output

Select the appropriate format of the output signals.

Note: to get the best picture quality and sharpness set the "TV SCART output" option to "RGB".

Dolby Digital

Default **Dolby Digital** setting is **No**. Do not modify this setting if your audio receiver supports PCM only (Stereo digital). If your audio receiver supports AC3 (multisound system Dolby Digital 5.1), set **Dolby Digital** to **Yes**.

You will find detailed info concerning: the **Easy Recording**, **Recording Type** and **Device** settings in the Advanced Settings section later in this manual (see chapter 7).

Default Volume level

This option is used to set the sound level at wake-up from standby. It is recommended to set it close to the maximum value.



Modem Settings Screen



Virtual Keyboard

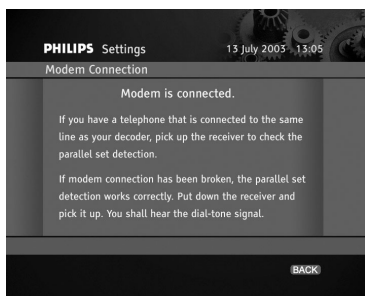

Modem Connection

6.4.2.3 Installation / Settings / Modem Settings

Your receiver is equipped with an internal modem. To configure your modem parameters use the remote control keys presented in the help bar. Pressing **RED** allows you to enter a virtual keyboard where you will be able to find any characters you need.

Once you have configured your modem, press **OK** to confirm its configuration.

Note: modem configuration is generally handled by the MHP applications.

6.4.2.4 Installation / Settings / Modem Connection

The **Modem Connection** screen allows you to check the modem connection as well as to check the parallel set detection. If any problems are detected, the appropriate message will be shown. In case no problems are detected, you will be able to check if the modem is connected by following the instructions on the screen.



Decoder Upgrade Settings

6.4.2.5 Installation / Settings / Decoder Upgrade Settings

Select **Upgrade Settings** from the **Settings** submenu. In this screen you can change the way your decoder is upgraded.

If you set **Auto Upgrade** to **Yes**, your decoder will automatically initiate the upgrade procedure when available. Otherwise you will be asked for permission to initiate the procedure.

If you want to be prompted to check for new upgrades every time you switch your decoder on, the **Upgrade Check After Power On** should be set to **Yes**.

You can also set the exact time and frequency of checks for new upgrades in **Upgrade Check in Operate Mode**. Note that your decoder must be in running mode in order to check for upgrade at the specified time.



Select Country

6.4.2.6 Installation / Settings / Country

Selecting **Country** item allows you to change any presets for a particular country. If you change the country and confirm your choice, your decoder will be configured to work in the country you selected.

Note that changing the country will initiate the channel search and you will lose your current channel list.



Signal Meter

6.4.3 Installation / Signal Meter

Selecting the **Signal Meter** from the **Installation** submenu brings up the **Signal Meter** screen. This screen displays the signal strength/level as well as the quality value of the signal broadcast at the specified frequency.

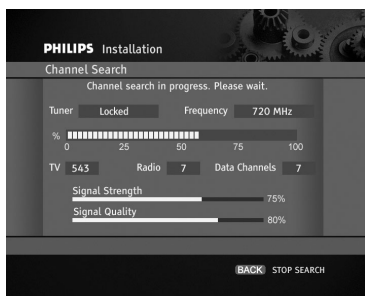

Channel Searching



Decoder Status Submenu

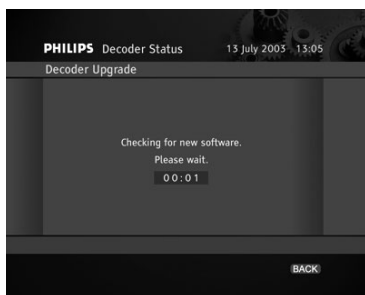

Receiver Upgrade



Factory Reset

6.4.4 Installation / Channel Search

Once you select the **Channel Search** item from the **Installation** submenu, you will have two channel search methods to choose from. You can either **Search for New Channels** or **Reinstall All Channel Lists**. In the first method only new channels will be added to your existing list, whereas in the second one your current channel list will be replaced by a new one. Pressing **OK** initializes the channel searching procedure. You may interrupt this procedure by pressing **BACK**. Follow the prompts displayed on the screen.

6.4.5 Installation / Decoder Status

The **Decoder Status** submenu gives you access to some system and loader information. It also allows you to perform the receiver upgrade procedure.

To check whether a new software version is available for your receiver, select the **Decoder Upgrade** item from the **Decoder Status** submenu. If new software exists, you will be prompted to press **OK** to initiate the upgrading process.

Once the upgrade process is initiated, it takes complete control of the receiver, so the receiver's normal operation is suspended. You may interrupt this procedure by pressing **BACK**.

Selecting the **Smart Card** item from the **Decoder Status** submenu gives you access to information concerning the inserted smart card.

6.4.6 Installation / Factory Reset

Once you select the **Factory Reset** option, the **Restore Settings** option is set to **No**. If you decide to restore all factory settings of the receiver, press **◀/▶** to change the value of the **Restore Settings** option to **Yes**. Pressing **BACK** returns to the **Installation** submenu.

Note that pressing **OK** restores factory settings of the receiver and restarts the first-time installation process (the **Language** screen appears).

7 Advanced Settings

7.1 Easy Recording

The **Easy Recording** feature allows you to perform recordings without the necessity to program your video recorder (VCR or DVD recorder). When you set a recording reminder or timer from the **Channel Banner** or **Timer Manager**, the VCR starts/ends recording at the correct time. Please note, however, that you may only use the **Easy Recording** feature provided that your recorder supports it.

- First of all, consult User Manual of your recorder equipment to check if it supports Easy Recording. Please note that most Philips VCR/DVD recorders support one of the two Easy Recording options: either **Prepare Record (to be checked first)** or **Record Link**.
- Also, both your TV and VCR shall be equipped with two SCART sockets.

If your equipment satisfies above two conditions, connect your receivers as shown in the Connection diagram below.

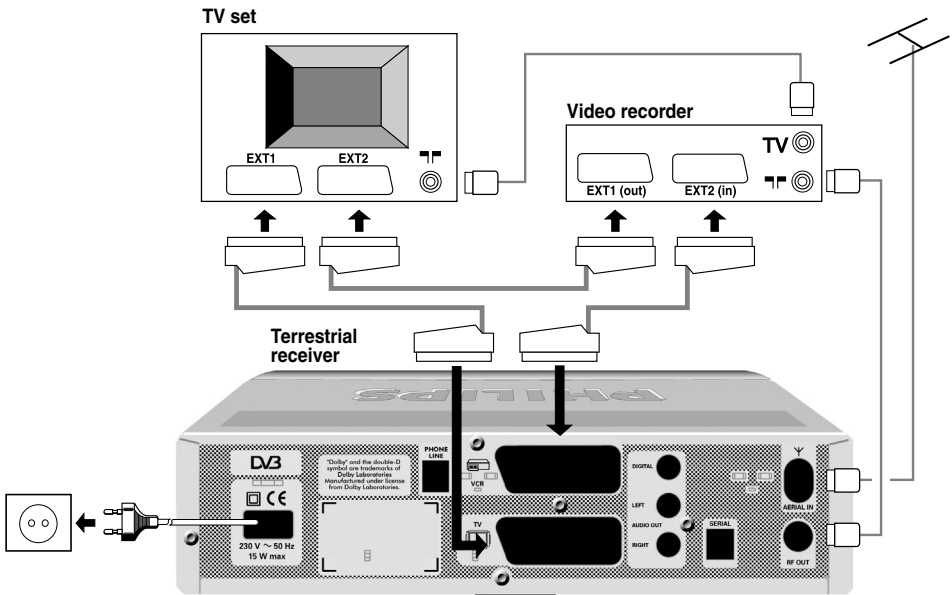

Then, select the **System Settings** item from the **Settings** submenu, enable the **Easy Recording** feature by setting its option to YES, and assign to the **Recording Type** an appropriate value: either **Prepare Record** or **Record Link**. You might have to test both settings to find out the one applicable for your recorder.

Assuming the settings of your receiver and recorder (refer to your VCR or DVD recorder user manual) are done, to perform a recording you shall:

- Program a timer with your receiver (refer to section 4.9)
- Put your recorder in the appropriate status to be controlled by your receiver (refer to the VCR or DVD recorder user manual).

At timer occurrence your recorder shall start and stop recording automatically.

*Note: While the recording is in progress, your receiver is protected from inadvertent action to disrupt the recording. Please note that during the recording the "rEc" label is displayed on the front panel display. To cancel the running recording, press **EXIT**. This brings up a small window prompting you for confirmation. To cancel the recording, press **OK**.*

7.2 Change the Remote Control and receiver "Device" Settings

If you have other equipment in your home and the Philips remote control of your digital receiver interferes with them, you can change the setting of your remote control and the setting of your receiver as well. By default, your receiver is recognized as Device 1 and the remote control is set to control Device 1. You may change this identifier to Device 2 using the System Settings screen from the Settings submenu. Please note however, that you will also have to change the remote control setting in order to be able to control Device 2.

To change the setting of your remote control, proceed as follows:

- 1** Make sure that the remote control is in the STB mode (Press Mode button, the STB LED shall blink, if a different LED does, press the Mode button as many time as necessary to get STB LED blinking).
- 2** Press number keys 1 and 3 simultaneously and hold them until LED blinks twice.
- 3** Release these two keys. The STB LED is still on to indicate that the remote control is in the programming mode.
- 4** Enter the new code setting within 60 seconds (the LED is blinking once after each digit entry):
Either 0048 for Device 2 or 0038 for Device 1 (factory setting).

Alternatively you may reset your remote control to its default setting (Device 1) by removing the batteries and waiting for more than 3 minutes to re-insert them.

8 Programming the Remote Control for your STB, TV, Video Recorder, DVD and Tuner - Amplifier

8.1 Setting up your remote control

By default at power up, for instance at first installation or at battery replacement, your remote control is preset to control your terrestrial receiver as well as most of the Philips audio/video appliances.

If you have other brands of appliances, or if the presets do not control your Philips appliance, please follow the procedure here below.

Note: some of the functions described in the next pages may not be available or have the same behaviour for all brand of the same appliances.

- 1 Press the **MODE** button to select the type of appliance you want to set up (TV, VCR, DVD or Amp/Tuner). Pressing the **MODE** button once will remind you of the **MODE** you are in through green light indicators: left for STB, middle for TV, right for VCR, left/middle for DVD, middle/right for Amp/Tuner.
To set the **MODE**, press the **MODE** button several times until the desired mode is signaled by the light(s). The sequence is: STB → TV → VCR → DVD → Amp/Tuner. At every key press, lights blink to indicate in which **MODE** you are in.
- 2 Press digits 1 and 3 simultaneously until the lights corresponding to the selected mode blink twice and remain on.
- 3 Enter the 4 digit code .The lights corresponding to the selected mode blink once at each digit entry. You will find a list of codes at the end of this manual. (If several codes are possible, go through this procedure with the 1st code and try your remote control. If you are not successful, repeat the procedure with the second code, and so on).
- 4 If a valid 4-digit code has been entered, the lights will switch off and blink twice. If not, go back to step 1. Pressing any key other than digit keys and **standby** button will automatically exit this procedure.

We advice you to fill in the table below to remind your personal remote control settings, this will be helpful the day you have to replace the remote control batteries (see NOTE 2 below).

	Philips Brand factory setting	Your appliance brand / type	Your code setting
TV set	0666		
Video Recorder	1608		
DVD player / Recorder	0566		
Amplifier / Tuner	1316 (Philips tuner)		
STB (Your Satellite Receiver)	0038 (Device 1)		
Volume control (see chapters 4.2.2.1 and 4.2.2.2)			

Important Notes:

- 1- You need to reset the STB mode to the factory mode.
If you have made a mistake changing the default setting of the STB mode resulting in the impossibility to control your terrestrial receiver, then please refer to above description.
- 2- Battery change.
If the battery change takes more than 1 minute the remote control may return to the "Philips brand factory settings". Therefore you shall proceed with a new setting of your remote control, with the help of the table above, for your non Philips branded appliances.
- 3- All manufacturers are concerned about the constant improvement of their products. Although the remote control is compatible with most equipment of the brands mentioned at the end of this manual (see Brand Code List), Philips cannot guarantee its operation with the complete range of products on the market.

8.2 Using your remote control for your TV**TV mode (TV)**

Note: Some of the functions described below may not be available or may not have the same behaviour for all appliances.

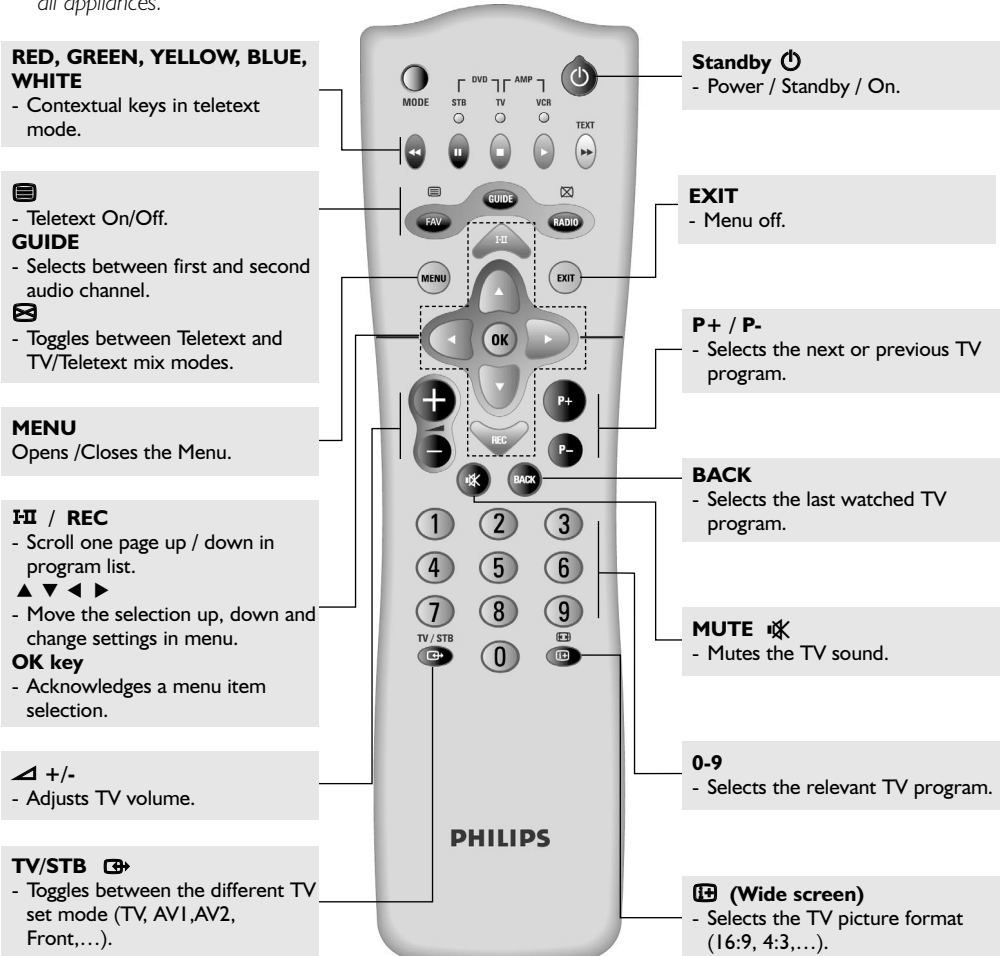

8.3 Using your remote control for your VCR

VCR mode (VCR)

Note: Some of the functions described below may not be available or may not have the same behaviour for all appliances.

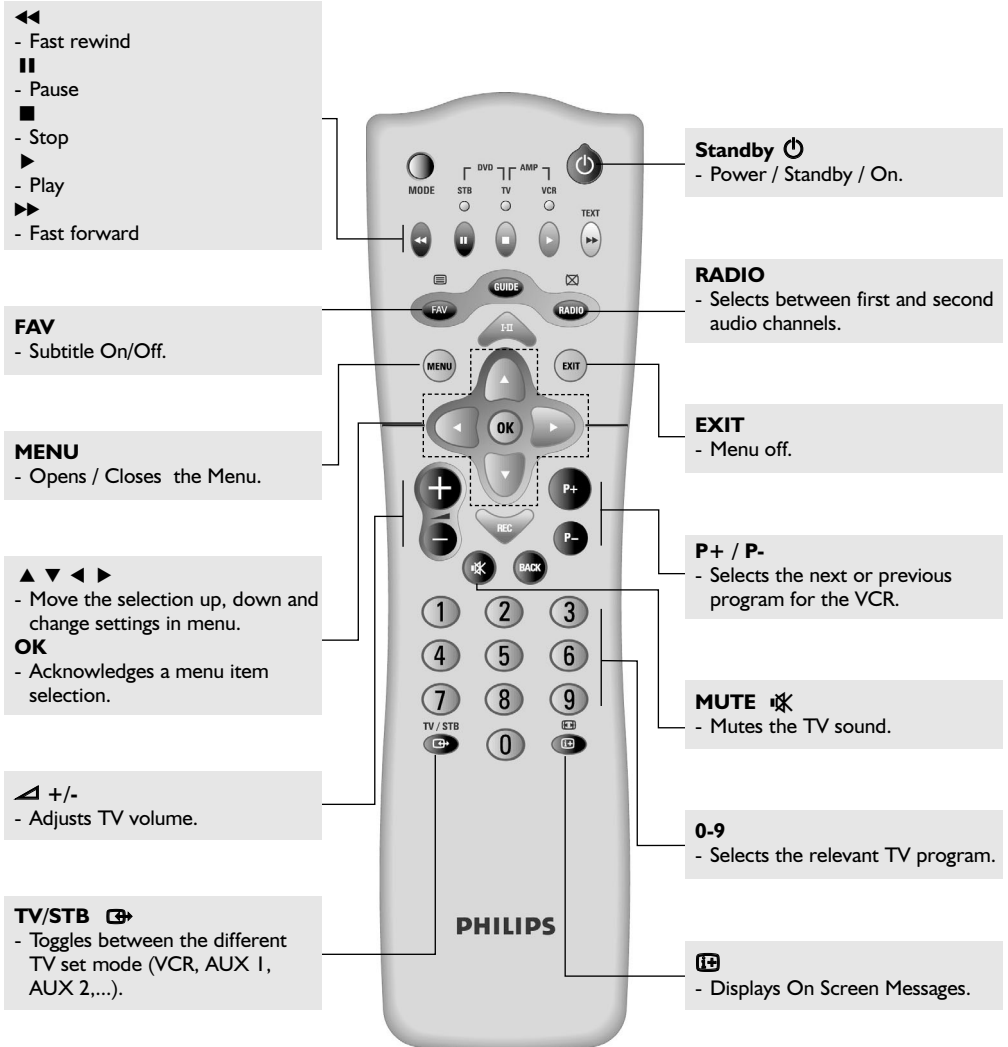

8.4 Using Remote Control For Your DVD Player

DVD mode (DVD)

Note: Some of the functions described below may not be available or may not have the same behaviour for all appliances.

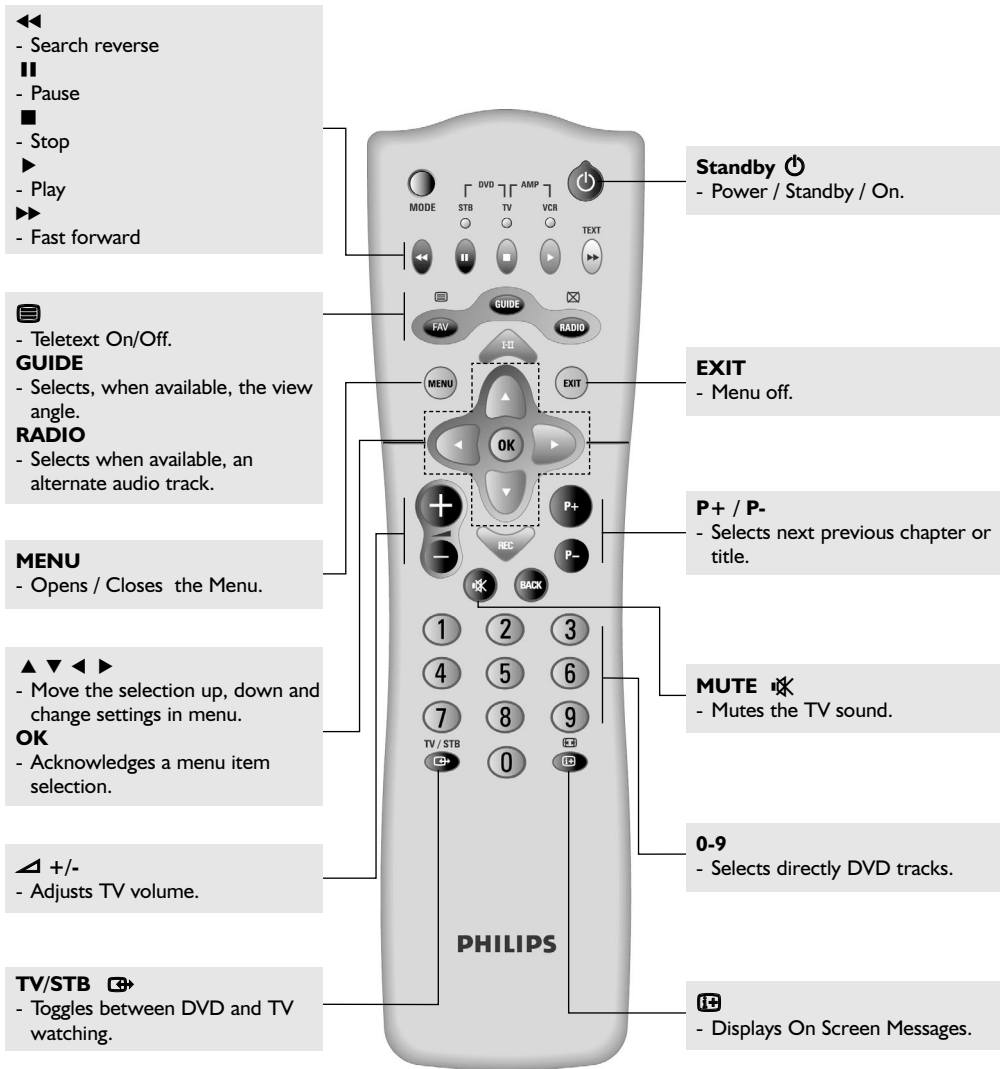

8.5 Using Remote Control For Your Tuner / Amplifier

TUNER-AMPLIFIER mode (AMP)

Note: Some of the functions described below may not be available or may not have the same behaviour for all appliances.

(*) Indicates the commands which are only available for Philips Tuner / Amplifiers.

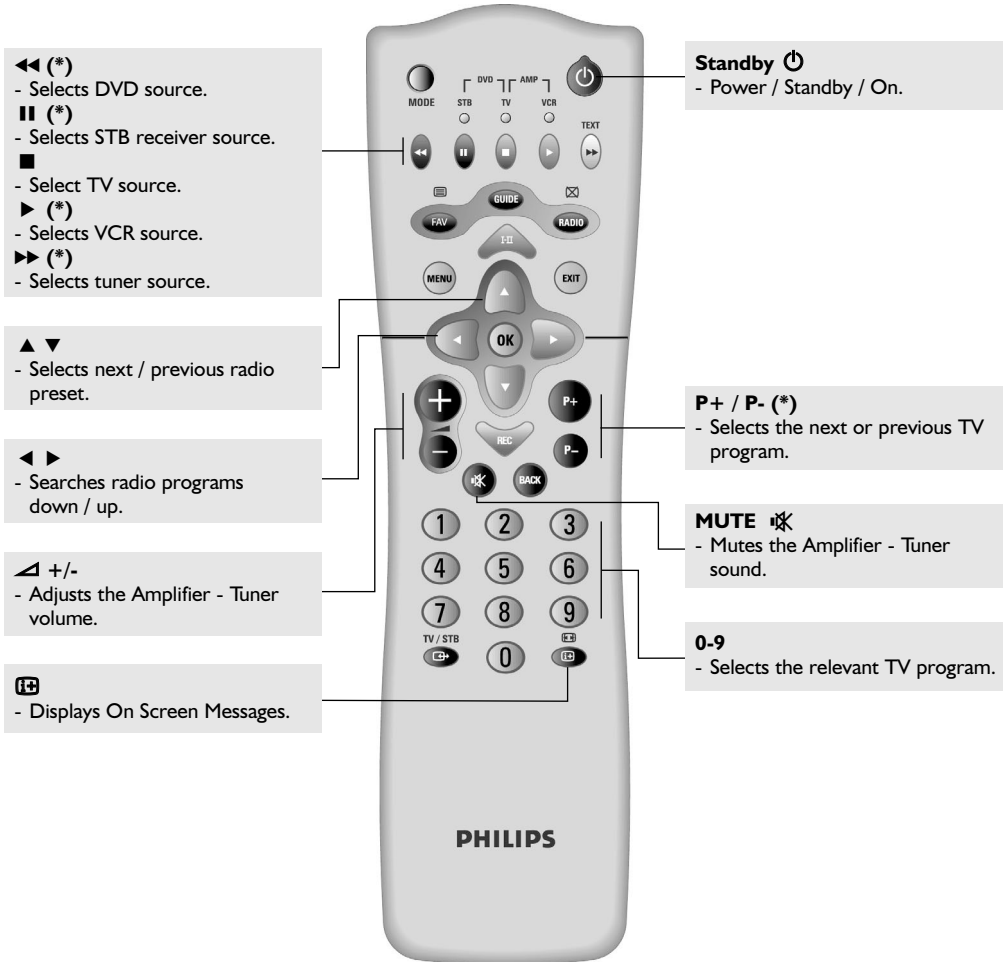

9 Troubleshooting guide

Check the guide below for a possible cause of the problem you are experiencing. The most common problems that arise are related to cable connections. Make sure that your receiver is properly connected.

Symptom	Remedy
Nothing lights up on your receiver's front panel.	<p>Check that the mains power cord is correctly connected. Disconnect this cord, and then reconnect it to ensure it is in place.</p> <p>Check that power is available at the wall socket.</p>
Your remote control fails to operate your receiver.	<p>Make sure your receiver is in the operate mode.</p> <p>Make sure that you are pointing your remote control at the receiver front panel.</p> <p>Make sure that the remote control is set to STB mode (see 2.2.1).</p> <p>Check the batteries in your remote control.</p> <p>Check if your remote is set to the "Device" (1 or 2) setting corresponding to your receiver (see 6.4.2 and 7.2).</p>
There is no sound/picture but the current time is displayed on the receiver's front panel.	<p>Your receiver is in standby. Press P+ / P- button on your remote control to wake up your receiver. Alternatively, press PROG+ / PROG- button on the receiver's front panel.</p>
There is no sound/picture. However, front panel display is correct.	<p>You are viewing TV via your UHF aerial TV connection. Press the TV / STB remote control button twice.</p> <p>Make sure that the SCART connections are correct.</p> <p>Connections are correct but the TV set is NOT switched to external AV source. Press twice the TV / STB remote control button, if the problem is not fixed refer to the user manual of your TV set.</p>
Main Menu can be displayed but you cannot select channels.	<p>Your receiver has not been properly configured. Perform the Channel Search procedure. (Select the Installation submenu from the Main Menu). Optionally return to factory setting.</p>
Main Menu and Channel Banner can be displayed, but there is no reception (black screen).	<p>Aerial is not receiving the signal. Check the installation and the aerial positioning (Check signal quality).</p> <p>Transmitted signal is too weak. Check the installation and the aerial positioning. This effect may also be produced by severe weather conditions.</p>
The picture is not sharp and text is difficult to read.	<p>The TV SCART output video format is not set to RGB. Change setting of the TV SCART item to RGB in the System Settings menu.</p> <p>The TV SCART lead is not connected to the RGB capable SCART socket of your TV set (refer to TV set user manual for proper connection).</p> <p>The SCART lead for TV connection is not RGB capable (not fully wired). Use the SCART cable supplied with your receiver for the connection to the TV set.</p>
Intermittent reception ("mosaic" effect or "frozen" image).	<p>You may have defective cable links. Check all connections and cables.</p> <p>Poor signal due to the incorrect positioning of the aerial. Reorient the aerial and fasten it securely.</p>
You have forgotten your PIN code.	<p>You have the possibility to reset it to its default PIN code (1234). To reset the PIN code, type in the so-called Master PIN Code (00799700). Type in the Master PIN code in quick succession on the level of the Main Menu. Before you enter the Master PIN code, press the OK key. Please keep this code secret to prevent your children from using it.</p>

10 Technical Specifications

This product is in conformity with the requirements of the 95/47/EC and 2002/21/EC directives.

Video Decoding

- MPEG-2 DVB compliant up to MP@ ML
- Video bit rate: up to 15 Mbit /sec
- Video format: 4:3 (letter box or Pan & scan if source is in 16:9) and 16:9
- Resolution: up to 720x576 pixels

Audio Decoding

- MPEG layer I / II

Ease of installation

- Automatic program installation via scanning
- Program editing for personalised installation (delete, add, move)

Ease of use

- Automatic program list update
- Direct access TV & Radio modes-Full remote controlled
- Multibrand remote control(TV, VCR, DVD, Audio AMP-Tuner)
- Automatic recording via:
 - Timer programming by tagging in banner and Easy recording for Philips VCR and DVD+RW recorders
- Now & Next program in banner
- EPG list per channel based on EIT schedule

Operation/Features

- Receiver compatible with services based on MHP
- 1000 presets
- Skip program
- Free to air reception
- DVB Subtitles
- Parental lock with PIN code
- Channel lock with PIN code
- Menu controlled installation and operation using On Screen Display
- 8 event VCR timer / Reminder
- Automatic VCR play back: Audio L/R + CVBS or RGB / Fast blanking
- Full range RF loop-through
- Software upgrade via over the air download
- Rotary 4x7 digit LED display
- Dolby Digital bit-stream audio out

Application System Resources

Processor clock speed	180 MHz
SDRAM - CPU/Video-Graphics	40 MB
Flash memory	8 MB
EEPROM	16 kB
Graphics resolution	16 bits

Terrestrial antenna interface

- RF input: IEC 169-2 female connector
- RF output (bypass): IEC 169-2 male connector

Reception-Demodulation

- Demodulation type: COFDM 2K / 8K
- Network: MFN /SFN
- Input frequency range: VHF III & UHF IV / V
- Loop-through frequency range (MHz): 47 - 862 MHz

Secured transaction

- For future application - Italy only
- Smart card type: Citizen card
- Interface: OCF based

De-scrambling

- Finland only
 - Type: DVB
 - Implementation: Embedded
 - Smart card (not supplied): I for CA
 - CA system: Conax
- Note: Subscription is required to watch Pay-TV.*

Connections

TV SCART:

- Output: CVBS or RGB / Fast blanking
- Volume controlled audio L/R, Slow blanking outputs

VCR SCART

- Input: CVBS or RGB / Fast blanking, Slow blanking , Audio L/R
- Output: CVBS , Audio L/R, Slow blanking during timer if "Prepare Record" mode is activated

Audio CINCH

- Analog audio output: L / R
- Digital audio output: PCM or AC3

Serial interface:

- Type: RJ 9

Modem

- Type: V90
- interface: RJ 11

Smart card reader

- Type: ISO 7816

Accessories

- Remote control
- Scart cable
- User manual
- Worldwide Guarantee booklet
- Batteries: 2 x 1.5V type AA/R06
- RF cable
- Telephone cord
- Mains cord
- Stand for using the receiver in the upright position

Miscellaneous

- Temperature range (°C)
 - Operating +5 to 45
 - Storage -10 to +70
- Mains: 230 V ~ +/-10%
50 Hz
- Power consumption: < 15W
- Standby consumption: < 6 W
- Low power < 1 W
- Weight
 - Product 1.5 kg
 - Including packaging 2.0 kg
- Dimensions:
 - Product 260 x 225 x 60 mm
 - Packaging 395 x 275 x 90 mm

Multi-language

Menu

- English, Italian, Finnish, Swedish, Spanish, French, German, Polish.

User manual

- English, Italian, Finnish, Swedish, Spanish, French, German.

AC3® is a regisred trademark of Dolby Laboratories Licensing Corporation.

Dolby® is a regisred trademark of Dolby Laboratories Licensing Corporation.

Due to continued product improvements, this information is subject to change without notice.



English

Italiano

Suomi

Svenska

Español

Deutsch