

1 Addendum

Enlarge teletext pages

The section “Enlarge teletext pages” in this user manual instructs you to press **OPTION** to enlarge teletext pages.

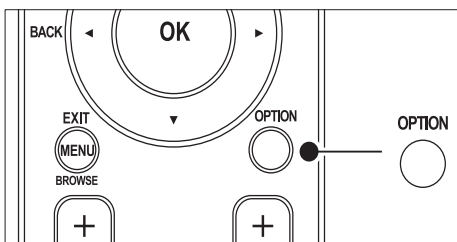

After updating the TV software (to version 64.67.3 or higher), **OPTION** can no longer be used to enlarge teletext pages.

Use the following instructions in place of the original instructions to enlarge teletext pages:

- 1 Press **TELETEXT** and select a teletext page.
- 2 Press **Picture format** to enlarge the top part of the page.

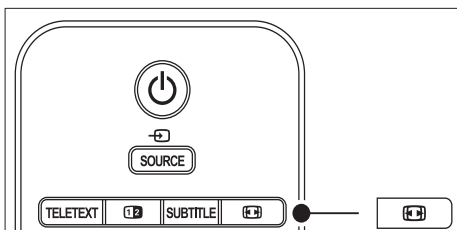

- 3 Press **Picture format** again to view the enlarged lower part of the page.
- 4 Press **▲▼** to scroll through the enlarged page.
- 5 Press **Picture format** again to return to the normal page size.

Use dual screen teletext

The section “Use dual screen teletext” in this user manual instructs you to press **Dual screen** to display normal teletext when dual screen teletext is enabled.

After updating the TV software (to version 64.67.3 or higher), **Dual screen** can no longer be used to display normal teletext.

Use the following instructions in place of the original instructions:

- 1 Press **Dual screen** on your remote control to enable dual screen teletext.
- 2 Press **Dual screen** again to exit teletext.

Register your product and get support at

www.philips.com/welcome



EN USER MANUAL

PHILIPS



Österreich	0810 000205	€0.07 pro Minute
België/Belgique	078250145	€0.06 Per minuut/Par minute
България	+3592 489 99 96	Местен разговор
Hrvatska	01 3033 754	Lokalni poziv
Česká republika	800142840	Bezplatný hovor
Danmark	3525 8759	Lokalt opkald
Suomi	09 2311 3415	paikallispuhelu
France	0821 611655	€0.09 Par minute
Deutschland	01803 386 852	€0.09 pro Minute
Ελλάδα	0 0800 3122 1280	Κλήση χωρίς χρέωση
Magyarország	0680018189	Ingyenes hívás
Ireland	0800 055 6882	Free call
Italia	848390207	€0.08 Al minuto
Luxemburg/ Luxembourg	40 6661 5644	Ortsgespräch/ Appel local
Nederland	0900 8407	€0.10 Per minuut
Norge	2270 8111	Lokalsamtale
Polska	0223491504	połączenie lokalne
Portugal	2 1359 1442	Chamada local
România	1-203-2060	Apel local
Россия	(495) 961-1111	Местный звонок
Србија	+381 114 440 841	Lokalni poziv
Slovensko	0800 004537	Bezplatný hovor
Slovenija	01 280 95 22	lokalni klic
España	902 888 784	€0.10 Por minuto
Sverige	08 5792 9100	Lokalsamtal
Suisse/Schweiz/ Svizzera	0844 800 544	Appel local/Ortsgespräch/ Chiamata locale
Türkiye	0800 261 3302	Şehir içi arama
United Kingdom	0870 900 9070	Local call
Україна	044 254 2392	Місцевий виклик

This information is correct at the time of press. For updated contact information, refer to www.philips.com/flavors.

Table of contents

1 Important	3
1.1 Safety	3
1.2 Screen care	4
1.3 Environmental care	4

2 Your TV	5
2.1 TV overview	5

3 Get started	7
3.1 Position the TV	7
3.2 Wall mount the TV	7
3.3 Connect the antenna cable	9
3.4 Connect the mains cord	9
3.5 Insert the remote control batteries ..	10
3.6 Switch on the TV	10
3.7 First time setup	10

4 Use your TV	11
4.1 Switch your TV on/off or to standby	11
4.2 Watch TV	12
4.3 Access DVB-C and DVB-T channel networks	12
4.4 Use teletext	13

5 Use more of your TV	14
5.1 Remote control overview	14
5.2 Use TV menus	16
5.3 Adjust picture and sound settings. .	18
5.4 Change to Shop or Home mode ...	22
5.5 Use advanced teletext features	22
5.6 Create favorite lists	24
5.7 Use the Electronic Programme Guide	25
5.8 Use timers and Child lock	26
5.9 Use subtitles	27
5.10 View photos and listen to music. . .	28
5.11 Listen to digital radio channels . . .	30

5.12 Update your TV software	30
------------------------------------	----

6 Install channels	32
6.1 Automatically install channels	32
6.2 Manually install channels	33
6.3 Rename channels	34
6.4 Uninstall or reinstall channels	34
6.5 Rearrange channels	34
6.6 Manually update the channel list. . .	35
6.7 Test digital reception	35
6.8 Start a demo	35
6.9 Reset TV to factory settings	36

7 Connect devices	37
7.1 Connection overview	37
7.2 Select connection quality	38
7.3 Connect devices	40
7.4 Setup devices	44
7.5 Use Philips EasyLink	45
7.6 Prepare TV for digital services	45

8 Technical specifications.	47
--	-----------

9 Troubleshooting	48
9.1 General TV issues	48
9.2 TV channel issues	48
9.3 Picture issues	48
9.4 Sound issues	49
9.5 HDMI connection issues	49
9.6 USB connection issues	50
9.7 PC connection issues	50
9.8 Contact us	

10 Index.	
------------------------	--

2008 © Koninklijke Philips Electronics N.V. All rights reserved. Specifications are subject to change without notice. Trademarks are the property of Koninklijke Philips Electronics N.V. or their respective owners.

Philips reserves the right to change products at any time without being obliged to adjust earlier supplies accordingly.

The material in this manual is believed adequate for the intended use of the system. If the product, or its individual modules or procedures, are used for purposes other than those specified herein, confirmation of their validity and suitability must be obtained. Philips warrants that the material itself does not infringe any United States patents. No further warranty is expressed or implied.

Warranty

No components are user-serviceable. Do not open or remove covers to the inside of the product. Repairs may only be done by Philips Service Centres and official repair shops. Failure to do so shall void any warranty, stated or implied. Any operation expressly prohibited in this manual, any adjustments, or assembly procedures not recommended or authorised in this manual shall void the warranty.

Pixel characteristics

This LCD product has a high number of colour pixels. Although it has effective pixels of 99,999% or more, black dots or bright points of light (red, green or blue) may appear constantly on the screen. This is a structural property of the display (within common industry standards) and is not a malfunction.

Open source software

This television contains open source software. Philips hereby offers to deliver or make available, upon request, for a charge no more than the cost of physically

performing source distribution, a complete machine-readable copy of the corresponding source code on a medium customarily used for software interchange.

This offer is valid for a period of 3 years after the date of purchase of this product. To obtain the source code, write to

Philips Consumer Lifestyle
Development Manager
LoB Mainstream Displays
620A Lorong 1, Toa Payoh
Singapore 319762

Compliance with EMF

Koninklijke Philips Electronics N.V. manufactures and sells many products targeted at consumers, which, like any electronic apparatus, in general have the ability to emit and receive electromagnetic signals.

One of Philips' leading Business Principles is to take all necessary health and safety measures for our products, to comply with all applicable legal requirements and to stay well within the EMF standards applicable at the time of producing the products.

Philips is committed to develop, produce and market products that cause no adverse health effects.

Philips confirms that if its products are handled properly for their intended use, they are safe to use according to scientific evidence available today.

Philips plays an active role in the development of international EMF and safety standards, enabling Philips to anticipate further developments in standardisation for early integration in its products.

Mains fuse (UK only)

This TV is fitted with an approved moulded plug. Should it become necessary to replace the mains fuse, this must be replaced with a fuse of the **same value as indicated** on the plug (example 10A).

1. Remove fuse cover and fuse.
2. The replacement fuse must comply with BS 1362 and have the ASTA approval mark. If the fuse is lost, contact your dealer in order to verify the correct type.
3. Refit the fuse cover.

In order to maintain conformity to the EMC directive, the mains plug on this product must not be detached from the mains cord.

Copyright



VESA, FDMI and the VESA Mounting Compliant logo are trademarks of the Video Electronics Standards Association.



Manufactured under license from Dolby Laboratories. 'Dolby', 'Pro Logic' and the double D symbol **DD**, are trademarks of Dolby Laboratories.



Manufactured under license from BBE Sound, Inc. Licensed by BBE, Inc under one or more of the following US patents: 5510752, 5736897. BBE and BBE symbol are registered trademarks of BBE Sound Inc.

Windows Media is either a registered trademark or trademark of Microsoft Corporation in the United States and/or other countries.

® Kensington and Micro Saver are registered US trademarks of ACCO World Corporation with issued registrations and pending applications in other countries throughout the world. All other registered and unregistered trademarks are the property of their respective owners.

1 Important

Congratulations on your purchase and welcome to Philips!

Read this user manual before you start to use this product.

Pay close attention to this section and follow the safety and screen care instructions. The product warranty does not apply if damage is caused by failing to follow these instructions.

To fully benefit from the support that Philips offers, register your product at www.philips.com/welcome.

The model and serial number of your TV can be found on the back and side of the TV as well as on the packaging.

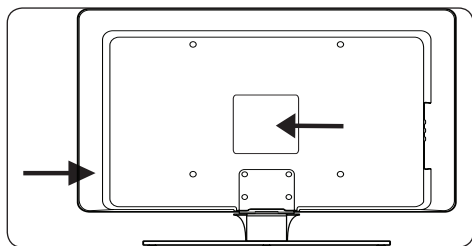

1.1 Safety

- Two people are required to lift and carry a TV that weighs more than 25 kilos (55lb). Improper handling of the TV can result in serious injury.
- If transporting the TV in low temperatures (less than 5°C), open the box and wait until the TV matches the ambient temperature of the room before unpacking.
- To avoid short circuit, do not expose the TV, remote control or remote control batteries to rain or water.
- Do not place vessels of water or other liquids on top of or near the TV. Spilling liquids on the TV can cause electric shock. If liquids are spilt on the TV, do not operate the TV. Immediately disconnect the TV from the mains and have the TV checked by a qualified technician.
- To avoid risk of fire or electric shock, do not place the TV, remote control or remote control batteries near naked flame sources (e.g. lighted candles) and other heat sources including direct sunlight.
- Do not install the TV in a confined space such as a bookcase. Leave a space of at least 10cm (four inches) around the TV for ventilation. Be sure air flow is not obstructed.
- If placing the TV on a flat, solid surface be sure to use only the supplied stand. Do not move the TV if the stand is not properly screwed to the TV.
- Wall mounting of the TV should only be performed by qualified personnel. The TV must only be mounted on an appropriate wall bracket and on a wall that can safely hold the weight of the TV. Improper wall mounting can result in severe injury or damage. Do not attempt to wall mount the TV yourself.
- If the TV is mounted on a swivel base or swivel arm, ensure no strain is placed on the power cord when the TV is swivelled. Strain on the power cord can loosen connections and cause arcing or fire.
- Disconnect the TV from the mains and antenna before lightning storms. During lightning storms do not touch any part of the TV, mains cord or antenna cable.
- Be sure that you have full access to the mains cord for easy disconnection of the TV from the mains.
- When disconnecting the TV from the mains, be sure to:
 1. Turn off the TV, then the mains power (if available).
 2. Unplug the mains cord from the mains socket outlet.

- Unplug the mains cord from the power connector at the back of the TV. Always pull the mains cord by the plug. Do not pull the mains cord.

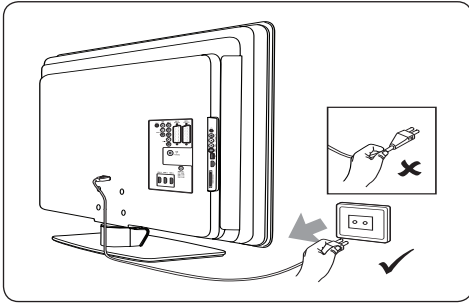

- Permanent hearing loss can occur if you use earphones or headphones at high volumes. Though high volume may sound normal over time, it can damage your hearing. To protect your hearing, limit the amount of time you use earphones or headphones at high volume.

1.2 Screen care

- Turn off and unplug the mains cord before cleaning the screen. Clean the screen with a soft, dry cloth. Do not use substances such as household cleaning agents as these may damage the screen.

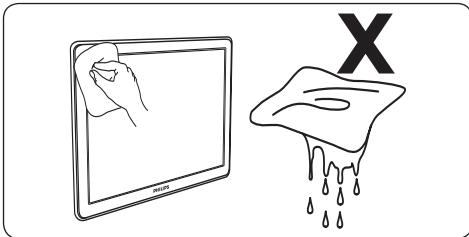

- To avoid deformations or colour fading, wipe off water droplets as soon as possible.
- Do not touch, push, rub or strike the screen with hard objects as this may damage the screen permanently.
- Where possible, avoid stationary images that remain on-screen for extended periods

of time. Examples include screen menus, teletext pages, black bars or stock market tickers. If you must use stationary images, reduce the screen contrast and brightness to avoid screen damage.

1.3 Environmental care

Recycling your packaging

The packaging of this product is intended to be recycled. Contact your local authorities for information on how to recycle the packaging.

Disposing your used product

Your product is manufactured with high-quality materials and components that can be recycled and reused. When you see the crossed-out wheel bin symbol attached to a product, it means the product is covered by the European Directive 2002/96/EC:



Do not dispose your used product with household waste. Ask your dealer for information on how to safely dispose of the product. Uncontrolled waste disposal harms both the environment and human health.

Disposing used batteries

The supplied batteries do not contain mercury or cadmium. Dispose supplied and all other used batteries according to your local regulations.

Power consumption

The TV consumes minimal energy in standby mode to minimise environmental impact. Active power consumption is displayed at the back of the TV.

For more product specifications, see the product leaflet at www.philips.com/support.

2 Your TV

This section gives you an overview of commonly-used TV controls and functions.

2.1 TV overview

Side controls and indicators

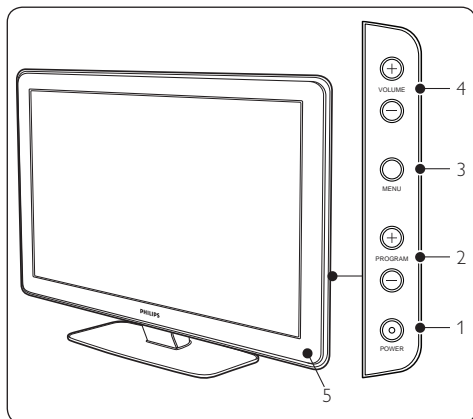

1. **POWER**
2. **PROGRAM +/-**
3. **MENU**
4. **VOLUME +/-**
5. Power indicator/Remote control sensor

Side connectors

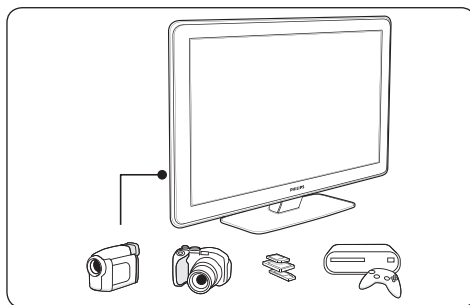

Use the TV side connectors to connect to mobile devices such as a camera or high-definition game console. You can also connect a pair of headphones or a USB memory device.

Back connectors

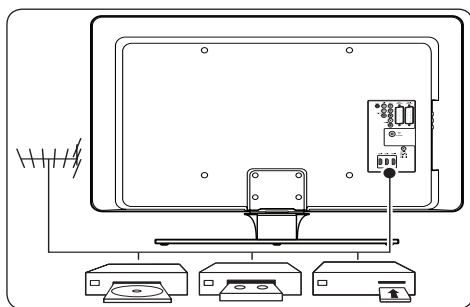

Use the TV back connectors to connect to the antenna and permanent devices such as a high-definition disc player, DVD player or VCR.

Note

For more information about connections, see *Section 7 Connect devices*.

Remote control

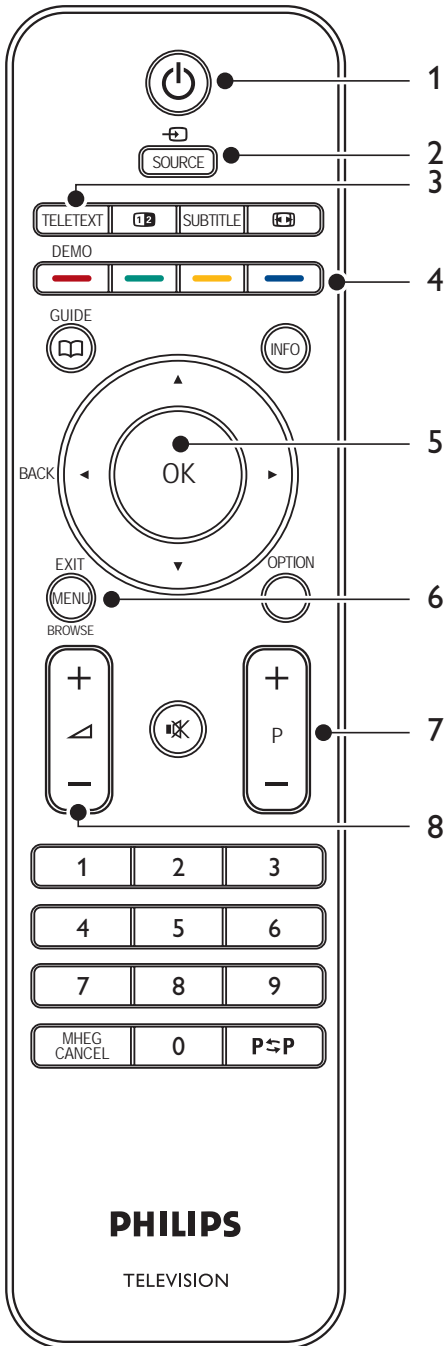

1. **STANDBY**
2. **SOURCE**
3. **TELETEXT**
4. **COLOUR KEYS**
From left: Red, green, yellow, blue
5. **NAVIGATION KEYS**
Up ▲, Down ▼, Left ◀, Right ▶, **OK**
6. **MENU**
7. **PROGRAM +/-**
8. **VOLUME +/-**

For advanced information about the remote control, see *Section 5.1 Remote control overview*.

3 Get started

This section helps you position and install the TV and supplements the information provided in the *Quick Start Guide*.

Note

Refer to the *Quick Start Guide* for stand mounting instructions.

3.1 Position the TV

In addition to reading and understanding the safety instructions in *Section 1.1*, consider the following before positioning your TV:

- The ideal viewing distance for watching TV is three times its screen size.
- Position the TV where light does not fall on the screen.
- Connect your devices before you position your TV.
- Your TV is equipped with a Kensington Security Slot at the back of the TV.

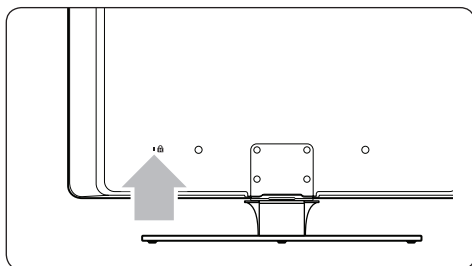

If connecting an anti-theft Kensington lock (not supplied), position the TV within reach of a permanent object (such as a table) that can be easily attached to the lock.

3.2 Wall mount the TV

WARNING

Wall mounting of the TV should only be performed by qualified installers. Koninklijke Philips Electronics N.V. bears no responsibility for improper mounting that results in accident or injury.

Step 1 Purchase a VESA-compatible wall bracket

Depending on the size of your TV screen, purchase one of the following wall brackets:

TV screen size (inches/cm)	VESA-compatible wall bracket type (millimeters)	Special instructions
32"/81cm	Adjustable 300 x 300	The VESA-compatible bracket must be adjusted to 200 x 300 before securing to the TV
37"/94cm	Fixed 300 x 300	None
42"/107cm or larger	Fixed 400 x 400	None

Step 2 Remove the TV stand

Note

These instructions are only applicable to TV models with mounted stands. If your TV stand is not mounted, skip to *Step 3 Secure the VESA-compatible wall bracket to the TV*. TV stands may differ in shape on some TV models.

1. Carefully place the TV face down on a flat, stable surface that is covered by soft cloth. The cloth should be thick enough to protect your screen.

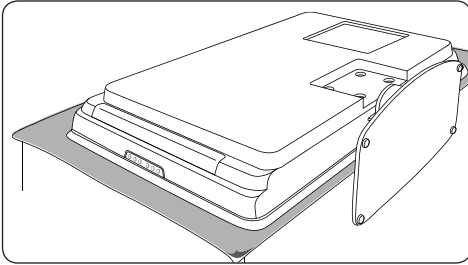

2. Using a cross-head screwdriver (not supplied), unscrew the four bolts that secure the stand to the TV.

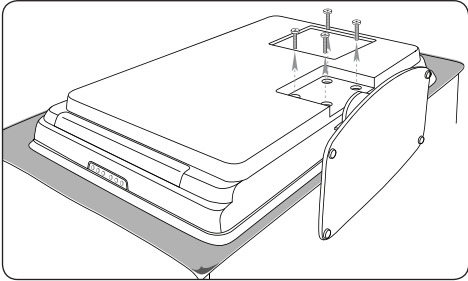

3. Firmly pull the stand from the bottom of the TV. Place both the stand and bolts in a secure location for future reinstallation.

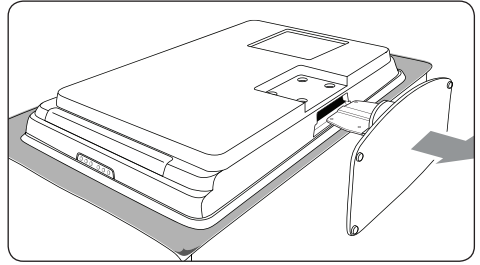

Step 3 Secure the VESA-compatible wall bracket to the TV

1. Locate the four mounting nuts at the back of the TV.

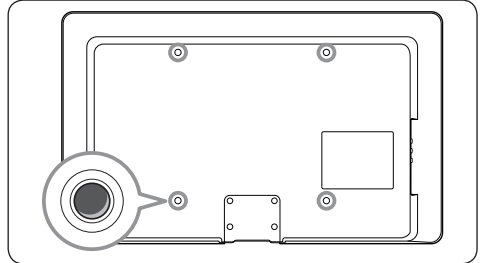

2. Continue with the instructions provided with your VESA-compatible wall bracket.

Note

When securing the VESA-compatible wall bracket to your TV, use M6 bolts for 32 inch models or M8 bolts for larger models (bolts not supplied).

3.3 Connect the antenna cable

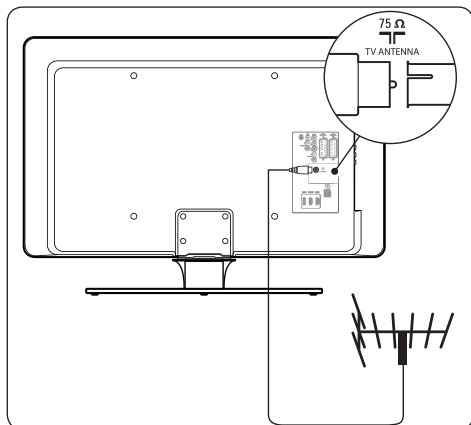

1. Locate the **TV ANTENNA** connector at the back of the TV.
2. Connect one end of an antenna cable (not supplied) to the **TV ANTENNA** connector. Use an adaptor if the antenna cable does not fit.
3. Connect the other end of the antenna cable to your antenna outlet, ensuring that the cable is tightly secured at both ends.

3.4 Connect the mains cord

WARNING

Verify that your mains voltage corresponds with the voltage printed at the back of the TV. Do not insert the mains cord if the voltage is different.

To connect the mains cord

Note

The location of the mains connector varies according to TV model.

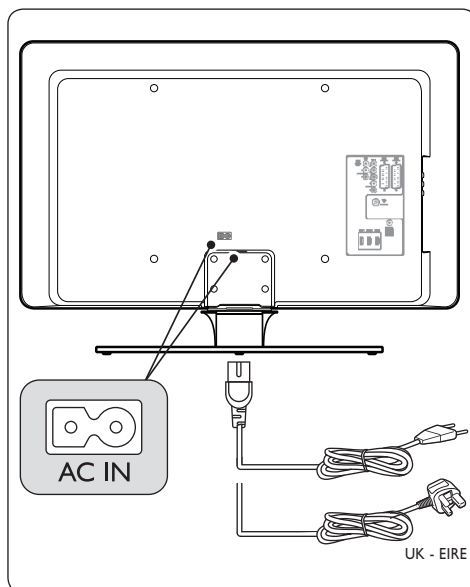

1. Locate the **AC IN** mains connector at the back or on the bottom of the TV.
2. Connect the mains cord to the **AC IN** mains connector.
3. Connect the mains cord to the mains, ensuring that the cord is tightly secured at both ends.

3.5 Insert the remote control batteries

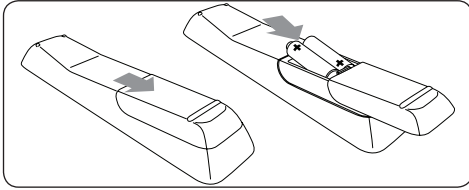

1. Slide the battery cover off the back of the remote control.
2. Insert the two supplied batteries (Size AAA, Type LR03). Be sure the + and - ends of the batteries line up with the markings inside the case.
3. Slide the cover back into position.

Note

Remove the batteries if not using the remote control for an extended period of time.

3.6 Switch on the TV

The first time you switch on the TV, check that the mains cord is properly connected. When ready, turn on the mains (if mains switch is available), then press **POWER** on the side of the TV.

Note

Certain TV models require you to press and hold **POWER** for up to two seconds. A beep sound indicates that your TV is switched on. Your TV may take up to 15 seconds to start.

3.7 First time setup

The first time the TV is switched on, a language selection menu appears.

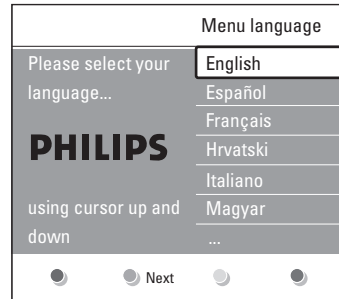

Select your language and follow the on-screen instructions to setup the TV.

Note

If DVB-C is available, you will be prompted to select **Antenna** or **Cable**. **Antenna** installs DVB-T channels. **Cable** installs DVB-C channels.

CAUTION

Do not change DVB-C **Settings** unless required.

Tip

You can reinstall channels as described in *Section 6 Install channels*

4 Use your TV

This section helps you perform basic TV operations. Instructions on advanced TV operations are provided in *Section 5 Use more of your TV*.

4.1 Switch your TV on/off or to standby

4.1.1 Switch on your TV

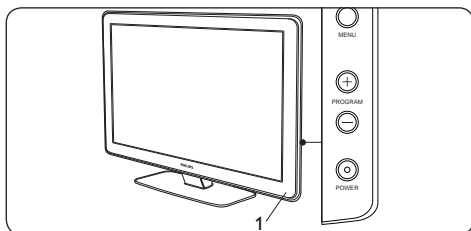

- If the power indicator (1) is off, press **POWER** on the side of the TV.

4.1.2 Switch off your TV

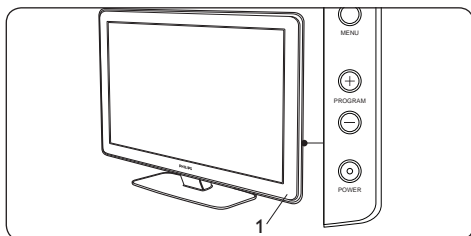

- Press **POWER** on the side of the TV. The power indicator (1) switches off.

4.1.3 Switch your TV to standby

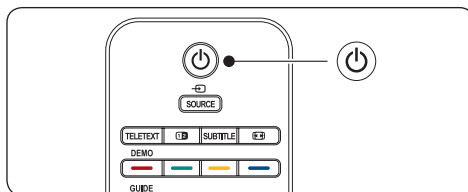

- Press **STANDBY** on the remote control. The power indicator switches to standby (red).

✳ Tip

Though your TV consumes very little power when in standby, energy continues to be consumed as long as the mains remain connected and powered. When not in use for extended periods of time, switch off and disconnect the TV from the mains.

4.1.4 Switch on the TV from standby

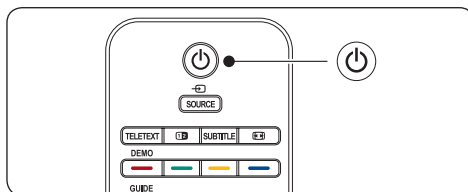

- If the power indicator is in standby (red), press **STANDBY** on the remote control.

ⓘ Note

If you cannot locate your remote control and you want to switch on the TV from standby, press **POWER** on the side of the TV. This switches off your TV. Press **POWER** again to switch the TV back on.

4.2 Watch TV

4.2.1 Switch channels

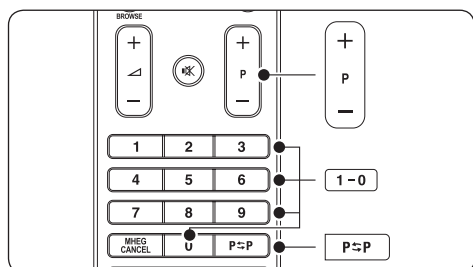

- Press a number (1 to 999) or press **P +/-** on your remote control.
- Press **PROGRAM +/-** on the side controls of the TV.
- Press **P<=>P** on the remote control to return to the previously-viewed TV channel.

4.2.2 Switch channels (digital receiver)

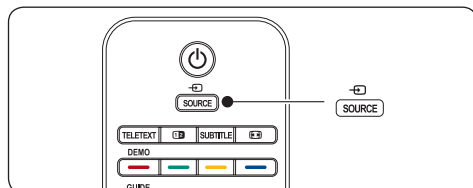

1. Switch on the digital receiver.
2. Press **SOURCE** on the remote control then select the input your digital receiver is connected to.
3. Press **OK** to select the digital receiver.
4. Use the remote control of the digital receiver to select TV channels.

4.2.3 Adjust volume

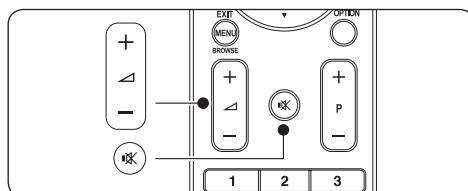

- Press **VOLUME +** or **-** on the remote control.
- Press **VOLUME +** or **-** on the side controls of your TV.
- Press **MUTE** on the remote control to mute the sound. Press **MUTE** again to un-mute the sound.

ⓘ Note

If headphones are connected, adjust headphone volume as described in [Section 5.3.5 Adjust sound settings](#). You must press the **MUTE** button on the remote control to mute audio from the TV speakers. Pressing **VOLUME +/-** buttons turns on the TV speakers again.

4.3 Access DVB-C and DVB-T channel networks

If you have both DVB-C and DVB-T installed, you can access channels from both networks.

1. Press **MENU**.
2. Select **TV menu > Installation > Installation mode**.
3. Select **Cable** (to access DVB-C channels) or **Antenna** (to access DVB-T channels).
4. Switch between DVB-C or DVB-T channels as described in [Section 4.2.1 Switch channels](#).

ⓘ Note

For instructions on how to install DVB-C and DVB-T channels, see [Section 6.1 Automatically install channels](#).

4.4 Use teletext

Most TV channels broadcast information via teletext.

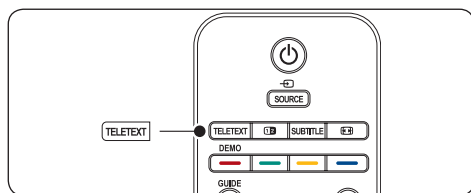

1. Press **TELETEXT** on the remote control. The main index page appears.
2. To select a page with the remote control:
 - Enter the page number with the number keys.
 - Press **P +/-** or **▲/▼** to view the next or the previous page.
 - Press a colour key to select one of the colour coded items at the bottom of the screen.

Tip

Press **P ⇄ P** to return to the previously viewed page.

3. Press **TELETEXT** again to switch off teletext.

Note (for UK users only)

Some digital TV channels offer dedicated digital text services (for example, BBC1).

For advanced information on teletext, see *Section 5.5 Use advanced teletext features.*

5 Use more of your TV

This section helps you perform advanced TV operations, including how to:

- Use the TV menus (Section 5.2)
- Adjust picture and sound settings (Section 5.3)
- Change to Shop or Home mode (Section 5.4)
- Use advanced teletext features (Section 5.5)
- Create favourite lists (Section 5.6)
- Use the Electronic Programme Guide (Section 5.7)
- Use timers and Child lock (Section 5.8)
- Use subtitles (Section 5.9)
- View photos and listen to music (Section 5.10)
- Listen to digital radio channels (Section 5.11)
- Update your TV software (Section 5.12)

5.1 Remote control overview

This section provides a detailed overview of remote control features.

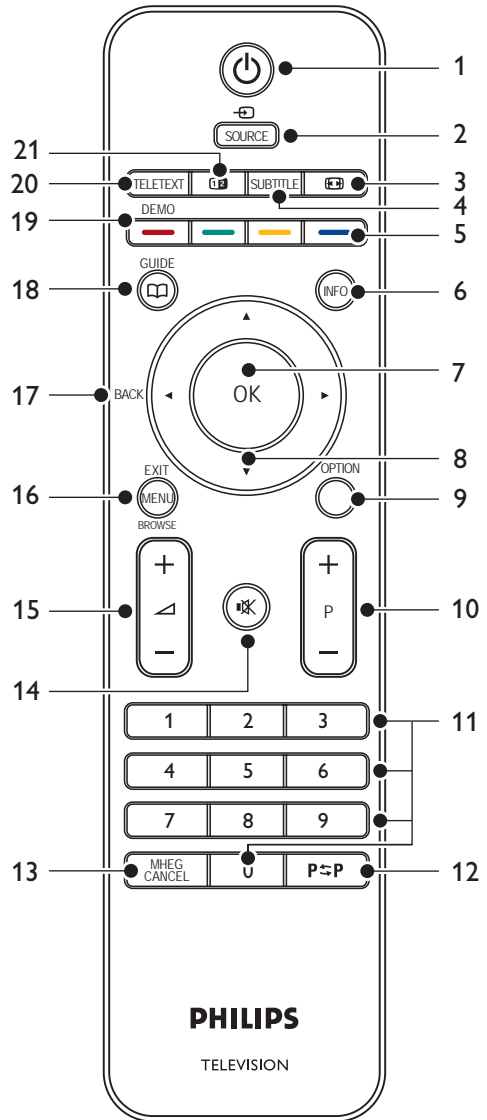

1. **STANDBY**
Switches the TV on from standby or back to standby.
2. **SOURCE**
Selects connected devices.
3. **PICTURE FORMAT**
Selects a picture format.
4. **SUBTITLE**
Activates or deactivates subtitles.
5. **COLOUR KEYS**
Selects tasks or teletext pages.
6. **INFO**
Displays programme information, if available.
7. **OK**
Accesses the **All channels** menu or activates a setting.
8. **NAVIGATION KEYS**
Up ▲, Down ▼, Left ◀ and Right ▶ keys navigate the menu.
9. **OPTION**
Activates the **Quick access** menu.
10. **PROGRAM (P) +/-**
Switches to the next or previous channel.
11. **NUMBER KEYS**
Selects a channel, page or setting.
12. **PREVIOUS CHANNEL**
Returns to the previously-viewed channel.
13. **MHEG CANCEL**
Cancels digital text or interactive services (UK only).
14. **MUTE**
Mutes or restores sound.
15. **VOLUME +/-**
Increases or decreases volume.
16. **MENU**
Toggles the menu on or off.
17. **BACK**
18. **GUIDE**
Toggles the Electronic Programme Guide on or off. Only active with digital channels.
19. **DEMO**
Toggles the **Demo** menu on or off.
20. **TELETEXT**
Toggles teletext on or off.
21. **DUAL SCREEN**
Splits the current channel or source on the left of the screen. Teletext appears on the right.

5.2 Use TV menus

On-screen menus help you install your TV, adjust picture and sound settings and access other features. This section describes how to navigate the menus.

5.2.1 Access the main menu

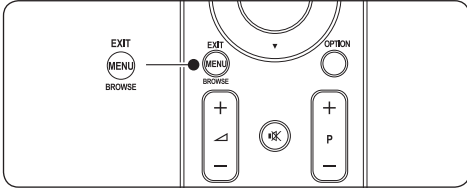

1. Press **MENU** on the remote control to display the main menu.

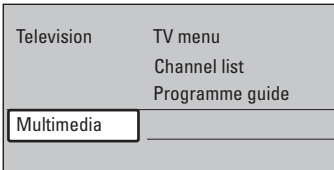

2. Press **MENU** to exit.

The main menu offers the following items:

- **TV menu**
Select this menu for installation, picture, sound settings and other feature settings.
- **Channel list**
Select this item to display the Channel list. Create your Favourite channel lists here.
- **Programme guide**
Available when digital channels are installed, this item displays information about the digital programmes. See *Section 5.7 Use the Electronic Programme Guide*.
- **Multimedia**
Select this item to view photos or play music stored on a USB device.
See *Section 5.10 View photos and listen to music*.

5.2.2 Use the main menu

The following example describes how to use the main menu.

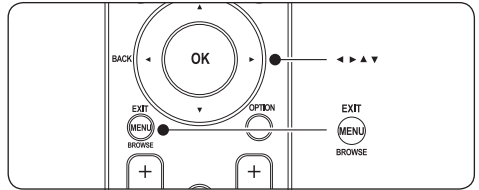

1. Press **MENU** on the remote control to display the main menu.

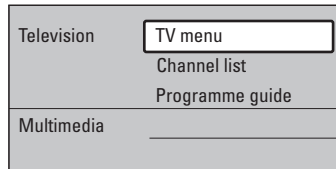

2. Press **▶** to enter the **TV menu**.

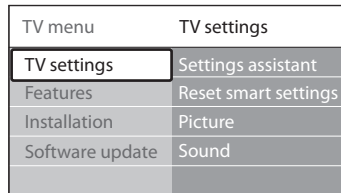

3. Press **▶** to enter the **TV settings** menu.

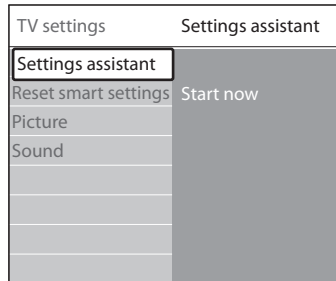

4. Press **▼** to select **Picture**.

TV settings	Picture
Settings assistant	Contrast
Reset smart settings	Brightness
Picture	Colour
Sound	Hue
	Sharpness
	Tint

5. Press **▶** to enter the **Picture** settings.

Picture	Contrast
Contrast 90	
Brightness 47	
Colour 52	
Hue 0	
Sharpness 4	
Tint	

6. Press **▼** to select **Brightness**.

Picture	Brightness
Contrast 98	
Brightness 47	
Colour 52	
Hue 0	
Sharpness 4	
Tint	

7. Press **▶** to enter the **Brightness** setting.

Brightness

8. Press **▲** or **▼** to adjust the setting.
 9. Press **◀** to return to the **Picture** settings or press **MENU** to exit.

⊞ Note

More choices are available when digital channels are installed and broadcast.

5.2.3 Use the Quick access menu

The **Quick access** menu gives direct access to some often-needed menu items.

⊞ Note

When digital channels are installed and broadcasted, the relevant digital options are displayed in the **Quick access** menu.

- Press **OPTION** on the remote control.
- Press **▲** or **▼** to select an option:
 - Audio language (digital)**
See Section 5.3.5 Adjust sound settings.
 - Subtitle language (digital)**
See Section 5.9.3 Select a subtitle language on digital TV channels.
 - Subtitle**
See Section 5.9 Use subtitles.
 - Picture format**
See Section 5.3.4 Change picture format.
 - Equalizer**
See Section 5.3.5 Adjust sound settings.
 - Clock**
- Press **OK** to display the selected option menu.
- Press **▲**, **▼**, **◀**, **▶** to adjust the settings in the menu.
- Press **OPTION** to exit the menu.

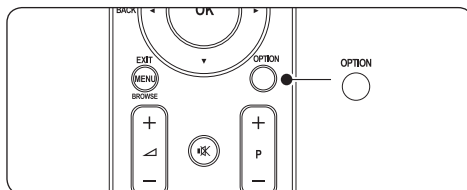

To display or hide the clock

- In the **Quick access** menu, select **Clock** and press **OK** to display the clock permanently.

Quick access
Audio language
Subtitle language
Subtitle
Picture format
Equalizer
Clock

2. Press **OPTION** and press **▲** or **▼** to select **Clock** again.
3. Press **OK** to hide the clock.

5.3 Adjust picture and sound settings

This section describes how to adjust picture and sound settings.

5.3.1 Use Settings assistant

Use **Settings assistant** to guide you through picture and sound settings.

1. Press **MENU** on the remote control and select **TV menu > TV settings > Settings assistant**.
2. Press **▶** to enter.
3. Press **OK** to **Start now**.
4. Press the green key on the remote control to start the assistant.
5. Press **◀** or **▶** to select the left or right side to make your choice.
6. Press the green key to go to the next setting. You will go through several settings. When finished you will be prompted to store these settings.
7. Press the green key to store all your settings.

5.3.2 Adjust picture settings

This section describes how to adjust picture settings.

1. Press **MENU** on the remote control and select **TV menu > TV settings > Picture**.

TV settings	Picture
Settings assistant	Contrast
Reset smart settings	Brightness
Picture	Colour
Sound	Hue
	Sharpness
	Tint
	Dynamic contrast
	Noise reduction
	Colour enhancement
	Active Control
	Light sensor
	Picture format

2. Press **▶** to enter the list.
3. Press **▲** or **▼** to select a setting:
 - **Contrast**
Changes the level of bright parts in the picture keeping the dark parts unchanged.
 - **Brightness**
Changes the level of light in the picture.
 - **Colour**
Changes the level of saturation.
 - **Hue**
If NTSC is broadcast, this level compensates the colour variations.
 - **Sharpness**
Changes the level of sharpness of fine details.
 - **Tint**
Sets the colours to **Normal**, **Warm** (reddish) or **Cool** (bluish). Select **Custom** to make a setting of your own.
 - **Custom tint**
If **Custom** is selected in the **Tint** menu,

follow the on-screen instructions to change the value of:

- **R-WP** (Red White Point)
- **G-WP** (Green White Point)
- **B-WP** (Blue White Point)
- **R-BL** (Red Black Level)
- **G-BL** (Green Black Level)

- **Dynamic contrast**

Enhances the contrast in the picture as the image on the screen changes.

Set the level to **Minimum**, **Medium**, **Maximum** or **Off**. **Medium** is recommended.

- **Noise reduction**

Filters and reduces the noise in the picture.

Set the level to **Minimum**, **Medium**, **Maximum** or **Off**.

- **Colour enhancement**

Makes colours more vivid and improves the resolution of details in bright colours.

Set the level to **Minimum**, **Medium**, **Maximum** or **Off**.

- **Active Control**

Corrects all incoming signals to provide the best picture possible. Switches Active control **On** or **Off**.

- **Light sensor**

Adjusts picture settings to match lighting conditions in the room. Switches Light sensor **On** or **Off**.

 **Note**

Not available on all TV models.

- **Picture format**

See *Section 5.3.4 Change picture format*.

5.3.3 Use smart settings

Apart from manually adjusting picture settings, you can use smart settings to set your TV to a predefined picture and sound setting.

1. Press **MENU** on the remote control and select **TV menu > TV settings > Reset smart settings**.
2. Press **▶** to enter the list.
3. Press **▲** or **▼** to select one of the following settings:
 - **Current**
Applies manually selected picture and sound settings.
 - **Standard**
Applies natural picture and sound settings suitable for most living room conditions.
 - **Vivid**
Applies brilliant picture and sound settings suitable for bright surroundings.
 - **Movie**
Applies dynamic picture and sound settings suitable for a complete cinematic experience.
4. Press the green key to store your selection.

5.3.4 Change picture format

Change the picture format to suit your content.

1. Press **PICTURE FORMAT** on your remote control. Alternatively, press **MENU** and select **TV menu > TV settings > Picture > Picture format**.

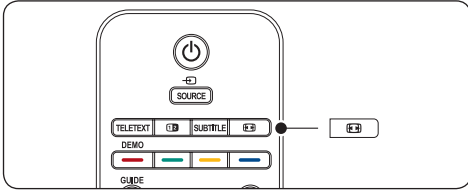

2. Press **▲** or **▼** to select one of the following picture formats:

- **Auto format** (Not for PC)

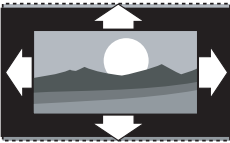

Enlarges the picture automatically to fill the screen. Subtitles remain visible.

Note

We recommend you use **Auto format** for minimal screen distortion.

- **Super zoom** (Not for HD)

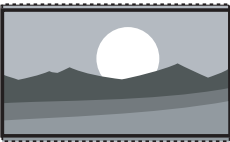

Removes the black bars on the side of 4:3 broadcasts with minimal distortion.

- **4:3** (Not for HD)



Displays the classic 4:3 format.

Note

Constant use of the **4:3** picture format can cause screen distortion. We recommend you use **Auto format**.

- **Movie expand 14:9** (Not for HD)

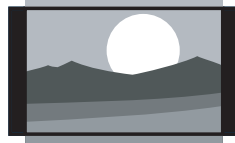

Scales the classic 4:3 format to 14:9.

Note

Constant use of the **14:9** picture format can cause screen distortion. We recommend you use **Auto format**.

- **Movie expand 16:9** (Not for HD)

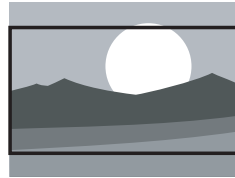

Scales the classic 4:3 format to 16:9.

- **Wide screen**

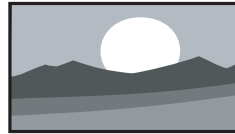

Stretches the classic 4:3 format to 16:9

- **Unscaled** (Only for HD and PC)

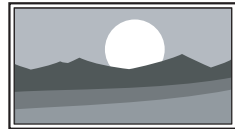

Maximum sharpness though distortion may appear on borders. Also, black bars may appear with pictures from your PC.

5.3.5 Adjust sound settings

This section describes how to adjust sound settings.

1. Press **MENU** on the remote control and select **TV menu > TV settings > Sound**.
2. Press **▶** to enter the list.

TV settings	Sound
Settings assistant	Equalizer
Reset smart settings	Volume
Picture	Balance
Sound	Audio language
	Dual I/II
	Mono/Stereo
	Surround mode
	Headphone volume
	Auto volume leveling
	Delta volume
	Auto surround

3. Press **▲** or **▼** to select one of the following settings:

- **Equalizer**

Changes the bass and treble of the sound.

Select each bar to change a setting.

Alternatively, press the colour keys to select a pre-defined equalizer setting:

- **Standard**
Equalizer set to neutral.
- **Speech**
Equalizer settings maximized for speech-based audio.
- **Multimedia**
Settings maximized for different audio types.
- **Music**
Settings maximized for music.
- **Volume**
Changes the volume.

- *** Tip**

To enable or disable the  volume bar that appears when you change the volume, press **MENU** on the remote control and select

TV menu > Installation > Preferences.

Press **▶** to enter the list and select **Volume bar on** or **Volume bar off**.

- **Balance**
Sets the balance of the left and right speakers to best fit your listening position.
- **Audio language**
Lists audio languages available for a digital channel (unavailable on analogue channels).
- **Dual I/II**
If available, choose between two different languages.
- **Mono/Stereo**
If stereo broadcasting is available, choose between mono or stereo.
- **Surround mode**
If surround sound is available, enable it for more spatial sound.
- **Headphone volume**
Changes the volume of your headphones.

- **⊖ Note**

When headphones are connected, press the **MUTE** button on the remote control to mute audio from the TV speakers. Pressing **VOLUME +/-** buttons un-mutes the TV speakers.

- **Automatic volume leveling**
Reduces sudden volume changes, for example, during commercials or when switching from one channel to another. Select **On** or **Off**.
- **Delta volume**
Levels out volume differences between channels or connected devices. You must switch to the connected device before changing the Delta volume.
- **Auto surround**
Automatically switches the TV to the best surround sound mode available from a broadcast. Select **On** or **Off**.

5.4 Change to Shop or Home mode

1. Press **MENU** on the remote control and select **TV menu > Installation > Preferences > Location**.
2. Press **▶** to enter the **Location** menu.
3. Use **▲** or **▼** to select the TV mode:
 - **Shop**
Sets smart settings to **Vivid**, ideal for a shop environment. The flexibility to change settings is limited.
 - **Home**
Gives home users the full flexibility to change all TV settings.
4. Press **OK** to confirm.
5. Press **MENU** to exit.

5.5 Use advanced teletext features

Your TV has a 1,200 page memory that stores broadcasted teletext pages and subpages. The teletext memory reduces page loading time.

5.5.1 Select teletext subpages

A teletext page can hold several subpages. Subpages are displayed on a bar next to the main page number.

1. Press **TELETEXT** on the remote control.
2. Select a teletext page.
3. Press **◀** or **▶** to select a subpage.

5.5.2 Select T.O.P. teletext broadcasts

Table Of Pages (T.O.P.) teletext broadcasts allow you to jump from one subject to another without using page numbers. T.O.P. teletext is not broadcast on all TV channels.

1. Press **TELETEXT** on the remote control.

2. Press **INFO**.

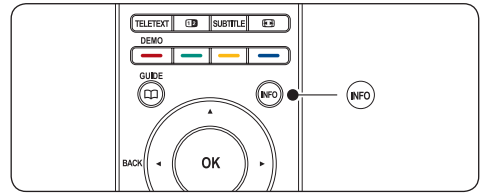

The T.O.P. overview appears.

3. Use **◀, ▶** or **▲, ▼** to select a subject.
4. Press **OK** to view the page.

5.5.3 Use dual screen teletext

Enabling dual screen teletext displays your channel or source on the left of the screen. Teletext is displayed on the right.

1. Press **12 DUAL SCREEN** on your remote control to enable dual screen teletext.
2. Press **12** again to display normal teletext.
3. Press **TELETEXT** to switch off teletext.

5.5.4 Search teletext

Quickly jump to a subject linked to a series of page numbers or search for specific words in teletext pages.

1. Press **TELETEXT** on the remote control.
2. Press **OK** to highlight the first word or number.
3. Press **▲, ▼** or **◀, ▶** to jump to the next word or number on the page.
4. Press **OK** to search a page which holds the highlighted word or number.
5. Press **▲** until no word or number is highlighted to exit **Search**.

5.5.5 Enlarge teletext pages

For more comfortable reading, you can enlarge the teletext page.

1. Press **TELETEXT** on the remote control and select a teletext page.
2. Press **OPTION** on the remote control to enlarge the top part of the page.

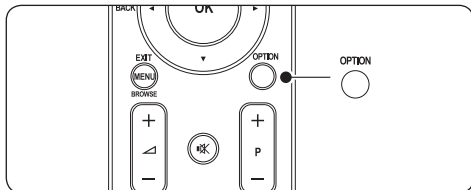

3. Press **OPTION** again to view the enlarged lower part of the page.
4. Press **▲** or **▼** to scroll through the enlarged page.
5. Press **OPTION** again to return to the normal page size.

5.5.6 Use the teletext menu

With the options in the teletext menu you can reveal hidden information, cycle subpages automatically and change the character setting.

1. Press **TELETEXT** on the remote control.
2. Press **MENU**. The **Teletext menu** appears.

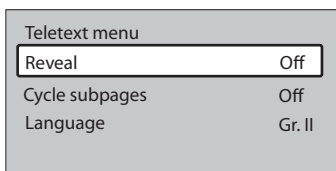

3. Press **▲** or **▼** to select an option.
- **Reveal**
Hide or reveal hidden information on a page, such as solutions to riddles or puzzles.

- **Cycle subpages**

If subpages are available for the selected page, you can cycle subpages automatically.

- **Language**

Some languages use a different set of characters. If using a different language, switch to the appropriate language group to display the text correctly.

4. Press **OK** to change an option:
5. Press **MENU** to exit **Teletext menu**.
6. Press **TELETEXT** to switch off teletext.

5.5.7 Use digital text services (UK only)

Some digital TV broadcasters in UK offer dedicated digital text or interactive services (for example, BBC1). These services work like normal teletext with the addition of number, colour and navigation keys.

1. Press **TELETEXT** on the remote control.
2. Press **▲**, **▼** or **◀**, **▶** to select or highlight items.
3. Press one of the colour keys to select an option.
4. Press **OK** to confirm or activate.
5. Press **MHEG Cancel** to cancel digital text or interactive services.

! Caution

Digital text services are blocked when subtitles are broadcasted and **Subtitle On** is set in the **Features** menu as described in *Section 5.9 Subtitles*.

5.5.8 Use Teletext 2.5

If broadcasted by the TV channel, Teletext 2.5 offers more colours and better graphics than normal teletext. Teletext 2.5 is switched on by default.

1. Press **MENU** on the remote control and select **TV menu > Installation > Preferences > Teletext 2.5.**
2. Press **▶** to enter the list.
3. Select **On** or **Off.**
4. Press **OK** to change the option.

5.6 Create favorite lists

Use the **All channels** list or setup a favourite list of your own with preferred TV channels and radio stations. Each member of your family can create his or her own favourite list.

5.6.1 Select a favorite list

1. Press **OK** on the remote control. Alternatively, press **MENU** and select **Channel list.**
If this is new installation, the **All channels** list is displayed.

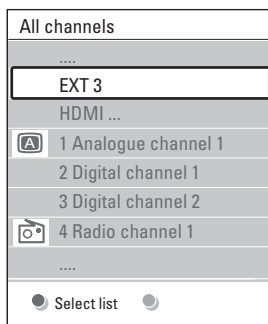

If this is not a new installation, the last selected favourite list appears.

2. Press the red key to display all favourite lists.
3. Press **▲** or **▼** to select a list.
4. Press **OK.** The selected favourite list appears.
5. Press **OK** again to exit.

5.6.2 Setup a favorite list

1. Press **OK** on the remote control. The last selected list appears.
2. Press the red key to show all favourite lists.
3. Press **▲** or **▼** to select a list.
4. Press **OK.**
5. Press the green key to enter **Edit** mode. The selected list displays a full channel list.
6. Press **▲** or **▼** to highlight a channel.
7. Press **OK** to mark (or unmark) the highlighted channel. The channel is added to (or removed from) the selected list.
8. Press the green key again to exit **Edit** mode. The modified channel list appears again.

5.6.3 Select a channel from a favorite list

1. Press **OK** on the remote control. The last selected channel list appears.
2. Use **▲** or **▼** to highlight a channel.
3. Press **OK.** The TV tunes to that channel.

Tip

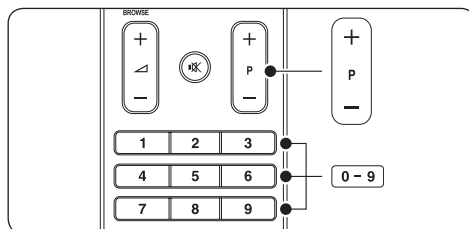

- Press **PROGRAM (P) +/-** on the remote control to scan channels in your selected list.
- You can select channels not in your list by pressing the number keys.

5.7 Use the Electronic Programme Guide

EPG is an on-screen guide that displays scheduled digital TV programmes. This guide is not available with analogue channels. You can navigate, select and view programmes by time, title or genre.

There are two types of EPG, **'Now and Next'** and **'7 or 8 day'** EPG. **'Now and Next'** is always available but the **'7 or 8 day'** EPG is only available in certain countries.

With the EPG menu you can:

- View a list of currently broadcast digital programmes
- View upcoming programmes
- Group programmes by genre
- Set reminders when programmes start
- Setup preferred EPG channels

5.7.1 Switch on EPG

Note

The first time you use EPG, you may be prompted to perform an update. If so, follow the on-screen instructions.

1. Press  **GUIDE** on the remote control.

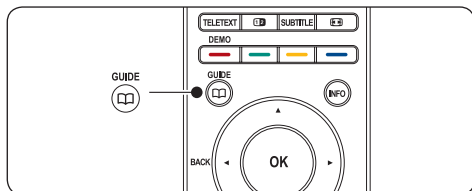

Alternatively, press **MENU** and select **Programme guide**.

The following EPG types appear:

'Now and Next' EPG

Detailed information about the current programme is displayed:

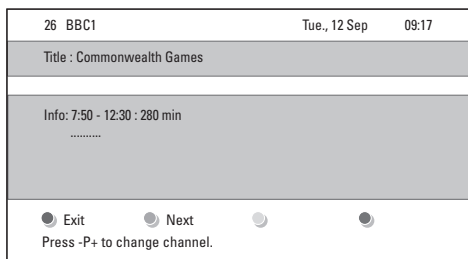

Or

'7 or 8 day' EPG

It may take some time to receive **'7 or 8 day'** EPG data. When loaded, a list of TV programmes is displayed.

Programme guide		Tue., 12 Sep	
	Around	09:55	Next
BBC ONE	07:50 Commonwealth	12:30 Commonwealth	
BBC TWO	09:50 Tweenies	10:15 Something Special	
five	09:00 The Wright Stuff	10:30 Trisha Goddard	
BBC THREE	05:32 This is BBC THREE	12:00 This is BBC THREE	
BBC FOUR	05:32 This is BBC FOUR	12:00 This is BBC FOUR	
abc1	09:20 Moonlighting	10:15 Daddio	
	 Remind 13:50 Anastasia	 Watch	 Jump to... 0010 - EEN

2. Use the colour keys on the remote control to activate available actions:
 - **Next**
Displays information about the next programme.
 - **Remind**
Marks a programme as a reminder.
 - **Watch**
Watch or listen to a current programme.
 - **Jump to...**
Jumps to the next or previous day.
 - **Info**
If available, displays information about a selected programme.
3. Press  **GUIDE** to exit the EPG.

5.7.2 More on '7 or 8 day' EPG

Searching by genre, scheduling reminders and more features are available through the Programme guide menu.

1. Press  **GUIDE** on the remote control.
2. Press **MENU** on the remote control. The **Programme guide** menu appears.

Programme guide	What's on
What's on	12:30 South Today
Search by genre	11:50 Working Lunch
Scheduled remind...	11:55 Melrose Place
Preferred EPG ch...	13:00 In aller Freund
Acquire EPG data	

3. Press **▲** or **▼** to select a menu option.
4. Press **▶** to enter.
5. Press **▲** or **▼** to make a selection.
6. Press **OK** or the green key to activate the selection.
7. Press  **GUIDE** to exit the EPG.

Note

Only channels marked as preferred EPG channels appear in the **Programme guide** menu.

5.8 Use timers and Child lock

This section describes how to switch the TV on or off at a specified time and to use Child lock.

5.8.1 Automatically switch the TV to standby (Sleeptimer)

Sleeptimer switches the TV to standby after a defined period of time.

1. Press **MENU** on the remote control and select **TV menu > Features > Sleeptimer**.
2. Press **▶** to enter the **Sleeptimer** bar.
3. Press **▲** or **▼** to set the sleep time. This can be up to 180 minutes in steps of five minutes. If set to zero minutes, the Sleeptimer is switched off.
4. Press **OK** to activate the Sleeptimer.

Note

You can always switch off your TV earlier or reset Sleep timer during the countdown.

5.8.2 Automatically switch the TV on (On timer)

On timer switches the TV to a specified channel at a specified time, from standby.

1. Press **MENU** on the remote control and select **TV menu > Features > On timer**.
2. Press **▶** to enter the **On timer** menu.
3. Use **▲** or **▼**, **◀** or **▶** to select and enter the menu items to set a channel, day of the week, frequency and starting time.
4. Press **OK** to confirm.
5. Press **MENU** to exit.

Tip

To switch off On timer, select **Off** in the **On timer** menu.

5.8.3 Lock TV channels or connected devices (Child lock)

Lock TV channels or connected devices with a four digit code to prevent children from watching unauthorised content.

To set or change the Child lock code

1. Press **MENU** on the remote control and select **TV menu > Features > Set code or Change code**.
2. Press **▶** to enter the code setup.
3. Enter your code with the number keys. The **Features** menu reappears with a message confirming that your code is created or changed.

Tip

If you forget your code, enter '8888' to override any existing codes.

To enter the Child lock menu

1. Press **MENU** on the remote control and select **TV menu > Features > Child lock** and press **▶** to enter your code.
2. Enter your code with the number keys.

To lock or unlock all channels and connected devices

1. In the **Child Lock** menu, select **Lock** or **Unlock**.
2. Press **OK**.

To lock a programme or all channels from a certain time

1. In the **Child lock** menu, select **Custom lock**.

Child lock	Custom lock
Lock	Lock after
Custom lock	Channel lock
Unlock	Parental rating

2. Press **▶** to enter the **Custom lock** menu.
3. Press **▶** again to enter the **Lock after** menu.
4. Select **On** to enable the **Timer lock**.
5. Press **◀**.
6. Select **Time**.
7. Press **▶**.
8. Enter the time with **▲** or **▼** and **▶**.
9. Press **OK**.

To lock one or more channels and connected devices

1. In the **Child lock** menu, select **Custom lock**.
2. Press **▶** to enter:

3. Press **▲** or **▼** to select **Channel lock**.
4. Press **▶**.
5. Press **▲** or **▼** to select the channel or device you want to lock or unlock.
6. At each selection, press **OK** to lock or unlock the channel or device.

To set parental ratings

Some digital broadcasters rate their programmes according to age. You can set your TV to display only programmes with age ratings higher than your child's.

1. In the **Child lock** menu, select **Custom lock**.
2. Press **▶** to enter.
3. Press **▲** or **▼** to select **Parental rating**.
4. Press **▶**.
5. Press **▲** or **▼** to select an age rating.
6. Press **Menu** to exit the **Child lock** menu.

5.9 Use subtitles

You can enable subtitles for each TV channel. Subtitles are broadcast via teletext or DVB-T digital broadcasts. With digital broadcasts, you have the additional option of selecting a preferred subtitle language.

5.9.1 Enable subtitles on analogue TV channels

1. Select an analogue TV channel.
2. Press **TELETEXT** on the remote control.
3. Enter the three digit page number of the subtitle page.
4. Press **TELETEXT** to switch off teletext.
5. Press **MENU** on the remote control and select **TV menu > Features > Subtitle**.
6. Press **▶** to enter the list.

TV menu	Features
TV settings	Subtitle
Features	Subtitle language
Installation	Sleeptimer
Software update	Child lock
	Set/Change code
	On timer
	Common interface
	Demo

- Press **▲** or **▼** to select **On** to display subtitles always or **On during mute** to display subtitles only when the sound is muted with the **MUTE** key on the remote control.
- Press **OK** to return to the **Features** menu.

Note

You must repeat this procedure to enable subtitles on each analogue channel.

5.9.2 Enable subtitles on digital TV channels

Repeat steps 5 to 8 in *Section 5.9.1 Enable subtitles on analogue TV channels.*

5.9.3 Select a subtitle language on digital TV channels

Note

When you select a subtitle language on a digital TV channel as described below, the preferred subtitle language set in the **Installation** menu is temporarily overruled.

- Press **MENU** on the remote control and select **TV menu > Features > Subtitle language**.
- Press **▶** to enter the list of available languages.
- Press **▲** or **▼** to select a subtitle language.
- Press **OK**.

5.10 View photos and listen to music

Connect an external USB storage device and view pictures (JPEG format only) or listen to music (MP3 or Linear PCM formats only).

Note

Philips will not be held responsible if your USB storage device is not supported nor shall Philips accept any liability for damage or loss of stored data.

5.10.1 Connect a USB storage device

While your TV is on, connect your USB storage device to the USB port on the side of your TV. The main menu appears automatically and the name of the USB device is highlighted next to **Multimedia**.

Television	TV menu
	Channel list
	Programme guide
Multimedia	

Note

See *Section 7.1 Connection overview* for a description of the side connectors, including the USB port.

5.10.2 Disconnect a USB storage device

Caution

To avoid damaging your USB device, always follow the procedure described below when disconnecting.

- Press **MENU** on the remote control to exit the **Multimedia** menu.
- Wait five seconds before disconnecting the USB device.

5.10.3 View your photos

- After connecting your USB storage device to the TV, press **▶** to enter the **Multimedia** menu. **Picture** is highlighted.

USB	Picture
Picture	Afrika_2001
Music	Paris_2006
	My_car.jpg
	Jean.jpg
	Mary.jpg

- Press **▶** to enter the **Picture** folder.
- Press **▲** or **▼** to select a picture or a picture album on the USB device.

Picture	Afrika_2001
Afrika_2001	Kenya.jpg
Paris_2005	Congo.jpg
My_car.jpg	Victoria.jpg
Jean.jpg	Dakar.jpg
Mary.jpg	Cairo.jpg

Afrika_2001	Afrika_2001
Kenya.jpg	 Kenya.jpg
Congo.jpg	
Victoria.jpg	
Dakar.jpg	
Cairo.jpg	

- Press **OK** to view the picture or to start a slide show of the pictures in the album.
 - Press **OK** to pause the slide show. Press **OK** again to restart.
 - Press one of the colour keys on the remote control to perform the corresponding function shown at the bottom of the screen.
 - Press the blue key to stop the show and to see more functions. If the function bar at the bottom disappears, press any colour key to make it reappear.
- Press **◀** and select another picture or another album.

Slide show settings

- No details / More details**
Displays the picture name, date, size and next picture in the slide show.
- Transitions**
Displays the list of available transition styles of the pictures. Press **▲** or **▼** to select and press **OK** to activate.
- Slide time**
Sets the time lag for picture transitions: **Short**, **Medium** or **Long**.
- Rotate**
Rotates a picture.
- Zoom**
Displays a list of available zoom magnifications.
- Start show/Stop show**
Starts or stops a slide show.

5.10.4 View pictures as thumbnails

Thumbnails allow you to view picture albums in an overview format.

- Select a picture album.
- Press **▶** to enter the picture list.
- Press the green key.
- Press **▲** or **▼**, **◀** or **▶** to highlight a picture.
- Press **OK** to view the picture.
- Press **◀** to return to the thumbnail overview.
- Press the green key again to go back to the picture list.

5.10.5 Listen to music

- After connecting your USB storage device to the TV, press **▶** to enter the **Multimedia** menu.
- Select **Music** then press **▶** to enter the

Music folder.

3. Press **▲** or **▼** to select a song or a music album.
4. Press **OK** to play the selected song or album.

Music settings

- **No details/More details**
Displays the file name.
- **Repeat one/all**
Repeat a song or an album.
- **Shuffle**
Play songs in a random sequence.

5.10.6 View a slide show with music

You can view a slide show of your stored pictures with background music.

1. Select an album of songs first then press **OK**.
2. Select an album to display then press **OK**.

5.11 Listen to digital radio channels

If digital broadcasting is available, digital radio channels are installed automatically during installation. To reorder the digital radio channels, see *Section 6.5 Rearrange the channels*.

1. Press **OK** on the remote control. The **All channels** menu is displayed.
2. Use the number keys to select a radio channel.
3. Press **OK**.

5.12 Update your TV software

Philips continuously tries to improve its products and we strongly recommend that

you update the TV software when updates are available. Check www.philips.com/support for availability.

5.12.1 Check your current software version

- Press **MENU** on the remote control and select **TV menu > Software update > Current software info**.

5.12.2 Check if software updates are available

Philips periodically transmits messages via digital broadcast, announcing when software updates are available:

- Press **MENU** on the remote control and select **TV menu > Software update > Announcement**.

5.12.3 Update software (digital broadcasts)

If using (DVB-T) digital broadcasts, your TV automatically receives software updates. If you receive a message on-screen prompting you to update your software:

- Select **Now** (recommended) to update the software immediately.
- Select **Later** to be reminded to update the software later.
- Select **Cancel** to exit the update (not recommended). If you cancel the update, manually update the software by pressing **MENU** and selecting **TV menu > Software update > Local updates**. Follow the on-screen instructions.

5.12.4 Update software (analogue broadcasts)

Note

Before performing this procedure be sure to:

- Set aside some time to complete the entire update.
 - Have available a USB storage device with at least 64MB of storage space.
 - Have access to a computer with a USB port and internet access.
1. Press **MENU** on the remote control and select **TV menu > Software update > Update assistant**.
 2. Select **Start now**.
 3. Insert the USB storage device and press the green key. An ID file is copied to the USB device.
 4. Press the green key to finish.
 5. Connect the USB storage device to your computer.
 6. In your computer, browse to the USB storage device and double-click the 'Update' HTML file.
 7. Follow the on-screen instructions to complete the update.

6 Install channels

The first time you setup your TV, you will be prompted to select an appropriate menu language and to perform automatic installation of all TV and digital radio channels (if available).

This chapter provides instructions on how to reinstall channels as well as other useful channel installation features.

Note

Re-installing channels modifies the **All channels** list.

6.1 Automatically install channels

This section describes how to search and store channels automatically. Instructions are for both digital and analogue channels.

Step 1 Select your menu language

Note

Skip to *Step 2 Select your country* if your language settings are correct.

1. Press **MENU** on the remote control and select **TV menu > Installation > Languages > Menu language**.

Languages	Menu language
Menu language	<input type="radio"/> English
Primary audio	<input type="radio"/> Español
Secondary audio	<input type="radio"/> Français
Primary subtitles	<input type="radio"/> Hrvatski
Secondary subtitles	<input type="radio"/> Italiano
Primary teletext	<input type="radio"/> Magyar
Secondary teletext	...

2. Press **▶** to enter the **Menu languages** menu.
3. Press **▲** or **▼** to select your language.
4. Press **OK** to confirm.

5. Press **◀** twice to return to the **Installation** menu.

Installation	Languages
Languages	Menu language
Time zone	Primary audio
Channel installation	Secondary audio
Preferences	Primary subtitles
Connections	Secondary subtitles
Factory settings	Primary teletext
	Secondary teletext

6. In addition to menu language, you can configure the following language settings via the **Languages** menu (digital channels only):

- **Primary/Secondary audio**
Select primary and secondary audio languages for digital channels.
- **Primary/Secondary subtitles**
Select primary and secondary subtitle languages for digital channels.
- **Primary/Secondary teletext**
Select primary and secondary teletext languages for digital channels.
- **Hearing impaired**
Select **On** to display subtitles with primary and secondary audio languages.

Step 2 Select your country

Select the country where you are located. The TV installs and arranges channels according to your country.

Note

Skip to *Step 3 Select Antenna or Cable* if your country settings are correct.

1. In the **Installation** menu, press **▼** to select **Channel installation**.
2. Press **▶** to enter the list. Automatic installation is highlighted.
3. Press **▶** to select Start now.

4. Press **OK** to confirm.
5. Press **▲** or **▼** to select your country.
6. Press **Next**.

Step 3 Select Antenna or Cable (DVB-C only)

⊖ Note

This option appears only if your country supports DVB-C (Digital Video Broadcasting-Cable). Skip to *Step 4 Install channels* if DVB-C is not available in your country.

1. Press **▲** or **▼** to select **Antenna** or **Cable**.
Selecting **Antenna** installs channels available via DVB-T (Digital Video Broadcasting-Terrestrial). Selecting **Cable** installs channels available via DVB-C.
2. Press **Next**.

Step 4 Install channels

Your TV searches and stores all available digital and analogue TV channels as well as all available digital radio channels.

⚠ CAUTION

If you select **Cable** in *Step 3 Select Antenna or Cable*, a **Settings** menu is available. Leave settings unchanged unless your DVB-C provider supplies values for **Network frequency**, **Network ID** or **Symbol rate**. Note that setting **Frequency scan** to **Full** can extend installation time significantly.

1. Press **Start** to start installation.
The installation may take a few minutes.
2. When complete, press **Finish** to return to the **Installation** menu.
3. Press **MENU** to exit.

⊖ Note

If you have access to DVB-T and DVB-C, and want to view channels from both networks, you must perform channel installation twice — once for DVB-T and once for DVB-C. After installation, switch between channels as described in *Section 4.3 Access DVB-C and DVB-T channel networks*.

⊗ Tip

When digital TV channels are found, the list of installed channels may display empty channel numbers. If you want to rename, reorder or uninstall stored channels, see *Section 6.5 Rearrange channels*.

6.2 Manually install channels

This section describes how to search and store analogue TV channels manually.

Step 1 Select your system

⊖ Note

Skip to *Step 2 Search and store new TV channels* if your system settings are correct.

1. Press **MENU** on the remote control and select **TV menu > Installation > Channel installation > Analogue: Manual installation**.

Channel install...	Analogue: Manual...
Automatic install...	System
Installation update	Search
Digital: Test recept...	Fine tune
Analogue: Manual...	Store current ch...
Rearrange	Store as new ch...

2. Press **▶** to enter the **Channel installation** menu. **System** is highlighted.
3. Press **▶** to enter the **System** list.
4. Press **▲** or **▼** to select your country or region.
5. Press **◀** to return to the **Channel installation** menu.

Step 2 Search and store new TV channels

1. Press **MENU** on the remote control and select **TV menu > Installation > Channel installation > Analogue: Manual installation > Search.**
2. Press **▶** to enter the **Search** menu.
3. Press the red key and use the number keys on the remote control to manually enter the three digit frequency. Alternatively, press the green key to automatically search for the next channel.
4. Press **◀** when the new channel is found.
5. Select **Store as new channel** to store the new channel under a new channel number.
6. Press **▶** to enter.
7. Press **OK. Done** appears.
8. Press **MENU** to exit.

6.2.1 Fine tune analogue channels

You can manually fine tune analogue channels when reception is poor.

1. Press **MENU** on the remote control and select **TV menu > Installation > Channel installation > Analogue: manual installation > Fine tune.**
2. Press **▶** to enter the **Fine tune** menu.
3. Press **▲** or **▼** to adjust the frequency
4. Press **◀** when done.
5. Select **Store current channel** to store the fine tuned channel under the current channel number.
6. Press **▶** to enter.
7. Press **OK. Done** appears.
8. Press **MENU** to exit.

6.3 Rename channels

1. Press **MENU** on the remote control and select **TV menu > Installation > Channel installation > Rearrange.**
2. Press **▶** to enter the **Rearrange** list.
3. Press **▲** or **▼** in the **Rearrange** list to select the channel you want to rename.
4. Press the red key.
5. Press **◀** and **▶** to select characters or **▲** and **▼** to change the characters. Space, numbers (0-9) and other special characters are located between **z** and **A.**
6. Press the green key or **OK** to finish.

Tip

Delete all characters by pressing the yellow key. Delete only the highlighted character by pressing the blue key.

6.4 Uninstall or reinstall channels

You can uninstall a stored channel or reinstall an uninstalled channel.

1. Press **MENU** on the remote control and select **TV menu > Installation > Channel installation > Rearrange.**
2. Press **▶** to enter the **Rearrange** list.
3. Press **▲** or **▼** to select the channel you want to uninstall or reinstall.
4. Press the green key to uninstall or reinstall the channel.
5. Press **MENU** to exit.

6.5 Rearrange channels

1. Press **MENU** on the remote control and select **TV menu > Installation > Channel installation > Rearrange.**

2. Press **▶** to enter the **Rearrange** list.
3. Press **▲** or **▼** to select the channel you want to rearrange.
4. Press the yellow key to move the channel up the list. or press the blue key to move the channel down the list.
5. Press **MENU** to exit.

6.6 Manually update the channel list

If your TV is in standby mode, an update is performed every morning. This update matches channels stored in your channel list with those available from your broadcaster. If a channel is unavailable, it is automatically removed from the channel list.

In addition to the automatic update, you can manually update the channel list.

1. Press **MENU** on the remote control and select **TV menu > Installation > Channel installation > Installation update**.
2. Press **▶** to enter the **Installation update** menu. **Start now** is highlighted.
3. Press **OK**.
4. Press the green key to start the update. This may take a few minutes.
5. When the update is complete, press the red key to return to the **Channel installation** menu.
6. Press **MENU** to exit.

6.7 Test digital reception

If using digital broadcasts, you can check the quality and signal strength of digital channels. This allows you to reposition and test your antenna or satellite dish.

1. Press **MENU** on the remote control

and select **TV menu > Installation > Channel installation > Digital: Test reception**.

2. Press **▶** to enter the **Digital: Test reception** menu.
3. Press **OK**.
4. Press the green key to automatically start the test or manually enter the frequency of the channel you want to test. If the signal quality and strength is poor, reposition the antenna or satellite dish and retest.
5. When complete, press the yellow key to store the frequency.
6. Press the red key to return to the **Channel installation** menu.
7. Press **MENU** to exit.

Note

If you have further problems with the reception of your digital broadcast, contact a specialised installer.

6.8 Start a demo

1. Press the red key on the remote control. Alternatively, press **MENU** on the remote control and select **TV menu > Features > Demo**.
2. Press **▶** to enter the **Demo** menu.
3. Select a demo and press **OK**.
4. Press the red key to exit.

6.9 Reset TV to factory settings

Resetting your TV to factory settings restores default picture and sound settings. Channel installation settings remain the same.

1. Press **MENU** on the remote control and select **TV menu > Installation > Factory settings**.
2. Press **▶** to enter the **Factory settings** menu. **Reset** is highlighted.
3. Press **OK** to reset to factory settings.
4. Press **MENU** to exit.

7 Connect devices

7.1 Connection overview

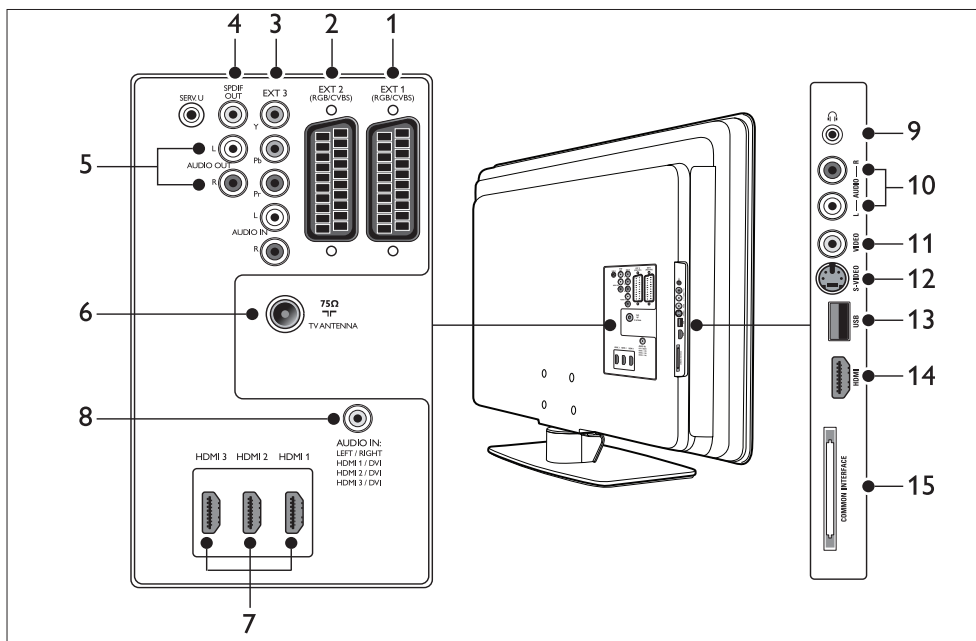

Back connectors

1. EXT 1

First SCART connector for DVD players, VCRs, digital receivers, game consoles and other SCART devices. Supports Audio L/R, CVBS in/out, RGB.

2. EXT 2

Second SCART connector. Supports Audio L/R, CVBS in/out, RGB.

3. EXT 3

Component video (Y Pb Pr) and Audio L/R input connectors for DVD players, digital receivers, game consoles and other component video devices.

4. SPDIF OUT

SPDIF sound output connector for home theatres and other audio systems.

5. AUDIO OUT L/R

Sound output cinch connectors for home theatres or other audio systems.

6. TV ANTENNA

7. HDMI 1/2/3

HDMI input connectors for Blu-ray Disc players, digital receivers, game consoles and other high-definition devices.

ⓘ Note

The number of HDMI connectors available may vary according to your TV model.

8. AUDIO IN

Mini-jack connector for PC audio in (when connecting a PC via a DVI-HDMI adaptor).

Side connectors

9. Headphones

Stereo mini-jack.

10. AUDIO L/R

Audio L/R input connectors for composite and S-Video devices.

11. VIDEO

Video input cinch connector for composite devices.

12. S-VIDEO

S-Video input connector for S-Video devices.

13. USB

USB connector for storage devices.

14. HDMI

Additional HDMI connector for mobile high-definition devices.

15. COMMON INTERFACE

Slot for Conditional Access Modules.

7.2 Select connection quality

This section describes how you can enhance your audio visual experience by connecting your devices with the best possible connectors.

After connecting your devices, be sure to enable them as described in *Section 7.4 Setup devices*.

7.2.1 HDMI - Highest quality ★★★★★

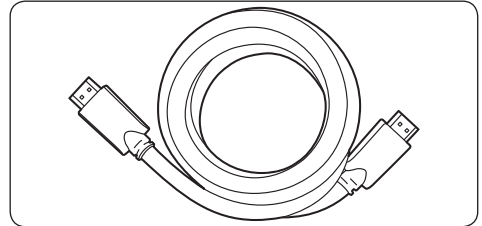

HDMI produces the best audio visual quality possible. Both audio and video signals are combined in one HDMI cable, providing an uncompressed, digital interface between your TV and HDMI devices. You must use HDMI to experience full high-definition video. You must also use HDMI cables to enable Philips EasyLink as described in *Section 7.5 Use Philips EasyLink*.

✳ Tip

If your PC only has a DVI connector, use a DVI-HDMI adaptor to connect your device to a HDMI connector at the back of the TV. You must connect a separate audio cable from the device to the AUDIO IN mini-jack connector.

☰ Note

Philips HDMI supports HDCP (High-bandwidth Digital Contents Protection). HDCP is a form of Digital Rights Management that protects high definition content in DVD or Blu-ray Discs.

7.2.2 Component (Y Pb Pr) - Higher quality ★★★★★

Component (Y Pb Pr) video provides better picture quality than S-Video or composite video connections. Though component video supports high-definition signals, picture quality is lower than HDMI and is analogue.

When connecting a component video cable, match the cable colours to the EXT 3 connectors on the back of the TV. Also, connect a Audio L/R cable to the red and white Audio L/R input connectors at EXT 3.

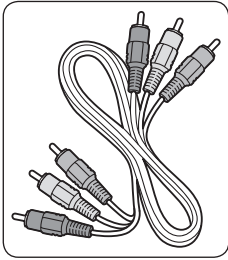

Component video cable
- Red, Green, Blue

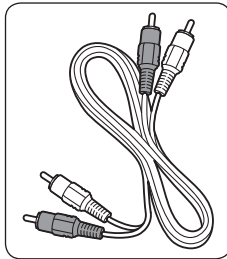

Audio L/R cable
- Red, White

7.2.3 SCART - Good quality ★★★

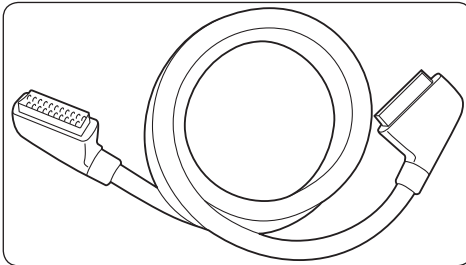

SCART combines audio and video signals in one cable. Audio signals are stereo, while video signals can be composite or S-Video quality. SCART does not support high-definition video and is analogue. Two SCART connectors are provided on the TV, EXT 1 and EXT 2.

7.2.4 S-Video - Good quality ★★

An analogue connection, S-Video provides better picture quality than composite video. When connecting your device with S-Video, plug the S-Video cable to the S-Video connector on the side of the TV. You must connect a separate Audio L/R cable from the device to the red and white Audio L/R connectors on the side of the TV.

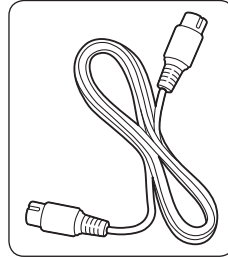

S-Video cable

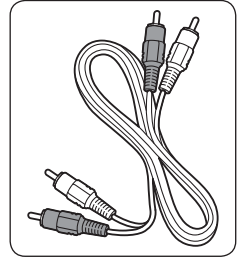

Audio L/R cable
- Red, White

7.2.5 Composite - Basic quality ★

Composite video provides basic analogue connectivity, usually combining a (yellow) video cinch cable with (red and white) Audio L/R cinch cable. Match the cable colours when connecting to the composite Video and Audio L/R input connectors on the side of the TV.

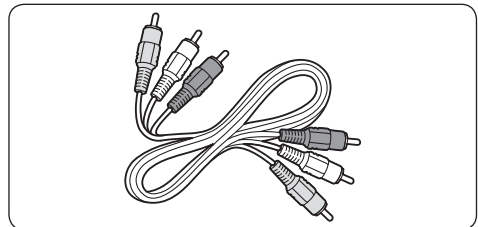

Composite audio/video cable - Yellow, red and white

7.3 Connect devices

This section describes how to connect various devices with different connectors and supplements examples provided in the *Quick Start Guide*.

⚠ Caution

Disconnect the mains cord before connecting devices.

📌 Note

Different types of connectors may be used to connect a device to your TV, depending on availability and your needs.

7.3.1 Blu-ray Disc player

For full high-definition video, connect a HDMI cable as illustrated:

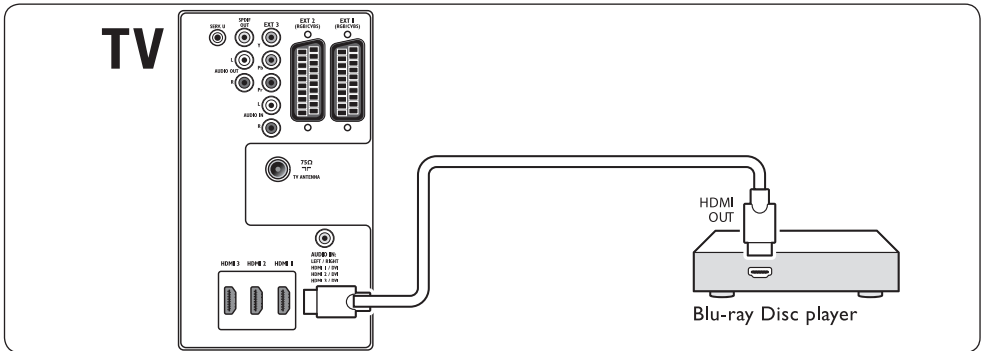

7.3.2 DVD player

For DVD video, connect a SCART cable as illustrated:

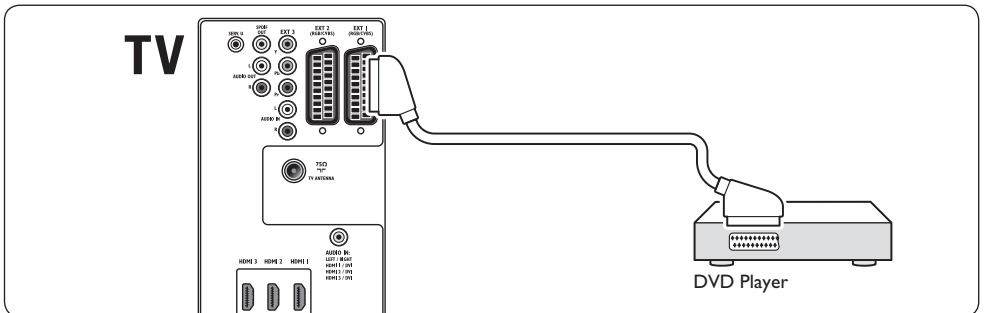

7.3.3 Satellite receiver

To receive analogue channels via antenna and digital channels via a satellite receiver, connect an antenna cable and SCART cable as illustrated:

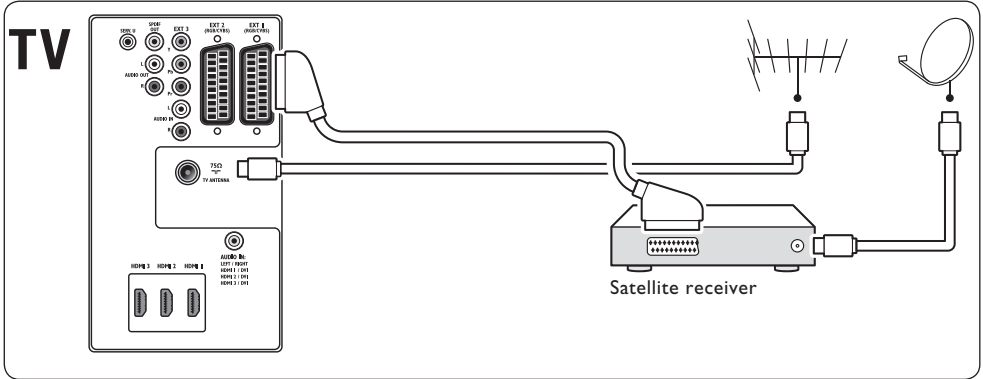

7.3.4 HD digital receiver

To receive analogue channels via antenna and digital channels via a HD digital receiver, connect two antenna cables and HDMI cable as illustrated:

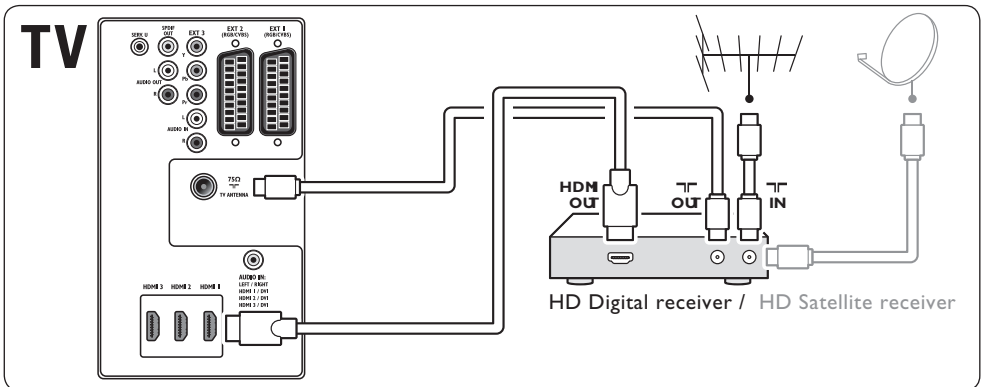

7.3.5 Combined DVD recorder and digital receiver

To receive analogue channels via antenna and record programs on a combined DVD recorder and digital receiver, connect two antenna cables and one SCART cable as illustrated:

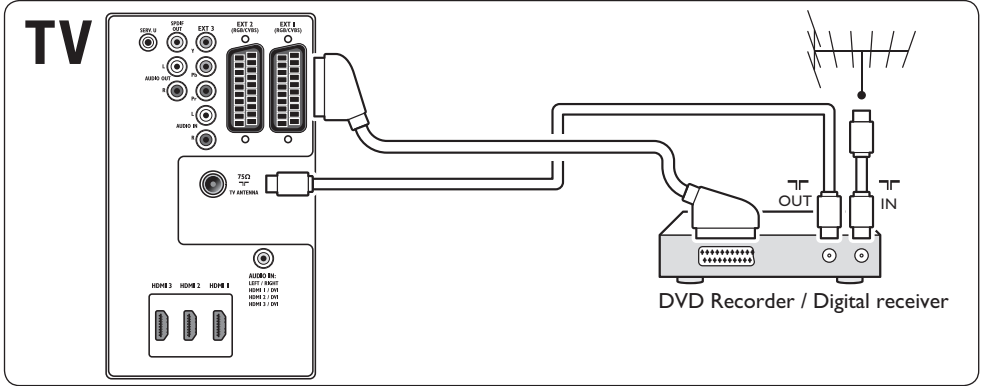

7.3.6 Separate DVD recorder and receiver

To receive analogue channels via antenna and record programmes on a separate DVD recorder and receiver, connect three antenna cables and three SCART cables as illustrated:

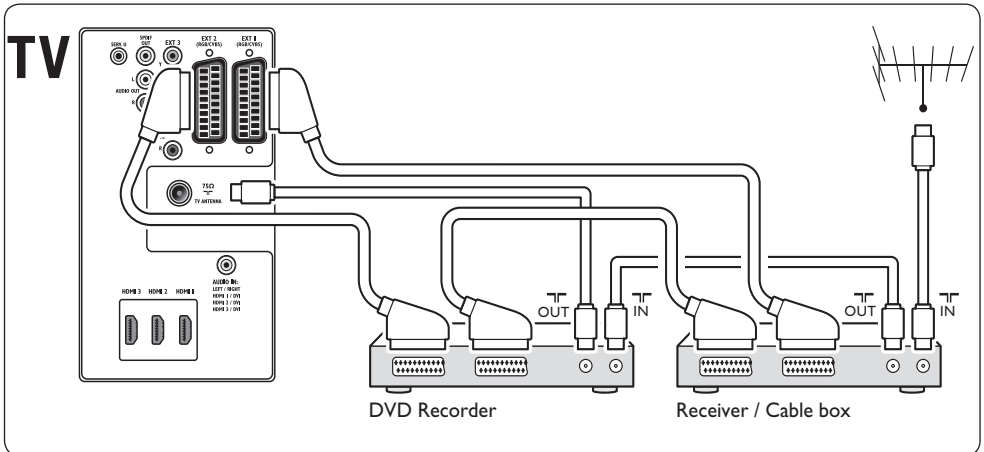

7.3.7 DVD recorder and home theatre system

To receive analogue channels via antenna, output sound to a home theatre system and record programmes on a DVD recorder, connect two antenna cables, one SCART cable and two digital audio cables as illustrated:

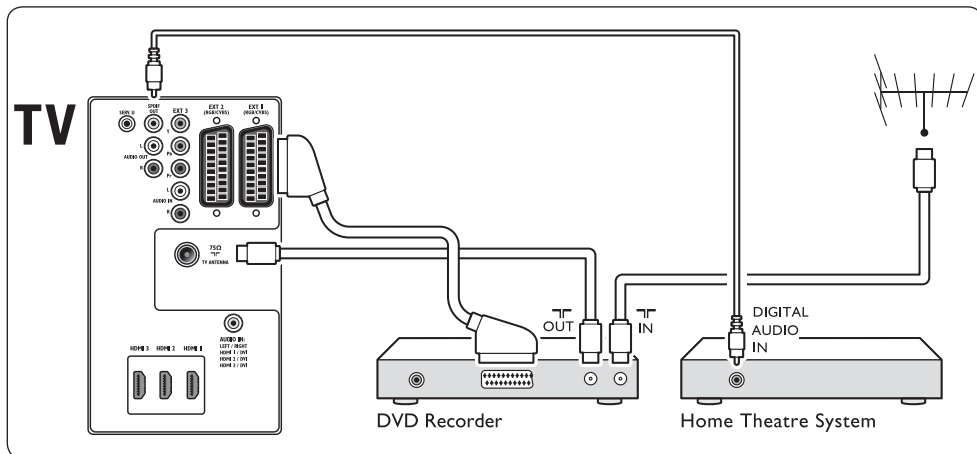

Note

If using a home theatre or other audio system, the best synchronisation between images and sound is achieved by connecting the audio signal from your playback device to the TV first. Subsequently, channel the audio signal to the home theatre system or audio device via the audio connectors on the back of the TV.

7.3.8 Game console or camcorder

The most practical connection for a mobile game console or camcorder may be at the side of the TV. You can, for example, connect the game console or camcorder to VIDEO/S-Video and AUDIO L/R connectors at the side of the TV. A HDMI connector is also available for high-definition devices.

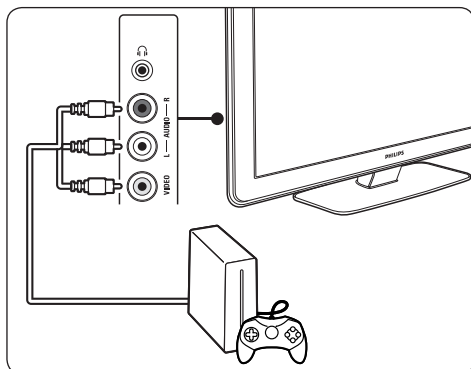

A permanent game console or camcorder can be connected to a HDMI connector or EXT 3 (component) connectors at the back of the TV.

7.3.9 Personal Computer

Before connecting the PC:

- Set the PC monitor refresh rate to 60Hz. See *Section 8 Technical specifications* for a list of computer resolutions.
- Change the TV picture format to **Unscaled** as described in *Section 5.3.4. Change picture format*.

To connect a PC to the back of the TV

1. Using a HDMI to DVI cable or a HDMI-to-DVI adaptor (attached to a HDMI cable), connect a HDMI connector on the back of your TV to the DVI connector on your PC.
2. Connect an audio cable from your PC to the AUDIO IN mini-jack connector at the back of the TV.

Note

You must assign the AUDIO IN mini-jack connector to the HDMI connector as described in *Section 7.4.3 Assign the AUDIO IN mini-jack connector*.

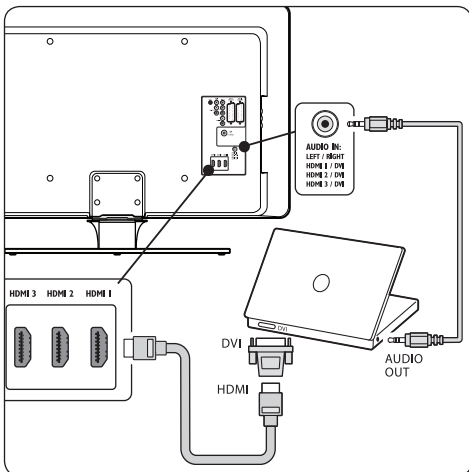

7.4 Setup devices

When all devices are connected, you must select the type of device attached to each connector.

7.4.1 Assign devices to connectors

For easy selection and best signal handling, assign the device connected to the connectors on your TV.

1. Press **MENU** on the remote control and select **TV menu > Installation > Connections**.

Connections	EXT 1
EXT 1	None
EXT 2	DVD
EXT 3	Blu-ray
HDMI 1	HDD/DVDR
HDMI 2	HD rec.
HDMI 3	Game
Side	VCR
...	...

2. Press **▶** to enter the list.
3. Press **▼** or **▲** to select a connector.
4. Press **▶** to enter the list.
5. Press **▼** or **▲** to select the device attached to the connector.
6. Press **OK** to select the device.
7. Repeat the procedure until all devices are correctly assigned to connectors.
8. Press **MENU** to exit.

7.4.2 Assign the AUDIO IN mini-jack connector

If you connect audio from a PC to the AUDIO IN mini-jack connector at the back of the TV, you must associate it to the HDMI connector.

1. Press **MENU** on the remote control and select **TV menu > Installation >**

Connections > Audio In L/R.

Connections	AUDIO IN L/R
...	None
EXT 3	HDMI 1
HDMI 1	HDMI 2
HDMI 2	HDMI 3
HDMI 3	
Side	
AUDIO IN L/R	

- Press **▶** to enter the list.
- Press **▼** or **▲** to select the HDMI connector used by the PC.
- Press **MENU** to exit.

7.4.3 Assign a channel decoder

Decoders that decode digital channels can be connected to EXT 1 or EXT 2 (SCART). You have to assign the TV channel as a channel to be decoded. Then assign the connection where the decoder is connected.

- Press **MENU** on the remote control and select **TV menu > Installation > Decoder > Channel**.
- Press **▶** to enter the list.
- Press **▼** or **▲** to select the channel to decode.
- Press **◀** and go back to select **Status**.
- Press **▼** or **▲** to select the connector used by the decoder.
- Press **MENU** to exit.

7.5 Use Philips EasyLink

Your TV supports Philips EasyLink, which enables one-touch play and one-touch standby between EasyLink-compliant devices. Compliant devices must be connected to your TV via HDMI and assigned as described in *Section 7.4.1 Assign devices to connectors*.

7.5.1 Enable or disable EasyLink

- Press **MENU** on the remote control then select **TV menu > Installation > Preferences > EasyLink**.
- Select **On** or **Off**.

7.5.2 Use one-touch play

- After enabling EasyLink, press play on your device. The TV automatically switches to the correct source.

7.5.3 Use one-touch standby

- Press and hold **⏻ STANDBY** on the TV or device remote control for at least three seconds. The TV and all connected HDMI devices switch to standby.

7.6 Prepare TV for digital services

Scrambled digital TV channels can be decoded with a Conditional Access Module (CAM) and a Smart card provided by a digital TV service operator.

The CAM may enable several digital services, depending on the operator and services you choose (for example, pay TV). Contact your digital TV service operator for more information about services and terms.

7.6.1 Using the Conditional Access Module

⚠ WARNING

Switch off your TV before inserting a CAM. Be sure to follow the instructions described below. Wrong insertion of a CAM may damage both the CAM and your TV.

- Following the directions printed on the CAM, gently insert the CAM into the Common Interface on the side of the TV.

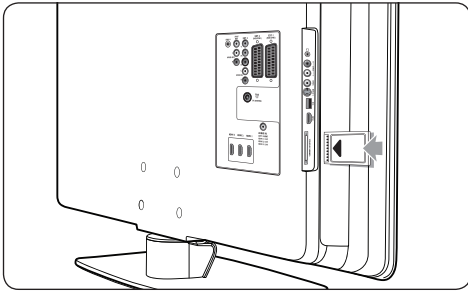

2. Push the CAM in as far as it will go.

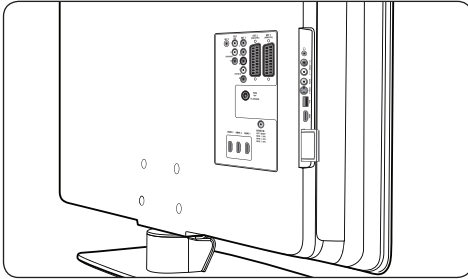

3. Turn on the TV and wait for the CAM to be activated. This may take several minutes.

Note

Do not remove the CAM from the slot. Removing the CAM will deactivate the digital services.

7.6.2 Access CAM services

- After inserting and activating the CAM, press **MENU** on the remote control and select **TV menu > Features > Common interface**.

This menu option is only available if the CAM is correctly inserted and activated. On-screen applications and content are provided by your digital TV service operator.

8 Technical specifications

Supported display resolutions

• Computer formats

Resolution	Refresh rate
640 x 480	60Hz
800 x 600	60Hz
1024 x 768	60Hz
1920 x 1080i	60Hz
1920 x 1080p	60Hz

• Video formats

Resolution	Refresh rate
480i	60Hz
480p	60Hz
576i	50Hz
576p	50Hz
720p	50Hz, 60Hz
1080i	50Hz, 60Hz
1080p	24Hz, 25Hz, 30Hz
1080p	50Hz, 60Hz

Tuner / Reception / Transmission

- Antenna input: 75ohm coaxial (IEC75)
- TV system: DVB COFDM 2K/8K
- Video playback: NTSC, SECAM, PAL
- DVB Terrestrial (see listed countries on the back of the TV)

Multimedia

- Connection: USB
- Playback formats: MP3, Linear PCM, slide show (.alb), JPEG

Remote control

- Type: RCPF02E08B/RCPF05E08B
- Batteries: 2 x AAA size (LR03 type)

Connections (Rear)

- EXT 1 (SCART): Audio L/R, CVBS in/out, RGB
- EXT 2 (SCART): Audio L/R, CVBS in/out, RGB

- EXT 3: Component (Y Pb Pr), Audio L/R in
- HDMI 1/2/3

Note

The number of HDMI connectors available may vary according to your TV model.

- SPDIF OUT: Digital audio out (coaxial-cinch-S/PDIF). Display synchronised.
- AUDIO OUT L/R: Analogue audio out.
- TV ANTENNA
- AUDIO IN: Mini-jack audio in for PC DVI-HDMI connections.

Connections (Side)

- Headphone out (stereo mini-jack)
- AUDIO L/R in
- Video (CVBS) in
- S-Video
- USB
- HDMI
- Common Interface (CAM slot)

Power

- Mains power: AC 220-240V ($\pm 10\%$)
- Power and standby power consumption: See technical specifications at www.philips.com
- Ambient temperature: 5°C - 35°C

Specifications are subject to change without notice. For detailed specifications of this product go to www.philips.com/support.

9 Troubleshooting

This section describes commonly-encountered issues and accompanying solutions.

9.1 General TV issues

The TV does not switch on:

- Unplug the mains cord, wait for one minute and plug in the mains again.
- Verify that the mains cord is properly connected and that the mains are powered.

The remote control is not working properly:

- Verify that the remote control batteries are correctly inserted according to the +/- orientation.
- Replace the remote control batteries if they are flat or weak.
- Clean the remote control and TV sensor lens.

The standby light on the TV blinks red:

- Turn off the TV and unplug the mains cord. Wait until the TV cools down before reinserting the mains cord and turning on the TV. If the blinking occurs again, contact our Customer Support Centre.

You forgot your code to unlock Child lock

- Enter '8888' as described in *Section 5.8.3 Lock TV channels or connected devices (Child lock)*.

The TV menu is in the wrong language

- See *Section 6.1 Automatically install channels* for instructions on how to change the TV menu to your preferred language.

When turning the TV on/off/to standby, you hear a creaking sound from the TV chassis:

- No action is required. The creaking sound is normal expansion and contraction of the TV as it cools and warms up. This does not impact performance.

9.2 TV channel issues

Previously installed channels do not appear in the channel list:

- Verify that the correct list is selected.
- The channel may have been uninstalled to the **Rearrange** menu. To access the menu, press **MENU** on the remote control and select **TV Menu > Installation > Channel installation > Rearrange**.

No digital channels were found during the installation:

- Verify if the TV supports DVB-T in your country. See the listed countries on the back of the TV.

9.3 Picture issues

The power indicator is on, but there is no picture:

- Verify if the antenna is connected properly.
- Verify if the correct device is selected.

There is sound but no picture:

- Verify that picture settings are correctly set. See *Section 5.3.2 Adjust picture settings*.

You receive poor TV reception from an antenna connection:

- Check that the antenna is properly connected to the TV.
- Loud speakers, unearthed audio devices, neon lights, high buildings or mountains can influence the picture quality. Try to improve the reception quality by changing the antenna direction or moving devices away from the TV.

- Verify if the correct TV system is selected for your region. See *Section 6.2 Manually install channels.*
- If reception on only one channel is poor, try to fine tune this channel. See *Section 6.2.1 Fine tune channels.*

You receive poor picture quality from connected devices:

- Check that the devices are connected properly. Also, be sure to assign devices to connectors as described in *Section 7.4.1 Assign devices to connectors.*
- Verify that picture settings are correctly set. See *Section 5.3.2 Adjust picture settings.*

The TV did not save my settings:

- Verify that the TV is set to **Home** mode, which offers you complete flexibility to change settings. See *Section 5.4 Change to Shop or Home mode.*

The picture does not fit the screen, it is too big or too small:

- Try using a different picture format as described in *Section 5.3.4 Change picture format.*
- Assign your device to connectors as described in *Section 7.4.1 Assign devices to connectors.*

The picture position on screen is not correct:

- Picture signals from some devices do not fit the screen correctly. Check the signal output of the device.

9.4 Sound issues

There is picture but no sound from the TV:

Note

If no audio signal is detected, the TV automatically switches off audio output and

does not indicate malfunction.

- Check that all cables are properly connected.
- Check that the volume is not set to 0.
- Check that the sound is not muted.

There is picture but sound quality is poor:

- Check **Sound** settings as described in *Section 5.3.5 Adjust sound settings*, verifying that **Stereo** selected and **Equalizer** settings are correct. If needed, try resetting audio settings to standard.

There is picture but sound comes from one speaker only:

- Verify that **Balance** correctly set as described in *Section 5.3.5 Adjust sound settings.*

9.5 HDMI connection issues

You encounter problems with HDMI devices

- HDCP support can delay the time taken for a TV to display content from a device.
- If the TV does not recognise the device and the screen displays no picture, try switching from one device to another and back again to restart.
- If you experience intermittent sound disruptions, check the user manual of the HDMI device to verify that output settings are correct. Alternatively, try connecting the audio signal from the HDMI device to the TV via AUDIO IN at the back of the TV.
- If a HDMI-to-DVI adaptor or HDMI to DVI cable is used, check that an additional audio cable is connected to AUDIO IN. You must also assign the audio connector as described in *Section 7.4.2 and 7.4.3.*

9.6 USB connection issues

The TV does not display the USB device content:

- Set your device to 'Mass Storage Class' compliant, as described in your device documentation.
- Your USB device may not be compatible with the TV.
- Not all audio and picture files are supported. See *Section 8 Technical specifications* for a list of supported file types.

Audio and picture files do not play or display smoothly

- The transfer performance of the USB device may limit the transfer rate.

9.7 PC connection issues

The PC display on my TV is not stable or is not synchronised:

- Check that a supported resolution and refresh rate is selected on your PC. See *Section 8 Technical specifications* for supported resolutions and refresh rates.

10 Index

A

- Active Control 19
- All channels list 24
- Analogue
 - Channel installation 33
 - Fine tune channels 34
- Antenna
 - Connect 9
- Assign
 - Devices 44
- Audio language 21
- Automatic
 - Channel installation 32
 - Surround 21
 - Volume leveling 21

B

- Back connectors 5
- Balance
 - Sound 21
- Brightness 18

C

- Care
 - Environment 4
 - Screen 4
- Channels
 - All channels list 24
 - Change 12
 - Decoder 45
 - Favorite lists
 - Select 24
 - Setup 24
 - Use 24
 - Installation
 - Automatic 32
 - Manual 33
 - Rearrange 34
 - Rename 34
 - Test digital reception 35
 - Uninstall 34
 - Update channel list 35
- Child lock
 - Lock all channels/devices 27
 - Lock from a certain time 27
 - Lock one or more channel/device 27
 - Set/change code 26
 - Set parental rating 27
- Clock 17
- Colour enhancement 19
- Component cable 39
- Composite 39
- Conditional Access Module (CAM)
 - Insert 45
 - Menu 46
- Connections
 - Back connectors 37
 - Cable quality
 - Component 39
 - Composite 39
 - HDMI 38
 - SCART 39
 - S-Video 39
 - Devices
 - Blu-ray Disc player 40
 - Conditional Access Module (CAM) 45
 - DVD player 40
 - DVD recorder/Digital receiver 42
 - DVD recorder/Home theatre system 43
 - DVD recorder/Receiver 42
 - Game console/camcorder 43
 - HD digital receiver 41
 - PC 44
 - Satellite receiver 41
 - USB 28
 - Philips Easylink
 - Enable/disable 45
 - Use 45
 - Setup devices

Assign channel decoder 45
Assign to connectors 44
Side connectors 38
Contrast 18
Country
 Selection 32
Custom tint 18

D
Decoder 45
Delta volume 21
Demo 35
Devices
 Watch 12
Digital
 Radio 30
 Services 45
 Teletext 23
Dual I/II 21
Dual screen teletext 22
Dynamic contrast 19

E
Electronic Programme Guide
 Use 25
Environmental care 4
Equalizer 21

F
Factory setting 36
Favorite lists 24
Fine tune channels 34

H
HDCP 38
HDMI cable 38
Home mode 22
Hue 18

K
Kensington lock 7

L
Language
 Audio 21
 Menus 32
 Subtitles 28
Light sensor 19

M
Mains
 Connect 9
Manual channel installation 33
Menus
 Child lock 26
 Language 32
 Main
 Access 16
 Use 16
 Quick access
 Use 17
 Teletext menu 23
Mono sound 21
Mute 15

N
Noise reduction 19

O
On timer 26

P
Parental rating 27
Philips EasyLink 45
Photos and music
 Connect USB device 28
 Listen to music 29
 View photos 29
 View slide show with music 30
Picture
 Adjust settings
 Active Control 19
 Brightness 18

- Colour 18
- Colour enhancement 19
- Contrast 18
- Custom tint 18
- Dynamic contrast 19
- Hue 18
- Light sensor 19
- Noise reduction 19
- Sharpness 18
- Tint 18
- Change format 20
- Use Settings assistant 18
- Use smart settings
 - Current 19
 - Movie 19
 - Standard 19
 - Vivid 19
- Position TV 7
- Power
 - Connect 9

Q

- Quick access menu 17

R

- Radio channels 30
- Rearrange channels 34
- Recycling product 4
- Remote control
 - Advanced use 14
 - Basic use 6
 - Batteries 10
- Rename channels 34
- Reset to factory settings 36

S

- Safety information 3
- SCART cable 39
- Screen care 4
- Settings
 - Picture

- Adjust settings 18
- Change format 20
- Use Settings assistant 18
- Use smart settings 19
- Sound
 - Adjust settings 21
 - TV location
 - Change location 22
- Setup devices 44
- Sharpness 18
- Shop mode 22
- Side
 - Connectors 5
 - Controls 5
- Sleeptimer 26
- Smart settings
 - Current 19
 - Movie 19
 - Standard 19
 - Vivid 19
- Software update
 - Check availability 30
 - Check version 30
 - Update (analogue) 31
 - Update (digital) 30
- Sound
 - Adjust settings
 - Audio language 21
 - Automatic volume leveling 21
 - Auto surround 21
 - Balance 21
 - Delta volume 21
 - Dual I/II 21
 - Equalizer 21
 - Headphone volume 21
 - Mono/Stereo 21
 - Surround mode 21
 - Volume 21
 - Stereo sound 21
- Subtitles
 - Analogue TV 27

- Digital TV 28
- Language 28
- Surround sound
 - Auto 21
 - Mode 21
- S-Video 39
- Switch TV
 - Off 11
 - On 10, 11
 - On from standby 11
 - To standby 11
- System selection 33

T

- Technical specifications 47
- Teletext
 - Advanced use
 - Cycle subpages 23
 - Digital teletext 23
 - Dual screen 22
 - Enlarge 23
 - Language 23
 - Reveal 23
 - Search 22
 - Select subpages 22
 - Teletext 2.5 23
 - T.O.P broadcasts 22
- Timers
 - On timer 26
 - Sleeptimer 26
- Time zone 33
- Tint 18
- T.O.P. teletext 22
- Troubleshooting 47
- TV
 - Channel installation 32
 - Channels
 - Change 12
 - Favorite lists 24
 - Child lock 26
 - Connect

- Antenna 9
- Mains 9
- Connections
 - Back 37
 - Devices 40
 - Quality 38
 - Side 38
- Demo 35
- Electronic Programme Guide 25
- Get started 7
- Main menus
 - Access 16
 - Use 16
 - Overview 5
 - Photos and music 28
 - Position 7
 - Ideal distance 7
 - Quick access menu
 - Use 17
 - Remote control
 - Advanced use 14
 - Basic use 6
 - Batteries 10
 - Reset to factory setting 36
 - Side controls 5
 - Software update 30
 - Stand 8
 - Subtitles 27
 - Switch
 - Off 11
 - On 10, 11
 - On from standby 11
 - To standby 11
 - Teletext
 - Advanced use 22
 - Basic use 13
 - Timers
 - On timer 26
 - Sleeptimer 26
 - Volume 12
 - Wall mount 7

Watch
Channels 12
Devices 12

U

Uninstall channels 34
USB device
 Connect 28
 Disconnect 28

V

VESA wall bracket 7
Video formats 47
Volume
 Adjust 12, 21
 Automatic leveling 21
 Delta 21
 Headphone 21

W

Wall mount TV 7

Y

Y Pb Pr 39



Information about how to re-tune your TV during the digital TV switchover.

Keep this user manual safe – you'll need it.

.....

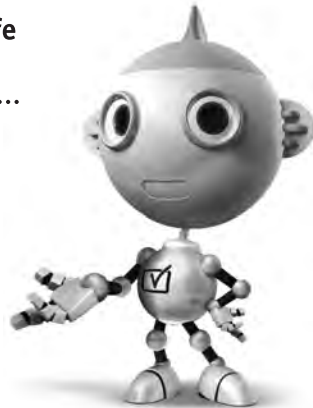

Television in the UK is going digital, bringing us all more choice and new services. Starting in late 2007 and ending in 2012, television services in the UK will go completely digital, TV region by TV region.

Please see the next page to find out when your area switches to digital.

Digital UK is the independent, non-profit organisation leading the process of digital TV switchover in the UK. Digital UK provides impartial information on what people need to do to prepare for the move to digital, and when they need to do it.

How the switchover affects your TV equipment:

Your new TV has a digital tuner built in, which means it is ready to receive the Freeview signal by simply plugging it into your aerial socket (check if you can get digital TV through your aerial now, or whether you'll have to wait until switchover, at www.digitaluk.co.uk).

When the TV switchover happens in your area, there are at least two occasions when you will need to re-tune your TV in order to continue receiving your existing TV channels, and also to pick up new ones.

Digital UK, the body leading the digital TV switchover, will advise you when you need to re-tune during the switchover. If you choose to connect your TV to satellite or cable with a digital box then it will not be affected by switchover, and you won't need to re-tune.

If you have any questions, please contact your equipment supplier or call Digital UK on ... 0845 6 50 50 50 or visit www.digitaluk.co.uk

How to re-tune:

To find out how to re-tune your TV, check this user manual for details. Go to section **6 Install channels**.

If you do not re-tune your channels when advised to do so by Digital UK, you may lose some or all of your channels until you do re-tune. You should re-tune your TV every few months to check for any new channels.

If you are missing any channels, it may be that they are not available in your area, or that your aerial needs upgrading.

When does switchover happen?

*Copeland switches on October 17, 2007

The exact date you switch depends on the transmitter you are served by. To check when you switch, go to Digital UK's postcode checker on www.digitaluk.co.uk

Check your ITV news service or look at Teletext page 106 to see what TV region you're in.



Visit us at digitaluk.co.uk
Call us on 0845 6 50 50 50†

† Calls charged at BT rate of 3p per minute daytime and 1p per minute evenings and weekends. Rates may vary for calls from non-BT lines.