

Register your product and get support at
www.philips.com/welcome

EN User manual

PHILIPS

Contents

1	Notice	2		
2	Important	4		
3	TV overview	6		
	Side controls	6		
	Guest menu	6		
	Access the guest menu with the PBS setup remote control	6		
	Access the guest menu with the guest remote control	7		
4	Access and use the setup menu	8		
	Select a language	9		
	Select the country	9		
	Set the type of communication	9		
	Set the number of channels	9		
	Auto install, program install, and configuration	10		
	Cloning/upgrade and healthcare	10		
	Set the clock	10		
5	Configuration of advanced settings	11		
	Configure the switch-on settings	11		
	Configure the picture settings	14		
	Configure the sound settings	14		
	Configure the security settings	14		
	Configure the control options	16		
	Select the energy saving option	17		
6	Automatically install the channels	18		
7	Manually install the channels	19		
	Step 1: Select a programme	19		
	Step 2: Select the type of input	19		
	Step 3: Select the system	19		
	Step 4: Select the frequency	19		
	Step 5: Customise the TV channels	19		
	Step 6: Select a ring of channels	20		
8	Clone data and upgrade software	21		
	Clone data	21		
	Download software	21		
9	Healthcare	23		
10	Connect devices	24		
	Back connectors	24		
	Side connectors	25		
	Use a Conditional Access Module	26		
	Use a Kensington lock	26		
11	Product information	27		
	Supported display resolutions	27		
	Multimedia	27		
	Tuner/Reception/Transmission	27		
	Power	27		
	Power	27		
12	Troubleshooting	28		
	TV power on/ off issues	28		
	No access to PBS setup menu	28		
	Picture issues	28		
	Sound issues	28		
	Communication issues	29		
	Guest RC does not work	29		
	Other issues	29		
	Contact us	29		
13	Index	30		

1 Notice

2009 © Koninklijke Philips Electronics N.V. All rights reserved.

Specifications are subject to change without notice. Trademarks are the property of Koninklijke Philips Electronics N.V. or their respective owners. Philips reserves the right to change products at any time without being obliged to adjust earlier supplies accordingly. The material in this manual is believed adequate for the intended use of the system. If the product, or its individual modules or procedures, are used for purposes other than those specified herein, confirmation of their validity and suitability must be obtained. Philips warrants that the material itself does not infringe any United States patents. No further warranty is expressed or implied.

Warranty

- Risk of injury, damage to TV or void of warranty! Never attempt to repair the TV yourself.
- Use the TV and accessories only as intended by the manufacturer.
- The caution sign printed on the back of the TV indicates risk of electric shock. Never remove the TV cover. Always contact Philips Customer Support for service or repairs.



- Any operation expressly prohibited in this manual, or any adjustments and assembly procedures not recommended or authorised in this manual shall void the warranty.

Pixel characteristics

This LCD product has a high number of colour pixels. Although it has effective pixels of 99.999% or more, black dots or

bright points of light (red, green or blue) may appear constantly on the screen. This is a structural property of the display (within common industry standards) and is not a malfunction.

Open source software

This television contains open source software. Philips BU Hospitality hereby offers to deliver or make available, upon request, for a charge no more than the cost of physically performing source distribution, a complete machine-readable copy of the corresponding source code on a medium customarily used for software interchange.

To obtain the source code, write to:
Philips Singapore Pte Ltd.
Philips BU Hospitality
Software Development Manager
620A Lorong 1, Toa Payoh
Singapore 319762

This offer is valid for three years after the date of purchase of this product.

Compliance with EMF

Koninklijke Philips Electronics N.V. manufactures and sells many products targeted at consumers which, like any electronic apparatus, in general have the ability to emit and receive electromagnetic signals.

One of Philips' leading Business Principles is to take all necessary health and safety measures for our products, to comply with all applicable legal requirements and to stay well within the EMF standards applicable at the time of producing the products.

Philips is committed to develop, produce and market products that cause no adverse health effects. Philips confirms that if its products are handled properly for their intended use, they are safe to use according to scientific evidence available today.

Philips plays an active role in the development of international EMF and safety standards, enabling Philips

to anticipate further developments in standardisation for early integration in its products.

Mains fuse (UK only)

This TV is fitted with an approved moulded plug. Should it become necessary to replace the mains fuse, this must be replaced with a fuse of the same value as indicated on the plug (example 10A).

- 1** Remove fuse cover and fuse.
- 2** The replacement fuse must comply with BS 1362 and have the ASTA approval mark. If the fuse is lost, contact your dealer in order to verify the correct type.
- 3** Refit the fuse cover.

In order to maintain conformity to the EMC directive, the mains plug on this product must not be detached from the mains cord cable.

Copyright



VESA, FDMI and the VESA Mounting Compliant logo are trademarks of the Video Electronics Standards Association.

® Kensington and Micro Saver are registered US trademarks of ACCO World Corporation with issued registrations and pending applications in other countries throughout the world.

All other registered and unregistered trademarks are the property of their respective owners.

2 Important

Read and understand all instructions before you use your TV. If damage is caused by failure to follow instructions, the warranty does not apply.

Safety

- Risk of electric shock or fire!
 - Never expose the TV to rain or water. Never place liquid containers, such as vases, near the TV. If liquids are spilt on or into the TV, disconnect the TV from the power outlet immediately. Contact Philips Consumer Care to have the TV checked before use.
 - Never place the TV, remote control or batteries near naked flames or other heat sources, including direct sunlight.
To prevent the spread of fire, keep candles or other flames away from the TV, remote control and batteries at all times.



- Never insert objects into the ventilation slots or other openings on the TV.
 - When the TV is swivelled ensure that no strain is exerted on the power cord. Strain on the power cord can loosen connections and cause arcing.
 - Risk of short circuit or fire!
 - Never expose the remote control or batteries to rain, water or excessive heat.
- Avoid force coming onto power plugs. Loose power plugs can cause arcing or fire.
 - Risk of injury or damage to the TV!
 - Two people are required to lift and carry a TV that weighs more than 25 kg.
 - When stand mounting the TV, use only the supplied stand. Secure the stand to the TV tightly. Place the TV on a flat, level surface that can support the combined weight of the TV and the stand.
 - When wall mounting the TV, use only a wall mount that can support the weight of the TV. Secure the wall mount to a wall that can support the combined weight of the TV and wall mount. Koninklijke Philips Electronics N.V. bears no responsibility for improper wall mounting that result in accident, injury or damage.
 - Risk of injury to children! Follow these precautions to prevent the TV from toppling over and causing injury to children:
 - Never place the TV on a surface covered by a cloth or other material that can be pulled away.
 - Ensure that no part of the TV hangs over the edge of the surface.
 - Never place the TV on tall furniture (such as a bookcase) without anchoring both the furniture and TV to the wall or a suitable support.
 - Educate children about the dangers of climbing on furniture to reach the TV.
 - Risk of overheating! Never install the TV in a confined space. Always leave a space of at least 4 inches or 10 cm around the TV for ventilation. Ensure curtains or other objects never cover the ventilation slots on the TV.
 - Risk of damage to the TV! Before you connect the TV to the power outlet, ensure that the power voltage matches

the value printed on the back of the TV. Never connect the TV to the power outlet if the voltage is different.

- Risk of injury, fire or power cord damage! Never place the TV or any objects on the power cord.
- To disconnect the TV power cord easily from the power outlet, ensure that you have full access to the power cord at all times.
- When you disconnect the power cord, always pull the plug, never the cable.
- Disconnect the TV from the power outlet and antenna before lightning storms. During lightning storms, never touch any part of the TV, power cord or antenna cable.
- Risk of hearing damage! Avoid using earphones or headphones at high volumes or for prolonged periods of time.
- If the TV is transported in temperatures below 5°C, unpack the TV and wait until the TV temperature matches room temperature before connecting the TV to the power outlet.

Screen care

- Avoid stationary images as much as possible. Stationary images are images that remain on-screen for extended periods of time. Examples include: on-screen menus, black bars and time displays. If you must use stationary images, reduce screen contrast and brightness to avoid screen damage.
- Unplug the TV before cleaning.
- Clean the TV and frame with a soft, damp cloth. Never use substances such as alcohol, chemicals or household cleaners on the TV.
- Risk of damage to the TV screen! Never touch, push, rub or strike the screen with any object.
- To avoid deformations and colour fading, wipe off water drops as soon as possible.

Disposal of your old product and batteries



Your product is designed and manufactured with high quality materials and components, which can be recycled and reused.



When this crossed-out wheeled bin symbol is attached to a product it means that the product is covered by the European Directive 2002/96/EC. Please inform yourself about the local separate collection system for electrical and electronic products.

Please act according to your local rules and do not dispose of your old products with your normal household waste.

Correct disposal of your old product helps to prevent potential negative consequences for the environment and human health.



Your product contains batteries covered by the European Directive 2006/66/EC, which cannot be disposed of with normal household waste.

Please inform yourself about the local rules on separate collection of batteries because correct disposal helps to prevent negative consequences for the environment and human health.

3 TV overview

This section gives you an overview of commonly used TV controls and functions and the Guest Menu.

Side controls

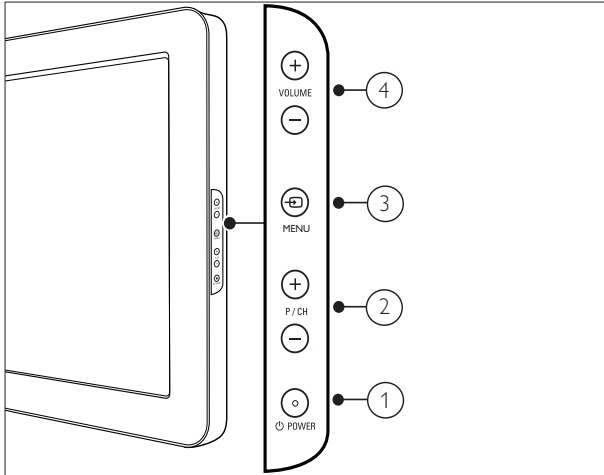

- ① **POWER** : Switches the product on or off. The product is not powered off completely unless it is physically unplugged.
- ② **P/CH +/-**: Switches to the next or previous channel.
- ③ **MENU**: Accesses the home menu.
- ④ **VOLUME +/-**: Increases or decreases volume.

Guest menu

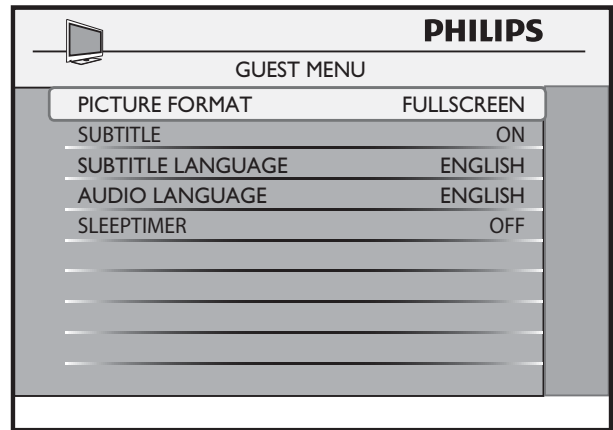

Access the guest menu with the PBS setup remote control

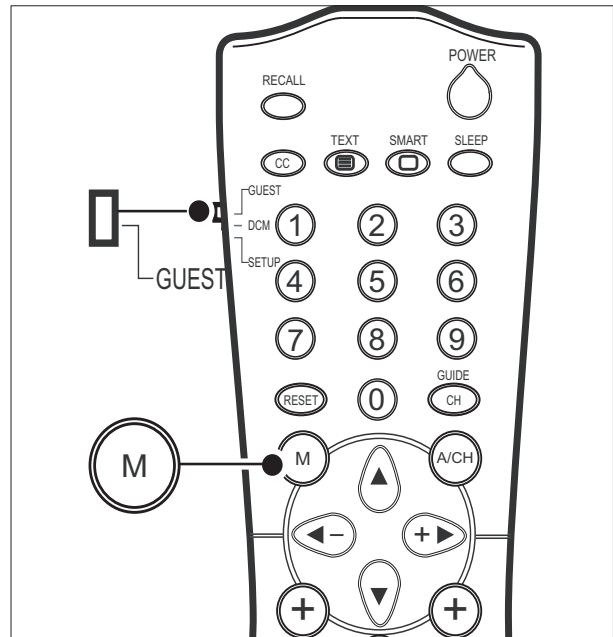

- 1 Switch on the TV and select a TV channel.
- 2 Set the switch at the side of the remote control to **GUEST**.
- 3 Press **M** to display the guest menu.
↳ The guest menu is displayed.

Access the guest menu with the guest remote control

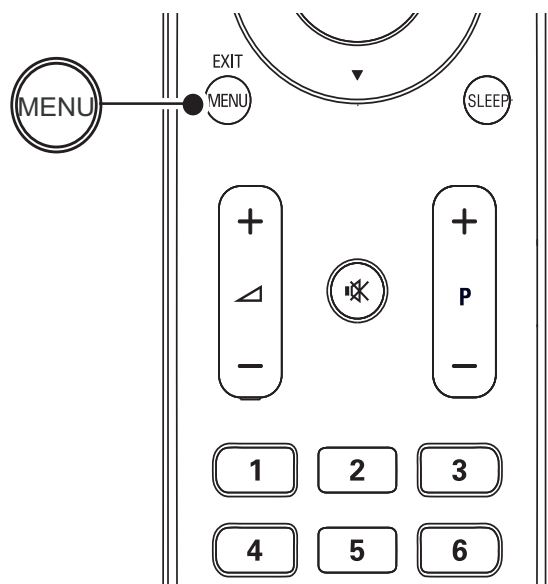

- 1 Switch on the TV and select a TV channel.
- 2 Press **MENU** to display the guest menu.
↳ The guest menu is displayed.

4 Access and use the setup menu

On-screen menus help you setup and install channels on the TV, change settings, and access different features. This section describes how to access the menus and configure the TVs.

When the security level is **[STANDARD]**, you can access the PBS setup menu with the PBS setup remote control or the guest remote control.

When the security level is **[HIGH]**, you must use the PBS setup remote control to access the PBS setup menu.

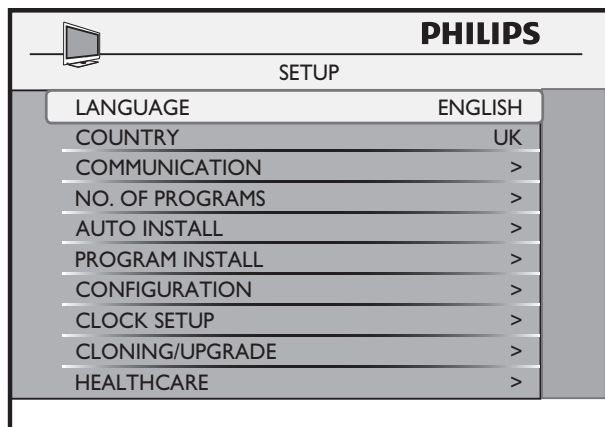

Access the setup menu with the PBS setup remote control

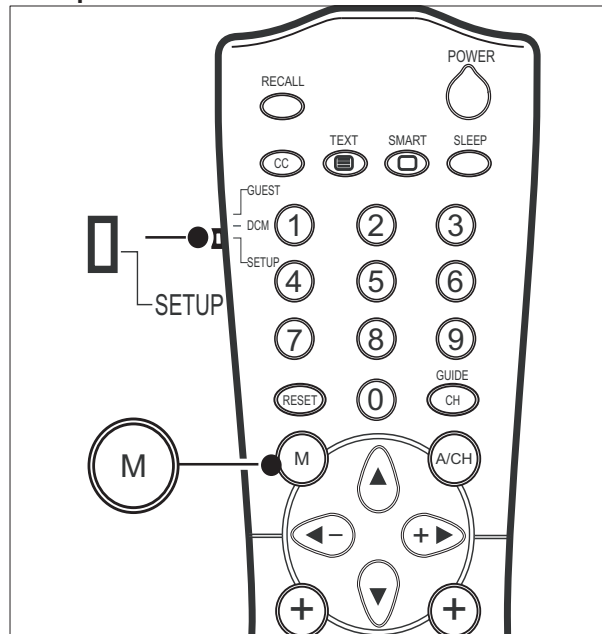

- 1 Switch on the TV and select a TV channel.
- 2 Set the switch at the side of the remote control to **SETUP**.
- 3 Press **M** to display the setup menu.
↳ The setup menu is displayed.

Access the setup menu with the guest remote control

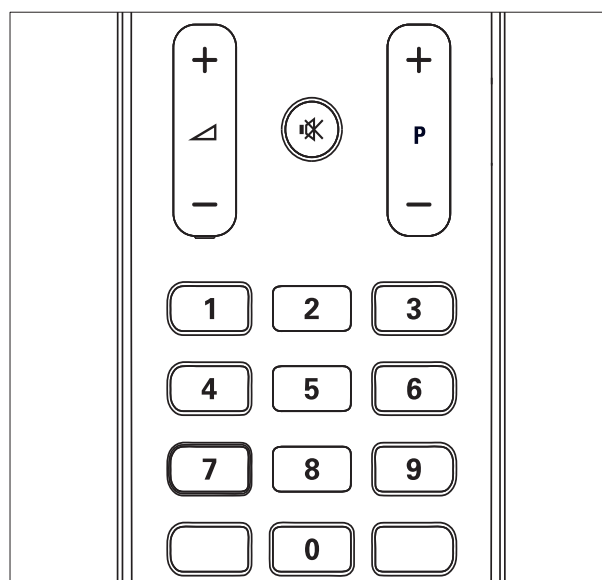

- 1 Switch on the TV and select a TV channel.
- 2 Press '319753' followed by **M** (Mute) within 10 seconds.
↳ The setup menu is displayed.

To navigate the setup menu,

- Press **▲▼** on the remote control to select a menu.
- Press **▶** to configure or modify the settings of the selected function.
- Press **M** on the PBS setup remote control or **MENU** on the guest remote control to return to the previous menu.

Select a language

You can choose a language for the on-screen display on your TV.

- 1 Enter the setup menu.
- 2 Press **▶** to select a language.
↳ The setup menu is displayed in the selected language.

Note

- You can choose **[ENGLISH]**, **[FRANCAIS]**, **[DEUTSCH]**, or **[ITALIANO]** as your preferred language.

Select the country

Select the country where you are installing the TV.

- 1 Enter the setup menu.
- 2 Press **▲▼◀▶** to select the country.

Set the type of communication

You must set the correct communication protocol to work with an external system.

- 1 Enter the setup menu.
- 2 Press **▼** to select **[COMMUNICATION]**.

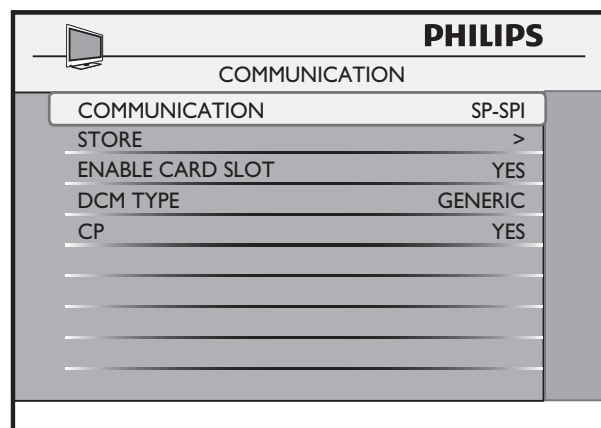

- 3 Press **▲▼◀▶** to select the type of communication:
 - **[COMMUNICATION]**: Select one of the following:
 - **[SP-SPI]**, **[SP-I2C]**, **[HM-LINK]** or **[SERIAL XPRESS]**: Sets the communication protocol between the TV and an external device connected to the TV, such as a set-top box.
 - **[SMART RC]**: Accesses PayTV channels using remote control.
 - **[OFF]**: Allows no communication.
 - **[STORE]**: Stores the settings. Select this option after making all the selections.
 - **[ENABLE CARD SLOT]**: Select **[YES]** to enable the smart card slot.
 - **[DCM TYPE]**: Select **[GENERIC]** if you use **[SP-SPI]** or **[SP-I2C]** protocol. Select **[NO SOURCE SWITCH]** if the set-top box requires no switching.
 - **[CP]**: Select **[YES]** to control the panel in system mode.

Set the number of channels

Set the number of channels for different kinds of programmes. The total number of channels for all programmes is 250.

- 1 Enter the setup menu.

2 Press ▼ to select [NO. OF PROGRAMS].

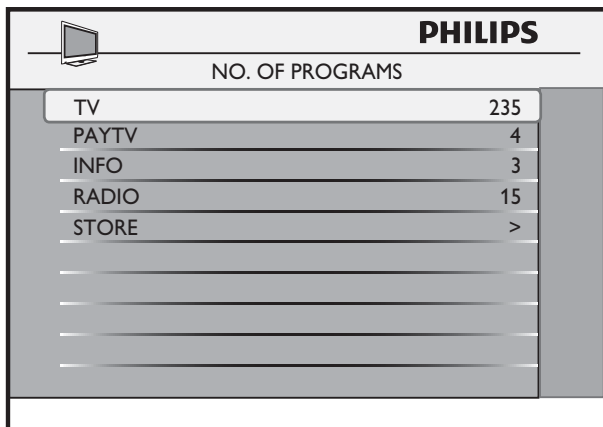

PHILIPS	
NO. OF PROGRAMS	
TV	235
PAYTV	4
INFO	3
RADIO	15
STORE	>

3 Press ▲▼◀▶ to select one of the following programmes, then press 0-9 (Numeric buttons) to set the number of channels for the programme:

- [TV]: Sets the number of TV channels.
- [PAYTV]: Sets the number of Pay TV channels.
- [INFO]: Sets the number of information channels.
- [RADIO]: Sets the number of radio channels.

4 Press ▲▼◀▶ to select [STORE].

Auto install, program install, and configuration

For detailed information on automatic install, program install and configuration, read the later sections of the user manual.

Cloning/upgrade and healthcare

For detailed information on cloning/upgrade and healthcare, read the later sections of the user manual.

Set the clock

This section describes how to set the time and display the clock .

1 Enter the setup menu.

2 Press ▲▼◀▶ to select [CLOCK SETUP].

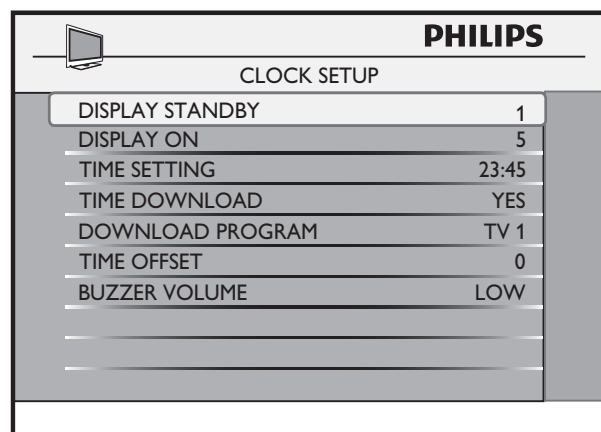

PHILIPS	
CLOCK SETUP	
DISPLAY STANDBY	1
DISPLAY ON	5
TIME SETTING	23:45
TIME DOWNLOAD	YES
DOWNLOAD PROGRAM	TV 1
TIME OFFSET	0
BUZZER VOLUME	LOW

3 Press ▶ to configure one of the following:

- [DISPLAY STANDBY]: Sets the brightness of the clock display, when the TV is in standby mode. Select [OFF] to turn off the display.
- [DISPLAY ON]: Sets the brightness of the clock display, when the TV is switched on. Select [OFF] to turn off the display.
- [TIME SETTING]: Press 0-9 (Numeric buttons) to set the clock.
- [TIME DOWNLOAD]: Select [YES] to download the time from the TV programme or select [NO] to set the clock manually.
- [DOWNLOAD PROGRAM]: Selects the channel to download the time from. Appears only when you select [TIME DOWNLOAD] > [YES]. Set the download program as the startup program to achieve a fast startup time.
- [TIME OFFSET]: Sets the time offset.
- [BUZZER VOLUME]: Sets the volume of the alarm buzzer. Select [OFF] to switch off the buzzer.

5 Configuration of advanced settings

This section describes how to configure the advanced settings for the TV, such as the switch-on settings, picture and sound settings, energy saving, and control settings.

- 1 Enter the setup menu.
- 2 Press ▲▼ to select **[CONFIGURATION]**.

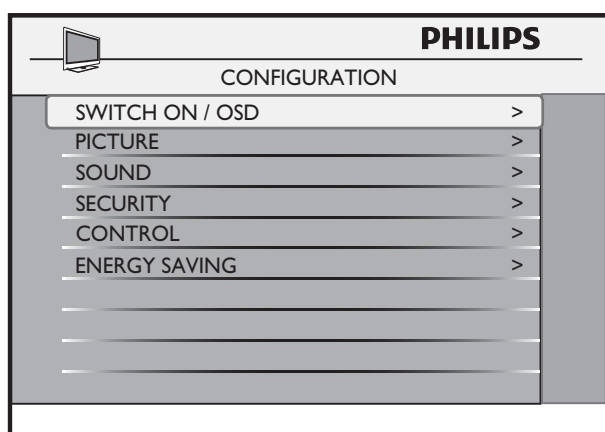

- 3 Press ▲▼◀▶ to configure the settings:
 - **[SWITCH ON / OSD]**: Sets the default value for settings such as volume, channel, picture format, and power mode. These values are used when the TV is switched on (see 'Configure the switch-on settings' on page 11).
 - **[PICTURE]**: Configures picture settings such as brightness, colour, and sharpness (see 'Configure the picture settings' on page 14).
 - **[SOUND]**: Configures sound settings such as bass, balance, and AVL (see 'Configure the sound settings' on page 14).
 - **[SECURITY]**: Sets the level of security (see 'Configure the security settings' on page 14).

- **[CONTROL]**: Configures some settings (see 'Configure the control options' on page 16).
- **[ENERGY SAVING]**: Sets the energy saving mode (see 'Select the energy saving option' on page 17).

Configure the switch-on settings

- 1 Enter the setup menu.
- 2 Press ▲▼ to select **[CONFIGURATION]**>**[SWITCH ON / OSD]**.

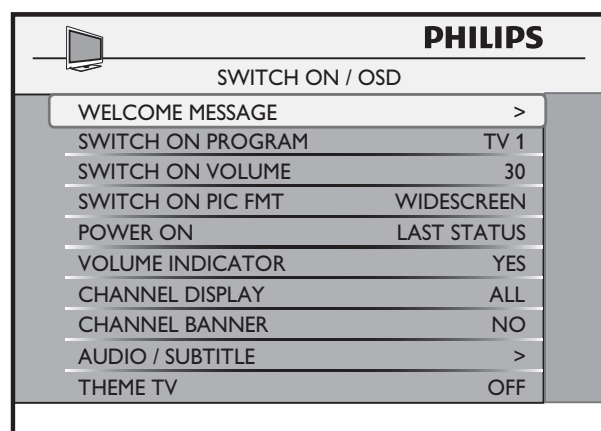

- 3 Press ▶ to select one of the available options:
 - **[WELCOME MESSAGE]**: Sets or clears a welcome message (see 'Set the welcome message' on page 12).
 - **[SWITCH ON PROGRAM]**: Sets a channel that is displayed when the TV is turned on (see 'Preset the switch-on channel' on page 12).
 - **[SWITCH ON VOLUME]**: Specifies the volume at which the TV is turned on (see 'Preset the switch-on volume' on page 12).
 - **[SWITCH ON PIC FMT]**: Sets the picture format that is used to display when the TV is turned on (see 'Preset the picture format' on page 12).

- **[POWER ON]**: Sets the power mode that is used when the TV is turned on after a prolonged period of no activity (see 'Preset the switch-on power mode' on page 12).
- **[VOLUME INDICATOR]**: Sets the display of the volume indicator (see 'Enable or disable the volume indicator' on page 13).
- **[CHANNEL DISPLAY]**: Sets the display of the channel number and the label on the screen (see 'Set the channel display' on page 13).
- **[CHANNEL BANNER]**: Displays the channel banner on the top of the screen (see 'Display the channel banner' on page 13).
- **[AUDIO / SUBTITLE]**: Sets the preferred language for audio and subtitles (see 'Select the preferred audio and subtitle language' on page 13).
- **[THEME TV]**: Displays the ring icons (also known as the theme) (see 'Set ThemeTV' on page 13).

Set the welcome message

- 1 Enter the setup menu.
- 2 Press ▲▼ to select **[CONFIGURATION]** >**[SWITCH ON / OSD]**>**[WELCOME MESSAGE]**.
- 3 Press ▲▼◀▶ to select one of the following options:
 - **[DISPLAY]**: Select **[YES]** to display the welcome message. Select **[NO]** to prevent display of the welcome message.
 - **[LINE 1]**: The first line of the welcome message. Press ◀▶ to select a character slot and ▲▼ to select an alphanumeric character.
 - **[LINE 2]**: The second line of the welcome message. Press ◀▶ to select a character slot and ▲▼ to select an alphanumeric character.

- **[CLEAR]**: Clears the welcome message.

Note

- You can have a maximum of 20 alphanumeric characters in each line of your welcome message.

Preset the switch-on channel

- 1 Enter the setup menu.
- 2 Press ▲▼ to select **[CONFIGURATION]** >**[SWITCH ON / OSD]** >**[SWITCH ON PROGRAM]**.
- 3 Press ▶ to select the type and press **0-9** (**Numeric buttons**) to select the channel that is displayed when the TV is turned on.

Preset the switch-on volume

- 1 Enter the setup menu.
- 2 Press ▲▼ to select **[CONFIGURATION]** >**[SWITCH ON / OSD]** > **[SWITCH ON VOLUME]**.
- 3 Press ▶ to pre-define the volume at which the TV is turned on.

Preset the picture format

- 1 Enter the setup menu.
- 2 Press ▲▼ to select **[CONFIGURATION]** >**[SWITCH ON / OSD]** >**[SWITCH ON PIC FMT]**.
- 3 Press ▶ to select one of the available picture formats:
 - ↳ The selected picture format is used to display pictures when the TV is turned on.

Preset the switch-on power mode

- 1 Enter the setup menu.

- 2 Press ▲▼ to select **[CONFIGURATION]** > **[SWITCH ON / OSD]** > **[POWER ON]**.
- 3 Press ► to select the power mode that is used when the TV is turned on from the AC mains power outlet:
 - **[LAST STATUS]**: Turns on the TV in the last used power mode.
 - **[ON]**: Turns on the TV. The Ⓟ button on the TV and the guest remote control are enabled.
 - **[STANDBY]**: Turns on the TV in standby mode.
 - **[FORCED ON]**: Turns on the TV. The Ⓟ button on the TV and the guest remote control are disabled.

Enable or disable the volume indicator

- 1 Enter the setup menu.
- 2 Press ▲▼ to select **[CONFIGURATION]** > **[SWITCH ON / OSD]** > **[VOLUME INDICATOR]**.
- 3 Press ► to select one of the following:
 - **[YES]**: Displays the volume indicator.
 - **[NO]**: Prevents display of the volume indicator.

Set the channel display

- 1 Enter the setup menu.
- 2 Press ▲▼ to select **[CONFIGURATION]** > **[SWITCH ON / OSD]** > **[CHANNEL DISPLAY]**.
- 3 Press ► to set the format of the channel display:
 - **[NUMBER]**: Displays the channel number on the screen.
 - **[LABEL]**: Displays the channel name on the screen.
 - **[ALL]**: Displays both the channel number and the name on the screen.
 - **[NONE]**: Prevents display of channel information.

Display the channel banner

- 1 Enter the setup menu.
- 2 Press ▲▼ to select **[CONFIGURATION]** > **[SWITCH ON / OSD]** > **[CHANNEL BANNER]**.
- 3 Press ► to select one of the following:
 - **[YES]**: Displays the channel banner on the screen.
 - **[NO]**: Prevents display of the channel banner on the screen.

Select the preferred audio and subtitle language

- 1 Enter the setup menu.
- 2 Press ▲▼◀▶ to select **[CONFIGURATION]** > **[SWITCH ON / OSD]** > **[AUDIO / SUBTITLE]**.
- 3 Press ▲▼◀▶ to set the audio and subtitle language:
 - **[AUDIO LANGUAGE]**: Sets the audio language.
 - **[SUBTITLE LANGUAGE]**: Sets the subtitle language.



Note

- The default language will be selected each time the TV is tuned to a new channel.
- The preferred language selected in the Guest Menu will override the language selected in the Setup menu until the TV restarts.

Set ThemeTV

- 1 Enter the setup menu.
- 2 Press ▲▼◀▶ to select **[CONFIGURATION]** > **[SWITCH ON / OSD]** > **[THEME TV]**.
- 3 Press ◀▶ to select one of the following:
 - **[ON]**: Displays ThemeTV when you press **OK**.
 - **[OFF]**: Prevents the display of ThemeTV.

- **[DISPLAY ON STARTUP]:** Displays ThemeTV on startup and when you press **OK**.

Configure the picture settings

- 1 Enter the setup menu.
- 2 Press **▲▼** to select **[CONFIGURATION]** > **[PICTURE]**.
- 3 Press **▲▼◀▶** to select one of the following options:
 - **[BRIGHTNESS]:** Adjusts the light intensity or darkness.
 - **[COLOUR]:** Adjusts the colour.
 - **[CONTRAST]:** Adjusts the contrast.
 - **[SHARPNESS]:** Adjusts the image sharpness.
 - **[TINT]:** Adjusts the colour balance in an image.
 - **[ACTIVE CONTROL]:** Select **[YES]** to fine-tune the received signals according to the lighting conditions of the room. Select **[NO]** to retain other setting.

Configure the sound settings

- 1 Enter the setup menu.
- 2 Press **▲▼** to select **[CONFIGURATION]** > **[SOUND]**.
- 3 Press **▲▼◀▶** to select one of the following options:
 - **[EQUALIZER]:** Adjusts individual sound frequencies.
 - **[BALANCE]:** Adjusts the balance of the speakers.
 - **[MIN VOLUME]:** Sets the minimum volume.
 - **[MAX VOLUME]:** Sets the maximum volume.
 - **[AVL]:** Select **[ON]** to reduce the fluctuations in volume when the

commercials are aired or when you switch channels.

- **[SMART SETTING RC]:** Select **[SMART SETTING]** to select a smart sound setting or select **[SPLIT AUDIO]** to select the sound from a different audio source.
- **[AUDIO SOURCE]:** Selects the audio source from a particular connection.

Configure the security settings

- 1 Enter the setup menu.
- 2 Press **▲▼** to select **[CONFIGURATION]** > **[SECURITY]**.

PHILIPS	
SECURITY	
SECURITY	STANDARD
KEYBOARD LOCK	ALL
REMOTE CONTROL LOCK	YES
AUDIO/VIDEO OUT	TUNER
USB BREAK-IN	YES
EPG	YES
TXT/MHEG	ALL
VTRACK	ON
SCRAMBLING	>

- 3 Press **▲▼◀▶** to select one of the following:
 - **[SECURITY]:** Specifies the security level (see 'Select the security level' on page 15).
 - **[KEYBOARD LOCK]:** Enables or disables local TV controls (see 'Enable or disable the TV controls' on page 15).
 - **[REMOTE CONTROL LOCK]:** Enables or disables the remote control keys (see 'Enable or disable the remote control' on page 15).
 - **[AUDIO/VIDEO OUT]:** Disables audio and video out signal (see

- 'Enable or disable video and audio output to a recording device' on page 15).
- **[USB BREAK-IN]:** Enables or disables the auto detection of USB devices. Select **[YES]** to automatically switch to the USB root menu when a USB device is plugged in. Select **[NO]** to disable automatic switchover.
 - **[EPG]:** Select **[YES]** to enable the EPG function and **[NO]** to disable EPG.
 - **[TXT/MHEG]:** Select **[TXT]** to enable teletext only. Select **[ALL]** to select both teletext and MHEG or select **[NO]** to disable teletext and MHEG.
 - **[VTRACK]:** Select **[YES]** to enable watermark in the PayTV channels. Select **[NO]** to disable watermark in the PayTV channels.
 - **[SCRAMBLING]:** Loads the key required to descramble Vsecure channels. Select **[LOAD KEY TO USB]** to load the Public key to USB and **[LOAD KEY TO TV]** to load the descramble key to the television via USB.

Select the security level

- 1 Enter the setup menu.
- 2 Press **▲▼** to select **[CONFIGURATION] > [SECURITY] > [SECURITY]**.
- 3 Press **▶** to select one of the following settings:
 - **[STANDARD]:** Accesses the setup menu using the PBS setup remote control or the guest remote control (see 'Access the setup menu with the guest remote control' on page 8).
 - **[HIGH]:** Accesses the setup menu using the PBS remote control only (see 'Access the setup menu with

the PBS setup remote control' on page 8).

Enable or disable the TV controls

- 1 Enter the setup menu.
- 2 Press **▲▼** to select **[CONFIGURATION] > [SECURITY] > [KEYBOARD LOCK]**.
- 3 Press **▶** to select one of the following settings:
 - **[ALL]:** Locks all control keys on the TV including the **Ⓞ** key.
 - **[YES]:** Locks all control keys on the TV excluding the **Ⓞ** key.
 - **[NO]:** Unlocks all control keys on the TV.

Enable or disable the remote control

- 1 Enter the setup menu.
- 2 Press **▲▼** to select **[CONFIGURATION] > [SECURITY] > [REMOTE CONTROL LOCK]**.
- 3 Press **▶** to select one of the following settings:
 - **[YES]:** Disables all standard remote control functions.
 - **[NO]:** Enables all standard remote control functions.

Note

- The PBS setup remote control cannot be locked.
- You can access the PBS Setup Menu even if you lock the remote control.

Enable or disable video and audio output to a recording device

- 1 Enter the setup menu.
- 2 Press **▲▼◀▶** to select **[CONFIGURATION] > [SECURITY] > [AUDIO/VIDEO OUT]**. Select one of the following options:

- **[TUNER]**: Sends the audio/ video output from the tuner to another TV that is connected to your TV.
- **[MONITOR]**: Sends the audio/ video output from a monitor to another TV that is connected to your TV. This is not available when input signal is protected with Vsecure, HDCP and Macrovision.
- **[MUTE]**: Disables the audio/ video output from all sources.

Configure the control options

- 1 Enter the setup menu.
- 2 Press **▲▼** to select **[CONFIGURATION]** **>[CONTROL]**.

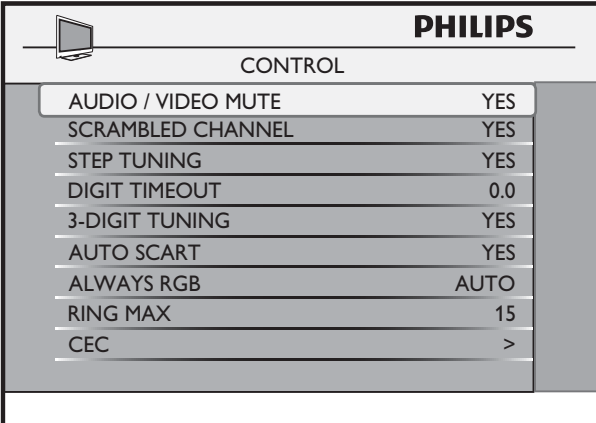

PHILIPS	
CONTROL	
AUDIO / VIDEO MUTE	YES
SCRAMBLED CHANNEL	YES
STEP TUNING	YES
DIGIT TIMEOUT	0.0
3-DIGIT TUNING	YES
AUTO SCART	YES
ALWAYS RGB	AUTO
RING MAX	15
CEC	>

- 3 Press **▲▼◀▶** to select one of the following options:
 - **[AUDIO / VIDEO MUTE]**: Select **[YES]** to mute the source audio and video.
 - **[SCRAMBLED CHANNEL]**: Select **[YES]** to install the scrambled channels during automatic installation or **[NO]** to skip the scrambled channels during automatic installation.
 - **[STEP TUNING]**: Select **[YES]** to enable tuning of single digit channels

- or select **[NO]** to enable the tuning of double digit channels.
- **[DIGIT TIMEOUT]**: Set a time between 1 - 9.9 seconds for a channel to switch to another channel. Do not select **[DIGIT TIMEOUT]** to be too short if you want to enable the tuning of two digit or three digit channel numbers.
- **[3-DIGIT TUNING]**: Select **[YES]** to enable the tuning of three digit channels. Select **[NO]** to enable the tuning of only two digit channels.
- **[AUTO SCART]**: Enables or disables the automatic detection of SCART signal (see 'Automatic detection of SCART signal' on page 16).
- **[ALWAYS RGB]**: Enables or disables RGB insertion (see 'Insert RGB' on page 17).
- **[RING MAX]**: Sets the maximum number of rings.
- **[CEC]**: Enables or disables HDMI CEC features such as one touch play, system standby and RC passthrough.

Automatic detection of SCART signal

- 1 Enter the setup menu.
- 2 Press **▲▼** to select **[CONFIGURATION]** **>[CONTROL]** **>[AUTO SCART]**.
- 3 Press **▲▼◀▶** to select one of the following options:
 - **[AV1]**: Switches to AV1 automatically when a SCART cable is connected to the AV1 (**EXT 1**) connector.
 - **[AV2]**: Switches to AV2 automatically when a SCART cable is connected to the AV2 (**EXT 2**) connector.
 - **[ALL]**: Switches to the correct source when a SCART signal is detected on any connector.
 - **[POWER SCART]**: Wakes up the TV automatically from standby when a SCART signal is detected. Switches

automatically to standby when the SCART signal is removed.

- **[NO]**: Disables automatic detection of SCART signal.

Insert RGB

- 1 Enter the setup menu.
- 2 Press **▲▼** to select **[CONFIGURATION]** > **[CONTROL]** > **[ALWAYS RGB]**.
- 3 Press **▲▼◀▶** to select one of the following options:
 - **[AV1]**: Allows RGB insertion in AV1 (**EXT 1**) and other sources.
 - **[AUTO]**: Allows RGB insertion in any source when **[COMMUNICATION]** in the setup menu is selected as **[SP-SPI]** or **[SP-I2C]**. Otherwise, allows RGB insertion in AV1 (**EXT 1**) only.
 - **[NO RGB]**: Prevents RGB insertion in any source.
 - **[NO]**: Allows RGB insertion in AV1 (**EXT 1**) only.

- 3 Press **▲▼◀▶** to set the energy saving options:
 - **[LOW POWER STANDBY]**: Defines the power consumption for the TV when it is in standby mode:
 - **[GREEN]**: Achieves minimum power consumption. **[COMMUNICATION]** is disabled in this mode.
 - **[FAST]**: Achieves fast power up.
 - **[CLOCK]**: Achieves low power consumption when the clock is displayed and **[COMMUNICATION]** is enabled.
 - **[ESP]**: Set a time from 1 - 99 hours to enable ESP. If the TV does not receive any command for this time period, it enters the standby mode to save energy. Select **[OFF]** to disable ESP.
 - **[SMART POWER]**: Selects a power saving mode. Select **[HIGH]** for maximum power savings. Select **[MEDIUM]** and **[LOW]** for less power savings. Select **[OFF]** to disable the power saving mode.

Select the energy saving option

- 1 Enter the setup menu.
- 2 Press **▲▼** to select **[CONFIGURATION]** > **[ENERGY SAVING]**.

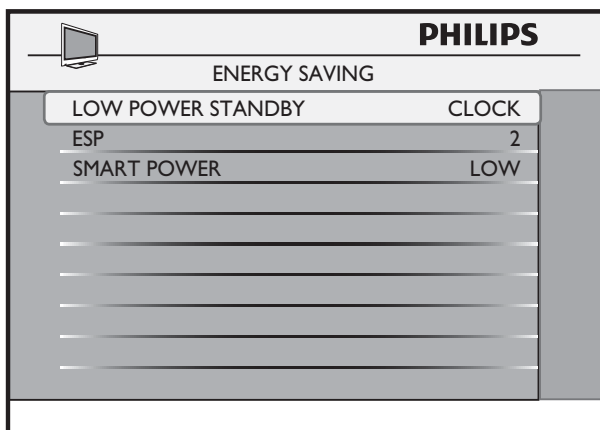

6 Automatically install the channels

Note

- The complete installation takes a few minutes or up to 2 hours if DVB-C Full Scan is enabled. When complete, the first tuned channel appears on the TV.

This section describes how to install the TV channels automatically.

- 1 Enter the setup menu.
- 2 Press **▲▼◀▶** to select **[AUTO INSTALL]**.

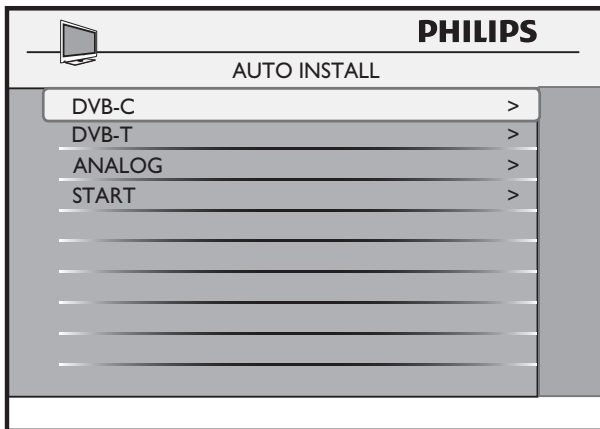

- 3 Press **▲▼◀▶** to select one of the following:
 - **[DVB-C]**: Installs DVB-C channels. The **[FULL SCAN]** searches the whole frequency spectrum and takes approximately 2 hours. Filling in **[MODULATION]** type and **[SYMBOL RATE]** will speed up auto installation. **[QUICK SCAN]** takes a few minutes but it needs additional parameters such as **[NID]** and **[NETWORK FREQUENCY]**.
 - **[DVB-T]**: Installs DVB-T channels.
 - **[ANALOG]**: Installs analogue channels.
 - **[START]**: Starts the automatic installation of channels.

7 Manually install the channels

This section describes how to install the TV channels manually.

- 1 Enter the setup menu.
- 2 Press ▼ to select **[PROGRAM INSTALL]**.
- 3 Press ► to install the channels manually.

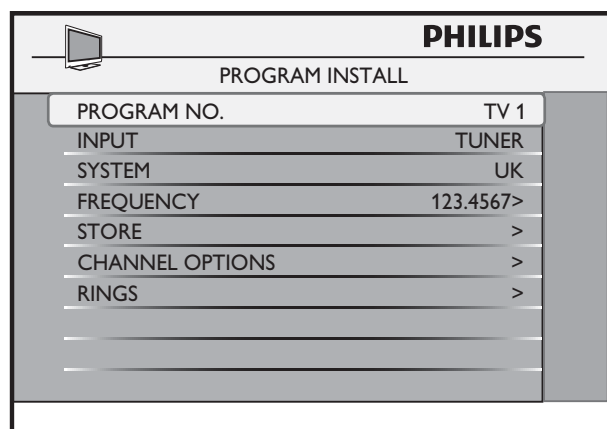

- 4 Press ▲▼ to select a setting.

Step 1: Select a programme

- 1 Enter the setup menu.
- 2 Press ▲▼◀▶ to select **[PROGRAM INSTALL]** > **[PROGRAM NO.]**.
- 3 Press ► to select the type of channel that you want to install: **[TV]**, **[PAYTV]**, **[INFO]**, or **[RADIO]**.
- 4 Press **0-9 (Numeric buttons)** to select a channel.

Step 2: Select the type of input

- 1 Enter the setup menu.
- 2 Press ▲▼◀▶ to select **[PROGRAM INSTALL]** > **[INPUT]**.

- 3 Press ► to select the input source of the selected programme.

Step 3: Select the system

- 1 Enter the setup menu.
- 2 Press ▲▼◀▶ to select **[PROGRAM INSTALL]** > **[SYSTEM]**.
- 3 Press ► to select the system.

Step 4: Select the frequency

- 1 Enter the setup menu.
- 2 Press ▲▼◀▶ to select **[PROGRAM INSTALL]** > **[FREQUENCY]**.
- 3 Press **0-9 (Numeric buttons)** to enter a frequency or press ► to start the search for a channel.
 - ↳ If the specified channel is not found, the system searches for the next available channel.

Step 5: Customise the TV channels

- 1 Enter the setup menu.
- 2 Press ▲▼◀▶ to select **[PROGRAM INSTALL]** > **[CHANNEL OPTIONS]**, then select one of the following:
 - **[LABEL]**: Labels a channel (see 'Label a channel' on page 20).
 - **[FINE TUNE]**: Fine tunes the channel.
 - **[TELETEXT LANGUAGE]**: Selects a teletext language.
 - **[MUTE]**: Mutes the audio or video in the channel (see 'Mute a channel' on page 20).
 - **[PROTECTION]**: Select **[YES]** to lock the channel or **[NO]** to unlock a locked channel.

3 Press ▲▼◀▶ to select [STORE].

 Note

- [CHANNEL OPTIONS] is available only when you select [PROGRAM INSTALL] > [INPUT] > [TUNER].

Label a channel

- 1 Enter the setup menu.
- 2 Press ▲▼◀▶ to select [PROGRAM INSTALL] > [CHANNEL OPTIONS] > [LABEL].

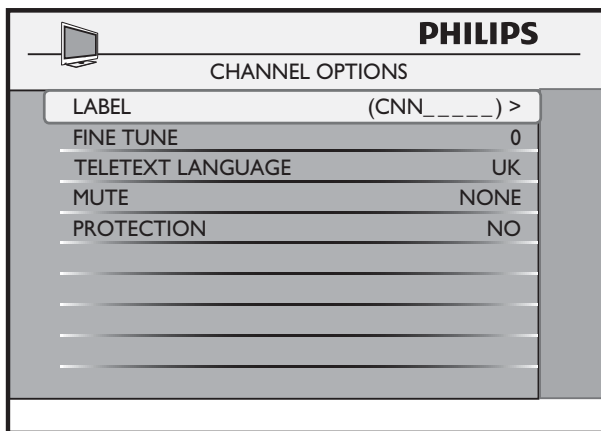

- 3 Press ◀▶ to select a slot to enter a character.
↳ A flashing red mark underlines the selected slot.
- 4 Press ▲▼ to select a character.
- 5 Repeat steps 3 and 4 until you finish naming the channel.
- 6 Press ▲▼◀▶ to select [STORE].

 Note

- The channel name can have a maximum of nine characters.

Mute a channel

- 1 Enter the setup menu.
- 2 Press ▲▼◀▶ to select [PROGRAM INSTALL] > [CHANNEL OPTIONS] > [MUTE].
- 3 Press ◀▶ to select one of the following:
 - [AUDIO]: Mutes the audio in the channel.
 - [VIDEO]: Mutes the the video in the channel.
 - [NONE]: Does not mute the sound from the audio or video source in the channel.
- 4 Press ▲▼◀▶ to select [STORE].

Step 6: Select a ring of channels

- 1 Enter the setup menu.
- 2 Select the channel that you want to include in a ring.
- 3 Press ▲▼◀▶ to select [PROGRAM INSTALL] > [RINGS].
- 4 Press ▲▼◀▶ to select the preferred ring of channels.
↳ A flashing red dash appears next to the selected list.
- 5 Press OK on the guest remote control to select or deselect a list.
↳ The selected list is marked by an "X".
- 6 Press M on the setup RC or MENU on the guest RC to return to the previous menu.
- 7 Press ▲▼◀▶ to select [PROGRAM INSTALL] > [STORE].

 Note

- Rings R13 - R15 are reserved for certain channels.

8 Clone data and upgrade software

This section describes how to clone the TV configuration data and download software.

- 1 Enter the setup menu.
- 2 Press ▲▼◀▶ to select **[CLONING/UPGRADE]**.

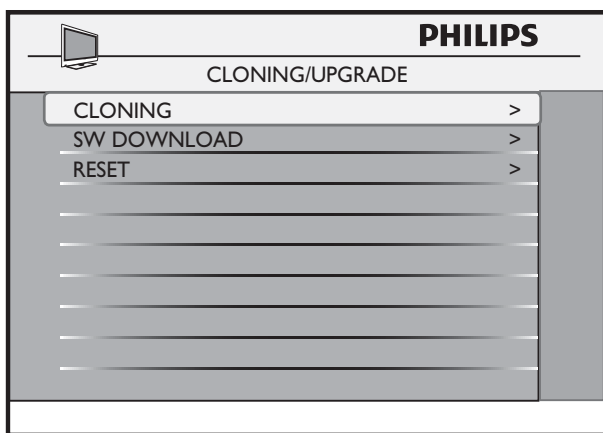

- 3 Press ▶ to select one of the following options:
 - **[CLONING]**: Clones data from a USB storage device to a TV or a TV to a USB storage device.
 - **[SW DOWNLOAD]**: Downloads software from a USB storage device or an RF channel.
 - **[RESET]**: Resets to setup menu default settings (including channels list).

Clone data

You can copy the configuration data from a TV to a USB storage device or vice versa. This enables the installer to bypass the PBS setup menu and configure multiple TVs by simply using the USB storage device.

- 1 Insert the USB storage device into the USB connector of your TV.
- 2 Enter the setup menu.
- 3 Press ▲▼◀▶ to select **[CLONING/UPGRADE]** > **[CLONING]**.
- 4 Press ▶ to select one of the following options:
 - **[OPTIONS]**: Selects the data to clone.
 - **[ALL]**: Clones all data. This option requires the longest time.
 - **[SETTINGS]**: Clones TV settings and channels list only. Select this option if you do not need to clone icons. It requires a shorter time.
 - **[THEMETV IMAGE]**: Clones Theme TV icons.
 - **[MOVIE BAR IMAGE]**: Clones Movie Bar icons.
 - **[USB TO TV]**: Clones the data from a USB storage device to a TV.
 - **[TV TO USB]**: Clones the data from a TV to a USB storage device.

Note

- Do not remove the USB storage device during cloning.
- All standard remote control functions and TV controls are disabled during cloning.

Tip

- Switch off the TV after cloning and restart it for the changes to take effect.

Download software

You can download software upgrades or TV settings from a USB storage device or an RF channel.

- 1 Enter the setup menu.
- 2 Press ▲▼◀▶ to select **[CLONING/UPGRADE]** > **[SW DOWNLOAD]**.

- 3** Press ► to set the source and type of the software download:
- **[SOURCE]:** Select **[USB]** or **[RF]** as the source of download.
 - **[SW TYPE]:** Select one of the following types of software for download:
 - **[SSB NVM]:** Downloads SSB NVM software.
 - **[SSB FIRMWARE]:** Downloads digital software such as MPEG 2 and MPEG 4.
 - **[8051 FIRMWARE]:** Downloads the TV startup data.
 - **[IBOARD NVM]:** Downloads the TV settings.
 - **[IBOARD FIRMWARE]:** Downloads iboard software.
 - **[ALL]:** Downloads all the software upgrades.
 - **[PROGRAM NO.]:** Selects the RF channel to download the software from. This is available only when you select RF as the source of download. Press **0-9** (**Numeric buttons**) to select the channel.
 - **[RF TO TV]:** Downloads the software from an RF channel to the TV. This is available only when you select RF as the source of download.
 - **[USB TO TV]:** Downloads the software from a USB storage device to the TV. This is available only when you select USB as the source of download. Executes also via the **F** button on the setup remote control.



Note

- Do not remove the USB storage device during cloning.
- All standard remote control functions and TV controls are disabled during cloning.

9 Healthcare

This section describes how to select some of the features that are used in the healthcare industry.

- 1 Enter the setup menu.
- 2 Press **▲▼◀▶** to select **[HEALTHCARE]**.

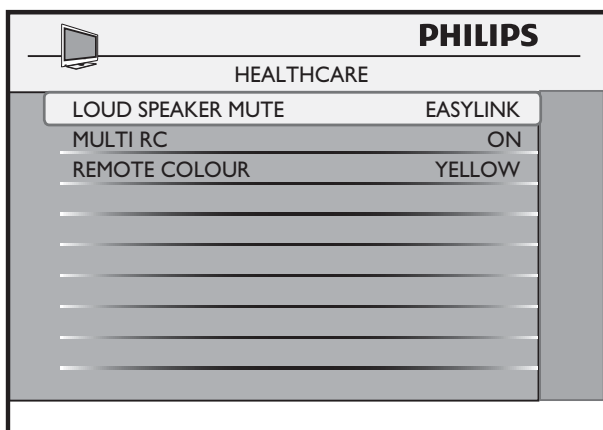

- 3 Press **▶** to select one of the following options:
 - **[LOUD SPEAKER MUTE]**: Select **[YES]** to mute the TV speakers or select **[NO]** to enable the TV speakers. Select **[EASYLINK]** to enable the speakers of the easylink compliant device connected to the TV.
 - **[MULTI RC]**: Enables or disables Multi RC. Select **[ON]** to enable Multi RC or select **[OFF]** to disable multi RC. Multi RC enables you to watch up to four TVs in a room without any interference from each other's remote controls. When Multi RC is enabled, each TV responds to a remote control that is set to the same colour that the TV is programmed to. Each of the remote controls must be programmed to one of the four colours - blue, yellow, green or red. Each TV must be separately programmed to

respond to a remote control of one of those colours.

- **[REMOTE COLOUR]**: Configures the TV to respond to the remote control of a particular colour.

10 Connect devices

This section describes how to connect various devices with different connectors and supplements examples provided in the Quick Start.

Note

- Different types of connectors may be used to connect a device to your TV, depending on availability and your needs. A comprehensive interactive guide to help you connect your product is available at www.connectivityguide.philips.com.

Back connectors

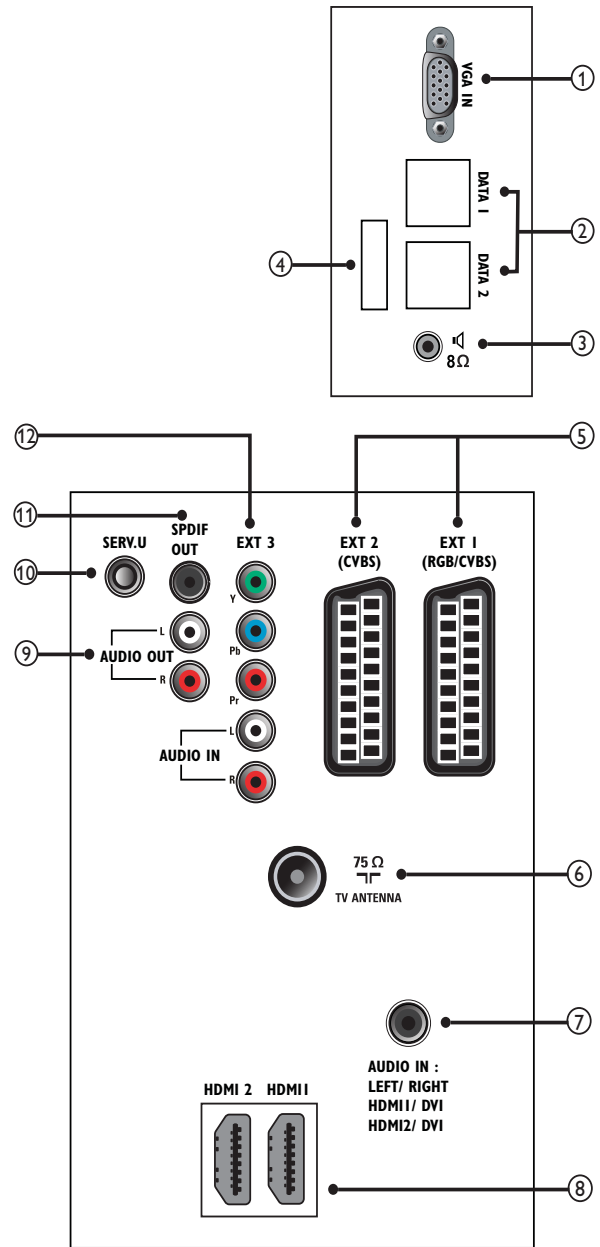

- ① **VGA IN**
Video input from a computer.
- ② **DATA 1 and DATA 2**
Pay-Per-View terminal connection.
- ③ **8Ω**
1/8 inch mini-jack connection to a bathroom speaker or a healthcare pendant control (also known as pillow speaker).
- ④ **Software Update**

- ⑤ **EXT 1 (RGB/CVBS) and EXT 2 (CVBS)**
Analogue audio and video input from analogue or digital devices such as DVD players or game consoles.

TV ANTENNA

Signal input from an antenna, cable or satellite.

AUDIO IN

Audio input from devices that require a separate audio connection, such as a computer.

- ⑥ **HDMI 1/ HDMI 2**

Digital audio and video input from high-definition digital devices such as Blu-ray players.

AUDIO OUT L/R

Analogue audio output to home theatres and other audio systems.

SERV. U

For Serial Express communication and use by service personnel.

SPDIF OUT

Digital audio output to home theatres and other digital audio systems.

- ⑦ **EXT 3 (Y Pb Pr and AUDIO IN L/R)**
Analogue audio and component video input from analogue or digital devices such as DVD players or game consoles.

Note

- Do not use **VGA IN** and **EXT 3** at the same time.

Side connectors

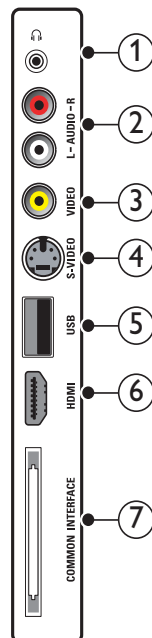

- ① **Headphone**
Stereo audio output to headphones or earphones.
- ② **AUDIO L/R**
Audio input from analogue devices connected to **VIDEO**.
- ③ **VIDEO**
Composite video input from analogue devices such as VCRs.
- ④ **S-VIDEO**
S-Video (side) to be used with Audio L/R connectors for camcorder, game console, etc. When you use the S-Video (side) for video signals, do not use the Composite video (side) input for video signals.
- ⑤ **USB**
Data input from USB storage devices.
- ⑥ **HDMI**
Digital audio and video input from high-definition digital devices such as Blu-ray players.
- ⑦ **COMMON INTERFACE**
Slot for a Conditional Access Module (CAM).

Use a Conditional Access Module

A Conditional Access Module (CAM) is provided by digital TV service operators to decode digital TV channels.

Note

- If required, refer to documentation from your operator on how to insert a smart card into the Conditional Access Module.

Insert and activate a CAM

! Caution

- Be sure to follow the instructions described below. Wrong insertion of a CAM may damage both the CAM and your TV.

- 1 Switch off the TV and disconnect it from the power outlet.
- 2 Following the directions printed on the CAM, gently insert the CAM into the **COMMON INTERFACE** at the side of the TV.

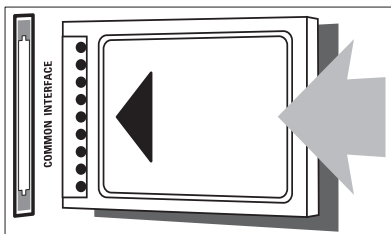

- 3 Push the CAM in as far as it will go.
- 4 Reconnect the TV to the power outlet.
- 5 Turn on the TV and wait for the CAM to be activated. This may take several minutes. Do not remove the CAM from the slot when in use — removing the CAM will deactivate digital services.

Access CAM services

- 1 After inserting and activating the CAM, enter the setup menu.
- 2 Press ▲▼◀▶ to select **[CONFIGURATION] > [SECURITY] > [CI CARD] > [YES]**.
 - ↳ Applications provided by the digital TV service operator appear on the screen.

Note

- This menu option is available only if the CAM is inserted and activated correctly.

Use a Kensington lock

There is a Kensington security slot at the back of the TV. Prevent theft by looping a Kensington lock between the slot and a permanent object, such as a heavy table.

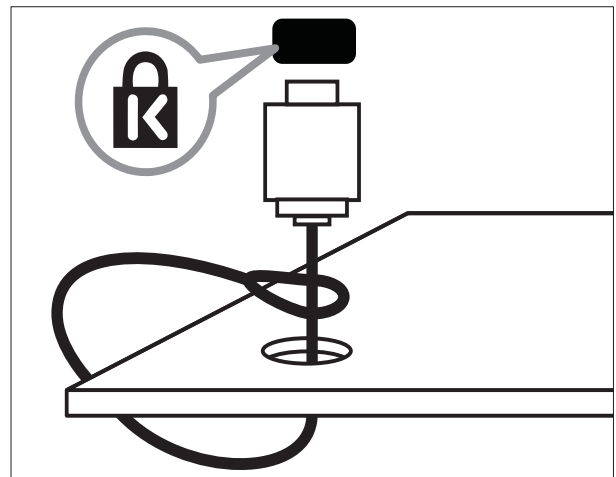

11 Product information

Product information is subject to change without notice. For detailed product information, go to www.philips.com/support.

Supported display resolutions

Computer formats

- Resolution - refresh rate:
 - 640 × 480 - 60Hz
 - 800 × 600 - 60Hz
 - 1024 × 768 - 60Hz
 - 1280 × 1024 - 60Hz (HDMI only)
 - 1360 × 768 - 60Hz
 - 1920 × 1080 - 60Hz (HDMI only)

Video formats

- Resolution - refresh rate:
 - 720 × 480p @60Hz
 - 720(1440) × 480i @60Hz
 - 720 × 576p @50Hz
 - 720(1440) × 576i @50Hz
 - 1280 × 720p @ 60Hz
 - 1280 × 720p @50Hz
 - 1920 × 1080i@50Hz, 60Hz
 - 1920 × 1080p@24Hz, 25Hz, 30Hz, 50Hz, 60Hz

Multimedia

- Supported storage device: USB1.1 and USD 2.0 memory class device
- Supported audio format: MP3
- Supported image format: JPEG (.jpg)
- Supported slideshow format: Philips Album Format (.alb)

Tuner/Reception/Transmission

- Antenna input: 75ohm coaxial (IEC75)
- TV system: DVB-T; PAL I/BG/DK; SECAM BG/DK/I/ L/L'
- Video playback: NTSC M/4.43; SECAM; PAL BG/M/N/60
- Tuner Bands: Hyperband, S-channel, UHF, VHF

Power

- Mains power: 90-270V, 50Hz
- Standby power: < 1W with LCD clock display.
- Ambient temperature: 5 to 40 degrees Celsius

Power

- Speaker diversity: 10W/ 6 Ohms
- Internal speaker RMS power:
 - Impedance: 6 Ohm
 - Power: 2 × 10W
 - Audio response: -3dB, >12.5 KHz
- Headphone:
 - Impedance: 16 Ohm
 - Power: 2 × 50mW
- Bathroom amplifier:
 - Impedance: 8 Ohm
 - Power: 1W

12 Troubleshooting

This section describes commonly encountered issues and accompanying solutions.

TV power on/ off issues

The TV does not power on:

- Ensure that the TV is connected to the AC mains power outlet. If it does not power on, pull the plug out of the power outlet, wait for 60 seconds, plug it back in and turn the TV on again.

The TV does not respond:

- Check that the TV controls are not locked. Use the PBS setup remote control to access the PBS setup menu and unlock all TV control keys (see 'Enable or disable the TV controls' on page 15).
- If you are using the guest remote control, check that the remote control is not locked. Use the PBS setup remote control to access the PBS setup menu and enable the guest remote control (see 'Enable or disable the remote control' on page 15).

The TV turns off by itself:

- Check the ESP setting and increase the time if you want the TV to stay on for a longer duration (see 'Select the energy saving option' on page 17).

The TV cannot be turned off:

- Check if the power mode has been set to **[FORCED ON]**. If it is set to **[FORCED ON]**, select a different setting (see 'Preset the picture format' on page 12).

No access to PBS setup menu

The PBS setup mode cannot be accessed using the guest remote control:

- Check that the high-security mode has been turned off. Use the PBS setup

remote control to access the PBS setup menu to allow the use of the guest remote control (see 'Select the security level' on page 15).

The PBS setup mode cannot be accessed using the PBS setup remote control:

- Check that the switch at the side of the PBS setup remote control is set to the **SETUP** position (see 'Access the setup menu with the PBS setup remote control' on page 8).

Picture issues

The TV is on, but there is no picture:

- Check that the antenna or the cable is connected properly to the TV.
- Check that source device and communication protocols are selected correctly.

The TV is on, but picture quality is not good:

- Check the antenna, cable or set-top box connections to the TV and ensure that they are properly connected.
- Check that the picture settings are correct for your TV and the source device.
- Do not connect the VGA input and the EXT3 input to the TV at the same time.

Sound issues

There is a picture but no sound:

- Check that all the cables are properly connected.
- Check if the audio is muted. If it is muted, enable audio on the channel (see 'Mute a channel' on page 20).
- Check that the audio source is selected correctly (see 'Configure the sound settings' on page 14).
- If the TV is connected to a DVD player using an HDMI connection, make sure

that the digital output of the DVD player is set to PCM mode.

- Check that the **[MIN VOLUME]** is not set to zero (see 'Configure the sound settings' on page 14).

Communication issues

The TV does not communicate with the external device:

- Select the correct communication source.
- Check that the card slot is enabled, if you want to use the system/smart card.

Guest RC does not work

The guest remote control does not work:

- Change the batteries if they are weak or old.
- Check the orientation of the batteries and make sure that they are inserted in accordance with the +/- orientation.
- If the remote control is locked, unlock the remote control (see 'Enable or disable the remote control' on page 15).

Other issues

The character 'F' appears on screen:

- This means that the TV is in factory mode. Press **MENU** at the side of the TV for a few seconds to reset the TV to normal mode.

Contact us

If you cannot resolve your problem, refer to the FAQs for this product at www.philips.com/support.

If the problem remains unresolved, contact Philips Consumer Care in your country as listed in the Addendum.



Warning

- Do not attempt to repair the product yourself. This may cause severe injury, irreparable damage to your product or void your warranty.



Note

- Make a note of your TV model and serial number before you contact Philips. These numbers are printed on the back of the TV and on the packaging.

13 Index

A

Audio/video out	15
Auto SCART	16

C

CAM	26
Card slot	9
Channel	
Channel banner	13
Channel display	13
Lock a channel	19
Mute a channel	20
Name a channel	20
Rings of channels	20
Scrambled channel	16
Set the number of channels	9
Switch-on channel	12

Clock settings

Buzzer volume	10
Display clock	10
Download time	10
Set time	10

Cloning

Clone data from TV to USB	21
Clone data from USB to TV	21

Communication

Conditional Access Module	26
---------------------------	----

Configure settings

Clock settings	10
Control settings	16
Energy saving	17
Healthcare settings	23
Picture settings	14
Security settings	14
Sound settings	14
Switch-on settings	11

Control settings

Controls	6
----------	---

D

Display resolutions	27
---------------------	----

Download software	21
Download time	10

E

Energy saving	17
ESP	17

H

Healthcare settings	23
---------------------	----

I

Install channels

Automatic installation	18
Manual installation	19

K

Kensington lock	26
Keyboard lock	15

L

Language

Menu language	9
Teletext language	19

Loud speaker mute

Low power standby	17
-------------------	----

M

Multi RC	23
----------	----

P

Picture settings	14
------------------	----

Power

ESP	17
Low power standby	17
Power mode	12
Power specifications	27
Smart power	17

R

Remote control

Guest RC	8
Multi RC	23

PBS setup RC	8
RC lock	15
Remote control colour	23
RGB insertion	17
Rings of channels	20

S

Screen care	5
Security settings	
High security	15
Keyboard lock	15
RC lock	15
Standard security	15
Smart power	17
Sound settings	14
Switch-on settings	
Audio language	13
Channel banner	13
Channel display	13
Power mode	12
Subtitle language	13
Switch-on channel	12
Switch-on picture format	12
Switch-on power	12
Switch-on volume	12
TV theme	13
Volume indicator	13
Welcome message	12

T

Troubleshooting	28
------------------------	----

