

Philips Business Display Solutions

User Manual

26HF5544D
32HF7544D
37HF7544D
42HF7544D
42HF7544R



Thank you for choosing Philips.

Need help fast?

*Read your Quick Use Guide and/or
Owner's Manual first for quick tips
that make using your Philips product
more enjoyable.*

*If you have read your instructions
and still need assistance,
you may access our online help at*

www.bds.philips.com

or call

1-866-358-9601

***while with your product
(and Model / Serial number)***

For Customer Use

Enter below the Serial No. which is located
on the rear of the cabinet. Retain this
information for future reference.

Model No. _____

Serial No. _____

PHILIPS

TABLE OF CONTENTS

Introduction

| | |
|--|---|
| Important Safety Instructions | 3 |
| Safety Information and Useful Tips | 4 |
| Before Calling Service | 5 |

Basic Installation/Functions

| | |
|--|---|
| Basic Television Connection | 6 |
| Use & Care of Remote Control | 6 |
| Rear Jack Panel Connections | 7 |
| Remote Controls | 8 |
| Guest Remote Control Keys | 9 |

TV Installation

| | |
|--|---------|
| Activating TV Setup Menu | 10 |
| TV Setup Main Menu | 10 |
| TV Setup & Sub-menus | 11 - 12 |
| Accessing Internal TV Setup Menu | 13 |

Cabinet Dimension Drawings

| | |
|--|----|
| 26HF5544D Dimensions | 14 |
| 32HF7544D Dimensions | 15 |
| 37HF7544D Dimensions | 16 |
| 42HF7544D/42HF7544R Dimensions | 17 |

Appendix

| | |
|---|---------|
| Glossary (Definitions, Acronyms, Abbreviations) | 18 - 19 |
| Cleaning & Care | 20 |
| Product End-of-life Disposal | 20 |
| Limited warranty | 20 |
| Index | 21 |

Note : Specifications in this manual are subject to change without notification.



Recycling Directive – To minimize harm to the environment, the batteries supplied with the TV set do not contain mercury or nickel cadmium. If possible, when disposing of batteries, use recycling means available to you.

Your TV set uses materials which are reusable or which can be recycled. To minimize the amount of waste in the environment, certain companies recover used sets for dismantling and collection of reusable materials (contact your dealer or local recycling resources).

IMPORTANT SAFETY INSTRUCTIONS

Read before operating equipment

1. Read these instructions.
2. Keep these instructions.
3. Heed all warnings.
4. Follow all instructions.
5. Do not use this apparatus near water.
6. Clean only with a dry cloth.
7. Do not block any of the ventilation openings. Install in accordance with the manufacturers instructions.
8. Do not install near any heat sources such as radiators, heat registers, stoves, or other apparatus (including amplifiers) that produce heat.
9. Do not defeat the safety purpose of the polarized or grounding type plug. A polarized plug has two blades with one wider than the other. A grounding type plug has two blades and third grounding prong. The wide blade or third prong are provided for your safety. When the provided plug does not fit into your outlet, consult an electrician for replacement of the obsolete outlet.
10. Protect the power cord from being walked on or pinched particularly at plugs, convenience receptacles, and the point where they exit from the apparatus.
11. Only use attachments/accessories specified by the manufacturer.
12.  Use only with a cart, stand, tripod, bracket, or table specified by the manufacturer, or sold with the apparatus. When a cart is used, use caution when moving the cart/apparatus combination to avoid injury from tip-over.
13. Unplug this apparatus during lightning storms or when unused for long periods of time.
14. Refer all servicing to qualified service personnel. Servicing is required when the apparatus has been damaged in any way, such as power-supply cord or plug is damaged, liquid has been spilled or objects have fallen into apparatus, the apparatus has been exposed to rain or moisture, does not operate normally, or has been dropped.
15. This product may contain lead and mercury. Disposal of these materials may be regulated due to environmental considerations. For disposal or recycling information, please contact your local authorities or the Electronic Industries Alliance: www.eiae.org
16. **Damage Requiring Service** - The appliance should be serviced by qualified service personnel when:
 - A. The power supply cord or the plug has been damaged; or

- B. Objects have fallen, or liquid has been spilled into the appliance; or
 - C. The appliance has been exposed to rain; or
 - D. The appliance does not appear to operate normally or exhibits a marked change in performance; or
 - E. The appliance has been dropped, or the enclosure damaged.
17. **Tilt/Stability** - All televisions must comply with recommended international global safety standards for tilt and stability properties of its cabinet design.
 - Do not compromise these design standards by applying excessive pull force to the front, or top, of the cabinet which could ultimately overturn the product.
 - Also, do not endanger yourself, or children, by placing electronic equipment/toys on the top of the cabinet. Such items could unsuspectingly fall from the top of the set and cause product damage and/or personal injury.
 18. **Wall or Ceiling Mounting** - The appliance should be mounted to a wall or ceiling only as recommended by the manufacturer.
 19. **Power Lines** - An outdoor antenna should be located away from power lines.
 20. **Outdoor Antenna Grounding** - If an outside antenna is connected to the receiver, be sure the antenna system is grounded so as to provide some protection against voltage surges and built up static charges. Section 810 of the National Electric Code, ANSI/NFPA No. 70-1984, provides information with respect to proper grounding of the mast and supporting structure, grounding of the lead-in wire to an antenna discharge unit, size of grounding connectors, location of antenna-discharge unit, connection to grounding electrodes, and requirements for the grounding electrode. See Figure below.
 21. **Object and Liquid Entry** - Care should be taken so that objects do not fall and liquids are not spilled into the enclosure through openings.
 22. **Battery Usage CAUTION** - To prevent battery leakage that may result in bodily injury, property damage, or damage to the unit:
 - Install all batteries correctly, with + and - aligned as marked on the unit
 - Do not mix batteries (old and new or carbon and alkaline, etc.)
 - Remove batteries when the unit is not used for a long time.

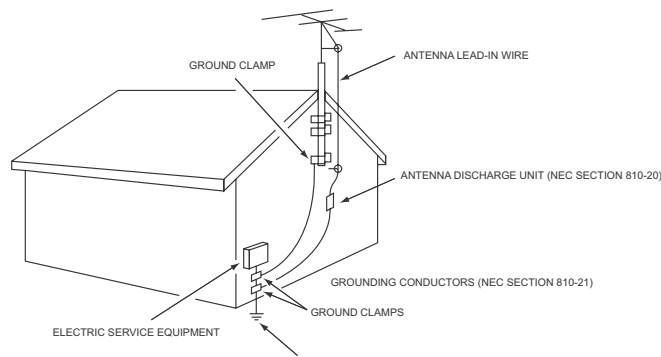

Note to the CATV system installer: This reminder is provided to call the CATV system installer's attention to Article 820-40 of the NEC that provides guidelines for proper grounding and, in particular, specifies that the cable ground shall be connected to the grounding system of the building, as close to the point of cable entry as practical.

EXAMPLE OF ANTENNA GROUNDING AS PER NATIONAL ELECTRICAL CODE (NEC)

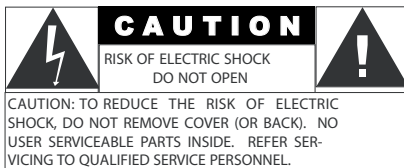

Know these safety symbols



-  This "bolt of lightning" indicates uninsulated material within your unit which may cause an electrical shock. For the safety of everyone in your household, please do not remove product covering.
-  The "exclamation point" calls attention to features for which you should read the enclosed literature closely to prevent operating and maintenance problems.

WARNING: To reduce the risk of fire or electric shock, this appliance should not be exposed to rain or moisture and objects filled with liquids, such as vases, should not be placed on this apparatus.

CAUTION: To prevent electric shock, match wide blade of plug to wide slot, and fully insert.

ATTENTION: Pour éviter les chocs électriques, introduire la lame la plus large de la fiche dans la bome correspondante de la prise et pousser jusqu'au fond.

SAFETY INFORMATION AND USEFUL TIPS

A GUIDE TO DIGITAL TV

What is Digital Television (DTV)?

Digital Television (DTV) is a relatively new type of broadcasting that promises to transform television viewing into a whole new experience. Digital technology is used to capture images and sound to deliver a better picture quality. DTV technology is also capable of multicasting and interactive capabilities.

There are many levels of digital television quality. The most common are:

Standard Definition TV (SDTV)

SDTV is the basic level of quality display and resolution for both analog and digital. Transmission of SDTV can be in the traditional (4:3) or widescreen (16:9) format.

Enhanced Definition TV (EDTV)

EDTV is better in picture quality than analog television. The formats for EDTV are 480p widescreen (16:9) or traditional (4:3). EDTV is in the middle range quality between SDTV and HDTV.

High Definition TV (HDTV)

HDTV has the highest quality for digital broadcast formats. Its resolution is widescreen format (16:9). Combined with digitally enhanced sound technology, HDTV sets new standards for sound and picture quality in television.

DTV is by far a more flexible and efficient technology than the analog broadcast system. Analog broadcasts can only provide one program at a time. Digital television can broadcast a high definition program or more than one standard definition program at the same time. This is often referred to as "multicasting". Digital television can also give you interactive video and data services through a single digital channel.

PREPARATION

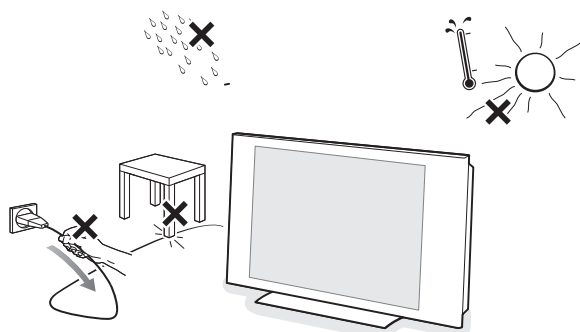

Do not insert the power plug in a wall socket before all connections are made.

Place the TV on a solid surface or place the TV on the supplied stand. For the mounting instructions of the stand, see the Cover Page. For ventilation, leave at least 4" to 6" free all around the TV. Do not place the TV on a carpet. To prevent any unsafe situations, no naked flame sources, such as lighted candles, should be placed in the vicinity. Avoid heat, direct sunlight and exposure to rain or water. The equipment shall not be exposed to dripping or splashing.

Mounting the TV on the wall

This TV is compatible with the VESA wall mounting standard. Please contact your local electronics retailer for a VESA compliant bracket to wall mount this TV.



Caution: Installing the TV requires special skill that should only be performed by qualified personnel. You should not attempt to do the work yourself. Philips bears no responsibility for improper mounting or mounting that results in accident or injury. Make sure that the wall mount is being fixed securely enough so that it meets safety standards.

BEFORE CALLING SERVICE

Check this list of symptoms and suggested steps to take before requesting service. You may be able to solve the problem yourself. **Note :** *Please become familiar with the commercial features as described in TV installation / Setup because the effects of several of these features, if not thoroughly understood might appear as faulty operation.*

| SYMPTOMS | | SUGGESTED STEPS TO TAKE |
|--------------------------------|---|--|
| Installation | TV does not respond to commands (volume, channel, power), or cannot be turned on (if it is off). Or cannot be turned off (if TV is on). | 1. Check commercial TV setup (TV installation / setup) menu, including power forced on, Keyboard Lock, volume minimum / maximum features. |
| Installation | TV turns off by itself. | 1. TV automatically turns off after approximately 5 minutes when no RF signal is present (unless POWER ON = FORCED). 2. Check Energy Saving Programmability setting (see ESP) in TV installation / setup. |
| Picture | No Picture | 1. Check that the antenna / cable is connected properly at the rear of the TV. 2. Check Tuning Mode setting (Air / Cable). 3. Possible TV station problem. Try another channel. |
| Picture | There is picture but no sound. | 1. Try increasing the volume. 2. Check that the sound is not muted. If it is, press the MUTE button on the remote control to restore sound. |
| Picture Display (Color) | Uneven color display. | 1. Ensure that the TV is not placed near any speakers or magnetic objects. |
| Picture Display | Double image / "ghost" image | Check antenna, cable or set-top box. |
| Picture Display | Snowy / noisy picture | 1. Check antenna, cable and / or setup box connections. Ensure that they are properly connected. 2. Possible electrical interference from appliances or other sources. |
| Power | No power | Ensure that the TV's AC power cord is plugged into the main socket. If there is still no power, disconnect the plug. Wait for 60 seconds and re-attach plug. Turn on the TV again. |
| Remote Control | TV does not respond to remote control | 1. Check batteries. 2. Aim remote control directly at remote control sensor lens on TV and try pressing any button on the remote control. |
| Sound | There is sound but poor or no picture | Check picture adjustments (brightness, contrast, color, tint). |

BASIC TELEVISION CONNECTION

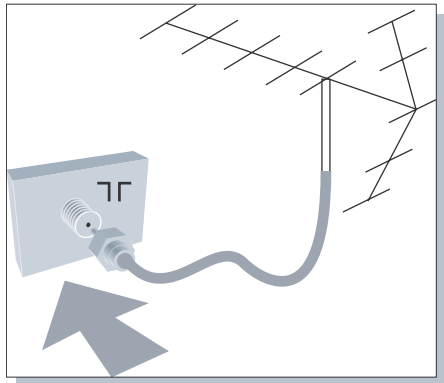

ANTENNA CONNECTION

- Connect the antenna or RF cable signal to the 75 ohm RF 'F' connector socket located on the TV.

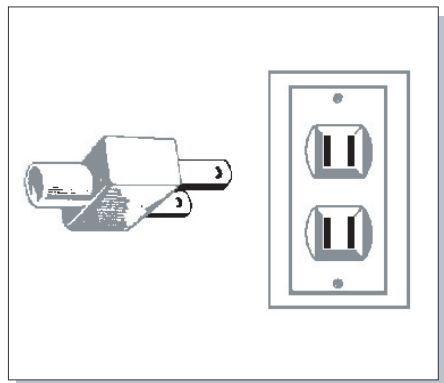

MAINS CONNECTION

- Ensure that the mains voltage and frequency are correct. Please refer to the product labelling and documentation.

Note : The power button on the TV does not disconnect the television from the AC mains. It toggles the TV between on and standby mode. To completely turn off the AC mains power, you must unplug the AC mains plugs from the wall socket.

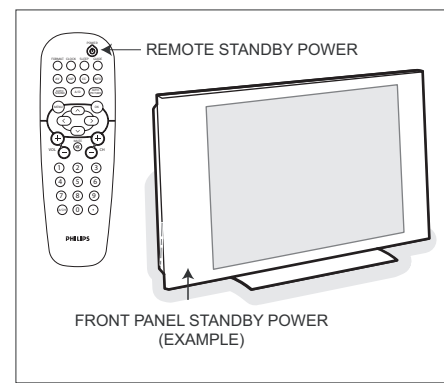

SWITCHING ON THE SET

- Press the power button on the TV or on one of the optional remote controls to switch the TV set on.

Note : If the TV is in commercial mode, it might not respond to the front panel or the remote control. Please refer to the section on **TV Installation** and **TV Setup Menu** in this documentation for more information.

USE & CARE OF OPTIONAL REMOTE CONTROLS

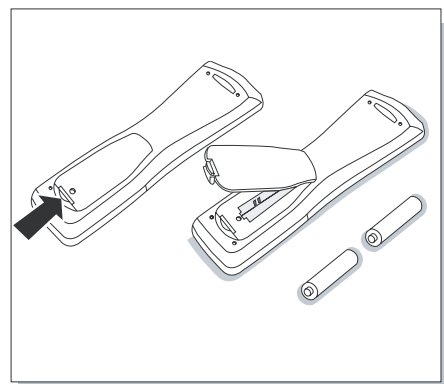

To load the supplied batteries into the remote control ;

- Remove the battery compartment lid from the back of the remote control.
- Insert two AA-sized batteries into the battery compartment, making sure the positive + and negative - polarity line up correctly as indicated inside the case.
- Reattach the battery compartment lid.

Note : Always remove batteries from the remote control if it is not used for a long period of time. This is to prevent damage to the remote control due to battery leakage.

REAR JACK PANEL CONNECTIONS

*** WARNING :**

- Risk of electric shock. Rear jack panel must be removed by qualified personnel only.
- Do not connect any telephone cables or equipment to Data1 (RJ12) & Data2 (RJ45) connectors.

26HF5544D

Rear Connectors

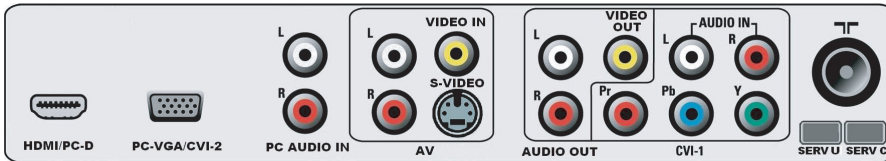

26"/32" Side Connectors

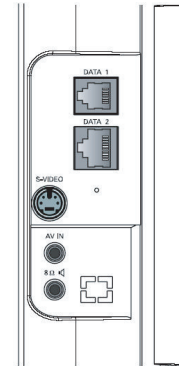

32HF7544D

Rear Connectors

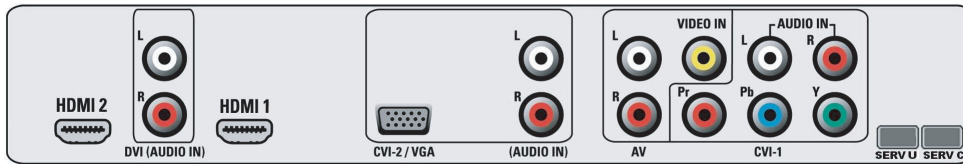

37HF7544D

42HF7544D

42HF7544R

Rear Connectors

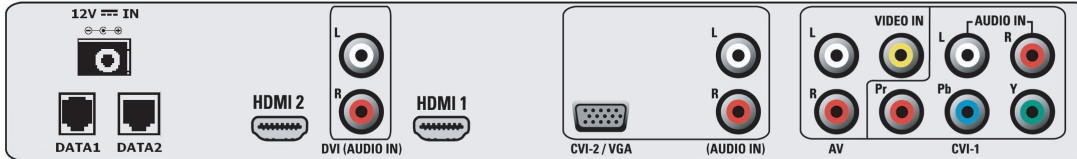

37" Side Connectors

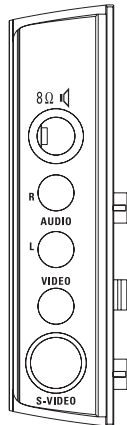

42" Side Connectors

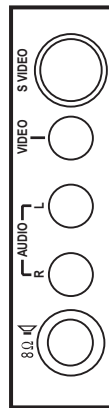

OPTIONAL REMOTE CONTROLS

The following remote controls are applicable to Philips Business Display Solutions TV products. These can be used for setup and configuration purposes.



RC2888/01
Guest-Mode Remote
(optional)

Slide this button up to enter into **Guest mode**.

Slide this side button down to enter into **Setup mode**.

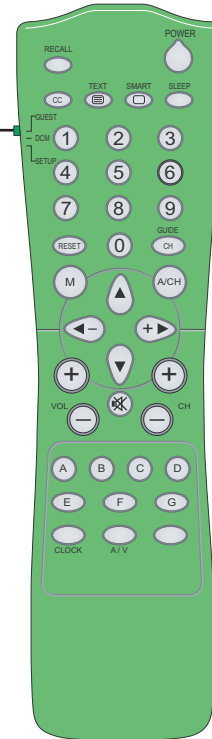

RC2573GR
(optional)

RC2573GR (optional)

RC2573GR is an optional remote control for Institutional TV / Business Display Solutions features and SmartCard settings. It can be purchased separately.

GUEST REMOTE CONTROL KEYS

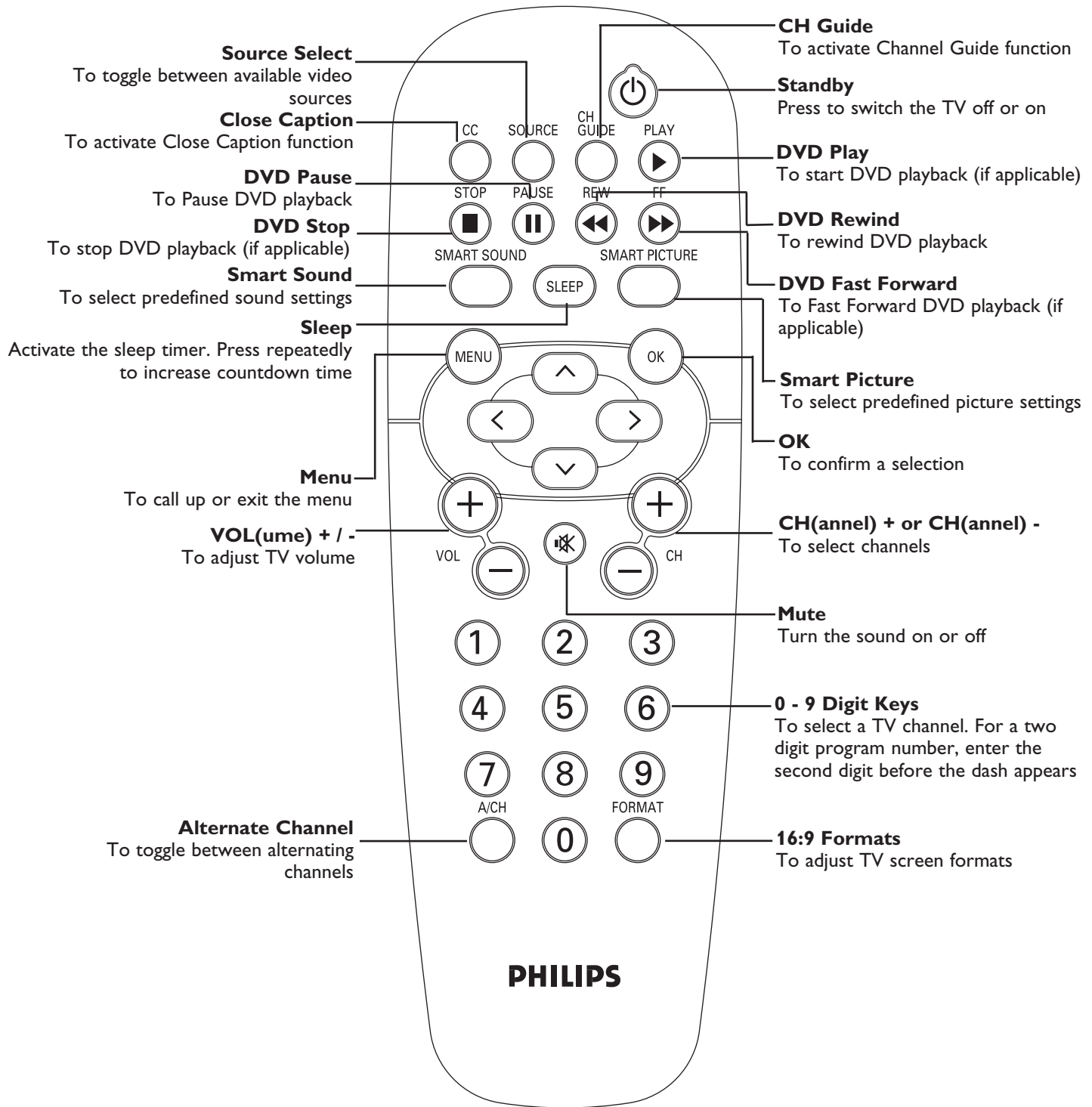

ACTIVATING TV SETUP MENU

The following remote control commands are applicable to Philips Business Display Solutions TV products. These can be used for setup and configuration purposes.

WITH GUEST REMOTE CONTROL RC2888/01

(only when SECURITY in the TV SETUP MENU is set to STANDARD. Refer to page 11).

To activate TV SETUP MENU :

- 1** Select a channel number
- 2** Key in 7 4 3 0 6 8 followed by the  button on the remote control.

Note : All buttons (in step 2) on the remote control 7 4 3 0 6 8  must be pressed successively within 20 seconds or else the TV Setup Menu will not be activated.

WITH REMOTE CONTROL RC2573GR (only in TV Commercial Mode).

To activate TV Setup Menu

- 1** Press the **F** button on the remote control to activate the TV Setup Menu.

TV SETUP MAIN MENU

| Menu Items | Options |
|----------------------------|----------------------------|
| Tuning Mode | Air / Cable |
| Switch-On Options | |
| • Switch-On Channel | Channel 1 - 125 |
| • Volume | Restore / Volume 0 - 99 |
| • Picture Format | Native / Widescreen |
| • Power On | Standby / Forced / Restore |
| Security Options | |
| • Security | Standard / High |
| Control Options | |
| • ESP | Hours : 0 - 99 |
| • Source Menu Item | Yes / No |
| • Picture Format Menu Item | Yes / No |
| • Minimum Volume | Volume 0 - 99 |
| • Maximum Volume | Volume 0 - 99 |
| Captioning Options | |
| • Save Captioning | Yes / No |
| • Captioning | On / On when muted / Off |
| • Analog CC Mode | CC1 - CC4 / TXT1 - TXT4 |
| Service Menu | |
| • Update Channel | Channel : 0 - 125 |
| • Allow Update Searching | Yes / No |
| • Start Firmware Update | |
| • Restore Factory Settings | |
| • Show Status | |

- 1) To scroll through the menu, press **▲** or **▼** on the remote control. A highlight indicates that the respective menu item's setting is selected for modification.
- 2) To modify the setting of the selected menu item press **▶**.
- 3) To exit, press  on the RC2573GR setup remote control.

TV SETUP MENU & SUB-MENUS (CONTINUED)

* Tuning mode (Air / Cable)

If *Tuning mode* is set to **Air**. You are selecting standard off-air channel tuning

If *Tuning mode* is set to **Cable**. You are selecting channel tuning via cable.

* Switch-On Options

● Switch-On Channel (1 - 125)

Specify the channel which the TV will be tuned when it is powered on.

● Volume (Restore / 0 - 99)

Specify the volume setting that takes effect when the TV is powered on.

If **Restore** is selected, the volume at power-on will be the volume at which the TV was prior to last power-down.

● Picture Format (Native / Widescreen)

Specifies the picture screen format when the TV is powered on.

If **Native** is selected, the TV screen will display the picture according to the actual screen format of the TV transmission.

Example : if the TV signal is transmitted in 4 : 3 format, then the TV screen format will also be set to 4 : 3.

If **Widescreen** is selected, the TV screen will always be set to Widescreen (16 : 9) format when the TV is powered on, irrespective of the actual picture format that is transmitted to the TV.

● Power On (Standby / Forced / Restore)

STANDBY : The TV will be in standby mode when AC mains power is first applied after being disconnected.

FORCED : The TV will turn ON whenever AC mains power is applied. This feature allows the TV's power status to be controlled. (For example : From an AC Mains breaker)

RESTORE : When AC mains power is first applied after being disconnected, the TV's power status will revert back to the status when the AC mains power was last removed.

* Security Options

● Security (Standard / High)

This feature provides the option to enable access to the SETUP MENU without an RC2573GR setup remote control.

Standard : The TV SETUP MENU can be accessed by entering a special security code with a guest remote control. Refer to your Philips sales representative for more details.

High : The TV SETUP MENU can be accessed only with an RC2573GR setup remote control in setup mode.

Note : The default SECURITY setting for Institutional TV is STANDARD. When SECURITY is in STANDARD mode, the TV may be vulnerable to unauthorized operation.

* Control Options

● ESP - Energy Saving Programmability (OFF / 1 HR / 2 HR / ... / 99 HR)

This feature enables the TV to automatically power-down after a specified period of time. If during this period it does not receive any commands from the remote control or TV front panel, this energy-saving feature assumes the TV is inactive, and will automatically power-down.

● Source Menu Item (No / Yes)

This feature specifies whether the current signal source (eg. Tuner, AV, Side, HDMI-2, CVI-1, VGA) item is present in the OPTIONS MENU that appears when the SLEEP or CC button on the remote control is pressed, or when the MENU button on the guest-mode remote control is pressed.

No : The SOURCE line item does not appear in the OPTIONS MENU.

Yes : The SOURCE line item appears in the OPTIONS MENU.

TV SETUP MENU & SUB-MENUS (CONTINUED)

● **Picture Format Menu Item (Yes / No)**

This feature specifies whether the PICTURE FORMAT item is present in the OPTIONS MENU that appears when the SLEEP or CC button on the remote control is pressed, or when the MENU button on the guest-mode remote control is pressed.

No : The PICTURE FORMAT line item does not appear in the OPTIONS MENU.

Yes : The PICTURE FORMAT line item appears in the OPTIONS MENU.

● **Minimum Volume (0 - 99)**

Specify the lowest volume setting possible by using the remote control or the TV front panel (if it is not locked out). This setting cannot exceed the MAX VOLUME.

● **Maximum Volume (0 - 99)**

Specify the highest volume setting possible by using the remote control or the TV front panel (if it is not locked out). This setting cannot be less than the MIN VOLUME.

* **Captioning Options**

● **Save Captioning (No / Yes)**

This feature enables the CC setting to remain in effect after the TV is powered down.

No : When the TV is powered down and turned on again, the closed captioning settings will default to OFF.

Yes : When the TV is powered down and turned on again, the closed captioning previously set will remain in effect.

● **Captioning (On / On when muted / Off)**

Since July 1993, TV sets with 13" screens or larger must have built-in caption decoders. Captioning of most broadcast and cablecast programming is mandated under the Telecommunications Act of 1996, except for programs exempted by the FCC. For additional information please visit the U.S. FCC website at : <http://www.fcc.gov/cgb/consumerfacts/closedcaption.html>.

Off : Close captioning text will not be displayed even when it is provided by the broadcaster.

On when muted : Close captioning text will appear only when the TV is MUTED.

On : Close captioning text will be displayed if it is present in the incoming signal.

● **Analog CC Mode**

This feature specifies which of the (Analog) CC Modes are to be used for Close Captioning information, if Captioning is set to ON.

* **Service Menu**

Note: The Service Menu should only be used by trained personnel who are familiar with the upgrading process of this TV set.

● **Update Channel (0 - 125)**

Specify the TV channel to obtain software or firmware updates for the TV set.

● **Allow Update Searching (Yes / No)**

This option allows the TV to automatically scan through all available channels for the latest software and firmware updates, without any need for manual intervention. The scanning of the channels only begins after the TV set is placed in Standby mode, to minimize viewing disruption.

Yes : Allows the TV to perform automatic updates of the TV software and firmware, whenever the TV is put into Standby mode.

No : Prevents the TV from performing automatic updates of the TV software and firmware.

● **Start Firmware Update**

Select this option to manually start the process of updating the firmware of the TV set.

● **Restore Factory Settings**

Select this option to reset all the settings of your TV to its original 'out-of-factory' default state.

● **Show Status**

Select this option to display the Status screen, which provides important information on the current status of the TV set, including firmware version details that would help our Service personnel identify your set.

ACCESSING INTERNAL TV SETUP MENU

Adjustments to Picture and TV Keyboard settings can be made via the Internal TV Setup menu. Once these settings are modified and stored, the new settings will take effect immediately.

*** WARNING :** 

It is strongly recommended not to access the Internal TV Setup menu unless absolutely necessary. Modifying any other settings in the Internal TV Setup menu (apart from the Picture settings) may prevent your TV from functioning normally.

To activate Internal TV Setup Menu:

1. Ensure that the TV is switched off
2. Disconnect the RJ12 cable from the DATA1 jack on the TV
3. Switch on the TV
4. Press the '3' on the (optional) Green Setup Remote Control (RC2573GR) to switch to an Analog channel (if successful, "TV3" will be displayed on the screen)
5. Press the Menu button on the RC2573GR to activate the Internal TV Setup menu (ensure that the Side Button on the RC2573GR is set to Setup Mode – see page 8)
6. Make the required changes to the settings on the TV
7. Ensure that the modified settings are stored, and press the Menu button again to exit
8. Switch off the TV
9. Reconnect the RJ12 cable into the DATA1 jack on the TV
10. Switch on the TV

26HF5544D DIMENSIONS

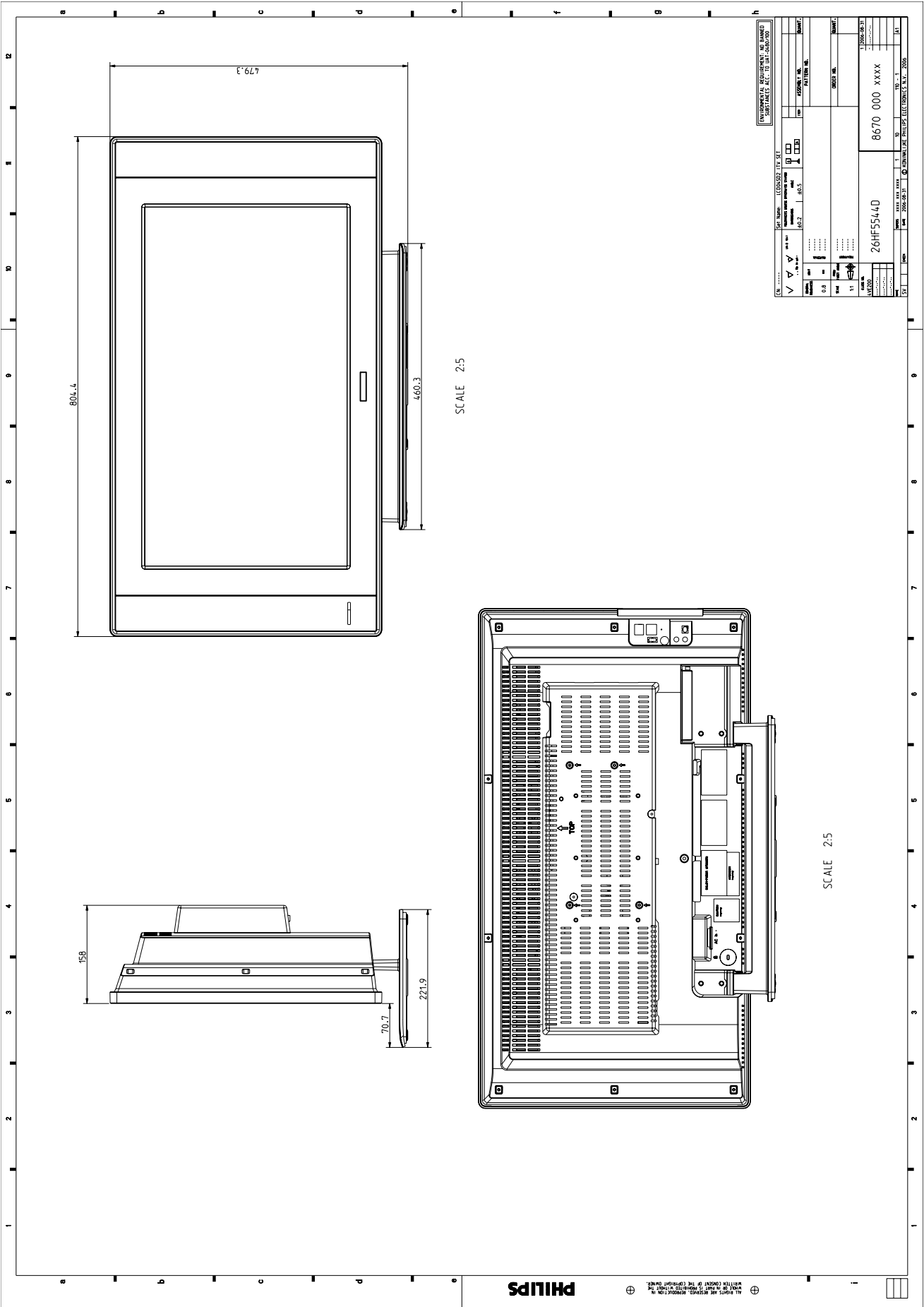

37HF7544D DIMENSIONS

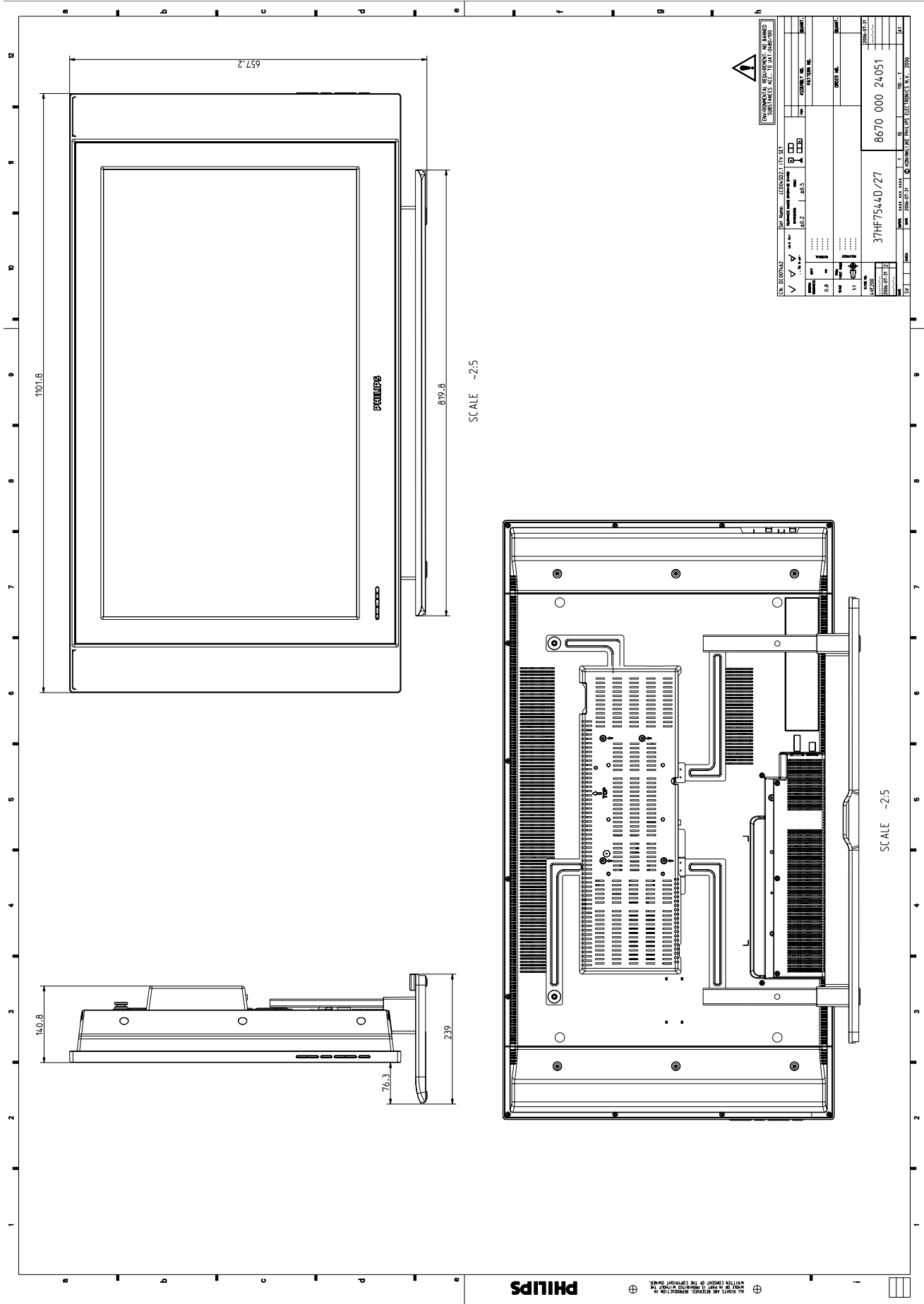

PHILIPS

ALL RIGHTS ARE RESERVED. REPRODUCTION IN WHOLE OR IN PART IS PROHIBITED WITHOUT THE WRITTEN CONSENT OF THE COPYRIGHT OWNER.

DEFINITIONS, ACRONYMS & ABBREVIATIONS

| | |
|------------|--|
| APAC | Automatic Pixel Aging Correction. A technique whereby the image displayed on the television screen is periodically shifted slightly, for the purpose of minimizing plasma panel phosphor "burn-in" |
| A/V | Audio / video. |
| BDS | Business Display Solutions. See PBS. |
| Bit Rate | Sometimes written "bitrate", the frequency at which bits are passing a given (physical or metaphorical) "point", quantified in terms of bits per second (bit/s). |
| CVI | Component video input. Sometimes used interchangeably with "YPbPr". |
| CVBS | Composite Video Broadcast Standard. Video signal containing combined color, luminance, and synchronization signals. Also often referred to as "AUX" video. |
| DB-9 | Standardized 9-pin connector, typically used for RS-232 asynchronous serial communications. |
| DB-15 | Standardized 15-pin connector, typically used for VGA / computer display signals. |
| DCM | Data Communications Module. ITV terminology for devices that communicate with Philips Institutional Television products by means of the Philips ITV SmartPort. |
| DFU | Directions For Use. Philips Consumer Electronics term for product instruction documentation. |
| DHCP | Dynamic Host Configuration Protocol. A protocol used on TCP/IP networks. Allows client configuration (TCP/IP address, default gateway, DNS configuration, etc.) to be sent to clients. |
| DNS | The network service used in TCP/IP networks that translates host names to IP addresses. |
| DVI | Digital Visual Interface, a digital interface standard created by the Digital Display Working Group (DDWG) to convert analog signals into digital signals to accommodate both analog and digital monitors. |
| HTML | Hypertext Markup Language. The set of markup symbols or codes inserted in a file intended for display on a World Wide Web browser page. |
| IR | Infra-red, long-wavelength light energy invisible to the human eye. In this context as applied to wireless remote controls. |
| IR-FACE | ITV interface module that adds ITV features and connectivity to non-ITV televisions. |
| MP3 | A compressed digital audio format. MPEG (Motion Pictures Experts Group) Layer 3 Audio compression. |
| MPEG | Moving Picture Experts Group. General term for a range of audio and video compression, and the name of the standards organization for digital video and digital audio compression. Operates under the auspices of the International Organization for Standardization (ISO) |
| ITV | Institutional Television. See PBS. Commercial / non-consumer division of Philips Consumer Electronics Co. |
| NA | Not available, not applicable. |
| NC | Not connected, no connection. |
| Off | See "Standby". |
| On | A state of operation in which the unit (television) is connected to an AC power source, in active use, and capable of responding to queries or commands from a control device (IR remote control) and/or DCM. |
| OSD | On-Screen Display. The display of alphanumeric text that appears over the video image. Typically generated by a character generator usually integrated into the television chassis control processor. |
| PBS | Philips Business Solutions. A commercial / non-consumer division of Philips Consumer Electronics.Co., of which Philips BDS, Business Display Solutions, formerly known as ITV, is a part. |
| Plug | Connector on a cable that connects to a plug. |
| RC | Remote control. |
| RC-5, RC-6 | Philips IR remote control communication protocols. |
| RJ-11 | Registered jack 11. Modular telephone-style connector form factor with 4 electrical conductors. |

DEFINITIONS, ACRONYMS & ABBREVIATIONS (CONT.)

| | |
|------------|---|
| RJ-12 | Registered jack 12. Modular telephone-style connector form factor with 6 electrical conductors. |
| Router | Technically, also known as a Layer 2 Switch. A switching hub that operates at the Data Link Layer (Layer 2), and builds a table of the MAC addresses of all the connected stations. |
| RTSP | Real-Time Streaming Protocol. Allows control of multimedia streams delivered, for example, via RTP (RFC 3389, Real-time Transport Protocol Payload). Control includes absolute positioning within the media stream, recording and possibly device control. |
| RTP | Real-time Transport Protocol. Defines a standardized packet format for delivering audio and video over the Internet. |
| Setup Mode | See System 7. Remote control mode used to configure Philips Institutional Televisions for specialized and/or restricted features such as front panel lockout, volume range, channel list, etc. |
| SmartPort™ | Philips proprietary three-wire synchronous serial communications and control interface. |
| SmartPlug™ | See SmartPort. |
| Socket | Connector on a cable that connects to socket. |
| SBB | Set-back box. Used interchangeably with "set-top box". General term for a device that adds functionality to, and / or interfaces a television with, a host content- and/or control- environment. |
| STB | Set-top box. See SBB. |
| Standby | Generally referred to as "off". A state of operation, characterized by relatively low power consumption, in which the unit (television) is connected to an AC power source, but not in active use, and capable of responding to queries or commands from a control device and/or DCM. |
| System 0 | First data word of a Philips RC-5 / RC-6 remote control code for standard television commands. Synonymous with Business Display Solutions / ITV "guest" mode. |
| System 7 | First data word of a Philips RC-5 / RC-6 remote control code reserved for specialized commands. Used for Business Display Solutions / ITV "setup" mode. |
| TCP/IP | Transmission Control Protocol / Internet Protocol. De facto standard protocol for Internet communications. |
| UDP | User Datagram Protocol. A minimal message-oriented transport layer protocol that is currently documented in IETF RFC 768. Used by Philips NetLink to issue device discovery packets. |
| YPbPr | Component video signals consisting of luminance, and blue and red components. |

Business Display Solutions



PHILIPS

One (1) Year Labor and Parts Repair

PHILIPS CONSUMER ELECTRONICS warrants this product against defect in material or workmanship, subject to any conditions set forth as follows:

PROOF OF PURCHASE:

You must have proof of the date of purchase to receive warranted repair on the product. A sales receipt or other document showing the product and the date that you purchased the product as well as the authorized retailer included, is considered such proof.

COVERAGE:

(If this product is determined to be defective)

LABOR: For a period of one (1) year from the date of purchase, Philips will repair or replace the product, at its option, at no charge, or pay the labor charges to any Philips authorized repair facility. After the period of one (1) year, Philips will no longer be responsible for charges incurred.

PARTS: For a period of one (1) year from the date of purchase, Philips will supply, at no charge, new or rebuilt replacement parts in exchange for defective parts, through a Philips authorized service center.

Note: If Philips is unable to provide service in your area, receipt of the paid service can be submitted for consideration of adjustment or full reimbursement at Philips discretion.

EXCLUDED FROM WARRANTY COVERAGE

Your warranty does not cover:

- Labor charges for installation or setup of the product, adjustment of customer controls on the product, and installation or repair of antenna systems outside of the product.
- Product repair and/or part replacement because of improper installation, connections to improper voltage supply, abuse, neglect, misuse, accident, unauthorized repair or other cause not within the control of Philips.
- A product that requires modification or adaptation to enable it to operate in any country other than the country for which it was designed, manufactured, approved and/or authorized, or repair of products damaged by these modifications.
- Damage occurring to product during shipping when improperly packaged or cost associated with packaging.
- Product lost in shipment and no signature verification of receipt can be provided.
- Products sold AS IS or RENEWED.

CARRY-IN / SHIP-IN WARRANTY

For Carry-In warranty repair, take the product to a Philips authorized service center for repair. When the product has been repaired, you must pick up the unit at the center.

For Ship-In warranty repair, ship the product to a Philips authorized service center for repair in its original carton and packing material. If you do not have the original carton or packing material, have your product professionally packed for shipping. Ship product via a traceable carrier. When it is necessary for you to ship the product to Philips for repair, you will pay the shipping cost for shipment to Philips. Philips will pay the shipping costs when returning the product to you.

TO OBTAIN WARRANTY SERVICE IN THE U.S.A., PUERTO RICO, OR U.S. VIRGIN ISLANDS...

Contact Philips Customer Care Center at:
1-866-358-9601

TO OBTAIN WARRANTY SERVICE IN CANADA...

1-866-358-9601

REPAIR OR REPLACEMENT AS PROVIDED UNDER THIS WARRANTY IS THE EXCLUSIVE REMEDY FOR THE CONSUMER. PHILIPS SHALL NOT BE LIABLE FOR ANY INCIDENTAL OR CONSEQUENTIAL DAMAGES FOR BREACH OF ANY EXPRESS OR IMPLIED WARRANTY ON THIS PRODUCT. EXCEPT TO THE EXTENT PROHIBITED BY APPLICABLE LAW, ANY IMPLIED WARRANTY OF MERCHANTABILITY OR FITNESS FOR A PARTICULAR PURPOSE ON THIS PRODUCT IS LIMITED IN DURATION TO THE DURATION OF THIS WARRANTY.

Some states do not allow the exclusions or limitation of incidental or consequential damages, or allow limitations on how long an implied warranty lasts, so the above limitations or exclusions may not apply to you. In addition, if you enter into a service contract agreement with the PHILIPS partnership within ninety (90) days of the date of sale, the limitation on how long an implied warranty lasts does not apply.

REMEMBER...

Please record the model and serial numbers found on the product below. Also, please fill out and mail your warranty registration card promptly. It will be easier for us to notify you if necessary.

MODEL # _____
SERIAL # _____

This warranty gives you specific legal rights. You may have other rights which vary from state/province to state/province.

(Warranty: 4835 710 27175) - itv 102504.1115

CLEANING & CARE

- To avoid possible shock hazard, please be sure that the television is unplugged from the electrical outlet before cleaning.
- When cleaning the television screen, take care not to scratch or damage the screen surface (avoid wearing jewelry or using anything abrasive). Wipe the front of the screen with a clean cloth dampened with water. Use even, easy, vertical strokes when cleaning.
- Gently wipe the cabinet surfaces with a clean cloth or sponge dampened in a solution of cool clear water. Use a clean dry cloth to dry the wiped surfaces.
- Occasionally vacuum the ventilation holes or slots in the cabinet back.
- Never use thinners, insecticide sprays, or other chemicals on or near the cabinet, as they might cause permanent marring of the cabinet finish.

END-OF-LIFE DISPOSAL

- This Philips Institutional Television product and its packaging contain materials that can be recycled and re-used. Specialized companies can recycle your product to increase the amount of reusable materials and minimize the amounts which need to be properly disposed.
- This product might also use batteries which should not be thrown away when depleted, but should be handed in and disposed of as small chemical waste.
- Please find out about the local regulations regarding the disposal of the television, batteries, and packaging materials whenever you replace existing equipment.

Philips, P.O. Box 671539, GA 30006-0026

INDEX

| | | | | |
|---|----|--|----|----|
| A | | M | | |
| ACTIVATING TV SETUP MENU | 10 | MAXIMUM VOLUME | 12 | |
| ANALOG CC MODE | 12 | MINIMUM VOLUME | 12 | |
| B | | P | | |
| BASIC TELEVISION CONNECTION | 6 | PICTURE FORMAT | 11 | |
| BEFORE CALLING SERVICE | 5 | PICTURE FORMAT MENU ITEM | 12 | |
| C | | POWER ON | | 11 |
| CAPTIONING | 12 | R | | |
| CAPTIONING OPTIONS | 12 | RC2888/01, GUEST REMOTE | 8 | |
| CLEANING & CARE | 19 | RC2573GR, SETUP REMOTE | 8 | |
| CONTROL OPTIONS | 11 | REAR JACK PANEL CONNECTIONS | 7 | |
| D | | REMOTE CONTROLS | | 8 |
| DEFINITIONS, ACRONYMS & ABBREVIATIONS | 17 | S | | |
| E | | SAVE CAPTIONING | | 12 |
| END-OF-LIFE DISPOSAL | 19 | SAFETY INFORMATION AND USEFUL TIPS | | 4 |
| ESP | 11 | SECURITY | | 11 |
| F | | SECURITY OPTIONS | | 11 |
| FIRMWARE UPDATE | 12 | SERVICE MENU | | 12 |
| FIRMWARE UPDATE CHANNEL | 12 | SOURCE MENU ITEM | | 11 |
| G | | SWITCH-ON CHANNEL | | 11 |
| GUEST REMOTE CONTROL KEYS | 9 | SWITCH-ON OPTIONS | | 11 |
| I | | T | | |
| IMPORTANT SAFETY INSTRUCTIONS | 3 | TABLE OF CONTENTS | | 2 |
| K | | TV SETUP MAIN MENU | | 10 |
| KEYBOARD LOCK | 11 | TV SETUP MENU & SUB-MENUS | | 11 |
| L | | TUNING MODE | | 11 |
| LIMITED WARRANTY | 19 | U | | |
| | | USE & CARE OF REMOTE CONTROL | | 6 |