

Contents

Installation

| | |
|--------------------------------------|---|
| Your remote control | 2 |
| Preparation | 3 |
| Installation | 3 |
| Search for and Store TV channels | |
| Select the menu language and country | 4 |
| Automatic installation | 4 |
| Manual installation | 5 |
| Give name | 6 |
| Reshuffle the programme list | 6 |
| Select favourite TV channels | 6 |
| Install TV setup | 7 |

Operation

| | |
|---------------------------|-------|
| Use of the remote control | 8-9 |
| Use of the menus | |
| Picture menu | 10 |
| Sound menu | 10 |
| Features menu | 11-12 |
| Teletext | 13-14 |

| | |
|-------------------------------------|--------------|
| Connect peripheral equipment | 15-18 |
|-------------------------------------|--------------|

| | |
|-------------|-----------|
| Tips | 19 |
|-------------|-----------|

| | |
|--------------|-----------|
| Index | 19 |
|--------------|-----------|

| | |
|----------------|-----------|
| Lexicon | 20 |
|----------------|-----------|



EasyLink features are based on the "one touch operation" approach. This means that a sequence of actions are executed at the same time in both the television and the video cassette recorder, **provided both are fitted with the EasyLink function and connected with the eurocable supplied.**

Your remote control

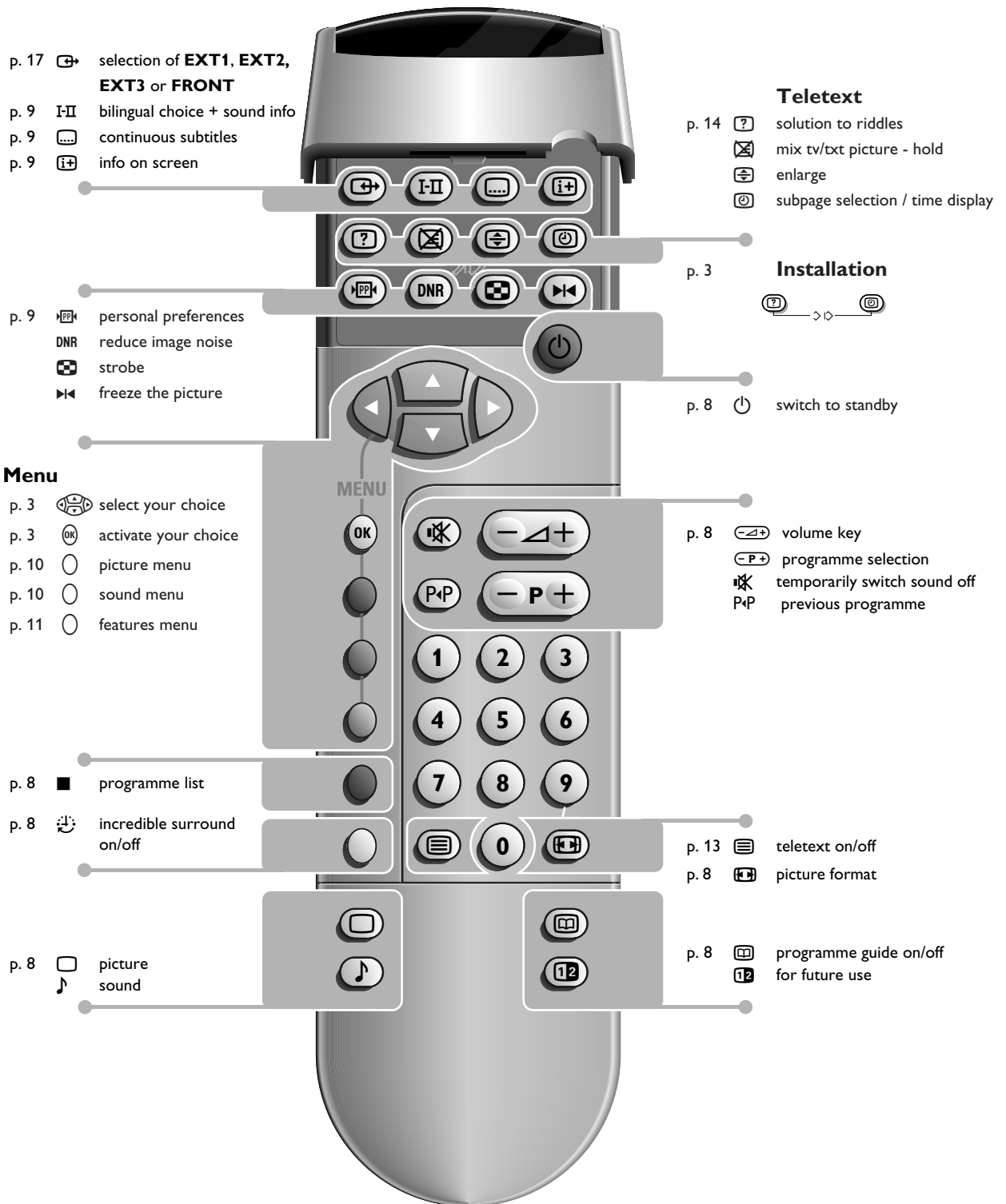

- p. 17 selection of **EXT1, EXT2, EXT3** or **FRONT**
- p. 9 bilingual choice + sound info
- p. 9 continuous subtitles
- p. 9 info on screen

- Teletext**
- p. 14 solution to riddles
 - mix tv/txt picture - hold
 - enlarge
 - subpage selection / time display

- p. 3 **Installation**
-

- p. 9 personal preferences
- DNR** reduce image noise
- strobe
- freeze the picture

- p. 8 switch to standby

Menu

- p. 3 select your choice
- p. 3 activate your choice
- p. 10 picture menu
- p. 10 sound menu
- p. 11 features menu

- p. 8 volume key
- programme selection
- temporarily switch sound off
- P4P** previous programme

- p. 8 programme list
- p. 8 incredible surround on/off

- p. 13 teletext on/off
- p. 8 picture format

- p. 8 picture sound

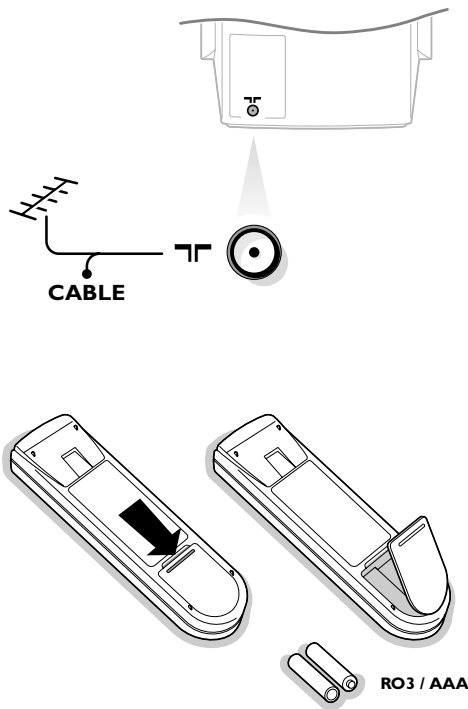

- p. 8 programme guide on/off for future use

Preparation



- ❶ **Place the TV on a solid surface.**
For ventilation, leave at least 5 cm free all around the TV.
To prevent any unsafe situation, do not place any objects on top of the TV.
- ❷ **Insert the aerial plug** tightly into the aerial socket  at the back of the TV. You can improve the picture quality by using the suppressor-aerial cable supplied.
- ❸ **Insert the mains plug** in the wall socket with a mains voltage of 220V - 240V.
- ❹ **Remote control:** Remove the cover of the battery compartment. Insert the 2 batteries supplied (type R03G-1,5V).



The batteries supplied do not contain the heavy metals mercury and cadmium. Nevertheless in many countries exhausted batteries may not be disposed of with your household waste. Please ensure you dispose of exhausted batteries according to local regulations.

- ❺ **Switch TV on :** Press the power switch  on the front of your TV.
A green indicator and the screen light up.
If the indicator is red, press the  key on the remote control.

*The green lamp blinks every time you press a key on the remote control. When you switch on your set **for the first time**, the menu **LANGUAGE** automatically appears on the screen. Alternatively the explanation appears in the different languages. Choose your own language and press the **OK** key on the remote control. Go on to page 4.*

Installation

Select the INSTALLATION menu :

- ❶ Open the door of the remote control.
- ❷ Press  and  at the same time.



To use the menus

- ❶ Use the  keys to select a menu item.
- ❷ Use the **OK** key to activate.
- ❸ Use the red **MENU** key to return or to switch menu off.

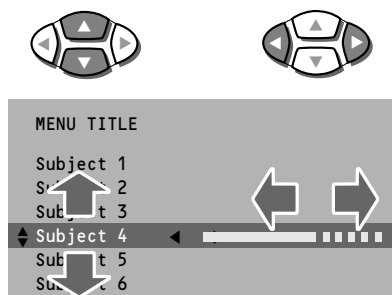
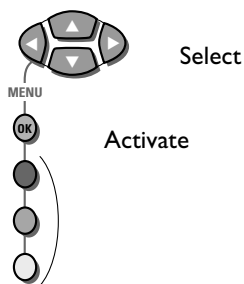

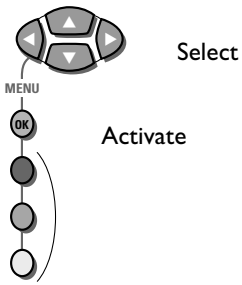

Store TV channels

Select the menu language and country

First, you have to select your language and your country.

- 1 Select the **Menu Language** and press the **OK** key.
- 2 Select your language and press the **OK** key.
- 3 Select **Country** and press the **OK** key.
- 4 Select the country where you are now located and press the **OK** key. Select **Other** when none of the countries applies.

You can now search for and store the TV channels in two different ways: using **automatic installation** or **manual installation** (tuning-in channel by channel).

- Select your choice and press the **OK** key.

*If the TV is connected to a video recorder with the EasyLink function, the TV automatically transfers the language and country selections to the video recorder. The message **EasyLink : Downloading** appears on the screen.*

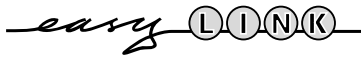

Automatic installation

In the Automatic Installation menu select **Start** and press the **OK** key to activate the searching. All TV channels are searched for and stored automatically.

If a cable system which broadcasts ACI (Automatic Channel Installation) or a TV channel transmitting a teletext page with the frequencies and programme names of all the TV channels which can be received, is detected, the search is stopped and a programme list appears. The programme list is automatically filled with all the programme numbers and names of the TV channels transmitted.

*It is possible that the cable company or the TV channel displays a broadcast selection menu. Layout and items are defined by the cable company or the TV channel. Make your choice with the keys and press the **OK** key.*

*If the TV is connected to a video recorder with the EasyLink function, the TV automatically transfers the stored TV channels to the video recorder. The message **EasyLink : Downloading Presets ...** appears on the screen. The programme list of the video recorder is now equal to the one of the TV.*



To exit from the menu

- Press the red **MENU** key.

Go on to page 6.

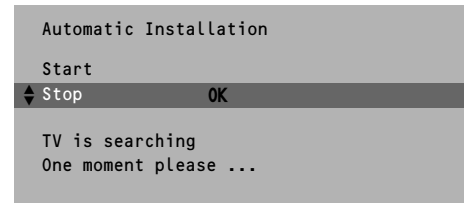
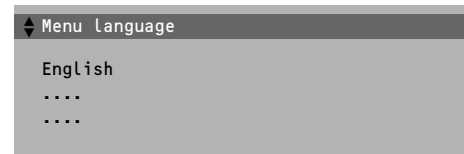

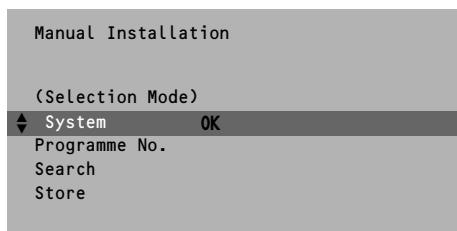

Manual installation

Searching for and storing TV channels is done channel by channel. You must go through every step of the Manual Installation menu.

Selection Mode is only present and lights up if the country you selected also offers the channel option (C-channels for aerial channels, S-channels for cable channels).

You can choose either channel or frequency mode.

1 Select the TV system

- Select the country or part of the world from where you want to receive the TV channel.
- If you are connected to a cable system, select your country.

2 Enter the programme number with the digit keys.

3 Search for a TV channel

The frequency or the channel number increases until a TV channel is found. In case of poor reception, you can improve the reception by adjusting the frequency with the **←P→** key.

Direct selection of a TV channel

If you know the frequency, or the C- or S-channel number, enter it directly with the digit keys 0 to 9.

Ask for a list from your cable company or dealer, alternatively consult the Table of frequencies on the inside backcover of this handbook.

4 Store steps 1 till 3

- Select **Store** and press the **OK** key.



*After the new or extra TV channel has been stored, the TV automatically transfers that (those) TV channel(s) to the video recorder provided with the EasyLink function. The message : **EasyLink : Downloading Presets ...** appears on the screen. The programme list of the video recorder is now equal to the one of the TV.*

Repeat every step to store another TV channel.

To exit from the menu :

- Press the red **MENU** key.

Give name

It is possible to change the name stored in the memory or to assign a name to a TV channel which has not yet been entered. A name with up to 5 letters or numbers can be given to the programme numbers 0 to 99. For example SUPER, BBC1,... Between 99 and 0 you can also name any peripherals that are connected.

- 1 Select **Give Name** in the **INSTALLATION** menu and press the **OK** key.
- 2 Select the programme number.
- 3 Press the **OK** key.
- 4 Select the character with the \uparrow \downarrow keys.
- 5 Select the following position with the \leftarrow \rightarrow keys.
- 6 Select the following character.
- 7 Press the **OK** key when finished.
- 8 Press the red **MENU** key to return to the **INSTALLATION** menu.

A space, numbers or other special characters are located between Z and A.

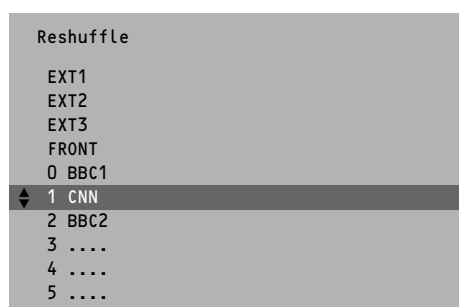
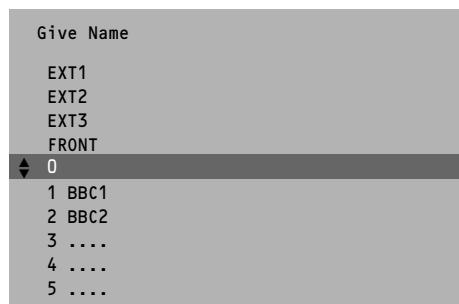
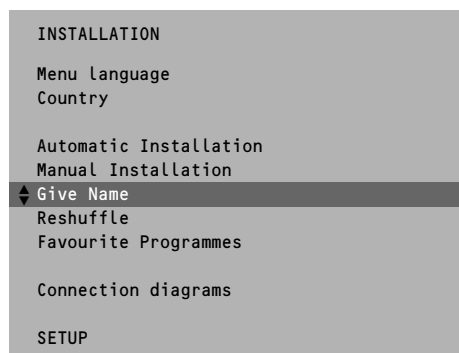

Reshuffle the programme list

According to your preference you **can** change the order of the stored TV channels.

- 1 Select **Reshuffle** in the **INSTALLATION** menu and press the **OK** key.
- 2 Select the programme number you want to change.
- 3 Press the **OK** key.
- 4 Select the new number.
- 5 Press the **OK** key.
Repeat the operation until all TV channels are allocated as you like.
- 6 Press the red **MENU** key to return to the **INSTALLATION** menu.

Select Favourite TV channels

After leaving the installation you can browse through the TV channels by pressing the \leftarrow \rightarrow key. Only those TV channels which are in the favourite list will be displayed. The non-favourite TV channels can still be selected with the digit keys.

- 1 Select **Favourite Programmes** in the **INSTALLATION** menu and press the **OK** key.
- 2 Select your favourite programme number.
- 3 Select **Yes** or **No**.
- 4 Repeat for every TV channel you want to change into a favourite or a non-favourite TV channel.
- 5 Press the red **MENU** key to return to the **INSTALLATION** menu.

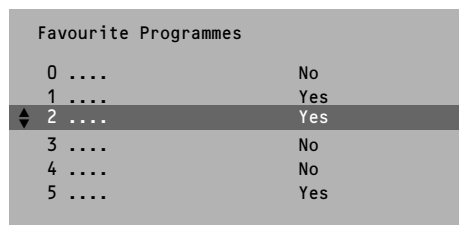

If the TV is connected to a video recorder with the EasyLink function, the TV automatically transfers the reshuffled or modified TV channels to the video recorder. The message **EasyLink : Downloading Presets ...** appears on the screen. The programme list of the video recorder is equal again to the one of the TV.



Connection diagrams

See Connect Peripheral Equipment, p. 15.

Install TV Setup

- 1 Use the  keys to select the menu item.
- 2 Use the **OK** key to activate.
- 3 Use the red **MENU** key to return or switch menu off.

CD-i / Photo CD

See Connect Peripheral Equipment, TV and a CD-i / Photo CD, p. 16.



Define Decoder/Descrambler programme numbers

If you have connected a decoder or a descrambler, see p. 15, you can define one or more programme numbers as decoder programme numbers.

- Press the  keys to select **Off**, **EXT1** or **EXT2**, the euroconnector where you connected your decoder.
- Select **Off** if you do not want the selected programme number being activated as a decoder programme number.

Select **EXT2** when the decoder is connected to your EasyLink video recorder.
When selecting the decoder, the message **EasyLink: Downloading Presets....** appears on the screen.

Picture Tilt (only for 32" or 82 cm sets)

- Select **Picture Tilt** with the  keys.
- Keep the  keys pressed to adjust the rotation of the picture.

Information Line

After the selection of a TV programme or after pressing the  key on the remote control, a TV channel which broadcasts teletext may transmit the name of the TV channel or the programme name or another message which appears briefly in the information line on the screen.

When selected **Off**, the information line will only appear after pressing the  key, and not after the selection of a TV channel.

Auto Format

Selecting **Auto Format Yes**, the screen will automatically be filled as much as possible with the picture in case of no PALplus transmission or when TV programmes are not carrying special signals detecting the correct screen format.

With the  key on the remote control you can still select other picture formats (see p. 8).

Installation

Select **Installation** and press the **OK** key to return immediately to the **INSTALLATION** menu.

To exit from the menu

- 4 Keep the red **MENU** key pressed.

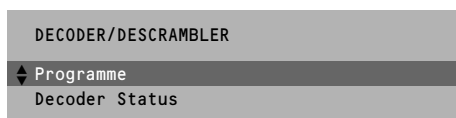
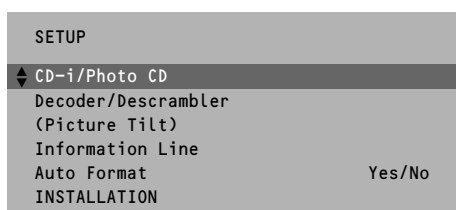
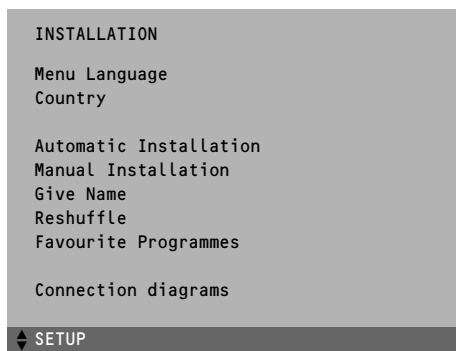

Standby

The TV set is switched off and the red indicator lights up.
To switch the TV on again, press  or the digit keys.

Your TV consumes energy in the standby mode. Energy consumption contributes to air and water pollution. We advise to switch off your TV overnight instead of leaving it on standby. You save energy.



Mute key

Temporarily interrupt the sound or restore it.

P+P Previous programme

The previously selected TV channel is displayed.
The  indication has a video recorder function.

Programme list

To select the programme list.
Select the desired TV channel with the  or  keys and press **OK**.

Incredible Surround

In **MONO** sound mode, this feature, when switched on, enables you to hear a spatial effect of sound.

In **STEREO** sound mode, when **Incredible Surround On** is selected, it seems as though the loudspeakers are spread further apart from one another.

Smart Controls keys

To select predefined picture and sound settings.

Smart Picture (key)

Each time it is pressed, a different picture setting is selected, corresponding with a specific predefined setting of Contrast, Colour, Sharpness and Dynamic contrast.

Smart Sound (key)

Each time it is pressed a different sound setting is selected, corresponding with a specific predefined setting of Treble, Bass and Loudness.

Personal refers to the personal preference setting of picture and sound which you have stored with **Store PP** in the Features menu, p. 11.

The smart picture and sound settings are set to **Manual** until the personal adjustments are stored.

Use of the remote control

Volume

The volume is adjusted. If you want to store the volume adjustment in the memory, see the Features menu, Store PP, p. 11 to store the same volume adjustment for all the stored TV channels.



Programme selection

To browse through the TV channels activated in the Favourite Programme menu. See p. 6.

0 / 9 Digit keys

To select a TV channel.
For a two digit programme number, enter the second digit within 2 seconds.

Picture format

Press this key repeatedly to select another picture format: 4:3, Movie Expand 14:9, Movie Expand 16:9 with or without subtitling, Wide Screen, Automatic (in case Auto Format Yes has been selected in the **SETUP** menu) or Super Zoom, When in Movie Expand 14:9 or 16:9 picture format you can make subtitles visible with the  or  keys.



When the broadcaster transmits PALplus signals, the Movie Expand 16:9 picture format is selected automatically.





Sometimes video recorders or TV programmes carry special signals which will automatically switch the TV to the correct screen format. Selecting Auto format, the screen will be filled as much as possible with the picture in case of no PALplus transmission or when TV programmes are not carrying special signals detecting the correct screen format.

12 For future use

Programme Guide

TV channels which broadcast teletext also transmit a page with the programme guide of the day. For each TV channel you can store the programme guide page which can be selected directly with the  key.

- Press  to switch on teletext and select the proper programme guide page.
- Press  for 2 seconds to store the selected page.
- Press  again to switch off teletext.

Every time you press the  key, the programme guide page of the selected TV channel will be available. Press   or the  key to run through the previous or the following pages and subpages. Press the  key again to switch the page off.

For every TV channel the programme guide page should be stored separately.

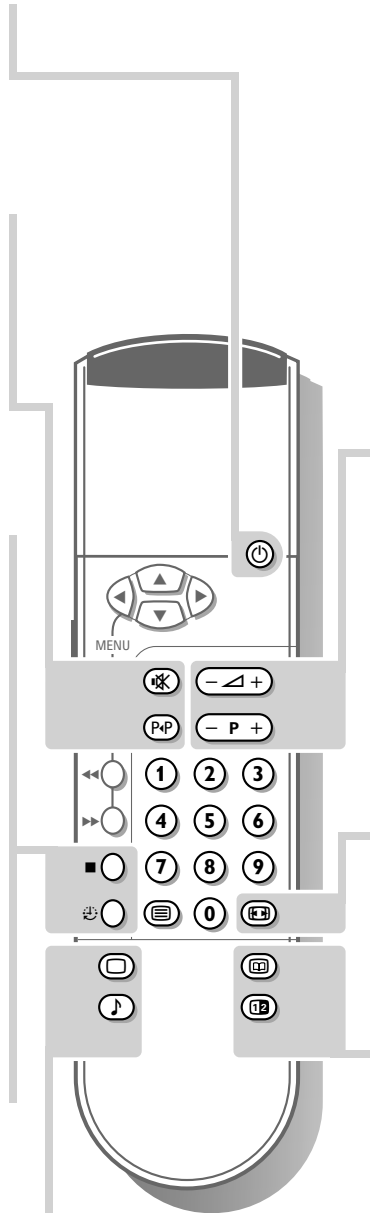

Select peripherals

Press this key repeatedly to select **EXT1**, **EXT2**, **EXT3** or **FRONT**, according to where you connected your peripherals (see p. 17).

I-II Bilingual choice and sound mode selection

Press this key

- to switch from **Stereo** to **Mono** sound, in case of stereo transmission, or from **Digital Sound** to **Digital Sound available**, in case of digital transmission;
- to choose between language I (Dual I) or language II (Dual II), in case of bilingual transmission.

The setting is stored for each TV channel separately.

Time display

The time, downloaded from the TV channel (with teletext) stored on programme number 1 or under the lowest favourite programme number, is displayed on the screen.

This function is not available when continuous subtitles have been switched on.

Personal Preferences

Restore picture and sound settings, stored in the features menu (see p. 11).

DNR Dyn. Noise Reduction

To reduce the image noise and improve picture quality when receiving weak signals.

Press this key to select **Minimum**, **Medium** (optimum picture quality for normal strength signal), **Maximum** (for poor picture quality) or **Off**.

DNR can be individually set for each TV channel.



Continuous subtitles

TV channels with teletext often transmit certain programmes with subtitling. Switch on teletext and select the proper subtitle page from the index.

Press  to store the subtitle page.

Switch off teletext.

Every time a programme of the selected TV channel is subtitled, the subtitling will be available **for that TV channel**.

Press  to switch the subtitles **On** of **Off**. When switched on and only the subtitle symbol appears, there are no subtitles available for that programme.

Screen information

Press for 5 seconds to activate/de-activate extended or reduced display of TV channel and programme information on the screen.

Press briefly to display information about the selected TV channel and programme, the sound reception, the selected DNR setting and picture format and the remaining time set with the sleep timer.

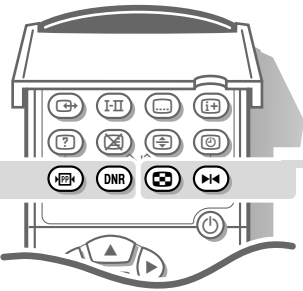

Strobe

Press this key to reproduce the picture image by image.

Press the **OK** key to have a faster speed.

Press  again to switch off the strobe function.

Freeze

To activate/de-activate the frozen picture.

Use of the menus

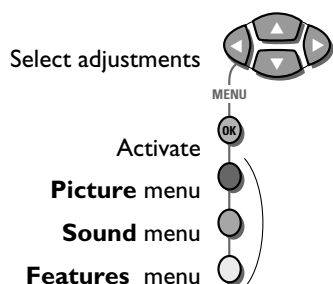

- ❶ Press the red, green or yellow colour key to display/cancel the **PICTURE**, **SOUND** or **FEATURES** menu .
- ❷ Use the keys to select the menu item.
- ❸ Use the **OK** key to activate.
- ❹ Press the same colour key to return or to switch menu off.

Picture menu

When you are watching a TV channel in the NTSC-system, or if a NTSC peripheral is connected to one of the euroconnectors, the option Hue also appears and can be adjusted.

Sharpness

You can adjust the Sharpness for each TV channel separately.

Tint

- Select the colour temperature: **Normal**, **Warm** or **Cool**.

Digital Scan (Line Flicker Reduction)

In certain circumstances while watching TV programmes it may be preferred to switch off the digital scan line flicker reduction.

- Press the keys to select **On** or **Off**.

Dynamic Contrast

To make the contrast between darker and brighter picture parts more noticeable, select the **Med** setting.

In certain circumstances it may be preferred to select **Min** or **Off**.

- Store the modified adjustments for Contrast, Brightness, Colour, Tint, Digital Scan and Dynamic Contrast for all TV channels with **Store PP** in the **FEATURES** menu.

Sound menu

Switch Loudness on or off

When Loudness On is selected, the low and high frequencies are amplified so that the natural balance is restored when listening at a low volume.

The selected setting for Loudness is stored for all TV channels.

Headphone

See Connect Peripheral Equipment, p. 16 for the connection of the headphone.

- Select **Dual** to choose between the dubbed or original language when the TV channel broadcasts in 2 languages.
- Store the modified adjustments for Volume, Balance, Treble and Bass for all TV channels with **Store PP** in the **FEATURES** menu.

To exit from the menus

- Press the corresponding red, green or yellow colour key.

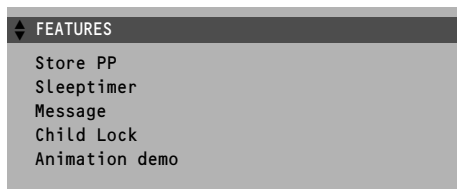
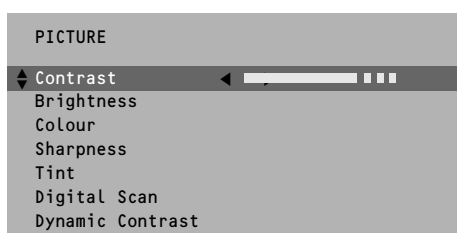

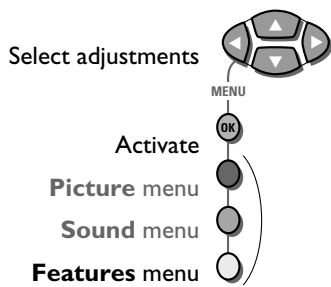

Features menu

- 1 Press the yellow colour key to display/cancel the **FEATURES** menu.
- 2 Use the keys to select the menu item.
- 3 Use the **OK** key to activate.

Store PP

The adjustments of Contrast, Brightness, Colour, Tint, Digital Scan and Dynamic Contrast made in the picture menu and the adjustments of Volume, Balance, Treble, Bass and Loudness made in the sound menu can be stored in memory for all the TV channels.

Sleeptimer

With the sleeptimer you can set a time period after which the TV should switch itself off to standby. The counter runs from **Off** up to **180 min.** or from **180 min.** down to **Off**. One minute before the TV is set to go to standby, the remaining minute appears on screen. You can always switch off your set earlier or change the set time.

Child Lock

If the child lock is on, the TV can only be switched on with the remote control. The - and + keys on top of the TV cannot be used to select a TV channel. In this way you can prevent unauthorised use of your TV. If the message **Child Lock On** appears, the child lock must be switched off before you can use the - and + keys on the TV to select a TV channel.

Animation demo

Selecting this menu item starts a continuous loop of an animation introducing your TV. This animation has no operational function. Press the **OK** key to stop the animation.

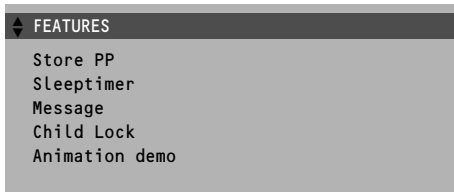

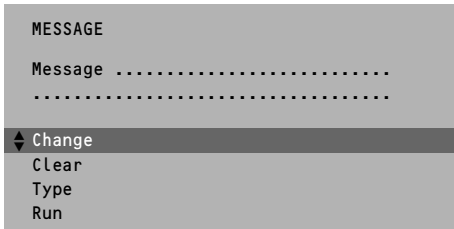
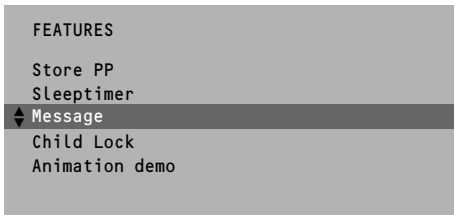

Message

With this function you can enter a personal message on 2 lines which will be displayed automatically when the set is switched on from standby.
For example: I'll be late this evening. Don't wait for dinner.

Change

- Select with the keys the letter or number you want to enter.
- Select with the key the next position.
- Press the **OK** key when you have entered the complete message.

Clear

- Press the **OK** key to remove a previous message.

Type

- Press the keys to select the way the message will be displayed : **Wipe**, **Slide**, **Fall** or **Fade**.

The Fade display is a randomly selection of the three other display types.

Run

- Press the keys to select the display frequency : **Continuous**, **Once** or **No**.

Display message

- Switch the TV to standby.
The message appears on the screen when the TV is switched on again.
If you selected **Once**, the message will disappear from the screen after 30 seconds.
If you selected **Continuous**, the message will appear on the screen until the display frequency is switched off in the Message menu.
The message does NOT appear when Continuous Subtitles have been switched **On**. See p. 9.

The keys on top of the TV

Should your remote control be lost or broken you can still change some of the basic picture and sound settings with the keys on top of the TV.

- Press the **MENU** key repeatedly to select **Volume**, **Brightness**, **Colour**, **Contrast**, **Treble** or **Bass**.
- Press the - or + key to regulate the selected adjustment.
When the menu adjustment is not displayed, the - and + keys enable you to select the TV channels.

The selected adjustment automatically switches off when after 10 sec. no action has been executed.

Teletext

Most TV channels broadcast information via teletext. Each channel which broadcasts teletext transmits a page with information on how to use its teletext system. Look for the teletext page with the main index (usually p. 100).

Depending on the TV channel, teletext is transmitted in different systems. The colours used in the options line correspond with the colour keys of your remote control.

About the Easy Text system

The Easy Text system considerably reduces the waiting time (on condition the teletext broadcast of the particular TV channel is switched on for at least half a minute) by :

- a **direct selection** of previous and following pages which are in transmission and of the pages referred to in the options line
- a **habit watcher list**: frequently used pages are put in a list of preferred pages, so that they are immediately available afterwards
- the **precapturing of the page numbers** referred to in the displayed page
- the **precapturing of all the subpages**.

Switch Teletext on and off

- Press  to switch on or off the teletext. The main index page appears on the screen together with two information lines at the top and one option line at the bottom of the screen.

Select a Teletext page



With the digit keys

- Enter the desired page number with the digit keys. The page counter seeks the page or the page appears immediately when the page number has been stored in the memory.
A message appears when you have entered a non existent or an incorrect page number. Page numbers beginning with 0 or 9 do not exist. Choose another number.

With the option line

- Select with the colour keys, corresponding to the coloured options at the bottom of the screen, the desired subject.

Quickly run through the teletext pages

- Press   or the  key to run through the previous or the following pages.

Select the previously selected txt page

- Press the P&P key.

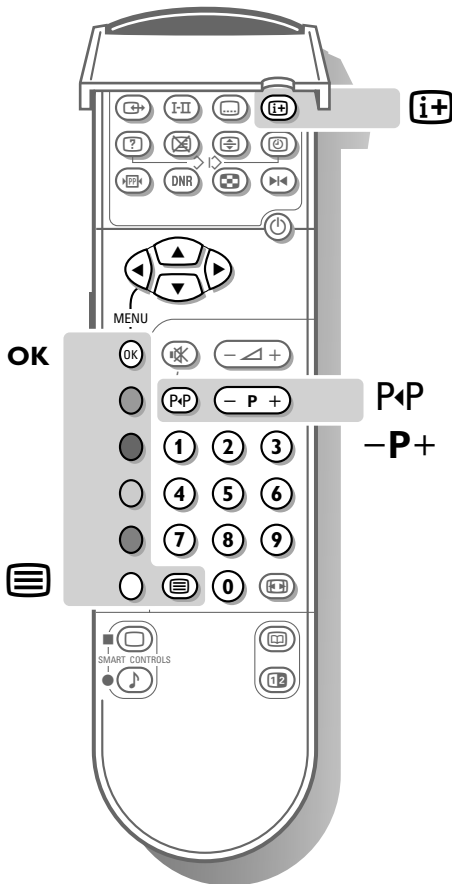

Select the index teletext page

- Press the white colour key to display the main index (usually p.100).

Only for T.O.P teletext broadcasts :

T.O.P orders the pages in categories and adds other possibilities of enhancing ease of use.

- Press **i+**. A T.O.P. overview of the teletext subjects available appears. Not all TV channels broadcast T.O.P. teletext. When the teletext system is not T.O.P. teletext, a message appears at the top of the screen.
- Select with the **◀ ▶** keys the desired subject and press the **OK** key.

Select subpages

When a selected teletext page consists of different subpages, one of the subpages appears on the screen.

The coloured number in the first information line refers to the displayed subpage.

The other subpages can be selected in 2 ways :

1. With the **◀ ▶** keys.

The other subpage numbers appear in white as soon as the transmission has found them. They are stored in the memory so that they are available while the teletext page is on screen.

- Select with the **◀ ▶** keys the previous or the following subpage.

2. With the **Ⓢ** key.

Enter the subpage number yourself.

- Press **Ⓢ**. Enter the desired subpage with the digit keys : e.g. 3 for the third page of seven subpages. The TV searches for the selected subpage.

Automatically rotating subpages:

- Press **Ⓢ** again to cancel the entered digit for the subpage. Now the subpages rotate automatically.
- Press **Ⓢ** again to select the subpages with the **◀ ▶** keys again.

Special teletext functions

Mix / Interrupt

- Press **⊗** to overlay the teletext page on the TV programme.
- Press **⊗** again to de-activate the screen overlay. The display **≡** indicates that you are still in the teletext mode. You can select a page number. When the page has been found, the page number appears on the screen.
- Press **⊗** again to display the teletext page.

Enlarge

- Press **⊞** repeatedly to display the upper part, the lower part and then to return to the normal page size. When the upper part is displayed, you can scroll the text line per line by using the **⏪ ⏩** keys.

Reveal

- Press **?** to reveal/conceal the hidden informations, such as solutions to riddles and puzzles.

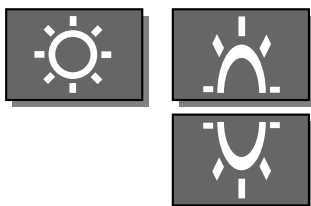
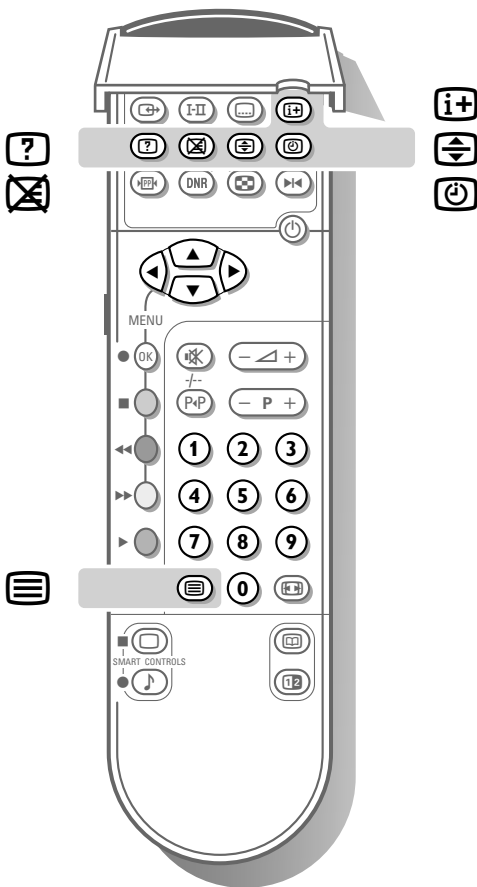

Connect Peripheral Equipment

| CONNECTION DIAGRAMS |
|---------------------|
| Amplifier |
| CD-i/Photo CD |
| Decoder/Descrambler |
| VCR1 |
| VCR2 |
| Antenna |

There is a wide range of audio and video equipment that can be connected to your TV. The following connection diagrams show you how to connect it. See also the menu item Connection diagrams in the **INSTALLATION** menu where the different connection possibilities are shown. Each time a menu item is selected a graphic is shown of the connection. Those graphics have no operational function.

Video recorder

- Connect the aerial cables ①, ② and, to obtain a better picture quality, eurocable ③ as shown opposite.

*If your video recorder is provided with the EasyLink function, the eurocable supplied with it, should be connected to **EXTERNAL 2** to benefit from the EasyLink functionality.*

You have to do the following if you do not connect the eurocable ③.

Search for and store the test signal of the video recorder

- Unplug the aerial cable ① from the aerial socket of your video recorder.
- Switch on your TV and put the video recorder on the test signal. (See the handbook for your video recorder.)
- Search for the test signal of your video recorder in the same way as you searched for and stored the TV signals. See Installation, Searching for and storing TV channels, Manual Installation, p. 5.
- Store the test signal either under programme number 0 or between 90 and 99.
- Replace the aerial cable in the aerial socket of your video recorder after you have stored the test signal.

Decoder and video recorder

- Connect a eurocable ④ to your decoder and to the special euroconnector of your video recorder. See also the video recorder handbook. See Define Decoder/Descrambler prog. numbers, p. 7. You can also connect your decoder directly to **EXTERNAL 1** or **2** with a eurocable .

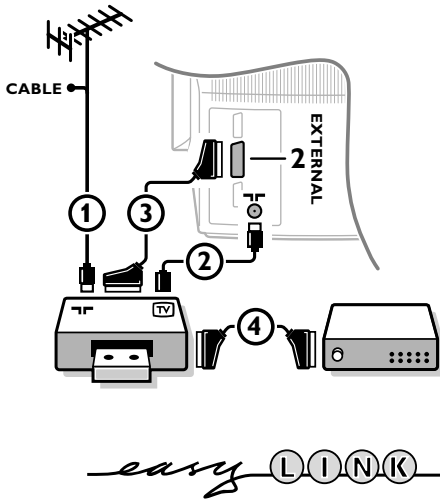

Video recorder and other peripherals (except CD-i/Photo CD)

- Connect the aerial cables ①, ② and ③ as shown opposite. Better picture quality can be obtained if you also connect eurocable ⑤ to **EXTERNAL 2** and a eurocable ④ to **EXTERNAL 1** or **3**.
- Look for the test signal of your peripheral in the same way as you do for a video recorder.

When a video recorder is connected to **EXTERNAL 1** you can only record a programme from your TV.

Only when a video recorder is connected to **EXTERNAL 2** it is possible to record a programme from your TV as well as from other connected equipment. See Record with your video recorder, p. 18.

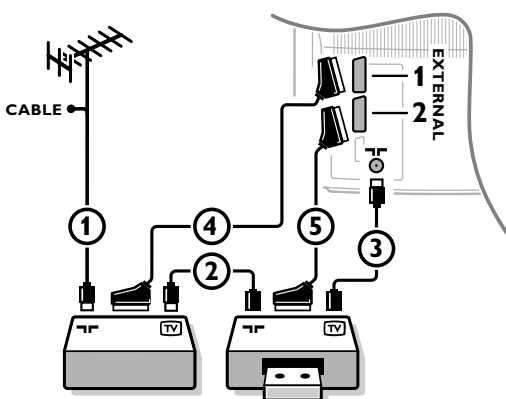

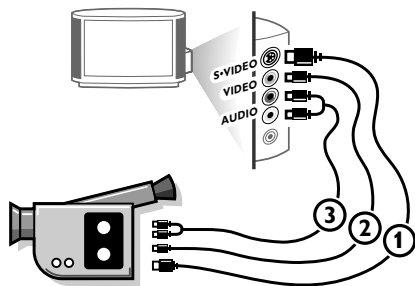

Camera and camcorder

- Connect your camera or camcorder at the right side of your TV.
 - Connect the equipment to **VIDEO** (2) and **AUDIO L** (3) for mono equipment.
 - Press the **I-II** key under the door of the remote control repeatedly to select the sound coming from one or both loudspeakers of your TV.
 - For stereo equipment, also connect **AUDIO R** (3).
- S-VHS quality with a S-VHS camcorder is obtained by connecting the S-VHS cables with the **S-VHS** input (1) and **AUDIO** inputs (3).

Other equipments

Connect the eurocable (1) to **EXTERNAL 1** as shown opposite.

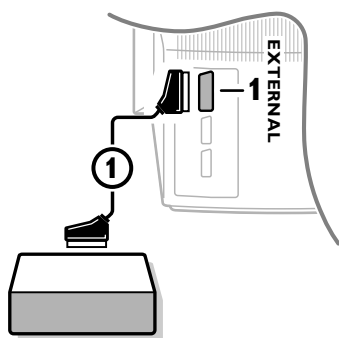

Only for CD-i and Photo CD :

- Press **[?]** and **[⊕]** at the same time.

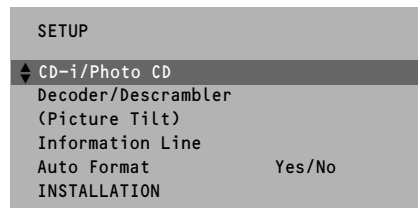

- Select **CD-i/Photo CD Present** in the Setup menu of the **INSTALLATION** menu. This offers you optimum picture quality for your CD-i or Photo CD.
- Keep the red **MENU** key pressed to switch off all menus.

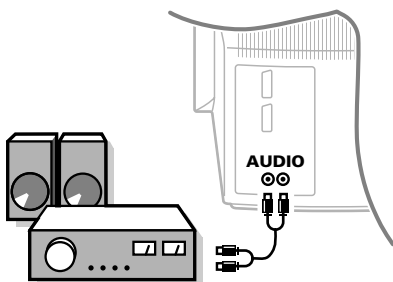

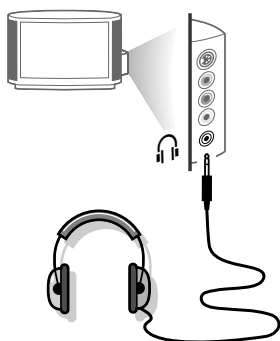

Audio equipment / Amplifier

- Connect the audio cables to the audio input of your audio equipment and to **AUDIO L** and **R** at the back of your TV. You can listen to your TV sound via your audio equipment.



Headphone

- Insert the plug into the headphone socket  at the right side of the TV.
- Press  on the remote control to switch off the internal loudspeakers of the TV.

The headphone impedance must be between 8 and 4000 Ohm. The headphone socket has a 3.5 mm jack.

In the **SOUND** menu select **Headphone** to adjust the headphone volume and to select dubbed or original language (when the TV channel broadcasts in two languages) for your headphone sound. See p. 10.

If you want to connect more equipment to your TV, consult your dealer.

To select connected equipment

easy LINK

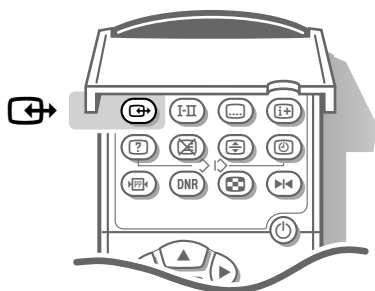

If the TV is connected to a video recorder with the EasyLink function, in some cases the TV will be switched on, even when the TV was in standby. (E.g. playback tape,...) This is not possible when Child Lock On is selected.

Equipment connected with an aerial cable only :

- Select the programme number under which you have stored the test signal with the digit keys.

Equipment connected to a euroconnector or to the right side of the TV

- Press the  key repeatedly to select **EXT1**, **EXT2**, **EXT3** or **FRONT**, according to where you connected your equipment at the back or the right side of your TV.

Remark : Most equipment (decoder, video recorder) carries this switching itself.

Do you want to watch TV channels again ?



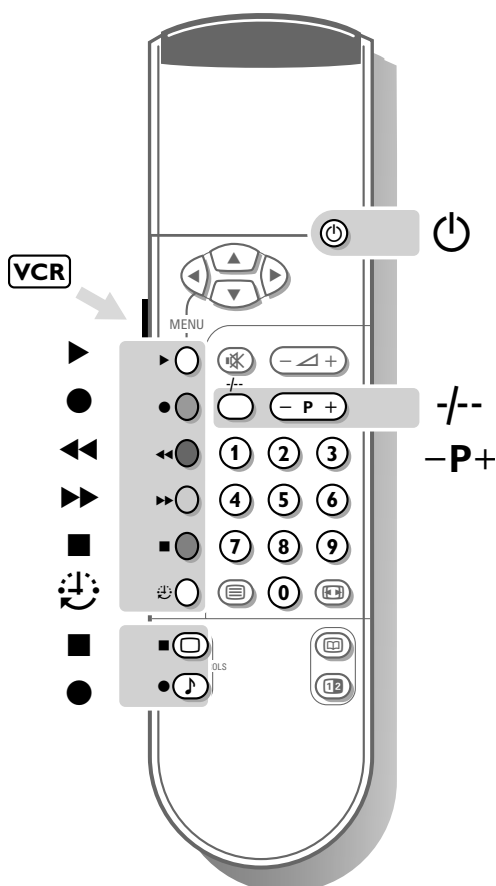













- Enter the programme number of the TV channel which you want to watch with the digit keys.



Video recorder keys



Most of the video equipment from our range of products can be operated with the remote control of the TV.

Press simultaneously on the **VCR** key and:

-   for play,
-   for record,
-   for rewind,
-   for fast forward,
-   for stop,
-   for programming (on certain models),
-   for selecting 1- or 2- digit programme numbers from the video recorder tuner,
-  for fast programme selection from the video recorder tuner,
- 0 to 9** to select a programme number from your video recorder tuner,
-  to switch the video recorder to standby

These keys function with video recorders which use the RC5 signalling standard.

easy LINK

If your video recorder has the EasyLink function the   and   keys for record and stop can be operated in the TV mode.

Record with your video recorder without EasyLink

To record S-VHS quality, connect a S-VHS peripheral directly to the video recorder.

1. Record a TV programme

using only an **aerial cable**

- Select the programme number on your video recorder.
- Set your video recorder to record.
(See the handbook for your video recorder.)

Switching programme numbers on your TV does not disturb recording !

using a **eurocable** connected to the euroconnector **EXTERNAL 2**

With a video recorder connected to EXTERNAL 2 it is possible to record a programme from your TV as well as from other connected equipment.

- Select the programme number or external input on the TV.
- Select the right external on your video recorder.
- Set your video recorder to record.
You record what you are watching on the screen.

Do not switch programme numbers or do not switch off your TV when you are recording !

using a **eurocable** connected to the euroconnector **EXTERNAL 1**

With a video recorder connected to EXTERNAL 1 you can only record a TV channel.

- Select the programme number on the TV.
- Set your video recorder to record.

Switching to a programme from a connected peripheral equipment does not disturb recording .

2. Record a programme on your video recorder connected to **EXTERNAL 2** from Audio/Video equipment connected to **EXTERNAL 1**, **EXTERNAL 3** or to the right side

- Switch on the equipment.
- Select the right external on your video recorder.
- Set your video recorder to record.
You record what you are watching on the screen.

Do not switch programme numbers or do not switch off your TV when you are recording !

Record with a video recorder with EasyLink



If you have connected a S-VHS video recorder provided with the EasyLink function, you can record S-VHS-quality from a S-VHS peripheral connected to the right side of the TV. (E.g. from a S-VHS camcorder.)

In TV mode it is possible to start a direct recording of the programme which is being displayed on the TV screen.

- Press at the same time the **VCR** key on the left side and the  key of the remote control.

The video recorder switches on when it was in standby and a message of what is being recorded appears at the bottom of the screen.

The video recorder starts recording the programme that appears on the screen.

- Press the  key to stop the recording.

*When recording a programme from a peripheral connected to **EXTERNAL 1** or **FRONT**, you can not select another TV programme on the screen.*

To watch TV programmes again, press the programme number you want to select twice . Then the recording is stopped and your video recorder switches to standby.

*If you switch to standby during recording a programme from a peripheral connected to **EXTERNAL 1** or **FRONT**, the blinking red lamp on the front of your TV indicates that you are still recording. The blinking stops after the recording is finished.*

Tips

Care of the screen

Clean the TV with a slightly damp soft cloth. Do not use abrasive solvent as it can damage the TV screen.

Poor Picture

Have you selected the correct TV system?

Is your TV or house aerial located too close to loudspeakers, non-earthed audio equipment or neon lights, etc. ?

Mountains or high buildings can cause double pictures or ghost images.

Sometimes you can improve the picture quality by changing the direction of the outside aerial.

Is the picture or teletext unrecognisable?

Check if you have entered the correct frequency. See Installation, p. 5.

Are brightness and contrast out of adjustment ? Press the  key.

Sometimes poor picture quality is possible when having activated a S-VHS camera or camcorder connected to the right side of your TV and another peripheral is connected to **EXT1** or **EXT2** at the same time. In this case switch off one of the other peripherals.

No picture

Is the aerial connected properly ? Are the plugs tightly connected in the aerial socket?

Is the aerial cable in good condition and does it have suitable plugs ? Are the connection facilities to a possible second TV in good condition ? If in doubt, consult your dealer.

Remote control

If your TV no longer responds to the remote control, the batteries may be dead.

You can still use the Menu key and the **-/+** keys at the top of your TV.

Menu

Have you selected the wrong menu ? Press the same key again to exit from the menu.

No solution

Switch your TV off and then on again.

Never attempt to repair a defective TV yourself.

Check with your dealer or call a TV technician.

End of life directives

Your new TV contains materials which can be recycled and reused.

At the end of life specialised companies can dismantle the discarded TV to concentrate the reusable materials and to minimise the amount of materials to be disposed of.

Please ensure you dispose of your old TV according to local regulations.

How to dispose of dead batteries ?

The batteries supplied do not contain the heavy metals mercury and cadmium.

Nevertheless in many countries dead batteries may not be disposed of with your household waste. Please ensure you dispose of dead batteries according to local regulations.

Index

a automatic installation, 4
ACI, 4
b bilingual broadcast, 9
c camcorder, 16
CD-i / Photo CD, 16
child lock, 11
clock, 9
country, 4
d decoder/descrambler, 7
digital, 9
digital scan, 10
DNR, 9
dynamic contrast, 10
e easy text, 13
eurocable, 15
f favourite programmes, 6
freeze, 9
frequency, 5
g give name, 6

h headphone, 16
hue, 10
i Incredible Surround, 8
info on screen, 9
information line, 7
interrupt the sound, 8
l language, 4
loudness, 10
m manual installation, 5
menu language, 4
message, 12
p personal preferences, 9
picture adjustments, 10
picture format, 8
programme guide, 8
programme list, 8
r recording, 18
reshuffle, 6
s search for TV channels, 5

setup, 7
sleep timer, 11
smart picture and sound, 8
sound adjustments, 10
sound mode, 9
stereo, 9
store PP, 11
store TV channels, 4
strobe, 9
subpages teletext, 14
subtitles, 9
S-VHS, 18
switch TV on, 3
t teletext, 13
v video recorder, 15
volume, 8

Lexicon

100 Hz

100 Hertz provides a superior solution to the problem of picture flicker which is particularly noticeable with larger screen sizes. In a conventional TV, the picture area is scanned 50 times a second (50 Hertz) – a frequency which is still detectable by the human eye in the form of a flickering picture. In 100 Hertz sets, the picture area is scanned at a rate of 100 times per second (100 Hertz). At this frequency, the eye cannot detect flicker, resulting in a clearer picture which is more relaxing to the eye.

Automatic Channel Installation (ACI)

Automatically installs all TV channels in the same order as offered by your cable company, provided of course that the data is transmitted. It also automatically includes programme number and programme name. With ACI, channel installation is fully automatic, simple and fast.

Child Lock

Feature to prevent children from viewing unwanted channels.

Digital Scan

If you look at a television screen you will see small imperfections in the picture caused by line vibration. Digital Scan (an internal process) removes interline flicker. When combined with 100 Hz, you will see a totally stable image.

DNR

Digital Noise Reduction. By encoding signals digitally in 100 Hz sets with Digital Scan it is possible to clean up picture noise. This is especially beneficial in poor signal areas and when viewing poor quality video tapes.

Easy Link

Digital 'intelligent' ESI bus-system between audio components in HiFi systems and between TV and VCR. (Scart connection required). Turns source selection and control into a one-button operation.

Easy Text

Teletext memory that automatically memorises Teletext pages and gives you instant access to them.

Euroconnector

A 21-pins connector system enabling you to simply connect various types of audio/video and computer equipment.

Incredible Surround

Feature to enrich the sound performance of your TV set or audio equipment. It enhances the stereo effect by giving the impression that the speakers are positioned much wider apart than they actually are.

Menu

On-screen display of functions and facilities in a well-organised survey, which you can select using your remote control.

NTSC

The broadcasting system used in the USA, Japan and parts of South America and Southeast-Asia.

Smart Picture and Sound Controls

Keys on the remote control to select predefined picture and sound settings.

Sleeptimer

Function with which you can set a time period after which the TV should switch itself off to standby.

Picture Freeze

TV mode which allows you to "freeze" a certain image in order to study a specific detail at ease, e.g. to make notes of certain programme information like phone numbers.

Teletext

See also Easy Text
WST: World Standard Teletext.
FLOF: Full Level one Features. System applied by the BBC, RVE... that provides a fast access to the teletext pages.
TOP: Table of (Teletext) Pages. German system for an easy access to the teletext pages.

Tint (or Hue in NTSC)

TV-function to modify the general colour balance between cool and warm and to adjust it according to your personal preference.