

Contents

Installation

- Your remote control **2**
- Preparation **3**
- Installation **4**
- Store TV channels **4**
 - Select the menu language and country **4**
 - Automatic installation **5**
 - Manual installation **5**
- Give name **6**
- Reshuffle the programme list **6**
- Select favourite TV channels **6**
- Install TV setup **7-8**

Operation

- Use of the remote control **9-11**
- Use of the menus
 - Picture menu **12**
 - Sound menu **12-14**
 - Features menu **15**
- NEXTVIEW **16-20**
- Teletext **21-23**

- The keys on top of the TV **23**

Connect peripheral equipment

- Connecting and selecting equipment **24-27**
- Remote control functions for peripherals **27-28**
- Recording **29**

- Tips 30**
- Index 30**
- Glossary 31**



EasyLink features are based on the "one touch operation" approach. This means that a sequence of actions are executed at the same time in both the television and the video cassette recorder, **provided both are fitted with the EasyLink function** and connected with the eurocable supplied with your video recorder.

Preparation

Your remote control

Peripherals p. 27
 ◀▶ selection of **EXT1, EXT2, EXT3** or **FRONT**
TV, video recorder (**VCR**), **DVD**, Satellite (**SAT**), **TUNER**, **CD**, **TAPE** or cd-recordable (**CDR**) selection.

○ no function
 ⏸ freeze the picture p. 9
 hold teletext page p. 22
 ⌘ surround modes p. 9
 ◻ NEXTVIEW on/off p. 9
OK activate your choice

⏪ volume up/down p. 9
 🔇 sound mute p. 9
P programme selection p. 9

ⓘ on screen info p. 9
 P/P previous programme p. 9
 -/-- video recorder/DVD function p. 9

I-II bilingual choice/sound info p.11
 TXT language group selection p. 21

EasyLink p. 11
 ● **INSTANT** recording
 🖼 picture format p. 11

Dual Screen p. 10
 1/2 dual screen on
 ⏪ no function
 🖼 still teletext picture
 ⚡ strobe

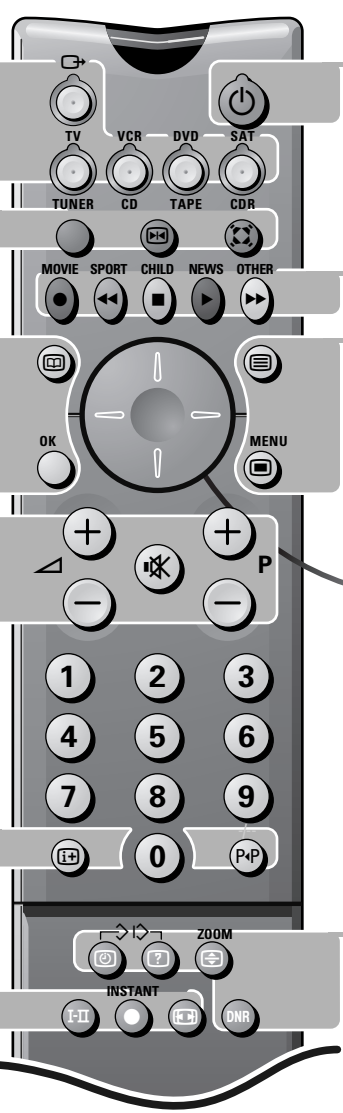

⏻ switch to standby p. 9

☰ teletext on/off p. 21
 🖼 main menu on/off p. 9

⬅️ cursor to select your choice p. 12

📺 Installation p. 4

Colour keys
 - select TV channels by theme p. 11
 - direct teletext page or subject selection p. 21

Audio- and Video equipment p. 27-28

Teletext p. 22
 ⌚ time display/subpage selection
 ❓ solution to puzzles display PDC/VPS code
 🔍 enlarge
 DNR reduce image noise p. 11

Smart Controls
 🎵 smart sound p. 11
 📺 active control p. 10
 🖼 smart picture p. 11



Preparation

- 1 Place the TV on a solid surface.**
 For ventilation, leave at least 5 cm free all around the TV.
 Do not place the TV on a carpet.
 To prevent any unsafe situations, do not place any objects on top of the TV.
 Avoid heat, direct sunlight and exposure to rain or water.
- 2 Insert the aerial plug** firmly into the aerial socket  at the back of the TV.

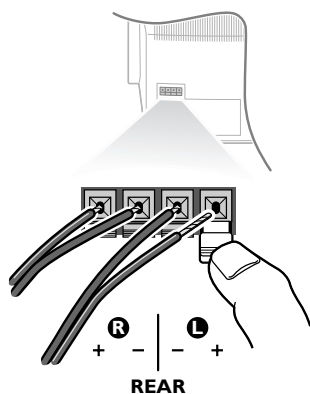
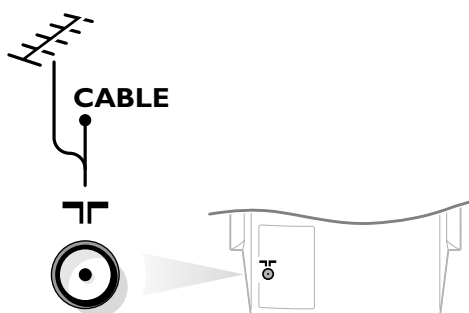

- 3 Connect the two Surround Sound rear loudspeakers** supplied to the connector clips at the back of the TV. Always connect both Surround Sound loudspeakers: the left rear loudspeaker at **REAR L**; the right rear loudspeaker at **REAR R**.

Push the connector clip down and insert the end of the wire into the opening; the positive wire (the one with the black line) to the red loudspeaker connection; the negative wire to the black loudspeaker connection. Do not insert the wires too far. The Surround Sound loudspeakers should always be located behind or to either side of the listener. If preferred you can also hang the loudspeakers on the wall.

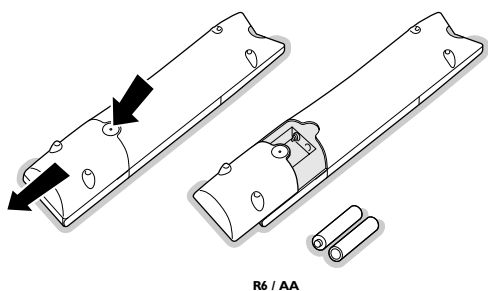



R6 / AA

- 4 Insert the mains plug** in the wall socket having a mains voltage of 220V-240V.
 To prevent damaging the mains (AC) cord which could cause a fire or electric shock, do not place the TV on the cord.
- 5 Remote control:** Remove the cover of the battery compartment. Insert the 2 batteries supplied (Type R6-1,5V). Press the **TV** key to be sure your remote control is in the TV mode.

The batteries supplied do not contain the heavy metals mercury and cadmium. Nevertheless in many countries exhausted batteries may not be disposed of with your household waste. Please check on how to dispose of exhausted batteries according to local regulations.

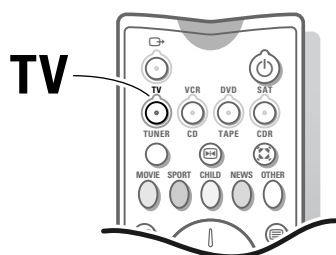
Note: this remote control functions with TVs which use the RC6 signalling standard.



- 6 Switch the TV on :** Press the power switch  on the front of your TV. A green indicator on the front of the TV lights up and the screen comes on. If the indicator is red, press the **- P+** keys on the remote control.

*The green lamp blinks every time you press a key on the remote control. When you switch on your set **for the first time**, the menu **LANGUAGE** automatically appears on the screen. The explanation appears in different languages one at a time. Choose your own language and press the **OK** key on the remote control.*

Go on to page 4.

Installation

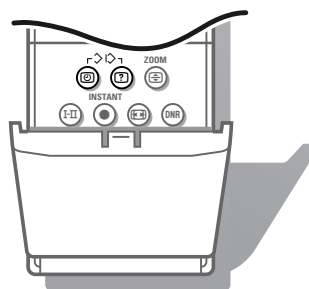

Select the INSTALLATION menu

- 1 Open the door of the remote control.
- 2 Press and at the same time.

To use the menus

- 1 Use the cursor in the up/down, left/right directions to select a menu item.
- 2 Press the **OK** key to activate.
- 3 Use the key to return or to switch the menu off.

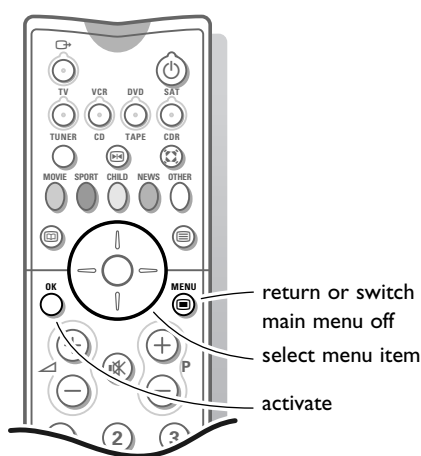
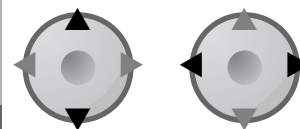
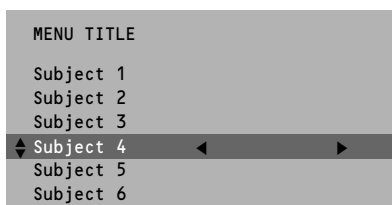

Store TV channels



After the new or extra TV channels have been stored, the TV automatically transfers those TV channels to the video recorder if it is equipped with the EasyLink function. The message **EasyLink : downloading** appears on the screen. The programme list of the video recorder is now the same as the one of the TV. If the TV is connected to a video recorder which supports the NEXTVIEWLink function, the TV also automatically transfers the language and country selections to the video recorder.

Select the menu language and country

First, select your language and country.

- 1 Select **Menu language** and press the **OK** key.
- 2 Select your language and press the **OK** key. Use the cursor up/down to scroll through the list and to bring up other languages which are not displayed on the screen at present.
- 3 Select **Country** and press the **OK** key.
- 4 Select the country where you are now located and press the **OK** key. Use the cursor up/down to scroll through the list and bring up other countries which are not displayed on the screen at present.

Select **Other** when none of the countries applies.

You can now search for and store the TV channels in two different ways: using **automatic installation** or **manual installation** (tuning-in channel by channel).

Select your choice and press the **OK** key.

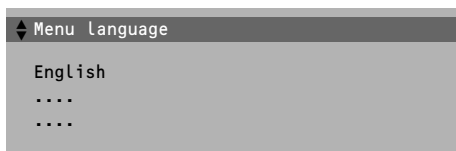

Automatic installation

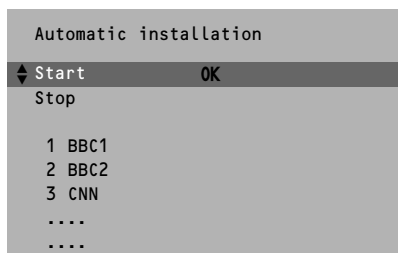
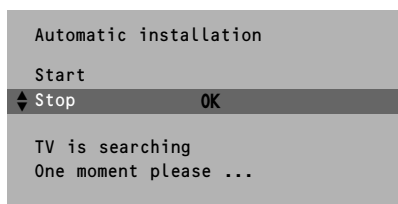

In the Automatic installation menu select **Start** and press the **OK** key to activate the searching. All TV channels are searched for and stored automatically.

If a cable system which broadcasts ACI (Automatic Channel Installation) or a TV channel transmitting a teletext page with the frequencies and programme names of all the TV channels which can be received, is detected, the search is stopped and a programme list appears.

The programme list is automatically filled with all the programme numbers and names of the TV channels transmitted.

*It is possible that the cable company or the TV channel displays a broadcast selection menu. Layout and items are defined by the cable company or the TV channel. Make your choice with the cursor and press the **OK** key.*

To exit from the menu press the  key on the remote control.

Go on to page 6.

Manual installation

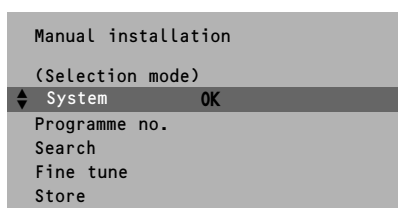

Searching for and storing TV channels is done channel by channel. You must go through every step of the Manual installation menu.

Selection mode is only present and lights up if the country selected also offers the channel option (C-channels for aerial channels, S-channels for cable channels).

You can choose either channel or frequency mode.

- 1 Select the TV system
Select the country or part of the world from where you want to receive the TV channel.
If you are connected to a cable system, select your country or part of the world where you are now located.
- 2 Press the cursor down and enter the programme number with the digit keys.
- 3 Search for a TV channel
Press the cursor left/right.
The frequency or the channel number increases until a TV channel is found.

Direct selection of a TV channel

If you know the frequency, the C- or S-channel number, enter it directly with the digit keys 0 to 9.

Ask for a list from your cable company or dealer; alternatively consult the Table of frequencies on the inside backcover of this handbook.

- 4 Fine tune
In case of poor reception, you can improve the reception by adjusting the frequency with the cursor left/right.
- 5 To store your TV channel, select **Store** and press the **OK** key.

Repeat steps 1 to 5 to store another TV channel.

- 6 To exit from the menu press the  key on the remote control.

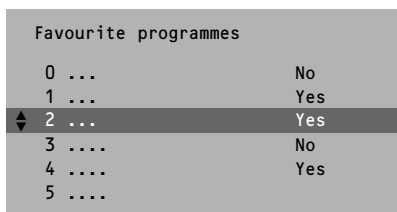
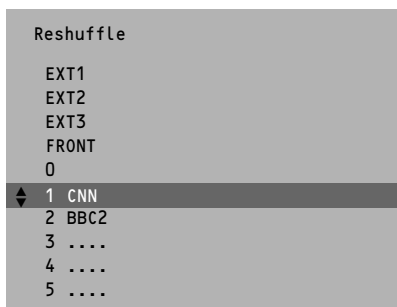
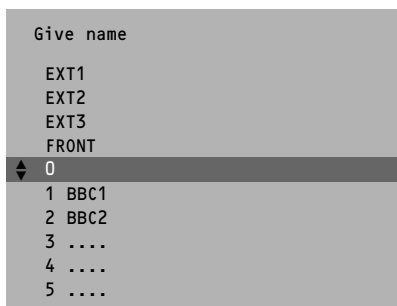
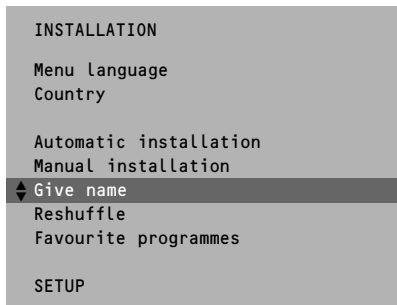

Give name

It is possible to change the name stored in the memory or to assign a name to a TV channel which has not yet been entered. A name with up to 5 letters or numbers can be given to the programme numbers 0 to 99. For example SUPER, BBC1,...

Between 99 and 0 you can also name any peripherals that are connected to a euroconnector.

- 1 Select **Give name** in the **INSTALLATION** menu and press the **OK** key.
- 2 Select the programme number.
- 3 Press the **OK** key.
- 4 Select the character with the cursor up/down.
- 5 Select the following position with the cursor right.
- 6 Select the following character.
- 7 Press the **OK** key when finished.
- 8 Press the  key to return to the **INSTALLATION** menu.

Space, numbers and other special characters are located between Z and A.

Reshuffle the programme list

According to your preference you **can** change the order of the stored TV channels.

- 1 Select **Reshuffle** in the **INSTALLATION** menu and press the **OK** key.
- 2 Select the programme number you want to exchange.
- 3 Press the **OK** key.
- 4 Select the new number you want to exchange it with.
- 5 Press the **OK** key.
Repeat the operation until all TV channels are allocated as you like.
- 6 Press the  key to return to the **INSTALLATION** menu.

Select Favourite TV channels

After leaving the installation you can browse through the TV channels by pressing the - **P** + key. Only those TV channels which are in the favourite list will be displayed. Non-favourite TV channels can still be selected with the digit keys. By default all stored channels are added to the favourite list.

- 1 Select **Favourite programmes** in the **INSTALLATION** menu and press the **OK** key.
- 2 Select your favourite programme number.
- 3 Select **Yes** or **No** with the cursor left/right.
- 4 Repeat for every TV channel you want to make a favourite or a non-favourite TV channel.
- 5 Press the  key to return to the **INSTALLATION** menu.



In order for NEXTVIEW to function properly, the first TV channel from the favourite list should also broadcast the correct local date and time via teletext.

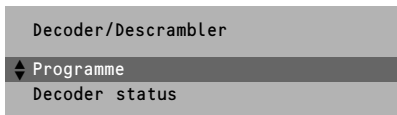
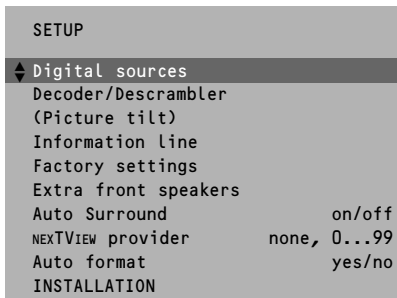

Install TV Setup

The Setup menu allows you to adjust initial settings, i.e. those which are not related to the installation of the TV channels. The Setup menu contains items that control the settings of the TV's functions, features, services and peripherals you may have connected.

- 1 Use the cursor in the up/down, left/right directions to select the menu item.
- 2 Use the **OK** key to activate.
- 3 Use the **□** key to return or switch menu off.

Digital sources

See Connect Peripheral Equipment, p. 25 to connect your digital equipment, like a DVD, a digital satellite tuner or a similar digital device.

Define Decoder/Descrambler programme numbers

If a decoder or a descrambler is connected, see p. 24, you can define one or more programme numbers as decoder programme numbers.

Press the cursor left/right to select the input used to connect to your decoder **Off**, **EXT1** or **EXT2**.

Select **Off** if you do not want the selected programme number being activated as a decoder programme number.

Select **EXT2** when the decoder is connected to your EasyLink video recorder. When selecting the decoder, the message **EasyLink: downloading presets....** appears on the screen.



Picture tilt (if provided)

Select **Picture tilt** with the cursor up/down.

Keep the cursor left/right pressed to adjust the rotation of the picture.

Information line

Select **On** and after the selection of a TV programme or after pressing the **i+** key on the remote control, a TV channel which broadcasts teletext may transmit the name of the TV channel, the programme name or another message. This is displayed on screen next to information about sound, picture format and DNR setting.

When selected **Off**, only sound, picture format and DNR information is displayed after the selection of a TV channel or after pressing the **i+** key.

Factory settings

Select **Factory settings** and press the **OK** key to restore picture and sound settings, predefined in the factory.

Extra front speakers

See Connect Extra loudspeakers, Amplifier, p. 26.

If no extra front speakers/amplifier are connected, do not change the predefined factory setting which is **No (TV)**.

SETUP	
Digital Sources	
Decoder/Descrambler	
(Picture tilt)	
Information line	
Factory settings	
Extra front speakers	
Auto Surround	on/off
◆ NEXTVIEW provider	none/o...99
Auto format	yes/no
INSTALLATION	

Auto surround

Sometimes the broadcaster transmits special signals for Surround Sound encoded programmes.

Dependent on your speaker configuration, the TV automatically switches to the best surround sound mode when Auto Surround is switched **On**.

When rear speakers are connected, Dolby Pro Logic will be reproduced.

When no rear speakers are connected, 3D surround will be reproduced.

Overruling this surround mode remains possible.

NEXTVIEW provider

Most broadcasters in Europe are offering teletext pages containing the day's programme schedule. These pages can be requested by switching the TV to Teletext Guide.

An increasing number of broadcasters are offering an extended programme guide service called NEXTVIEW.

NEXTVIEW is a new way of presenting programme schedules and offers more features than basic teletext. With NEXTVIEW it is possible to show for instance all the movies or children programmes for tonight or the following days.

If you select **None** as NEXTVIEW provider, the TV will capture all data from the available TV channels which broadcast NEXTVIEW. Broadcaster defined menus will not be available.

If you select a programme number of a TV channel stored in the favourite list as NEXTVIEW provider, the selected TV channel will provide NEXTVIEW data and additional information of its own broadcasts as well as from other (non selected) TV channels.

Normally you will select the NEXTVIEW provider that transmits most information in your language. You can make the best selection via information from TV announcements or from the newspapers.

Important:

In order for NEXTVIEW to function properly, the first TV channel from the favourite list should also broadcast the correct local date and time via teletext.

Please check at startup if the time and date are correct in the NEXTVIEW screen.

Remark:

Not all TV channels support NEXTVIEW.

How to make use of NEXTVIEW, see p. 16.

Auto Format

Selecting **Yes** causes the screen to automatically fill as much of the picture as possible when TV programmes are not carrying special signals detecting the correct screen format.

With the **[F4]** key on the remote control you can still select other picture formats. See p. 11.

Installation

Select **Installation** and press the **OK** key to return immediately to the **INSTALLATION** menu.

- 4 To exit from the menu press the **[EXIT]** key repeatedly.

Operation

Use of the remote control

Select peripherals

Press this key repeatedly to select **EXT1**, **EXT2**, **EXT3** or **FRONT**, according to where you connected the peripherals (p. 27).

TV VCR DVD SAT TUNER CD TAPE CDR

Press one of these keys to use the remote control directly in the TV, video recorder, DVD or satellite mode. A green indicator lights up. Press the same key again within 3 seconds to use the remote control in the mode indicated below the key (tuner, CD, tape or CD-recordable). A red indicator lights up. Press the key again to return to the function mentioned above the key.

 **Video recorder** see p. 27

 **NEXTVIEW** on/off see p. 16

OK Press this key to activate your choice, when in the menus.

Screen information

Press for 5 seconds to activate/de-activate the extended or reduced display of TV channel and programme information on the screen.

Press briefly to display information about the selected TV channel and programme, the sound reception, picture settings, the selected DNR setting and the remaining time set with the sleep timer.

0/9 **Digit keys**

To select a TV channel.
For a two digit programme number, enter the second digit within 2 seconds.
To switch immediately to a selected one digit TV channel, keep the digit key pressed a bit longer.

P/P **Previous programme**

The previously selected TV channel is displayed. The **-/-** indication is only video recorder/DVD.

Standby

The set is switched off and the red indicator (orange when acquiring NEXTVIEW information) lights up. When acquiring NEXTVIEW the TV is switched to full standby after a period of max. 1 hour and the red indicator lights up.

To switch the TV on again, press **- P +** or the digit keys.

If your EasyLink video recorder has the system standby function and you press the standby key for 3 seconds, both the TV and video recorder are switched to standby.

Freeze

To activate/de-activate the frozen picture and to hold a teletext page.

Surround mode

Press this key repeatedly to select another available surround mode: Pro Logic, 3D Surround, Dolby 3 Stereo, Stereo or Hall.

 **Teletext** on/off see p. 21

 **Main menu** on/off see p. 12

Volume

Press **+** or **-** to adjust the volume.

Mute

Temporarily interrupt the sound or restore it.

P **Programme selection**

To browse through the TV channels activated in the Favourite Programme menu.

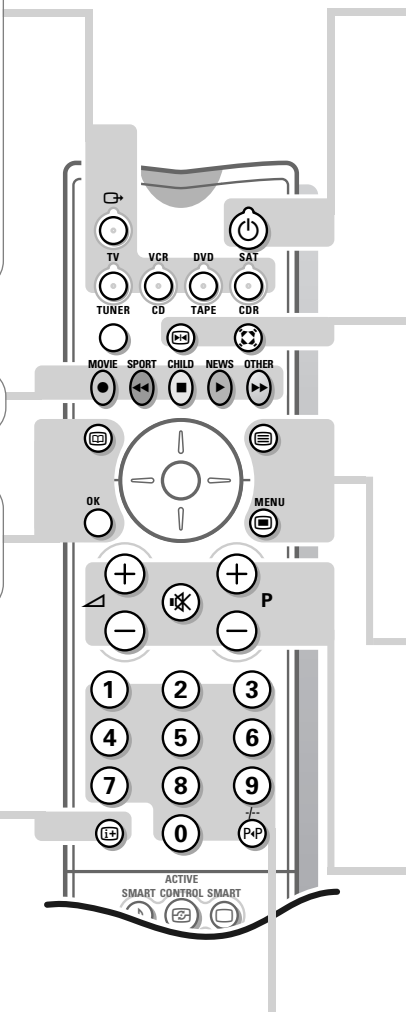

Time display

The time, downloaded from the TV channel (with teletext) stored on programme number 1 or the lowest favourite programme number, is displayed on the screen.

This function is not available when continuous subtitles have been switched on.

    **Teletext functions** see p. 22

Active control

Active control is a pro-active and automatic system. The TV continuously measures and corrects all incoming signals in order to provide the best picture possible. Thanks to the Ambient Light Sensor which measures the light conditions of the room in which the TV is situated, the contrast, dynamic contrast, brightness and colour picture settings are adjusted automatically. The light sensor is active when the Active control function is switched to Medium (if provided) or Maximum. Press the  key repeatedly to select the Active Control values Off, Minimum, Medium (if provided) or Maximum.

Off Sharpness and Dynamic Contrast are controlled automatically

Minimum Sharpness, Dynamic Contrast and Noise Reduction are controlled automatically.

(Medium Dynamic Contrast, Colour, Sharpness and Noise reduction are controlled automatically.)

Maximum Contrast (if provided), Dynamic Contrast, Colour, Sharpness and Noise reduction are controlled automatically.

Press the cursor in the up/down directions while the selected Active Control setting information is on top of the screen.

The Active Control menu appears.

The picture settings are being adapted continuously and automatically.

The menu items cannot be selected.





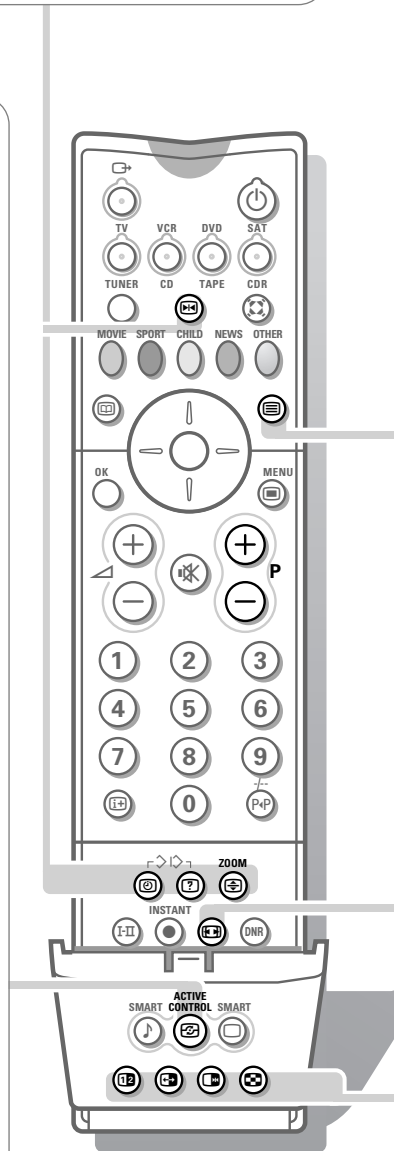

Colour enhancement (skintone correction, green enhancement and blue stretch) is switched on with certain Smart Picture selections.

Press the cursor in the up/down directions again to switch off the menu.





 no function

Dual Screen

- 1 Press the  key to switch on Dual Screen. The TV screen is divided into 2 parts:
 - the left side for the normal main picture,
 - the right side for teletext broadcast by the selected TV channel or for NEXTVIEW/Teletext Guide.To operate NEXTVIEW/Teletext Guide, see p. 16. To operate teletext, see p. 21.
If Dual Screen is Off, the picture, teletext or NEXTVIEW/Teletext Guide are displayed full screen.
- 2 Press the  key under the door of the remote control to select a vertical squeezed or a non vertical squeezed picture size
- 3 Press **+ P** - to run through the teletext pages.
- 4 Select still teletext picture
Press the  key to freeze only the teletext picture. The info in this page is not being updated by the teletext broadcaster.
- 5 When in Teletext Dual Screen, press the  key to return to a full picture screen or press the  key to return to a full Teletext screen.
- 6 When in NEXTVIEW/Teletext Guide Dual Screen, press the  key to return to a full picture screen or press the  key to return to a full NEXTVIEW/Teletext Guide screen.

Strobe

Press this key to reproduce the picture image by image.
Press the  key again to have a faster speed.
Press the  key again to switch off the strobe function.

I-II Bilingual choice and sound mode selection

Press this key

- to switch from **Stereo** to **Mono** sound, in case of stereo transmission, or from **Nicam Stereo** to **Nicam available**, in case of digital transmission;
- to choose between language I (Dual I) or language II (Dual II), in case of bilingual transmission. The setting is separately stored for each TV channel.

● Instant record

If your video recorder has the EasyLink function the **INSTANT** ● key for record can be operated in the TV mode.

Picture format

Press this key repeatedly to select another picture format: 4:3, Movie Expand 14:9, Movie Expand 16:9 with or without subtitling, Wide Screen, Super Zoom or Automatic (when Auto format is set to Yes in the **SETUP** menu).

Automatic makes the picture to fill the screen as much as possible. Sometimes also video recorder programmes carry special signals which will automatically switch the TV to the correct screen format.

Auto format is disabled when in Dual screen.

When in Movie Expand 14:9 or 16:9 or Super Zoom picture format you can make subtitles visible with the cursor up/down.

DNR Dyn. Noise Reduction

To reduce the image noise and improve picture quality when receiving weak signals. Press the **DNR** key to select **Off**, **Minimum**, **Medium** or **Maximum**.

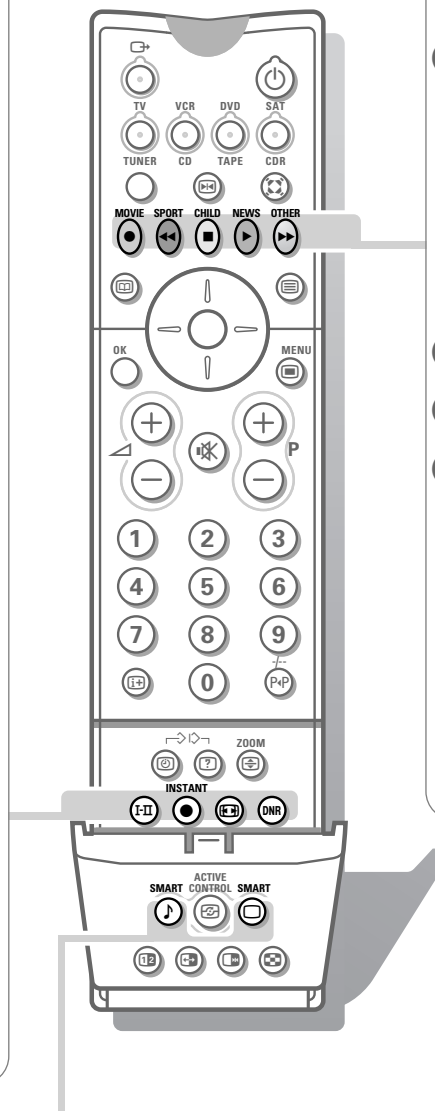

Select TV channels by theme

If programmes in the TV guide of NEXTVIEW have defined themes, it is possible to quickly select TV programmes with the coloured keys.

- 1 Press the red, green, yellow or blue key to select one of the four predefined theme categories **MOVIES**, **SPORTS**, **CHILDREN**, **NEWS**. The TV switches to the first TV channel broadcasting a programme of the selected theme. At the same time a list of all the TV channels currently transmitting a programme of the selected theme appears on the screen.
- 2 Use the cursor up/down to select a TV channel.
- 3 Press the same colour key again to remove the list.
- 4 Under the white key you can programme your own theme category. (Default; the theme category **Shows** has been preprogrammed in the factory.) Press the cursor up and select a preferred theme from the theme list with the cursor left/right. From now on the selected theme category is stored under the white key. A list of all the TV channels currently transmitting a programme of the selected theme appears on the screen.

Smart Keys

To select predefined picture and sound settings.

Smart Sound

Each time it is pressed, a different sound setting is selected, corresponding with specific factory setting of the equalizer.

Smart Picture

Each time it is pressed, a different picture setting is selected, corresponding with specific factory settings of Contrast, Colour, Sharpness, Colour Enhancement and Dynamic Contrast.

Personal refers to the personal preference settings of picture and sound selected in the picture and sound menu.

Remark: the moment you are in a predefined smart sound or picture setting and you modify a setting in the picture or sound menu, all values of the menu will overwrite the previously made settings.

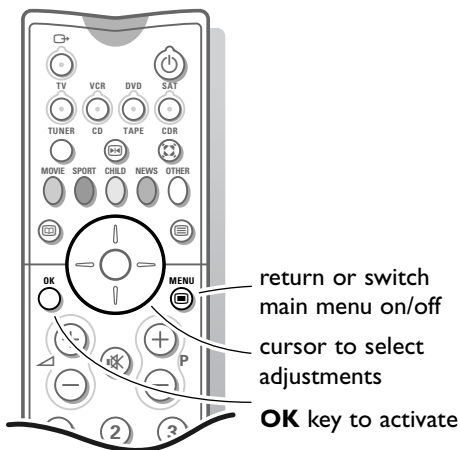

Use of the menus

- 1 Press the key to display/cancel the **MAIN MENU**.
- 2 Use the cursor in the up/down directions to select the **PICTURE, SOUND** or **FEATURES** menu or to select the **PROGRAMMES**.
- 3 Press the cursor right to activate the selected menu.
- 4 Use the cursor in the up/down, left/right directions to select the menu item.
- 5 Use the **OK** key to activate.
- 6 Press the key repeatedly to return or to switch the menu off.

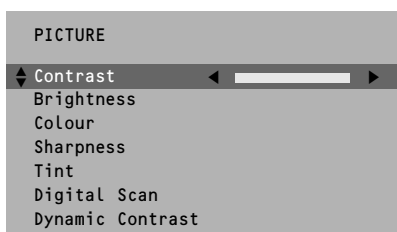
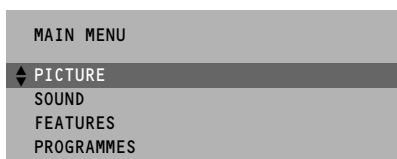

Picture menu

If an NTSC peripheral is connected to one of the euroconnectors, the option Hue also appears.

Tint

Select the colour temperature: **Normal, Warm** or **Cool**.

Digital Scan (Line Flicker Reduction)

In Movie Expand picture format, Digital Scan is always active. The menu item is not available.

In rare circumstances while watching TV programmes it may be preferable to switch off the digital scan line flicker reduction. Normally keep it switched on. Press the cursor left/right to select **On** or **Off**.

Dynamic Contrast

To make the contrast in the darker and the brighter picture areas more noticeable, select the **Med** setting.

In certain circumstances it may be preferred to select **Min, Max** or **Off**.

The modified adjustments for Contrast, Brightness, Colour, Sharpness, Tint, Digital Scan and Dynamic Contrast are automatically stored for all TV channels.

Select **Factory settings** in the Setup menu to restore the predefined factory settings, see p. 7.

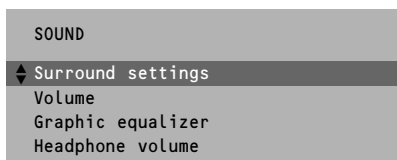

Sound menu

Surround settings, see p. 13.

Graphic equalizer

Here you can select the preferred sound setting which corresponds with the personal sound settings.

Select **Factory settings** in the Setup menu to restore the predefined factory settings, see p. 7.

Headphone volume

See Connect Peripheral Equipment, p. 25 for the connection of the headphone.

Available menu items in case of the selected Surround modes.

Surround settings

Test start	•	•	•		
Test stop	•	•	•		
Centre volume		•	•	•	
Balance	•	•	•	•	•
Rear volume			•		•
3D effect	•				
Surround mode	•	•	•	•	•
	Stereo	3D surround	Pro Logic	Dolby 3 Stereo	Hall

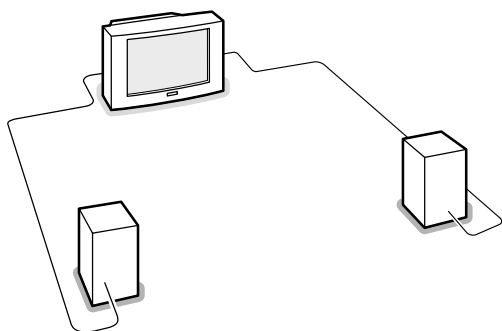
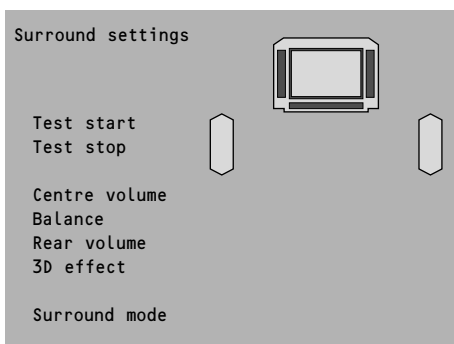

Surround settings menu

Select **Surround settings** in the Sound menu.

The contents of the Surround settings menu depends on the selected Surround modes.

The graphical representation of the speakers is displayed on screen when controls are being changed or when in test tone mode.

The drawing on screen is updated according to the chosen setup and the selected surround mode. Speakers which are active are highlighted.

In 3D surround mode the graphical representation of the rear loudspeakers is replaced by the symbol)) ((. The menu item **3D effect** appears and the level of the 3D effect can be adjusted.

Note: if extra front speakers are connected and selected in the Setup menu, all internal TV speakers produce centre sound. See Connect Peripheral Equipment, Extra loudspeakers/Amplifier, p. 26.

Adjustment of the volume level of the loudspeakers

The menu item **Test** which only appears in Dolby* 3 Stereo, 3D Surround mode or Pro Logic, enables you to have a reference of the internal and the rear loudspeakers loudness.

- 1 Select **Dolby 3 Stereo**, **3D Surround** or **Pro Logic**.
- 2 Select **Test start** and press the **OK** key.
A steady noise tone is switched sequentially through the available loudspeakers, for 2 seconds each. This enables you to have a reference of the loudness of each loudspeaker.
The loudspeakers activated light up in the screen graphic.
- 3 Select **Centre volume**, **Balance** or **Rear volume** and alter the selected adjustments.
- 4 Select **Test stop** and press the **OK** key when you have finished the adjustment of the speaker levels.

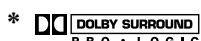

* 'Dolby' 'Pro Logic' and the double-D symbol  are trademarks of Dolby Laboratories Licensing Corporation. Manufactured under license from Dolby Laboratories Licensing Corporation.

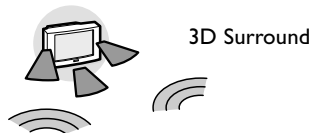

3D Surround

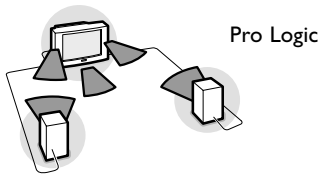

Pro Logic

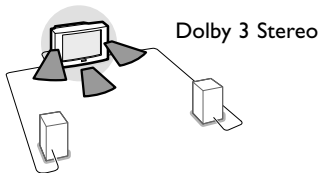

Dolby 3 Stereo

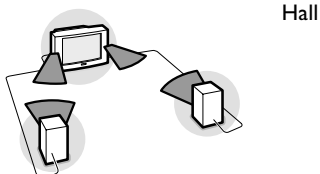

Hall

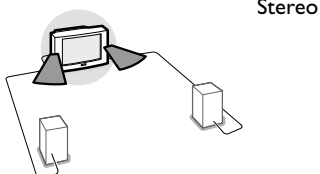

Stereo

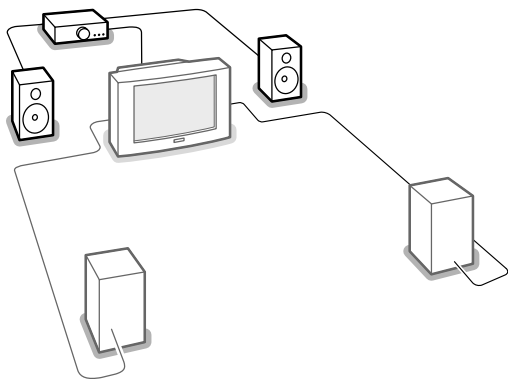

Surround modes

Select the Surround mode according to the sound mode being broadcast.

3D Surround (optimal with Dolby Surround broadcasting)

3D Surround enables you to experience the effect of Dolby Surround Pro Logic without the need of having rear speakers connected or activated. The graphical representation of the rear loudspeakers is replaced by the symbol .

Select the level of **3D effect** with the cursor left/right.

Pro Logic (with Dolby Surround broadcasting)

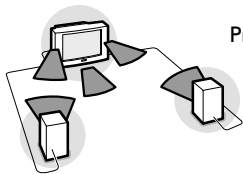
In addition to the left and right internal speakers, the centre and the rear surround loudspeakers reproduce the Dolby Surround Pro Logic sounds. This 4-channel sound is always present in the movie or programme marked with  Dolby Surround.

This mode is especially recommended for such programmes or movies.

Dolby Pro Logic signals are also present on some DVD tracks.

Dolby 3 Stereo (optimal with Dolby Surround broadcasting)

The sound signal is now distributed over the front left, the front right and the centre TV loudspeakers.

The rear loudspeakers do not produce any signal.

Hall

The special sound signal is distributed over the rear loudspeakers which creates a hall effect from the rear.

The centre loudspeaker does not reproduce any signal.

This mode is recommended when you wish to add surround sound to a broadcast which is not encoded Dolby Surround or to a mono signal.

Stereo

This mode reproduces only the left and right front sound signals.

You only hear a stereo sound if the broadcast which you are watching or listening to is transmitted in stereo or nicam stereo.

With two extra front loudspeakers connected

To enhance the sound reproduction of your TV you may connect two extra front loudspeakers via an external amplifier. See Connect Peripheral Equipment, Extra loudspeakers/Amplifier, p. 26.

In the Surround modes, Hall and Stereo (**+ amp**) is added to indicate that you should switch on your amplifier as in these modes the internal TV speakers do not produce any sound. The subwoofer output is muted.

Note: If extra front speakers are connected and selected, all internal TV speakers produce centre sound in the surround modes Pro Logic, Dolby 3 Stereo and 3D Surround.

Press the  key to return to the **SOUND** menu.

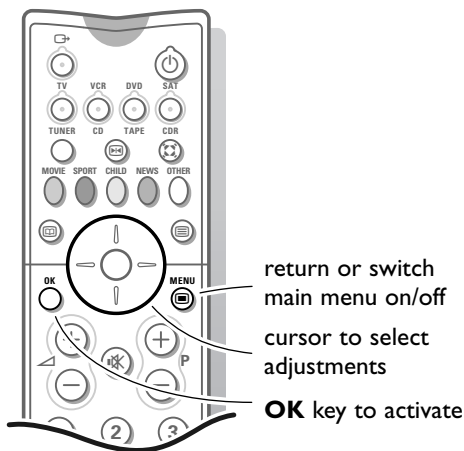

FEATURES	
Sleeptimer	Off
Child lock	Off
Subtitle	Off

Features menu

- 1 Press the  key to display/cancel the **MAIN MENU**.
- 2 Use the cursor in the up/down directions to select the **FEATURES** menu.
- 3 Press the cursor right to activate the selected menu.
- 4 Use the cursor in the up/down directions to select a menu item.
- 5 Use the cursor in the left/right directions to select the desired setting.

Sleeptimer

With the sleeptimer you can set a time period after which the TV should switch itself to standby.

The counter runs from **Off** up to **180 min.**

One minute before the TV is set to go to standby, the remaining seconds appear on screen. Not visible in dual screen mode. You can always switch off your set earlier or change the set time.

Child lock

If the child lock is on, the TV can only be switched on with the remote control. The **P** - and + keys on top of the TV cannot be used to select a TV channel. In this way you can prevent unauthorised use of your TV.

If the message **Child lock On** appears, the child lock must be switched off before you can use the **P** - and + keys on top of the TV to select a TV channel.



Subtitle

TV channels with teletext often transmit certain programmes with subtitling. See Teletext, Continuous Subtitles, p. 23 how to select the proper subtitle page from the teletext index.

Select **Subtitle On** or **Off**.

Press the  key to switch off the Features menu.

Programme list

- 1 Press the  key to display/cancel the **MAIN MENU**.
- 2 Select **PROGRAMMES** with the cursor up/down.
- 3 Press the cursor right to display an overview of all the TV channels installed.
- 4 Press the cursor up/down to run through the list and press **OK** to select the desired TV channel.
- 5 Press the  key to switch off the Programme list.

NEXTVIEW / Teletext Guide

In the Setup menu, p. 8 you were asked to select a NEXTVIEW provider. If the selected provider supports NEXTVIEW then the TV will automatically present the NEXTVIEW programme schedule. If the TV channel supports just teletext, then the TV will switch automatically to Teletext Guide. Both facilities are offering the same functions: record, remind, info and watch. However in case of Teletext Guide the broadcaster is responsible for the availability of these functions.

Some broadcasters provide information about their own programmes and sometimes other TV channels for one or more days. You can search for the programmes you want to watch up to 7 days in advance. It is also possible to search for a programme by theme, e.g. sport, movie, etc. Once a programme has been selected it can be tagged, to remind you, or to record on the video recorder automatically (provided the video recorder is equipped with NEXTVIEWLink), once, daily, weekly or series. Teletext Guide/NEXTVIEW also allows direct access to detailed information about programmes if provided by the broadcaster.

*The broadcaster is responsible for the content of the information.
The TV is responsible for the capture of that information and for the presentation to the user.*

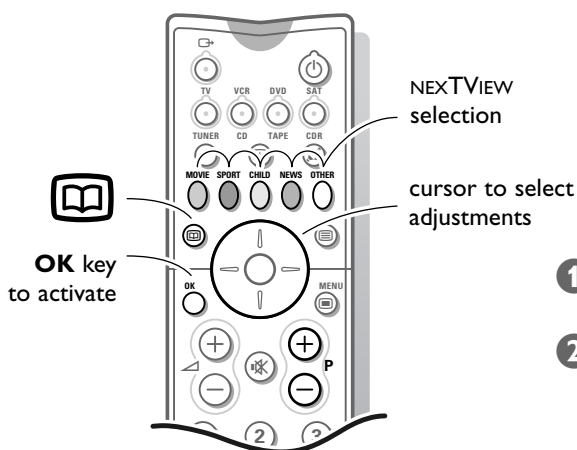

Use of the Teletext Guide/NEXTVIEW menus

- 1 Press the  key on the remote control to display/cancel the Teletext Guide/NEXTVIEW menu.
- 2 Use the cursor in the up/down, left/right directions to select the date, **DAY** for the daily guide and the time block (in steps of 15 minutes), **CHANNEL** for the channel guide, **THEME** for the theme guide, **OVERVIEW** for an overview of all the programmes which are marked as reminders or for recording, the programme guide page number or to enter the programme list.

Teletext Guide

	Menu	Day	Channel	Theme	Overview
			BBC1		BBC2
	p. 202		◀ 01 02 ... ▶		
Record			BBC1		
Remind	11.03			
Info					
Watch	14.35			226/3
	17.50			231

NEXTVIEW

	Monday 9 Oct		18:03
	Menu	Day	Channel
	CNN		BBC1
			BBC2
Record		BBC1	NEXTVIEW
Remind			
Info	What's on now		
Watch	Preview		
	Themes		
	Ratings		

- 3 Enter the proper programme guide page number with the digit keys or with the **- P +** keys.
 - 4 Press the cursor left/right to run through the subpages.
 - 5 Select a programme with the cursor up/down.
 - 6 Press one of the colour keys to select one of the basic functions (if available); **record**, **remind**, **info**, **watch**. See Basic functions further on.
 - 7 Press the **OK** key to return to the header area again.
- 3 Select a programme with the cursor up/down.
 - 4 Press one of the colour keys to select one of the basic functions (if available); **record**, **remind**, **info**, **watch**. See Basic functions further on.
 - 5 Press the **OK** key to return to the header area again.

	Menu	Day	Channel	Theme	Overview
			BBC 2		
	p.202	◀	01 02 ...	▶	
Record			BBC 2		
Remind	11.03			
Info					
Watch	14.35			226/3
	17.50			231
One moment please					

Teletext guide

TV channels which broadcast teletext also transmit a page with the programme guide of the day. For each selected TV channel the programme guide page can be selected with the  key:

- automatically if the selected TV channel supports services like PDC (Programme Delivery Control) or MIP (Magazine Inventory Page).
- if automatic pre-selection is not possible then the index page is displayed and the proper programme guide page number of the selected TV channel has to be entered with the digit keys.

The programme guide page will be stored automatically only if it satisfies Video Programming via Teletext (VPT) requirements.

Every time you press the  key, the programme guide page of the selected TV channel will be available if the TV channel does not support NEXTVIEW.

The function items record, remind, info and watch, corresponding with the coloured keys, become highlighted if the displayed programme page satisfies the Video Programming via Teletext (VPT) requirements. Select a programme item and press one of the function keys, e.g. Record or Remind. See Basic functions further on.

The Info item is enabled if the selected programme contains a page number with an optional subcode referring to a page with more info about the programme.

NEXTVIEW modes to sort and represent information

Menu

If in the Setup menu, see p. 8, you have selected a TV channel as NEXTVIEW provider which also supports NEXTVIEW. NEXTVIEW menu is displayed or can be selected. The selected TV channel is responsible for this menu.

The NEXTVIEW menu appears when NEXTVIEW is switched on.

Use the cursor up/down to select a menu item.

Use the cursor right to select the menu item.

While going through the menus, the TV is collecting the sorting criteria to finally display a list of programme events.

The functions, in the left column, are shown at reduced brightness as long as the menu is displayed.

If **None** has been selected as NEXTVIEW provider in the Setup menu, the broadcaster's defined menu will not be available.

	Monday 9 Oct	18:03
	Menu	
	BBC1	NEXTVIEW
Record		
Remind	What's on now	
Info	Preview	
Watch	Themes	
	Ratings	

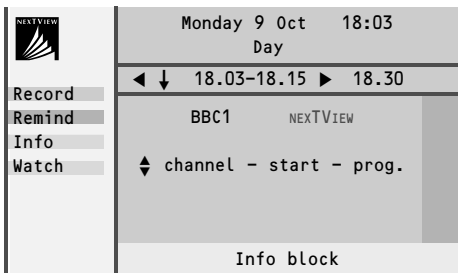

Day

The day guide provides an overview of all programme titles active in the selected time block. Time blocks are 15 minute intervals starting from the current time of the current day.

The default order is based on the programme list of the favourite TV channels as stored in the installation of the TV. TV channels not marked as favourite TV channels will not appear.

Default NEXTVIEW opens with the day screen if the broadcast does not have its own menu.

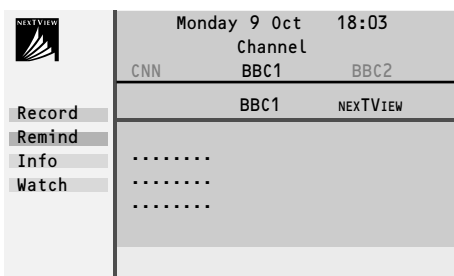

Channel

The Channel guide provides an overview of all programmes that are broadcast by a single channel during one day.

Previous programmes can be made visible via cursor up.

The list will start with the earliest broadcast programme.

With cursor left/right another favourite TV channel can be selected.



Theme

The theme guide displays a list of all programmes at the selected date, that matches with the selected category (news, sport, culture, movies, ...).

The default starting item will be the current or next programme on the current TV channel.

The **THEME** selection is only present if programmes in the TV guide have defined themes.

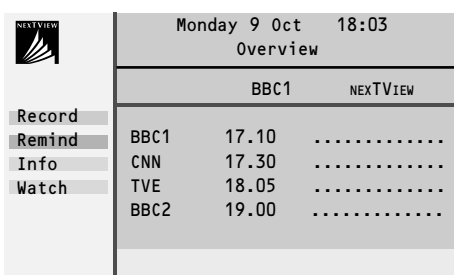

Overview

The Overview menu provides a list of programmes that are marked as reminders and those that have to be recorded.

When more than one programme to be recorded has an overlap in time, these programmes will be marked by a red colour.

After the programme has been broadcast, all items set for once will be deleted from the list the following day. This menu can be used to change a reminder or programmes to be recorded.

Note: the TV will automatically interpret the broadcast time (as shown on the teletext guide) of your selected programme into the correct local time and date.

	Date	Time
Record	CNN	BBC2
Remind	BBC1	NEXTVIEW
Info	11.03	Travel Guide R
Watch	14.35	World news ◆
	◀Once ▶ Daily Weekly Clear	
	17.50	Insight
	Info block	

Basic functions

The functions Record, Remind, Info and Watch can be activated with the corresponding colour keys on the remote control. If the function is not available, then the text is shown at reduced brightness. Select a programme with the cursor up/down.

Record **R** or Remind **◆**

- 1 Press the red colour key to activate **Record** or the green colour key to activate **Remind**.

If the programme number of the broadcaster is not yet known, a message appears with the request to input the right number.

A small menu pops up in which you can choose the interval: once, daily or weekly, or clear an earlier made record or remind setting. The default interval is set to **Once**. If a programme is an episode of a series, it is identified by the system and the options **daily** and **weekly** are replaced by the option **series**. In this case the system identifies when the next episode of the series will be broadcast. This is not possible in the Teletext guide.

- 2 Use the cursor in the left/right directions to select the interval. The colour of the tag refers to the interval.
- 3 Press the **OK** key.

When **Record **R**** is activated:

Storing is displayed to indicate the video recorder is programmed.

When **Remind **◆**** is activated:

- a message will be displayed the moment the tagged programme with **◆** starts, when watching the TV later on.
- the TV switches on the moment the tagged programme with **◆** starts, when the TV is in standby.

Note: Recordings and reminders are not possible when the broadcaster does not transmit dates and times of the programmes.

*The message **No TV programming possible** appears.*

Make sure you are on the TV programming page.

Info

- 1 Press the yellow colour key to activate **Info**. Advertisements or information relating to the selected programme are displayed. In some cases all of the information does not fit on the screen. Use the cursor up/down to browse through all the information.
- 2 Press the yellow colour key again to switch off the information.

Watch

Press the blue colour key to activate **Watch**.

This function is only available if a currently broadcast programme is selected. Otherwise the function is not available.

The selection causes the TV to tune to the selected TV channel. NEXTVIEW is switched off.

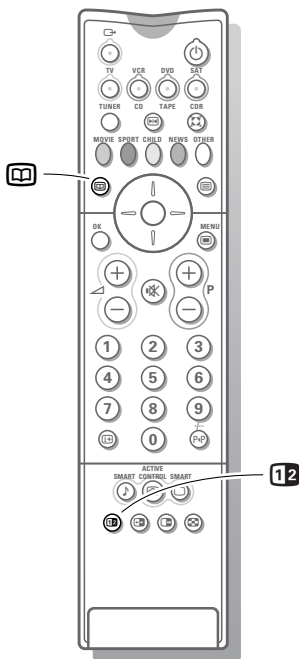



Select Picture/NEXTVIEW-Teletext Guide

Press the  key.

Press the  key.

The screen is divided into two parts: the left side for the normal main picture, the right side for NEXTVIEW/Teletext Guide.

Press the  key to return to a full NEXTVIEW/Teletext guide screen or press the  key to return to a full picture screen.

Acquisition and updating of NEXTVIEW information

Acquisition and updating of NEXTVIEW is done when you are watching the TV channel of the selected NEXTVIEW provider; see Setup menu p. 8, or when the TV is switched to standby.

The indicator on the front of the TV remains orange during standby.

After all needed acquisition or updating is complete, it turns red.

Acquisition of fresh data will happen once during the night.

Note: it may be necessary to put the TV in standby mode when all NEXTVIEW information is outdated, e.g. returning from holiday.

Video recorder restrictions with NEXTVIEW

The **Record** item and the automatic recording will only be present and possible if your video recorder is equipped with NEXTVIEWLink.

Your video recorder should be connected to **EXTERNAL 2**. See Connect Peripheral Equipment, p. 24.

The daily, weekly and series options, the number of recordings set and the way overlapping recordings are managed, depend on the type of video recorder you have. When all video recorder timers are full, the item **Record** in the menu will not be present.

Upload video recorder overview (only with Philips sets)

When the TV is switched on, the timer recordings are uploaded to the TV to check if any manual addition or deletions have been done. This is shown in the overview.

The video recorder manages and removes timer recordings when performed.

Some NEXTVIEWLink video recorders do not allow a daily programming of the recording to start on a Saturday or Sunday. In this case the item **daily** will be removed from the menu on those days.



Teletext

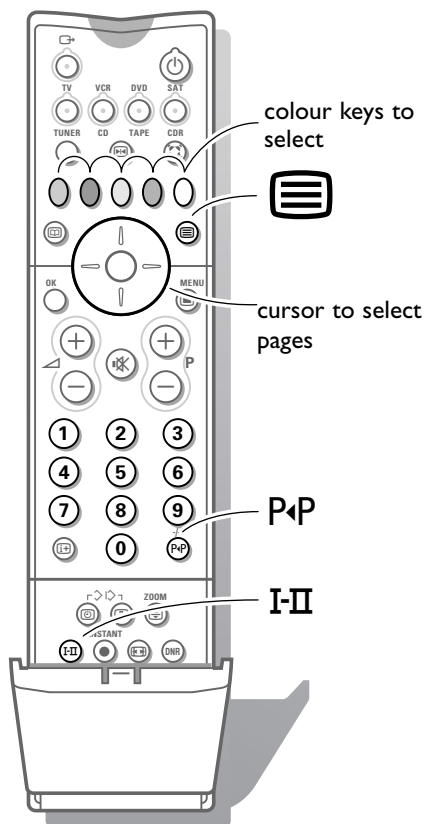

Most TV channels broadcast information via teletext.

Each channel which broadcasts teletext transmits a page with information on how to use its teletext system. Look for the teletext page with the main index (usually p. 100).

Depending on the TV channel, teletext is transmitted in different systems. The colours used in the options line correspond with the colour keys of your remote control.

About Easy Text

Easy Text considerably reduces the waiting time (on condition that the teletext broadcast of the particular TV channel is received for at least half a minute) by :

- a direct selection of previous and following pages which are in transmission and of the pages referred to in the options line
- a habit watcher list: frequently used pages are put automatically in a list of preferred pages, so that they are immediately available
- the precapturing of the page numbers referred to in the displayed page
- the precapturing of all the subpages.

Switch Teletext on and off

Press  to switch the teletext on or off.

The main index page appears on the screen together with two information lines at the top and one option line at the bottom of the screen.

Remark: if the displayed teletext characters on screen do not correspond with the characters used in your language, press the I-II key, under the door of the remote control, repeatedly to select Language group 1 or 2.

Select a Teletext page

With the digit keys

Enter the desired page number with the digit keys.

The page counter seeks the page or the page appears immediately when the page number has been stored in the memory.

A message appears when you have entered a non existent or incorrect page number. Page numbers beginning with 0 or 9 do not exist. Choose another number.

With the option line

Select with the colour keys, corresponding to the coloured options at the bottom of the screen, the desired subject.

Select Picture/Teletext

Select a TV channel which broadcasts teletext.

Press the  key.

The screen is divided into two parts:

the left side for the normal main picture,

the right side for teletext broadcast by the selected TV channel.

Press the  key to return to a full screen picture.

Press the  key to return to a full teletext picture.

Quickly run through the teletext pages

Press the cursor up/down or the - P + key to run through the previous or the following pages.

Select the previously selected txt page

Press the P<P key.

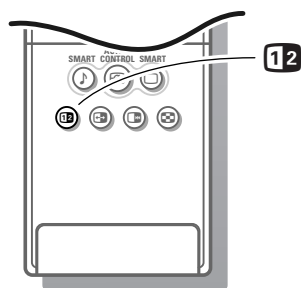

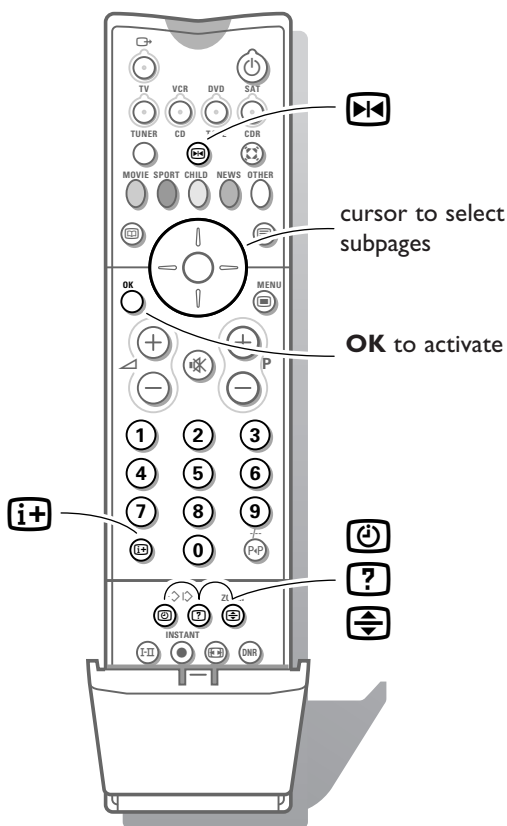

Select the index teletext page

Press the white colour key to display the main index (usually p.100).

Only for T.O.P teletext broadcasts :

T.O.P orders the pages in categories and adds other possibilities of enhancing ease of use.

Press **i+**. A T.O.P overview of the teletext subjects available is displayed. Not all TV channels broadcast T.O.P. teletext. When the teletext system is not T.O.P. teletext, a message appears at the top of the screen.

Select with the cursor up/down, left/right the desired subject and press the **OK** key.

Select subpages

When a selected teletext page consists of different subpages, one of the subpages appears on the screen.

The coloured number in the first information line refers to the displayed subpage.

The other subpages can be selected in 2 ways :

With the cursor left/right

The other subpage numbers appear in white as soon as the transmission has found them. They are stored in the memory so that they are available while the teletext page is on screen.

Select with the cursor left/right the previous or the following subpage.

With the **⏻** key

- Enter the subpage number yourself:

Press **⏻**. Enter the desired subpage with the digit keys : e.g. 3 for the third page of seven subpages.

The TV searches for the selected subpage.

- Automatically rotating subpages:

Press **⏻** again to cancel the entered digit key for the subpage.

Now the subpages rotate automatically.

Press **⏻** again to select the subpages with the cursor left/right again.

Special teletext functions

Hold

Press **⏻** to stop the automatically rotating of the subpages or to stop the page counter from seeking when you have entered a wrong page number or when the page is not available.

Enter another page number.

Enlarge

Press **⏻** repeatedly to display the upper part, the lower part and then to return to the normal page size. When the upper part is displayed, you can scroll the text, line by line using the cursor up/down.

Reveal

Press **?** to reveal/conceal the hidden information, such as solutions to riddles and puzzles.

Select Continuous Subtitles

TV channels with teletext often transmit programmes with subtitling. For each TV channel you can store a subtitle page which will be displayed continuously if the programme being broadcast is transmitted with subtitles.

Switch on teletext and select the proper subtitle page from the index.
Switch off teletext.
Now the subtitle page is stored for the selected TV channel.

Once subtitles have been stored and **Subtitle On** has been selected they will automatically be displayed on the selected TV channel if subtitles are in the transmission.

Select **Subtitle On** or **Off** in the Features menu, see p. 15.
The subtitle symbol  appears when **Subtitle On** is selected.

Remark: you are in teletext mode, so only teletext functions are available.

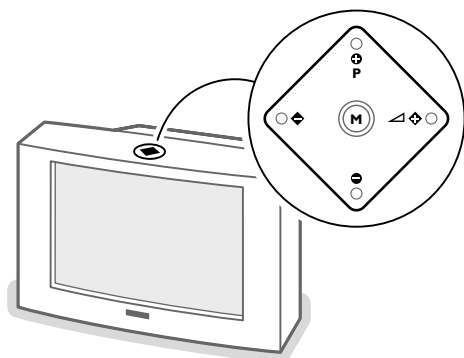

Keys on top of the TV

Should your remote control be lost or broken you can still change some of the basic picture settings with the keys on top of the TV.

Press the **M** key repeatedly to select **Volume, Brightness, Colour, Contrast**.
Press the **P** - or + keys to carry out the selected adjustment.
When the menu adjustment is not displayed, the **P**- or + keys enable you to select the TV channels, the  - or + keys to adjust the volume.

The selected adjustment automatically switches off when no action has been executed. for 10 seconds.

Connect Peripheral Equipment

There is a wide range of audio and video equipment that can be connected to your TV. The following connection diagrams show you how to connect them.

Video recorder

Connect the aerial cables ①, ② and, to obtain the optimum picture quality, eurocable ③ as shown opposite.

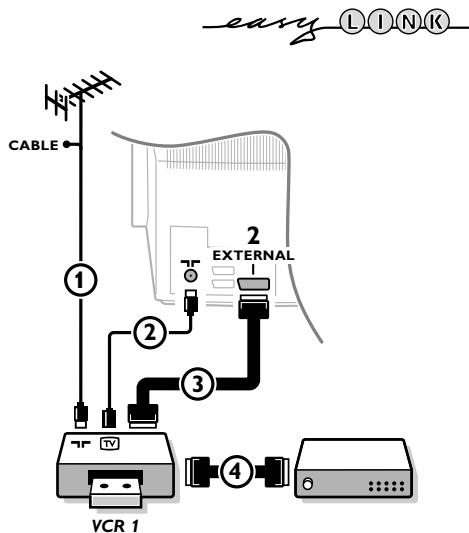

If your video recorder is provided with the EasyLink function, the eurocable supplied with it should be connected to **EXTERNAL 2** to benefit from the EasyLink functionality.

If the eurocable ③ is not used the following steps are required:

Search for and store the test signal of the video recorder

- ① Unplug the aerial cable ① from the aerial socket of your video recorder.
- ② Switch on your TV and put the video recorder on the test signal. (See the handbook for your video recorder.)
- ③ Search for the test signal of your video recorder in the same way as you searched for and stored the TV signals. See Installation, Searching for and storing TV channels, Manual installation, p. 5.
- ④ Store the test signal under programme number 0 or between 90 and 99.
- ⑤ Replace the aerial cable in the aerial socket of your video recorder after you have stored the test signal.

Decoder and video recorder

Connect a eurocable ④ to your decoder and to the special euroconnector of your video recorder. See also the video recorder handbook.

See Define Decoder/Descrambler prog. numbers, p. 7.

You can also connect your decoder directly to **EXTERNAL 1** or **2** with a eurocable.

Video recorder and other peripherals (except Digital Sources)

- ① Connect the aerial cables ①, ② and ③ as shown opposite. Better picture quality can be obtained if you also connect eurocable ⑤ to **EXTERNAL 2** and a eurocable ④ to **EXTERNAL 1** or **3**.
- ② Look for the test signal of your peripheral in the same way as you do for a video recorder.

When a video recorder is connected to **EXTERNAL 1** you can only record a programme from your TV.

Only when a video recorder is connected to **EXTERNAL 2** it is possible to record a programme from your TV as well as from other connected equipment. See Record with your video recorder, p. 29.

Note: **EXTERNAL 1** can handle CVBS and RGB, **EXTERNAL 2** CVBS, Y/C and RGB, **EXTERNAL 3** only CVBS.

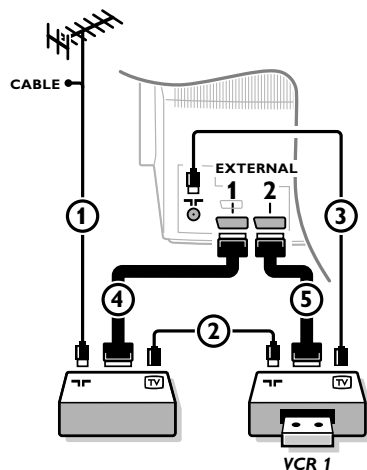

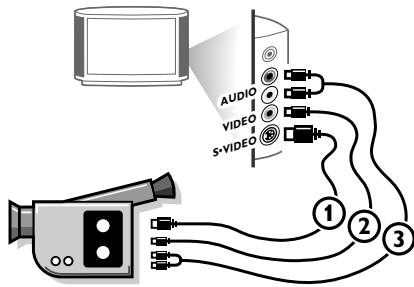

Camera & camcorder

- 1 Connect your camera or camcorder to sockets at the right side of your TV.
- 2 Connect the equipment to **VIDEO** ② and **AUDIO L** ③ for mono equipment.
Press the **I-II** key repeatedly to select the sound coming from one or both loudspeakers of your TV.
- 3 For stereo equipment also connect **AUDIO R** ③.

S-VHS quality with an S-VHS camcorder is obtained by connecting the S-VHS cables with the **S-VIDEO** input ① and **AUDIO** inputs ③.

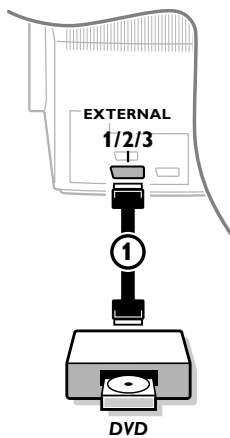

Digital equipment (DVD, digital satellite tuner,...)

Connect your digital equipment with a eurocable ① to one of the euroconnectors (**EXT1**, **EXT2** or **EXT3**), or with a cinch cable to the **VIDEO** input at the right side of the TV (see illustration above).

- 1 Press **Ⓞ** and **?** at the same time.

INSTALLATION
Menu language
Country
Automatic installation
Manual installation
Give name
Reshuffle
Favourite programmes
SETUP

SETUP
Digital sources
Decoder/Descrambler (Picture tilt)
Information line
Factory settings
Extra front speakers
Auto Surround on/off
NEXTVIEW provider none, 0...99
Auto format yes/no
INSTALLATION

- 2 Select **Digital sources** in the Setup menu of the **INSTALLATION** menu and select:
 - **None** if you have no digital source connected,
 - **EXT1**, **EXT2** or **EXT3** if you have connected your equipment to a euroconnector,
 - **FRONT** in case you connected to the right side of the TV,
- 3 Press the **Ⓞ** key to switch off all menus.

*Note: the low quality of some digital picture material may be the cause of digital image distortion. In this case select **Eco** under the **SMART PICTURE** key on the remote control as this setting is intended to improve distorted picture quality.*



Headphone

- 1 Insert the plug into the headphone socket at the right side of the TV.
- 2 Press **ⓧ** on the remote control to switch off the internal loudspeakers of the TV.

*The headphone impedance must be between 8 and 4000 Ohm.
The headphone socket has a 3.5 mm jack.*

In the **SOUND** menu select **Headphone volume** to adjust the headphone volume. See p. 12.

Connect Extra loudspeakers / Amplifier

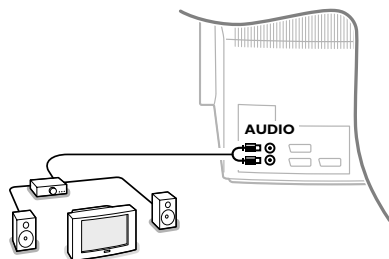

Stereo amplifier and two extra FRONT speakers

To enhance the sound reproduction of your TV you can connect two extra speakers via an external amplifier.

- 1 Connect the audio cables to the audio input of your amplifier and to **AUDIO L** and **R** at the back of your TV.

The output level is controlled by the volume control of your TV.

Note: Switch off the TV and your audio amplifier before connecting them.

Set the audio amplifier's volume to minimum.

- 2 Select **Extra front speakers Yes (Amp)** in the Setup menu. See p. 7. See Surround settings, p. 14 for the available Surround modes.

- 3 Adjust the volume of the audio amplifier.

You may make use of the Test tone function in the Surround Settings menu, see p. 13, to have a reference of the loudness of the separate loudspeakers.

Note: Once you have adjusted the volume of the amplifier, do not change it while watching TV as the whole configuration operates with the volume adjustment of your TV.

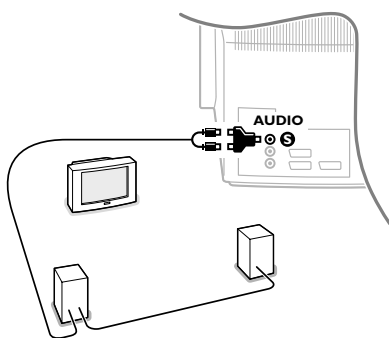

REAR multimedia loudspeakers

Instead of connecting the two supplied rear loudspeakers to enjoy Dolby Pro Logic Surround sound, you can also connect two other rear loudspeakers with built in amplifiers (or an audio amplifier with rear loudspeakers).

- 1 Connect the audio cables to the rear loudspeakers and to the Dolby surround output **S** at the back of your TV as shown opposite.

There is only one cinch output for both speakers. Use a mono to stereo adaptor.

Note: Switch off the TV and the rear loudspeakers before connecting them.

Rear Surround Sound loudspeakers should always be located behind or to either side of the listener at about 1 m above the seated listener's head.

- 2 Adjust the volume of the rear loudspeakers.

You may make use of the Test tone function in the Surround settings menu, see p. 13, to have a reference of the loudness of the separate loudspeakers.

Note: Once you have adjusted the volume of the rear loudspeakers, do not change it while watching TV as the whole configuration operates with the volume adjustment of your TV.

Dolby Pro Logic Surround amplifier

- 1 Connect the Dolby Pro Logic Surround amplifier to the **AUDIO L** and **R** at the back of your TV.

- 2 Select **Extra front speakers No** in the Setup menu. See p. 7.

The audio output is now independent of volume, equalizer and surround settings.

- 3 Switch off the volume of the TV with the mute key .

All volume settings, tone control and speaker connections have to be done via the external Dolby Pro Logic amplifier.

Attention: the sound info on screen will not correspond with the actual sound reproduction.

If you want to connect more equipment to your TV, consult your dealer.

To select connected equipment

easy LINK

If the TV is connected to a video recorder with the EasyLink function, in some cases the TV will be switched on, even when it was in standby. (E.g. playback tape,...)
This is not possible when Child lock On is selected.

Equipment connected with an aerial cable only :

Select the programme number under which you have stored the test signal with the digit keys.

Equipment connected to a euroconnector or to the right side of the TV

Press the  key repeatedly to select **EXT1**, **EXT2**, **EXT3** or **FRONT**, according to where you connected your equipment at the back or the right side of your TV.

Remark : Most equipment (decoder, video recorder, satellite receiver) carries out the switching itself.

If you want to change to TV channels?

Enter the programme number of the TV channel which you want to watch with the digit keys or press the **TV** key.

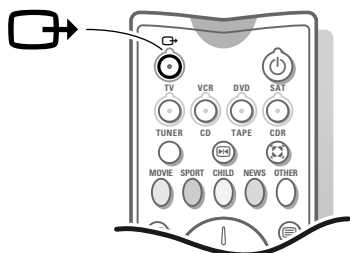

Audio and video equipment keys

Most of the audio and video equipment from our range of products can be operated with the remote control of your TV.

Press the **VCR**, **DVD**, **SAT**, **TUNER**, **CD**, **TAPE** or **CDR** key according to the equipment you want to operate with this remote control. See Use of the remote control, p. 9.

Video recorder

Press one of the video recorder keys after you pressed the **VCR** key:

- for record,
- ◀◀ for rewind,
- for stop,
- ▶ for play,
- ▶▶ for fast forward,
- /- for selecting 1- or 2-digit programme numbers from the video recorder,
- P + for sequential programme selection from the video recorder tuner,
- 0 to 9 to select a programme number from your video recorder tuner,
- ⏻ to switch the video recorder to standby
- 🕒 VCR timer

These keys function with equipment which use the RC5 signalling standard.

easy LINK

If your video recorder has the EasyLink function, the key **INSTANT** ● for recording, under the door of the remote control, can be operated in the TV mode.

If your EasyLink video recorder has the system standby function, when you press the ⏻ key for 3 seconds, both TV and the video recorder are switched to standby.

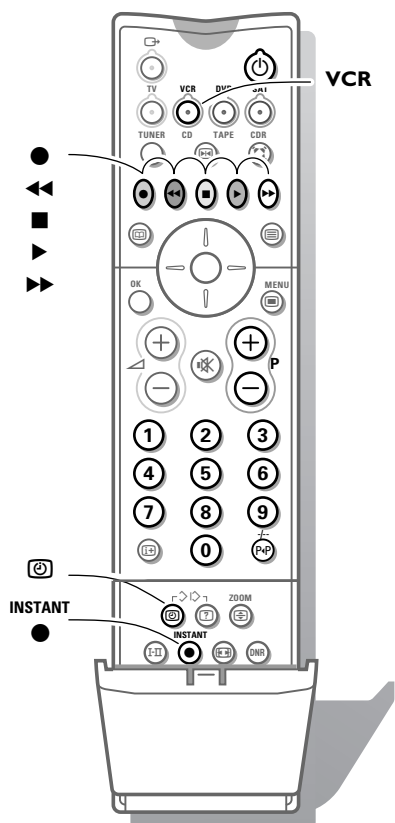

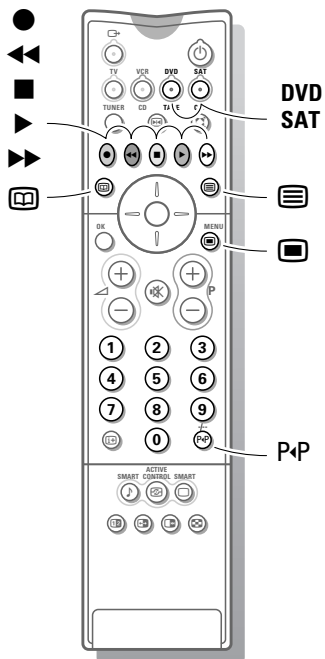

DVD keys

Press one of the following keys after you have pressed the **DVD** key.

- to switch the DVD menu on or off
- P+P** to select a DVD chapter
- to select a DVD title
- to select your choice of subtitle language
- to search down
- stop
- play
- to search forward
- pause
- 0-9** to select a programme number from your DVD

These keys function with equipment which use the RC6 signalling standard and with Philips DVD players.

Satellite receiver

Press one of the TV keys after you have pressed the **SAT** key.

These keys function with equipment which use the RC5 signalling standard.

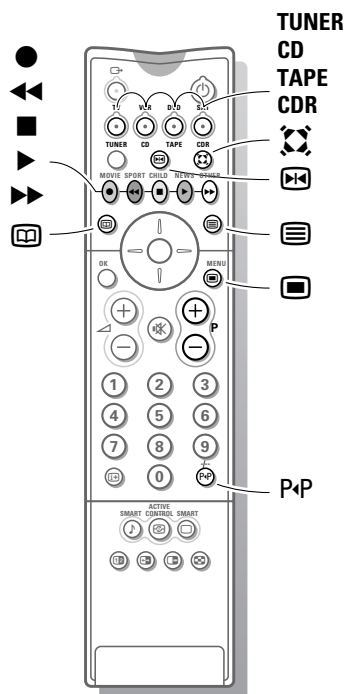

Tuner, CD, Tape and CDR keys

Press one of the following keys after you have pressed the **TUNER, CD, TAPE** or **CDR** key.

- to switch the menu on or off (tuner)
- P+P** to select a frequency (tuner)
- to record
- to search down (tuner); rewind (CD/tape); speed down (CDR)
- stop
- play
- to search up (tuner); forward (CD/tape); speed up (CDR)
- RDS display (tuner); info on screen (CD/CDR)
- RDS news/TA (tuner); select following disc (CD/CDR)
- pause (CD/CDR/tape)
- surround modes (CD/CDR/tape)
- + P -** next/previous (CD)

Record with your video recorder without EasyLink

To record S-VHS quality, connect an S-VHS peripheral directly to the video recorder.

Record a TV programme

- 1 Select the programme number on your video recorder.
- 2 Set your video recorder to record.
See the handbook for your video recorder.

Switching programme numbers on your TV does not disturb recording !

Record a programme on your video recorder connected to EXTERNAL 2 from Audio/Video equipment connected to EXTERNAL 1, EXTERNAL 3 or to sockets on the right side of the TV

- 1 Switch on the equipment.
- 2 Select the right external on your video recorder.
- 3 Set your video recorder to record.
You record what you are watching on the screen.

Do not switch programme numbers or do not switch off your TV when you are recording !

Record with your video recorder with EasyLink

easy LINK

If you have connected an S-VHS video recorder provided with the EasyLink function, you can record S-VHS-quality from an S-VHS peripheral connected to the right side of the TV. (E.g. from an S-VHS camcorder.)

In TV mode, it is possible to start a direct recording of the programme which is being displayed on the TV screen.

*Press the **INSTANT** ● record key, under the door of the remote control.*

The video recorder switches on from standby and a message of what is being recorded appears on the screen.

The video recorder starts recording the programme you are watching.

Switching programme numbers on your TV does not disturb recording !

When recording a programme from a peripheral connected to EXTERNAL 1, 3 or FRONT, you can not select another TV programme on the screen.

To watch TV programmes again, press the programme number you want to select twice.

Attention: the recording is stopped and your video recorder switches to standby.

If you switch to standby during recording of a programme from a peripheral connected to EXTERNAL 1, 3 or FRONT, the blinking lamp on the front of your TV indicates that you are still recording. The blinking stops after the recording is finished.

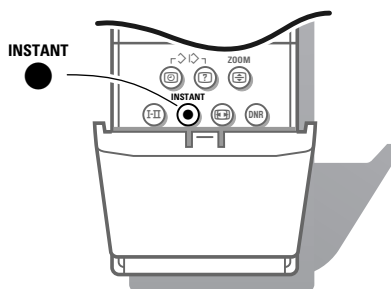

Record with your video recorder with NEXTVIEWLink



If your video recorder is equipped with NEXTVIEWLink, and you tagged one or more programmes to be recorded automatically in the NEXTVIEW mode, it is not necessary for the TV to be in the standby mode or switched on for the recording to start.

Tips

Care of the screen

Clean the TV with a slightly damp soft cloth. Do not use abrasive solvent as it can damage the TV screen.

Poor Picture

Have you selected the correct TV system? Is your TV or house aerial located too close to loudspeakers, non-earthed audio equipment or neon lights, etc.?

Mountains or high buildings can cause double pictures or ghost images.

Sometimes you can improve the picture quality by changing the direction of the aerial.

Is the picture or teletext unrecognisable? Check if you have entered the correct frequency. See Installation, p. 5.

Are brightness and contrast out of adjustment? Select Factory settings in the Setup menu, p. 7.

Sometimes poor picture quality is possible when having activated an S-VHS camera or camcorder connected to the right side of your TV and another peripheral is connected to **EXT1** or **EXT2** at the same time. In this case switch off one of the other peripherals.

No picture

Is the aerial connected properly? Are the plugs tightly connected in the aerial socket? Is the aerial cable in good condition and does it have suitable plugs?

Are the connection facilities to a possible second TV in good condition? If in doubt, consult your dealer.

No sound

No sound on any channel? Check the volume isn't at minimum. Is the sound interrupted with the mute key **M**? Check if your speaker configuration corresponds with the selections made in the Setup menu, p. 7. E.g. is your amplifier switched on when you have 2 extra front speakers connected?

No sound from the rear speakers or the centre speakers? Select an appropriate surround mode, according to the broadcasted sound signal or adjust the volume. See Surround modes, p. 14.

Remote control

If your TV no longer responds to the remote control, the batteries may be dead.

You can still use the **M** key and the **-/+** keys at the top of your TV.

Menu

Have you selected the wrong menu? Press the same key again to exit from the menu.

NEXTVIEW - No information

See Acquisition and updating of NEXTVIEW information, p. 20.

No solution

Switch your TV off and then on again once.

Never attempt to repair a defective TV yourself.

Check with your dealer or call a TV technician.

End of life directives

Philips is paying a lot of attention to produce environmentally-friendly in green focal areas. Your new TV contains materials which can be recycled and reused.

At the end of its life specialised companies can dismantle the discarded TV to concentrate the reusable materials and to minimise the amount of materials to be disposed of.

Please ensure you dispose of your old TV according to local regulations.

How to dispose of dead batteries?

The batteries supplied do not contain the heavy metals mercury and cadmium. Nevertheless in many countries dead batteries may not be disposed of with your household waste. Please ensure you dispose of dead batteries according to local regulations.

Index

- a** ACI, 5
 - active control, 10
 - auto format, 8
 - automatic installation, 5
 - auto surround, 8
- b** bilingual broadcast, 11
- c** camcorder, 25
 - centre volume, 13
 - child lock, 15
 - continuous subtitles, 23
 - country, 4
- d** decoder/descrambler, 7
 - digital scan, 12
 - digital sources, 25
 - DNR, 11
 - dolby surround settings, 13
 - dolby 3 Stereo, 14
 - dual screen, 10
 - DVD, 28
 - dynamic contrast, 12
- e** easy text, 21
 - eurocable, 24
- f** factory settings, 7
 - favourite programmes, 6
 - freeze, 9
 - frequency, 5
 - front speakers, 7
- g** give name, 6
 - graphic equalizer, 12
- h** hall, 14
 - headphone volume, 12
 - hue, 12
- i** info on screen, 9
 - information line, 7
 - interrupt the sound, 9
- l** language, 4
- m** manual installation, 5
 - menu language, 4
- n** NEXTVIEW, 16
 - NEXTVIEW provider, 8
 - nicam, 11
- p** picture adjustments, 12
 - picture format, 11
 - picture tilt, 7
 - programme selection, 9
 - programme list, 15
- Pro Logic, 14
- r** recording, 29
 - reshuffle, 6
- s** satellite receiver, 28
 - search for TV channels, 5
 - setup, 7
 - sleeptimer, 15
 - smart picture and sound, 11
 - sound adjustments, 12
 - stereo, 11
 - stereo (+ amp), 14
 - store TV channels, 4
 - strobe, 10
 - subpages teletext, 22
 - surround mode, 14
 - S-VHS, 29
 - switch TV on, 3
- t** teletext, 21
- v** video recorder, 24
 - volume, 9
 - 3D effect, 13
 - 3D surround, 14

Glossary

100 Hz

100 Hertz provides a superior solution to the problem of picture flicker which is particularly noticeable with larger screen sizes. In a conventional TV, the picture area is scanned 50 times a second (50 Hertz) – a frequency which is still detectable by the human eye in the form of a flickering picture. In 100 Hertz sets, the picture area is scanned at a rate of 100 times per second (100 Hertz). At this frequency, the eye cannot detect flicker, resulting in a clearer picture which is more relaxing to the eye.

Automatic Channel Installation (ACI)

Automatically installs all TV channels in the same order as offered by your cable company, provided of course that the data is transmitted. It also automatically includes programme number and programme name. With ACI, channel installation is fully automatic, simple and fast.

Child lock

Feature to prevent unauthorised use of your TV.

Digital Scan

If you look at a television screen you will see small imperfections in the picture caused by line vibration. Digital Scan (an internal process) removes interline flicker. When combined with 100 Hz, you will see a totally stable image.

DNR

Digital Noise Reduction.

By encoding signals digitally in 100 Hz sets, it is possible to clean up picture noise. This is especially beneficial in poor signal areas and when viewing poor quality video tapes.

Dolby Surround Pro Logic

Literally wraps you in 4-channel sound. It brings your favourite movies to life with all the realism and impact of cinema sound as though you are part of the action.

Easy Link

Digital 'intelligent' ESI bus-system between TV and VCR (Scart connection required). Turns source selection and control into a one-button operation.

Easy Text

Teletext memory that automatically memorises Teletext pages and gives you instant access to them.

Euroconnector

A 21-pin connector system enabling you to simply connect various types of audio/video and computer equipment.

Menu

On-screen display of functions and facilities in a well-organised survey, which you can select using your remote control.

NEXTVIEW

NEXTVIEW is a new feature to assist the TV and VCR user in selecting the programmes she or he likes to watch from a television programme guide on the screen. It enables the user to see a description of every programme, and mark interesting programmes to be reminded (auto TV on) or recorded (NEXTVIEWLink video recorder required).

NTSC

The broadcasting system used in the USA, Japan and parts of South America and Southeast-Asia.

Smart Picture and Sound controls

Keys on the remote control to select predefined picture and sound settings.

Sleeptimer

Function with which you can set a time period after which the TV should switch itself to standby.

Picture Freeze

TV mode which allows you to "freeze" a certain image in order to study a specific detail at ease, e.g. to make notes of certain programme information like phone numbers.

Teletext

See also Easy Text

WST: World Standard Teletext.

FLOF: Full Level one Features. System applied by the BBC, RVE.... that provides a fast access to the teletext pages.

TOP: Table of (Teletext) Pages. German system for an easy access to the teletext pages.

Tint

TV-function to modify the general colour balance between cool and warm and to adjust it according to your personal preference.