

# Contents

---

## Installation

- Your remote control **2**
- Preparation **3**
- Installation **4**
- Store TV channels **4**
  - Select the menu language and country **4**
  - Automatic installation **5**
  - Manual installation **5**
- Give name **6**
- Reshuffle the programme list **6**
- Select favourite TV channels **6**
- Install TV setup **7-8**

---

## Operation

- Use of the remote control **9-10**
- Use of the menus
  - Picture menu **11**
  - Sound menu **11**
  - Features menu **12**
- Dual Screen **13**
- NEXTVIEW **14-17**
- Teletext **18-20**
  
- The keys on top of the TV **20**

---

## Connect peripheral equipment

- Connecting and selecting equipment **21-24**
- Remote control functions for peripherals **24-25**
- Recording **26**

- Tips 27**
- Index 27**
- Glossary 28**



EasyLink features are based on the "one touch operation" approach. This means that a sequence of actions are executed at the same time in both the television and the video cassette recorder, **provided both are fitted with the EasyLink function** and connected with the eurocable supplied with your video recorder.

# Preparation

## Your remote control

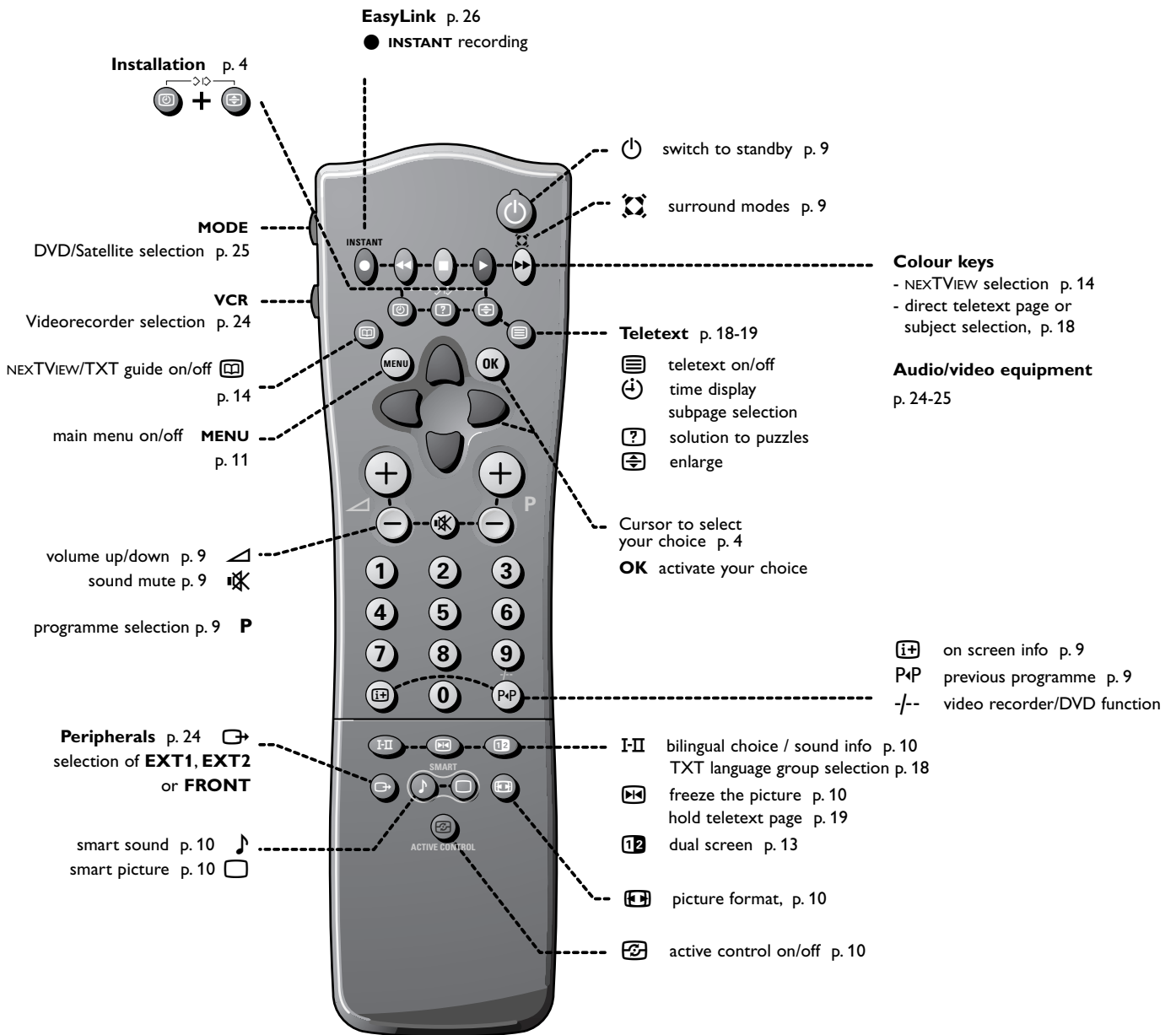

## Preparation

- 1 Place the TV on a solid surface.**  
For ventilation, leave at least 5 cm free all around the TV.  
Do not place the TV on a carpet.  
To prevent any unsafe situations, do not place any objects on top of the TV.  
Avoid heat, direct sunlight and exposure to rain or water.
- 2 Insert the aerial plug firmly into the aerial socket**  **at the back of the TV.**

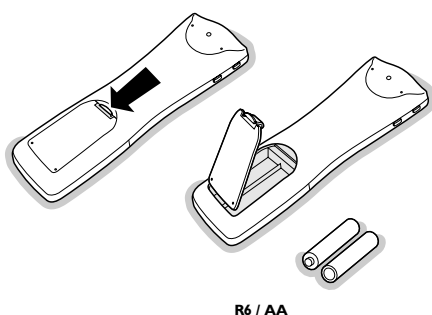
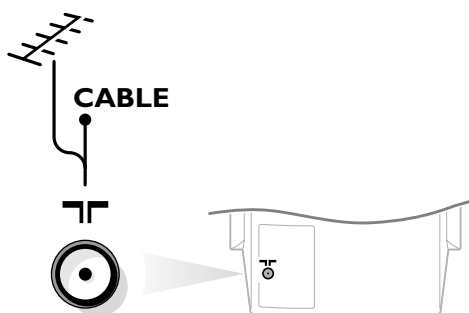

R6 / AA

- 3 Insert the mains plug in the wall socket having a mains voltage of 220V-240V.**  
To prevent damaging the mains (AC) cord which could cause a fire or electric shock, do not place the TV on the cord.
- 4 Remote control: Remove the cover of the battery compartment.**  
Insert the 2 batteries supplied (Type R6-1.5V).

*The batteries supplied do not contain the heavy metals mercury and cadmium. Nevertheless in many countries exhausted batteries may not be disposed of with your household waste. Please check on how to dispose of exhausted batteries according to local regulations.*

*Note: this remote control functions with TVs which use the RC6 signalling standard.*

- 5 Switch the TV on :** Press the power switch  on the front of your TV. A red indicator on the front of the TV lights up and the screen comes on. If the TV is in standby mode (see p. 9), press the **-P+** key on the remote control.  
*The red lamp blinks every time you press a key on the remote control.  
When you switch on your set for the first time, the menu LANGUAGE automatically appears on the screen. The explanation appears in different languages one at a time. Choose your own language and press the OK key on the remote control.*

Go on to page 4, Store TV channels.

# Installation

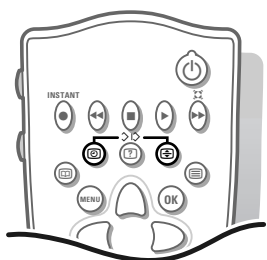

## Select the INSTALLATION menu

Press and at the same time.

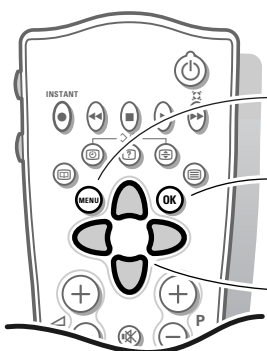

return or switch main menu off

activate

select menu item

## To use the menus

- 1 Use the cursor in the up/down, left/right directions to select a menu item.
- 2 Press the **OK** key to activate.
- 3 Use the **MENU** key to return or to switch the menu off.

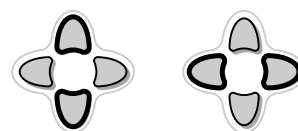

# Store TV channels



After the new or extra TV channels have been stored, the TV automatically transfers those TV channels to the video recorder if it is equipped with the EasyLink function. The message **EasyLink : downloading .....** appears on the screen. The programme list of the video recorder is now the same as the one of the TV. If the TV is connected to a video recorder which supports the NEXTVIEWLink function, the TV also automatically transfers the language and country selections to the video recorder.

## Select the menu language and country

First, select your language and country.

- 1 Select **Menu language** and press the **OK** key.
- 2 Select your language and press the **OK** key. Use the cursor up/down to scroll through the list and to bring up other languages which are not displayed on the screen at present.
- 3 Select **Country** and press the **OK** key.
- 4 Select the country where you are now located and press the **OK** key. Use the cursor up/down to scroll through the list and bring up other countries which are not displayed on the screen at present.

Select **Other** when none of the countries applies.

You can now search for and store the TV channels in two different ways: using **automatic installation** or **manual installation** (tuning-in channel by channel).

Select your choice and press the **OK** key.

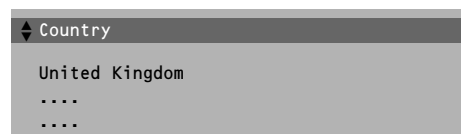
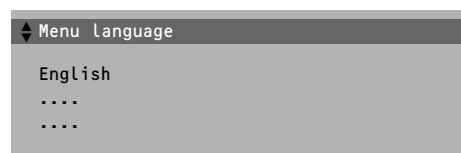

## Automatic installation

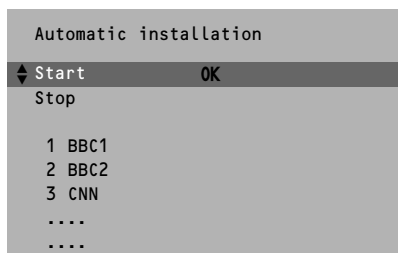
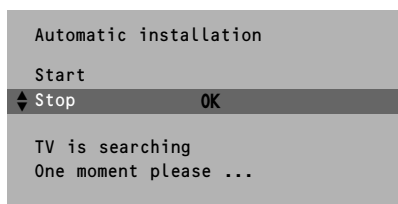

In the Automatic installation menu select **Start** and press the **OK** key to activate the searching. All TV channels are searched for and stored automatically.

If a cable system which broadcasts ACI (Automatic Channel Installation) or a TV channel transmitting a teletext page with the frequencies and programme names of all the TV channels which can be received, is detected, the search is stopped and a programme list appears.

The programme list is automatically filled with all the programme numbers and names of the TV channels transmitted.

*It is possible that the cable company or the TV channel displays a broadcast selection menu. Layout and items are defined by the cable company or the TV channel. Make your choice with the cursor and press the **OK** key.*

To exit from the menu press the **MENU** key on the remote control.

Go on to page 6.

## Manual installation

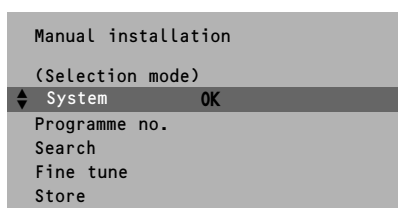

Searching for and storing TV channels is done channel by channel. You must go through every step of the Manual installation menu.

**Selection mode** is only present and lights up if the country selected also offers the channel option (C-channels for aerial channels, S-channels for cable channels).

You can choose either channel or frequency mode.

- 1 Select the TV system  
Select the country or part of the world from where you want to receive the TV channel.  
If you are connected to a cable system, select your country or part of the world where you are now located.
- 2 Press the cursor down and enter the programme number with the digit keys.
- 3 Search for a TV channel  
Press the cursor left/right.  
The frequency or the channel number increases until a TV channel is found.

### Direct selection of a TV channel

If you know the frequency, the C- or S-channel number, enter it directly with the digit keys 0 to 9.

Ask for a list from your cable company or dealer; alternatively consult the Table of frequencies on the inside backcover of this handbook.

- 4 Fine tune  
In case of poor reception, you can improve the reception by adjusting the frequency with the cursor left/right.
- 5 To store your TV channel, select **Store** and press the **OK** key.

Repeat steps 1 to 5 to store another TV channel.

- 6 To exit from the menu press the **MENU** key on the remote control.

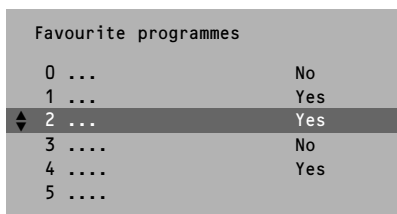
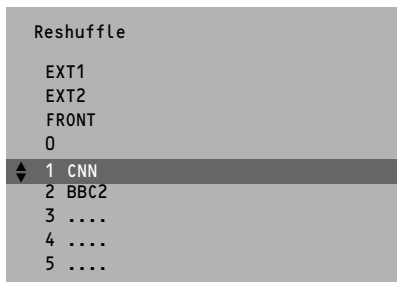
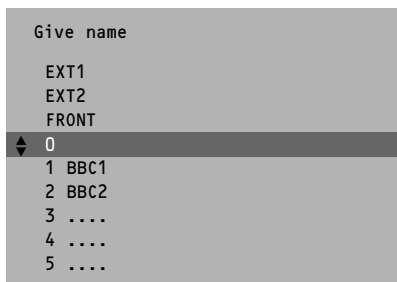
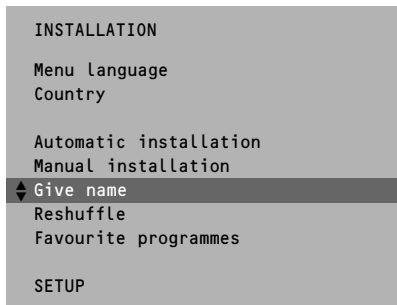

## Give name

It is possible to change the name stored in the memory or to assign a name to a TV channel which has not yet been entered. A name with up to 5 letters or numbers can be given to the programme numbers 0 to 99. For example SUPER, BBC1,... Between 99 and 0 you can also name any peripherals that are connected to a euroconnector.

- 1 Select **Give name** in the **INSTALLATION** menu and press the **OK** key.
- 2 Select the programme number.
- 3 Press the **OK** key.
- 4 Select the character with the cursor up/down.
- 5 Select the following position with the cursor right.
- 6 Select the following character.
- 7 Press the **OK** key when finished.
- 8 Press the **MENU** key to return to the **INSTALLATION** menu.

Space, numbers and other special characters are located between Z and A.

## Reshuffle the programme list

According to your preference you **can** change the order of the stored TV channels.

- 1 Select **Reshuffle** in the **INSTALLATION** menu and press the **OK** key.
- 2 Select the programme number you want to exchange.
- 3 Press the **OK** key.
- 4 Select the new number you want to exchange it with.
- 5 Press the **OK** key.  
Repeat the operation until all TV channels are allocated as you like.
- 6 Press the **MENU** key to return to the **INSTALLATION** menu.

## Select Favourite TV channels

After leaving the installation you can browse through the TV channels by pressing the - **P** + key. Only those TV channels which are in the favourite list will be displayed. Non-favourite TV channels can still be selected with the digit keys. By default all stored channels are added to the favourite list.

- 1 Select **Favourite programmes** in the **INSTALLATION** menu and press the **OK** key.
- 2 Select your favourite programme number.
- 3 Select **Yes** or **No** with the cursor left/right.
- 4 Repeat for every TV channel you want to make a favourite or a non-favourite TV channel.
- 5 Press the **MENU** key to return to the **INSTALLATION** menu.



In order for **NEXTVIEW** to function properly, the first TV channel from the favourite list should also broadcast the correct local date and time via teletext.

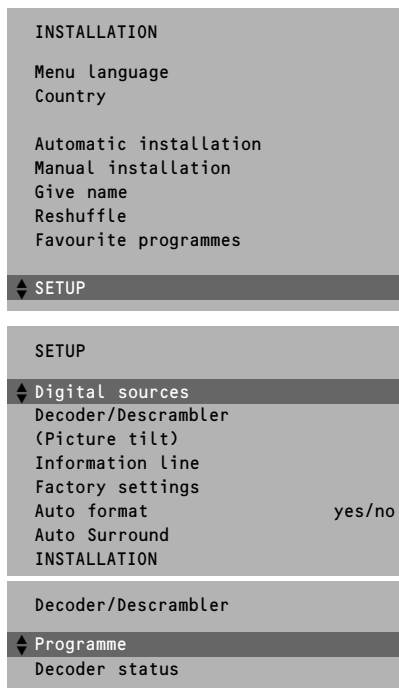

## Install TV Setup

The Setup menu allows you to adjust initial settings, i.e. those which are not related to the installation of the TV channels. The Setup menu contains items that control the settings of the TV's functions, features, services and peripherals you may have connected.

- 1 Use the cursor in the up/down, left/right directions to select the menu item.
- 2 Use the **OK** key to activate.
- 3 Use the **MENU** key to return or switch menu off.

### Digital sources

See Connect Peripheral Equipment, p. 22 to connect your digital equipment, like a DVD, a digital satellite tuner or a similar digital device.

### Define Decoder/Descrambler programme numbers

If a decoder or a descrambler is connected, see p. 21 you can define one or more programme numbers as decoder programme numbers.

Press the cursor left/right to select the input used to connect to your decoder **Off**, **EXT1** or **EXT2**.

Select **Off** if you do not want the selected programme number being activated as a decoder programme number.

Select **EXT2** when the decoder is connected to your EasyLink video recorder. When selecting the decoder, the message **EasyLink: downloading presets....** appears on the screen.

### Picture tilt (if provided)

Select **Picture tilt** with the cursor up/down.

Keep the cursor left/right pressed to adjust the rotation of the picture.

### Information line

Select **On** and after the selection of a TV programme or after pressing the **i+** key on the remote control, a TV channel which broadcasts teletext may transmit the name of the TV channel, the programme name or another message. This is displayed on screen next to information about sound and picture format.

When selected **Off**, only sound and picture format information is displayed after the selection of a TV channel or after pressing the **i+** key.

### Factory settings

Select **Factory settings** and press the **OK** key to restore picture and sound settings, predefined in the factory.

### Auto format

Selecting **Yes** causes the screen to automatically fill as much of the picture as possible when TV programmes are not carrying special signals detecting the correct screen format.

With the **OK** key on the remote control you can still select other picture formats. See p. 10.



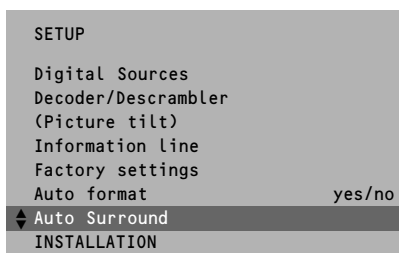

### Auto Surround

Sometimes the broadcaster transmits special signals for Surround Sound encoded programmes. In that case, the TV automatically switches to the best Surround Sound mode when Auto Surround is switched on. Virtual Dolby\* Surround will be reproduced, see p. 9.

Overruling this surround mode remains possible.

### Installation

Select **Installation** and press the **OK** key to return immediately to the **INSTALLATION** menu.

- 4 To exit from the menu press the **MENU** key repeatedly.

\* 'Dolby' and the double-D symbol  are trademarks of Dolby Laboratories.  
Manufactured under license from Dolby Laboratories .



# Operation

## Use of the remote control

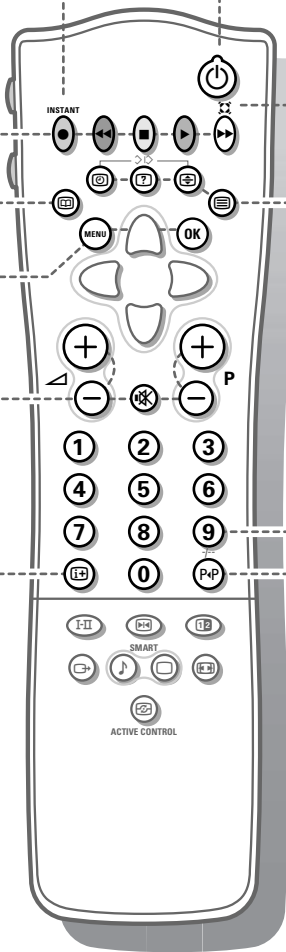

**Instant record**  
 If your video recorder has the EasyLink function the **INSTANT** key for record can be operated in the TV mode.

**Video recorder** see p. 24

**NEXTVIEW/TXT guide** on/off see p. 14

**MENU Main menu** on/off see p. 11  
**OK** Press this key to activate your choice, when in the menus.

**Volume**  
 Press + or - to adjust the volume.  
**Mute**  
 Temporarily interrupt the sound or restore it.

**P Programme selection**  
 To browse through the TV channels activated in the Favourite Programme menu.

**Screen information**  
 Press for 5 seconds to activate/de-activate the extended or reduced display of TV channel and programme information on the screen.  
 Press briefly to display information about the selected TV channel and programme, the sound reception, picture settings and the remaining time set with the sleep timer.

**Standby**  
 The set is switched off. To switch the TV on again, press - **P +** or the digit keys. If your EasyLink video recorder has the system standby function and you press the standby key for 3 seconds, both the TV and video recorder are switched to standby. Your TV consumes energy in the standby mode. Energy consumption contributes to air and water pollution. We advise to switch off your TV overnight instead of leaving it on standby. You save energy.

**Surround modes**  
**Incredible Surround**  
 • In **MONO** sound mode, this feature, when switched on, enables you to hear a spatial effect of sound.  
 • In **STEREO** sound mode, when **Incredible Surround** is selected, it seems as though the loudspeakers are spread further apart from one another.  
**Virtual Dolby Surround** (optimal with Dolby Surround signals)  
 Virtual Dolby Surround enables you to experience the effect of Dolby Surround Pro Logic, reproducing a rear sound effect

**Teletext** on/off see p. 18  
**Teletext functions** see p. 19  
**Time display**  
 The time, downloaded from the TV channel (with teletext) stored on programme number 1 or the lowest favourite programme number, is displayed on the screen.  
 This function is not available when continuous subtitles have been switched on.

**0/9 Digit keys**  
 To select a TV channel.  
 For a two digit programme number, enter the second digit within 2 seconds.  
 To switch immediately to a selected one digit TV channel, keep the digit key pressed a bit longer.  
**P/P Previous programme**  
 The previously selected TV channel is displayed. The -/- indication is only video recorder/DVD.

### **Select peripherals**

Press this key repeatedly to select **EXT1**, **EXT2** or **FRONT**, according to where you connected the peripherals (p. 24).

### **Smart Keys**

To select predefined picture and sound settings.

#### **Smart Sound**

Each time it is pressed, a different sound setting is selected, corresponding with specific factory setting of the equalizer.

#### **Smart Picture**

Each time it is pressed, a different picture setting is selected, corresponding with specific factory settings of Contrast, Colour, Sharpness and Dynamic Contrast.

**Personal** refers to the personal preference settings of picture and sound selected in the picture and sound menu.

*Remark: the moment you are in a predefined smart sound or picture setting and you modify a setting in the picture or sound menu, all values of the menu will overwrite the previously made settings.*

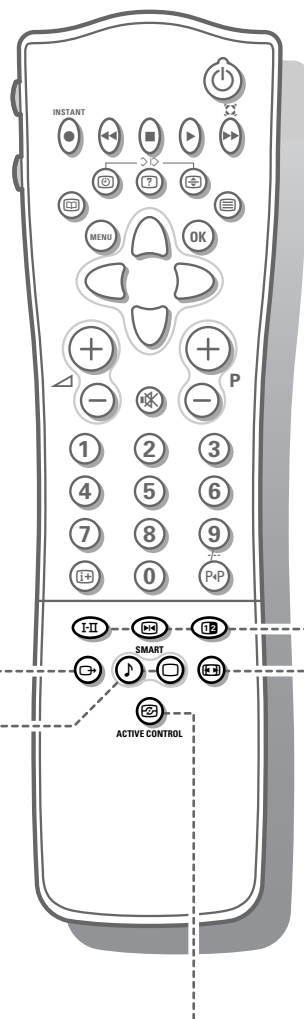

### **I-II Bilingual choice and sound mode selection**

Press this key

- to switch from **Stereo** to **Mono** sound, in case of stereo transmission, or from **Nicam Stereo** to **Nicam available**, in case of digital transmission;
- to choose between language I (Dual I) or language II (Dual II), in case of bilingual transmission. The setting is separately stored for each TV channel.

### **Freeze**

To activate/de-activate the frozen picture or to hold a teletext page.

### **Dual screen**, see p. 13

### **Picture format**

Press this key repeatedly to select another picture format: 4:3, Movie Expand 14:9, Movie Expand 16:9 with or without subtitling, Wide Screen, Super Zoom or Automatic (when Auto format is set to Yes in the **SETUP** menu).

Automatic makes the picture to fill the screen as much as possible.

Sometimes also video recorder programmes carry special signals which will automatically switch the TV to the correct screen format.

*Auto format is disabled when in Dual screen.*

When in Movie Expand 14:9 or 16:9 or Super Zoom picture format you can make subtitles visible with the cursor up/down.

### **Active control**

Active control is a pro-active and automatic system. The TV continuously measures and corrects all incoming signals in order to provide the best picture possible.

Press the  key to select the Active Control values Off or On.

**Off** Sharpness and Dynamic Contrast are controlled automatically

**On** Sharpness, Dynamic Contrast and Noise Reduction are controlled automatically.

Press the cursor in the up/down directions while the selected Active Control setting information is on top of the screen.

The Active Control menu appears.

The picture settings are being adapted continuously and automatically.

The menu items cannot be selected.

Press the cursor in the up/down directions again to switch off the menu.

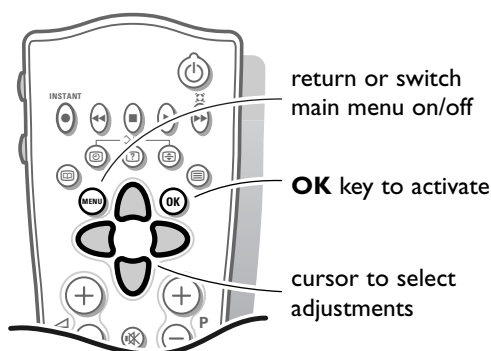

## Use of the menus

- 1 Press the **MENU** key to display/cancel the **MAIN MENU**.
- 2 Use the cursor in the up/down directions to select the **PICTURE**, **SOUND** or **FEATURES** menu or to select the **PROGRAMMES**.
- 3 Press the cursor right to activate the selected menu.
- 4 Use the cursor in the up/down, left/right directions to select the menu item.
- 5 Use the **OK** key to activate.
- 6 Press the **MENU** key repeatedly to return or to switch the menu off.

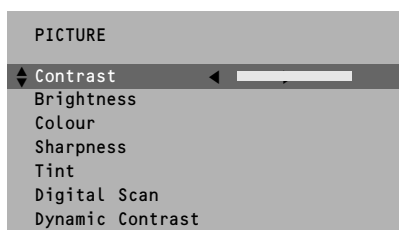

## Picture menu

If an NTSC peripheral is connected to one of the euroconnectors, the option Hue also appears.

### Tint

Select the colour temperature: **Normal**, **Warm** or **Cool**.

### Digital Scan (Line Flicker Reduction)

In certain circumstances while watching TV programmes it may be preferable to switch off the digital scan line flicker reduction.

Press the cursor left/right to select **On** or **Off**.

### Dynamic Contrast

To make the contrast in the darker and the brighter picture areas more noticeable, select the **Med** setting.

In certain circumstances it may be preferred to select **Min**, **Max** or **Off**.

The modified adjustments for Contrast, Brightness, Colour, Sharpness, Tint, Digital Scan and Dynamic Contrast are automatically stored for all TV channels.

Select **Factory settings** in the Setup menu to restore the predefined factory settings, see p. 7.

## Sound menu

The modified adjustments for Volume, Balance, Treble and Bass are automatically stored for all TV channels.

Select **Factory settings** in the Setup menu to restore the predefined factory settings, see p. 7.

### Graphic Equalizer

Here you can select the preferred sound setting which corresponds with the personal sound settings.

### Headphone volume

See Connect Peripheral Equipment, p. 23, for the connection of the headphone.

### AVL (Automatic Volume Leveller)

AVL automatically controls the volume level to avoid too large level differences, especially when switching to another programme or during commercial breaks.

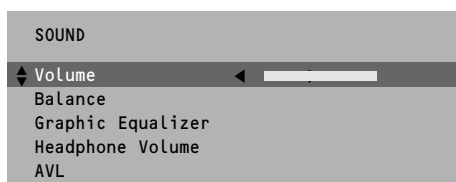

## Features menu

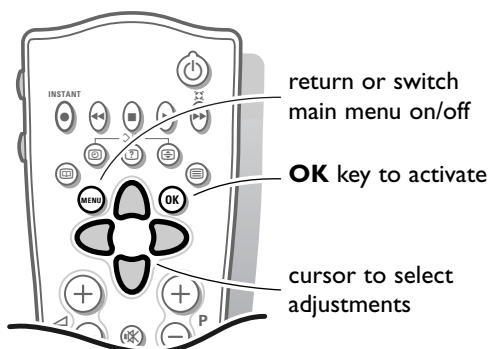

FEATURES	
Sleeptimer	Off
Child lock	Off
Subtitle	Off

- 1 Press the **MENU** key to display/cancel the **MAIN MENU**.
- 2 Use the cursor in the up/down directions to select the **FEATURES** menu.
- 3 Press the cursor right to activate the selected menu.
- 4 Use the cursor in the up/down directions to select a menu item.
- 5 Use the cursor in the left/right directions to select the desired setting.

### Sleeptimer

With the sleeptimer you can set a time period after which the TV should switch itself to standby.

The counter runs from **Off** up to **180 min.**

One minute before the TV is set to go to standby, the remaining seconds appear on screen. Not visible in dual screen mode. You can always switch off your set earlier or change the set time.

### Child lock

If the child lock is on, the TV can only be switched on with the remote control. The **P** - and + keys on top of the TV cannot be used to select a TV channel. In this way you can prevent unauthorised use of your TV.

If the message **Child lock On** appears, the child lock must be switched off before you can use the **P** - and + keys on top of the TV to select a TV channel.

### Subtitle

TV channels with teletext often transmit certain programmes with subtitling. See Teletext, Continuous Subtitles, p. 20 how to select the proper subtitle page from the teletext index.

Select **Subtitle On** or **Off**.

Press the **MENU** key to switch off the Features menu.

## Programme list

- 1 Press the **MENU** key to display/cancel the **MAIN MENU**.
- 2 Select **PROGRAMMES** with the cursor up/down.
- 3 Press the cursor right to display an overview of all the TV channels installed.
- 4 Press the cursor up/down to run through the list and press **OK** to select the desired TV channel.
- 5 Press the **MENU** key to switch off the Programme list.

## Dual Screen

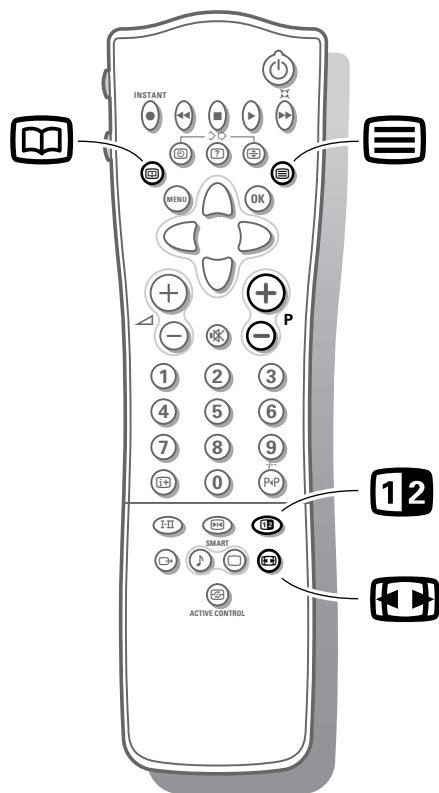

- 1 Press the **12** key to switch on Dual Screen.  
The TV screen is divided into 2 parts:
  - the left side for the normal main picture,
  - the right side for teletext broadcast by the selected TV channel or for NEXTVIEW/Teletext Guide.To operate NEXTVIEW/Teletext Guide, see p. 14.  
To operate teletext, see p. 18.  
*If Dual Screen is Off, the picture, teletext or NEXTVIEW/Teletext Guide are displayed full screen.*
- 2 Press the **P** key to select a vertical squeezed or a non vertical squeezed picture size
- 3 Press **+ P** - to run through the teletext pages.
- 4 When in Teletext Dual Screen, press the **12** key to return to a full picture screen or press the **12** key to return to a full Teletext screen.
- 5 When in NEXTVIEW/Teletext Guide Dual Screen, press the **12** key to return to a full picture screen or press the **12** key to return to a full NEXTVIEW/Teletext Guide screen.

## NEXTVIEW / Teletext Guide

Today, most broadcasters in Europe, are offering teletext pages containing their programme schedule of today. These pages can be requested by switching the TV to **Teletext Guide**.

An increasing number of broadcasters are offering an extended programme guide service called **NEXTVIEW**. NEXTVIEW is a new way of presenting programme schedules and offers more features than common teletext. With NEXTVIEW it is possible to show for instance all the movies coming tonight.

Both facilities are integrated in this TV: NEXTVIEW and Teletext Programme Guide. If a TV channel supports NEXTVIEW then the TV will automatically present the NEXTVIEW programme schedule. If the TV channel supports just teletext, then the TV will switch automatically to Teletext Guide.

Both facilities are offering the same functions: record, remind and info. However in case of Teletext Guide the broadcaster is responsible if these functions are possible.

You can search for the programmes you want to watch up to 7 days in advance. It is also possible to search for a programme by theme, e.g. sport, movie, etc. Once a programme has been selected it can be tagged, to remind you, or to record on the video recorder automatically (provided the video recorder is equipped with NEXTVIEWLink Level 20), once, daily, weekly or series. Teletext Guide/NEXTVIEW also allows direct access to detailed information about programmes if provided by the broadcaster.

*The broadcaster is responsible for the contents of the information.*

*The TV is responsible for the capture of that information and for the presentation to the user.*

### Use of the Teletext Guide/NEXTVIEW menus

- 1 Press the  key on the remote control to display/cancel the Teletext Guide/NEXTVIEW menu.
- 2 Use the cursor in the up/down, left/right directions to select the date, **CHANNEL** for the channel guide, **THEME** for the theme guide, **OVERVIEW** for an overview of all the programmes which are marked as reminders or for recording, the programme guide page number or to enter the programme list.

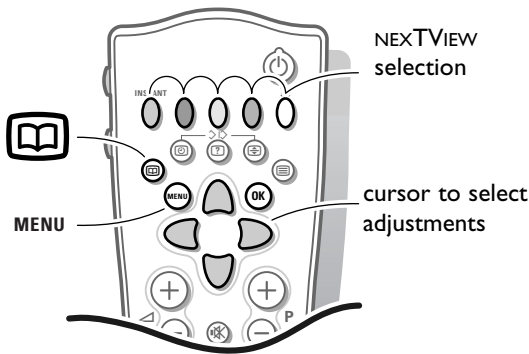

#### Teletext Guide

	Channel	Overview
	BBC1	BBC2
	p.202	◀ 01 02 ... ▶
Record	BBC1	
Remind	11.03	.....
Info	14.35	..... 226/3
	17.50	..... 231

- 3 Enter the proper programme guide page number with the digit keys or with the **- P +** keys.
- 4 Press the cursor left/right to run through the subpages.
- 5 Select a programme with the cursor up/down.
- 6 Press one of the colour keys to select one of the basic functions (if available); **record**, **remind**, **info**. See Basic functions further on.
- 7 Press the **OK** key to return to the header area again.

#### NEXTVIEW

	Monday 9 Oct	18:03
	Channel	Theme Overview
	BBC1	NEXTVIEW
Record		
Remind	What's on now	
Info	Preview	
	Themes	
	Ratings	

- 3 Select a programme with the cursor up/down.
- 4 Press one of the colour keys to select one of the basic functions (if available); **record**, **remind**, **info**. See Basic functions further on.
- 5 Press the **OK** key to return to the header area again.

	Channel	Theme	Overview
	BBC 1	BBC 2	CNN
	p.202	◀ 01 02 ... ▶	
Record		BBC 2	
Remind	11.03	.....	
Info	14.35	.....	226/3
	17.50	.....	231
	One moment please		

## Teletext guide

TV channels which broadcast teletext also transmit a page with the programme guide of the day. For each selected TV channel the programme guide page can be selected with the  key:

- automatically if the selected TV channel supports services like PDC (Programme Delivery Control) or MIP (Magazine Inventory Page).
- if automatic pre-selection is not possible then the index page is displayed and the proper programme guide page number of the selected TV channel has to be entered with the digit keys.

The programme guide page will be stored automatically only if it satisfies Video Programming via Teletext (VPT) requirements.

Every time you press the  key, the programme guide page of the selected TV channel will be available if the TV channel does not support NEXTVIEW.

The function items record, remind and info, corresponding with the coloured keys, become highlighted if the displayed programme page satisfies the Video Programming via Teletext (VPT) requirements. Select a programme item and press one of the function keys, e.g. Record or Remind. See Basic functions further on.

The Info item is enabled if the selected programme contains a page number with an optional subcode referring to a page with more info about the programme.

	Channel	Theme	Overview
	BBC1	CNN	BBC2
Record		BBC1	NEXTVIEW
Remind			
Info			
	.....		
	.....		
	.....		

## NEXTVIEW modes to sort and represent information

### Channel

The Channel guide provides an overview of all programmes that are broadcast by a single channel during one day.

Already passed programmes can be made visible via cursor up.

The list will start with the earliest broadcast programme.

With cursor left/right another favourite TV channel can be selected.

	Channel	Theme	Overview
	Culture	Movie	....
Record		BBC1	NEXTVIEW
Remind			
Info			
	BBC1		
	CNN		
	TVE		

### Theme

The theme guide displays a list of all programmes at the selected date, that matches with the selected category (news, sport, culture, movies, ...).

The default starting item will be the current or next programme on the current TV channel.

The **THEME** selection is only present if programmes in the TV guide have defined themes.

### Overview

The Overview menu provides a list of programmes that are marked as reminders or to be recorded each day.

When more than one programme to be recorded has an overlap in time, these programmes will be marked by a red colour.

After the programme has been broadcast, all items set for once will be deleted from the list the following day. This menu can be used to change a reminder or recorder.

*Note: the TV will automatically interpret the broadcast time (as shown on the teletext guide) of your selected programme into the correct local time and date.*

	Channel	Theme	Overview
	BBC1		NEXTVIEW
Record			
Remind	BBC1	17.10	
Info	CNN	17.30	
	TVE	18.05	
	BBC2	19.00	

	Date	time
CHANNEL	THEME	OVERVIEW
Record		
Remind	11.03	Travel Guide <b>R</b>
Info	14.35	World news <b>◆</b>
	◀Once▶	Daily Weekly Clear
	17.50	Insight
	.....	
		Info block

## Basic functions

The functions Record, Remind and Info can be activated with the corresponding colour keys on the remote control. If the function is not available, then the text is shown at reduced brightness. Select a programme with the cursor up/down.

### Record **R** or Remind **◆**

- 1 Press the red colour key to activate **Record** or the green colour key to activate **Remind**.

*If the programme number of the broadcaster is not yet known, a message appears with the request to input the correct programme number with the cursor left/right and press OK.*

A small menu pops up in which you can choose the interval: once, daily or weekly, or clear an earlier made record or remind setting. The default interval is set to **Once**. If a programme is an episode of a series, it is identified by the system and the options **daily** and **weekly** are replaced by the option **series**. In this case the system identifies when the next episode of the series will be broadcast. This is not possible in the Teletext guide.

- 2 Use the cursor in the left/right directions to select the interval. The colour of the tag refers to the interval.
- 3 Press the **OK** key.

When **Record **R**** is activated:

**Storing** is displayed to indicate the video recorder is programmed.

When **Remind **◆**** is activated:

- a message will be displayed the moment the tagged programme with **◆** starts, when watching the TV later on.
- the TV switches on the moment the tagged programme with **◆** starts, when the TV is in standby.

*Note: Recordings and reminders are not possible when the broadcaster does not transmit dates and times of the programmes.*

*The message **No TV programming possible** appears.*

*Make sure you are on the TV programming page.*

### Info

- 1 Press the yellow colour key to activate **Info**. Advertisements or information relating to the selected programme are displayed. In some cases all of the information does not fit on the screen. Use the cursor up/down to browse through all the information.
- 2 Press the yellow colour key again to switch off the information.



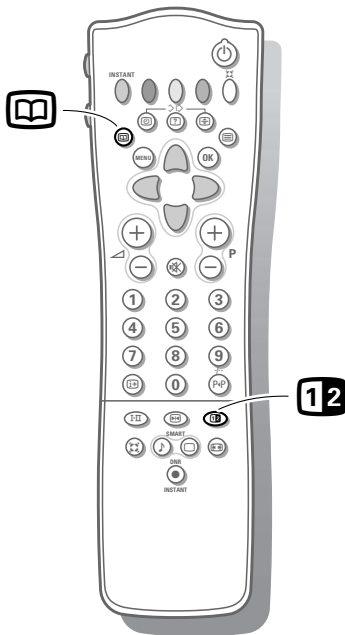

### Select Picture/NEXTVIEW-Teletext Guide

Press the  key.

Press the **12** key.

The screen is divided into two parts: the left side for the normal main picture, the right side for NEXTVIEW/Teletext Guide.

Press the **12** key to return to a full NEXTVIEW/Teletext guide screen, or press the  key to return to a full picture screen.

### Acquisition and updating of NEXTVIEW information

Acquisition and updating of NEXTVIEW is done when you are watching a TV channel supporting NEXTVIEW.

### Video recorder restrictions with NEXTVIEW

The **Record** item and the automatic recording will only be present and possible if your video recorder is equipped with NEXTVIEWLink.

Your video recorder should be connected to **EXTERNAL 2**. See *Connect Peripheral Equipment*, p. 21.

The daily, weekly and series options, the number of recordings set and the way overlapping recordings are managed, depend on the type of video recorder you have. When all video recorder timers are full, the item **Record** in the menu will not be present.

#### Upload video recorder overview

When the TV is switched on, the timer recordings are uploaded to the TV to check if any manual addition or deletions have been done. This is shown in the overview.

The video recorder manages and removes timer recordings when performed.

Some NEXTVIEWLink video recorders do not allow a daily programming of the recording to start on a Saturday or Sunday. In this case the item **daily** will be removed from the menu on those days.



## Teletext

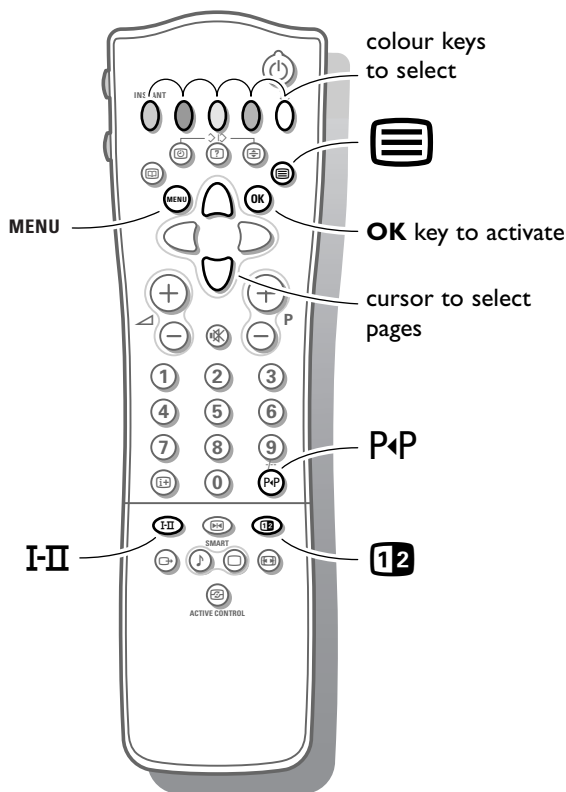

Most TV channels broadcast information via teletext.

Each channel which broadcasts teletext transmits a page with information on how to use its teletext system. Look for the teletext page with the main index (usually p. 100).

Depending on the TV channel, teletext is transmitted in different systems. The colours used in the options line correspond with the colour keys of your remote control.

### About Easy Text

Easy Text considerably reduces the waiting time (on condition that the teletext broadcast of the particular TV channel is received for at least half a minute) by :

- a direct selection of previous and following pages which are in transmission and of the pages referred to in the options line
- a habit watcher list: frequently used pages are put automatically in a list of preferred pages, so that they are immediately available
- the precapturing of the page numbers referred to in the displayed page
- the precapturing of all the subpages.

### Switch Teletext on and off

Press  to switch the teletext on or off.

The main index page appears on the screen together with two information lines at the top and one option line at the bottom of the screen.

*Remark: if the displayed teletext characters on screen do not correspond with the characters used in your language, press the I-II key repeatedly to select Language group 1 or 2.*

### Select a Teletext page

#### With the digit keys

Enter the desired page number with the digit keys.

The page counter seeks the page or the page appears immediately when the page number has been stored in the memory.

*A message appears when you have entered a non existent or incorrect page number. Page numbers beginning with 0 or 9 do not exist. Choose another number.*

#### With the option line

Select with the colour keys, corresponding to the coloured options at the bottom of the screen, the desired subject.



### Select Picture/Teletext

Select a TV channel which broadcasts teletext.

Press the  key.

The screen is divided into two parts:

the left side for the normal main picture, the right side for teletext broadcast by the selected TV channel.

Press the  key to return to a full screen picture or press the  key to return to a full teletext picture.

### Quickly run through the teletext pages

Press the cursor up/down or the - P + key to run through the previous or the following pages.

### Select the previously selected txt page

Press the P<P key.

## Select the index teletext page

Press the white colour key to display the main index (usually p.100).

### Only for T.O.P teletext broadcasts :

T.O.P orders the pages in categories and adds other possibilities of enhancing ease of use.

Press **i+**. A T.O.P overview of the teletext subjects available is displayed. Not all TV channels broadcast T.O.P teletext. When the teletext system is not T.O.P teletext, a message appears at the top of the screen.

Select with the cursor up/down, left/right the desired subject and press the **OK** key.

## Select subpages

When a selected teletext page consists of different subpages, one of the subpages appears on the screen.

The coloured number in the first information line refers to the displayed subpage.

The other subpages can be selected in 2 ways :

### With the cursor left/right

The other subpage numbers appear in white as soon as the transmission has found them. They are stored in the memory so that they are available while the teletext page is on screen.

Select with the cursor left/right the previous or the following subpage.

### With the **0** key

• Enter the subpage number yourself:

Press **0**. Enter the desired subpage with the digit keys : e.g. 3 for the third page of seven subpages.

The TV searches for the selected subpage.

• Automatically rotating subpages:

Press **0** again to cancel the entered digit key for the subpage.

Now the subpages rotate automatically.

Press **0** again to select the subpages with the cursor left/right again.

## Special teletext functions

### Hold

Press **Hold** to stop the automatically rotating of the subpages or to stop the page counter from seeking when you have entered a wrong page number or when the page is not available.

Enter another page number.

### Enlarge

Press **Enlarge** repeatedly to display the upper part, the lower part and then to return to the normal page size. When the upper part is displayed, you can scroll the text, line by line using the cursor up/down.

### Reveal

Press **Reveal** to reveal/conceal the hidden information, such as solutions to riddles and puzzles.

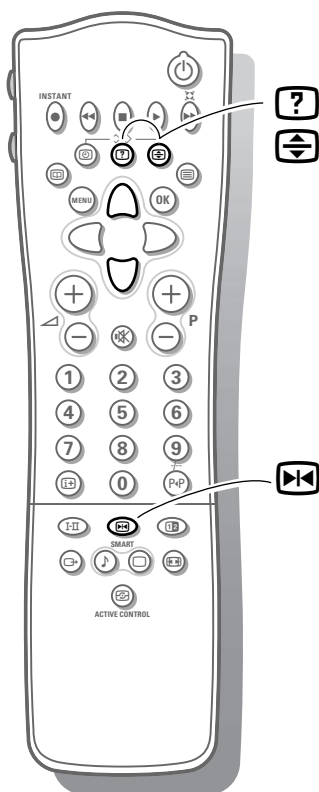
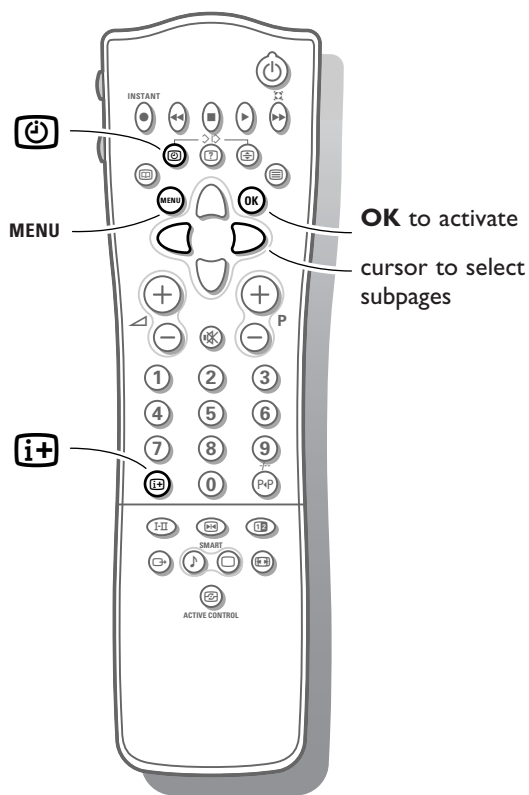

---

## Select Continuous Subtitles

TV channels with teletext often transmit programmes with subtitling. For each TV channel you can store a subtitle page which will be displayed continuously if the programme being broadcast is transmitted with subtitles.

Switch on teletext and select the proper subtitle page from the index.  
Switch off teletext.  
Now the subtitle page is stored for the selected TV channel.

Once subtitles have been stored and **Subtitle On** has been selected they will automatically be displayed on the selected TV channel if subtitles are in the transmission.

Select **Subtitle On** or **Off** in the Features menu, see p. 12.  
The subtitle symbol  appears when **Subtitle On** is selected.

*Remark: you are in teletext mode, so only teletext functions are available.*

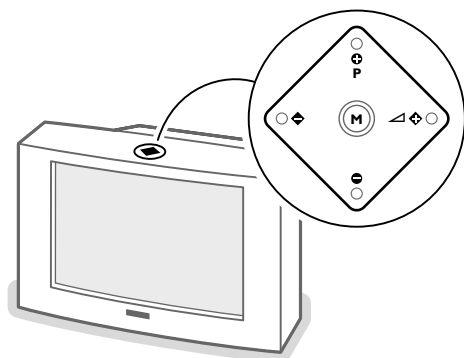

---

### Keys on top of the TV

Should your remote control be lost or broken you can still change some of the basic picture settings with the keys on top of the TV.

Press the **M** key repeatedly to select **Volume, Brightness, Colour, Contrast**.  
Press the **P** - or + keys to carry out the selected adjustment.  
When the menu adjustment is not displayed, the **P**- or + keys enable you to select the TV channels, the  - or + keys to adjust the volume.

*The selected adjustment automatically switches off when no action has been executed for 10 seconds.*

# Connect Peripheral Equipment

There is a wide range of audio and video equipment that can be connected to your TV. The following connection diagrams show you how to connect them.

## Video recorder

Connect the aerial cables ①, ② and, to obtain the optimum picture quality, eurocable ③ as shown opposite.

*easy LINK*

If your video recorder is provided with the EasyLink function, the eurocable supplied with it should be connected to **EXTERNAL 2** to benefit from the EasyLink functionality.

If the eurocable ③ is not used the following steps are required:

### Search for and store the test signal of the video recorder

- ① Unplug the aerial cable ① from the aerial socket of your video recorder.
- ② Switch on your TV and put the video recorder on the test signal. (See the handbook for your video recorder.)
- ③ Search for the test signal of your video recorder in the same way as you searched for and stored the TV signals. See Installation, Searching for and storing TV channels, Manual installation, p. 5.
- ④ Store the test signal under programme number 0 or between 90 and 99.
- ⑤ Replace the aerial cable in the aerial socket of your video recorder after you have stored the test signal.

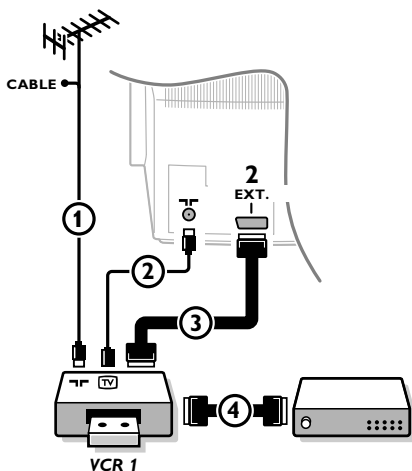

### Decoder and video recorder

Connect a eurocable ④ to your decoder and to the special euroconnector of your video recorder. See also the video recorder handbook.

See Define Decoder/Descrambler prog. numbers, p. 7.

You can also connect your decoder directly to **EXTERNAL 1** or **2** with a eurocable.

### Video recorder and other peripherals (except Digital Sources)

- ① Connect the aerial cables ①, ② and ③ as shown opposite. Better picture quality can be obtained if you also connect eurocable ⑤ to **EXTERNAL 2** and a eurocable ④ to **EXTERNAL 1**.
- ② Look for the test signal of your peripheral in the same way as you do for a video recorder.

When a video recorder is connected to **EXTERNAL 1** you can only record a programme from your TV.

Only when a video recorder is connected to **EXTERNAL 2** it is possible to record a programme from your TV as well as from other connected equipment. See Record with your video recorder, p. 26.

Note: **EXTERNAL 1** can handle CVBS and RGB, **EXTERNAL 2** CVBS and YIC and RGB.

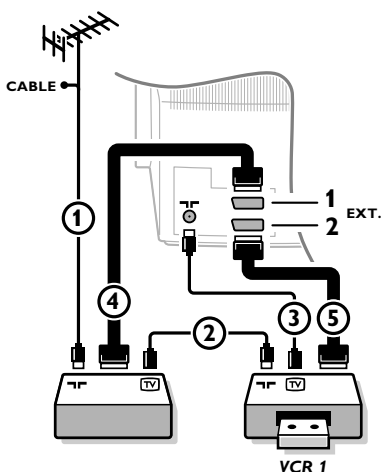

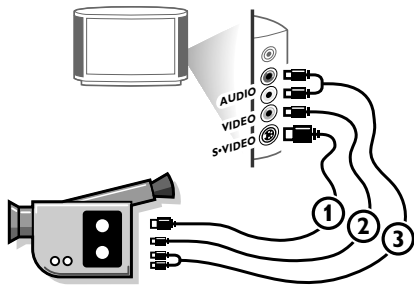

## Camera & camcorder

- 1 Connect your camera or camcorder to sockets at the right side of your TV.
- 2 Connect the equipment to **VIDEO** ② and **AUDIO L** ③ for mono equipment.  
Press the **I-II** key repeatedly to select the sound coming from one or both loudspeakers of your TV.
- 3 For stereo equipment also connect **AUDIO R** ③.

S-VHS quality with an S-VHS camcorder is obtained by connecting the S-VHS cables with the **S-VIDEO** input ① and **AUDIO** inputs ③.

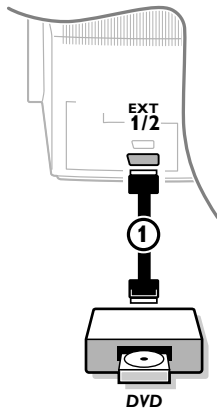

## Digital equipment (DVD, digital satellite tuner,...)

Connect your digital equipment with a eurocable ① to one of the euroconnectors (**EXT1** or **EXT2**), or with a cinch cable to the **VIDEO** input at the right side of the TV (see illustration above).

- 1 Press **Ⓞ** and **↕** at the same time.

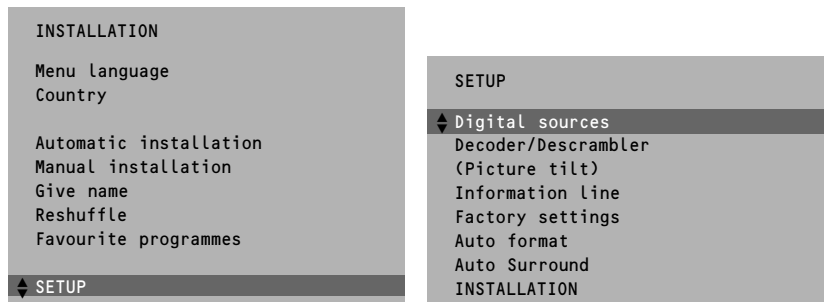

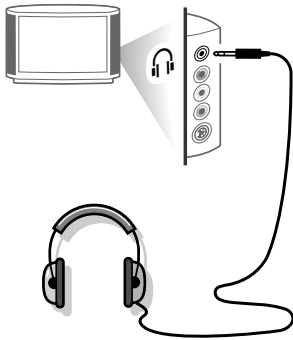

- 2 Select **Digital sources** in the Setup menu of the **INSTALLATION** menu and select:
  - **None** if you have no digital source connected,
  - **EXT1** or **EXT2** if you have connected your equipment to a euroconnector,
  - **FRONT** in case you have connected your equipment to the right side of the TV.
- 3 Press the **MENU** key to switch off all menus.

*Note: the low quality of some digital picture material may be the cause of digital image distortion. In this case select **Eco** under the **SMART PICTURE**  key on the remote control as this setting is intended to improve distorted picture quality.*



## Headphone

- 1 Insert the plug into the headphone socket  at the right side of the TV.
- 2 Press  on the remote control to switch off the internal loudspeakers of the TV.  
*The headphone impedance must be between 8 and 4000 Ohm.  
The headphone socket has a 3.5 mm jack.*

In the **SOUND** menu select **Headphone volume** to adjust the headphone volume, see p. 11.

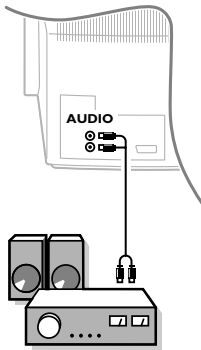

## Audio equipment / Amplifier

Connect the audio cables to the audio input of your audio equipment and to **AUDIO L** and **R** at the back of your TV.

You can listen to your TV sound via your audio equipment.

If you want to connect more equipment to your TV, consult your dealer.

## To select connected equipment

*easy* LINK

If the TV is connected to a video recorder with the EasyLink function, in some cases the TV will be switched on, even when it was in standby. (E.g. playback tape,...)  
This is not possible when Child lock On is selected.

### Equipment connected with an aerial cable only :

Select the programme number under which you have stored the test signal with the digit keys.

### Equipment connected to a euroconnector or to the right side of the TV

Press the  key repeatedly to select **EXT1**, **EXT2** or **FRONT**, according to where you connected your equipment at the back or the right side of your TV.

Remark : Most equipment (decoder, video recorder, satellite receiver) carries out the switching itself.

### If you want to change to TV channels?

Enter the programme number of the TV channel which you want to watch with the digit keys or press the  key repeatedly to select **TV**.

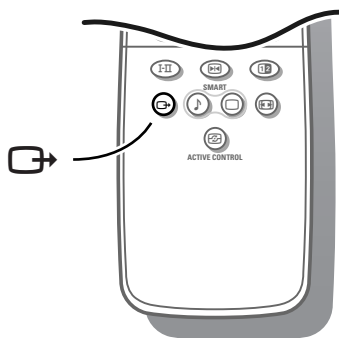









## Audio and video equipment keys

Most of the audio and video equipment from our range of products can be operated with the remote control of your TV.

### Video recorder

Keep the **VCR** key on the left side of the remote control pressed and simultaneously press:

-  for record,
-  for rewind,
-  for stop,
-  for play,
-  for fast forward,
-  for selecting 1- or 2-digit programme numbers from the video recorder,
-  for sequential programme selection from the video recorder tuner,
- 0 to 9** to select a programme number from your video recorder tuner,
-  to switch the video recorder to standby

These keys function with equipment which use the RC5 signalling standard.

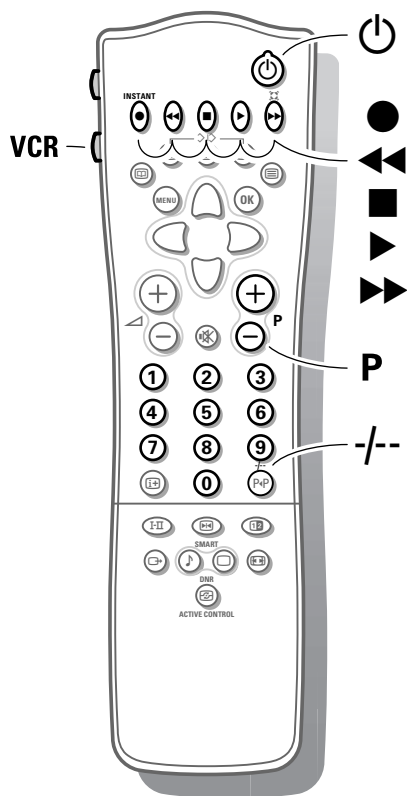

*easy* LINK

If your video recorder has the EasyLink function, the key **INSTANT**  for recording, can be operated in the TV mode.

If your EasyLink video recorder has the system standby function, when you press the  key for 3 seconds, both TV and the video recorder are switched to standby.



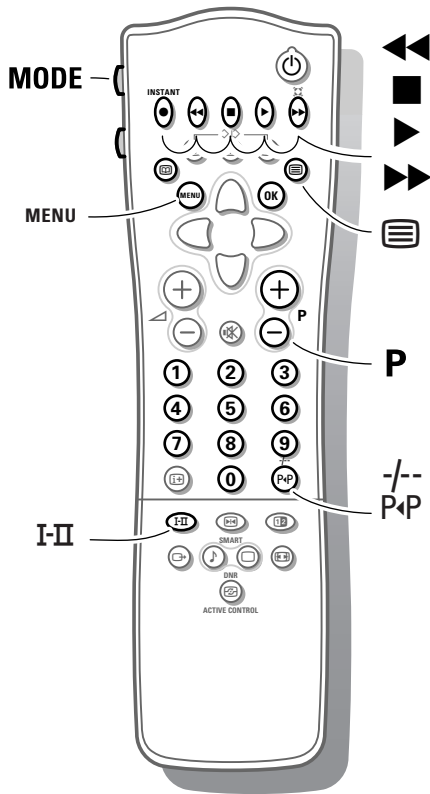

### Satellite receiver

Press the **OK** key simultaneously with the digit key 1.

Now you can operate your satellite receiver with the remote control of your TV.

Keep the **MODE** key on the left side of the remote control pressed and simultaneously press:

- MENU** to switch the **SAT** menu on or off
- /--** to select a one or two digit programme number from the satellite receiver.





*These keys function with equipment which use the RC5 signalling standard.*

### DVD player

Press the **OK** simultaneously with the digit key 2.

Now you can operate your DVD player with the remote control of your TV.

Keep the **MODE** key on the left side of the remote control pressed and simultaneously press:

- MENU** to switch the DVD menu on or off
-  to select a DVD title
- P<P** to select a DVD chapter
- I-II** to select your choice of audio language
-  to search down
-  stop
-  play
-  to search forward
- 0-9** to select a programme number from your DVD
- OK** to enter the selected menu item

, , , ,  have no function

*Note: after replacing the batteries the default operational equipment is the satellite receiver.*

*These keys function with equipment which use the RC6 signalling standard.*

## Record with your video recorder

To record S-VHS quality, connect an S-VHS peripheral directly to the video recorder.

### Record a TV programme

- 1 Select the programme number on your video recorder.
- 2 Set your video recorder to record.  
See the handbook for your video recorder.

*Switching programme numbers on your TV does not disturb recording !*

### Record a programme on your video recorder connected to EXTERNAL 2 from Audio/Video equipment connected to EXTERNAL 1 or to sockets on the right side of the TV

- 1 Switch on the equipment.
- 2 Select the right external on your video recorder.
- 3 Set your video recorder to record.  
You record what you are watching on the screen.

*Do not switch programme numbers or do not switch off your TV when you are recording !*

## Record with your video recorder with EasyLink



If you have connected an S-VHS video recorder provided with the EasyLink function, you can record S-VHS-quality from an S-VHS peripheral connected to the right side of the TV. (E.g. from an S-VHS camcorder.)

In TV mode, it is possible to start a direct recording of the programme which is being displayed on the TV screen.

Press the **INSTANT** ● record key of the remote control.

The video recorder switches on from standby and a message of what is being recorded appears on the screen.

The video recorder starts recording the programme you are watching.  
Switching programme numbers on your TV does not disturb recording !

When recording a programme from a peripheral connected to EXTERNAL 1 or FRONT, you can not select another TV programme on the screen.

To watch TV programmes again, press the programme number you want to select twice.

Attention: the recording is stopped and your video recorder switches to standby.

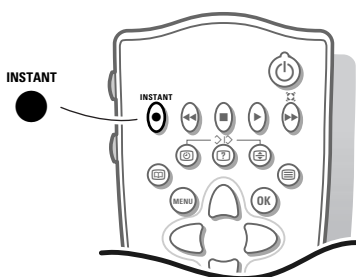

## Record with your video recorder with NEXTVIEWLink



If your video recorder is equipped with NEXTVIEWLink, and you tagged one or more programmes to be recorded automatically in the NEXTVIEW mode, it is not necessary for the TV to be in the standby mode or switched on for the recording to start.

## Tips

### Care of the screen

Clean the TV with a slightly damp soft cloth. Do not use abrasive solvent as it can damage the TV screen.

### Poor Picture

Have you selected the correct TV system? Is your TV or house aerial located too close to loudspeakers, non-earthed audio equipment or neon lights, etc.?

Mountains or high buildings can cause double pictures or ghost images. Sometimes you can improve the picture quality by changing the direction of the aerial.

Is the picture or teletext unrecognisable?

Check if you have entered the correct frequency. See Installation, p. 5.

Are brightness and contrast out of adjustment? Select Factory settings in the Setup menu, p. 7.

Sometimes poor picture quality is possible when having activated an S-VHS camera or camcorder connected to the right side of your TV and another peripheral is connected to **EXT1** or **EXT2** at the same time. In this case switch off one of the other peripherals.

### No picture

Is the aerial connected properly? Are the plugs tightly connected in the aerial socket?

Is the aerial cable in good condition and does it have suitable plugs?

Are the connection facilities to a possible second TV in good condition? If in doubt, consult your dealer.

### No sound

No sound on any channel? Check the volume isn't at minimum. Is the sound interrupted with the mute key ?

### Remote control

If your TV no longer responds to the remote control, the batteries may be dead.

You can still use the **M** key and the **-/+** keys at the top of your TV.

### Menu

Have you selected the wrong menu? Press the **MENU** key again to exit from the menu.

### No solution

Switch your TV off and then on again once.

**Never attempt to repair a defective TV yourself.**

Check with your dealer or call a TV technician.

### End of life directives

Philips is paying a lot of attention to produce environmentally-friendly in green focal areas. Your new TV contains materials which can be recycled and reused.

At the end of its life specialised companies can dismantle the discarded TV to concentrate the reusable materials and to minimise the amount of materials to be disposed of.

Please ensure you dispose of your old TV according to local regulations.

### How to dispose of batteries?

The batteries supplied do not contain the heavy metals mercury and cadmium.

Nevertheless in many countries batteries may not be disposed of with your household waste. Please ensure you dispose of batteries according to local regulations.

## Index

- a** ACI, 5
  - active control, 10
  - automatic installation, 5
  - auto format, 7
  - auto surround, 8
  - AVL, 11
- b** bilingual broadcast, 10
- c** camcorder, 22
  - child lock, 12
  - continuous subtitles, 20
  - country, 4
- d** decoder/descrambler, 7
  - digital scan, 11
  - digital sources, 22
  - dual screen, 13
  - DVD, 25
  - dynamic contrast, 11
- e** easy text, 18
  - eurocable, 21
- f** factory settings, 7
  - favourite programmes, 6
  - freeze, 10
  - frequency, 5
- g** give name, 6
  - graphic equalizer, 11
- h** headphone, 23
  - hue, 11
- i** incredible surround, 9
  - info on screen, 9
  - information line, 7
  - interrupt the sound, 9
- l** language, 4
- m** manual installation, 5
  - menu language, 4
- n** NEXTVIEW, 14
  - nicam, 10
- p** picture adjustments, 11
  - picture format, 10
  - picture tilt, 7
  - programme selection, 9
  - programme list, 12
- r** recording, 26
  - reshuffle, 6
- s** satellite receiver, 25
  - search for TV channels, 5
  - setup, 7
  - sleeptimer, 12
  - smart picture and sound, 10
  - sound adjustments, 11
  - stereo, 10
  - store TV channels, 4
  - subpages teletext, 19
  - S-VHS, 26
  - switch TV on, 3
- t** teletext, 18
- v** video recorder, 21
  - Virtual Dolby Surround, 9
  - volume, 9

## Glossary

### 100 Hz

100 Hertz provides a superior solution to the problem of picture flicker which is particularly noticeable with larger screen sizes. In a conventional TV, the picture area is scanned 50 times a second (50 Hertz) – a frequency which is still detectable by the human eye in the form of a flickering picture. In 100 Hertz sets, the picture area is scanned at a rate of 100 times per second (100 Hertz). At this frequency, the eye cannot detect flicker, resulting in a clearer picture which is more relaxing to the eye.

### Automatic Channel Installation (ACI)

Automatically installs all TV channels in the same order as offered by your cable company, provided of course that the data is transmitted. It also automatically includes programme number and programme name.

With ACI, channel installation is fully automatic, simple and fast.

### Child lock

Feature to prevent unauthorised use of your TV.

### Digital Scan

If you look at a television screen you will see small imperfections in the picture caused by line vibration. Digital Scan (an internal process) removes interline flicker. When combined with 100 Hz, you will see a totally stable image.

### Easy Link

Digital 'intelligent' ESI bus-system between TV and VCR (Scart connection required). Turns source selection and control into a one-button operation.

### Easy Text

Teletext memory that automatically memorises Teletext pages and gives you instant access to them.

### Euroconnector

A 21-pin connector system enabling you to simply connect various types of audio/video and computer equipment.

### Menu

On-screen display of functions and facilities in a well-organised survey, which you can select using your remote control.

### NEXTVIEW

NEXTVIEW is a new feature to assist the TV and VCR user in selecting the programmes she or he likes to watch from a television programme guide on the screen. It enables the user to see a description of every programme, and mark interesting programmes to be reminded (auto TV on) or recorded (NEXTVIEWLink video recorder required).

### NTSC

The broadcasting system used in the USA, Japan and parts of South America and Southeast-Asia.

### Smart Picture and Sound controls

Keys on the remote control to select predefined picture and sound settings.

### Sleeptimer

Function with which you can set a time period after which the TV should switch itself to standby.

### Picture Freeze

TV mode which allows you to "freeze" a certain image in order to study a specific detail at ease, e.g. to make notes of certain programme information like phone numbers.

### Teletext

See also Easy Text

*WST*: World Standard Teletext.

*FLOF*: Full Level one Features. System applied by the BBC, RVE.... that provides a fast access to the teletext pages.

*TOP*: Table of (Teletext) Pages. German system for an easy access to the teletext pages.

### Tint

TV-function to modify the general colour balance between cool and warm and to adjust it according to your personal preference.