

Operating Instructions LCD Television



VIERA

Contents

Be Sure to Read

Important Notice	2
Safety Precautions	2

Quick Start Guide

Accessories	4
Connections	5
Identifying Controls	8
First time Auto Setup	10

Using your VIERA

Watching TV	11
Watching External Inputs	12
Viewing Text Service	12

Using TV Guide	14
Using Menu Functions	14
Tuning and Editing Channels	19
Child Lock	20
Updating the TV Software	20
Using Media Player	21
VIERA Link	23

Others

Technical Information	26
Maintenance	28
FAQs	29
Specifications	30





Even if no special notation has been made of company or product trademarks, these trademarks have been fully respected.

- DVB and the DVB logos are trademarks of the DVB Project.
- HDMI, the HDMI Logo, and High-Definition Multimedia Interface are trademarks or registered trademarks of HDMI Licensing LLC in the United States and other countries.
- HDAVI Control™ is a trademark of Panasonic Corporation.
- Manufactured under license from Dolby Laboratories. Dolby and the double-D symbol are trademarks of Dolby Laboratories.
- Manufactured under license under U.S. Patent Nos: 5,956,674; 5,974,380; 6,487,535 & other U.S. and worldwide patents issued & pending. DTS, the Symbol, & DTS and the Symbol together are registered trademarks & DTS 2.0+Digital Out is a trademark of DTS, Inc. Product includes software. © DTS, Inc. All Rights Reserved.

Important Notice

Notice for DVB / Data broadcasting

This TV is designed to meet the standards (as of August, 2012) of digital services.

- Not all the features are available depending on the country, area, broadcaster, service provider and network environment.
- The compatibility with future services is not guaranteed.
- Check the latest information on the available services at the following website.

<http://panasonic.net/viera/support>

This product is licensed under the AVC patent portfolio license for the personal and non-commercial use of a consumer to (i) encode video in compliance with the AVC Standard ("AVC Video") and/or (ii) decode AVC Video that was encoded by a consumer engaged in a personal and non-commercial activity and/or was obtained from a video provider licensed to provide AVC Video. No license is granted or shall be implied for any other use.

Additional information may be obtained from MPEG LA, LLC.

See <http://www.mpegla.com>.

Panasonic does not guarantee operation and performance of peripheral devices made by other manufacturers; and we disclaim any liability or damage arising from operation and/or performance from usage of such other maker's peripheral devices.

Transport only in upright position

Safety Precautions

To help avoid risk of electrical shock, fire, damage or injury, please follow the warnings and cautions below:

■ Mains plug and lead

Warning

If you detect anything unusual, immediately switch off the mains supply switch and remove the mains plug.

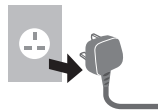

- This TV is designed to operate on AC 220-240 V, 50 / 60 Hz.
- Insert the mains plug fully into the socket outlet.
- Ensure that the mains plug is easily accessible.
- Disconnect the mains plug when cleaning the TV.
- Do not touch the mains plug with wet hands.



- Do not damage the mains lead.

- Do not place a heavy object on the lead.



- Do not place the lead near a high temperature object.



- Do not pull on the lead. Hold onto the mains plug body when disconnecting the plug.



- Do not move the TV with the lead plugged into a socket outlet.
- Do not twist the lead, bend it excessively or stretch it.
- Do not use a damaged mains plug or socket outlet.
- Ensure the TV does not crush the mains lead.
- Do not use any mains lead other than that provided with this TV.

**IMPORTANT:
THE MOULDED MAINS PLUG**

**FOR YOUR SAFETY, PLEASE READ THE
FOLLOWING TEXT CAREFULLY.**

This TV is supplied with a moulded 3-pin mains plug for your safety and convenience.

A 5 amp fuse is fitted in this mains plug. Shall the fuse need to be replaced, please ensure that the replacement fuse has a 5 amp rating and that it is approved by ASTA or BSI to BS1362.

Check for the ASTA mark  or the BSI mark  on the fuse body.

If the mains plug contains a removable fuse cover, you must ensure that it is refitted when the fuse is replaced.

If you lose the fuse cover, the mains plug must not be used until a replacement cover is obtained.

A replacement fuse cover may be purchased from your local dealer.

Do not cut off the mains plug.

Do not use any other type of mains lead except the one supplied with this TV.

The supplied mains lead and moulded plug are designed to be used with this TV to avoid interference and for your safety.

If the socket outlet in your home is not suitable, get it changed by a qualified electrician.

If the plug or mains lead becomes damaged, purchase a replacement from an authorised dealer.

How to replace the fuse:

For plug type shown in example 1

Lift out the removable fuse cover with a screwdriver and replace the fuse, then refit it securely into the mains plug.

Example 1





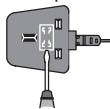

For plug type shown in example 2

Lift open the fuse cover in the mains plug with a screwdriver and replace the fuse, then press the fuse cover down securely.

Example 2



- Do not place the TV on sloped or unstable surfaces, and ensure that the TV does not hang over the edge of the base.  

- This TV is designed for table-top use.
- Do not expose the TV to direct sunlight and other sources of heat.  

To prevent the spread of fire, keep candles or other open flames away from this product at all times



■ Dangerous part / Small object

Warning

- This product contains possibly dangerous parts such as plastic bags, that can be breathed in or swallowed by young children accidentally. Keep these parts out of reach of young children.

■ Pedestal

Warning

- Do not disassemble or modify the pedestal.

Caution

- Do not use any pedestal other than the one provided with this TV.
- Do not use the pedestal if it becomes warped or physically damaged. If this occurs, contact your nearest Panasonic dealer immediately.
- During setup, make sure that all screws are securely tightened.
- Ensure that the TV does not suffer any impact during installation of the pedestal.
- Ensure that children do not climb onto the pedestal.
- Install or remove the TV from the pedestal with at least two people.
- Install or remove the TV by the specified procedure.

■ Ventilation

Caution

Allow sufficient space around the TV in order to help prevent excessive heat, which could lead to early failure of some electronic components.

Minimum distance:

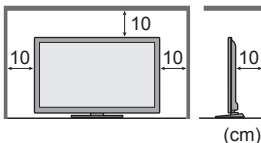

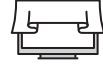

- Ventilation should not be impeded by covering the ventilation openings with items such as newspapers, tablecloths and curtains.  

- Whether you are using a pedestal or not, always ensure the vents at the bottom of the TV are not blocked and there is sufficient space to enable adequate ventilation.

■ Take care

Warning

- Do not remove covers and never modify the TV yourself as live parts are accessible when they are removed. There are no user serviceable parts inside. 
- Do not expose the TV to rain or excessive moisture. This TV must not be exposed to dripping or splashing water and objects filled with liquid, such as vases, must not be placed on top of or above the TV.  
- Do not insert foreign objects into the TV through the air vents.
- Do not use an unapproved pedestal / mounting equipment. Be sure to ask your local Panasonic dealer to perform the setup or installation of approved wall-hanging brackets.
- Do not apply strong force or impact to the display panel.

■ Moving the TV

Caution

Before moving the TV, disconnect all cables.

- Move the TV with at least two people. Support as shown to avoid injury by the TV tipping or falling.



■ Excessive volume

Caution

- Do not expose your ears to excessive volume from the headphones. Irreversible damage can be caused.
- If you hear a drumming noise in your ears, turn down the volume or temporarily stop using the headphones.



■ When not in use for a long time

Caution

This TV will still consume some power even in the Off mode, as long as the mains plug is still connected to a live socket outlet.

- Remove the mains plug from the wall socket when the TV is not in use for a prolonged period of time.

■ Battery for the Remote Control

Caution

- Incorrect installation may cause battery leakage, corrosion and explosion.
- Replace only with the same or equivalent type.
- Do not mix old and new batteries.
- Do not mix different battery types (such as alkaline and manganese batteries).
- Do not use rechargeable batteries (Ni-Cd, etc.).
- Do not burn or break up batteries.
- Do not expose batteries to excessive heat such as sunshine, fire or the like.
- Make sure you dispose of batteries correctly.

Accessories

Remote Control

→ (p. 9)

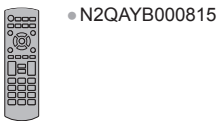

Batteries (2)

• R6
→ (p. 9)



Pedestal

→ (p. 4, 5)

32-inch model

39-inch model

50-inch model

42-inch model

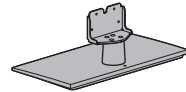
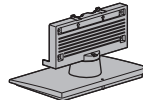

Mains lead

→ (p. 6)

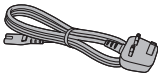

Cable tie

→ (p. 8)



Operating Instructions

Production Registration Leaflet

- Accessories may not be placed all together. Take care not to throw them away unintentionally.

Assembling / Removing the pedestal

32-inch model

(A) Assembly screw (4)



(B) Assembly screw (4)



M4 × 25

(C) Bracket

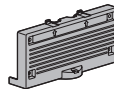

(D) Base

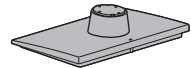

■ Assembling the pedestal

1

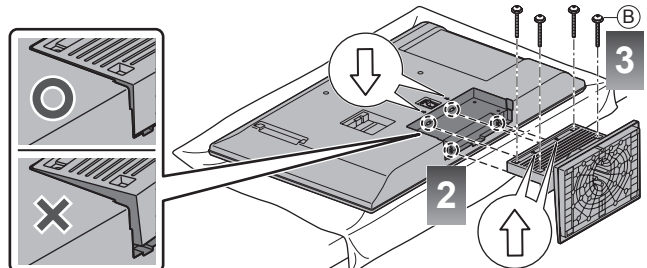
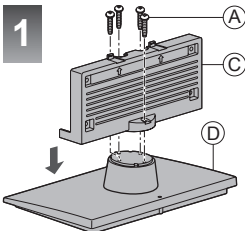

39-inch model 42-inch model 50-inch model

(A) Assembly screw
(4)



M5 × 15

(B) Assembly screw
(4)



M4 × 12

(C) Bracket



(D) Base

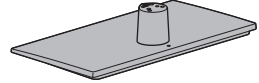

■ Assembling the pedestal

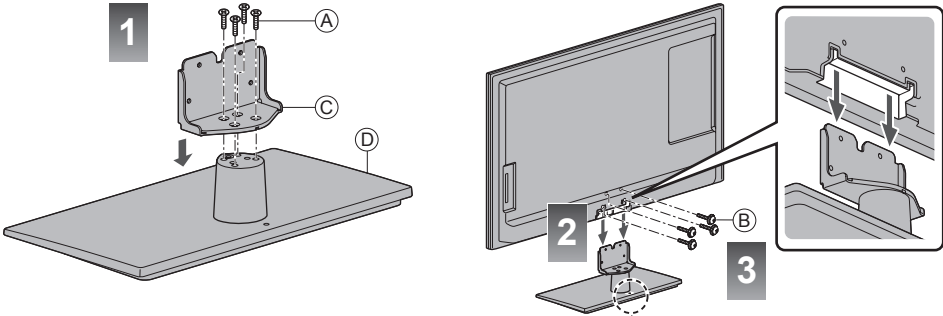

Secure the base as shown to prevent the TV from falling over.

- The place where the base is secured should be thick enough and made of hard material.

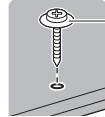

Commercially available screw
(not supplied)

Diameter: 3 mm
Length: 25 - 30 mm

Removing the pedestal from the TV

Be sure to remove the pedestal in the following way when using the wall-hanging bracket or repacking the TV.

- 1 Remove the assembly screws (B).
- 2 Pull out the pedestal from the TV.
- 3 Remove the assembly screws (A) from the bracket.

Connections

- External equipment and cables shown are not supplied with this TV.
- Ensure that the unit is disconnected from the mains socket before attaching or disconnecting any leads.
- Check the type of terminals and cable plugs are correct when connecting.
- Always use a fully wired SCART or HDMI cable.
- Keep the TV away from electronic equipment (video equipment, etc.) or equipment with an infrared sensor. Otherwise, distortion of image / sound may occur or operation of other equipment may be interfered.
- Also read the manual of the equipment being connected.

Terminals

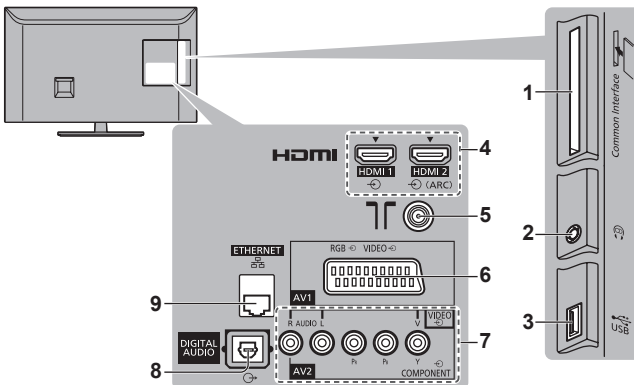

- 1 CI slot → (p. 7)
- 2 Headphone jack → (p. 7)
- 3 USB port
- 4 HDMI1 - 2 → (p. 6, 7)
- 5 Terrestrial terminal → (p. 6)
- 6 AV1 (SCART) → (p. 6)
- 7 AV2 (COMPONENT / VIDEO) → (p. 7)
- 8 DIGITAL AUDIO
- 9 ETHERNET

Basic connections

Mains lead and aerial

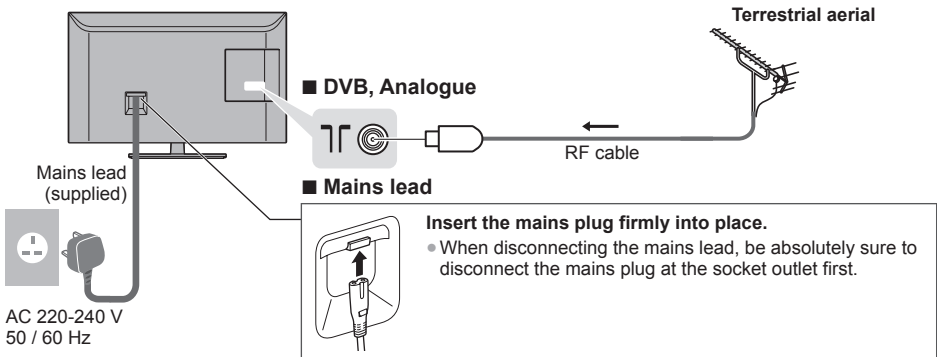

AV devices

■ DVD Recorder / VCR

TV

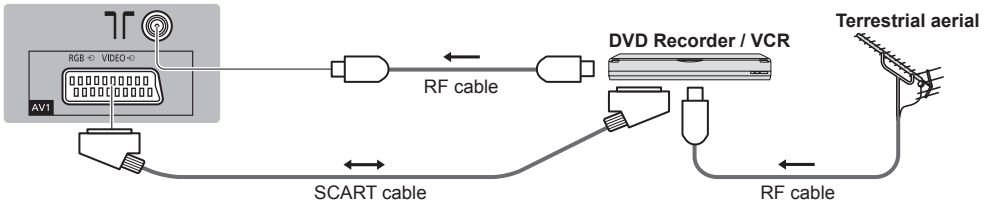

■ DVD Recorder / VCR and Satellite receiver

TV

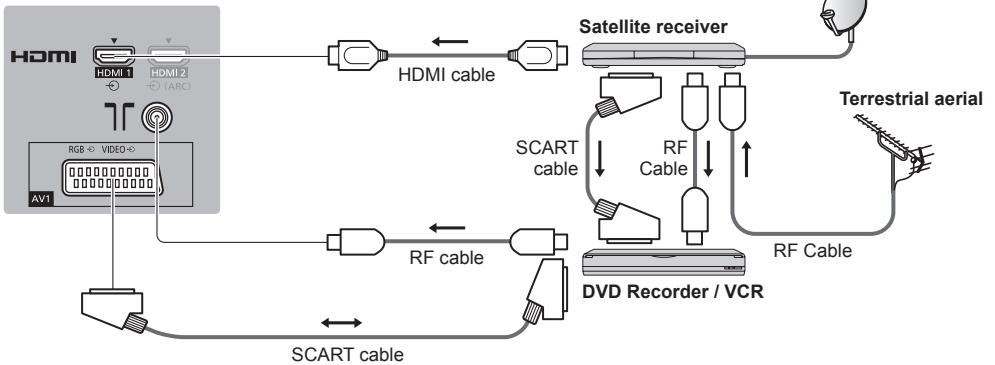

Other connections

■ DVD player

(COMPONENT equipment)

TV

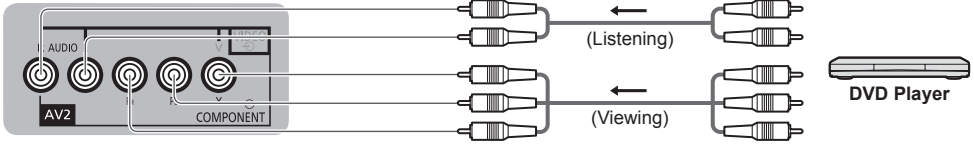

■ Camcorder / Game equipment

(VIDEO equipment)

TV

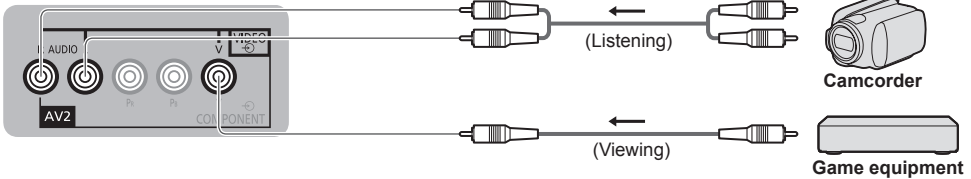

■ Amplifier (to listen with speakers)

TV

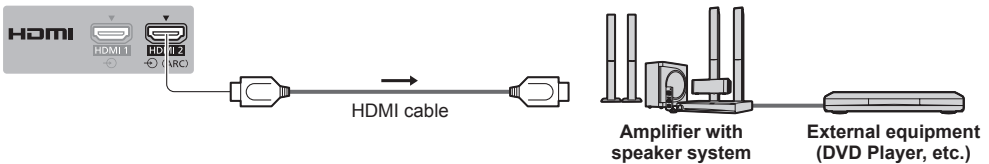

- Use HDMI2 for connecting an amplifier. This connection is applicable when using an amplifier that has ARC (Audio Return Channel) function.
As for an amplifier without ARC function, use DIGITAL AUDIO.
- To enjoy the sound from the external equipment in multi-channel sound (e.g. Dolby Digital 5.1ch), connect the equipment to the amplifier. For the connections, read the manuals of the equipment and amplifier.

■ Headphones

TV





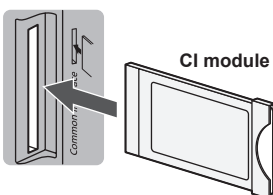

■ Common Interface

TV



- If a view card and a card reader come as a set, first insert the card reader, then insert the view card into the card reader.
- Insert the module in the correct direction.
- Features that appear on the screen are dependent on the contents of the selected CI module.
- Normally encrypted channels will appear. Follow the on-screen instructions.
If encrypted channel does not appear → **[Common Interface] (p. 18)**
- For more information, read the manual of the CI module, or check with the broadcaster.

Types of connectable equipment to each terminal

Features	Terminal					
	AV1 	AV2			DIGITAL AUDIO 	HDMI 1 - 2 
		COMPONENT 	VIDEO 			
To record / play back videocassettes / DVDs (VCR / DVD Recorder)	○					
To watch satellite broadcasts (Set top box)	○			○	○	
To watch DVDs (DVD Player)	○	○		○	○	
To watch camcorder images (Video camera)	○			○	○	
To play games (Game equipment)	○			○	○	
To use amplifier with speaker system				○	○*	
VIERA Link					○	

○ : Recommended Connection

* Use HDMI2 for connecting an amplifier. This connection is applicable when using an amplifier that has ARC (Audio Return Channel) function.

Using the cable tie (supplied) 32-inch model

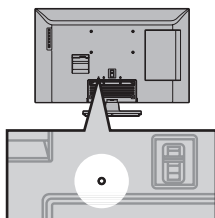

- Do not bundle the RF cable and mains lead together (could cause distorted image).
- Fix cables with the cable tie as necessary.
- When using the optional accessory, follow the option's assembly manual to fix cables.

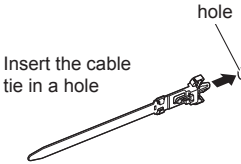
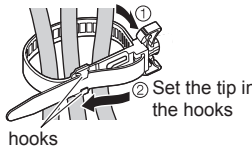
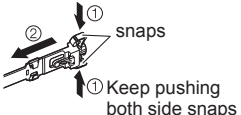
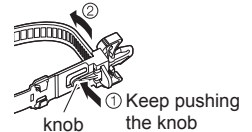
<p>Attach the cable tie</p>  <p>Insert the cable tie in a hole</p>	<p>Bundle the cables</p>  <p>① Set the tip in the hooks</p>
<p>To remove from the TV:</p>  <p>① Keep pushing both side snaps</p>	<p>To loosen:</p>  <p>① Keep pushing the knob</p>

Identifying Controls

Indicator / Control panel

- When pressing 1, 2, 3 buttons, the control panel guide appears on the right side of the screen for 3 seconds to highlight the pressed button.

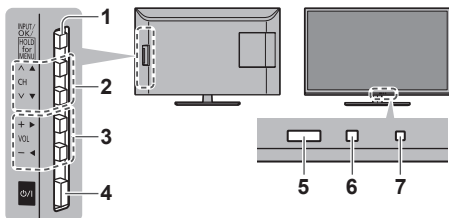

Rear side of the TV

1 Input mode selection

- Press repeatedly until you reach the desired mode.

[Main Menu]

- Press and hold for about 3 seconds to display main menu.

OK (when in the menu system)

2 Channel Up / Down

Cursor Up / Down (when in the menu system)

3 Volume Up / Down

Cursor Left / Right (when in the menu system)

4 Mains power On / Off switch

- Use to switch the mains power.

5 Remote control signal receiver

- Do not place any objects between the TV remote control signal receiver and remote control.

6 Ambient sensor

- Senses brightness to adjust picture quality when [Ambient Sensor] in the Picture Menu is set to [On].

7 Power LED

Red: Standby

Green: On

- The LED blinks when the TV receives a command from the remote control.

Remote Control

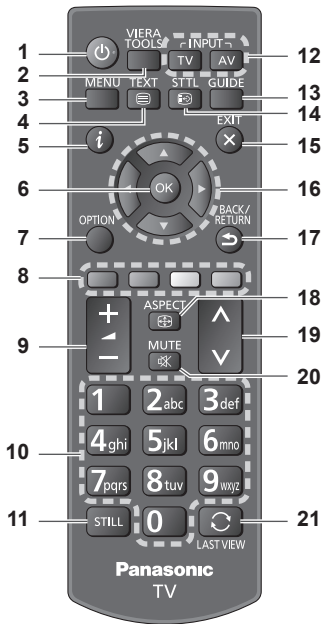

1 Standby On / Off switch

2 VIERA TOOLS

Displays some special feature icons and accesses easily.



- [VIERA Link] ➔ (p. 25)
- [Photo] in Media Player ➔ (p. 21)
- [Video] in Media Player ➔ (p. 21)
- [Music] in Media Player ➔ (p. 21)
- [Eco Navigation] ➔ (p. 17)

3 [Main Menu] ➔ (p. 14)

Press to access Picture, Sound, Network, Timer, Setup and Help Menus.

4 Text service button ➔ (p. 12)

5 Information ➔ (p. 11)

Displays channel and programme information.

6 OK

Confirms selections and choices.
Press after selecting channel positions to quickly change channel.

7 [Option Menu]

Easy optional setting for viewing, sound, etc.

8 Coloured buttons (red-green-yellow-blue)

Used for the selection, navigation and operation of various functions.

9 Volume Up / Down

10 Numeric buttons

Changes channel and teletext pages.

Sets characters.

When in Standby mode, switches TV on.

11 Still

Freezes / unfreezes the picture.

12 Input mode selection ➔ (p. 11, 12)

TV - switches to DVB / Analogue mode.

AV - switches to AV input mode from Input Selection list.

13 TV Guide ➔ (p. 14)

Displays Electronic Programme Guide.

14 Subtitles

Displays / hides subtitles. (if available)

15 Exit

Returns to the normal viewing screen.

16 Cursor buttons

Makes selections and adjustments.

17 Return

Returns to the previous menu / page.

18 Aspect ➔ (p. 11)

Displays Aspect Selection list to change aspect ratio.

- Selectable aspect modes may vary depending on the input signal.

19 Channel Up / Down

20 Sound Mute On / Off

21 Last view

Switches to previously viewed channel or input mode.

- Press again to return to the current view.

- Watching less than 10 seconds is not regarded as the previously viewed channel or input mode.

■ Installing / Removing batteries

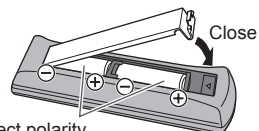
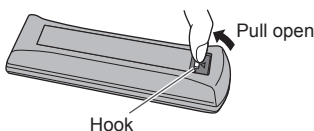

Note the correct polarity (+ or -)

Using the On Screen Displays - Operation guide

Many features available on this TV can be accessed via the On Screen Display menu.

■ Operation guide

Operation guide will help your operation by using the remote control.

Example: [Sound Menu]

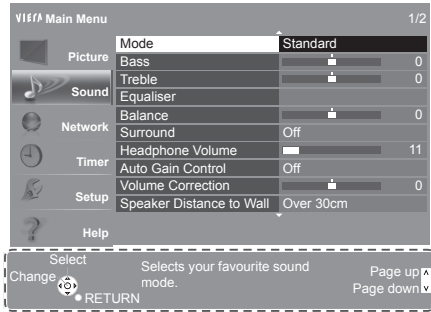

Operation guide

■ How to use remote control



Open the main menu



Move the cursor / select from a range of options / select the menu item (up and down only) / adjust levels (left and right only)



Access the menu / store settings after adjustments have been made or options have been set



Return to the previous menu



EXIT
Exit the menu system and return to the normal viewing screen



First time Auto Setup

Automatically sets up the TV and searches for available TV channels when the TV is turned on for the first time.

- These steps are not necessary if the setup has been completed by your local dealer.
- Please complete connections (p. 5 - 8) and settings (if necessary) of the connected equipment before starting Auto Setup. For details of settings for the connected equipment, read the manual of the equipment.

1

Plug the TV into mains socket and turn power on



- Takes a few seconds to be displayed.



2

Select the following items

Set up each item by following the on-screen instructions.

Select [Home]

Select [Home] viewing environment to use in your home environment.

- [Shop] is for shop display.

- To change viewing environment later on, you will need to initialise all settings by accessing Shipping Condition.

Select your country

Select your region **UK only**

Auto Setup is now complete and your TV is ready for viewing.

If tuning has failed, check the connection of the RF cable, and then follow the on-screen instructions.

- To retune all channels ➔ **[Auto Setup]** (p. 18)
- To initialise all settings ➔ **[Shipping Condition]** (p. 18)

Watching TV

1 Turn power on

 (TV)

or

 • Mains power On / Off switch should be on. (p. 8)
(Remote Control)

2 Select the mode



3 Select a channel

 up
 down

or



• To select 2 or more-digit channel position number, e.g. 399



Note

- The TV will automatically go into Standby mode when no operation is performed for 4 hours if [Auto Standby] in the Timer Menu is set to [On].
- The TV will automatically go into Standby mode when no signal is received and no operation is performed for 10 minutes if [No signal Power off] in the Timer Menu is set to [On].

Aspect

Change the aspect ratio (image size)

ASPECT

[Auto]: The best ratio is selected automatically according to the "Aspect Control Signal" (p. 26).

[16:9]: Directly displays the image at 16:9 without distortion (anamorphic).

[14:9]: Displays the image at the standard 14:9 without distortion.

[Just]: Displays a 4:3 image full-screen. Stretching is only noticeable at the left and right edges.

[4:3]: Displays the image at the standard 4:3 without distortion.

[Zoom]: Displays a 16:9 letterbox or 4:3 image without distortion.

[4:3 Full]: Displays a 4:3 image enlarged horizontally to fit the screen.

• For HD (High definition) signals

[Sidecut Just]: Displays a 16:9 letterbox (anamorphic) image full-screen. Stretching is only noticeable at the left and right edges.

• For HD (High definition) signals

[Sidecut Zoom]: Displays a 16:9 letterbox (anamorphic) image full-screen without distortion.

• For HD (High definition) signals

Note

- Aspect mode can be memorised separately for SD (Standard definition) and HD (High definition) signals.
- Aspect cannot be changed in teletext service.

Information banner

Display Information banner



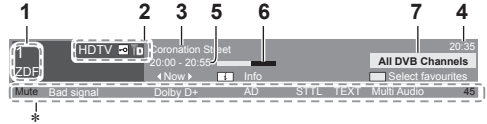

• Also appears when changing a channel.

Example: DVB



1 Channel position and name

2 Channel type ([Radio], [Data], [HDTV], etc.) / Encrypted channel () / TV mode ()

3 Programme

4 Current time

5 Programme Start / Finish time (DVB)
Channel number, etc. (Analogue)

6 Progress time indicator of the selected programme (DVB)

7 [All DVB Channels], [All Analogue Channels] or [Favourites] 1 to 4 (p. 19)

• To switch (DVB)

 (blue)

*Features available / Message meanings

[Mute]

Sound mute on

[Bad signal]

Poor TV signal quality

[Dolby D+], [Dolby D], [HE-AAC]

Audio track

[Also in HD] [UK only]

Same programme available as HD broadcast

[AD]

Audio Description service available

[STTL]

Subtitle service available

[TEXT]

Text service available

[Multi Audio]

Multiple audio available

[Stereo], [Mono], [NICAM]

Audio mode

1 - 90

Off Timer remaining time

■ To confirm another tuned channel name



■ To watch the channel listed in the banner



■ Information on the next programme (DVB)



■ To hide



■ Extra information (DVB)

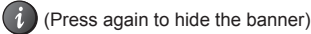

■ To set display timeout

➔ [Banner Display Timeout] (p. 18)

Note

- [AD], [STTL], [TEXT], [Multi Audio] indications are displayed as available on particular programmes, but may not be available for all individual programmes being broadcast. Display the extra information to confirm availability of these functions.

Watching External Inputs

Connect the external equipment (VCRs, DVD equipment, etc.) and you can watch through the input.

1 Turn the TV on



When connecting with SCART or HDMI

Receives input signals automatically when playback starts.

If input mode is not switched automatically

Perform 2 and 3

- Check the setup of the equipment.

2 Display the input selection menu



3 Select the input mode connected to the equipment

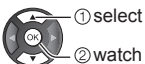
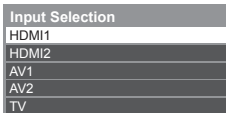

- You can also select the input by pressing the AV button repeatedly.
- To switch between [COMPONENT] and [VIDEO] in [AV2], use left and right cursor button.

Viewing Text Service

Text services are the text information provided by the broadcasters.

The features may vary depending on the broadcasters.

- The availability of text services for a programme is indicated by [TEXT] in the information banner.

[Ireland]

Depending on the broadcaster, the digital text (MHEG) services may not be available. In this case, the operation of the text services may be the same as the analogue teletext services.

Digital text (MHEG)

When you switch to a digital text service, the images you see can contain graphics and text, laid out and controlled in a manner decided by the broadcaster.

1 Select DVB



2 Switch to Text service



■ How to operate services

In all cases, it is possible to navigate the pages using buttons on the remote control, but because the commands available must apply to all manufacturers of digital equipment, some on-screen commands may not correspond exactly to the remote control buttons.

- Select, go
- Symbol: ◀▶▶▶▲



- Back key



- When options with numbers are displayed



- Coloured characters



Coloured button

■ To exit from Text service



Note

- As soon as you switch to a digital channel with links to a text service, software is downloaded in the background to enable the text function. This means that when switching to a digital channel, you should wait for approximately 5 seconds before pressing the TEXT button - this will allow the software to download. If you press the TEXT button before download is complete, it will be ignored and you will have to press the TEXT button again when the download is complete.
- While navigating text services, you will find there is a short delay when moving between pages while the page downloads. There is often a prompt shown on the page (for example "Loading") to let you know that this is happening.

Analogue teletext Ireland

What is FASTEXT mode?

In FASTEXT mode, four differently coloured subjects are situated at the bottom of the screen. To access more information about one of these subjects, press the appropriate coloured button. This facility enables fast access to information on the subjects shown.

What is List mode?

In List mode, four differently coloured page numbers are situated at the bottom of the screen. Each of these numbers can be altered and stored in the TV's memory.

■ To change mode → [Teletext] (p. 18)

1 Switch to Teletext



- Displays the index page (content varies depending on the broadcasters).

2 Select the page



Coloured button
(Corresponds to the colour bar)

■ To adjust contrast



(Press three times)



■ To return to TV



View in multi window

- Operations can be made only in teletext screen.



(Press twice)



Select [Picture and text] On or Off



Reveal hidden data

Reveal hidden words e.g. quiz page answers



(red)

- Press again to rehide.

Subtitles

Call up the page stored on the blue button (List mode)

- Factory setting is "P888" (subtitle service) on the blue button.



FULL / TOP / BOTTOM

MENU



(green)

(TOP)

(BOTTOM)

Normal (FULL)

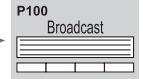
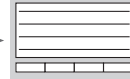
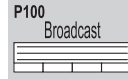

Store frequently viewed pages

Store frequently viewed pages in the colour bar (List mode only)

- If you use Subtitles, do not change number on blue button.

As page is displayed



press and hold

(Corresponding coloured button)

■ To change stored pages

1. Press the coloured button you want to change.
2. Enter new page number with numeric buttons.
3. Press and hold the OK button.

View sub page

View sub page (Only when Teletext is more than one page)



- The number of sub pages varies depending on the broadcasters (up to 79 pages).
- It may take some time for searching, during which time you can watch TV.

■ To view specific sub page



(blue)



Enter the 4-digit number

Example: P6

0 0 0 6

Watch TV while waiting for update

View the TV picture while searching for a teletext page

Teletext automatically updates itself when new information becomes available.



(yellow)

Changes to TV screen temporarily
(You cannot change the channel.)



Appears when updating is completed



View the updated page

(yellow)

- The news page provides a function that indicates arrival of the latest news ("News Flash").

Using TV Guide

TV Guide - Electronic Programme Guide (EPG) provides an on-screen listing of the programmes currently broadcast and the forthcoming broadcasts over the next seven days (depending on the broadcasters).

- This function varies depending on the country you select.
- When this TV is turned on for the first time, or the TV is switched off for more than a week, it may take some time before TV Guide is completely shown.

1 Select the mode



2 View TV Guide

GUIDE



Example: **[UK]**

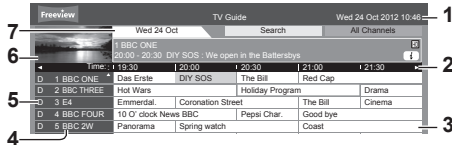

- 1 Current date and time
- 2 TV Guide time
- 3 Programme
- 4 Channel position and name
- 5 [D]: DVB [A]: Analogue
- 6 TV screen
- 7 TV Guide date

■ To watch the programme

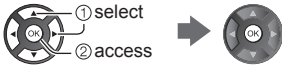

■ To the previous day (DVB)



■ To the next day (DVB)



■ To view a channel list of the selected type (DVB)



■ To search programme titles and view a list of the searched programmes (DVB)

[UK only]



■ To view a channel list of the selected category



■ To view details of the programme (DVB)



■ To change the layout of TV Guide

→ [TV Guide View] (p. 17)

■ To return to TV

EXIT



Using Menu Functions

1 Display the menu

MENU



2 Select the menu



3 Select the item

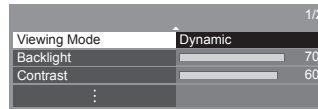

■ Choose from among alternatives

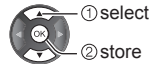

■ Adjust using the slide bar



Moved



■ Go to the next screen

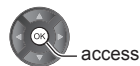
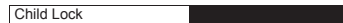

■ Enter characters by free input menu

You can enter names or numbers freely for some items.



Set characters one by one



Store



- You can set characters by using numeric buttons.

Picture

Viewing Mode

Selects your favourite picture mode for each input.

[Dynamic]: Improves contrast and sharpness for viewing in a bright room.

[Normal]: Normal use for viewing in a normal lighting condition.

[Cinema]: Improves the performance of contrast, black and colour reproduction for watching movies in a darkened room.

[True Cinema]: Reproduces the original image quality precisely without any revision.

[Custom]: Adjusts each menu item manually to suit your favourite picture quality.

In each Viewing Mode, [Backlight], [Contrast], [Brightness], [Colour], [Tint], [Sharpness], [Colour Temperature], [Vivid Colour], [Adaptive Backlight Control], [Ambient Sensor], [Noise Reduction] and [MPEG Noise Reduction] can be adjusted and stored.

When in [True Cinema] or [Custom] mode, [Advanced Settings] can be adjusted additionally. The settings in [True Cinema] or [Custom] mode can be stored for each input.

Backlight / Contrast / Brightness / Colour / Tint / Sharpness

Adjusts the levels of these options according to your personal preference.

Colour Temperature

Sets the overall colour tone of the picture (bluer - redder).

Vivid Colour

Automatically adjusts colours to vivid ones.

Adaptive Backlight Control

Automatically controls the level of backlight according to the images.

- If uncomfortable dark images occur, set to [Off].

Ambient Sensor

Automatic Brightness Control function

Adjusts picture settings automatically depending on ambient lighting conditions.

Noise Reduction

Reduces unwanted picture noise.

- Not valid when [1080p Pixel Direct] is set to [On]

MPEG Noise Reduction

Reduces flicker noise in contoured parts of a picture and block noise.

- Not valid when [1080p Pixel Direct] is set to [On]

Advanced Settings

■ Adaptive Gamma Control

Adjusts the gamma curve to make the image brighter.

- Not valid when [Adaptive Backlight Control] is set to [Off]

■ Black Expander

Gradually adjusts the shades of black.

■ White Balance

[R-Gain] / [G-Gain] / [B-Gain]

Adjusts the white balance of bright red / green / blue areas.

[R-Cutoff] / [G-Cutoff] / [B-Cutoff]

Adjusts the white balance of dark red / green / blue areas.

[Reset to Defaults]

Resets to the default White Balance.

■ Colour Management

[R-Hue] / [R-Saturation] / [R-Luminance]

Adjusts the picture hue / saturation / luminance of red areas.

[G-Hue] / [G-Saturation] / [G-Luminance]

Adjusts the picture hue / saturation / luminance of green areas.

[B-Hue] / [B-Saturation] / [B-Luminance]

Adjusts the picture hue / saturation / luminance of blue areas.

[Reset to Defaults]

Resets to the default Colour Management.

■ Gamma

[Gamma]

Switches the gamma curve.

- Please note the numerical values are reference for the adjustment.

[Reset to Defaults]

Resets to the default Gamma.

■ Reset to Defaults

Resets [Advanced Settings] to the default settings.

Option Settings

■ Film Cadence Mode

Improves vertical resolution for movie images.

- This function is available for interlaced signals.

■ 1080p Pixel Direct

39-inch model 42-inch model 50-inch model

Reproduces the original image quality in detail for 1080p (HDMI) input signal.

■ HDMI Content Type

Adjusts the picture settings of each HDMI input according to the selected content type.

- For HDMI input

[Auto]: Automatically adjusts the picture settings according to the received HDMI content if the connected equipment supports HDMI Content Type.

- To set the availability of each content type for [Auto] mode ➔ [Auto Detail Setting]

■ HDMI RGB Range

Adjusts the black level of the image for each HDMI input.

- When the black level is not suitable, select [Full].

- For HDMI input

■ 3D-COMB

Makes still or slow moving pictures more vivid.

Occasionally, while viewing still or slow moving pictures, colour patterning may be seen. Set to [On] to display sharper and more accurate colours.

- For PAL / NTSC signal reception in TV mode or from composite

Screen Settings

■ 16:9 Overscan

Selects the screen area displaying the image for 16:9 aspect.

[On]: Enlarges the image to hide the edge of the image.

[Off]: Displays the image in the original size.

- Set to [On] if noise occurs on the edge of the screen.
- This function can be memorised for SD (Standard definition) and HD (High definition) signals respectively.

■ H-Size

Switches the horizontal display range to reduce noise on the side edge of the image.

- For TV mode, AV and HDMI input

■ Zoom Adjustments

Adjusts the vertical position and size when aspect is set to [Just], [Sidecut Just], [Zoom] or [Sidecut Zoom].

■ Screen Display

Turns the screen off when you select [Off].

This function is effective in reducing power consumption when listening to the sound without watching the TV screen.

- Press any buttons (except Standby) to turn the screen on.

Copy Adjustment

Copies the selected [True Cinema] or [Custom] settings to those of the other input.

Reset to Defaults

Resets the current Picture Viewing Mode to the default settings.

Sound

Mode

Selects your favourite sound mode for each input.

[Standard]: Provides the suitable sound quality for all types of scenes.

[Music]: Improves sound quality for watching music videos, etc.

[Speech]: Improves sound quality for watching news, drama, etc.

[User]: Adjusts the sounds manually by using the equaliser to suit your favourite sound quality.

- In each mode, [Bass], [Treble] and [Surround] can be adjusted and stored.
- For the User mode, [Equaliser] will be available in the Sound Menu instead of [Bass] and [Treble]. Select [Equaliser] and adjust the frequency.
- This function is not effective for the sound from headphones.

Bass

Adjusts level to enhance or minimise lower, deeper sound output.

Treble

Adjusts level to enhance or minimise sharper, higher sound output.

Equaliser

Adjusts the frequency level to suit your favourite sound quality.

- This function is available when [Mode] is set to [User].
- Select the frequency and change the frequency level by using the cursor button.
- To enhance the bass sound, raise the level of the lower frequency. To enhance the treble sound, raise the level of the higher frequency.
- To reset the levels of each frequency to the default settings, select [Reset to Defaults] by using the cursor button.

Balance

Adjusts volume level of right and left speakers.

Surround

Provides a dynamic enhancer of width to simulate improved spatial effects.

Headphone Volume

Adjusts the volume of headphones.

Auto Gain Control

Automatically regulates large sound level differences between channels and inputs.

Volume Correction

Adjusts the volume of each individual channel or input mode.

Speaker Distance to Wall

Compensates for the low frequency sound due to the distance between the speakers and the wall.

- If the back space between the TV and wall is within 30 cm, [Up to 30cm] is recommended.
- If the back space between the TV and wall is over 30 cm, [Over 30cm] is recommended.

NICAM

Near Instantaneous Companded Audio Multiplex

Reproduces NICAM stereo sound.

- Set to [Off] if reception is poor (FM monaural sound)
- For Analogue mode

Audio Preference Ireland only

Selects the initial setting for audio tracks.

[Multichannel]: The priority is given to multi-channel audio track.

[Stereo]: The priority is given to stereo (2ch) audio track.

[MPEG]: The priority is given to MPEG.

- MPEG is an audio compression method that compresses audio to the smaller size without any considerable loss of audio quality.
- For digital mode

SPDIF Selection

SPDIF: A standard audio transfer file format
Selects the initial setting for digital audio output signal from DIGITAL AUDIO and HDMI2 (ARC function) terminals.

[Auto]: Dolby Digital Plus, Dolby Digital and HE-AAC multi-channel are output as Dolby Digital Bitstream. MPEG is output as PCM. DTS is output as DTS for video contents of Media Player.

[PCM]: Digital output signal is fixed to PCM.

- ARC (Audio Return Channel): A function of digital audio output using HDMI cable
- For DVB mode or video contents of Media Player (p. 21)

SPDIF Delay (Ireland only)

Adjusts the delay time of the sound output from DIGITAL AUDIO and HDMI2 (ARC function) terminals if the sound does not synchronise the image.

- For digital mode

Audio Description

■ Audio Description

Narration settings for visually impaired users.

Set to [Auto] to activate the narration sound track when available on the broadcast.

- The availability of audio description sound track is indicated by [AD] in the information banner (p. 11).
- For DVB mode

■ Volume (UK only)

Adjusts the volume for Audio Description.

- For DVB mode

■ Speakers (UK only)

Set to [On] to activate the description sound track from TV speakers.

- For DVB mode

■ Headphones (UK only)

Set to [On] to activate the description sound track from headphones.

- For DVB mode

HDMI Input

■ HDMI1 / 2

Selects to fit the input signal. (p. 26)

[Digital]: When sound is carried via the HDMI cable connection

[Analogue]: When sound is not carried via the HDMI-DVI adaptor cable connection

- For HDMI input

Reset to Defaults

Resets the current Sound Mode to the default settings.

Network

Network Connection

Sets the network setting to use this TV in your network environment. (p. 21)

Network Status

Displays and checks the network status. (MAC Address, current network settings, etc.)

Software Update

Checks for available software updates from the Panasonic website. (p. 21)

New Software Message

Selects whether to give a notification message when new software is found via network.

Timer

Off Timer

Sets the duration of time until the TV automatically goes into Standby mode.

Time Zone (Ireland only)

Adjusts the time data.

- The time data will be corrected based on GMT.

Auto Standby

Automatically turns the TV to Standby mode for energy saving when no operation is performed for 4 hours.

- Automatic input switching with the connected equipment affects this function and time-count will be reset.
- The notification message will appear 3 minutes before going into Standby mode.

No signal Power off

Automatically turns the TV to Standby mode to prevent unnecessary power consumption when no signal is received and no operation is performed for 10 minutes.

- The notification message will appear 3 minutes before going into Standby mode.

Setup

Eco Navigation

Automatically sets the TV to the most suitable energy-saving mode.

The concerned items and their current settings are displayed. Select [Set to Eco] to set them to the energy-saving settings at once.

TV Guide Settings

■ TV Guide View

Changes the layout of TV Guide.

[Normal]: Default TV Guide screen

[Full]: Displays channels and programmes full-screen without the operation guide.

[Info]: Displays details of the selected programme at the bottom without the operation guide.

Child Lock

Applies access control for channels or inputs to prevent unwanted access. (p. 20)

Tuning Menu*

■ Favourites Edit

Creates a list of favourite channels. (p. 19)

- Not valid on Analogue mode

■ Channel List

Skips unwanted channels or edits channels. (p. 19)

■ Auto Setup

Automatically searches for receivable channels. (p. 19)

■ Channel Sorting by Region (UK only)

Automatically sorts tuned channels according to the available region. (p. 19)

- For DVB mode

■ Manual Tuning

Searches for channels manually. (p. 19)

■ Update Channel List

Updates the channel list while keeping your settings. (p. 20)

- For DVB mode

■ New Channel Message

Selects whether to give a notification message when a new channel is found.

- For DVB mode

■ Signal Condition

Checks the signal condition.

- Not valid on Analogue mode

Language

■ Preferred Multi Audio (UK only)

Selects the preferred language for digital channel multi audio. (depending on the broadcaster)

■ Preferred Audio 1 / 2 (Ireland only)

Selects the first and second preferred language for digital channel multi audio. (depending on the broadcaster)

■ Preferred Subtitles 1 / 2 (Ireland only)

Selects the first and second preferred language for digital channel subtitles. (depending on the broadcaster)

■ Preferred Subtitles (UK only)

Selects the preferred language for digital channel subtitles. (depending on the broadcaster)

- provides aids in understanding and enjoyment with subtitles (depending on the broadcaster).

■ Preferred Teletext (Ireland only)

Selects the preferred language for digital channel teletext service. (depending on the broadcaster)

Display Settings

■ Preferred Subtitle Type (Ireland only)

Selects the preferred subtitle type.

- [Hard of Hearing] provides aids in understanding and enjoyment with digital channel subtitles (depending on the broadcaster).
- [Preferred Subtitles 1 / 2] in [Language] are given priority.

■ Teletext

Analogue teletext display mode. (p. 13)

■ Teletext Character Set (Ireland only)

Selects teletext language font.

[West]: English, French, German, Greek, Italian, Spanish, Swedish, Turkish, etc.

[East1]: Czech, English, Estonian, Lettish, Rumanian, Russian, Ukrainian, etc.

[East2]: Czech, Hungarian, Italian, Lettish, Polish, Rumanian, etc.

■ Input Labels

Accesses the input labels list to select the label of each input mode or set to skip unconnected one for easier identification and selection in [Input Selection] (p. 12) or banner.

- To name each input mode freely, select [User input] and set characters (maximum 10 characters).
- To skip the input mode, select [Skip].

■ Banner Display Timeout

Sets how long the Information banner stays on screen.

■ Radio Mode

Sets the timer for turning off the screen automatically when a radio channel is selected.

The sound is active even if the screen turns off. This function is effective in reducing power consumption when listening to a radio channel.

- Press any buttons except Standby, Volume Up / Down and MUTE buttons to turn the screen on.
- Not valid on Analogue mode

VIERA Link Settings

■ VIERA Link

Sets to use VIERA Link functions. (p. 25)

■ Power on Link

Sets to use Power on Link functions. (p. 25)

■ Power off Link

Sets to use Power off Link functions. (p. 25)

■ Standby Power Save

Controls the connected equipment to reduce power consumption in Standby. (p. 25)

- This function is available when [VIERA Link] is set to [On] and [Power off Link] is set to [On].

■ Intelligent Auto Standby

Makes non-watched or non-used connected equipment go into Standby mode to reduce the power consumption. (p. 25)

- This function is available when [VIERA Link] is set to [On].

System Menu

■ USB Keyboard Layout

Selects the language that your USB Keyboard supports.

- For information of using USB Keyboard ➔ (p. 28)

■ Shipping Condition

Resets all settings to the original condition.

■ Common Interface

Sets to watch encrypted channels, etc.

■ System Update

Downloads new software to this TV. (p. 20)

■ Licence Menu

[Software Licence]

Displays the software licence information.

Other Settings

■ Power on Channel List

Automatically selects All Channels or Favourites list in the Information banner when the TV is turned on.

Set to [All Channel List] to display all the channels. Set to [Last] to display the one you selected last time.

- Not valid on Analogue mode

■ Power Save

Reduces brightness of the picture to economise on power consumption.

Help

TV Self Test

Makes a diagnosis of picture or sound problems. Follow the on-screen instructions.

System Information

Displays the system information of this TV.

Note

- *The menu name varies depending on the TV mode.
- A different menu will be displayed in the mode of Media Player. (p. 21)
- Only available items can be selected.

Tuning and Editing Channels

You can retune channels or make your favourite channel lists, skip unwanted channels, etc.

MENU  → [Setup] → [Tuning Menu]*

- *The menu name varies depending on the TV mode. ([DVB Tuning Menu] / [Analogue Tuning Menu])
- The settings in [Tuning Menu] are applicable only for the selected TV mode.

Favourites Edit

Create your favourite DVB channel lists from various broadcasters (up to 4: [Favourites]1 to 4). The DVB Favourites lists are available for switching in the Information banner and from "Category" in the TV Guide screen.

1 Select a channel to list  : Encrypted channel)

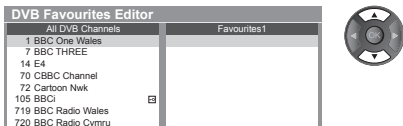

2 Add it to the Favourites list

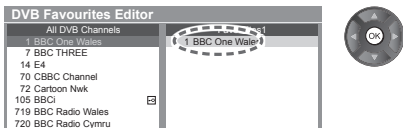

3 Store



To edit the list by using the coloured buttons

- While the cursor is in the left field
- **Select favourites:** Displays other Favourites.
- **Add all:** Adds all channels.

While the cursor is in the right field



- **Edit list name:** Names the Favourites.
- **Move:** Moves the channel.
- **Delete all:** Deletes all channels.

Channel List

You can hide (skip) unwanted channels. The hidden channels cannot be displayed except in this function.

Select a channel and reveal / hide

Example: DVB

All DVB Channels	
	70 CBBC Channel
	72 Cartoon Nwk
	105 BBCI
	719 BBC Radio Wales
	720 BBC Radio Cymru
	1 BBC ONE Wales
	7 BBC THREE



 : [Reveal]
 : [Hide] (skip)

To edit the list by using the coloured buttons

- **Tune:** Retunes each channel ([Manual Tuning]).
- **Swap:** Swaps the channel position number (logical channel number). (DVB)
- **Move:** Moves the channel position. (Analogue)
- **Reveal all:** Reveals all channels.
- **Rename:** Renames the channel name. (Analogue)

Note

- If a VCR is connected only with the RF cable in Analogue mode, edit [VCR].

Auto Setup

Automatically retune the channels received in the area.

- This function is available if channel tuning has already been performed.
- Only the selected mode is retuned. All the previous tuning settings are erased.
- If Child Lock PIN number has been set, the PIN number is required.
- If tuning has not been done completely → [Manual Tuning]

Channel Sorting by Region

You can sort DVB channels so that those with the best signal quality, or those for your preferred region, appear nearer the top of your Channel List. Normally, you should select [Best signal quality (All Regions)].

- If you choose to select your preferred region, you could find channels with a weaker signal appear nearer the top of your Channel List. If you have any image or sound problems, select [Best signal quality (All Regions)] instead.

Manual Tuning

Normally use [Auto Setup] or [Update Channel List] to retune DVB channels.

If tuning has not been done completely or for adjusting the direction of the aerial, use this function.

- All channels found will be added to the Channel List.

DVB:



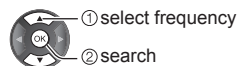



1 Adjust frequency for each channel

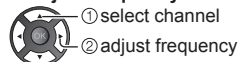

- Set where the level of [Signal Quality] becomes the maximum.

2 Search



Analogue:

[Ireland]

■ Fine Tuning

Use to make small adjustments to the tuning of an individual programme (affected by weather conditions, etc.).

1 Select the channel position



- If a VCR is connected only with the RF cable, select channel position [0].

2 Select the channel



3 Search



4 Select [Store]

Update Channel List

You can add new channels, delete removed channels, update channel name and position automatically to the channel list.

- The channel list is updated while keeping your settings in [Favourites Edit], [Channel List], [Child Lock], etc.
- Depending on the signal condition, the update may not work properly.

Child Lock

You can lock specific channels / AV input terminals and control who watches them.

When the locked channel / input is selected, a message appears. Enter the PIN number to watch.

MENU

➔ [Setup] ➔ [Child Lock]

1 Enter the PIN number (4 digits)

- Enter the PIN number twice at first setting.
- Make a note of the PIN number in case you forget it.

2 Select [Child Lock List] and set the channel / input to be locked

Child Lock List - TV and AV			
Name	Input	Type	Lock
101 BBC 1 Wales	DVB	Free TV	
7 BBC THREE	DVB	Free TV	🔒
14 E4C	DVB	Free TV	
VCR	Analogue	Analogue	
1 BBC1	Analogue	Analogue	
2 *****	Analogue	Analogue	
HDMI1	External	AV	🔒



🔒 : Appears when the channel / input is locked

To edit the list by using the coloured buttons

- **Lock all:** Locks all channels and input.
- **Unlock all:** Cancels all locks.
- **Next input:** Jumps to the top of the next input.

■ To change the PIN number

Select [Change PIN] and enter a new PIN number twice

■ Freeview Players [UK only]

Applies access control for some MHEG services.

■ To set Parental Rating [Ireland only]

To watch the DVB programme that has the rating information over the selected age, enter the PIN number to watch (depending on the broadcaster).

Select [Parental Rating] and set an age for the restriction of programmes.

Note

- Setting [Shipping Condition] (p. 18) erases the PIN number and all settings.

Updating the TV Software

A new version of software may be released for download to enhance the performance or operations of the TV.

- Download may take a few hours.
- During software download and update, DO NOT switch off the TV.

Update from Broadcasting

If there is an update available, a notification message is displayed when the channel has the update information.

- To update in next Standby mode, select [Standby].
To update immediately, select [Now].
(Select [Ignore] not to update.)

You can search new software automatically or update manually.

MENU

➔ [Setup] ➔ [System Menu] ➔ [System Update]

■ To search an update automatically

Select [Auto Update Search in Standby] and set to [On]

System Update

Auto Update Search in Standby Off
System Update Search Now

- The TV automatically performs a search an update in Standby mode (TV turned off with the remote control). If there is an update available, a notification message will be displayed when the TV is next turned on.

■ To update immediately

1 Select [System Update Search Now]

2 Searches for an update (for several minutes) and displays a corresponding message if any

3 Download



Update from Internet

The ETHERNET terminal is for TV's software update. You can download a newer version of software through the internet, if it is available.

Network connections

Connect the TV and the broadband network equipment (modem, hub or router) by using a LAN cable.

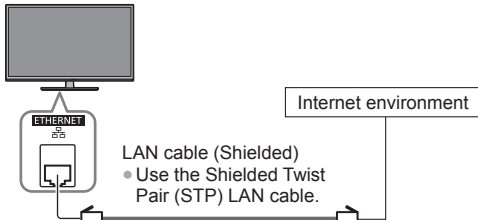

Note

- If you do not have any broadband network services, please consult your retailer for assistance.
- Ensure to use a LAN straight cable for this connection.
- Set up and connect any equipment required for the network environment. You cannot make settings for the equipment on this TV. Read the manual of the equipment.
- Contact your Internet Service Provider (ISP) or telecommunications company for further assistance regarding the network equipment.

Network Setup

MENU ⇒ [Network] ⇒ [Network Connection]

Follow the on-screen instructions.

Update TV's software

MENU ⇒ [Network] ⇒ [Software Update]

Accesses the specific web site to update TV's software and search if any software updates are available. Follow the on-screen instructions.

Using Media Player

Media Player allows you to enjoy photo, video or music recorded on a USB Flash Memory.

Photo mode: Digital photo data will be displayed.

Video mode: Digital video data will be played back.

Music mode: Digital music data will be played back.

- Supported file format ⇒ **"Supported file format in Media Player" (p. 27)**
- During the operation, audio signal is output from AV1, DIGITAL AUDIO and HDMI2 (ARC function) terminals. But no video signals are output. To use HDMI2 with ARC function, connect an amplifier that has ARC function and set to use theatre speakers (p. 24, 26).
- [Date] shows the date on which the recording was made by the recording equipment. The file without record of the date is shown "*****/**/*****".
- The picture may not appear correctly on this TV depending on the recording equipment used.
- Display may take some time when there are many files and folders.
- Partly degraded files might be displayed at a reduced resolution.
- Picture setting may not work depending on the conditions.
- The folder and file names may be different depending on the digital camera or digital video camera used.

■ To insert or remove the USB Flash Memory

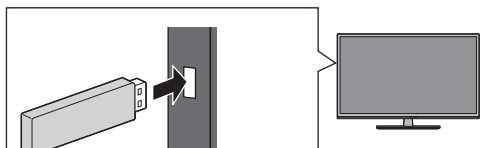

- Insert or remove straightly and completely.
- Connect the USB Flash Memory to the USB port.
- Check the type of terminals and devices are correct when connecting.

1 Insert the USB Flash Memory to the TV

2 Display [VIERA TOOLS] and select the content (Photo / Video / Music)



- Select the appropriate device and content for playing back each file.

■ To change the device

While the thumbnail is displayed, display the device selection

(yellow)

■ To change the contents

While the thumbnail is displayed, display the contents selection

(blue)

Photo mode

Example: Thumbnail - [All photos]



: Error display

- To change the size of photos on a thumbnail screen

OPTION



[Change Size]

[Single view] - Photos are displayed one at a time.

Select the file from the thumbnail of photos to be viewed

[Slideshow] - Slideshow completes when all photos are viewed within the current thumbnail.

1 Select the file from the thumbnail of photos for the first view

2 Start Slideshow



- To display / hide the operation guide



■ **To sort by folder, recorded date or recorded month**

1 Display the view selection in the thumbnail view



2 Select the sort type

[Folder view]:

Displays the thumbnail grouped by folder.

- The files which are not into a folder will be collected to the folder named "f".

[Sort by Date] / [Sort by Month]:

Displays the thumbnail grouped by the same date or month.

- The group of the photos without a recorded date is shown as [Unknown].

Photo Settings

OPTION



[Slideshow Settings]

■ **Frame**

Selects the frame type of the slideshow.

■ **Colour Effect**

Selects the colour effect of photos on Single view and Slideshow.

- This function is not available when [Frame] is set to [Drift], [Gallery] or [Cinema].

■ **Transition Effect**

Selects the transition effect for switching the photo during the slideshow.

- This function is available when [Frame] is set to [Off].

■ **Auto Makeup**

Automatically detects the face in the photo and improves luminance and contrast.

■ **Aspect**

Selects enlarged or normal viewing on Single view and Slideshow.

- This function is not available when [Frame] is set to [Collage], [Drift], [Gallery] or [Cinema] / when [Transition Effect] is set to [Motion].
- Depending on the photo size, it may not be fully enlarged to fill the screen, e.g. portrait style picture.

■ **Burst Playback**

Selects whether to display burst photos in a fast-paced slideshow mode.

- This function is not available when [Frame] is set to [Drift], [Gallery] or [Cinema] / when [Transition Effect] is set to [Motion].

■ **Interval**

Selects slideshow interval.

- This function is not available when [Frame] is set to [Drift], [Gallery] or [Cinema] / when [Transition Effect] is set to [Motion].

■ **Repeat**

Slideshow repeat

■ **Back Ground Music**

Selects the back ground music during Photo mode.

- [Type1 - 5] are the fixed music each installed in this TV. [User]: Music data in the device registered by yourself will be played back.

To register the music

1. Select the music file

Depending on the condition of the device, select folders until you reach the desired music file.

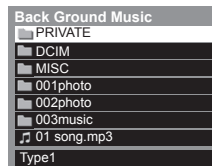

2. Select [File] or [Folder]

[File]: The selected music file will be registered.

[Folder]: All the music in the folder which contains the selected music file will be registered.

- If no music has been registered or the device which has the registered music is removed, no sound will be produced.

[Auto]: Music data stored in the root folder of the current device will be played back randomly.

- If there is no available music data, no sound will be produced.

Note

- Picture quality may become lower depending on the slideshow settings.
- Picture setting may not work depending on the slideshow settings.

Video mode

Example: Thumbnail - [Title view]

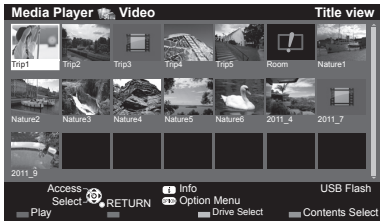

: Error display

: The file does not support thumbnail view.

The preview will start when the title / scene is highlighted if it supports a preview.

• To turn off the preview → [Video Preview]

1 Select the title / scene

2 Start playback

(red)

• If you stopped the last playback on the way, the confirmation screen is displayed to select whether to start from where you stopped last time or from the beginning.

• To display / hide the operation guide and information banner



• To change aspect

ASPECT



• To jump to the specified time point



While the time seek bar is displayed, use left and right cursor button.

Press: Search about 10 seconds

Press and hold: Search rapidly

Video Setup

OPTION → [Video Setup]

■ Video Preview

Sets to start the preview of the title or scene in the thumbnail view.

- Image may not be displayed for an instant in the thumbnail view. Set the preview [Off] to resolve this.
- Only available in the thumbnail view

■ Multi Audio, Dual Mono Audio

Selects between selectable sound tracks (if available).

- It may take several seconds to change the sound.
- Only available during playback

■ Subtitle

Subtitles On / Off (if available).

- Only available during playback

■ Subtitle Text

Selects the font type to display subtitles correctly (if available).

- Only available during playback

■ Repeat

Playback repeat within the selected file (depending on the content).

Music mode

Example: Thumbnail - [Folder view]

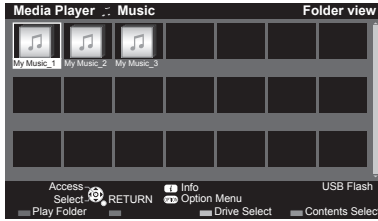

1 Select the folder / file

2 Start playback

(red)

• To display / hide the operation guide



Music Setup

OPTION → [Music Setup]

■ Repeat

[Folder]: Playback repeat within the selected folder

[One]: Playback repeat of the selected one file

VIERA Link

VIERA Link “HDAVI Control”™

Enjoy additional HDMI Inter-Operability with Panasonic products which have “HDAVI Control™” function.

VIERA Link (HDAVI Control) connects the TV and the equipment with VIERA Link function, and enables easy control, playback, energy saving, creating home theatre, etc., without complicated settings. Connections to the equipment (DIGA Recorder, HD Video Camera, Player theatre, Amplifier, etc.) with an HDMI cable allow you to interface them automatically (p. 24). These features are limited to models incorporating “HDAVI Control” and “VIERA Link”.

- This TV supports “HDAVI Control 5” function. “HDAVI Control 5” is the newest standard for HDAVI Control compatible equipment. This standard is compatible with conventional HDAVI equipment.
- Some functions are not available depending on the equipment’s version of HDAVI Control. Confirm the connected equipment’s version of HDAVI Control.
- Some functions may not work properly depending on the connected equipment.
- VIERA Link features may be available even with other manufacturers’ equipment supporting HDMI CEC.
- VIERA Link “HDAVI Control” is a unique function that we have developed and added based on the control functions provided by HDMI which is an industry standard known as HDMI CEC (Consumer Electronics Control). As such, its operation with other manufacturers’ equipment that supports HDMI CEC cannot be guaranteed.

- Please refer to individual manuals for other manufacturers' equipment supporting VIERA Link function.
- About applicable Panasonic equipment, consult your local Panasonic dealer.
- To confirm this TV's version of HDAVI Control
➔ [System Information] (p. 19)

Summary of VIERA Link features

■ VIERA Link (HDMI connection)

Features \ Connected equipment	DIGA Recorder	DVD Player / Blu-ray Disc Player	HD Video Camera / LUMIX Camera
Easy playback	○	○	○
Power on Link	○	○	○
Power off Link	○	○	○
Standby Power Save	○*2	○*2	-
Intelligent Auto Standby	○*2	○*2	-
VIERA Link Control	○*1	○*1	○*1
Speaker Selection	-	-	-

Connection

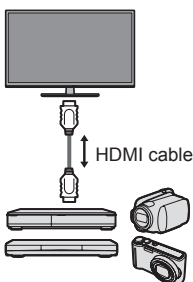

DIGA Recorder / DVD Player / Blu-ray Disc Player / HD Video Camera / LUMIX Camera with VIERA Link function

- Use a fully wired HDMI compliant cable.
- Connect the equipment supporting VIERA Link to the TV's HDMI terminal via an HDMI cable.
- About HDMI cable for connecting Panasonic HD Video Camera or LUMIX Camera, read the manual of the equipment.

■ VIERA Link (HDMI and Audio out connections)

Features \ Connected equipment	Player theatre	Blu-ray Disc theatre	Amplifier
Easy playback	○*3	○*3	-
Power on Link	○	○	-
Power off Link	○	○	○
Standby Power Save	-	○*2	-
Intelligent Auto Standby	○*2 *4	○*2 *4	○*2
VIERA Link Control	○*1	○*1	-
Speaker Selection	○	○	○

Connection

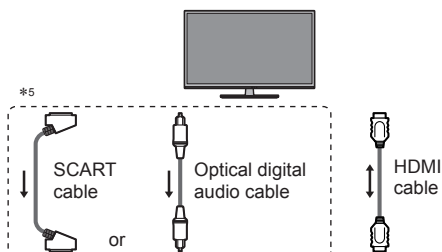

- To use Amplifier
- To use Player theatre / Blu-ray Disc theatre

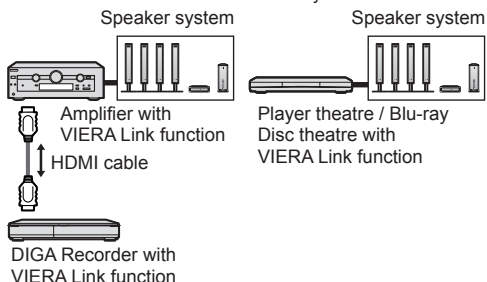

- Use a fully wired HDMI compliant cable.
- Connect the equipment supporting VIERA Link to the TV's HDMI terminal via an HDMI cable.
- Use a fully wired SCART cable.
- Use the optical digital audio cable or SCART cable for audio output from the TV.

- *1: Available with the equipment which has "HDAVI Control 2 or later" function.
- *2: Available with the equipment which has "HDAVI Control 4 or later" function.
- *3: While playing a disc.
- *4: Except for watching a disc.
- *5: If the connected equipment has "HDAVI Control 5" function, you do not have to use this audio cable (Optical digital audio cable or SCART cable). In this case, connect the equipment to the TV's HDMI2 terminal via an HDMI cable.

■ VIERA Link Control of compatible equipment

- Table below displays maximum number of compatible equipment that can be controlled by [VIERA Link Control]. This includes connections to equipment already connected to the TV. For example, DIGA Recorder connected to Amplifier which is connected to the TV via an HDMI cable.

Type of the equipment	Maximum number
Recorder (DIGA Recorder, etc.)	3
Player (DVD Player, Blu-ray Disc Player, HD Video Camera, LUMIX Camera, Digital Camera, Player theatre, Blu-ray Disc theatre, etc.)	3
Audio system (Player theatre, Blu-ray Disc theatre, Amplifier, etc.)	1
Tuner (Set top box, etc.)	4

Operations

Preparations

- VIERA Link connection ➔ (p. 24)
- Set up the connected equipment. Read the manual of the equipment.
- Set [VIERA Link] to [On] in the Setup Menu. ➔ (p. 18)
- Set up the TV.

After connection, turn the equipment on and then switch the TV on.

Select the input mode from HDMI1 or HDMI2 (p. 12), and make sure that an image is displayed correctly.

This setup should be done each time when the

following conditions occur:

- for the first time
- when adding or reconnecting equipment
- when changing setup

Easy playback

Automatic input switching - When the connected equipment is operated, input mode is switched automatically.

- Image or sound may not be available for the first few seconds when input mode is switched.

Power on Link

Set [Power on Link] to [On] in the Setup Menu to use this function ➔ (p. 18)

When the connected equipment starts playback or direct navigator / function menu for the equipment are activated, the TV is automatically turned on. (Only when the TV is in Standby mode.)

Power off Link

Set [Power off Link] to [On] in the Setup Menu to use this function ➔ (p. 18)

When the TV is set to Standby mode, the connected equipment is also automatically set to Standby.

- This function will work even if the TV enters Standby mode automatically by auto power standby function.

Standby Power Save

Set [Standby Power Save] to [On] in the Setup Menu to use this function ➔ (p. 18)

The power consumption of the connected equipment in Standby mode is controlled higher or lower in synchronisation with the TV on / off state to reduce the consumption.

When the TV is set to Standby mode, the connected equipment is automatically set to Standby and the power consumption of the connected equipment is automatically minimised.

When the TV is turned on, the connected equipment is still in Standby mode, but the power consumption is increased to make startup time fast.

- This function is effective if the connected equipment can change the power consumption in Standby mode and is set to higher consumption.
- This function works when [Power off Link] is set to [On].

Intelligent Auto Standby

Set [Intelligent Auto Standby] to [On] in the Setup Menu to use this function ➔ (p. 18)

When the TV is on, non-watched or non-used connected equipment goes into Standby mode automatically to reduce the power consumption. For example, when the input mode is switched from HDMI or when [Speaker Selection] is changed to [TV] (except for watching a disc).

- This function may not work properly depending on the connected equipment. If required, set to [Off].

VIERA Link Control

You can control some functions of the connected equipment with this TV remote control pointing at the TV's signal receiver.

- If you cannot operate, check the settings and the equipment.

1 Display [VIERA TOOLS] and select [VIERA Link]



2 Select [VIERA Link Control]

3 Select the type of the connected equipment to access



[Recorder] / [Player] / [Home Cinema] / [Video Camera] / [LUMIX] / [Digital Camera] / [Other]

- The displayed item may vary depending on the connected equipment.
- [Home Cinema] means Player theatre, Blu-ray Disc theatre or Recorder theatre.
- [Other] means Tuner set top box.

The menu of the accessed equipment will be displayed.

(Input mode will be changed automatically.)

4 Follow the operation guide to operate the menu of the equipment

- To display the operation guide

OPTION



- For details of the operations for the connected equipment, read the manual of the equipment.
- If other manufacturers' equipment is accessed, Setup / Contents Selection menu may be displayed.
- Available VIERA remote control buttons depend on the connected equipment.

Note

- Some operations may not be available depending on the equipment. In this case use its own remote control to operate the equipment.

■ If multiple recorders or players are connected

The number is given from the TV's lower number of HDMI terminal connected to the same type equipment. For example, two recorders to HDMI1 and HDMI2, the recorder connected to HDMI1 is displayed as [Recorder1], and the recorder connected to HDMI2 is displayed as [Recorder2].

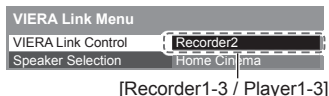

■ If you access non-VIERA Link equipment

The type of the connected equipment is displayed. Although you can access the connected equipment, you cannot operate it. Use its own remote control to operate the equipment.

Speaker Selection

You can control the theatre speaker with this TV remote control pointing at the TV's signal receiver.

- If you cannot operate, check the settings and the equipment.

1 Display [VIERA TOOLS] and select [VIERA Link]



2 Select [Speaker Selection]

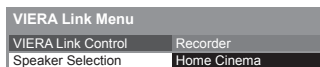

3 Set to [Home Cinema] or [TV]

[Home Cinema]: The sound is from theatre speakers. Player theatre, Blu-ray Disc theatre or Amplifier will be automatically turned on if it is in Standby mode.

- Volume up / down



- Mute



- The sound of TV speakers is mute. When the equipment is turned off, TV speakers will be active.

[TV]: TV speakers are active.

■ Multi-channel sound

If you want to enjoy the multi-channel sound (e.g. Dolby Digital 5.1ch) via an Amplifier, connect it with an HDMI cable and Optical digital audio cable (p. 24), and then select [Home Cinema]. If your Amplifier has "HDAVI Control 5" function, you only need to connect it with an HDMI cable to the TV's HDMI2 terminal.

To enjoy the sound from the DIGA Recorder in multi-channel sound, connect an HDMI cable from the DIGA Recorder to the Amplifier (p. 24).

Technical Information

Aspect Control Signal

Programmes usually contain an "Aspect Control Signal" (Widescreen signal, Control signal through SCART / HDMI terminal).

In [Auto] mode, aspect mode will appear in the top left of the screen if a Widescreen signal (WSS) or a Control signal through SCART (pin8) / HDMI terminal is found. The aspect will switch to the appropriate ratio.

■ Available conditions for the Widescreen signal (WSS)

Input terminal	Input signal format
Terrestrial	DVB
	PAL I
AV1 / AV2 (Composite)	PAL
AV2 (Component)	625 (576) / 50i, 50p

Note

- If the screen size looks unusual when a widescreen-recorded programme is played back on a VCR, adjust the tracking of the VCR.

HDMI connection

This TV incorporates HDMI™ technology. HDMI (high-definition multimedia interface) allows you to enjoy high-definition digital images and high-quality sound by connecting the TV and the equipment.

HDMI-compatible equipment*1 with an HDMI or DVI output terminal, such as a DVD player, a set top box or game equipment, can be connected to the HDMI terminal using an HDMI compliant (fully wired) cable.

■ Applicable HDMI features

- Input audio signal: 2ch Linear PCM (sampling frequencies - 48 kHz, 44.1 kHz, 32 kHz)
- Input video signal ➔ **"Input signal that can be displayed"**
Match the output setting of the digital equipment.
- VIERA Link (HDAVI Control 5) ➔ **"VIERA Link"** (p. 23)
- Content Type
- Audio Return Channel*2 (HDMI2 terminal only)

■ DVI connection

If the external equipment has only a DVI output, connect to the HDMI terminal via a DVI to HDMI adaptor cable. When the DVI to HDMI adaptor cable is used, connect the audio cable to AV2 audio terminals.

Note

- Audio settings can be made on [HDMI Input] in the Sound Menu. (p. 17)
- If the connected equipment has an aspect adjustment function, set the aspect ratio to "16:9".
- These HDMI connectors are compatible with HDCP (High-Bandwidth Digital Content Protection) copyright protection.

- Equipment having no digital output terminal may be connected to the input terminal of component or video to receive analogue signals.

*1: The HDMI logo is displayed on HDMI-compliant equipment.

*2: Audio Return Channel (ARC) is a function to send digital sound signals via an HDMI cable.

Input signal that can be displayed

■ COMPONENT (AV2) / HDMI terminal

Signal name	COMPONENT	HDMI
525 (480) / 60i, 60p	○	○
625 (576) / 50i, 50p	○	○
750 (720) / 60p, 50p	○	○
1,125 (1,080) / 60i, 50i	○	○
1,125 (1,080) / 60p, 50p, 24p		○

○ : Applicable input signal

- Signals other than above may not be displayed properly.
- The above signals are reformatted for optimal viewing on your display.

Supported file format in Media Player

- Some files may not be played back even if they fulfil these conditions.
- Do not use two-byte characters or other special codes for file names.
- Connected devices may become unusable with this TV if the file or folder names are changed.

Photo

■ JPEG (.jpg / .jpeg)

Image resolution (pixel): 8 × 8 to 30,719 × 17,279

Sub-sampling: 4:4:4, 4:2:2, 4:2:0

- DCF and EXIF standards
- Progressive JPEG is not supported.

Video

■ AVI (.avi)

Video codec: H.264 BP/MP/HP, MPEG1, MPEG2, MPEG4 SP/ASP, VC-1, Windows Media Video Ver. 9
Audio codec: AAC, ADPCM, Dolby Digital, Dolby Digital Plus, DTS core, HE-AAC, LPCM, MPEG Audio, MP3, WMA

- Some subtitles or chapter functions may not be available.
- WMA Pro and WMA Lossless are not supported.

■ MKV (.mkv)

Video codec: H.264 BP/MP/HP, MPEG1, MPEG2, MPEG4 SP/ASP
Audio codec: AAC, Dolby Digital, Dolby Digital Plus, DTS core, HE-AAC, MPEG Audio, MP3

- Some subtitles or chapter functions may not be available.
- WMA Pro and WMA Lossless are not supported.

■ ASF (.asf / .wmv)

Video codec: MPEG4 SP/ASP, VC-1, Windows Media Video Ver. 9

Audio codec: AAC, Dolby Digital, Dolby Digital Plus, HE-AAC, LPCM, MP3, WMA

- Copy-protected files cannot be played back.
- WMA Pro and WMA Lossless are not supported.

■ MP4 (.f4v / .m4v / .mp4)

Video codec: H.264 BP/MP/HP, MPEG1, MPEG2, MPEG4 SP/ASP

Audio codec: AAC, Dolby Digital, Dolby Digital Plus, HE-AAC, MPEG Audio, MP3

- This TV supports this container recorded with Panasonic products. For details, read the manual of the products.

■ FLV (.flv)

Video codec: H.264 BP/MP/HP

Audio codec: AAC, MP3

■ 3GPP (.3gp / .3g2)

Video codec: H.264 BP/MP/HP, MPEG4 SP/ASP

Audio codec: AAC, HE-AAC

■ PS (.mod / .mpg / .mpeg / .vob / .vro)

Video codec: H.264 BP/MP/HP, MPEG1, MPEG2, VC-1

Audio codec: AAC, Dolby Digital, Dolby Digital Plus, HE-AAC, LPCM, MPEG Audio, MP3

■ TS (.mts / .m2ts / .tp / .trp / .ts / .tts)

Video codec: H.264 BP/MP/HP, MPEG1, MPEG2, VC-1

Audio codec: AAC, Dolby Digital, Dolby Digital Plus, DTS core, HE-AAC, MPEG Audio, MP3

Subtitles

■ MicroDVD, SubRip, Tmplayer (.srt / .sub / .txt)

- The video file and subtitles text file are inside the same folder, and the file names are the same except for the file extensions.
- If there are more than one subtitles text files inside the same folder, they are displayed in the following order of priority: ".srt", ".sub", ".txt".

Music

■ MP3 (.mp3)

■ AAC (.m4a)

- Copy-protected files cannot be played back.

■ WMA (.wma)

- Copy-protected files cannot be played back.
- WMA Pro and WMA Lossless are not supported.

■ LPCM (.wav)

■ FLAC (.flac)

USB devices

- It is recommended to connect the USB device to the TV's USB port directly.
- Some USB devices or USB HUB may not be used with this TV.
- You cannot connect any devices by using USB card reader.
- You cannot use two or more same kind of USB devices simultaneously except USB Flash Memory.
- Additional information for the devices may be on the following website.
<http://panasonic.net/viera/support>

■ USB Flash Memory (for playing back in Media Player)

- USB Flash Memory format: FAT16, FAT32 or exFAT
- A USB HDD formatted on a PC is not guaranteed to work in Media Player.
- Data modified with a PC may not be displayed.
- Do not remove the device while the TV is accessing data. Otherwise this can damage device or TV.
- Do not touch the pins on the device.
- Do not subject the device to a high pressure or impact.
- Insert the device in the correct direction. Otherwise this can damage device or TV.
- Electrical interference, static electricity, or erroneous operation may damage the data or device.
- Back up the recorded data at regular intervals to prevent data deterioration, data damage or erratic operation of the TV. Panasonic is not liable for any deterioration or damage of recorded data.

■ USB Keyboard

- Keyboards requiring the drivers are not supported.
- To change the language type ➔ **[USB Keyboard Layout] (p. 18)**
- Characters may not be displayed correctly on the TV screen depending on the connected keyboard or the keyboard layout setting.
- Some of the keys of keyboards may correspond to the operation of the remote control.

Keyboard	Remote Control
↑ / ↓ / ← / →	Cursor buttons
Enter	OK
Backspace	BACK/RETURN
Esc	EXIT
0 - 9 / Character	Numeric buttons
F1	GUIDE
F2	VIERA TOOLS
F3	MENU
F4	AV
F5 / F6	Channel Down / Up
F7 / F8	Volume Down / Up
F9 / F10 / F11 / F12	Coloured buttons

Maintenance

First, remove the mains plug from the socket outlet.

Display panel, Cabinet, Pedestal

Regular care:

Gently wipe the surface of the display panel, cabinet, or pedestal by using a soft cloth to clean the dirt or fingerprints.

For stubborn dirt:

First clean the dust on the surface. Dampen a soft cloth with clean water or diluted neutral detergent (1 part detergent to 100 parts water). Wring the cloth and wipe the surface. Finally, wipe away all the moisture.

Caution

- Do not use a hard cloth or rub the surface too hard, otherwise this may cause scratches on the surface.
- Take care not to subject the TV's surfaces to water or detergent. Liquid inside the TV could lead to product failure.
- Take care not to subject the surfaces to insect repellent, solvent, thinner or other volatile substances. This may degrade surface quality or cause peeling of the paint.
- The surface of the display panel is specially treated and may be easily damaged. Take care not to tap or scratch the surface with your fingernail or other hard objects.
- Do not allow the cabinet and pedestal to make contact with a rubber or PVC substance for a long time. This may degrade surface quality.

Mains plug

Wipe the mains plug with a dry cloth at regular intervals. Moisture and dust may cause fire or electrical shock.

FAQs

Before requesting service or assistance, please follow these simple guides to solve the problem.

When an error message appears, follow the message's instructions. If the problem still persists, contact your local Panasonic dealer or the authorised service centre.

Block noise, frozen or disappearing image occurs in DVB mode / White spots or shadow image (ghosting) occurs in Analogue mode / Some channels cannot be tuned

- Check the position, direction and connection of the aerial.
- Check [Signal Condition] (p. 18). If [Signal Quality] is displayed in red, the DVB signal is weak. Connecting the aerial to the TV directly may improve signal quality than connecting the aerial through the equipment (set top box, DVD, etc.).
- Weather conditions will affect signal reception (heavy rain, snow, etc.), in particular in poor reception areas. Even during good weather, the high pressure can cause poor reception of some channels.
- Due to the digital reception technologies involved, quality of the digital signals may be relatively low in some cases, despite good reception of analogue channels.
- Consult your local dealer or service provider for the availability of services.

Picture quality problem

- Check the settings of the Picture Menu.
- Set [Noise Reduction] and [MPEG Noise Reduction] to remove noise (p. 15).
- Check nearby electrical products (car, motorcycle, fluorescent lamp).
- Reset channels.
- Check that the output of the external equipment matches the input of the TV. When connecting with SCART, ensure the output setting of the external equipment is not S-Video.

Sound quality problem

- Check the volume level or sound mute.
- Check connections and setting of external equipment.
- Ensure that [Speaker Selection] is set to [TV] (p. 26).
- Sound signal reception may be deteriorated.
- Set [NICAM] to [Off] (p. 16).

Picture or sound problems with HDMI connection

- Check the HDMI cable is connected properly.
- Turn the TV and equipment off, then turn them on again.
- Check an input signal from the equipment.
- Use equipment compliant with EIA/CEA-861/861D.
- Set the sound setting of the connected equipment to "2ch L.PCM".
- Check the [HDMI Input] setting (p. 17).
- If digital sound connection has a problem, select analogue sound connection.

The TV does not switch on

- Check the mains lead is plugged into the TV and the socket outlet.
- The fuse in the mains plug may have blown. Replace it with one of an identical rating. ➔ (p. 3)

The TV goes into Standby mode

- Auto power standby function is activated.

The remote control does not work or is intermittent

- Are the batteries installed correctly? ➔ (p. 9)
- Has the TV been switched on?
- The batteries may be running low. Replace them with new ones.
- Point the remote control directly at the TV's remote control signal receiver (within about 7 m and a 30 degree angle of the signal receiver).
- Situate the TV away from sunshine or other sources of bright light not to shine on the TV's remote control signal receiver.

No image can be displayed

- Check the TV is turned on.
- Check the mains lead is plugged into the TV and the socket outlet.
- Check the correct input mode is selected.
- Check the setting of [AV2] ([COMPONENT] / [VIDEO]) in [Input Selection] to match the output of the external equipment (p. 12).
- Check the settings of the Picture Menu.
- Check all required cables and connections are firmly in place.

Unusual image is displayed

- Turn the TV off with Mains power On / Off switch, then turn it on again.
- If the problem persists, initialise all settings. ➔ [Shipping Condition] (p. 18)

There may be red, blue, green and black spots on the screen

- This is a characteristic of liquid crystal panels and is not a problem. The liquid crystal panel is built with very high precision technology giving you fine picture details. Occasionally, a few non-active pixels may appear on the screen as a fixed point of red, green, blue or black. Please note this does not affect the performance of your LCD.

Parts of the TV become hot

- Even if the temperature of parts of the front, top and rear panels has risen, these temperature rises do not cause any problems in terms of performance or quality.

The LCD panel moves slightly and clattered sound is heard when it is pushed with a finger

- There is some flexibility around the panel to prevent damage to the panel. This is not a malfunction.

Overcurrent error message appears

- The connected USB device might cause this error. Remove the device and turn the TV to standby mode with Standby On / Off switch, then turn it on again.
- Check foreign objects are not inside the USB port.

Check you can get Freeview HD in your area. Text your postcode, followed by your house number or name to **80560***. Or visit **freeview.co.uk**

*e.g. NW96NY1 (Costs no more than a normal text.)

To get the most up to date service from Freeview it is important for Freeview customers to retune from time to time.

How do I re-tune my Freeview TV ?

This is a quick reference. If you have any problems, check the Operating Instructions or ask a friend or family member to show you how. Alternatively, go to your local electrical retailer, contact your local Panasonic dealer or visit **freeview.co.uk/retune**

Re-tuning only takes a few minutes, just follow the steps below:

1. Press the TV button to select DVB mode.
2. Press the MENU button to open the main menu.
3. [Setup] ➔ [DVB Tuning Menu] ➔ [Auto Setup]

Please note: most digital TV recorders will keep your original recordings after running a re-tune but you will need to reset any future recordings.

Specifications

		32-inch model	39-inch model	42-inch model	50-inch model
Model No.		TX-L32B6B TX-L32B6BS	TX-L39B6B	TX-L42B6B	TX-L50B6B
Dimensions (W × H × D)		741 mm × 515 mm × 184 mm (With Pedestal) 741 mm × 450 mm × 78 mm (TV only)	896 mm × 602 mm × 217 mm (With Pedestal) 896 mm × 537 mm × 85 mm (TV only)	972 mm × 645 mm × 217 mm (With Pedestal) 972 mm × 580 mm × 89 mm (TV only)	1,139 mm × 739 mm × 275 mm (With Pedestal) 1,139 mm × 674 mm × 89 mm (TV only)
Mass		7.0 kg Net (With Pedestal) 6.0 kg Net (TV only)	10.0 kg Net (With Pedestal) 9.0 kg Net (TV only)	12.0 kg Net (With Pedestal) 10.0 kg Net (TV only)	18.0 kg Net (With Pedestal) 15.0 kg Net (TV only)
Sound	Speaker	(90 mm × 25 mm) × 2, 8 Ω	(100 mm × 30 mm) × 2, 8 Ω		
	Audio output	10 W (5 W + 5 W)	20 W (10 W + 10 W)		
	Headphones	M3 (3.5 mm) stereo mini Jack × 1			
Power source		AC 220-240 V, 50 / 60 Hz			
Panel		LED LCD panel			
Operating conditions		Temperature: 0 °C - 35 °C Humidity: 20 % - 80 % RH (non-condensing)			
Connection terminals	AV1 input / output	SCART (Audio/Video in, Audio/Video out, RGB in)			
	AV2 input (COMPONENT / VIDEO)	VIDEO	RCA PIN Type × 1	1.0 V[p-p] (75 Ω)	
		AUDIO L - R	RCA PIN Type × 2	0.5 V[rms]	
		Y P _B , P _R	1.0 V[p-p] (including synchronisation) ±0.35 V[p-p]		
	HDMI 1 / 2 input	TYPE A Connectors HDMI1: Content Type HDMI2: Content Type, Audio Return Channel • This TV supports "HDAVI Control 5" function.			
	Card slot	Common Interface slot (complies with CI Plus) × 1			
	ETHERNET	RJ45, IEEE802.3 10BASE-T / 100BASE-TX			
USB	USB2.0 DC 5 V, Max. 500 mA				
DIGITAL AUDIO output	PCM / Dolby Digital / DTS, Fibre optic				

Receiving systems / Band name Check the latest information on the available services at the following website. http://panasonic.net/viera/support	UK	DVB-T / T2	Digital terrestrial services	
		PAL I	UHF E21 - 68	
		PAL 525/60	Playback of NTSC tape from some PAL Video recorders (VCR) or NTSC disc playback from DVD player and recorder	
		M.NTSC	Playback from M.NTSC Video recorders (VCR)	
		NTSC (AV input only)	Playback from NTSC Video recorders (VCR)	
	Ireland	DVB-T	Digital terrestrial services	
		PAL I	VHF A - J	UHF E21 - E69
			CATV S1 - S20	CATV S21 - S41 (Hyperband)
		PAL 525/60	Playback of NTSC tape from some PAL Video recorders (VCR) or NTSC disc playback from DVD player and recorder	
		M.NTSC	Playback from M.NTSC Video recorders (VCR)	
	NTSC (AV input only)	Playback from NTSC Video recorders (VCR)		
Aerial input	UK	UHF	Ireland	VHF / UHF

Note

- Design and Specifications are subject to change without notice. Mass and Dimensions shown are approximate.
- For the information of power consumption, display resolution, etc., please refer to Product fiche.
- This equipment complies with the EMC standards listed below.
 EN55013, EN61000-3-2, EN61000-3-3, EN55020, EN55022, EN55024

This product incorporates the following software:

- (1) the software developed independently by or for Panasonic Corporation,
- (2) the software owned by third party and licensed to Panasonic Corporation,
- (3) open sourced software.

The software categorized as (3) is distributed in the hope that it will be useful, but WITHOUT ANY WARRANTY, without even the implied warranty of MERCHANTABILITY or FITNESS FOR A PARTICULAR PURPOSE. Please refer to the detailed terms and conditions thereof shown in the "Software Licence" menu on this product.

■ When using the wall-hanging bracket

- Please contact your local Panasonic dealer to purchase the recommended wall-hanging bracket.

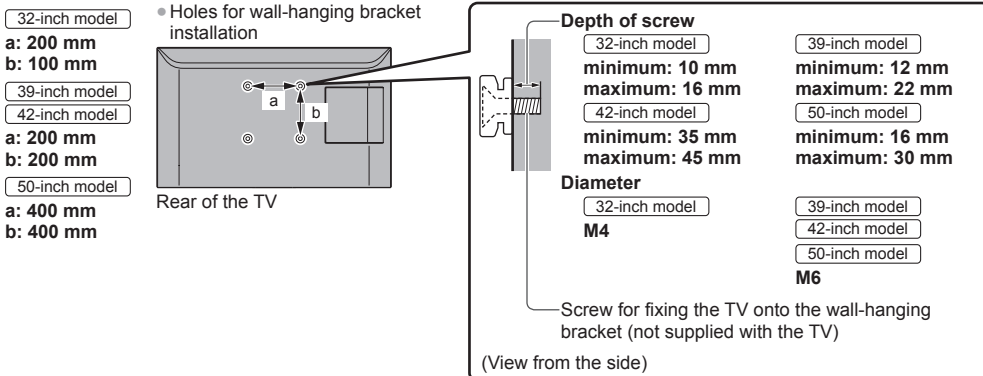

Warning

- Using other wall-hanging brackets, or installing a wall-hanging bracket by yourself have the risk of personal injury and product damage. In order to maintain the unit's performance and safety, be absolutely sure to ask your dealer or a licensed contractor to secure the wall-hanging brackets. Any damage caused by installing without a qualified installer will void your warranty.
- Carefully read the instructions accompanying the wall-hanging bracket, and be absolutely sure to take steps to prevent the TV from falling off.
- Handle the TV carefully during installation since subjecting it to impact or other forces may cause product damage.
- Do not mount the unit directly below ceiling lights (such as spotlights or halogen lights) which typically give off high heat. Doing so may warp or damage plastic cabinet parts.
- Take care when fixing wall brackets to the wall. Always ensure that there are no electrical cables or pipes in the wall before hanging bracket.
- To prevent fall and injury, remove the TV from its fixed wall position when it is no longer in use.

Information for Users on Collection and Disposal of Old Equipment and used Batteries



These symbols on the products, packaging, and/or accompanying documents mean that used electrical and electronic products and batteries should not be mixed with general household waste. For proper treatment, recovery and recycling of old products and used batteries, please take them to applicable collection points, in accordance with your national legislation and the Directives 2002/96/EC and 2006/66/EC.

By disposing of these products and batteries correctly, you will help to save valuable resources and prevent any potential negative effects on human health and the environment which could otherwise arise from inappropriate waste handling.



For more information about collection and recycling of old products and batteries, please contact your local municipality, your waste disposal service or the point of sale where you purchased the items.

Penalties may be applicable for incorrect disposal of this waste, in accordance with national legislation.

For business users in the European Union

If you wish to discard electrical and electronic equipment, please contact your dealer or supplier for further information.

[Information on Disposal in other Countries outside the European Union]

These symbols are only valid in the European Union. If you wish to discard these items, please contact your local authorities or dealer and ask for the correct method of disposal.



Cd

Note for the battery symbol (bottom two symbol examples):

This symbol might be used in combination with a chemical symbol. In this case it complies with the requirement set by the Directive for the chemical involved.

Sales and Support Information

Customer Communications Centre

- For customers within the UK: **0844 844 3899**
- For customers within Ireland: **01289 8333**
- Monday – Friday 9:00am – 5:00pm, (Excluding public holidays).
- For further support on your product, please visit our website: www.panasonic.co.uk

Direct Sales at Panasonic UK

- Order accessory and consumable items for your product with ease and confidence by phoning our Customer Communications Centre Monday – Friday 9:00am – 5:00pm, (Excluding public holidays).
- Or go on line through our Internet Accessory ordering application at www.pas-europe.com.
- Most major credit and debit cards accepted.
- All enquiries transactions and distribution facilities are provided directly by Panasonic UK.
- It couldn't be simpler!
- Also available through our Internet is direct shopping for a wide range of finished products. Take a browse on our website for further details.



Declaration of Conformity (DoC)

Authorized Representative:
Panasonic Testing Centre
Panasonic Marketing Europe GmbH
Winsbergring 15, 22525 Hamburg, Germany

Customer's Record

The model number and serial number of this product may be found on its rear panel. You should note this serial number in the space provided below and retain this book, plus your purchase receipt, as a permanent record of your purchase to aid in identification in the event of theft or loss, and for Warranty Service purposes.

Model Number

Serial Number

Panasonic UK, a branch of Panasonic Marketing Europe GmbH

Willoughby Road, Bracknell, Berkshire, RG12 8FP

Web Site: <http://panasonic.net>

M0113-1023