

# Panasonic®

Model No.  
**TX-L19E3B**

## Operating Instructions LCD Television

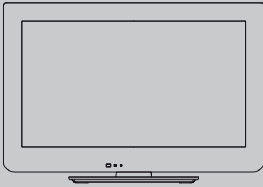

# VIERA

Thank you for purchasing this Panasonic product.  
Please read these instructions carefully before operating this product and retain them for future reference.  
The images shown in this manual are for illustrative purposes only.

English

UK and Ireland model



TQB0E2119

# Features

## **DVB-T tuner built-in**

Receives DVB (Digital Video Broadcasting) digital terrestrial broadcasts.

## **DVB-T2 tuner built-in** **UK only**

DVB-T2 is an advanced digital terrestrial system for more efficient transmission.

Available DVB-T2 broadcasts will be tuned automatically when you perform DVB Auto Setup.

## **GUIDE Plus+ (p. 18)** **UK only**

This TV supports the TV Guide services sent from the GUIDE Plus+ system.

## **Sharp pictures and clear sound with HDMI connection** (p. 72)

Enjoy high definition digital picture and high quality sound by using an HDMI cable.

- This TV supports HDMI (Version 1.4 with Audio Return Channel).

## **Timer Programming** (p. 19, 41)

Timer Programming enables you to use functions such as programme reminder and programme recording to the external recorder.

## **VIERA IMAGE VIEWER - SD Card viewer in Media Player** (p. 52)

Enjoy your photos or videos recorded on an SD Card on the TV screen.

## **SDXC Card**

This TV supports SDXC Card. SDXC is the latest standard of SD Card and a higher storage capacity card.

## **AVCHD**

It is possible to play moving pictures recorded on an SD Card in AVCHD format. AVCHD is a high definition video recording format. (p. 71)

## **Link up and control the connected equipment with “Q-Link” and “VIERA Link”** (p. 59)

Q-Link and VIERA Link provide easy recording and playback, creation of a home theatre without complicated settings, etc.

## **VIERA TOOLS - Display special feature icons for easy accessibility** (p. 26)

Special features (such as VIERA Link and Media Player) can be accessed easily by using the VIERA TOOLS button.

## **Dolby Digital Plus decoder**

It is possible to decode Dolby Digital Plus audio track (multi-channel sound) and output as a Dolby Digital multi-channel sound signal from the DIGITAL AUDIO OUT terminal.

## **Owner ID** (p. 48)

Owner ID is an anti-theft function. Entering the PIN number and owner's personal information will help the Police to determine the owner in the case of theft.

## **Supports Audio Description signal** (p. 15, 30) **UK only**

Audio Description (when broadcast) adds an additional soundtrack to describe events on screen (narration) and aids understanding and enjoyment, particularly for visually-impaired viewers.

You can switch Audio Description service Auto or Off, and adjust the volume of the description soundtrack independently of the main volume.

## **Digital Switchover for Terrestrial broadcasts** **UK only**

Starting in late 2007 and ending in 2012, TV services in the UK will go completely digital, TV region by TV region.

If you have any questions, please call Digital UK on 08456 50 50 50 or visit [www.digitaluk.co.uk](http://www.digitaluk.co.uk)

Digital Switchover will cover a period of several weeks. When it starts you will lose all Analogue TV channels and some Digital TV channels will be missing.

You will need to retune your TV each time this happens to recover your digital channels. Analogue channels are permanently turned off, it will not be possible to recover them.

- To retune your TV

➔ [Auto Setup] in [DVB Tuning Menu]-DVB mode (p. 36)

Users of cable or satellite boxes should still retune the TV to continue to receive Freeview channels via their aerial. (Your Analogue channel for viewing Cable or Satellite services will change to a new position.)

- Due to the digital reception technologies involved, quality of the digital signals may be relatively low in some cases, despite good reception of analogue channels.

This product is licensed under the AVC patent portfolio license for the personal and non-commercial use of a consumer to (i) encode video in compliance with the AVC Standard ("AVC Video") and/or (ii) decode AVC Video that was encoded by a consumer engaged in a personal and non-commercial activity and/or was obtained from a video provider licensed to provide AVC Video. No license is granted or shall be implied for any other use. Additional information may be obtained from MPEG LA, LLC. See <http://www.mpegla.com>.

ROVI CORPORATION AND/OR ITS RELATED AFFILIATES ARE NOT IN ANY WAY LIABLE FOR THE ACCURACY OF THE PROGRAM SCHEDULE INFORMATION PROVIDED BY THE GUIDE PLUS+ SYSTEM. IN NO EVENT SHALL ROVI CORPORATION AND/OR ITS RELATED AFFILIATES BE LIABLE FOR ANY AMOUNTS REPRESENTING LOSS OF PROFITS, LOSS OF BUSINESS, OR INDIRECT, SPECIAL, OR CONSEQUENTIAL DAMAGES IN CONNECTION WITH THE PROVISION OR USE OF ANY INFORMATION, EQUIPMENT, OR SERVICES RELATING TO THE GUIDE PLUS+ SYSTEM.  
<http://www.europe.guideplus.com/>

### Notice for DVB functions

The compatibility with future services is not guaranteed. Check the latest information on the available services at the following website.

<http://panasonic.jp/support/global/cs/tv/>

# Contents

## Be Sure to Read

Safety Precautions.....	4
-------------------------	---

## Quick Start Guide

Accessories / Options.....	6
Identifying Controls.....	8
Basic Connection.....	10
Auto Setup.....	12

## Enjoy your TV!

### Basic Features

Watching TV.....	14
Using TV Guide.....	18
Viewing Teletext.....	21
Watching External Inputs.....	24
How to Use VIERA TOOLS.....	26
How to Use Menu Functions.....	27

### Advanced Features

Retuning from Setup Menu.....	36
Tuning and Editing Channels.....	37
Timer Programming.....	41
Child Lock.....	43
Input Labels.....	44
Setup for Internet Connection.....	45
Shipping Condition.....	47
Owner ID.....	48
Using Common Interface.....	49
Updating the TV Software.....	50
Displaying PC on screen.....	51
Using Media Player.....	52
Link Functions (Q-Link / VIERA Link).....	59
External Equipment.....	67

### FAQs, etc.

Technical Information.....	70
FAQs.....	75
On screen messages.....	77
Glossary.....	79
Maintenance.....	80
Licence.....	80
Index.....	81
Specifications.....	82

# Safety Precautions

## Warning

### Mains plug and lead

To help avoid risk of electrical shock, fire, damage or injury, please follow the warnings below:

- This TV is designed to operate on AC 220-240 V, 50 Hz.
- Insert the mains plug fully into the socket outlet.
- Ensure that the mains plug is easily accessible.
- Remove the mains plug when cleaning the TV.

- Do not touch the mains plug with a wet hand.



- Do not damage the mains lead.
  - Do not place a heavy object on the lead.



- Do not place the lead near a high temperature object.

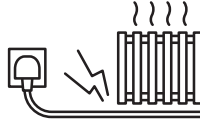

- Do not pull on the lead. Hold onto the mains plug body when disconnecting the plug.

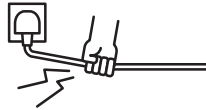

- Do not move the TV with the lead plugged into a socket outlet.
- Do not twist the lead, bend it excessively or stretch it.
- Do not use a damaged mains plug or socket outlet.
- Ensure the TV does not crush the mains lead.



If you detect anything unusual, immediately switch off the mains supply switch and remove the mains plug.



## IMPORTANT: THE MOULDED MAINS PLUG

FOR YOUR SAFETY, PLEASE READ THE FOLLOWING TEXT CAREFULLY.

This TV is supplied with a moulded three pin mains plug for your safety and convenience. A 5 amp fuse is fitted in this mains plug. Shall the fuse need to be replaced, please ensure that the replacement fuse has a rating of 5 amps and that it is approved by ASTA or BSI to BS1362.

Check for the ASTA mark  or the BSI mark  on the body of the fuse.

If the mains plug contains a removable fuse cover, you must ensure that it is refitted when the fuse is replaced.

If you lose the fuse cover the mains plug must not be used until a replacement cover is obtained.

A replacement fuse cover may be purchased from your local dealer.

**If the fitted moulded mains plug is unsuitable for the socket outlet in your home, then the fuse shall be removed and the mains plug cut off and disposed of safely. There is a danger of severe electrical shock if the cut off mains plug is inserted into any 13 amp socket.**

If a new mains plug is to be fitted, please observe the wiring code as shown below.

If in any doubt, please consult a qualified electrician.

**IMPORTANT:** – The wires in this mains lead are coloured in accordance with the following code: –Blue: Neutral Brown: Live  
As the colours of the wire in the mains lead of this appliance may not correspond with the coloured markings identifying the terminals in your mains plug, proceed as follows.

The wire which is coloured BLUE must be connected to the terminal in the mains plug which is marked with the letter N or coloured BLACK.

The wire which is coloured BROWN must be connected to the terminal in the mains plug which is marked with the letter L or coloured RED.

Under no circumstances should either of these wires be connected to the Earth terminal of the three pin mains plug, marked with the letter E or the earth symbol .

How to replace the fuse

**For plug type shown in example 1:**

Lift out the removable fuse compartment with a screwdriver and replace the fuse, then refit securely into the mains plug (see example 1).

**For plug type shown in example 2:**

Lift open the fuse compartment, in the mains plug, with a screwdriver, and replace the fuse, then press the fuse cover down securely (see example 2).

Example 1

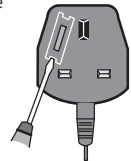

Example 2

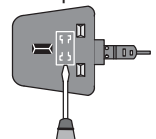

## Warning

### Take care

To help avoid risk of electrical shock, fire, damage or injury, please follow the warnings below:

- Do not remove covers and never modify the TV yourself as live parts are accessible when they are removed. There are no user serviceable parts inside.



- Do not expose the TV to rain or excessive moisture. This TV must not be exposed to dripping or splashing water and objects filled with liquid, such as vases, must not be placed on top of or above the TV.



- Do not expose the TV to direct sunlight and other sources of heat. To prevent fire never place any type of candle or naked flame on top or near the TV.

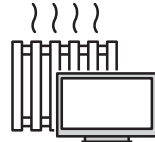

- Do not place the TV on sloped or unstable surfaces.



- Do not insert foreign objects into the TV through the air vents.
- Do not use an unapproved pedestal / mounting equipment. Be sure to ask your local Panasonic dealer to perform the setup or installation of approved wall-hanging brackets.
- Do not apply strong force or impact to the display panel.

## To prevent the spread of fire, keep candles or other open flames away from this product at all times



### Small object

This product contains possibly dangerous parts that can be breathed in or swallowed by young children accidentally.

- Keep the dangerous parts out of reach of young children.
- Do not allow children to handle SD Card. As with any small object, the SD Card could be swallowed by young children. Please remove SD Card immediately after use and store out of reach of young children.



## Caution

### Ventilation

Allow sufficient space around the TV in order to help prevent excessive heat, which could lead to early failure of some electronic components.

- Ventilation should not be impeded by covering the ventilation openings with items such as newspapers, tablecloths and curtains.

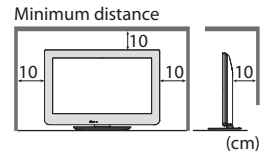
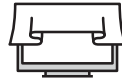

- Whether you are using the pedestal or not, always ensure the vents in the bottom of the TV are not blocked and there is sufficient space to enable adequate ventilation.

### Moving the TV

Before moving the TV, disconnect all cables.

- Transport only in upright position.

### When not in use for a long time

This TV will still consume some power even in the Off mode, as long as the mains plug is still connected to a live socket outlet.

- Remove the mains plug from the wall socket when the TV is not in use for a prolonged period of time.

### Excessive volume

Do not expose your ears to excessive volume from the headphones. Irreversible damage can be caused.



# Accessories / Options

## Standard accessories

### Remote Control

- N2QAYB000487



### Batteries for the Remote Control (2)

- R6
- ➔ (see below)



### Pedestal

- TBL0E0136
- ➔ (p. 7)



### Assembly screw for Pedestal (3)

- XYN4+F12FJK



M4 × 12

### Operating Instructions

- Accessories may not be placed all together. Take care not to throw them away unintentionally.

### Product Registration Leaflet

## Optional accessories

Please contact your nearest Panasonic dealer to purchase the recommended optional accessories. For additional details, please refer to the manual of the optional accessories.

### Wall-hanging bracket

- TY-WK23LR2W

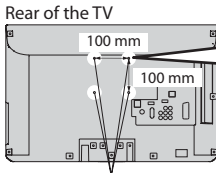

Holes for wall-hanging bracket installation

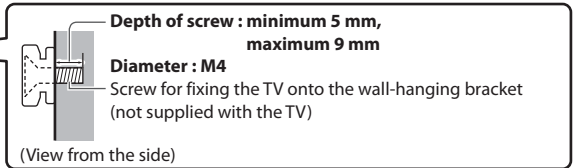

### Warning

- Using other wall-hanging brackets, or installing a wall-hanging bracket by yourself has the risk of personal injury and product damage. In order to maintain the unit's performance and safety, be sure to ask your dealer or a licensed contractor to secure the wall-hanging brackets. Any damage caused by installing without a qualified installer will void your warranty.
- Carefully read the instructions accompanying optional accessories, and be sure to take steps to prevent the TV from falling off.
- Handle the TV carefully during installation since subjecting it to impact or other forces may cause product damage which will void your warranty.
- Do not mount the unit directly below ceiling lights (such as spotlights or halogen lights) which typically give off high heat. Doing so may warp or damage plastic cabinet parts.
- Take care when fixing wall brackets to the wall. Wall mounted equipment must not be grounded by metal within the wall. Always ensure that there are no electrical cables or pipes in the wall before hanging bracket.
- To prevent fall and injury, remove the TV from its fixed wall position when it is no longer in use for an extended period of time.

## Installing / removing remote's batteries

1

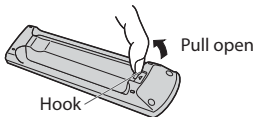

2

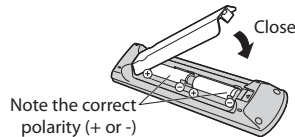

### Caution

- Incorrect installation may cause battery leakage and corrosion, resulting in damage to the remote control.
- Do not mix old and new batteries.
- Replace only with same or equivalent type. Do not mix different battery types (such as alkaline and manganese batteries).
- Do not use rechargeable (Ni-Cd) batteries.
- Do not burn or break up batteries.  
Batteries must not be exposed to excessive heat such as sunshine, fire, etc.
- Make sure you dispose of batteries correctly.
- Ensure batteries are replaced correctly, there is danger of explosion and fire if battery is reversed.
- Do not disassemble or modify the remote control.

## Attaching the pedestal

To help avoid risk of damage or injury by the TV tipping or falling, please follow the warnings and cautions below:

### Warning

- Do not disassemble or modify the pedestal.

### Caution

- Do not use any pedestal other than the one provided with this TV.
- Do not use the pedestal if it becomes warped or physically damaged. If this occurs, contact your nearest Panasonic dealer immediately.
- During setup, make sure that all screws are securely tightened.
- Ensure that the TV does not suffer any impact during installation of the pedestal.
- Ensure that children do not climb onto the pedestal.
- Install or remove the TV from the pedestal with at least two people.

### Securing the TV

Use only the supplied assembly screws to fasten the pedestal securely to the TV.

- Tighten the three assembly screws loosely at first, then tighten them firmly to fix securely.
- Carry out the work on a horizontal and level surface.

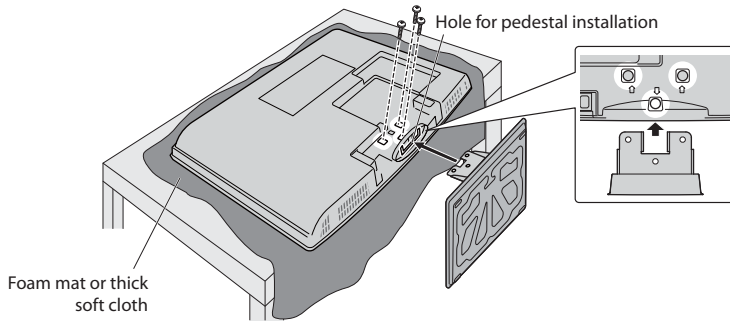

# Identifying Controls

## Remote Control

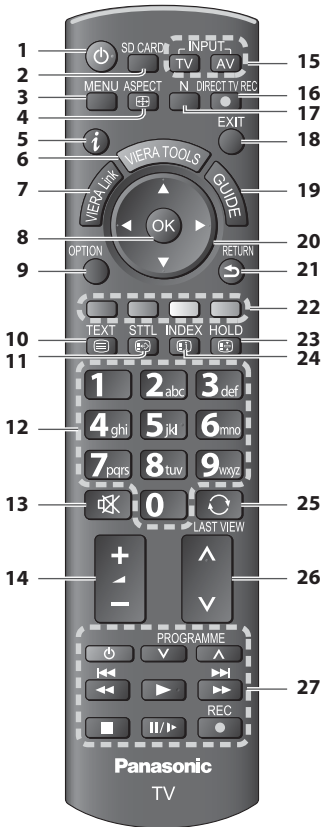

- 1 Standby On / Off switch**
  - Switches TV On or Off standby
- 2 [Media Player] ➔ (p. 52)**
  - Switches to SD Card viewing / listening mode
- 3 [Main Menu] ➔ (p. 27)**
  - Press to access Picture, Sound and Setup Menus
- 4 Aspect ➔ (p. 17)**
  - Changes aspect ratio
- 5 Information ➔ (p. 15)**
  - Displays channel and programme information
- 6 VIERA TOOLS ➔ (p. 26)**
  - Displays some special feature icons and accesses easily
- 7 [VIERA Link Menu] ➔ (p. 63)**
- 8 OK**
  - Confirms selections and choices
  - Press after selecting channel positions to quickly change channel
  - Displays the Channel List
- 9 [Option Menu] ➔ (p. 16)**
  - Easy optional setting for viewing, sound, etc.
- 10 Teletext ➔ (p. 21)**
  - Switches to teletext mode
- 11 Subtitles ➔ (p. 17)**
  - Displays subtitles
- 12 Numeric buttons**
  - Changes channel and teletext pages
  - Sets characters
  - When in Standby mode, switches TV On (Press for about 1 second)
- 13 Sound Mute**
  - Switches sound mute On or Off
- 14 Volume Up / Down**
- 15 Input mode selection**
  - TV - switches between DVB and Analogue modes ➔ (p. 14)
  - AV - switches to AV input mode from Input Selection list ➔ (p. 24)
- 16 Direct TV Recording ➔ (p. 61, 63)**
  - Records programme immediately in DVD Recorder / VCR with Q-Link or VIERA Link connection
- 17 Normalise ➔ (p. 27)**
  - Resets picture and sound settings to their default levels
- 18 Exit**
  - Returns to the normal viewing screen
- 19 TV Guide ➔ (p. 18)**
- 20 Cursor buttons**
  - Makes selections and adjustments
- 21 Return**
  - Returns to the previous menu / page
- 22 Coloured buttons (red-green-yellow-blue)**
  - Used for the selection, navigation and operation of various functions
- 23 Hold**
  - Freeze / unfreeze picture ➔ (p. 16)
  - Holds the current teletext page (teletext mode) ➔ (p. 22)
- 24 Index ➔ (p. 23)**
  - Returns to the teletext index page (teletext mode)
- 25 Last view ➔ (p. 15)**
  - Switches to previously viewed channel or input mode
- 26 Channel Up / Down**
- 27 Connected equipment operations ➔ (p. 25, 55, 65)**



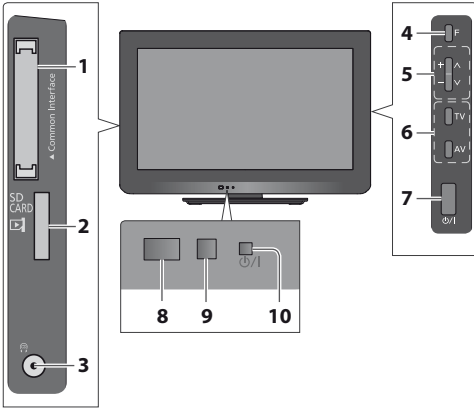

- 1 CI slot ➔ (p. 49)
- 2 SD Card slot ➔ (p. 52)
- 3 Headphones jack ➔ (p. 69)
- 4 Function select
  - [Volume] / [Contrast] / [Brightness] / [Colour] / [Sharpness] / [Tint] (NTSC signal) / [Bass]\* / [Treble]\* / [Balance] / [Auto Setup] (p. 36)
  - \*[Music] or [Speech] mode in the Sound Menu

- 5 Channel Up / Down, Value change (when using the F button), Switching the TV On (press either button for about 1 second when in Standby mode)
- 6 Changes the input mode
- 7 Mains power On / Off switch
  - Use to switch the mains power.
  - If you turned the TV Off during Standby mode by the remote control last time, the TV will be in Standby mode when you turn the TV On with Mains power On / Off switch.
- 8 Remote control signal receiver
  - Do not place any objects between the TV remote control signal receiver and remote control.
- 9 C.A.T.S. (Contrast Automatic Tracking System) sensor
  - Senses brightness to adjust picture quality when [Eco Mode] in the Picture Menu is set to [On] ➔ (p. 28)
- 10 Power and Timer LED
  - Red : Standby
  - Green : On
  - Orange : Timer Programming On
  - Orange (flash) : Recording of Timer Programming or Direct TV Recording in progress
  - Red with orange flash : Standby with Timer Programming On or Direct TV Recording
  - The LED blinks when the TV receives a command from the remote control.

## Using the On Screen Displays - Operation guide

Many features available on this TV can be accessed via the On Screen Display menu.

### Operation guide





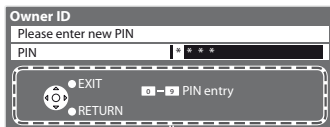

Operation guide will help you to operate by using the remote control.

Example : [Owner ID]



Operation guide

### How to use remote control

-  Open the main menu
-  Move the cursor / select the menu item
-  Move the cursor / adjust levels / select from a range of options
-  Access the menu / store settings after adjustments have been made or options have been set
-  Return to the previous menu
-  Exit the menu system and return to the normal viewing screen

## Auto power standby function

The TV will automatically go to Standby mode in the following conditions:

- no signal is received and no operation is performed for 30 minutes in Analogue TV mode
- [OffTimer] is active in the Setup Menu (p. 16)
- no operation is performed for the period selected in [Auto Standby] (p. 32)
- This function does not affect the recording of Timer Programming and Direct TV Recording.

# Basic Connection

External equipment and cables shown are not supplied with this TV.

Please ensure that the unit is disconnected from the mains socket before attaching or disconnecting any leads.

## Example 1 Connecting aerial

### TV only

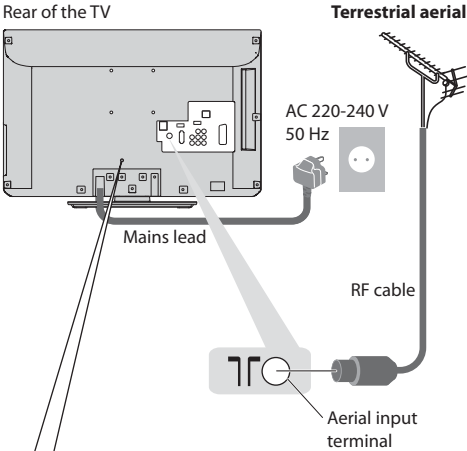

#### How to use the clammer bundling the mains lead

##### To loosen :

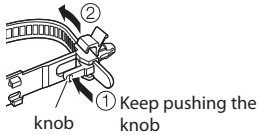

##### Bundle the cables



##### To remove from the TV:

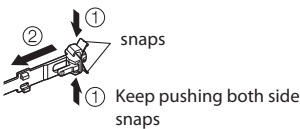

- Do not bundle the RF cable and mains lead together (could cause distorted image).
- Fix cables with clammers as necessary.
- When using the optional accessory, follow the option's assembly manual to fix cables.

#### Note

- Connect to the TV's AV1 for a DVD Recorder / VCR supporting Q-Link (p. 61).
- For HDMI-compatible equipment, it is possible to connect to HDMI terminals (HDMI1 / HDMI2) by using HDMI cable (p. 68).
- Q-Link and VIERA Link connection ➔ (p. 59, 60)
- Please also read the manual of the equipment being connected.

## Example 2 Connecting DVD Recorder / VCR

### TV, DVD Recorder or VCR

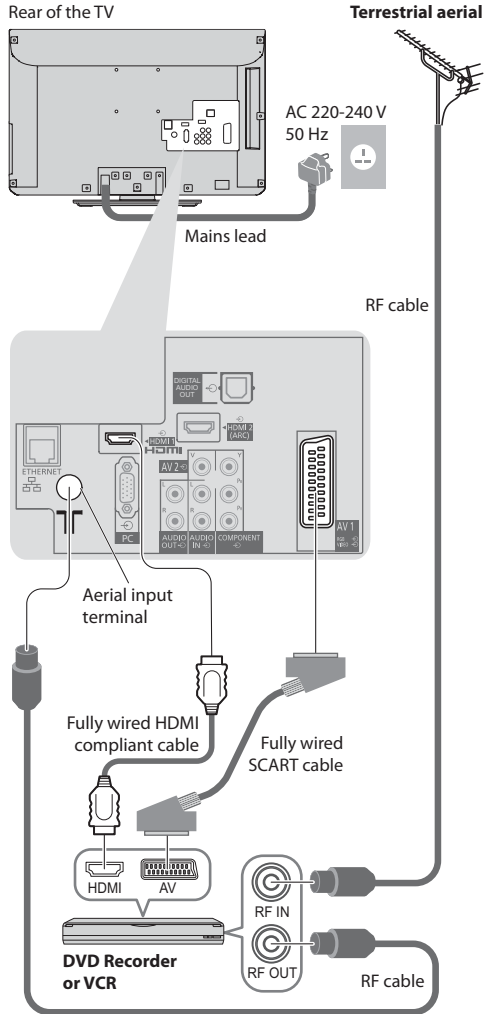

### Example 3

## Connecting DVD Recorder / VCR and Satellite Receiver

### TV, DVD Recorder / VCR and Satellite

Rear of the TV

Terrestrial aerial

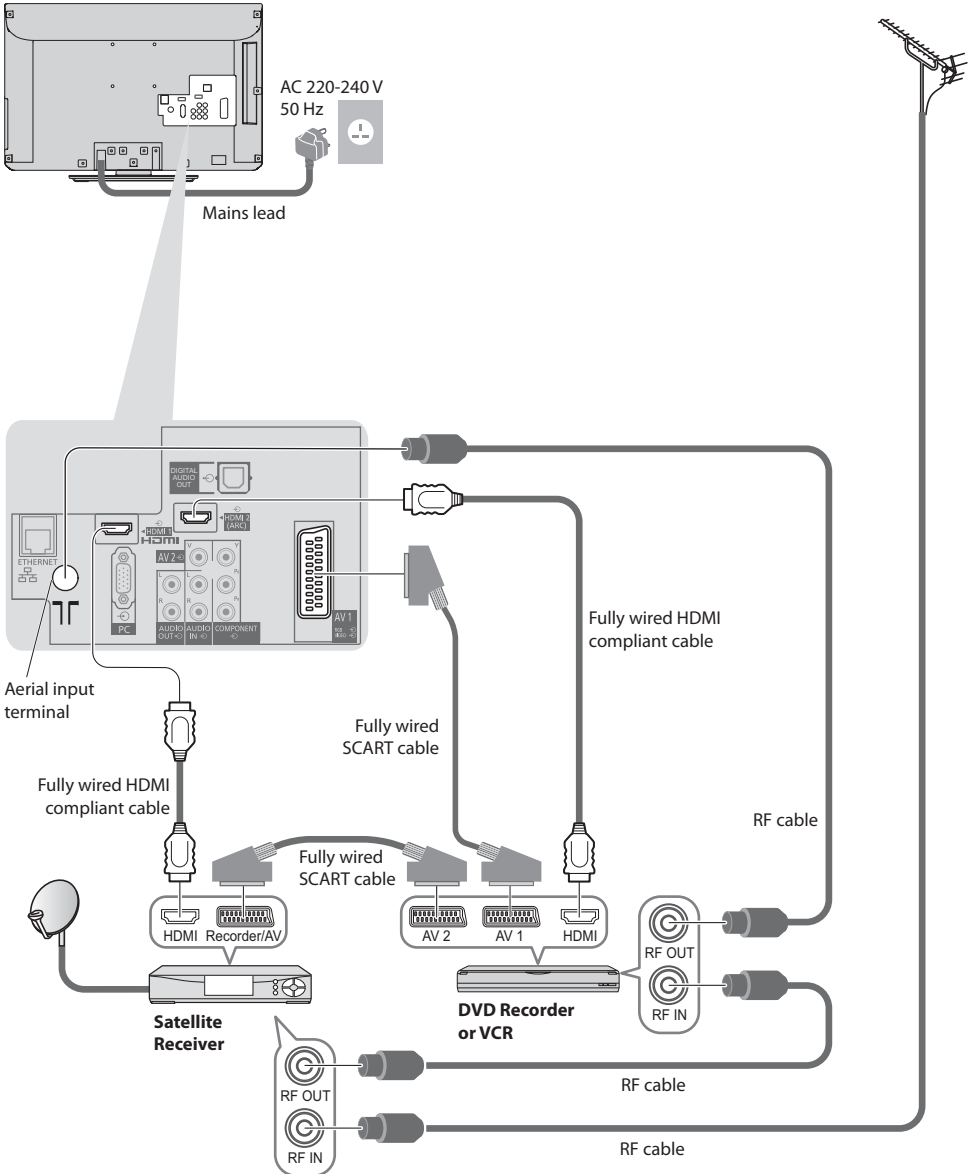

# Auto Setup

Search and store TV channels automatically.

- These steps are not necessary if the setup has been completed by your local dealer.
- Please complete connections (p. 10, 11) and settings (if necessary) of the connected equipment before starting Auto Setup. For details of settings for the connected equipment, read the appropriate manual.



1

## Plug the TV into mains socket and switch On

- Takes a few seconds to be displayed.
- If the red LED shows on the TV, press the Standby On / Off switch on the remote control for at least 1 second to turn the TV On.



2

## Select your country



Example : **UK**

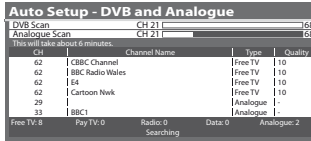

Auto Setup will start to search for TV channels and store them in the numbered order as specified by the broadcasters.

- Actual number of channels may differ due to channel duplication.

Example : **Ireland**

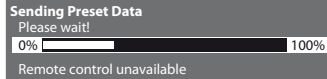
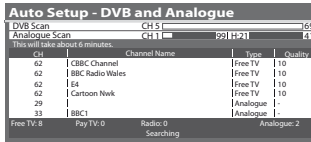

If Q-Link or similar technology (p. 60) compatible recorder with analogue tuner is connected, analogue channel setting is automatically downloaded to the recorder. (Digital channel setting is not downloaded.)

- If downloading has failed, you can download later through the Setup Menu. ➔ **"Q-Link Download"** (p. 30)

3

## Input Owner ID



Please enter your own choice of PIN number, name, etc. to help the police to crack crime.

- Make a note of the PIN number in case you forget it. The PIN number cannot be reset.
- You can input or change the Owner ID later. ➔ **[Owner ID]** (p. 48)
- To skip this step

EXIT



- This step will be skipped in the Auto Setup after [Shipping Condition] (p. 47) is performed.

## 3

### How to input Owner ID

#### 1 Enter the PIN number (4 digits)



- Enter the PIN number twice at first setting.

#### 2 Select the item (NAME / HOUSE NO / POSTCODE)



#### 3 Enter your name, house number and postcode

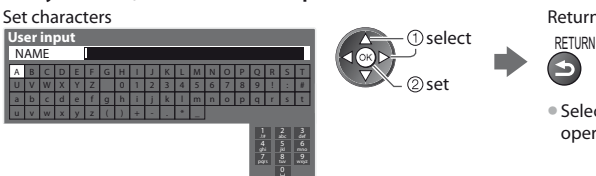

Return to select other items



- Select the next item and repeat the operations.

- You can set characters by using numeric buttons.  
 ➔ **“Characters table for numeric buttons” (p. 72)**

#### 4 Exit to go to next step



## 4

### Select [Home]

Select [Home] viewing environment (highlight [Home] in yellow) to use in your home environment.



#### ■ [Shop] viewing environment (for shop display only)

[Shop] viewing environment is the demonstration mode to explain main features of this TV.

#### Select [Home] viewing environment to use in your home environment.

- You can return to viewing environment selection screen at the stage of Shop confirmation screen and Automatic Demo Off / On selection screen.

#### 1 Return to viewing environment selection screen

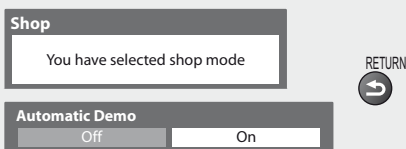

#### 2 Select [Home]

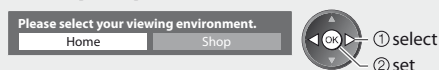

- To change viewing environment later on, you will need to initialise all settings by accessing Shipping Condition.  
 ➔ **[Shipping Condition] (p. 47)**

### Auto Setup is now complete and your TV is ready for viewing.

If tuning has failed, check the connection of the RF cable, and then, follow the on screen instructions.

- To check channel list at-a-glance ➔ **“Using TV Guide” (p. 18)**
- To edit or hide (skip) channels ➔ **“Tuning and Editing Channels” (p. 37 - 40)**
- To retune all channels ➔ **[Auto Setup] (p. 36)**
- To initialise all settings ➔ **[Shipping Condition] (p. 47)**

# Watching TV



Watching TV

Volume

## 1 Turn power on



- Press for about 1 second
- Mains power On / Off switch should be On. (p. 9)

## 2 Select DVB or Analogue



- Also possible to select the mode pressing the TV button on the side panel of the TV. (p. 9)

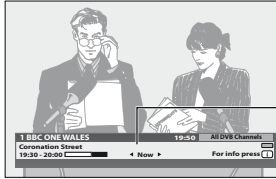

Information banner → (p. 15)

## 3 Select a channel

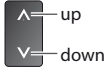

or



DVB channel position numbers run from 1 onwards.

Analogue channel position numbers run in the ranges 0 - 99.

- To select a two or three-digit channel position number, e.g. 399

**3** def → **9** num → **9** num

### ■ Select a channel using Information banner (p. 15)

It is possible to confirm the channel name and programme information by using the Information banner before changing channels.

#### 1 Display Information banner if it is not displayed



#### 2 While the banner is displayed, select the channel

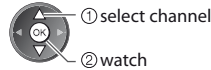

### ■ Select a channel using TV Guide (p. 18)

It is possible to confirm the channel and programme information by using the TV Guide (EPG) before changing channels.

#### 1 Display TV Guide



#### 2 Select a current programme or channel

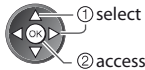

#### 3 Select [View] (DVB mode)

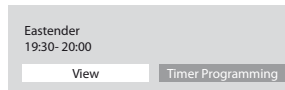

### Note

- To watch pay-TV → "Using Common Interface" (p. 49)

## Other useful functions

### Display Information banner

#### Display Information banner

- Also appears when changing a channel

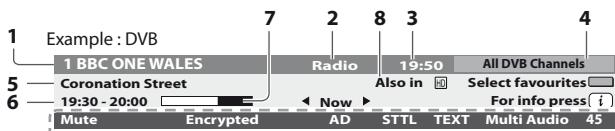

- 1 Channel position and name
- 2 Channel type ([Radio], [Data], [HDTV], etc.)
- 3 Current time
- 4 [All DVB Channels] or [Favourites1-4] (p. 38) (DVB)
  - To switch
- 5 Programme
- 6 Programme Start / Finish time (DVB)  
Channel number, etc. (Analogue)
- 7 Progress time indicator of the selected programme (DVB)
- 8 Same programme available as HD broadcast

**UK only**

- To display the extra information for details



#### Features available / Message meanings

<p><b>[Mute]</b> Sound mute On</p>	<p><b>[AD] UK only</b> Audio Description service available</p> <ul style="list-style-type: none"> <li>• This function can aid visually-impaired viewers by adding an additional audio track to describe events on screen.</li> <li>• For settings ➔ (p. 30)</li> </ul>	<p><b>[TEXT]</b> Teletext service available</p>
<p><b>[Bad signal]</b> Poor TV signal quality</p>	<p><b>[STTL]</b> Subtitle service available</p>	<p><b>[Multi Audio]</b> Multiple audio available</p>
<p><b>[Encrypted]</b> Scrambled programme</p>		<p><b>[Stereo], [Mono], [NICAM]</b> Audio mode</p>
		<p><b>1 - 90</b> Off Timer remaining time</p> <ul style="list-style-type: none"> <li>• For settings ➔ (p. 16)</li> </ul>

- To confirm another tuned channel name
- To watch the channel listed in the banner
- Information on the next programme (DVB)



- To hide



- Extra information (DVB)



(Press again to hide the banner)

- To set display timeout

➔ **[Banner Display Timeout] (p. 31)**

- [AD], [STTL], [TEXT], [Multi Audio] indications are displayed as available on particular programmes, but may not be available for all individual programmes being broadcast. Display the extra information to confirm availability of these functions.

Example :



### Last view

#### Switch to previously viewed channel or input mode easily



LAST VIEW

- Press again to return to the present view.

#### Note

- Switching channel is not available while the recording of Timer Programming or Direct TV Recording is in progress.
- Watching less than 10 seconds is not regarded as the previously viewed channel or input mode.

## Hold

### Freeze / unfreeze picture

HOLD



## Display the selectable settings for the current status

### Check or change the current status instantly

OPTION

- To change



① select

② change

#### [Audio Description] **UK only**

(DVB mode)

Set to [Auto] if the programme has Audio Description service, then you will hear an additional audio track to describe events on screen

- To adjust the volume for Audio Description

➔ **[Audio Description Menu] (p. 30)**

#### [Multi Audio]

(DVB mode)

Allows you to select between alternative language for sound tracks (if available)

- This setting is not memorized and it will return to the default setting once you exit the current programme.

#### [Monaural Audio]

(DVB mode)

Allows you to select stereo / monaural (if available)

- This setting is not memorized and it will return to the default setting once you exit the current programme.

#### [Subtitle Language]

(DVB mode)

Allows you to select the language in which subtitles should appear (if available)

- This setting is not memorized and it will return to the default setting once you exit the current programme.

#### [Teletext Character Set] **Ireland only**

Sets the teletext language font

➔ **[Setup Menu] (p. 31)**

#### [Teletext Language] **Ireland only**

(DVB mode)

Allows you to select between alternative language for teletext (if available)

#### [NICAM]

(Analogue mode)

Switches NICAM sound (if available)

➔ **[Sound Menu] (p. 29)**

#### [Volume Correction]

Adjusts volume of individual channel or input mode

## Off Timer

Turn the TV off automatically after a fixed period (Off / 15 / 30 / 45 / 60 / 75 / 90 minutes)

### 1 Display the menu

MENU



### 2 Select [Setup]

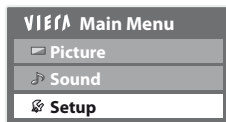

① select

② access

### 3 Select [Off Timer] and set the time

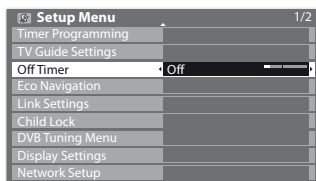

① select

② set

- To cancel ➔ Set to [Off] or turn the TV off.
- To display the remaining time ➔ **"Display Information banner" (p. 15)**
- When the remaining time is within 3 minutes, the remaining time will flash on the screen.



## Aspect

### Change the aspect ratio (image size)

**ASPECT** Enjoy viewing the image at its optimum size and aspect. Programmes usually contain an "Aspect Control Signal" (Widescreen signal, etc.), and the TV will choose the aspect ratio automatically according to the "Aspect Control Signal" (p. 70).

### ■ If you would like to change the aspect ratio manually

#### 1 Display Aspect Selection list

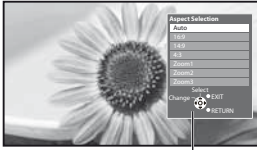

Aspect Selection list

#### 2 While the list is displayed, select the mode



- You can also change the mode only using the ASPECT button.



(Press repeatedly until you reach the desired mode)

#### [Auto]



The best ratio is chosen and the image expanded to fill the screen. For details ➔ (p. 70)

#### [16:9]



Directly displays the image at 16:9 without distortion (anamorphic).

#### [14:9]



Displays the image at the standard 14:9 without distortion.

#### [4:3]



Displays the image at the standard 4:3 without distortion.

#### [Zoom1]



Displays a 16:9 letterbox or 4:3 image without distortion.

#### [Zoom2]

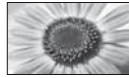

Displays a 16:9 letterbox (anamorphic) image full-screen without distortion.

#### [Zoom3]

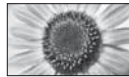

Displays a 2.35:1 letterbox (anamorphic) image full-screen without distortion. At 16:9, displays the image at its maximum (with slight enlargement).

### Note

- Only "16:9" and "4:3" are available in PC input mode.
- Aspect is fixed to [16:9] when [Viewing Mode] is set to [Game] in the Picture Menu.
- Not available in teletext service.
- Aspect mode can be memorized separately for SD (Standard definition) and HD (High definition) signals.

## Display subtitles

### ■ DVB mode

Display / hide subtitles (if available)



- To change the language for DVB (if available) ➔ [Preferred Subtitles] (p. 31)

### ■ Analogue mode

Display subtitles



Hide subtitles



### Note

- This is the same as switching to Analogue teletext service and selecting "P888" (subtitle service). (p. 23)
- You cannot change the channel when this function is active.

# Using TV Guide

TV Guide—Electronic Programme Guide (EPG) provides an on screen listing of the programmes currently broadcast and the forthcoming broadcasts over the next seven days (depending on the broadcasters).

- This TV supports the GUIDE Plus+ system. **UK only**
- The Rovi branding partner will supply the rating information in the programme information and the recommended group in the Search list. **UK only**
- DVB and Analogue channels are displayed on the same TV Guide screen. [D] means DVB channel and [A] means Analogue channel. There will be no programme listings for Analogue channels.
- When this TV is turned on for the first time, or the TV is switched off for more than a week, it may take some time before TV Guide is completely shown.

Using TV Guide



## 1 Select DVB or Analogue



## 2 View TV Guide

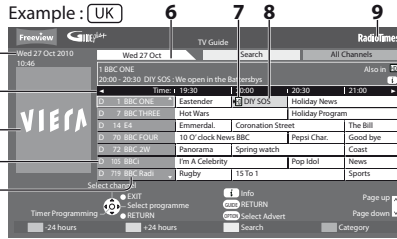

- 1 Current date and time
- 2 TV Guide time
- 3 Advertisement
- 4 [D] : DVB
- 5 [A] : Analogue
- 6 Channel position and name
- 7 TV Guide date

### ■ To return to TV



### 7 Some programmes may also be broadcast in HD **UK only**

- You can select HD or SD broadcast before viewing or setting Timer Programming.

### 8 Programme

### 9 Logo of the Rovi branding partner **UK only**

### ■ To change the layout of TV Guide → [TV Guide View] (p. 30)

### ■ To watch the programme

#### 1 Select a current programme or channel



#### 2 Select [View] (DVB mode)



- If a programme exists in both HD and SD broadcasts, the [View Options] screen will be displayed to select HD or SD broadcast. (DVB mode) **UK only**



- To use Timer Programming → (p. 19)



### ■ To the previous day (DVB mode)



### ■ To the next day (DVB mode)



### ■ View details of the programme (DVB mode)

#### 1 Select the programme



#### 2 View details

- Press again to return to TV Guide.

### ■ To view a channel list of the selected category



(Category list)

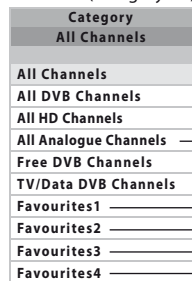

Only Analogue channels are listed

- To list favourite channels → (p. 38)

■ To search programme types and view a channel list of the searched programmes (DVB mode)

(yellow)

**UK** (Search list)

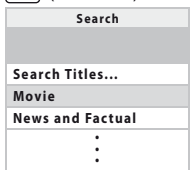

**Ireland** (Type list)

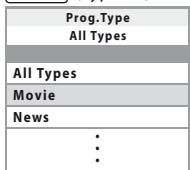

■ To search programme titles and view a list of the searched programmes (DVB mode) **UK only**

(yellow)



**1 Select [Search Titles...]**

**2 Set characters (maximum: 19 characters)**

① select  
② set

- To use numeric buttons
- ➔ "Characters table for numeric buttons" (p. 72)

**3 Start [Search]**

(green)

- All the programme titles including the word you set will be listed.
- Searching without any characters will list all programmes including current programmes.

Other useful functions

Timer Programming (DVB mode)

Timer Programming can remind you to watch a programme or record one on an external recorder.

**1 Select the forthcoming programme**



**2 Select the function ([Ext Rec.] or [Reminder])**



(Timer Programming screen)

Function	No.	Channel Name	Date	Start	End
[Ext Rec.]	1	BBC ONE DIY SOS	Wed 27 Oct	19:30	20:00 (30 min.)
---	---	---	---	---	---
---	---	---	---	---	---

LED will turn to orange if Timer Programming is set.  
(Orange LED will flash if the recording of Timer Programming is in progress.)

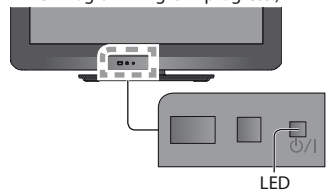

**[Ext Rec.]**

to record the programme to the external recorder [Ext Rec.]  
When the start time comes, the channel will be switched automatically and the video and audio signals will be output. 2 minutes before the starting time, a reminder message appears if you are watching TV.

**[Reminder]**

to remind you to watch the programme  
When you are watching TV, a reminder message appears 2 minutes before the start time. Press the OK button to switch to the programmed channel.

■ To check / change / cancel a timer programming event

➔ "Timer Programming" (p. 41)

■ To return to TV Guide



■ If you select a current programme

A confirmation screen asking whether you wish to watch or record the programme will appear. Select [Timer Programming] and set [Ext Rec.] to record from the time you finish programming the timer event setting.

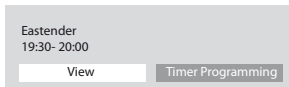

■ If a programme exists in both HD and SD broadcasts

**UK only**

The [Timer Options] screen will be displayed to select HD or SD broadcast.

Timer Options

DIY SOS				
101	BBC ONE	19:30-20:00	Wed 27 Oct 2010	30 min.
119	BBC HD	19:30-20:00	Wed 27 Oct 2010	30 min.



(Timer Programming screen)

Function	No.	Channel Name	Date	Start	End
[Ext Rec.]	1	BBC ONE DIY SOS	Wed 27 Oct	19:30	20:00 (30 min.)
---	---	---	---	---	---
---	---	---	---	---	---

will be displayed if HD broadcast is set.

**Note**

- This function is not available in Analogue mode.
- Timer Programming reminder messages will remain displayed until one of the following occurs:
  - You press the OK button to view the programme or the EXIT button to cancel the reminder.
  - The timer programming event that the reminder is set for ends.
- No other channel can be selected while the recording of Timer Programming is in progress.
- When recording programmes, be sure to make the proper settings on the recorder connected to the TV. ➔ (p. 41)

**Guide link programming (Timer Programming from the TV Guide signal)**

Guide link programming is Timer Programming which is controlled by information from the TV Guide; if programme start and end times are changed by the broadcaster, the timer programming event will follow the change. A Split Programme programming is a Guide link programming which is interrupted by one or more other programmes. Note that Guide link programming (including Split Programme programming) only works reliably if correct information is received from broadcasters.

(Timer Programming screen)

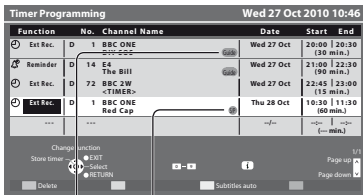

“S/P” is displayed if the timer is set from the TV Guide and the programme is a Split Programme

“Guide” is displayed if the timer is set from the TV Guide (Guide link programming)

Example: UK

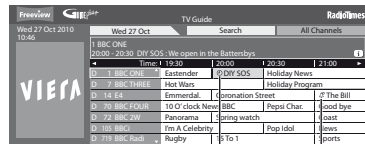

“☺” or “☹” will be displayed in the TV Guide if Timer Programming is set as the Guide link programming.

**Note**

- If you edit the start time or end time of a Guide link programming event by more than 10 minutes, it will no longer follow the broadcaster's changes to the start or end time. The start and end times will become fixed.
- Whilst making the Split Programme programming event for [Ext Rec.], you cannot record any channels between the interrupted programmes.
- The Split Programme programming event for Reminder will be cleared by pressing the OK button once to view.
- The Split Programme programming event for Reminder will switch to the programmed channel by pressing the OK button even if it is between the interrupted programmes.
- The Split Programme programming does not work if the separated parts are broadcast on different channels.

**View advertisement (UK only)**

Enter your postcode when using this function for the first time

➔ [Guide Plus+ Postcode] in [TV Guide Settings] (p. 30)

If you have already entered your postcode in “Auto Setup” - when first using the TV (p. 12, 13), you do not have to enter it again. If you enter an incorrect postcode for your area, or no postcode is entered, advertisements may not be displayed correctly.

**Display advertisement information**

OPTION



- To display the latest advertisement, you will need to update the information. To update the information continuously, the TV must be left in Standby mode.

**To change advertisements**



**To return to TV Guide**



**Note**

- Some advertisements are for future programmes. In this case it is possible to use the Guide link programming function.
- The advertisements displayed on the TV Guide are sent from the GUIDE Plus+ system so that they cannot be deleted manually or will not be lost even when the TV is turned Off with Mains power On / Off switch.

# Viewing Teletext

You can enjoy news, weather forecasts and subtitles, etc. (depending on the broadcaster)

- The availability of teletext services for a programme is indicated by [TEXT] in the information banner.



Information banner → (p. 15)

Displayed if programme has teletext service

## Ireland

Depending on the broadcaster, the digital teletext (MHEG) services may not be available. In this case, the operation of the teletext services may be the same as the analogue teletext services (p. 22).

## Digital teletext (MHEG)

Digital teletext services differ greatly from analogue teletext.

When you switch to a digital teletext service, the images you see can contain graphics and text, laid out and controlled in a manner decided by the broadcaster.



### 1 Select DVB



### 2 Switch to Teletext



- DVB programmes have digital teletext services (MHEG).

Example :

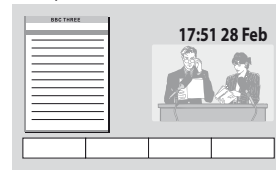

### How to operate services

In all cases, it is possible to navigate the pages using buttons on the remote control, but because the commands available must apply to all manufacturers of digital equipment, some on screen commands may not correspond exactly to the remote control buttons.

- Select, go



- Back key



- Symbol : ◀▶▼▲



- Coloured characters



Coloured button

- When options with numbers are displayed



### Note

- As soon as you switch to a digital channel with links to a teletext service, software is downloaded in the background to enable the teletext function. This means that when switching to a digital channel, you should wait for approximately 5 seconds before pressing the TEXT button - this will allow the software to download. If you press the TEXT button before download is complete, it will be ignored and you will have to press the TEXT button again when the download is complete.
- While navigating digital teletext, you will find there is a short delay when moving between pages while the page downloads. There is often a prompt shown somewhere on the page (for example "Loading") to let you know that this is happening.

### To return to TV



## Analogue teletext

Analogue teletext services are the text information provided by the broadcasters. The features may vary depending on the broadcasters.

### What is FASTEXT (FLOF) mode?

In FASTEXT mode, four differently coloured subjects are situated at the bottom of the screen. To access more information about one of these subjects, press the appropriately coloured button. This facility enables fast access to information on the subjects shown.

### What is List mode?

In List mode, four differently coloured page numbers are situated at the bottom of the screen. Each of these numbers can be altered and stored in the TV's memory. ➔ "Store frequently viewed pages" (p. 23)

### ■ To change mode ➔ [Teletext] (p. 31)



#### 1 Select Analogue



#### 2 Switch to Teletext



Sub page number

<< 01 02 03 04 05 06 07 >>

P100

17:51 28 Feb — Time / date

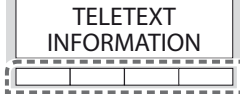

Colour bar

Current page number

- Displays the index page (content varies depending on the broadcasters)

#### 3 Select the page



or up  
down

or Coloured button  
(Corresponds to the colour bar)

#### ■ To adjust contrast

MENU

(Press twice)

As the blue bar is displayed



### ■ To return to TV

EXIT



## FULL / TOP / BOTTOM

MENU



(green)

(TOP)

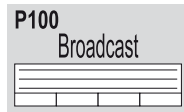

(Expand the TOP half)

(BOTTOM)

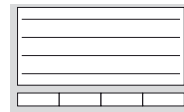

(Expand the BOTTOM half)

Normal (FULL)

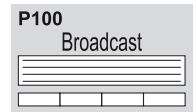

## Reveal hidden data

Reveal hidden words e.g. quiz page answers

MENU



(red)

- Press again to rehide

## HOLD

Stop automatic updating

(If you wish to hold the current page without updating)

HOLD



- Press again to resume

## INDEX

### Return to the main index page

INDEX



## Subtitles

### View a favourite page stored

STTL



- Factory setting is "P888" (subtitle service) on the blue button (List mode).

## View in multi window

### Watch TV and Teletext in two windows at once

TEXT



- Operations can be made only in Teletext screen.
- Each time pressed: Teletext → TV and Teletext



## Store frequently viewed pages

### Store frequently viewed pages in the colour bar (List mode only)

As page is displayed



(Corresponding coloured button)



press and hold

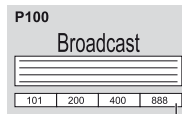

The number changes to white.

- If you wish to use Subtitles, do not change number on blue button.

### ■ To change stored pages



Coloured button you want to change



Enter new page number



press and hold

## View sub page

### View sub page (Only when teletext is more than one page)



<<01 02 03 04 05

Appears at top of the screen

- The number of sub pages varies depending on the broadcasters (up to 79 pages).
- It may take some time for searching, during which time you can watch TV.

### ■ To view specific sub page

MENU



(blue)

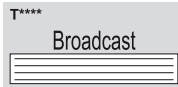

Enter the 4-digit number example : P6

0 0 0 6

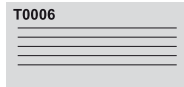

## Watch TV while waiting for update

### View the TV picture while searching for a teletext page

Teletext automatically updates itself when new information becomes available.

MENU



(yellow)



Changes to TV screen temporarily



Appears when updating is completed



View the updated page

(yellow)

(You cannot change the channel.)

- The news page provides a function that indicates arrival of latest news ("News Flash").

# Watching External Inputs

Connect the external equipment (VCRs, DVD equipment, etc.) and you can watch through the AV input.

- To connect the equipment ➔ (p. 10, 11, 67, 68, 69)

The Remote Control is capable of operating some functions of selected external equipment.

- ➔ "Operating the equipment with the TV remote control" (p. 25)



## 1 Turn the TV on



### When connecting with SCART as example 2 or 3 (p. 10, 11)

Receives input signals automatically when playback starts

- Input signals are automatically identified by the SCART (pin 8) terminal.
- This function is also available for HDMI connections (p. 67).

### If input mode is not switched automatically

Perform **2** and **3**

- Check the setup of the equipment.

## 2 Display the input selection menu



## 3 Select the input mode connected to the equipment

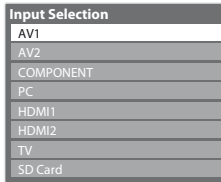

- You can also select the input using the AV button on the remote control or the side panel of the TV (except [SD Card]).

Press the button repeatedly until the desired input is selected.

- [SD Card] : Switches to Media Player ➔ [Using Media Player] (p. 52)
  - You can label or skip each input mode (except [SD Card]). ➔ "Input Labels" (p. 44)
- Skipped inputs will not be displayed when the AV button is pressed.

## 4 View

AV1 ————— Displays the selected mode

- To return to TV



Terminal	AV1	AV2	COMPONENT	PC	HDMI1	HDMI2
<b>Manual input</b> (default setting in "Input Labels")	AV1 AV1-RGB	AV2	COMPONENT	PC	HDMI1	HDMI2
<b>Auto input</b> (EC mode or VIERA Link)	EC/AV1 EC/AV1-RGB	-	-	-	EC/HDMI1 Applicable for EC mode and VIERA Link	EC/HDMI2 Applicable for VIERA Link

- If the above information is permanently displayed on the top left of the screen, press the **i** button to clear.









### Note

- If the external equipment has an aspect adjustment function, set it to [16:9].
- For details, see the manual of the equipment or ask your local dealer.



## Operating the equipment with the TV remote control

The Panasonic equipment connected to the TV can be directly operated with the below buttons of this TV remote control.

	<b>Standby</b> Set to Standby mode / Turn on
	<b>Play</b> Playback videocassette / DVD / video content
	<b>Stop</b> Stop the operations
	<b>Rewind / Skip / Search</b> VCR: Rewind, view the picture rapidly in reverse DVD / video content: Skip to the previous track or title Press and hold to search backward
	<b>Fast-forward / Skip / Search</b> VCR: Fast-forward, view the picture rapidly forward DVD / video content: Skip to the next track or title Press and hold to search forward
	<b>Pause</b> Pause / Resume DVD: Press and hold to play at slow speed
	<b>Channel Up / Down</b> Select channel
	<b>Record</b> Start recording

### How to change the code for the type of the equipment

Each type of the Panasonic equipment has its own remote control code.

Please change the code according to the equipment you want to operate.

If you operate in Video mode of Media Player (p. 56) or operate the connected equipment in VIERA Link (p. 64), select the code "73".

**Press and hold**  **during the following operations**

Enter the appropriate code, see table below



Press



Type of the equipment	Code
DVD Recorder, DVD Player, Blu-ray Disc Player	70 (default)
Player theatre, Blu-ray Disc theatre	71
VCR	72
Using in Video mode of Media Player ➔ <b>"Video mode" (p. 56)</b> The equipment using in VIERA Link ➔ <b>"VIERA Link Control" (p. 64)</b>	73

#### Note

- Confirm if the remote control works correctly after changing the code.
- The codes may be reset to default values if batteries are replaced.
- Some operations may not be possible on some equipment models.

# How to Use VIERA TOOLS

You can access some special features easily by using the VIERA TOOLS function.

- For [VIERA Link Control] and [Pause Live TV] functions to operate correctly, ensure the connections and settings are completed.
  - ➔ **“Summary of Q-Link and VIERA Link features” (p. 59, 60), “Preparations” (p. 62)**
  - After connection, turn the equipment on and then switch the TV on.
- For [Photo], [Video] and [Music] functions to operate correctly, ensure the device has photo or video data on it and insert it into the SD Card slot properly.
  - ➔ **“Using Media Player” (p. 52)**

How to Use VIERA TOOLS



## 1 Display icons of the feature



## 2 Select a feature



## 3 Follow the operations of each feature

[VIERA Link Control]

➔ **“VIERA Link Control” (p. 64)**

When two or more compatible equipment are connected, a selection screen will be displayed. Please select the correct description and access.



[Photo]

➔ **“Photo mode” (p. 53)**



[Video]

➔ **“Video mode” (p. 56)**



[Music]

➔ **“Music mode” (p. 58)**



■ **To return to TV**



### Note

- If the selected feature is not available, the demonstration to explain how to use it can be displayed. Press the OK button to view the demonstration after selecting the unavailable feature.

# How to Use Menu Functions

Various menus allow you to make settings for the picture, sound, and other functions.



**1 Display the menu**  
 MENU ● Displays the functions that can be set (varies according to the input signal)

**2 Select the menu**

① select  
 ② access

**3 Select the item**  
 Example : [Picture Menu]

select

**4 Adjust or select**  
 Example : [Picture Menu]

① change  
 ② store or access  
 (Required by some functions)

■ To return to TV at any time



■ To return to the previous screen



■ To change menu pages



■ Choose from among alternatives  
 Number and positions of alternatives

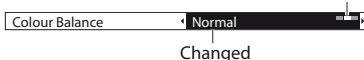

■ Adjust using the slide bar



■ Go to the next screen

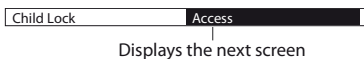

■ Enter characters by free input menu

You can enter names or numbers freely for some items.

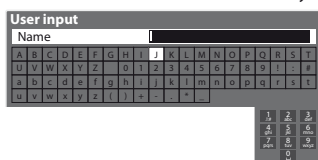

Set characters



Store



● To use numeric buttons

➔ “Characters table for numeric buttons” (p. 72)

■ To reset the settings

- To reset the picture settings only  
 ➔ [Reset to Defaults] in the **Picture Menu** (p. 28)
- To reset the sound settings only  
 ➔ [Reset to Defaults] in the **Sound Menu** (p. 30)
- To reset the picture and sound settings together  
 ➔ N (Also volume level and aspect mode are reset)
- To initialise all settings  
 ➔ [Shipping Condition] in the **Setup Menu** (p. 32)

**Note**

- If “Demo Settings” item is displayed in the Setup Menu, the TV is in “Shop” viewing environment. To return to “Home” viewing environment initialise all settings by accessing Shipping Condition. ➔ (p. 47)

## Menu list

Menu	Item	Adjustments / Configurations (alternatives)
Picture	Viewing Mode	<p>Basic picture mode <b>[Dynamic]</b> / <b>[Normal]</b> / <b>[Cinema]</b> / <b>[True Cinema]</b> / <b>[Game]</b>                      In each Viewing Mode, [Contrast], [Brightness], [Colour], [Sharpness], [Tint], [Colour Balance], [Vivid Colour], [C.A.T.S.], [P-NR] and [3D-COMB] can be adjusted and stored to suit your particular viewing requirement.</p> <ul style="list-style-type: none"> <li>● Set for each input signal.</li> </ul> <p><b>[Dynamic]</b> : Provides enhanced picture contrast and sharpness when viewing in a bright room.</p> <p><b>[Normal]</b> : Recommended for viewing under normal ambient room lighting conditions.</p> <p><b>[Cinema]</b> : For watching movies in a darkened room with the improved performance of contrast, black and colour reproduction</p> <p><b>[True Cinema]</b> : Precisely reproduces the original quality of the image without any revision.</p> <p><b>[Game]</b> : Fast response signal specifically to provide suitable images for playing games</p> <ul style="list-style-type: none"> <li>● Not valid on TV mode</li> <li>● A continuous record of time spent using Game mode can be displayed in the top right of the screen. ➔ [Playing Time Display] (p. 31)</li> </ul>
	Contrast, Brightness, Colour, Sharpness	Increases or decreases the levels of these options according to your personal preference
	Tint	<p>With an NTSC signal source connected to the TV, the picture hue can be adjusted to suit your taste</p> <ul style="list-style-type: none"> <li>● For NTSC signal reception only</li> </ul>
	Colour Balance	<p>Allows you to set the overall colour tone of the picture <b>[Cool]</b> / <b>[Normal]</b> / <b>[Warm]</b></p> <ul style="list-style-type: none"> <li>● Not valid when [Viewing Mode] is set to [True Cinema].</li> </ul>
	Vivid Colour	<p>Automatically adjusts colours to vivid ones <b>[Off]</b> / <b>[On]</b></p> <ul style="list-style-type: none"> <li>● Not valid on PC signal</li> </ul>
	C.A.T.S.	<p>Contrast Automatic Tracking System (Automatic Brightness Control function)                      Adjusts picture settings automatically dependent on ambient lighting conditions <b>[Off]</b> / <b>[On]</b></p> <ul style="list-style-type: none"> <li>● Set to [On] to make the suitable contrast setting automatically. The default setting is [On] when [Viewing Mode] is set to [Normal].</li> </ul>
	P-NR	<p>Picture Noise Reduction                      Automatically reduces unwanted picture noise and flicker noise in the contoured parts of a picture <b>[Off]</b> / <b>[Min]</b> / <b>[Mid]</b> / <b>[Max]</b></p> <ul style="list-style-type: none"> <li>● Not valid on PC signal</li> </ul>
	3D-COMB	<p>Makes still or slow moving pictures look more vivid <b>[Off]</b> / <b>[On]</b></p> <ul style="list-style-type: none"> <li>● Occasionally, whilst viewing still or slow moving pictures, colour patterning may be seen. Set to [On] to display sharper and more accurate colours.</li> <li>● For PAL or NTSC signal reception only</li> <li>● Not valid on RGB, Component, PC, HDMI and Media Player</li> </ul>
	Screen Display	<p>Turns the screen off when you select <b>[Off]</b> <b>[Off]</b> / <b>[On]</b></p> <ul style="list-style-type: none"> <li>● The sound is active even if the screen turns off.</li> <li>● Press any buttons (except Standby) to turn the screen on.</li> <li>● This function is effective in reducing power consumption when listening to the sound without watching the TV screen.</li> </ul>
	Advanced Settings	16:9 Overscan
DVI Input Setting		<p>Changes the black level in the image for HDMI input mode with DVI input signal manually</p> <p><b>[Normal]</b> / <b>[Full]</b></p> <ul style="list-style-type: none"> <li>● When the DVI input signal from the external equipment, especially from PC, is displayed, the black level may not be suitable. In this case, select [Full].</li> <li>● The black level for HDMI input signal will be adjusted automatically.</li> <li>● For HDMI input mode with DVI input signal only</li> </ul>
	Reset to Defaults	Press the OK button to reset the present Picture Viewing Mode to the default settings

Menu	Item	Adjustments / Configurations (alternatives)
Sound	Mode	<p>Selects the basic sound mode <b>[Music]</b> / <b>[Speech]</b> / <b>[User]</b></p> <ul style="list-style-type: none"> <li>• The selected mode affects all input signals.</li> </ul> <p><b>[Music]</b> : Improves sound quality for watching music videos, etc.</p> <p><b>[Speech]</b> : Improves sound quality for watching news, drama, etc.</p> <ul style="list-style-type: none"> <li>• In Music and Speech modes, you can adjust [Bass] and [Treble] settings, and those settings will be stored for each mode.</li> </ul> <p><b>[User]</b> : Adjusts the sounds manually by using the equaliser to suit your favourite sound quality.</p> <ul style="list-style-type: none"> <li>• For the User mode, [Equaliser] will appear on the Sound Menu instead of [Bass] and [Treble]. Select the [Equaliser] and adjust the frequency. ➔ [Equaliser] (see below)</li> </ul>
	Bass	Increases or decreases level to enhance or minimise lower, deeper sound output
	Treble	Increases or decreases level to enhance or minimise sharper, higher sound output
	Equaliser	<p>Adjusts the frequency level to suit your favourite sound quality</p> <ul style="list-style-type: none"> <li>• This function is available when [Mode] is set to [User].</li> <li>• Select the frequency and change the frequency level by using the cursor button.</li> <li>• If you want to enhance the bass sound, raise the level of the lower frequency. If you want to enhance the treble sound, raise the level of the higher frequency.</li> <li>• To reset the levels of each frequency to the default settings, select the [Reset to Defaults] by using the cursor button, and then press the OK button.</li> </ul>
	Balance	Adjusts volume level of right and left speakers
	Headphone Volume	Adjusts the volume of the headphones
	Surround	<p>Surround sound settings <b>[Off]</b> / <b>[V-Audio]</b> / <b>[V-Audio Surround]</b></p> <p><b>[V-Audio]</b> : Provides a dynamic enhancer of width to simulate improved spatial effects</p> <p><b>[V-Audio Surround]</b> : Provides a dynamic enhancer of width and depth to simulate improved spatial effects</p>
	Auto Gain Control	Adjusts the current volume level if it is extremely different from the previous viewed channel or input mode <b>[Off]</b> / <b>[On]</b>
	Volume Correction	Adjusts the volume of individual channel or input mode
	Speaker Distance to Wall	<p>Adjusts the low frequency sound <b>[Over 30cm]</b> / <b>[Up to 30cm]</b></p> <ul style="list-style-type: none"> <li>• If the gap between the TV and wall is over 30 cm, [Over 30cm] is recommended.</li> <li>• If the gap between the TV and wall is within 30 cm, [Up to 30cm] is recommended.</li> </ul>
	Preferred Multi Audio	<ul style="list-style-type: none"> <li>• Selects the preferred language for digital channel multi audio (depending on the broadcaster) <b>[English]</b> / <b>[Welsh]</b> / <b>[Gaelic]</b> / <b>[Irish]</b></li> </ul>
	NICAM	<p>Near Instantaneous Companded Audio Multiplex Reproduces NICAM stereo sound <b>[On]</b> / <b>[Off]</b></p> <ul style="list-style-type: none"> <li>• Off if reception is poor (FM monaural sound)</li> <li>• Analogue mode only</li> </ul>
	SPDIF Selection	<p>SPDIF: A standard audio transfer file format Selects the initial setting for digital audio output signal from DIGITAL AUDIO OUT and HDMI2 (ARC function) terminals <b>[Auto]</b> / <b>[PCM]</b></p> <p><b>[Auto]</b> : Dolby Digital Plus and Dolby Digital are output as Dolby Digital Bitstream. HE-AAC (48 kHz) multi-channel is output as DTS. MPEG is output as PCM.</p> <p><b>[PCM]</b> : Digital output signal is fixed to PCM.</p> <ul style="list-style-type: none"> <li>• For DVB mode or Video mode of Media Player (p. 56)</li> <li>• ARC (Audio Return Channel) : A function of digital audio output using HDMI cable</li> </ul>
	PCM Optical Level	<p>Adjusts the audio level of PCM output from DIGITAL AUDIO OUT terminal as the initial setting <b>[-12]</b> / <b>[-10]</b> / <b>[-8]</b> / <b>[-6]</b> / <b>[-4]</b> / <b>[-2]</b> / <b>[0]</b> (dB)</p> <ul style="list-style-type: none"> <li>• Normally, PCM sound is larger comparing with the other types of audio track.</li> <li>• DVB mode only</li> </ul>
HDMI1 / 2 Input	<p>Select to fit the input signal <b>[Digital]</b> / <b>[Analogue]</b> (p. 72)</p> <p><b>[Digital]</b> : When sound is carried via the HDMI cable connection</p> <p><b>[Analogue]</b> : When sound is not carried via the HDMI cable connection</p> <ul style="list-style-type: none"> <li>• HDMI input mode only</li> </ul>	

Menu	Item	Adjustments / Configurations (alternatives)	
Sound	Audio Description Menu	<b>Audio Description</b> Useful for visually-impaired viewers <b>[Off]</b> / <b>[Auto]</b> Set to "Auto" to activate the description sound track if available <ul style="list-style-type: none"> <li>The availability of audio description sound track is indicated by [AD] in the information banner (p. 15).</li> <li>DVB mode only</li> </ul> <b>UK only</b>	
		<b>Volume</b> Adjusts the volume for Audio Description <ul style="list-style-type: none"> <li>DVB mode only</li> </ul> <b>UK only</b>	
		<b>Speakers</b> Set to [On] to activate the description sound track from TV speakers <b>[Off]</b> / <b>[On]</b> <ul style="list-style-type: none"> <li>DVB mode only</li> </ul> <b>UK only</b>	
		<b>Headphones</b> Set to [On] to activate the description sound track from headphones <b>[Off]</b> / <b>[On]</b> <ul style="list-style-type: none"> <li>DVB mode only</li> </ul> <b>UK only</b>	
Setup	<b>Reset to Defaults</b>	Press the OK button to reset the present Sound Mode, [Balance], [Headphone Volume] and [Surround] to the default settings	
	<b>Timer Programming</b>	Sets a timer to remind watching or record forthcoming programmes (p. 41)	
	TV Guide Settings	<b>TV Guide View</b>	Changes the layout of TV Guide <b>[Normal]</b> / <b>[Full]</b> / <b>[Info]</b> <b>[Normal]</b> : Default TV Guide screen <b>[Full]</b> : Displays channels and programmes full-screen without the operation guide <b>[Info]</b> : Displays details of the selected programme at the bottom without the operation guide
		<b>GUIDE Plus+ Postcode</b>	Sets your postcode to display advertisements in the GUIDE Plus+ system (p. 20) <b>UK only</b>
		<b>GUIDE Plus+ Information</b>	Displays the system information of the GUIDE Plus+ system <b>UK only</b>
	<b>Off Timer</b>	Sets the time until the TV automatically goes to Standby mode <b>[Off]</b> / <b>[15]</b> / <b>[30]</b> / <b>[45]</b> / <b>[60]</b> / <b>[75]</b> / <b>[90] (minutes)</b> (p. 16)	
	<b>Eco Navigation</b>	Automatically sets the TV to the most suitable energy-saving mode <ul style="list-style-type: none"> <li>If you press the OK button, the following items are set as below :                [C.A.T.S.], [VIERA Link], [Standby Power Save], [Power Save] ► [On]                [Intelligent Auto Standby] ► [On (No reminder)]                [Auto Standby] ► [2 hours]</li> </ul>	
	Link Settings	<b>VIERA Link</b>	Sets to use VIERA Link functions <b>[Off]</b> / <b>[On]</b> (p. 62)
		<b>AV1 out</b>	Chooses the signal to be transmitted from the TV to Q-Link <b>[TV]</b> / <b>[AV2]</b> / <b>[Monitor]</b> <b>[Monitor]</b> : Image displayed on screen <ul style="list-style-type: none"> <li>Component, PC and HDMI signals cannot be output.</li> </ul>
		<b>Standby Power Save</b>	Controls the power consumption in Standby mode of the connected equipment to reduce the consumption <b>[Off]</b> / <b>[On]</b> (p. 63) <ul style="list-style-type: none"> <li>This function is available when [VIERA Link] is set to [On].</li> </ul>
<b>Intelligent Auto Standby</b>		Makes non-watched or non-used connected equipment go into Standby mode to reduce the power consumption <b>[Off]</b> / <b>[On (With reminder)]</b> / <b>[On (No reminder)]</b> (p. 63) <ul style="list-style-type: none"> <li>This function is available when [VIERA Link] is set to [On].</li> </ul>	
<b>Q-Link Download</b>		Downloads analogue channel information to a Q-Link compatible equipment connected to the TV	

Menu	Item	Adjustments / Configurations (alternatives)	
Setup	<b>Child Lock</b>	Locks a channel / AV input to prevent access to it (p. 43)	
	<b>DVB Tuning Menu</b>	<b>Favourites Edit</b>	Creates a list of favourite DVB channels (p. 38)
		<b>Channel List</b>	Skips the unwanted DVB channels or edits DVB channels (p. 39)
		<b>Auto Setup</b>	Automatically sets the DVB channels received in the area (p. 36)
		<b>Channel Sorting by Region</b>	Automatically sorts tuned channels according to the available region (p. 37) <b>UK only</b>
		<b>Manual Tuning</b>	Sets the DVB channels manually (p. 37)
		<b>Update Channel List</b>	Updates DVB Channel List while keeping your settings (p. 39)
		<b>New Channel Message</b>	Selects whether to give a notification message when a new DVB channel is found <b>[Off] / [On]</b> (p. 38)
		<b>Signal Condition</b>	Checks the DVB signal condition (p. 38)
	<b>Analogue Tuning Menu</b>	<b>Channel List</b>	Skips the unwanted Analogue channels or edits Analogue channels (p. 40)
		<b>Auto Setup</b>	Automatically sets the Analogue channels received in the area (p. 36)
		<b>Manual Tuning</b>	Sets the Analogue channels manually (p. 40)
	<b>Display Settings</b>	<b>Preferred Teletext</b>	Selects the preferred language for digital channel teletext service (depending on the broadcaster) <b>[English] / [Welsh] / [Gaelic] / [Irish]</b> <b>Ireland only</b>
		<b>Teletext</b>	Analogue teletext display mode <b>[FASTEXT] / [List]</b> (p. 22)
		<b>Teletext Character Set</b>	Selects teletext language font <b>[West] / [East1] / [East2]</b> <b>[West]</b> : English, French, German, Greek, Italian, Spanish, Swedish, Turkish, etc. <b>[East1]</b> : Czech, English, Estonian, Lettish, Rumanian, Russian, Ukrainian, etc. <b>[East2]</b> : Czech, Hungarian, Lettish, Polish, Rumanian, etc. <b>Ireland only</b>
		<b>Preferred Subtitles</b>	Selects the preferred language for digital channel subtitles (depending on the broadcaster) <b>[English] / [Welsh] / [Gaelic] / [Irish]</b> To display subtitles ➔ (p. 17) <input checked="" type="checkbox"/> provides aids in understanding and enjoyment with DVB subtitles (depending on the broadcaster).
		<b>Input Labels</b>	Labels or skips each input terminal (p. 44)
		<b>Banner Display Timeout</b>	Sets how long the Information banner (p. 15) stays on screen <b>[0 (No display)] / [1] / [2] / [3] / [4] / [5] / [6] / [7] / [8] / [9] / [10] (seconds)</b>
		<b>Playing Time Display</b>	Set to [On] to display a continuous record of time spent using Game mode every 30 minutes <b>[Off] / [On]</b> ● This function is available when [Game] is selected in [Viewing Mode] ➔ (p. 28)
		<b>Radio Mode</b>	Sets the timer for turning off the screen automatically when a radio channel is selected <b>[Off] / [5] / [10] / [15] / [20] (seconds)</b> ● The sound is active even if the screen turns off. ● Press any buttons except Standby, Volume Up / Down and Sound Mute buttons to turn the screen on. ● This function is effective in reducing power consumption when listening to a radio channel.

Menu	Item	Adjustments / Configurations (alternatives)	
Setup	<b>Network Setup</b>	Sets the network setting to use in your network environment (p. 45)	
	System Menu	<b>Shipping Condition</b>	Resets all settings, for example, when moving house (p. 47)
		<b>Owner ID</b>	Inputs the owner ID (p. 48)
		<b>Common Interface</b>	Uses include to watch encrypted channels (p. 49)
		<b>System Update</b>	Downloads new software to this TV (p. 50)
		<b>Software Licence</b>	Displays the software licence information
		<b>System Information</b>	Displays the system information of this TV
		Other Settings	<b>Power on Preference</b>
	<b>Power on Channel List</b>		Automatically selects All Channels or Favourites list in the Information banner (p. 15) when the TV is turned on <b>[All Channel List] / [Last]</b> Set to [All Channel List] to display all the channels. Set to [Last] to display the one you selected last time. <ul style="list-style-type: none"> <li>• Not available in Analogue mode</li> </ul>
	<b>Auto Standby</b>		Sets the time the TV automatically goes to Standby mode when no operation is performed for the selected times <b>[Off] / [2] / [4] (hours)</b> <ul style="list-style-type: none"> <li>• Starting Timer Programming automatically does not affect this function.</li> <li>• Automatic input switching with the connected equipment affects this function and time-count will be reset.</li> <li>• The notification message will appear 3 minutes before going to Standby mode.</li> </ul>
	<b>Power Save</b>		Reduces brightness of picture to economise on power consumption <b>[Off] / [On]</b>

- A different menu will be displayed in the mode of PC input or Media Player. (p. 51 - p. 58)
- Only available items can be selected.



# Overview (Picture, Sound)

How to operate → (p. 27)

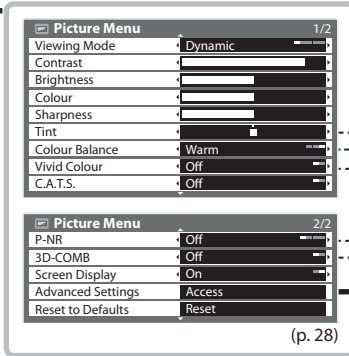
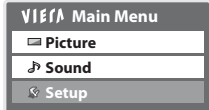

Available in NTSC

Not available when [Viewing Mode] is set to [True Cinema]

Not available in PC

Available in NTSC / PAL

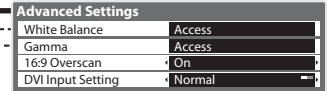

Available in PC

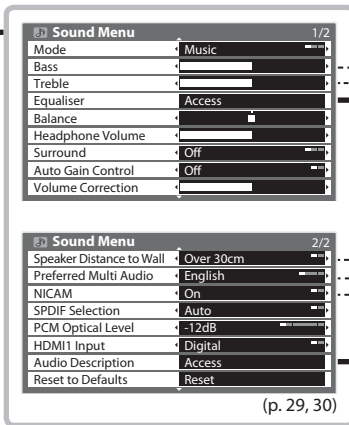

Available when [Mode] is set to [Music] or [Speech]

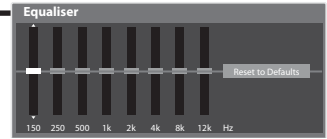

Available when [Mode] is set to [User]

Available in DVB

Available in Analogue

Available in DVB or Video mode

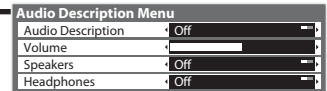

Available in DVB (UK only)

# Overview (Setup)

How to operate → (p. 27)

**VIERA Main Menu**

- Picture
- Sound
- Setup**

**Setup Menu** 1/2

- PC Setup Access
- Timer Programming Access
- TV Guide Settings Access
- Off Timer Off
- Eco Navigation Access
- Link Settings Access
- Child Lock Access
- DVB Tuning Menu Access
- Analogue Tuning Menu Access
- Display Settings Access

---

**Setup Menu** 2/2

- Network Setup Access
- System Menu Access
- Other Settings Access

(p. 30 - 32)

**Other Settings**

- Power on Preference TV
- Power on Channel List Last
- Auto Standby Off
- Power Save Off

--- Available in DVB (p. 32)

**System Menu**

- Shipping Condition Access
- Owner ID Access
- Common Interface Access
- System Update Access
- Software Licence Access
- System Information Access

(p. 32)

---

**System Update**

- Auto Update Search in Standby On
- System Update Search Now Access

(p. 50)

---

**Common Interface**

Slot 1: Module inserted

Available in DVB (p. 49)

---

**Owner ID**

Please enter PIN for access

PIN: \*

(p. 48)

---

**Shipping Condition**

All tuning data will be erased  
Are you sure?  
Are you sure?

(p. 47)

**PC Setup**

- Input Resolution 1024 x 768
- Clock
- H-pos
- V-pos
- Clock Phase
- Sync H & V
- Reset to Defaults Reset

Available in PC (p. 51)

**Timer Programming** Wed 27.10.2010 10:46

Function	No.	Channel Name	Date	Start	End
Est Rec	D 72	BBC 2W	<TIMER>	20:00	21:30
Reminder	D 14	EL	Wed 27 Oct	21:00	22:00
Est Rec	D 1	BBC ONE	DIV 202	23:45	1:30 am
Est Rec	D 1	BBC ONE	STL	10:30	11:30

(p. 41)

**Child Lock-PIN Entry**

Please enter new PIN

PIN: \*

(p. 43)

**DVB Tuning Menu**

- Favourites Edit Access
- Channel List Access
- Auto Setup Access
- Channel Sorting by Region Access
- Manual Tuning Access
- Update Channel List Access
- New Channel Message On
- Signal Condition Access

Available in DVB (p. 36 - 39)

**DVB Update Channel List**

Progress: CH 21 65%

This will take about 3 minutes.

Ch	Channel Name	Type	Quality
Free TV: 0	Pay TV: 0	Radio: 0	Data: 0

Searching

(p. 39)

**Analogue Tuning Menu**

- Channel List Access
- Auto Setup Access
- Manual Tuning Access

Available in Analogue (p. 36, 39, 40)

How to Use Menu Functions

**TV Guide Settings Menu**

- TV Guide View: Normal
- GUIDE Plus+ Postcode: Access
- GUIDE Plus+ Information: Access

UK only (p. 30)

**Enter Postcode**

Postcode: [A-Z 0-9]

(p. 30)

**Link Settings** 1/2

- VIERA Link: On
- AV1 out: TV
- Standby Power Save: On
- Intelligent Auto Standby: On (No reminder)
- Q-Link Download: Access

(p. 30)

**Sending Preset Data**  
Please wait!

0% [Progress Bar] 100%

Remote control unavailable (p. 30)

**Child Lock**

- Change PIN: Access
- Child Lock List: Access
- Parental Rating: No limit

Ireland only (p. 43)

**Child Lock List - TV and AV** Sorting 123...

Name	Input	Type	Lock
101 BBC1 Wales	DVB	Free TV	
7 BBC THREE	DVB	Free TV	
14 E4	DVB	Free TV	
VCR	Analogue	Analogue	
1 BBC1	Analogue	Analogue	
2 ****	Analogue	Analogue	
AV1	External	AV	
AV2	External	AV	

(p. 43)

**DVB Manual Tuning**

Frequency: [ ] MHz  
Signal Quality: 0  
Signal Strength: 0

Ch	Channel Name	Type	Now
Free TV:0	Play TV:0	Radio:0	Data:0

Stopped (p. 37)

**All DVB Channels**

- 70: CBBC Channel
- 72: Cartoon Nwk
- 105: BBC1
- 719: BBC Radio Wales
- 720: BBC Radio Cymru
- 1: BBC ONE Wales
- 7: BBC THREE

(p. 39)

**DVB Favourites Editor**

All DVB Channels	Favourites1
1 BBC One Wales	
7 BBC THREE	
14 E4	
70 CBBC Channel	
72 Cartoon Nwk	
105 BBC1	
719 BBC Radio Wales	
720 BBC Radio Cymru	

(p. 38)

**Channel Sorting by Region**

Best signal quality (All Regions)

England Regions

Region choice available (p. 37)

**DVB Auto Setup** CH 21

This will take about 3 minutes.

Ch	Channel Name	Type	Quality
62	CBBC Channel	Free TV	100
62	BBC Radio Wales	Free TV	100
62	E4	Free TV	100
62	Cartoon Nwk	Free TV	100

Free TV:4 Play TV:0 Radio:0 Data:0 Searching (p. 36)

**Analogue Manual Tuning**

BBC1 Manual Tuning 21 [Progress Bar] CH31

Manual Tuning 21 [Progress Bar] -68 (p. 40)

**Analogue Auto Setup** CH 21

This will take about 3 minutes.

Ch	Channel Name
29	
30	

Analogue:2 Searching (p. 36)

**Analogue Channel List**

- 1: BBC1
- 2: \*\*\*\*
- 4: \*\*\*\*
- 5: \*\*\*\*
- 6: \*\*\*\*
- 7: \*\*\*\*

(p. 40)

**Display Settings**

- Preferred Teletext: Irish
- Teletext: FASTEXT
- Teletext Character Set: West
- Preferred Subtitles: English
- Input Labels: Access
- Banner Display Timeout: 3 seconds
- Playing Time Display: On
- Radio Mode: Off

(p. 31)

Available in DVB Ireland only

Available in Analogue Ireland only

Available in DVB

**Input Labels**

- AV1: DVD
- AV2: AV2
- COMPONENT: COMPONENT
- PC: PC
- HDMI1: HDMI1
- HDMI2: HDMI2
- DVB: DVB
- Analogue: Analogue

(p. 44)

# Retuning from Setup Menu

Automatically retune the channels received in the area.

- This function is available if channel tuning is already performed.
- Only the selected mode is retuned.
- All the previous tuning settings are erased.
- If Child Lock PIN number (p. 43) has been set, the PIN number is required.
- If tuning has not been done completely ➔ **[Manual Tuning]** (p. 37, 40)

## DVB or Analogue channels

Retuning from Setup Menu



■ To return to TV



**For Auto Setup, using the buttons on the side panel of the TV (p. 9)**

1 Press repeatedly until [Auto Setup] appears



2 Access [Auto Setup]



3 Start [Auto Setup]

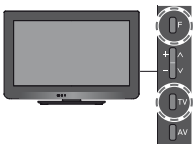

• To return to TV



### 1 Select DVB or Analogue



### 2 Display the menu



### 3 Select [Setup]

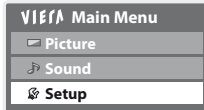

### 4 Select [DVB Tuning Menu] or [Analogue Tuning Menu]

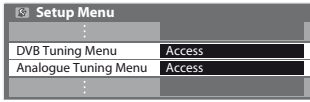

• The displayed item depends on the selected mode.

### 5 Select [Auto Setup]

Example :

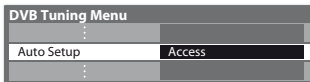

### 6 Start Auto Setup (Settings are made automatically)

Example : DVB

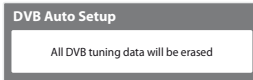

Example : Analogue

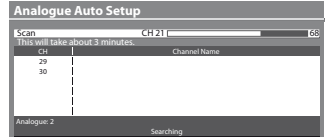
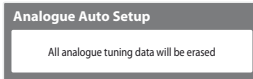

• The analogue settings are downloaded to a Q-Link compatible equipment connected to the TV in Analogue mode.

**When the operation is completed, the channel at the lowest position will be displayed.**

# Tuning and Editing Channels (DVB)

You can retune channels or make your favourite channel lists, skip unwanted channels, etc.



- 1 **Select DVB**  
TV
- 2 **Display the menu**  
MENU
- 3 **Select [Setup]**  

VIEW Main Menu	
Picture	
Sound	
Setup	
- 4 **Select [DVB Tuning Menu]**  

Setup Menu	
DVB Tuning Menu	Access
- 5 **Select one of the following functions**  

DVB Tuning Menu	
Favourites Edit	Access
Channel List	Access
Auto Setup	Access
Channel Sorting by Region	Access
Manual Tuning	Access
Update Channel List	Access
New Channel Message	On
Signal Condition	Access

■ To return to TV



• [Auto Setup] → "Retuning from Setup Menu" (p. 36)

## Sort DVB channels according to the region [Channel Sorting by Region] **UK only**

You can sort DVB channels so that those with the best signal quality, or those for your preferred region, appear nearer the top of your Channel List.

Normally, you should select [Best signal quality (All Regions)].

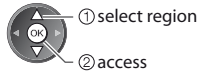
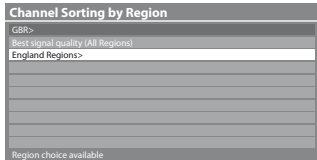

(select repeatedly until you reach the available region)

- If you choose to select your preferred region, you could find channels with a weaker signal appear nearer the top of your Channel List. If you have any image or sound problems, select [Best signal quality (All Regions)] instead.

## Set DVB channel manually [Manual Tuning]

Normally use [Auto Setup] or [Update Channel List] to retune DVB channels.

If tuning has not been done completely or for adjusting the direction of the aerial, use this function.

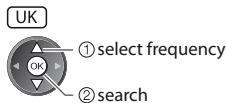
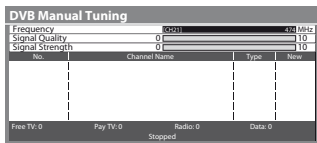

### 1 Adjust frequency for each channel

- ① select channel
- ② adjust frequency

### 2 Search



- All channels found will be added to the Channel List.

- Set where the level of [Signal Quality] becomes the maximum.

## List favourite DVB channels [Favourites Edit]

Create your favourite channel lists from various broadcasters (up to 4: [Favourites]1 to 4).

The DVB Favourites lists are available for switching in the Information banner (p. 15) and from [Category] in the TV Guide screen (p. 18).

### 1 Select a channel to list : Encrypted channel

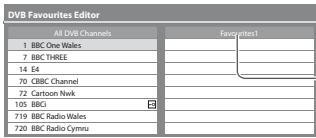

To display other Favourites



### 2 Add it to the Favourites list

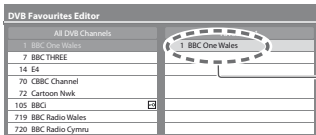

To add all channels to the list



### To edit Favourites list

While the cursor is in the Favourites field to edit

- To delete a channel
- To delete all channels



select



delete

- To move the channel



Select the new position



or

Select the turn



Store



- To name the Favourites



Set characters (maximum: ten characters)



select

set

Store



- To use numeric buttons
- “Characters table for numeric buttons” (p. 72)

### 3 Store

RETURN



### Note

- Channel position numbers (known as logical channel numbers) can be swapped in Channel List. To swap the channel position number ➔ [Channel List] (p. 39)

## Check DVB signal [Signal Condition]

Selects a channel and checks the DVB signal condition.

A good Signal Strength is not an indication of best signal for DVB reception. Please use the Signal Quality indicator as follows:

[Signal Quality]:

- Green bar ➔ Good
- Yellow bar ➔ Poor
- Red bar ➔ Bad (Check the Terrestrial aerial)

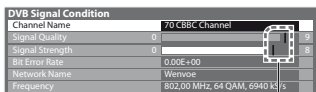

- To change the channel



## Display a notification message [New Channel Message]

Selects whether to give a notification message when a new DVB channel is found. [Off] / [On]

New channels found!  
Press OK to update channel list.  
Press EXIT to ignore.

- Selecting OK will perform [Update Channel List].

## Skip unwanted DVB channels, Edit DVB Channels [Channel List]

You can hide unwanted DVB channels.

The hidden channels cannot be displayed except in this function. Use this function to skip unwanted channels.

Select a channel and [reveal] / [hide]

All DVB Channels	
<input checked="" type="checkbox"/>	70 CBBC Channel
<input checked="" type="checkbox"/>	72 Cartoon Nwk
<input checked="" type="checkbox"/>	105 BBC1
<input checked="" type="checkbox"/>	719 BBC Radio Wales
<input checked="" type="checkbox"/>	720 BBC Radio Cymru
<input checked="" type="checkbox"/>	1 BBC ONE Wales
<input checked="" type="checkbox"/>	7 BBC THREE

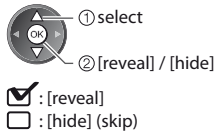

To reveal all channels  
 (yellow)

: [reveal]  
 : [hide] (skip)

### To edit channels

You can also edit each channel in Channel List.

To retune each channel → [Manual Tuning] (p. 37)

(only for the revealed channels)

(red)

To swap the channel position number (logical channel number)

(green)

→ Enter the new position number



Channel position number



→ Store  (green)

## Update DVB channel automatically [Update Channel List]

You can add new channels, delete removed channels, update channel name and position automatically to Channel List.

Example :  UK



- Channel List is updated while keeping your settings in [Favourites Edit], [Channel List], [Child Lock], [Timer Programming], etc.
- Depending on the signal condition, the update may not work properly.

## (Analogue)

You can retune channels or skip unwanted channels, edit channels etc.



1 Select Analogue

TV

2 Display the menu

MENU

3 Select [Setup]

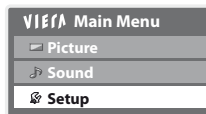

4 Select [Analogue Tuning Menu]



5 Select one of the following functions

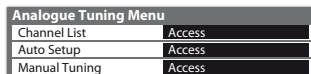

To return to TV

EXIT



• [Auto Setup]  
→ "Retuning from Setup Menu" (p. 36)

## Skip unwanted Analogue channels, Edit Analogue channels [Channel List]

You can hide unwanted Analogue channels.

The hidden channels cannot be displayed except in this function. Use this function to skip unwanted channels.

### Select a channel and [reveal] / [hide]

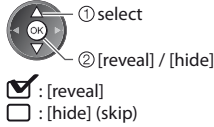
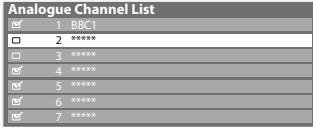

- To reveal all channels  
 (yellow)

### To edit channels

You can also edit each channel in Channel List.

- To retune each channel ([Manual Tuning]) (see below)



- To move the channel position

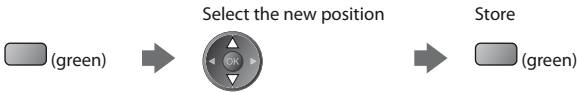

- To rename the channel name

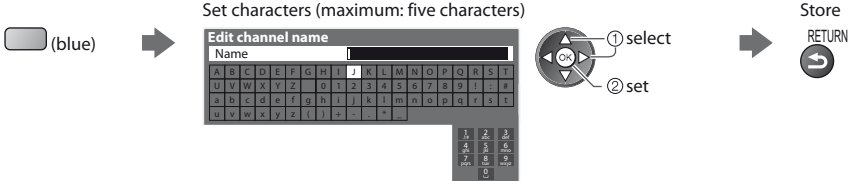

- To use numeric buttons

➔ **“Characters table for numeric buttons” (p. 72)**

Channel position  
Channel name



### Note

- If a VCR is connected only with the RF cable, edit [VCR].

## Set Analogue channel manually [Manual Tuning]

### [Fine Tuning] (Ireland only)

Use to make small adjustments to the tuning of an individual programme (affected by weather conditions, etc.)

### [Manual Tuning]

Set Analogue channel manually after Auto Setup.

- If a VCR is connected only with the RF cable, it is recommended to select channel position [0].

Example: (Ireland)



#### 1 Select the channel position



#### 2 Select the channel



#### 3 Search and store





# Timer Programming

## Timer Programming from Menu

The Timer Programming menu allows you to choose programmes that you wish to remind watching or record to the external recorder. At the correct time, the TV will tune to the correct channel automatically to record even if the TV is in Standby mode. TV Guide may also be used to set timer programming event (p. 19).

- Timer Programming can store up to 15 events.
- For recording using Timer Programming, the TV must be either On or in standby. For reminders to be displayed, the TV must be On.
- No other channel can be selected while the recording of Timer Programming is in progress.
- It may not be possible to record an encrypted programme (which is copy-protected).
- When recording programmes to the external recorder, be sure to make the proper settings on the recorder connected to the TV. If a compatible recorder with Q-Link or similar technologies is connected to the TV (p. 61) and the [Link Settings] (p. 30) are correct, no setting of the recorder is required. Also read the manual of the recorder.
- If the recorder is not compatible with Q-Link or similar technologies, set the timer of the recorder in addition to the Timer Programming on the TV. For preparations of a recorder, read the manual of the recorder.
- Recordings are always in standard definition composite video via SCART, even if the original programme is in high definition.



### 1 Select the tuner you want to use (DVB or Analogue)



### 2 Display the menu



### 3 Select [Setup]

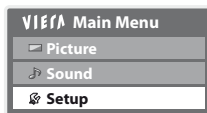

- ① select
- ② access

#### To return to TV



#### To unlock the tuner and stop recording



### 4 Select [Timer Programming]

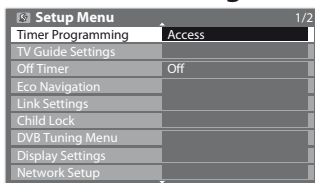

- ① select
- ② access

#### Note

- Check that the LED is orange. If not, timer programmes are not active or not stored.
- Timer Programming reminder messages will remain displayed until one of the following occurs:
  - You press the OK button to view the programme or the EXIT button to cancel the reminder.
  - The timer programming event that the reminder is set for ends.
- "!" identifies that any timer programming events have overlapped. [Ext Rec.] is given priority over [Reminder]. When two or more [Ext Rec.] overlap, the first timer programming event starts and finishes as programmed. The next timer programming event will then start.
- 2 minutes before the starting time, a reminder message appears if you are watching TV.

- To remove the message and start the programme



- To cancel the Timer Programming



- The recording of Timer Programming will automatically change to the programmed channel 10 seconds before the start time.
- To stop recording of the timer programming event, it may be necessary to stop the recorder manually.
- The recording of Timer Programming will be performed even if the TV is in Pause Live TV recording (p. 64). In this case, the Pause Live TV will be cancelled.

## Set timer programming event details [Timer Programming]

### 1 Start making the settings



### 2 Select the function ([Ext Rec.] or [Reminder])



**[Ext Rec.]** : to record the programme to the external recorder  
When the start time comes, the channel will be switched automatically and the video and audio signals will be output.  
2 minutes before the starting time, a reminder message appears if you are watching TV.

**[Reminder]** : to remind you to watch the programme  
When you are watching TV, a reminder message appears 2 minutes before the start time.  
Press the OK button to switch to the programmed channel.

### 3 Set the channel, date and time (repeat the operations as below)

Set items in the order of 1 to 4.

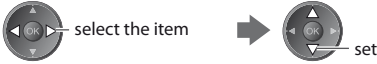

• 1, 3 and 4 can also be entered with numeric buttons.



! : Displayed if the timer programming events are overlapped  
Timer programming  
- Programmes according to the time setting

Timer Programming		Wed 27.10.2010 10:46		
Function	No.	Channel Name	Date	Start End
Ext Rec.	D 72	BBC 2W <TIMER>	Wed 27 Oct	20:00   21:30 (90 min.)
Reminder	D 14	E4 The Bill	Wed 27 Oct	21:00   22:00 (60 min.)
Ext Rec.	D 1	BBC ONE DIY SOS	Wed 27 Oct	22:45   23:00 (15 min.)
Ext Rec.	D	BBC ONE <TIMER>	Thu 28 Oct	10:30   11:30 (60 min.)

Records with subtitles (if available)

• To indicate this

(yellow) (Press again to remove subtitles)

Duration (automatic display)

2 Date

one day ahead

daily or weekly (press repeatedly)

• [Daily Sun-Sat] : Sunday to Saturday

• [Daily Mon-Sat] : Monday to Saturday

• [Daily Mon-Fri] : Monday to Friday

• [Weekly Sat/Fri/Thu/Wed/Tue/Mon/Sun] :  
Same time on the same day every week

1 Channel number

4 Ending time

3 Starting time

D : DVB / A : Analogue

• You cannot change the mode within the menu.

### UK only

Guide : Guide link programming - Programmes according to the TV Guide signal (p. 20)

S/P : Split Programme programming (p. 20)

• These functions are not available in Analogue mode.

Guide link programming is Timer Programming which is controlled by information from the TV Guide; if programme start and end times are changed by the broadcaster, the timer programming event will follow the change.

A Split Programme programming is a Guide link programming which is interrupted by one or more other programmes.

Note that Guide link programming (including Split Programme programming) only works reliably if correct information is received from broadcasters.

### 4 Store



#### To change a timer programming event

Select the programme to be changed



#### To record with subtitles (if available)

Select the programme to record with subtitles



#### To view details of the programming (only for Guide link programming) UK only

Select the programme to be viewed

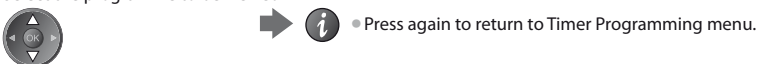

#### To cancel a timer programming event

Select the programme to be deleted



#### To cancel a timer programming event temporarily

Select the programme to be cancelled

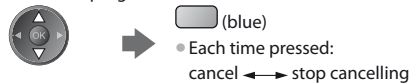

# Child Lock

You can lock specific channels / AV input terminals and control who watches them. When the locked channel / input is selected, a message appears; by entering the PIN number, you can watch it.



## 1 Display the menu



## 2 Select [Setup]

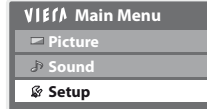

## 3 Select [Child Lock]

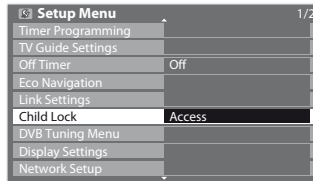

■ To return to TV

EXIT



## Control channel audience [Child Lock]

### 1 Enter the PIN number (4 digits)



- Enter the PIN number twice at first setting.
- Make a note of the PIN number in case you forget it.

### 2 Select [Child Lock List]



### 3 Select the channel / input to be locked

Name	Input	Type	Lock
101 BBC1 Wales	DVB	Free TV	🔒
2 BBC THREE	DVB	Free TV	🔒
14 E4C	DVB	Free TV	🔒
VCR	Analogue	Analogue	🔒
1 BBC1	Analogue	Analogue	🔒
2 ****	Analogue	Analogue	🔒
AV1	External	AV	🔒
AV2	External	AV	🔒



🔒: Appears when the channel / input is locked

• To lock all



(green)

• To cancel all locks



(yellow)

• To cancel

Select the locked channel / input



• To jump to the top of the next input



(blue)

### ■ To change the PIN number

#### 1. Select [Change PIN]



#### 2. Enter a new PIN number twice



### ■ To set Parental Rating Ireland only

If the DVB programme has the rated information for over the selected age, you have to enter the PIN number to watch (depending on the broadcaster).

Select [Parental Rating] and set an age for the restriction of programmes.

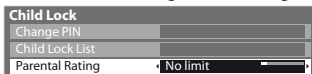

### Note

- Setting [Shipping Condition] (p. 47) erases the PIN number and all settings.

# Input Labels

For easier identification and selection of the input mode, you can label each input mode or skip terminals that are not connected to any equipment.

- To select the input mode → (p. 24)

Input Labels



■ To return to TV



## 1 Display the menu



## 2 Select [Setup]

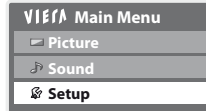

## 3 Select [Display Settings]

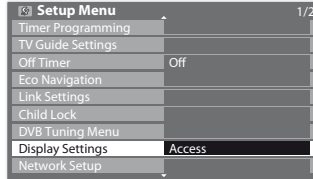

## 4 Select [Input Labels]



## 5 Select an input terminal

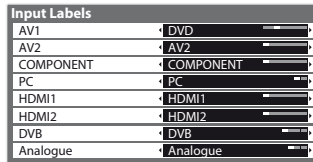

The labels you set will be displayed in the [Input Selection] menu (p. 24), [TV Selection] menu or banner.

- If [Skip] is selected, the input will not be displayed in the [Input Selection] menu and you cannot select the mode.

## ■ User input

You can name each input mode yourself.

### 1 Select [User input]



### 2 Set characters (maximum: ten characters)

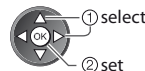
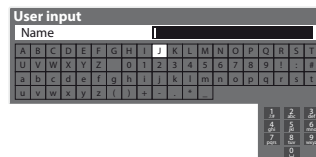

### 3 Store



- To use numeric buttons

➔ "Characters table for numeric buttons" (p. 72)

# Setup for Internet Connection

The ETHERNET terminal is for TV's software update. You can download a newer version of software through the internet, if it is available. ➔ (p. 46)

- To update the TV's software without internet connection ➔ "Updating the TV Software" (p. 50)

## Network connections

Connect the TV and the Broadband network equipment (modem, hub or router) by using a LAN cable.

- If you do not have a Broadband network services, please consult your retailer for assistance.
- Confirm the terms and conditions of the contracts with your Internet Service Provider (ISP) or telecommunications company.
- Set up and connect any equipment required for the network environment.
- Read the manual of the network equipment, too.

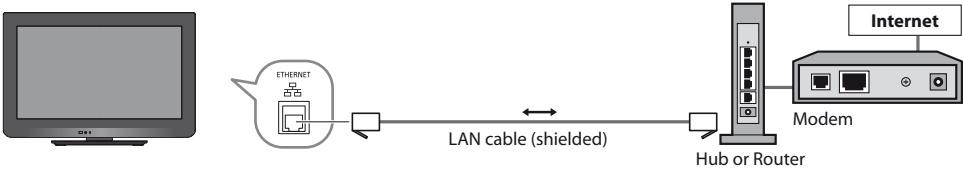

### Note

- Depending on the ISP or telecommunications company, the required equipment and the internet connection procedure are different. Ensure that you use the network equipment that are authorized by your ISP and telecommunications company.
- You cannot make settings for the network equipment on this TV. You may be required to make settings on your computer.
- Depending on the terms and conditions of the contracts with your ISP or telecommunications company, additional fees may be charged or multiple connections to the internet may be impossible.
- Please contact your ISP or telecommunications company if you require further assistance regarding the network equipment.

## [Network Setup]

Ensure the connections are completed before starting Network Setup.



### 1 Display the menu



### 2 Select [Setup]

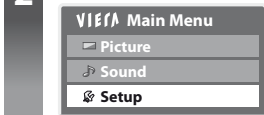

### 3 Select [Network Setup]

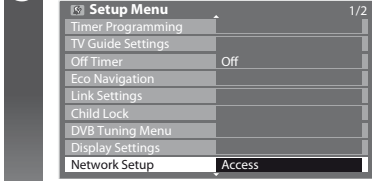

■ To return to TV



**Note**

**[MAC Address]**

- MAC address is a unique address that identifies hardware in the network. (for information only)

Network Setup	
Connection Test	
IP/DNS Settings	
Software Update	
MAC Address	ab-cd-ef-gh-ij-kl

## Connect to the network [Network Setup]

### 1 Select [IP/DNS Settings] and set the items



#### ■ To set [Acquire IP Address] / [Acquire DNS Address]

#### Select [Acquire IP Address] / [Acquire DNS Address] and set to [Auto]

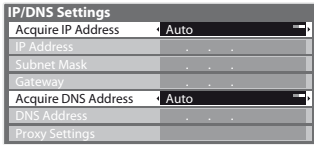

- The available settings are displayed automatically.
- For most users, the recommended method of connection to your network is by using [Auto] feature.

#### Manual settings

If you wish to set these functions manually, select [Manual].

Select [IP Address], [Subnet Mask], [Gateway], [Primary DNS] or [Secondary DNS]



➔ Move the cursor and enter the number



### 2 Select [Proxy Settings] and set the items

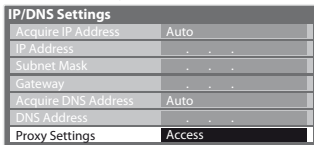

After settings, return to [Network Setup] screen



#### ■ To set [Proxy]

- This is the address of the relay server that is connected to the target server instead of the browser and sends data to the browser. Setting is required if specified by the provider.

1. Select [Proxy]

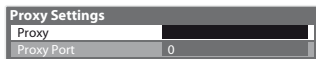

2. Enter the address

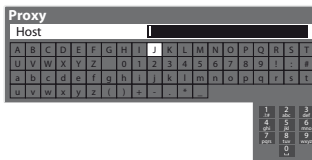

3. Store



- To use numeric buttons  
 ➔ "Characters table for numeric buttons" (p. 72)

#### ■ To set [Proxy Port]

- This number is also specified by the provider with the Proxy address.

1. Select [Proxy Port]

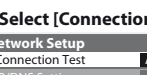

2. Move the cursor and enter the number

### 3 Select [Connection Test] and access to test

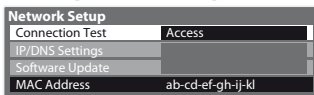

- Performs automatic testing of the network connection for the TV. (It takes a while to test.)



The test is successful and the TV is connected to the network.

Check the settings and connections, and then perform this function again.

## Update TV's software

Accesses the specific web site to update TV's software and search if any software updates are available.

### Select [Software Update]



- Follow the on screen instructions

# Shipping Condition

Resets the TV to its original condition with no channels tuned in.  
All settings other than [Owner ID] are reset (channels, picture, sound settings, etc.).

- To retune TV channels only, e.g. after moving house ➔ **"Retuning from Setup Menu"** (p. 36)



■ To return to TV

EXIT



## 1 Display the menu



## 2 Select [Setup]

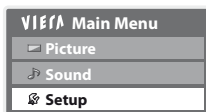

## 3 Select [System Menu]



## 4 Select [Shipping Condition]

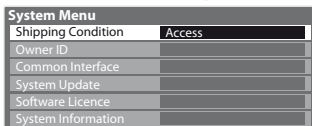

## Restore Settings [Shipping Condition]

### 1 Check the message and initialise

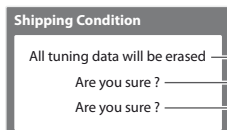

### 2 Follow the on screen instructions

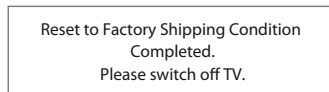

- [Auto Setup] will automatically start when Mains power On / Off switch is next turned On. (p. 12)

# Owner ID

Entry of the PIN number and personal information (your name, address and postcode).  
In the unfortunate event of theft, the Owner ID will help the Police to determine the owner.



## 1 Display the menu



## 2 Select [Setup]

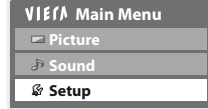

## 3 Select [System Menu]



## 4 Select [Owner ID]

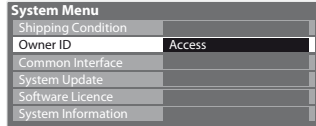

■ To return to TV



## Input owner ID [Owner ID]

### 1 Enter the PIN number (4 digits)



- Enter the PIN number twice at first setting.
- Make a note of the PIN number in case you forget it. The PIN number cannot be reset.

### 2 Select the item (NAME / HOUSE NO / POSTCODE) and set characters

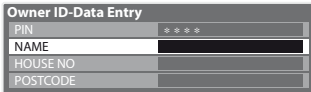

Return to select other items



- Select the next item and repeat the operations.

- To use numeric buttons
- ➔ "Characters table for numeric buttons" (p. 72)

### 3 Exit the menu



### ■ To check the personal information stored

Hold down for about 6 seconds

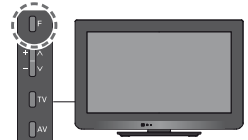

- The PIN number is not displayed.

### ■ To change the PIN number

#### 1. Select [PIN]

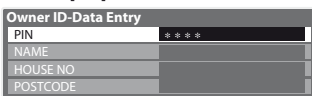

#### 2. Enter a new PIN number twice





# Using Common Interface

The Common Interface Module menu provides access to software contained on Common Interface (CI) Modules. This TV works only for Pay TV modules complying with CI standard.

- This function is not available for BskyB's Sky channels.
- Video and audio signals may not be output depending on broadcasts or services.

## Caution

- Turn Off Mains power On / Off switch whenever inserting or removing the CI module.
- If a viewing card and a card reader come as a set, first insert the card reader, then insert the viewing card into the card reader.
- Insert the module in the correct direction.

Side of the TV

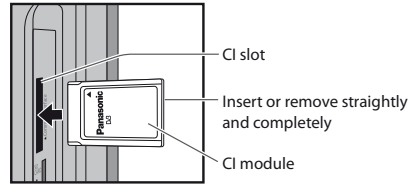

## Insert the CI module (optional)

- The features that appear on screen are dependent on the contents of the selected CI module.
- Follow the instructions that came with the viewing card to tune in the encrypted channels. If encrypted channels do not appear, perform the below to verify the card is recognised by the TV.
- For more details, see the manual of the CI module, or check with the broadcaster.



### 1 Select DVB



### 2 Display the menu



### 3 Select [Setup]

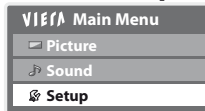

### 4 Select [System Menu]



### 5 Select [Common Interface]

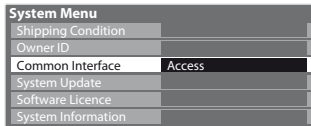

### 6 Access Common Interface



## ■ To return to TV

EXIT



## ■ How to operate services

Follow the on screen operation guide.  
(Check the instructions provided with the CI module.)

Example :

- Select, go



- Symbol : ◀▶▶▶▶



- Coloured characters



- On screen operation guide may not correspond to the remote control buttons.

# Updating the TV Software

From time to time, a new version of software may become available for download to enhance the performance or operations of the TV. In DVB mode, a notification banner will appear when one of the BBC channels is turned to if a new available software is found.

● To download



● If you choose not to download



You can update any new software automatically or manually.



## 1 Display the menu



## 2 Select [Setup]

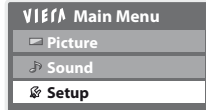

## 3 Select [System Menu]



## 4 Select [System Update]

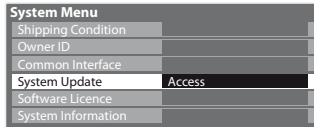

■ To return to TV



Updating the TV Software

### Update TV's software system [System Update]

■ To update automatically

Select [Auto Update Search in Standby] and set to [On]



- Automatically performs a search in standby and downloads an update, if any software updates are available.
- The automatic updating is performed at night under the following conditions:
  - Standby (TV turned Off with the remote control)
  - Recording of Timer Programming or Direct TV Recording is not in progress.

**If System Update is performed, the software will be updated (it may change TV functions). If you do not wish to do so, set [Auto Update Search in Standby] to [Off]. The notification banner will keep appearing during the period of new software availability, usually 2 to 3 days.**

■ To update immediately

#### 1 Select [System Update Search Now]



#### 2 Searches for an update (for several minutes) and displays a corresponding message if any

#### 3 Download



#### Note

- Download may take up to 60 minutes.
- During software download and update, DO NOT perform any operations on the TV or switch Off the TV.

# Displaying PC Screen on TV

The screen of the PC connected to the TV can be displayed on the TV.  
You can also listen to PC sound with the audio cable connected.

- To connect PC → p. 68



## 1 Select the external input

AV

## 2 Select [PC]

Input Selection
AV1
AV2
COMPONENT
PC
HDMI1
HDMI2
TV
SD Card



- Corresponding signals → p. 73
- If "H-freq." or "V-freq." is shown in red, the signals may not be supported.

■ To return to TV  
→ TV

- PC menu setting (changed as desired)
  - To make settings → "How to Use Menu Functions" (p. 27)

Menu	Item	Adjustments / Configurations (alternatives)	
Picture	Advanced Settings	White Balance	<b>R-Gain</b> Adjusts the white balance for red areas
			<b>G-Gain</b> Adjusts the white balance for green areas
			<b>B-Gain</b> Adjusts the white balance for blue areas
			<b>R-Cutoff</b> Adjusts the white balance for red areas
			<b>G-Cutoff</b> Adjusts the white balance for green areas
			<b>B-Cutoff</b> Adjusts the white balance for blue areas
			<b>Reset to Defaults</b> Press the OK button to reset to the default White Balance
	Gamma	<b>Gamma</b> Switches the gamma curve [1.8] / [2.0] / [2.2] / [2.4] / [2.6] • Please note the numerical values are reference for the adjustment.	
<b>Reset to Defaults</b> Press the OK button to reset to the default Gamma			
Setup	PC Setup	<b>Input Resolution</b> Switches to a wide view • VGA (640 × 480 pixels), WVGA (852 × 480 pixels), XGA (1,024 × 768 pixels), WXGA (1,280 × 768 pixels, 1,366 × 768 pixels) • Options change depending on signals	
		<b>Clock</b> Set to the minimum level if noise occurs	
	<b>H-pos</b> Adjusts horizontal position		
	<b>V-pos</b> Adjusts vertical position		
	<b>Clock Phase</b> Eliminates flicker and distortion • Adjust after Clock adjustment • Set to the minimum level if noise occurs		
	<b>Sync</b> Chooses another synchronous signal if the image is distorted [H & V] / [On Green] • H & V : by the horizontal and vertical signals from your PC • On Green : by the green signal from your PC (if available)		
	<b>Reset to Defaults</b> Press the OK button to reset to the default PC Setup settings		

- Other items → p. 28 - 32

### Note

- For HDMI-compatible PC, possible to connect to HDMI terminals (HDMI1 / HDMI2) by using HDMI cable (p. 72).

# Using Media Player

Media Player allows you to enjoy photo, video or music recorded on an SD Card.

VIERA IMAGE VIEWER is the function of the easy viewing for photos or videos recorded on an SD Card on the TV screen by simply inserting into the SD Card slot.

Photo mode : Still pictures recorded by digital cameras will be displayed.

Video mode : Moving pictures recorded by digital video cameras will be played back.

Music mode : Digital music data will be played back.

- During the operation, audio signal is output from AV1, AUDIO OUT, DIGITAL AUDIO OUT and HDMI2 (ARC function) terminals. But no video signals are output. AV1 can output audio signal if [AV1 out] is set to [Monitor] in the Setup Menu (p. 30). To use HDMI2 with ARC function, connect an amplifier that has ARC function (p. 60) and set to use theatre speakers (p. 66).
- [Date] shows the date on which the recording was made by the recording equipment. The file without record of the date is shown "\*\*\*/\*\*/\*\*\*\*\*"
- The picture may not appear correctly on this TV depending on the recording equipment used.
- Display may take some time when there are many files and folders.
- Partly degraded files might be displayed at a reduced resolution.
- The folder and file names may be different depending on the digital camera or digital video camera used.

## To insert or remove the SD Card

**■ SD Card**

**To insert the SD Card**

- ① Gently insert the SD Card label surface facing front.
- ② Push until a click is heard

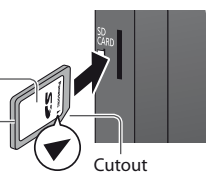

**To remove the SD Card**

Push the centre of the card





- For the information of the SD Card and supported file format ➔ (p. 71)

## Starting Media Player



### ■ To return to TV

EXIT or SD CARD

### ■ To return to the previous screen

RETURN

## 1 Insert the SD Card to the TV

➔ (see above)

## 2 Start Media Player

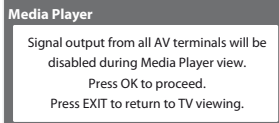

- Also possible by pressing following buttons.

SD CARD



AV ➔ "Watching External Inputs" (p. 24)

## 3 Select the content



- ① select
- ② access

[Photo] ➔ "Photo mode" (p. 53)

[Video] ➔ "Video mode" (p. 56)

[Music] ➔ "Music mode" (p. 58)

- You can also access each mode directly by using VIERA TOOLS.

➔ "How to Use VIERA TOOLS" (p. 26)

## Photo mode

Photo mode will read all ".jpg" extension files in the SD Card.



The thumbnail of all the photos in the SD Card will be displayed.  
Example : Thumbnail - [All photos]



: Error display

### ■ To return to TV



### ■ To return to the previous screen



- To change the back ground music ➔ **"Photo Settings"** (p. 54)
- To display the information of the highlighted photo



### ■ To sort by folder, recorded date or recorded month

#### 1 Display the view selection



#### 2 Select the sort type

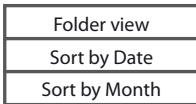

#### [Folder view] :

- Displays the thumbnail grouped by folder
- The files which are not into a folder will be collected to the folder named "/".

#### [Sort by Date] :

- Displays the thumbnail grouped by the same date
- The group of the photos without recorded date is shown as [Unknown].

#### [Sort by Month] :

- Displays the thumbnail grouped by the same month
- The group of the photos without recorded date is shown as [Unknown].

#### 3 Select one of the sorted groups to display the thumbnail of the selected group

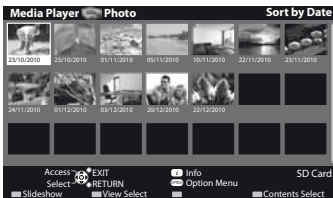

- To return to the thumbnail of all photos



- To display the information of the highlighted group

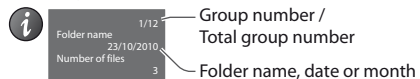

**[Single view]** - Photos are displayed one at a time.  
 Select the file from the thumbnail of photos to be viewed



Example :



Operation guide

- To display / hide the operation guide



- To return to thumbnail



- To operate Single view

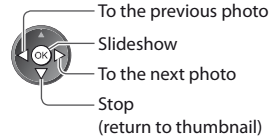

- To rotate 90°



**[Slideshow]** - Slideshow will complete when all photos have been viewed within the present thumbnail.

**1 Select the file from the thumbnail of photos for the first view**



- To display / hide the operation guide



**2 Start Slideshow**



- To pause (return to Single view)



- To return to thumbnail



## Photo Settings

Setup the settings for Photo mode.

**1 Display the option menu**



**2 Select [Slideshow Settings]**



**3 Select the items and set**

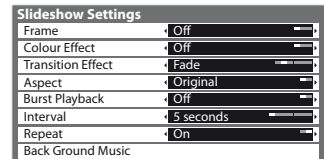

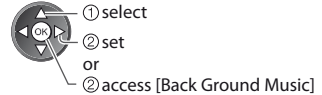

### Note

- Picture quality may become lower depending on the slideshow settings.
- Picture setting may not work depending on the slideshow settings.

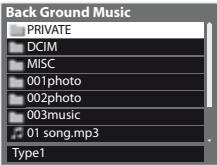

Menu	Item	Adjustments / Configurations (alternatives)
Slideshow Settings	Frame	Selects the frame type of the slideshow <b>[Off]</b> / <b>[Multi]</b> / <b>[Collage]</b> <b>[Multi]</b> : 9 photos are displayed orderly at once. <b>[Collage]</b> : Each photo is displayed at a random position and random scale.
	Colour Effect	Selects the colour effect of photos on Single view and Slideshow <b>[Off]</b> / <b>[Sepia]</b> / <b>[Gray scale]</b>

Menu	Item	Adjustments / Configurations (alternatives)
Slideshow Settings	Transition Effect	<p>Selects the transition effect for switching the photo during the slideshow  <b>[Off]</b> / <b>[Fade]</b> / <b>[Slide]</b> / <b>[Dissolve]</b> / <b>[Motion]</b> / <b>[Random]</b>  <b>[Fade]</b> : The next photo fades in gradually.  <b>[Slide]</b> : The next photo slides and appears from the left side.  <b>[Dissolve]</b> : Each photo is dissolved when switching to the next photo.  <b>[Motion]</b> : Each photo is displayed with an effect of enlarging, reducing, moving up or moving down.  <b>[Random]</b> : Each transition is selected at random.            ● This function is available when [Frame] is set to [Off].</p>
	Aspect	<p>Selects whether enlarged or normal viewing on Single view and Slideshow  <b>[Original]</b> / <b>[Zoom]</b>            ● This function is not available when [Frame] is set to [Collage].            ● This function is not available when [Transition Effect] is set to [Motion].            ● Depending on the photo size, it may not be fully enlarged to fill the screen, e.g. portrait style picture.</p>
	Burst Playback	<p>Selects whether to display burst photos in a fast-paced slideshow mode  <b>[Off]</b> / <b>[On]</b>            ● This function is not available when [Transition Effect] is set to [Motion].</p>
	Interval	<p>Selects slideshow interval <b>[5]</b> / <b>[10]</b> / <b>[15]</b> / <b>[30]</b> / <b>[60]</b> / <b>[90]</b> / <b>[120]</b> (seconds)            ● This function is not available when [Transition Effect] is set to [Motion].</p>
	Repeat	<p>Slideshow repeat <b>[Off]</b> / <b>[On]</b></p>
	Back Ground Music	<p>Selects the back ground music during Photo mode  <b>[Off]</b> / <b>[Type1]</b> / <b>[Type2]</b> / <b>[Type3]</b> / <b>[User]</b> / <b>[Auto]</b>            ● [Type1], [Type2] and [Type3] are the fixed music each installed in this TV.  <b>[User]</b> : Music data in the SD Card registered by yourself will be played back.  <b>To register the music</b>            1. Select the music file            Depending on the conditions of the SD Card, select folders until you reach the desired music file.</p> <div style="display: flex; justify-content: space-around;"> <div style="text-align: center;">  <p>① select ② access</p> </div> <div style="text-align: center;">  <p>2. Select [File] or [Folder]</p>  <p>① select ② set</p> </div> </div> <p><b>[File]</b> : The selected music file will be registered as back ground music.  <b>[Folder]</b> : All the music in the folder which contains the selected music file will be registered as back ground music.</p> <ul style="list-style-type: none"> <li>● If no music has been registered or the SD Card which has the registered music is removed, no sound will be produced.</li> </ul> <p><b>[Auto]</b> : Music data stored in the root folder of the SD Card will be played back randomly.</p> <ul style="list-style-type: none"> <li>● If there is no available music data, no sound will be produced.</li> </ul>

## Change the contents

You can switch to the other mode of Media Player from the thumbnail view.

### 1 While the thumbnail is displayed, display the contents selection

 (blue)

### 2 Select the contents



[Photo] ➔ **"Photo mode"** (p. 53)  
 [Video] ➔ **"Video mode"** (p. 56)  
 [Music] ➔ **"Music mode"** (p. 58)

## Video mode

Supported file formats → (p. 71)



The thumbnail of video titles in the SD Card will be displayed.

Example : Thumbnail - [Title view]

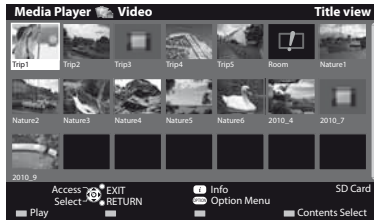

: Error display

: The file does not support thumbnail view.

- To view the scenes of the title

**Select the title**

Example : Thumbnail - [Scene view]



① select  
 ② access

### ■ Playback from Title view

Playback of the selected title will start.

- To repeat playback → "Video Setup" (p. 57)

**1 Select the title**



**2 Start playback**

(red)

### ■ Playback from the selected scene in the title (SD Video or AVCHD)

Playback will start from the selected scene to the end of the title.

- To repeat playback → "Video Setup" (p. 57)

**1 Select the title**



**2 Select the scene**



**3 Start playback**

(red)

### Note

- The structure of titles and scenes may vary depending on the digital video camera used.

### ■ How to operate in the playback

Example : Playback



Operation guide

Information banner

- To display / hide the operation guide and information banner



- To operate the playback

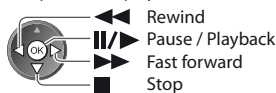

- You can also use the following buttons.

Set the code of the remote control to "73" (p. 25)



- To change aspect

ASPECT



- To the previous title / scene

(red)

- To the next title / scene

(green)

- To return to thumbnail

RETURN



The preview will start when the title is highlighted if it supports a preview.

- To turn off the preview → "Video Setup" (p. 57)
- To display the information of the highlighted title

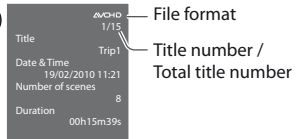

File format

Title number / Total title number

The preview will start when the scene is highlighted if it supports a preview.

- To turn off the preview → "Video Setup" (p. 57)
- To display the information of the highlighted scene

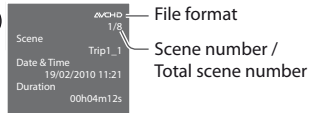

File format

Scene number / Total scene number



## Video Setup

Setup the settings for Video mode.

### 1 Display the option menu in the thumbnail view

OPTION



### 2 Select [Video Setup]



### 3 Select the items and set

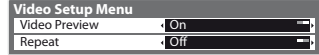

Menu	Item	Adjustments / Configurations (alternatives)
Video Setup	Video Preview	Sets to start the preview of the title or scene in the thumbnail view <b>[Off]</b> / <b>[On]</b> <ul style="list-style-type: none"> <li>Image may not be displayed for an instant in the thumbnail view. Set the preview <b>[Off]</b> to resolve this.</li> </ul>
	Repeat	Playback repeat within the title <b>[Off]</b> / <b>[On]</b>

## Confirm or change the current status

You can confirm or change the current status of the content.

- Menu items and selectable options vary depending on the content.

### 1 Display the option menu during playback

OPTION



### 2 Select [Video Setup]



### 3 Select the items and set

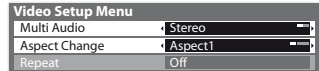

Menu	Item	Adjustments / Configurations (alternatives)
Video Setup	Multi Audio	Allows you to select between selectable sound tracks (if available) <ul style="list-style-type: none"> <li>It may take several seconds to change the sound.</li> </ul>
	Aspect Change	<b>[Aspect1]</b> : Displays the content full-screen <b>[Aspect2]</b> : Displays the content square <b>[Original]</b> : Displays the content original size <ul style="list-style-type: none"> <li>You can also change the aspect using the ASPECT button.</li> <li>Aspect change may not work depending on the content.</li> </ul>

## Audio output Settings

You can enjoy the multi-channel sound via an amplifier connected to DIGITAL AUDIO OUT terminal.

- To confirm or change the current sound status ➔ (see above)

### 1 Display the menu

MENU

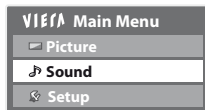

### 3 Select [SPDIF Selection] and set



Menu	Item	Adjustments / Configurations (alternatives)
Sound	SPDIF Selection	SPDIF : A standard audio transfer file format Selects the initial setting for digital audio output signal from DIGITAL AUDIO OUT and HDMI2 (ARC function) terminals <b>[Auto]</b> / <b>[PCM]</b> <b>[Auto]</b> : Dolby Digital is output as Dolby Digital Bitstream. MPEG is output as PCM. <b>[PCM]</b> : Digital output signal is fixed to PCM.

## Music mode

Supported file formats → (p. 71)



The thumbnail of music folders in the SD Card will be displayed.

Example : Thumbnail - [Folder view]

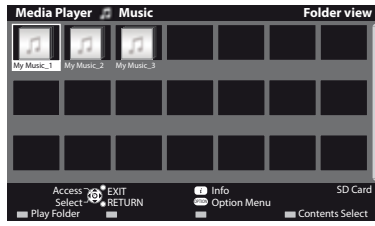

- To display the information of the highlighted folder

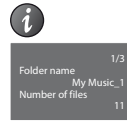

Folder number / Total folder number

### To return to TV

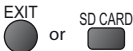

### To return to the previous screen



### Playback from Folder view

All the files in the selected folder will be played back.

#### 1 Select the folder



#### 2 Start playback



### Playback from File view

Selected file will be played back.

#### 1 Select the folder



#### 2 Select the file

Example : Thumbnail - File view

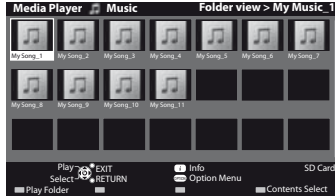

#### 3 Start playback



- To display the information of the highlighted file

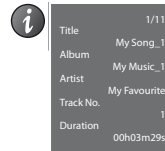

File number / Total file number

### How to operate in the playback

Example : Playback

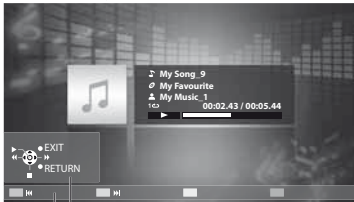

- To display / hide the operation guide



- To operate the playback

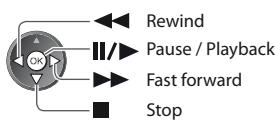

- To the previous track



- To the next track



- To return to thumbnail



Operation guide

### To change the content → "Change the contents" (p. 55)

## Music Setup

Setup the setting for Music mode (only available in the thumbnail view).

#### 1 Display the option menu



#### 2 Select [Music Setup]



#### 3 Set



[Folder] : Playback repeat within the selected folder

[One] : Playback repeat of the selected one file

# Link Functions (Q-Link / VIERA Link)

Q-Link connects the TV and DVD Recorder / VCR, and enables easy recording, playback, etc. ➔ (p. 61)

VIERA Link (HDAVI Control™) connects the TV and the equipment with VIERA Link function, and enables easy control, convenient recording, playback, energy saving, creation of a home theatre, etc., without complicated setting. ➔ (p. 62 - 66)

You can use Q-Link and VIERA Link functions together.

- This TV supports "HDAVI Control 5" function. But available features are depending on the connected equipment's version of HDAVI Control. Please refer to the manual of the equipment to confirm the version.
- VIERA Link features may be available even with other manufacturers' equipment supporting HDMI CEC.

## Summary of Q-Link and VIERA Link features

### Q-Link (SCART connection only)

Connected equipment	DVD Recorder / VCR with Q-Link function
Features	
Analogue channel download	○
Easy playback	○
Power on link	○
Power off link	○
Direct TV Recording	○

#### Connection

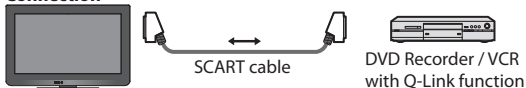

- Use a fully wired SCART cable.
- Connect the DVD Recorder / VCR supporting Q-Link to the TV's AV1 terminal via a SCART cable.

### VIERA Link (HDMI connection only)

Connected equipment	DIGA Recorder with VIERA Link function	DVD Player / Blu-ray Disc Player with VIERA Link function	HD Video Camera / LUMIX Camera with VIERA Link function
Features			
Analogue channel download	—	—	—
Easy playback	○	○	○
Power on link	○	○	○
Power off link	○	○	○
Reduce unnecessary power consumption in standby	○*3	○*3	—
Auto standby for unnecessary equipment	○*3	○*3	—
Pause Live TV programme	○*2 *4	—	—
Direct TV Recording	○*2	—	—
Control the menu of the connected equipment by VIERA remote control	○*1	○*1	○*1
Speaker control	—	—	—

#### Connection

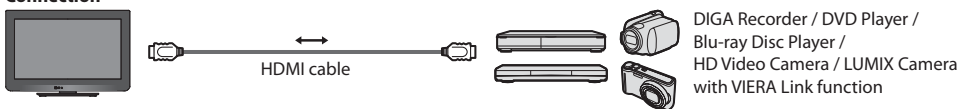

- Use a fully wired HDMI compliant cable.
- Connect the equipment supporting VIERA Link to the TV's HDMI1 or HDMI2 terminal via an HDMI cable.
- For information about using HDMI cables for connecting Panasonic HD Video Camera or LUMIX Camera, read the manual of the equipment.

### VIERA Link (HDMI and SCART connections)

Connected equipment	DIGA Recorder with VIERA Link function
Features	
Analogue channel download	○
Easy playback	○
Power on link	○
Power off link	○
Reduce unnecessary power consumption in standby	○*3
Auto standby for unnecessary equipment	○*3
Pause Live TV programme	○*2 *4
Direct TV Recording	○*2
Control the menu of the connected equipment by VIERA remote control	○*1
Speaker control	—

#### Connection

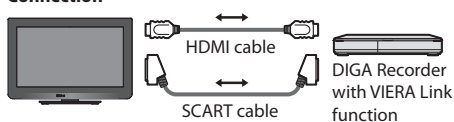

- Use a fully wired HDMI compliant cable.
- Connect the equipment supporting VIERA Link to the TV's HDMI1 or HDMI2 terminal via an HDMI cable.
- Use a fully wired SCART cable.
- Connect the equipment supporting VIERA Link to the TV's AV1 terminal via a SCART cable.

## VIERA Link (HDMI and Audio out connections)

Connected equipment	Player theatre with VIERA Link function	Blu-ray Disc theatre with VIERA Link function	Amplifier with VIERA Link function
Features			
Analogue channel download	–	–	–
Easy playback	○*5	○*5	–
Power on link	○	○	–
Power off link	○	○	○
Reduce unnecessary power consumption in standby	–	○*3	–
Auto standby for unnecessary equipment	○*3 *6	○*3 *6	○*3
Pause Live TV programme	–	–	–
Direct TV Recording	–	–	–
Control the menu of the connected equipment by VIERA remote control	○*1	○*1	–
Speaker control	○	○	○

### Connection

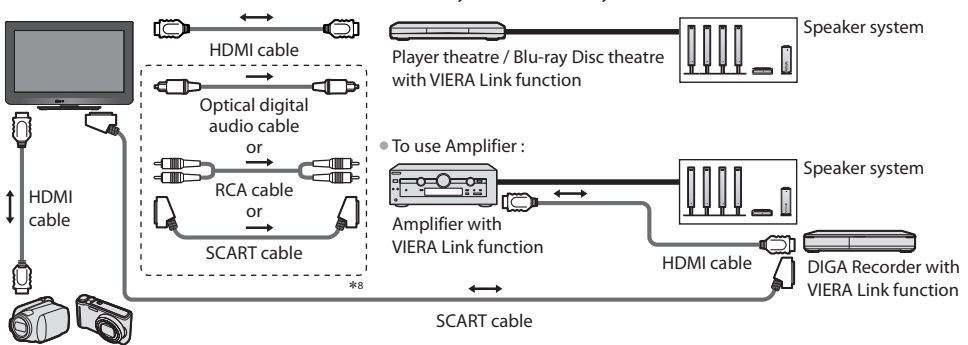

HD Video Camera / LUMIX Camera with VIERA Link function

- Use fully wired HDMI compliant cable.
- Connect the equipment supporting VIERA Link to the TV's HDMI2 terminal via an HDMI cable.
- Use fully wired SCART cable.
- If you use a SCART cable for audio output, connect the equipment supporting VIERA Link to the TV's AV1 terminal and set [AV1 out] to [Monitor] in the Setup Menu (p. 30).
- Use the optical digital audio cable, RCA cable or SCART cable for audio output from the TV.

\*1 : Available with the equipment which has "HDAVI Control 2 or later" function.

\*2 : Available with the equipment which has "HDAVI Control 3 or later" function.

\*3 : Available with the equipment which has "HDAVI Control 4 or later" function.

\*4 : Available with DIGA Recorder which has HDD.

\*5 : While playing a disc

\*6 : Except for watching a disc

\*7 : If the connected equipment has "HDAVI Control 5" function, you do not have to use this audio cable (Optical digital audio cable, RCA cable or SCART cable). In this case, connect the equipment to the TV's HDMI2 terminal via an HDMI cable.

### VIERA Link Control of compatible equipment ([VIERA Link Control] ➔ p. 64)

- Table below displays maximum number of compatible equipment that can be controlled by VIERA Link Control. This includes connections to equipment already connected to the TV. For example, DIGA Recorder connected to Amplifier which is connected to the TV via an HDMI cable.

Type of the equipment	Maximum number
Recorder (DIGA Recorder, etc.)	2
Player (DVD Player, Blu-ray Disc Player, HD Video Camera, LUMIX Camera, Digital Camera, Player theatre, Blu-ray Disc theatre, etc.)	2
Audio system (Player theatre, Blu-ray Disc theatre, Amplifier, etc.)	1
Tuner (Set top box, etc.)	3

**Preparations**

- Connect the DVD Recorder / VCR with the following logos: "Q-Link", "NEXTVIEWLINK", "DATA LOGIC (a trademark of Metz Corporation)", "Easy Link (a trademark of Philips Corporation)", "Megalagic (a trademark of Grundig Corporation)" or "SMARTLINK (a trademark of Sony Corporation)"
- Q-Link connection ➔ (p. 59)
- Use fully wired SCART cable.
- Set up the DVD Recorder / VCR. Read the manual of the recorder.
- Q-Link terminal setup in the Setup Menu ➔ [AV1 out] (p. 30)
- Download Analogue channel setting ➔ "Analogue channel download" (see below)

**Features available**

**Analogue channel download**

Analogue channel settings can be downloaded to a recorder with an analogue tuner (where Analogue is still broadcast). Digital channel settings are not downloaded.

- To download the Analogue channel settings ➔ [Q-Link Download] (p. 30) or [Auto Setup] in Analogue mode (p. 36) or "Auto Setup" - when first using the TV (p. 12)

**Direct TV Recording** - What you see is What you record

Recording the current programme on a DVD Recorder / VCR immediately.



- Available conditions:

Picture source	Mode	Recording from
Analogue	TV	TV monitor out
	AV	Recorder's tuner
DVB	TV	TV monitor out
AV (watching recorder's tuner)	AV	Recorder's tuner
AV (watching recorder's external input)	AV	Recorder's external input
AV (watching TV's external input)	AV	TV monitor out

- When Direct TV Recording is performed, the recorder is automatically turned on if it is in Standby mode.
- Changing channel or turning off the TV is available while the recorder is recording from its own tuner.
- Changing channel is not available while the recorder is recording from the TV tuner.

**■ To stop recording**

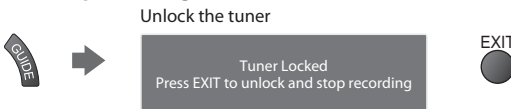

**Power on link and Easy playback**

When the DVD Recorder / VCR starts playback or the direct navigator / function menu for the equipment is activated, the TV is turned on and the input mode is switched automatically so that you can view the content. (Only when the TV is in Standby mode.)

**Power off link**

When the TV is set to Standby mode, the recorder is also automatically set to Standby. (Only when the videocassette or disc is not active.)

- This function will work even if the TV enters Standby mode automatically by auto power standby function.

**Note**

- Some recorders are not compatible. Read the manual of the recorder.

## VIERA Link "HDAVI Control"™/®

\***Enjoy additional HDMI Inter-Operability with Panasonic products which have "HDAVI Control" function.**

This TV supports "HDAVI Control 5" function.

Connections to the equipment (DIGA Recorder, HD Video Camera, Player theatre, Amplifier, etc.) with HDMI and SCART cables allow you to interface them automatically (p. 59, 60).

These features are limited to models incorporating "HDAVI Control" and "VIERA Link".

- Some functions are not available depending on the equipment's version of HDAVI Control. Please confirm the connected equipment's version of HDAVI Control.
- VIERA Link "HDAVI Control", based on the control functions provided by HDMI which is an industry standard known as HDMI CEC (Consumer Electronics Control), is a unique function that we have developed and added.  
As such, its operation with other manufacturers' equipment that supports HDMI CEC cannot be guaranteed.
- Please refer to individual manuals for other manufacturers' equipment supporting VIERA Link function.
- For information about applicable Panasonic equipment, consult your local Panasonic dealer or refer to [www.panasonic.co.uk](http://www.panasonic.co.uk)

### Preparations

- Connect the equipment that supports VIERA Link.
  - VIERA Link connection ➔ (p. 59, 60)  
Use a fully wired HDMI compliant cable. Non-HDMI-compliant cables cannot be utilised.  
Recommended Panasonic HDMI cables' part numbers:
    - RP-CDHS15 (1.5 m)
    - RP-CDHS30 (3.0 m)
    - RP-CDHS50 (5.0 m)
  - Use a fully wired SCART cable.
  - Set up the connected equipment. Read the manual of the equipment.
  - For optimal recording, the settings of the recorder may need to be changed. For details, read the manual of the recorder.
  - Download Analogue channel setting ➔ **"Analogue channel download"** (see below)
  - Set [VIERA Link] [On] in the Setup Menu ➔ **[VIERA Link]** (p. 30)
  - Set up the TV
    - ➔ **After connection, turn the equipment on and then switch the TV on.**  
**Select the input mode to HDMI1 or HDMI2 (p. 24), and make sure that an image is displayed correctly.**
- This setup should be done each time when the following conditions occur:
- for the first time
  - when adding or reconnecting equipment
  - when changing setup

### Features available

#### Analogue channel download

Analogue channel settings can be downloaded to a recorder with an analogue tuner (where Analogue is still broadcast). Digital channel settings are not downloaded.

- To download the Analogue channel settings ➔ **[Q-Link Download]** (p. 30) or **[Auto Setup] in Analogue mode (p. 36) or "Auto Setup" - when first using the TV (p. 12)**

#### Easy playback

Automatic Input switching - When the connected equipment is operated (during playback or menu operations, etc.), the input mode is switched automatically. When playback is stopped or menus are exited, the input mode returns to the original setting.

#### Power on link

When the connected equipment starts playback or the direct navigator / function menu for the equipment is activated, the TV is automatically turned on and the input mode is switched automatically so that you can view the content. (Only when the TV is in Standby mode.)

#### Power off link

When the TV is set to Standby mode, the connected equipment is also automatically set to Standby.

- This function will work even if the TV enters Standby mode automatically by auto power standby function.

## Reduce unnecessary power consumption in standby [Standby Power Save]

### Set Standby Power Save [On] in the Setup Menu to use this function ➔ [Standby Power Save] (p. 30)

The power consumption in Standby mode of the connected equipment is controlled in synchronization with the TV On / Off state.

When the TV is set to Standby mode, the connected equipment is automatically set to Standby and the power consumption in Standby mode of the connected equipment is automatically minimised.

When the TV is turned on and the connected equipment is still in Standby mode, the power consumption of the connected equipment is increased to reduce the startup time.

- This function is effective if the connected equipment can change the power consumption in Standby mode and is set to higher consumption.

## Auto standby for unnecessary equipment [Intelligent Auto Standby]

### Set Intelligent Auto Standby [On (With reminder)] or [On (No reminder)] in the Setup Menu to use this function ➔ [Intelligent Auto Standby] (p. 30)

When the TV is On, non-watched or non-used connected equipment goes into Standby mode automatically to reduce power consumption. For example, when the input mode is switched from HDMI, the connected equipment will go into Standby mode / when Speaker Selection is changed to [TV], the Player theatre will go into Standby mode (except when watching a disc).

- If you select [On (With reminder)], the on screen message will be displayed before the connected equipment turns to Standby.
- This function may not work properly depending on the connected equipment. If required, set to [Off].

## Direct TV Recording - What you see is What you record [Direct TV Rec]

Recording the current programme on a DIGA Recorder immediately.

- If you connect a variety of recorders including other manufacturers' recorders at the same time, please connect the DIGA Recorder to the TV's lower HDMI terminal number. For example, if you use HDMI1 and HDMI2 for two recorders, connect the DIGA Recorder to HDMI1.
- If Direct TV Recording does not operate, check the settings and the equipment ➔ "Summary of Q-Link and VIERA Link features" (p. 59, 60), "Preparations" (p. 62)
- If you wish to record a programme that the DIGA Recorder does not support, a SCART connection is required and the programme is recorded by Q-Link function (p. 61).
- Depending on the programme, a SCART connection may be required to record.
- Changing channel or turning off the TV is available while the recorder is recording from its own tuner.
- Changing channel is not available while the recorder is recording from the TV tuner.



1



### Display [VIERA Link Menu]

2

### Select [Direct TV Rec] and start recording

VIERA Link Menu	
Pause Live TV	Start
Direct TV Rec	Stop
VIERA Link Control	Recorder
Speaker Selection	Home Cinema



- You can also start recording directly.



### ■ To stop recording

Select [Stop] in [Direct TV Rec]

VIERA Link Menu	
Pause Live TV	Start
Direct TV Rec	Stop
VIERA Link Control	Recorder
Speaker Selection	Home Cinema



- You can also stop recording directly.

Unlock the tuner



Tuner Locked  
Press EXIT to unlock.  
Any timer programme in progress will also be deleted.



## Pause Live TV programme [Pause Live TV]

You can pause the live TV programme and resume the programme later.

The live TV programme will be recorded on HDD of the connected DIGA Recorder.

- This function is available with a DIGA Recorder which has HDD.
- If you connect a variety of recorders including other manufacturers' recorders at the same time, please connect the DIGA Recorder which has HDD to the TV's lower HDMI terminal number. For example, if you use HDMI1 and HDMI2 for two recorders, connect the DIGA Recorder which has HDD to HDMI1.
- If Pause Live TV does not operate, check the settings and the equipment
  - ➔ "Summary of Q-Link and VIERA Link features" (p. 59, 60), "Preparations" (p. 62)



### 1 Display [VIERA Link Menu]

### 2 Select [Pause Live TV] and pause

The TV picture will be paused.

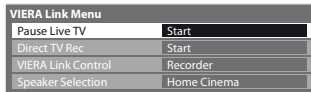

- Live TV programme is recorded on HDD from where it was paused.
- If the paused TV picture disappears after a few minutes.

OPTION

(the paused picture will be restored)

- Follow the operation guide to operate Pause Live TV function.

### ■ To operate Pause Live TV

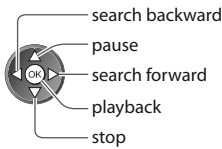

- Operations may be different depending on the recorder. In this case, follow the operation guide or read the manual of the recorder.

### ■ To return to Live TV (stop playback of Pause Live TV / cancel pause)

Select [Yes]



- If you stop playback or cancel pause, the recorded programme will be deleted from HDD.

## Control the menu of the connected equipment by VIERA remote control [VIERA Link Control]

You can control some functions of the connected equipment with this TV remote control (point the remote control at the TV's signal receiver).

- If you cannot operate the menu of the connected equipment, check the settings and the equipment
  - ➔ "Summary of Q-Link and VIERA Link features" (p. 59, 60), "Preparations" (p. 62)
- For details of the operations for the connected equipment, read the manual of the equipment.



### 1 Display [VIERA Link Menu]

### 2 Select [VIERA Link Control]

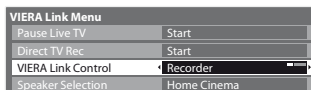



### 3 Select the equipment you want to access

The type of the connected equipment is displayed.  
Select the type of the equipment and access.

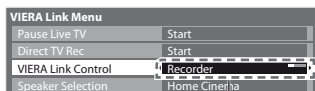

[Recorder] / [Player] / [Home Cinema] / [Video Camera] / [LUMIX] / [Digital Camera] / [Other]

- You can also access directly by using VIERA TOOLS ➔ “How to Use VIERA TOOLS” (p. 26)
- The displayed item may vary depending on the connected equipment.
- [Home Cinema] means Player theatre, Blu-ray Disc theatre or Recorder theatre.
- [Other] means Tuner set top box.

**The menu of the accessed equipment** (Input mode will be changed automatically)

### 4 Operate the menu of the equipment

Available VIERA remote control buttons:  
(depending on the connected equipment)



#### 1 Set the code of the remote control to “73”

➔ “How to change the code for the type of the equipment” (p. 25)

#### 2 Follow the operation guide

- To display the operation guide



If other manufacturers' equipment is accessed, Setup / Contents Selection menu may be displayed.

- When the key words are displayed on colour bar

 (red)  (green)  (yellow)  (blue)

#### Note

- Some operations may not be available depending on the equipment. In this case use its own remote control to operate the equipment.

#### ■ If multiple recorders or players are connected



[Recorder1-2 / Player1-2]

The number is given from the TV's lower HDMI terminal number connected to the same type equipment. For example, two recorders to HDMI1 and HDMI2, in this case the recorder connected to HDMI1 is displayed as [Recorder1], and the recorder connected to HDMI2 is displayed as [Recorder2].

#### ■ If you access non-VIERA Link equipment

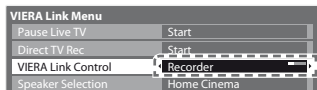

The type of the connected equipment is displayed.  
You can access the menu of the equipment. But you cannot operate it. Use its own remote control to operate the equipment.

## Speaker control [Speaker Selection]

You can control the home theatre speakers with this TV remote control (point the remote control at the TV's signal receiver).

- If you cannot operate, check the settings and the equipment
  - ➔ "Summary of Q-Link and VIERA Link features" (p. 59, 60), "Preparations" (p. 62)



### 1 Display [VIERA Link Menu]



### 2 Select [Speaker Selection]

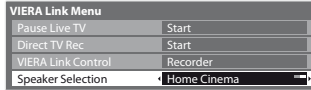

### 3 Set to [Home Cinema] or [TV]



#### [Home Cinema]

The Player theatre, Blu-ray Disc theatre or Amplifier will be automatically turned on if it is in Standby mode and the sound will be output from theatre speakers connected to the equipment.

- Volume up / down



- Mute



- The sound of the TV speakers is muted.
- When the equipment is turned off, the TV speakers will be activated.

#### [TV]

TV speakers are active.

### Multi-channel sound

If you wish to enjoy multi-channel sound (e.g. Dolby Digital 5.1ch) via an Amplifier, connect the Amplifier to the TV with an HDMI cable and an Optical digital audio cable (p. 60), and then select "Home Cinema". If your Amplifier has "HDAVI Control 5" function, you only need to connect with an HDMI cable. In this case, connect your Amplifier to the TV's HDMI2 terminal.

To enjoy the sound from the DIGA Recorder in multi-channel sound, connect an HDMI cable from the DIGA Recorder to the Amplifier (p. 60).

#### Note

- These functions may not work properly depending on the connected equipment.
- Image or sound may not be available for the first few seconds when input mode is switched.
- Easy playback may be available by using the remote control for Player theatre, Blu-ray Disc theatre or Amplifier. Read the manual of the equipment.
- "HDAVI Control 5" is the newest standard (current as of December, 2010) for HDAVI Control compatible equipment. This standard is compatible with conventional HDAVI equipment.
- To confirm this TV's version of HDAVI Control ➔ [System Information] (p. 32)

# External Equipment

These diagrams show our recommendations for connection of your TV to various pieces of equipment. For other connections, consult the instructions for each piece of equipment, the table below, and the specifications (p. 82 - p. 83).

## Types of connectable equipment to each terminal

Recording / Playback (equipment)	Terminal					
	AV1	AV2	COMPONENT	AUDIO OUT	DIGITAL AUDIO OUT	HDMI 1 - 2
To record / playback videocassettes / DVDs (VCR / DVD Recorder)	○					
To watch satellite broadcasts (Set top box)	○	○				○*1
To watch DVDs (DVD Player)	○	○	○			○
To watch camcorder images (Video camera)	○	○				○
To play games (Game equipment)	○	○				○
To use amplifier with speaker system				○	○	○*2
Q-Link	○					
VIERA Link	○ (with HDMI)					○
Direct TV Recording	○					○

○ : Recommended Connection

\*1 : Use HDMI1 for automatic input switching.

\*2 : Use HDMI2 for connecting an amplifier. This connection is applicable when using an amplifier that has ARC (Audio Return Channel) function.

### To record / playback

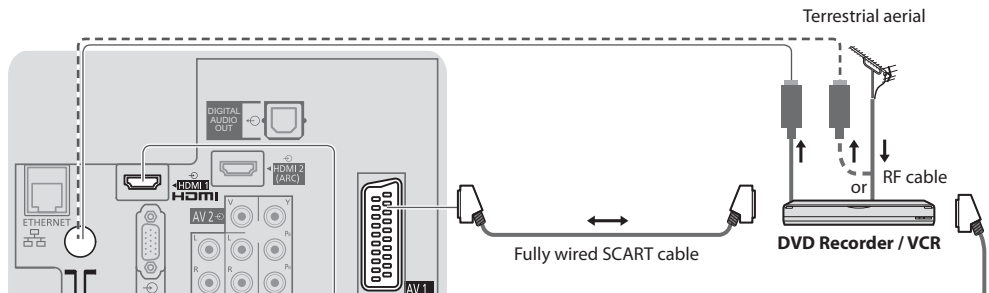

### To watch satellite broadcasts

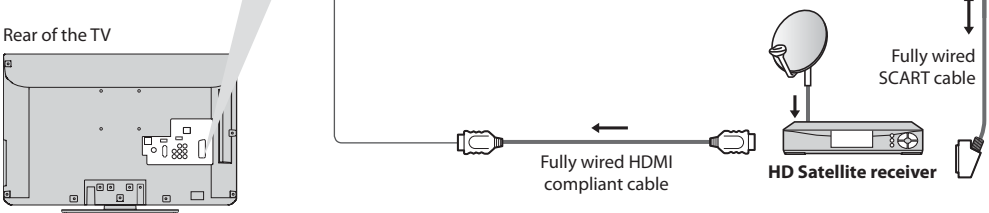

Rear of the TV

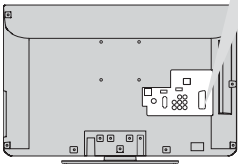

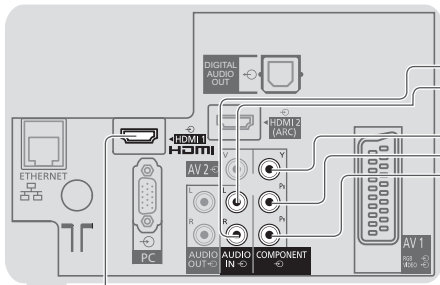

**To watch DVDs**

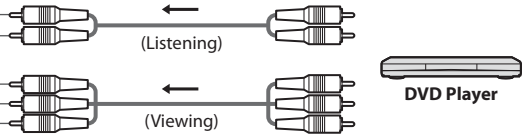

**HDMI equipment**

• HDMI connection ➔ (p. 72)

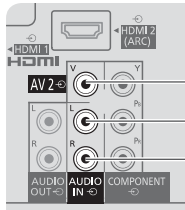
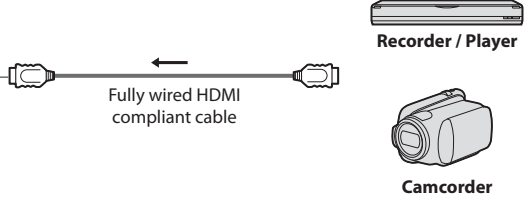

**Camcorder / Game equipment**

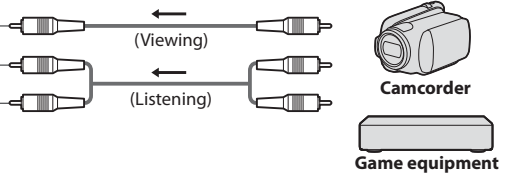

**PC**

• PC connection ➔ (p. 74)

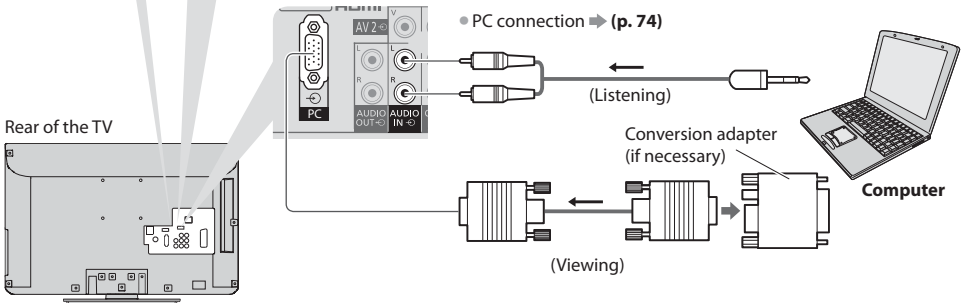

## To listen with speakers

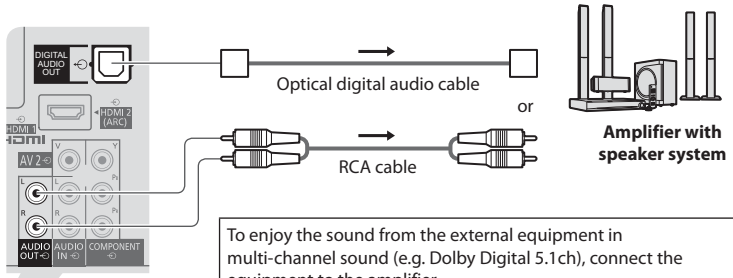

To enjoy the sound from the external equipment in multi-channel sound (e.g. Dolby Digital 5.1ch), connect the equipment to the amplifier. For the connections, read the manuals of the equipment and amplifier.

Rear of the TV

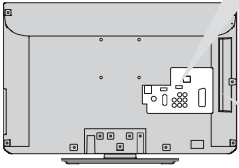

## Headphones

- To adjust volume ➔ **[Headphone Volume]** (p. 29)

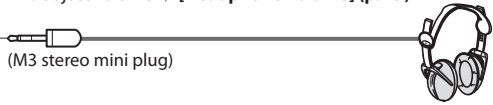

# Technical Information

## Auto Aspect

The optimum size and aspect can be chosen automatically, and you can enjoy finer images. ➔ (p. 17)

### Aspect Control Signal

[WIDE] will appear in the top left of the screen if a Widescreen signal (WSS) or a Control signal through SCART / HDMI terminal is found.

The aspect will switch to the appropriate 16:9 or 14:9 widescreen ratio.

This function will work in any aspect mode.

Input terminal	Input signal format	Aspect Control Signal	
		Widescreen signal (WSS)	Control signal through SCART (pin8) / HDMI terminal
RF	DVB	○	
	PAL I	○	
	PAL 525/60 6.0 MHz	-	
	M.NTSC 6.0 MHz	-	
AV1 / AV2 (Composite)	PAL	○	○
	PAL 525/60	-	○
	M.NTSC	-	○
	NTSC	-	○
COMPONENT	525 (480) / 60i, 60p	-	
	625 (576) / 50i, 50p	○	
	750 (720) / 60p, 50p	-	
	1,125 (1,080) / 60i, 50i	-	
HDMI1 HDMI2	525 (480) / 60i, 60p	-	○
	625 (576) / 50i, 50p	-	○
	750 (720) / 60p, 50p	-	○
	1,125 (1,080) / 60i, 50i	-	○
	1,125 (1,080) / 60p, 50p, 24p	-	○

### Auto mode

Auto mode determines the best aspect ratio to fill the screen. It does this using a four step process (WSS, Control signal through SCART / HDMI terminal, Letterbox detection or Justify to fill the screen).

This process may take several minutes, depending on the darkness of the image.

Letterbox detection:

If black bands at the top and bottom of the screen are detected, Auto mode chooses the best ratio and expands the image to fill the screen.

If no aspect signals are detected, Auto mode enhances the image for optimum viewing pleasure.

#### Note

- The ratio varies depending on the programme, etc. If the ratio is out of the standard 16:9, black bands at the top and bottom of the screen may appear.
- If the screen size looks unusual when a widescreen-recorded programme is played back on a VCR, adjust the tracking of the VCR. Read the manual of the VCR.

## Media Player

### SD Card

Card format : SDXC Card - exFAT

SDHC Card / SD Card - FAT16 or FAT32

Compliant card type (maximum capacity) : SDXC Card (64 GB), SDHC Card (32 GB), SD Card (2 GB), miniSD Card (2 GB) (requiring miniSD adaptor)

- If miniSD Card is used, insert / remove it together with the adaptor.
- Check the latest information on the card type at the following website.  
<http://panasonic.jp/support/global/cs/tv/>
- If the SD Card does not meet SD standards, it may cause the TV to malfunction.
- Do not remove the card while the TV is accessing data (this can damage card or TV).
- Do not touch the pins on the back of the card.
- Do not subject the card to a high pressure or impact.
- Insert the card in the correct direction (otherwise, card or TV may be damaged).
- Electrical interference, static electricity, or erroneous operation may damage the data or card.
- Back up the recorded data at regular intervals in case of deteriorated or damaged data or erratic operation of the TV. (Panasonic is not liable for any deterioration or damage of recorded data.)

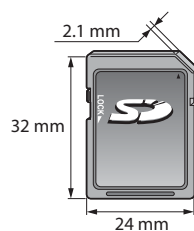

### Supported file format in Media Player

#### ■ Photo

Format	File extension	Image resolution (pixel)	Details / Restrictions
JPEG	.jpg	8 × 8 to 30,719 × 17,279	DCF*1 and EXIF*2 standards Sub-sampling : 4:4:4, 4:2:2, 4:2:0 • Motion JPEG and Progressive JPEG are not supported.

\*1 : Design rule for Camera File system - unified standard established by Japan Electronics and Information Technology Industries Association (JEITA)

\*2 : Exchangeable Image File - image file format used by digital cameras

#### ■ Video

Container	File extension	Video codec	Audio codec	Details / Restrictions
SD-Video	.mod	MPEG1 MPEG2	MPEG Dolby Digital	SD-Video Standard Ver. 1.3 (Entertainment Video Profile) • The data may not be available if a folder structure on the SD Card is modified.
AVCHD	.mts	H.264	Dolby Digital	AVCHD Standard • The data may not be available if a folder structure on the SD Card is modified.

#### Music

Codec	File extension	Restrictions
MP3	.mp3	–
AAC	.m4a	• Copy-protected files cannot be played back.

#### Note

- Some files may not be played back even if they fulfill these conditions.
- Do not use two-byte characters or other special codes for data.
- The card may become unusable with this TV if the file or folder names are changed.

## Characters table for numeric buttons

You can enter characters by using numeric buttons for free input items.

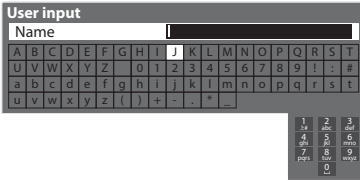

Press the numeric button repeatedly until you reach the desired character.

- The character is set automatically if you do not press the button for 1 second.
- You can also set the character by pressing the OK button or other numeric buttons within 1 second.

Characters table:

Numeric buttons	The number of times to press										
	1	2	3	4	5	6	7	8	9	10	11
1	.	1	!	:	#	+	-	*	_	(	)
2	a	b	c	:	A	B	C				
3	d	e	f	3	D	E	F				
4	g	h	i	4	G	H	I				
5	j	k	l	5	J	K	L				
6	m	n	o	6	M	N	O				
7	p	q	r	s	7	P	Q	R	S		
8	t	u	v	8	T	U	V				
9	w	x	y	z	9	W	X	Y	Z		
0	Space	0									

## HDMI connection

HDMI (high-definition multimedia interface) is the world's first complete digital consumer AV interface complying with a non-compression standard.

HDMI allows you to enjoy high-definition digital images and high-quality sound by connecting the TV and the equipment. HDMI-compatible equipment\*1 with an HDMI or DVI output terminal, such as a DVD player, a set top box or a game equipment, can be connected to the HDMI terminal using an HDMI compliant (fully wired) cable.

For information about connections, see "External Equipment" (p. 67).

### Applicable HDMI features

- Input audio signal :  
2ch Linear PCM (sampling frequencies - 48 kHz, 44.1 kHz, 32 kHz)
- Input video signal :  
480i, 480p, 576i, 576p, 720p, 1080i and 1080p  
➔ "Input signal that can be displayed" (p. 73)  
Match the output setting of the digital equipment.
- Input PC signal :  
➔ "Input signal that can be displayed" (p. 73)  
Match the output setting of the PC.
- VIERA Link (HDAVI Control 5)  
➔ [VIERA Link] (p. 62)
- Audio Return Channel\*2 (HDMI2 terminal only)

### DVI connection

If the external equipment has only a DVI output, connect to the HDMI terminal via a DVI to HDMI adaptor cable\*3. When the DVI to HDMI adaptor cable is used, connect the audio cable to the audio input terminal (use AV2 audio terminals).

#### Note

- Audio settings can be made on the [HDMI1 / 2 Input] in the Sound Menu. (p. 29)
- If the connected equipment has an aspect adjustment function, set the aspect ratio to [16:9].
- These HDMI connectors are "type A".
- These HDMI connectors are compatible with HDCP (High-Bandwidth Digital Content Protection) copyright protection.
- Equipment having no digital output terminal may be connected to the input terminal of "COMPONENT" or "VIDEO" to receive analogue signals.
- This TV incorporates HDMI™ technology.

\*1 : The HDMI logo is displayed on HDMI-compliant equipment.

\*2 : Audio Return Channel (ARC) is a function to be able to send digital sound signals via an HDMI cable.

\*3 : Enquire at your local digital equipment retailer shop.



## Input signal that can be displayed

### COMPONENT (Y, P<sub>B</sub>, P<sub>R</sub>), HDMI

Signal name	COMPONENT	HDMI
525 (480) / 60i, 60p	<input type="radio"/>	<input type="radio"/>
625 (576) / 50i, 50p	<input type="radio"/>	<input type="radio"/>
750 (720) / 60p, 50p	<input type="radio"/>	<input type="radio"/>
1,125 (1,080) / 60i, 50i	<input type="radio"/>	<input type="radio"/>
1,125 (1,080) / 60p, 50p, 24p		<input type="radio"/>

Mark : Applicable input signal

### PC (from D-sub terminal)

Signal name	Horizontal frequency (kHz)	Vertical frequency (Hz)
640 × 400 @70 Hz	31.47	70.07
640 × 480 @60 Hz	31.47	59.94
640 × 480 @75 Hz	37.50	75.00
800 × 600 @60 Hz	37.88	60.32
800 × 600 @75 Hz	46.88	75.00
800 × 600 @85 Hz	53.67	85.06
852 × 480 @60 Hz	31.44	59.89
1,024 × 768 @60 Hz	48.36	60.00
1,024 × 768 @70 Hz	56.48	70.07
1,024 × 768 @75 Hz	60.02	75.03
1,024 × 768 @85 Hz	68.68	85.00
1,280 × 768 @60 Hz	47.70	60.00
1,280 × 1,024 @60 Hz	63.98	60.02
1,366 × 768 @60 Hz	48.39	60.04
Macintosh13" (640 × 480)	35.00	66.67
Macintosh16" (832 × 624)	49.73	74.55
Macintosh21" (1,152 × 870)	68.68	75.06

Applicable input signal for PC is basically compatible to VESA standard timing.

### PC (from HDMI terminal)

Signal name	Horizontal frequency (kHz)	Vertical frequency (Hz)
640 × 480 @60 Hz	31.47	60.00
750 (720) / 60p	45.00	60.00
1,125 (1,080) / 60p	67.50	60.00

Applicable input signal for PC is basically compatible to HDMI standard timing.

#### Note

- Signals other than above may not be displayed properly.
- The above signals are reformatted for optimal viewing on your display.
- PC signal is magnified or compressed for display, so that it may not be possible to show fine detail with sufficient clarity.

## SCART and HDMI terminal information

### AV1 SCART terminal (RGB, VIDEO, Q-Link)

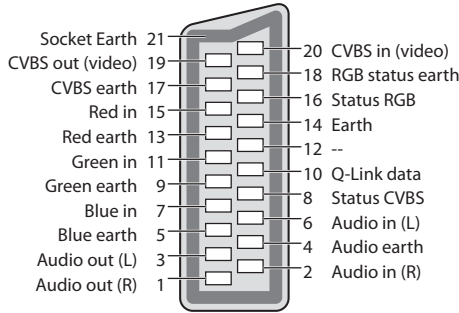

### HDMI terminal

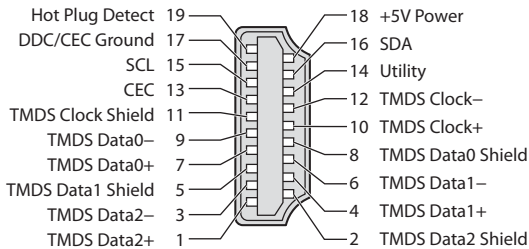

## PC connection

A PC may be connected to this TV so that the PC screen is displayed and sound is heard from the TV.

- To listen to PC sound from the TV, connect the audio cable to COMPONENT-AUDIO terminals. (p. 68)
- PC signals that can be inputted: Horizontal scanning frequency 31 to 69 kHz; vertical scanning frequency 59 to 86 Hz (more than 1,024 signal lines could result in incorrect display of the image).
- A PC adapter is not necessary for the DOS/V-compliant D-sub 15-pin connector.

#### Note

- Some PC models cannot be connected to this TV.
- When using PC, set the colour display quality of PC to the highest position.
- For details of the applicable PC signals ► "Input signal that can be displayed" (p. 73)
- Max. display resolution

Aspect	4:3	1,024 × 768 pixels
	16:9	1,366 × 768 pixels

- D-sub 15-pin connector signal



Pin No.	Signal Name	Pin No.	Signal Name	Pin No.	Signal Name
①	R	⑥	GND (Ground)	⑪	NC (not connected)
②	G	⑦	GND (Ground)	⑫	NC (not connected)
③	B	⑧	GND (Ground)	⑬	HD (HSYNC)
④	NC (not connected)	⑨	NC (not connected)	⑭	VD (VSYNC)
⑤	GND (Ground)	⑩	GND (Ground)	⑮	NC (not connected)

# FAQs

Before requesting service or assistance, please follow these simple guides to resolve the problem.

If the problem still persists, please contact your local Panasonic dealer or Panasonic Customer Care Centre for assistance. For details ➔ (p. 84)

## **Block noise, frozen or disappearing image occurs in digital mode / White spots or shadow image (ghosting) occurs in Analogue mode / Some channels cannot be tuned**

- Check the position, direction and connection of the aerial.
- Check [Signal Condition] (p. 38). If [Signal Quality] is displayed in red, the digital signal is weak.
- Check your postcode area is able to receive the Freeview channels at [www.freeview.co.uk](http://www.freeview.co.uk)
- Digital signals may be relatively low to prevent interference with analogue signals for the period of Digital Switchover. Check the schedule of Digital Switchover at [www.digitaluk.co.uk](http://www.digitaluk.co.uk)
- Weather conditions will affect signal reception (heavy rain, snow, etc.), in particular in poor reception areas. Even during good weather, high pressure can cause poor reception of some channels.
- Due to the digital reception technologies involved, quality of the digital signals may be relatively low in some cases, despite good reception of analogue channels.
- Turn the TV off with the Mains power On / Off switch, and then on again.
- If problem persists, consult your local dealer.

## **Neither image nor sound is produced**

- Is the TV in AV mode?
- Check the correct AV input mode is selected.
- Check the mains lead is plugged into the socket outlet.
- Has the TV been turned On?
- Check the Picture Menu (p. 28) and volume.
- Check all required cables and connections are firmly in place.

## **Auto aspect**

- Auto aspect is designed to provide you with the best ratio to fill the screen. ➔ (p. 70)
- Press the ASPECT button if you would like to change the aspect ratio manually ➔ (p. 17)

## **Black and white picture**

- When connecting with SCART, ensure the output setting of the external equipment is not S-Video.

## **Input mode, i.e. EC/AV1 remains on the screen**

- Press the  $\updownarrow$  button to clear this message.  
Press again to redisplay.

## **Q-Link function does not work**

- Confirm SCART cable and connection.  
Also set [AV1 out] in the Setup Menu ➔ (p. 30)

## **[VIERA Link] function does not work and an error message appears**

- Confirm the connection. ➔ (p. 59, 60)
- Turn the connected equipment on and then switch the TV on. ➔ (p. 62)

## **Recording does not start immediately**

- Check the settings of the recorder. For details, read the manual of the recorder.

	Problem	Actions
Screen	<b>Chaotic image, noisy</b>	<ul style="list-style-type: none"> <li>Set [P-NR] in the Picture Menu (to remove noise). ➔ (p. 28)</li> <li>Check nearby electrical products (fluorescent lamp, DECT phones, mobile phones, microwave, etc.).</li> </ul>
	<b>No image can be displayed</b>	<ul style="list-style-type: none"> <li>Is [Contrast], [Brightness] or [Colour] in the Picture Menu set to the minimum? ➔ (p. 28)</li> <li>Please also refer to "Neither image nor sound is produced" ➔ (p. 75)</li> </ul>
	<b>Blurry or distorted image (no sound or low volume)</b>	<ul style="list-style-type: none"> <li>Reset channels. ➔ (p. 36)</li> <li>Please also refer to "Neither image nor sound is produced" ➔ (p. 75)</li> </ul>
	<b>Unusual image is displayed</b>	<ul style="list-style-type: none"> <li>Turn the TV Off with Mains power On / Off switch, then turn it On again.</li> <li>If the problem persists, initialise all settings ➔ [Shipping Condition] (p. 47)</li> </ul>
Sound	<b>No sound is produced</b>	<ul style="list-style-type: none"> <li>Is Sound Mute active? ➔ (p. 8)</li> <li>Is the volume set to the minimum?</li> <li>Is Speaker Selection (VIERA Link) set to [TV]?</li> <li>Please also refer to "Neither image nor sound is produced" ➔ (p. 75)</li> </ul>
	<b>Sound level is low or sound is distorted</b>	<ul style="list-style-type: none"> <li>Sound signal reception may be deteriorated.</li> <li>Set [NICAM] (p. 29) in the Sound Menu to [Off]. (Analogue only)</li> <li>Please also refer to "Neither image nor sound is produced" ➔ (p. 75)</li> </ul>
	<b>Unusual sound from the TV</b>	<ul style="list-style-type: none"> <li>When power is on, whirring sound of cooling fan or drive noise may be heard from inside the TV (not a sign of faulty operation).</li> </ul>
	<b>No programmes shown on TV Guide</b>	<ul style="list-style-type: none"> <li>Reset channels. ➔ (p. 36)</li> <li>Check the digital transmission by contacting Digital UK on 08456 50 50 50 or at <a href="http://www.digitaluk.co.uk">www.digitaluk.co.uk</a></li> <li>Check the analogue broadcast (if still available in your area).</li> <li>Consult an aerial engineer to check the alignment of your aerial.</li> </ul>
Digital Channel	<b>Cannot find a channel you have previously watched</b>	<ul style="list-style-type: none"> <li>The channel may broadcast for part of the day.</li> <li>Check the channel in the TV Guide. ➔ (p. 18)</li> <li>Channel position numbers may be changed by broadcasters.</li> <li>Reset channels. ➔ (p. 36)</li> </ul>
	<b>Sound is unusual</b>	<ul style="list-style-type: none"> <li>Set the sound setting of the connected equipment to "2ch L.PCM".</li> <li>Check the [HDMI1 / 2 Input] setting in the Sound Menu. ➔ (p. 29)</li> <li>If digital sound connection has a problem, select analogue sound connection. ➔ (p. 72)</li> </ul>
HDMI	<b>Pictures from external equipment are unusual when the equipment is connected via HDMI</b>	<ul style="list-style-type: none"> <li>Check the HDMI cable is connected properly. ➔ (p. 68)</li> <li>Turn the TV and equipment Off, then turn them On again.</li> <li>Check an input signal from the equipment. ➔ (p. 73)</li> <li>Check the output resolution of the equipment.</li> <li>Use equipment compliant with EIA/CEA-861/861D.</li> </ul>
Network	<b>Cannot connect to the network</b>	<ul style="list-style-type: none"> <li>Check the LAN cable is connected properly. ➔ (p. 45)</li> <li>Check the connections and settings. ➔ (p. 45, 46)</li> <li>Check the network equipment and network environment.</li> <li>The router may not be set to issue IP address automatically. If the network administrator prefers to allocate an IP address, set an IP address manually. ➔ (p. 46)</li> <li>The router may be using MAC address filtering (security setting). Confirm the MAC Address of this TV (p. 45) and set the router to be able to use it.</li> <li>If the problem persists, consult your Internet Service Provider or telecommunications company.</li> </ul>
	<b>The TV does not switch On</b>	<ul style="list-style-type: none"> <li>Press and hold the standby On / Off switch on the remote control for about 1 second if Power LED is red.</li> <li>Check the mains lead is plugged into the socket.</li> <li>The fuse in the mains plug may have blown. Replace it with one of an identical rating ➔ (p. 4)</li> </ul>
Other	<b>The TV goes into Standby mode</b>	<ul style="list-style-type: none"> <li>Auto power standby function is activated. ➔ (p. 9)</li> <li>The TV enters Standby mode about 30 minutes after analogue broadcast ends.</li> </ul>
	<b>The remote control does not work or is intermittent</b>	<ul style="list-style-type: none"> <li>Are the batteries installed correctly? ➔ (p. 6)</li> <li>Has the TV been switched On?</li> <li>The batteries may be running low. Replace them.</li> <li>Point the remote control directly at the front of the TV (within about 7 m and a 30 degree angle of the front of the TV).</li> <li>Situate the TV so that sunshine or other sources of bright light do not shine on the TV's remote control signal receiver.</li> </ul>

	Problem	Actions
Other	Parts of the TV become hot	<ul style="list-style-type: none"> <li>Temperature rises of parts of the front, top and rear panels will not pose any problems in terms of performance or quality of the TV.</li> </ul>
	The LCD panel moves slightly when it is pushed with a finger Clattered sound might be heard	<ul style="list-style-type: none"> <li>There is some flexibility around the panel to prevent damage to the panel.</li> <li>The panel might move slightly when it is pushed with a finger, and clattered sound might be heard. This is not a malfunction.</li> </ul>
	There may be red spots, blue spots, green spots and black spots on the screen	<ul style="list-style-type: none"> <li>This is a characteristic of liquid crystal panels and is not a problem. The liquid crystal panel is built with very high precision technology giving you fine picture details. Occasionally, a few non-active pixels may appear on the screen as a fixed point of red, green, blue or black. Please note this does not affect the performance of your LCD.</li> </ul>
	An error message appears	<ul style="list-style-type: none"> <li>Follow the message's instructions.</li> <li>If the problem persists, contact your local Panasonic dealer or the authorized Service Centre.</li> </ul>

## On screen messages

Message	Meaning / Action
All tuning data will be erased	<ul style="list-style-type: none"> <li>[Shipping Condition] will erase all tuning data ➔ (p. 47)</li> </ul>
Are you sure ?	<ul style="list-style-type: none"> <li>Confirm correct operation.</li> </ul>
Are you sure you want to delete this timer ? Press OK to delete timer. Press RETURN to return.	<ul style="list-style-type: none"> <li>Confirm correct operation.</li> </ul>
Bad signal	<ul style="list-style-type: none"> <li>The signal is weak. Check the aerial is plugged in properly. It may be necessary to have an aerial installer check the signal and aerial alignment.</li> <li>Reset channels. ➔ (p. 36)</li> </ul>
Child Lock is active! Press OK to enter PIN.	<ul style="list-style-type: none"> <li>The selected channel is locked in Child Lock (p. 43). You must enter the PIN number before the channel will be displayed.</li> </ul>
Feature not available.	<ul style="list-style-type: none"> <li>It is not possible to record from COMPONENT or HDMI. Connect the recorder to the TV using a fully wired SCART cable for recording from the TV tuner.</li> <li>Confirm Q-Link or VIERA Link settings ➔ (p. 59 - 62)</li> </ul>
Feature not available. Press OK to view how it works.	<ul style="list-style-type: none"> <li>The selected feature on VIERA TOOLS is not available. Press the OK button to view the demonstration to explain how to use it.</li> </ul>
Found new software version ***. Press OK to start update (may take over 40 mins) or press EXIT to ignore and you can update when TV is in standby	<ul style="list-style-type: none"> <li>There is a new software available.</li> </ul>
Invalid operation - Please check settings and connections.	<ul style="list-style-type: none"> <li>Check the Q-Link or VIERA Link connection and setting ➔ (p. 59 - 62)</li> </ul>
Invalid system time. Please exit !	<ul style="list-style-type: none"> <li>Cannot get the time information and cannot edit Timer Programming screen. Check the connection of the RF cable.</li> </ul>
Invalid system time, Timer Programming will not work. Please press TV button on remote control and check time display on Banner	<ul style="list-style-type: none"> <li>Cannot get the time information. If there is no time displayed on the Information banner, check the connection of the RF cable.</li> </ul>
Max. number of timers already set !	<ul style="list-style-type: none"> <li>The maximum number of timer programming events is 15.</li> </ul>

Message	Meaning / Action
<b>New channels found!</b> Press OK to update channel list. Press EXIT to ignore.	<ul style="list-style-type: none"> <li>There may be new channels available.</li> <li>This message will appear each time a change is made by the broadcasters. This message can be deactivated by setting [New Channel Message] to Off in [DVB Tuning Menu].</li> <li>Selecting OK will perform [Update Channel List].</li> </ul>
<b>No channel found.</b> Please check aerial or local signal availability. Press OK to start Auto Setup.	<ul style="list-style-type: none"> <li>Follow the on screen instructions.</li> <li>Please also refer to p. 75.</li> <li>If channels are still not found, consult your local Panasonic dealer.</li> </ul>
<b>No module inserted</b>	<ul style="list-style-type: none"> <li>Check the CI module is inserted completely (p. 49).</li> </ul>
<b>No recording - Already recording</b>	<ul style="list-style-type: none"> <li>The equipment may already be recording.</li> </ul>
<b>No recording - Check media</b>	<ul style="list-style-type: none"> <li>The tape or disc may be "write protected", full, missing or damaged.</li> </ul>
<b>No recording - Playing</b>	<ul style="list-style-type: none"> <li>The equipment may be playing the tape or disc.</li> </ul>
<b>No recording - Unknown reason</b>	<ul style="list-style-type: none"> <li>The recording may not be performed. Check the equipment.</li> </ul>
<b>No service</b>	<ul style="list-style-type: none"> <li>The broadcaster has stopped the service. Check the channel in the TV Guide. (p. 18)</li> </ul>
<b>No signal</b>	<ul style="list-style-type: none"> <li>The TV cannot detect the signal. Check the connection of the RF cable.</li> </ul>
<b>PIN incorrect!</b>	<ul style="list-style-type: none"> <li>The PIN number you entered is wrong.</li> </ul>
<b>Please check settings and connections on HDMI devices.</b>	<ul style="list-style-type: none"> <li>Communication error in VIERA Link function (p. 62).</li> </ul>
<b>Please wait.</b>	<ul style="list-style-type: none"> <li>A function is in progress.</li> </ul>
<b>Recording this channel now</b>	<ul style="list-style-type: none"> <li>The recorder is recording the programme from its own tuner. You can turn the TV off and leave the equipment recording in the normal way.</li> </ul>
<b>Reset to Factory Shipping Condition Completed.</b> Please switch off TV.	<ul style="list-style-type: none"> <li>[Auto Setup] will automatically start when Mains power On / Off switch is next turned On. (p. 12)</li> </ul>
<b>Sending Preset Data</b>	<ul style="list-style-type: none"> <li>Q-Link or VIERA Link channel download is in progress.</li> </ul>
<b>Software successfully updated.</b> Press EXIT to continue.	<ul style="list-style-type: none"> <li>The software updating is finished.</li> </ul>
<b>Software update failed. Please try again later.</b> Press EXIT to continue.	<ul style="list-style-type: none"> <li>Perform [System Update Search Now] in System Update (p. 50).</li> <li>If this is still unsuccessful, there may not be any new software available.</li> </ul>
<b>This timer will not follow the TV Guide information.</b> Press OK to continue, RETURN to restore original timer.	<p><b>UK only</b></p> <ul style="list-style-type: none"> <li>If you edit the start time or end time of Guide link programming by more than 10 minutes, it will no longer be performed as Guide link programming. The programming will be performed according to the time setting.</li> </ul>
<b>Timer already expired !</b>	<ul style="list-style-type: none"> <li>The starting time in Timer Programming has already passed. Set the timer correctly (p. 42).</li> </ul>
<b>Timer Event Due to Start</b> ***:*** has been programmed for External recording at ***:***	<ul style="list-style-type: none"> <li>This message will appear 2 minutes before timer programming event for external recording due to start.</li> </ul>
<b>Timer incorrect !</b>	<ul style="list-style-type: none"> <li>Set the start and end times in Timer Programming correctly (p. 42).</li> </ul>
<b>Timer overlap.</b> Press OK to keep, RETURN to edit.	<ul style="list-style-type: none"> <li>Timer programming events are overlapped. Press the OK button to keep the overlapped setting. [Ext Rec.] is given priority over [Reminder]. When two or more [Ext Rec.] overlap, the first timer programming event starts and finishes as programmed. The next timer programming event can then start.</li> </ul>
<b>Tuner Locked</b> Press EXIT to unlock and stop recording	<ul style="list-style-type: none"> <li>If you want to unlock the tuner, cancel Direct TV Recording (p. 61, 63) or the recording of Timer Programming (p. 42).</li> </ul>
<b>Unable to download, please check equipment</b>	<ul style="list-style-type: none"> <li>The tape or disc is active. Stop the equipment and try again.</li> </ul>

## Media Player

Message	Meaning / Action
Cannot read file	<ul style="list-style-type: none"> <li>The file is damaged or unreadable.</li> <li>The TV does not support the format. (For the applicable formats and data ➔ p. 71)</li> </ul>
No SD card inserted	<ul style="list-style-type: none"> <li>Confirm the SD Card is inserted correctly.</li> </ul>
No valid file to play	<ul style="list-style-type: none"> <li>The card has no data.</li> </ul>
This operation is not possible	<ul style="list-style-type: none"> <li>The selected operation is not available.</li> </ul>

## Network

Message	Meaning / Action
Ethernet cable not connected	<ul style="list-style-type: none"> <li>Check the connection of the LAN cable. If you use a hub, also check the light on the hub is lit.</li> <li>The LAN cable might be defective.</li> </ul>

# Glossary

### AAC

Advanced Audio Coding - An advanced audio compression method

### AVCHD

Advanced Video Codec High Definition - A standard for high definition video cameras that can be used to record and play high resolution HD images

### DVI

Digital Visual Interface - A high quality video interface standard to connect to the display

### EPG

Electronic Programme Guide - A digital guide showing scheduled programmes

### HDMI

High-Definition Multimedia Interface - A digital audio and video interface for transmitting uncompressed digital signals on a single cable

### JPEG

Joint Photographic Experts Group - A standard for compressing colour still pictures

### LAN

Local Area Network

### MAC Address

Media Access Control Address

### MPEG2

Moving Picture Experts Group phase 2 - A standard for efficiently compressing and expanding colour videos

### MP3

MPEG Audio Layer 3 - A method for compressing audio data

### NICAM

Near Instantaneous Companded Audio Multiplex - A format for digital sound over television

### NTSC

National Television System Committee - One of the television signals used in USA, etc.

### RF

Radio Frequency - Signal received from terrestrial aerial

### RGB / Video

Choose between these three video formats depending on personal preference and equipment requirement (RGB - Red, Green and Blue)

### SCART

21 pin connection used for video, audio and switching signals (Also known as Euro SCART and Peritel)

### Shop viewing environment

Shop viewing environment is the demonstration mode to explain main features of this TV in an easy understandable way. This mode will work if you select [Shop] in "Auto Setup" (p. 13).

### SPDIF

A standard audio transfer file format

### VCR

Video Cassette Recorder

# Maintenance

**First, remove the mains plug from the socket outlet.**

## Display panel, Cabinet, Pedestal

### Regular care:

Gently wipe the surface of the display panel, cabinet, or pedestal by using a soft cloth to clean the dirt or fingerprints.

### For stubborn dirt:

Dampen a soft cloth with clean water or diluted neutral detergent (1 part detergent to 100 parts water). Then wring the cloth and wipe the surface. Finally, wipe away all the moisture.

### Caution

- Do not use a hard cloth or rub the surface too hard. This may cause scratches on the surface.
- Take care not to subject the TV's surfaces to water or detergent more than requires. A liquid inside the TV could lead to product failure.
- Take care not to subject the surfaces to insect repellent, solvent, thinner or other volatile substances. This may degrade surface quality or cause peeling of the paint.
- Take care not to tap or scratch the surface with your fingernail or other hard objects.
- Do not allow the cabinet or pedestal to make contact with a rubber or PVC substance for a long time. This may degrade surface quality.

## Mains plug

Wipe the mains plug with a dry cloth at regular intervals. Moisture and dust may lead to fire or electrical shock.

# Licence

Even if no special notation has been made of company or product trademarks, these trademarks have been fully respected.

- DVB and the DVB logos are trademarks of the DVB Project.
- VGA is a trademark of International Business Machines Corporation.
- Macintosh is a registered trademark of Apple Inc., USA.
- S-VGA is a registered trademark of the Video Electronics Standard Association.
- SDXC Logo is a trademark of SD-3C, LLC.
- HDMI, the HDMI Logo, and High-Definition Multimedia Interface are trademarks or registered trademarks of HDMI Licensing LLC in the United States and other countries.
- HDAVI Control™ is a trademark of Panasonic Corporation.
- "AVCHD" and the "AVCHD" logo are trademarks of Panasonic Corporation and Sony Corporation.
- Manufactured under license from Dolby Laboratories.  
Dolby and the double-D symbol are trademarks of Dolby Laboratories.
- Manufactured under license under U.S. Patent #: 5,451,942 & other U.S. and worldwide patents issued & pending. DTS and the Symbol are registered trademarks and DTS Digital Out and the DTS logos are trademarks of DTS, Inc. Product includes software. © DTS, Inc. All Rights Reserved.
- GUIDE Plus+ is (1) a registered trademark or trademark of, (2) manufactured under license from and (3) subject of various international patents and patent applications owned by, or licensed to, Rovi Corporation and/or its related affiliates.





# Index

<b>A</b> Accessories.....	6
Advanced Settings.....	28
Analogue Tuning Menu.....	36, 39, 40
Aspect.....	17
Audio Description.....	15, 30
Auto Gain Control.....	29
Auto Setup.....	12, 36
Auto Standby.....	32
AV1 out.....	30, 61
<b>B</b> Banner Display Timeout.....	31
<b>C</b> Category list.....	18
Channel List.....	39, 40
Channel Sorting by Region.....	37
Child Lock.....	43
Common Interface.....	49
COMPONENT.....	70, 73
Connection.....	10, 11, 45, 59, 60, 67, 68, 69
<b>D</b> Direct TV Recording.....	61, 63
DTS.....	29
DVB Tuning Menu.....	36-39
DVI.....	72
DVI Input Setting.....	28
DVD Recorder.....	10, 11, 25, 59, 67, 68
<b>E</b> EPG.....	18
External equipment.....	10, 11, 24, 67, 68, 69
External input.....	24, 25
<b>F</b> FAQs.....	75, 76
Favourites Edit.....	38
Free input menu.....	27, 72
<b>G</b> Gamma.....	51
Glossary.....	79
Guide link programming.....	20
<b>H</b> HDMI.....	72, 73, 80
Hold.....	16, 22
Home Cinema.....	66
<b>I</b> Information banner.....	15
Input Labels.....	44
Input signal.....	73
<b>L</b> Last view.....	15
Licence.....	80
<b>M</b> Mains Lead.....	11
Mains power On / Off switch.....	9, 12
Maintenance.....	80
Manual Tuning.....	37, 40
Media Player.....	52-58
Menu Functions.....	27-32
Mode.....	29
Monaural Audio.....	16
Multi Audio.....	16
Music mode.....	58
<b>N</b> Network connections.....	45
Network Setup.....	45
New Channel Message.....	38
NICAM.....	29
Normalise.....	27
NTSC.....	28, 82
<b>O</b> Off Timer.....	16, 30
Optional accessories.....	6
Owner ID.....	13, 48
<b>P</b> PAL.....	82
PC.....	51, 68, 72, 74
Pedestal.....	7
Photo mode.....	53
PIN number.....	12, 13, 43, 48
Playing Time Display.....	31
P-NR.....	28
Power and Timer LED.....	9, 19, 41
<b>Q</b> Q-Link.....	59, 61
Q-Link Download.....	12, 30
Quick Start Guide.....	6-13
<b>R</b> Radio Mode.....	31
Remote control.....	6, 8
Reset to Defaults.....	28, 30
RGB.....	83
<b>S</b> Sales and Support Information.....	84
Satellite receiver.....	67
SCART.....	74, 83
SD Card.....	52, 71
Search list.....	19
Shipping Condition.....	47
Signal Condition.....	38
Slideshow.....	54
Software Update.....	46, 50
Specifications.....	82, 83
Split Programme.....	20
Subtitles.....	17, 23
System Update.....	50
<b>T</b> Teletext.....	21-23
Timer Programming.....	19, 41
True Cinema.....	28
TV Guide.....	18-20
TV Guide Settings.....	30
<b>U</b> Update Channel List.....	39
<b>V</b> V-Audio Surround.....	29
VCR.....	10, 11, 25, 67
Video mode.....	56
VIERA Link.....	59, 60, 62-66
VIERA TOOLS.....	26
Viewing Mode.....	28
Vivid Colour.....	28
Volume Correction.....	16, 29
<b>W</b> WSS.....	70
White Balance.....	51
<b>Z</b> Zoom.....	17, 55

# Specifications

		TX-L19E3B
<b>Power Source</b>		AC 220-240 V, 50 Hz
<b>Rated Power Consumption</b>		34 W
<b>Standby Power Consumption</b>		0.3 W 8.6 W (With monitor out recording)
<b>Dimensions (W × H × D)</b>		469 mm × 346 mm × 163 mm (With Pedestal) 469 mm × 311 mm × 59 mm (TV only)
<b>Mass</b>		4.0 kg Net (With Pedestal) 3.5 kg Net (TV only)
<b>Display panel</b>	<b>Aspect Ratio</b>	16:9
	<b>Visible screen size</b>	47 cm (diagonal) 409 mm (W) × 230 mm (H)
	<b>Number of pixels</b>	1,049,088 (1,366 (W) × 768 (H))
<b>Sound</b>	<b>Speaker</b>	(115 mm × 30 mm) × 2; 8 Ω
	<b>Audio Output</b>	6 W (3 W + 3 W)
	<b>Headphones</b>	M3 (3.5 mm) stereo mini Jack × 1
<b>PC signals</b>		VGA, SVGA, WVGA, XGA SXGA, WXGA ..... (compressed) Horizontal scanning frequency 31 - 69 kHz Vertical scanning frequency 59 - 86 Hz
<b>Receiving Systems / Band name</b>		<div style="border: 1px solid black; padding: 2px; display: inline-block;">UK</div> <b>DVB-T / T2</b> Digital terrestrial services. <b>PAL I</b> UHF E21-68 <b>PAL 525/60</b> Playback of NTSC tape from some PAL Video recorders (VCR) or NTSC disc playback from DVD player and recorder. <b>M.NTSC</b> Playback from M.NTSC Video recorders (VCR). <b>NTSC (AV input only)</b> Playback from NTSC Video recorders (VCR). <div style="border: 1px solid black; padding: 2px; display: inline-block;">Ireland</div> <b>DVB-T</b> Digital terrestrial services. <b>PAL I</b> VHF A - J                      UHF E21 - E69 CATV S1 - S20              CATV S21 - S41 (Hyperband) <b>PAL 525/60</b> Playback of NTSC tape from some PAL Video recorders (VCR) or NTSC disc playback from DVD player and recorder. <b>M.NTSC</b> Playback from M.NTSC Video recorders (VCR). <b>NTSC (AV input only)</b> Playback from NTSC Video recorders (VCR).
<b>Aerial input</b>		<div style="border: 1px solid black; padding: 2px; display: inline-block;">UK</div> <div style="border: 1px solid black; padding: 2px; display: inline-block;">Ireland</div> UHF                                  VHF / UHF
<b>Operating Conditions</b>		<b>Temperature:</b> 0 °C - 35 °C <b>Humidity:</b> 20 % - 80 % RH (non-condensing)

Connection Terminals	<b>AV1 (SCART)</b>	21 Pin terminal (Audio/Video in, Audio/Video out, RGB in, Q-Link)		
	<b>AV2 input</b>	<b>VIDEO</b>	RCA PIN Type × 1	1.0 V[p-p] (75 Ω)
		<b>AUDIO L - R</b>	RCA PIN Type × 2	0.5 V[rms]
	<b>COMPONENT input</b>	<b>Y</b>	1.0 V[p-p] (including synchronization)	
		<b>Pb, Pr</b>	±0.35 V[p-p]	
	<b>HDMI 1 / 2 input</b>	TYPE A Connectors HDMI2 : HDMI (Version 1.4 with Audio Return Channel) ● This TV supports "HDAVI Control 5" function.		
	<b>PC</b>	HIGH-DENSITY D-SUB 15PIN	R,G,B/0.7 V[p-p] (75 W)	HD, VD/TTL Level 2.0 - 5.0 V[p-p] (high impedance)
	<b>Card slot</b>	SD Card slot × 1 Common Interface slot × 1		
	<b>AUDIO OUT</b>	RCA PIN Type × 2	0.5 V[rms] (high impedance)	
	<b>ETHERNET</b>	RJ45, IEEE802.3 10BASE-T / 100BASE-TX		
<b>DIGITAL AUDIO OUT</b>	PCM / Dolby Digital / DTS, Fiber optic			

- Design and Specifications are subject to change without notice. Mass and Dimensions shown are approximate.
- This equipment complies with the EMC standards listed below.  
EN55013, EN61000-3-2, EN61000-3-3, EN55020, EN55022, EN55024

## Information for Users on Collection and Disposal of Old Equipment and used Batteries



These symbols on the products, packaging, and/or accompanying documents mean that used electrical and electronic products and batteries should not be mixed with general household waste. For proper treatment, recovery and recycling of old products and used batteries, please take them to applicable collection points, in accordance with your national legislation and the Directives 2002/96/EC and 2006/66/EC.

By disposing of these products and batteries correctly, you will help to save valuable resources and prevent any potential negative effects on human health and the environment which could otherwise arise from inappropriate waste handling.

For more information about collection and recycling of old products and batteries, please contact your local municipality, your waste disposal service or the point of sale where you purchased the items.

Penalties may be applicable for incorrect disposal of this waste, in accordance with national legislation.

### For business users in the European Union

If you wish to discard electrical and electronic equipment, please contact your dealer or supplier for further information.

### [Information on Disposal in other Countries outside the European Union]

These symbols are only valid in the European Union. If you wish to discard these items, please contact your local authorities or dealer and ask for the correct method of disposal.

### Note for the battery symbol (bottom two symbol examples) :

This symbol might be used in combination with a chemical symbol. In this case it complies with the requirement set by the Directive for the chemical involved.



## Sales and Support Information

### Customer Care Centre

- For customers within the UK: **0844 844 3852**
- For customers within Ireland: **01 289 8333**
- Visit our website for product information: **[www.panasonic.co.uk](http://www.panasonic.co.uk)**
- E-mail: **[customer.care@panasonic.co.uk](mailto:customer.care@panasonic.co.uk)**

### Direct Sales at Panasonic UK

- For customers: **0844 844 3856**
- Order accessory and consumable items for your product with ease and confidence by phoning our Customer Care Centre Monday – Thursday 9:00am – 5:30pm, Friday 9:30am – 5:30pm (Excluding public holidays).
- Or go on line through our Internet Accessory ordering application at **[www.pas-europe.com](http://www.pas-europe.com)**.
- Most major credit and debit cards accepted.
- All enquiries transactions and distribution facilities are provided directly by Panasonic UK Ltd.
- It couldn't be simpler!
- Also available through our Internet is direct shopping for a wide range of finished products, take a browse on our website for further details.



### Declaration of Conformity (DoC)

Authorized Representative :

Panasonic Testing Centre

Panasonic Marketing Europe GmbH

Winsbergring 15, 22525 Hamburg, Germany

### Customer's Record

The model number and serial number of this product may be found on its rear panel. You should note this serial number in the space provided below and retain this book, plus your purchase receipt, as a permanent record of your purchase to aid in identification in the event of theft or loss, and for Warranty Service purposes.

**Model Number**

**Serial Number**

**Panasonic U.K. Ltd.**

Willoughby Road, Bracknell, Berkshire, RG12 8FP

Web Site : <http://panasonic.net>

© Panasonic Corporation 2011