

Panasonic®

Model No.
TX-40AX630B
TX-48AX630B
TX-55AX630B

English

Operating Instructions LCD Television



VIERA

For more detailed instructions, refer to [eHELP]
(Built-in Operating Instructions).

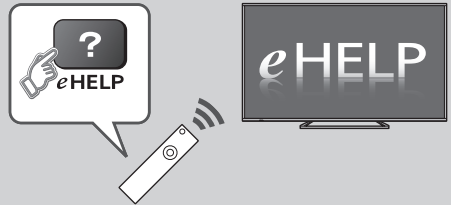

- How to use [eHELP] → (p. 17)

Thank you for purchasing this Panasonic product.

Please read these instructions carefully before operating this product and retain them for future reference.

The images shown in this manual are for illustrative purposes only.



TQB0E2491U



- For the information of the trademarks, refer to [eHELP] (Support > Licence).

Contents

Be Sure to Read

Important Notice	3
Safety Precautions	4

Quick Start Guide

Accessories	7
Connections	8
Identifying Controls	12
First time Auto Setup	15

Using your VIERA

Operations	16
How to Use eHELP	17
Viewing 3D images	17

Others

FAQs	19
Maintenance	20
Specifications	20

Important Notice

Notice for DVB / Data broadcasting / IPTV functions

This TV is designed to meet the standards (as of August, 2013) of digital services.

- Not all the features are available depending on the country, area, broadcaster, service provider and network environment.
- The compatibility with future services is not guaranteed.
- Check the latest information on the available services at the following website.

<http://panasonic.net/viera/support>

Panasonic does not guarantee operation and performance of peripheral devices made by other manufacturers; and we disclaim any liability or damage arising from operation and/or performance from usage of such other maker's peripheral devices.

The recording and playback of content on this or any other device may require permission from the owner of the copyright or other such rights in that content. Panasonic has no authority to and does not grant you that permission and explicitly disclaims any right, ability or intention to obtain such permission on your behalf. It is your responsibility to ensure that your use of this or any other device complies with applicable copyright legislation in your country. Please refer to that legislation for more information on the relevant laws and regulations involved or contact the owner of the rights in the content you wish to record or playback.

This product is licensed under the AVC patent portfolio license for the personal and non-commercial use of a consumer to (i) encode video in compliance with the AVC Standard ("AVC Video") and/or (ii) decode AVC Video that was encoded by a consumer engaged in a personal and non-commercial activity and/or was obtained from a video provider licensed to provide AVC Video. No license is granted or shall be implied for any other use.

Additional information may be obtained from MPEG LA, LLC.

See <http://www.mpegla.com>.

Rovi Corporation and/or its subsidiaries and related affiliates are not in any way liable for the accuracy or availability of the program schedule information or other data in the Rovi Guide system and cannot guarantee service availability in your area. In no event shall Rovi Corporation and/or its related affiliates be liable for any damages in connection with the accuracy or availability of the program schedule information or other data in the Rovi Guide system.

Transport only in upright position.

Safety Precautions

To help avoid risk of electrical shock, fire, damage or injury, please follow the warnings and cautions below:

■ Mains plug and lead

Warning

If you detect anything unusual, immediately switch off the mains supply switch and remove the mains plug.

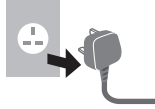

IMPORTANT:

THE MOULDED MAINS PLUG FOR YOUR SAFETY, PLEASE READ THE FOLLOWING TEXT CAREFULLY.

This TV is supplied with a moulded 3-pin mains plug for your safety and convenience.

A 5 amp fuse is fitted in this mains plug. Shall the fuse need to be replaced, please ensure that the replacement fuse has a 5 amp rating and that it is approved by ASTA or BSI to BS1362.

Check for the ASTA mark  or the BSI mark  on the fuse body.

If the mains plug contains a removable fuse cover, you must ensure that it is refitted when the fuse is replaced.

If you lose the fuse cover, the mains plug must not be used until a replacement cover is obtained.

A replacement fuse cover may be purchased from your local dealer.

Do not cut off the mains plug.

Do not use any other type of mains lead except the one supplied with this TV.

The supplied mains lead and moulded plug are designed to be used with this TV to avoid interference and for your safety.

If the socket outlet in your home is not suitable, get it changed by a qualified electrician.

If the plug or mains lead becomes damaged, purchase a replacement from an authorised dealer.

How to replace the fuse:

For plug type shown in example 1

Lift out the removable fuse cover with a screwdriver and replace the fuse, then refit it securely into the mains plug.

For plug type shown in example 2

Lift open the fuse cover in the mains plug with a screwdriver and replace the fuse, then press the fuse cover down securely.

Example 1



Example 2

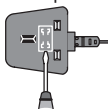

- This TV is designed to operate on AC 220-240 V, 50 / 60 Hz.

- Insert the mains plug fully into the socket outlet.
- Ensure that the mains plug is easily accessible.
- Disconnect the mains plug when cleaning the TV.
- Do not touch the mains plug with wet hands.



- Do not damage the mains lead.

- Do not place a heavy object on the lead.



- Do not place the lead near a high temperature object.



- Do not pull on the lead. Hold onto the mains plug body when disconnecting the plug.



- Do not move the TV with the lead plugged into a socket outlet.

- Do not twist the lead, bend it excessively or stretch it.

- Do not use a damaged mains plug or socket outlet.
- Ensure the TV does not crush the mains lead.

- Do not use any mains lead other than that provided with this TV.

■ Take care

Warning

- Do not remove covers and never modify the TV yourself as live parts are accessible when they are removed. There are no user serviceable parts inside.



- Do not expose the TV to rain or excessive moisture. This TV must not be exposed to dripping or splashing water and objects filled with liquid, such as vases, must not be placed on top of or above the TV.



- Do not insert foreign objects into the TV through the air vents.

- Do not use an unapproved pedestal / mounting equipment. Be sure to ask your local Panasonic dealer to perform the setup or installation of approved wall-hanging brackets.

- Do not apply strong force or impact to the display panel.

- Do not place the TV on sloped or unstable surfaces, and ensure that the TV does not hang over the edge of the base.



- This TV is designed for table-top use.

- Do not expose the TV to direct sunlight and other sources of heat.



To prevent the spread of fire, keep candles or other open flames away from this product at all times



■ Dangerous part / Small object

Warning

- This product contains possibly dangerous parts such as plastic bags, that can be breathed in or swallowed by young children accidentally. Keep these parts out of reach of young children.
- Do not allow children to handle any small objects such as SD Card. The small object could be swallowed by young children. Remove SD Card immediately after use and store out of reach of young children.



■ Pedestal

Warning

- Do not disassemble or modify the pedestal.

Caution

- Do not use any pedestal other than the one provided with this TV.
- Do not use the pedestal if it becomes warped or physically damaged. If this occurs, contact your nearest Panasonic dealer immediately.
- During setup, make sure that all screws are securely tightened.
- Ensure that the TV does not suffer any impact during installation of the pedestal.
- Ensure that children do not climb onto the pedestal.
- Install or remove the TV from the pedestal with at least two people.
- Install or remove the TV by the specified procedure.

■ Radio wave

Warning

- Do not use the TV and Touch Pad Controller in any medical institutions or locations with medical equipment. Radio waves may interfere with the medical equipment and cause accidents due to the malfunction.
- Do not use the TV and Touch Pad Controller near any automatic control equipment such as automatic doors or fire alarms. Radio waves may interfere with the automatic control equipment and cause accidents due to the malfunction.
- Keep the distance at least 22 cm from the TV and Touch Pad Controller when you have a cardiac pacemaker. Radio waves may interfere with the operation of the pacemaker.

- Do not disassemble or alter the TV and Touch Pad Controller in any way.

■ Built-in wireless LAN

Caution

- Do not use the built-in wireless LAN to connect to any wireless network (SSID*) for which you do not have usage rights. Such networks may be listed as a result of searches. However, using them may be regarded as illegal access.
*SSID is a name for identifying a particular wireless network for transmission.
- Do not subject the built-in wireless LAN to high temperatures, direct sunlight or moisture.
- Data transmitted and received over radio waves may be intercepted and monitored.
- The built-in wireless LAN uses 2.4 GHz and 5 GHz frequency bands. To avoid malfunctions or slow response caused by radio wave interference, keep the TV away from the devices such as other wireless LAN devices, microwaves, mobile phones and the devices that use 2.4 GHz and 5 GHz signals when using the built-in wireless LAN.
- When noises occur due to the static electricity, etc., the TV might stop operating for the protection of the devices. In this case, turn the TV off with Mains power On / Off switch, then turn it on again.
- Additional information for the wireless LAN and access point may be on the following website.
<http://panasonic.net/viera/support>

■ Bluetooth® wireless technology

Caution

- The TV and Touch Pad Controller use the 2.4 GHz radio frequency ISM band (Bluetooth®). To avoid malfunctions or slow response caused by radio wave interference, keep the TV and Touch Pad Controller away from the devices such as other wireless LAN devices, other Bluetooth devices, microwaves, mobile phones and the devices that use 2.4 GHz signal.

■ Ventilation

Caution

Allow sufficient space around the TV in order to help prevent excessive heat, which could lead to early failure of some electronic components.

Minimum distance:

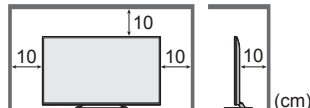

- Ventilation should not be impeded by covering the ventilation openings with items such as newspapers, tablecloths and curtains.
- Whether you are using a pedestal or not, always ensure the vents at the bottom of the TV are not blocked and there is sufficient space to enable adequate ventilation.



■ Moving the TV

Caution

Before moving the TV, disconnect all cables.

- Move the TV with at least two people.

■ When not in use for a long time

Caution

This TV will still consume some power even in the Off mode, as long as the mains plug is still connected to a live socket outlet.

- Remove the mains plug from the wall socket when the TV is not in use for a prolonged period of time.

■ Excessive volume

Caution

- Do not expose your ears to excessive volume from the headphones. Irreversible damage can be caused.
- If you hear a drumming noise in your ears, turn down the volume or temporarily stop using the headphones.



■ Battery for the Remote Control / Touch Pad Controller

Caution

- Incorrect installation may cause battery leakage, corrosion and explosion.
- Replace only with the same or equivalent type.
- Do not mix old and new batteries.
- Do not mix different battery types (such as alkaline and manganese batteries).
- Do not use rechargeable batteries (Ni-Cd, etc.).
- Do not burn or break up batteries.
- Do not expose batteries to excessive heat such as sunshine, fire or the like.
- Make sure you dispose of batteries correctly.
- Remove the battery from the unit when not using for a prolonged period of time to prevent battery leakage, corrosion and explosion.

■ Viewing 3D Images

Caution

- Pay special attention when children are viewing 3D images. 3D images should not be viewed by children younger than about 6 years old, as a guideline. All children must be fully supervised by parents or guardians who must ensure their safety and health while they are viewing 3D images.
- Stop viewing 3D images immediately if you feel tired, feel unwell, experience any other uncomfortable sensation or clearly see double images. Take an appropriate break before continuing to view. When you set the 3D effect by using [3D Adjustment], take into account that the vision of 3D images varies among different individuals.
- Do not view 3D images if you have a history of oversensitivity to light, heart problems or any other medical conditions.

- When viewing 3D images, your sense of distance may be tricked or go wrong. Be careful not to hit the TV screen or other people unintentionally. Ensure there are no breakable objects around you to avoid any accidental damage or injury.
- Do not view 3D images from a distance shorter than recommended. The recommended viewing distance is at least 3 times of the image height.

40-inch model : 1.5 m or more

48-inch model : 1.8 m or more

55-inch model : 2.1 m or more

When black bands at the top and bottom of the screen are displayed, such as movies, view the screen from a distance at least 3 times the height of the actual image. (That makes the distance shorter than the recommended values above.)

LCD Television



Declaration of Conformity (DoC)

"Hereby, Panasonic Corporation declares that this TV is in compliance with the essential requirements and other relevant provisions of the Directive 1999/5/EC."

If you want to get a copy of the original DoC of this TV, please visit the following website:

<http://www.doc.panasonic.de>

Authorized Representative:

Panasonic Testing Centre

Panasonic Marketing Europe GmbH

Winsbergring 15, 22525 Hamburg, Germany

This TV is intended to be used in the following countries.
Ireland, United Kingdom

The wireless LAN feature of this TV shall exclusively be used inside buildings.

Accessories

Remote Control

➔ (p. 12)

- N2QAYB000829



Touch Pad Controller

➔ (p. 13)

- N2QBYA000004

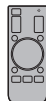

Pedestal

➔ (p. 7)

40-inch model 48-inch model

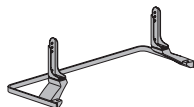

55-inch model

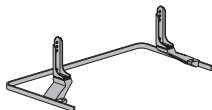

Mains lead

➔ (p. 9)

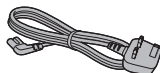

Batteries

- R6 (2)
(For Remote Control)

➔ (p. 12)

- R03 (2)
(For Touch Pad Controller)

➔ (p. 14)



Operating Instructions

Production Registration Leaflet

- Accessories may not be placed all together. Take care not to throw them away unintentionally.
- For the information of optional accessories, refer to [eHELP] (Support > Optional accessories).

Assembling / Removing the pedestal

(A) Assembly screw (4)



M5 × 15

(B) Assembly screw (4)



M4 × 12

(C) Bracket (2)



(D) Base

40-inch model 48-inch model

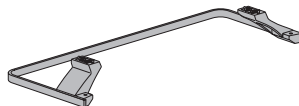

55-inch model

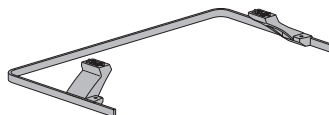

■ Assembling the pedestal

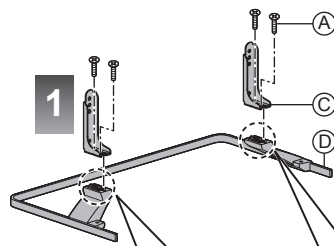

1

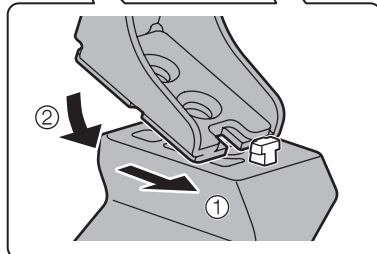

Connections

- External equipment and cables shown are not supplied with this TV.
- Please ensure that the unit is disconnected from the mains socket before attaching or disconnecting any cables.
- Check the terminal type and cable plugs are correct when connecting.
- Use a fully wired HDMI compliant cable.
- Use a fully wired SCART cable.
- Keep the TV away from electronic equipment (video equipment, etc.) or equipment with an infrared sensor, otherwise distortion of image / sound may occur or operation of other equipment may be affected.
- Please also read the manual of the equipment being connected.

Terminals

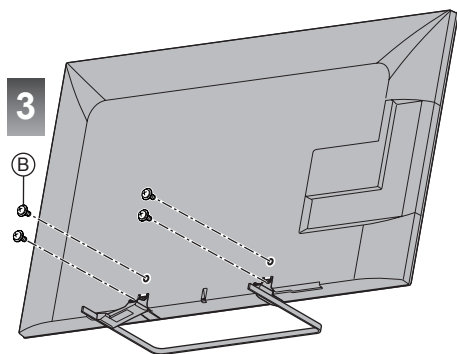
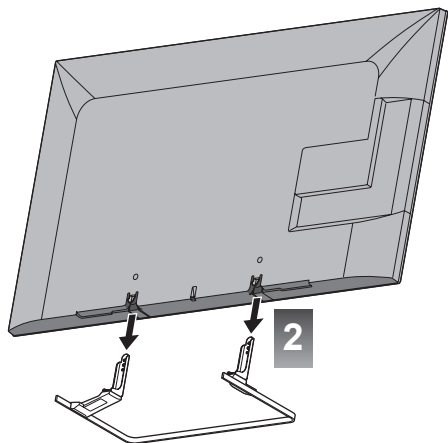

Removing the pedestal from the TV

Be sure to remove the pedestal in the following way when using the wall-hanging bracket or repacking the TV.

- 1 Remove the assembly screws **B** from the TV.
- 2 Pull out the pedestal from the TV.
- 3 Remove the assembly screws **A** from the bracket.

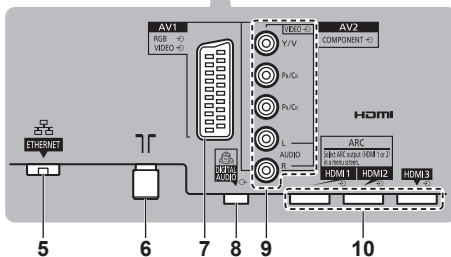
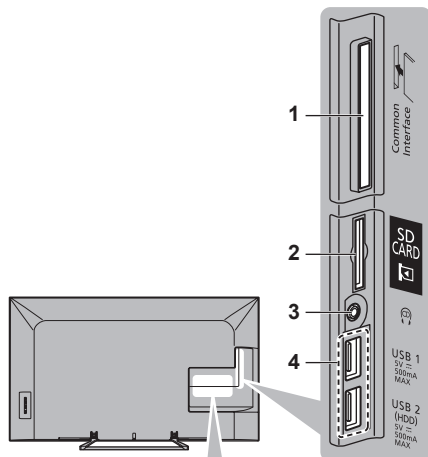

- 1 CI slot ➔ (p. 11)
- 2 SD Card slot
- 3 Headphone jack ➔ (p. 11)
- 4 USB 1 - 2 port
- 5 ETHERNET ➔ (p. 10)
- 6 Terrestrial terminal ➔ (p. 9)

- 7 AV1 (SCART) → (p. 9)
- 8 DIGITAL AUDIO
- 9 AV2 (COMPONENT / VIDEO) → (p. 10)
- 10 HDMI1 - 3 → (p. 9, 10, 11)

- To watch contents of 4K format, use HDMI terminal. → (p. 10)

Basic connections

■ Mains lead

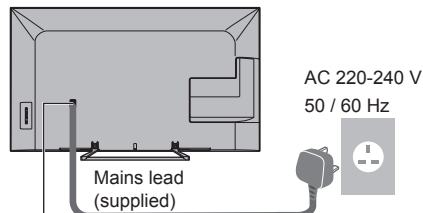

Insert the mains plug firmly into place.

- When disconnecting the mains lead, be absolutely sure to disconnect the mains plug at the socket outlet first.



■ Aerial

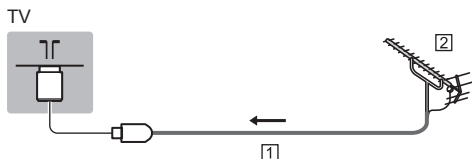

- 1 RF cable
- 2 Terrestrial aerial
- For DVB, Analogue

AV devices

■ DVD Recorder / VCR

TV

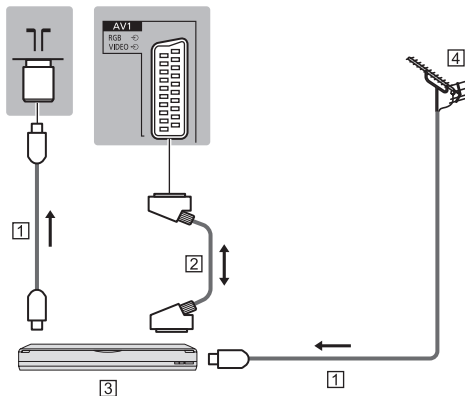

- 1 RF cable
- 2 SCART cable
- 3 DVD Recorder / VCR
- 4 Terrestrial aerial

■ DVD Recorder (VCR) / Satellite receiver

TV

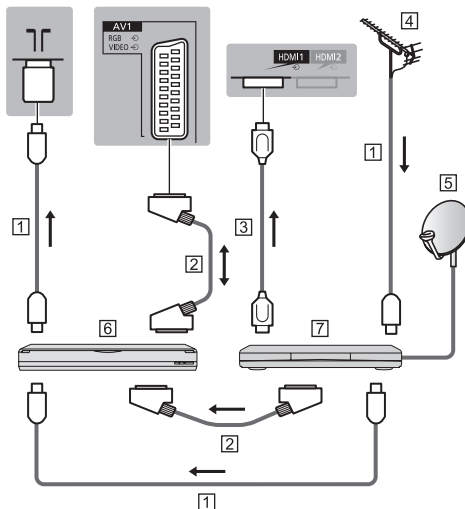

- 1 RF cable
- 2 SCART cable
- 3 HDMI cable
- 4 Terrestrial aerial
- 5 Satellite dish
- 6 DVD Recorder / VCR
- 7 Satellite receiver

Network

To use internet service, you need a broadband network environment.

- If you do not have any broadband network services, please consult your retailer for assistance.
- Prepare the internet environment for wired connection or wireless connection.
- Setup of the network connection will start when first using the TV. ➔ (p. 15)

■ Wired connection

TV

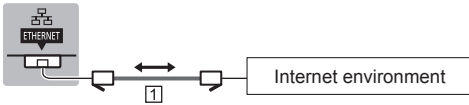

1 LAN cable (Shielded)

- Use the Shielded Twist Pair (STP) LAN cable.

■ Wireless connection



1 Built-in wireless LAN

2 Access point

Connections for 4K contents

■ 4K compatible equipment

TV

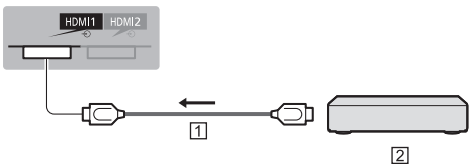

1 HDMI cable

2 4K compatible equipment

- To watch contents of 4K format, connect the 4K compatible equipment to HDMI terminal by using a 4K compatible cable.
- If 4K compatible equipment supports 4K (60p, 50p) 4:4:4 output, use HDMI1 for connecting.

Other connections

■ DVD Player

(COMPONENT equipment)

TV

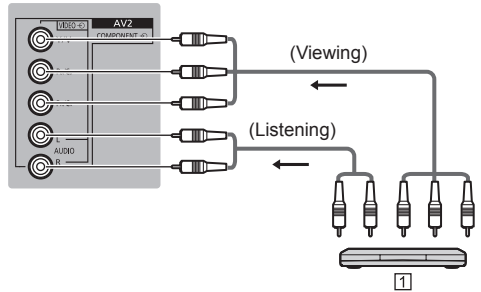

1 DVD Player

■ Camcorder / Game equipment

(VIDEO equipment)

TV

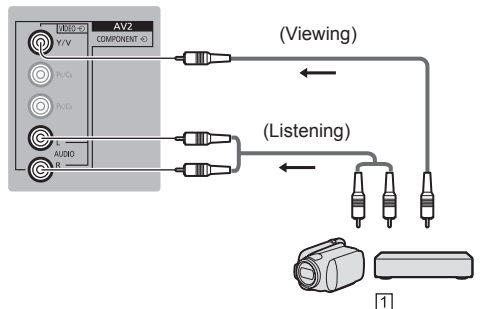

1 Camcorder / Game equipment

■ Blu-ray Disc Player

(3D-compatible equipment)

TV

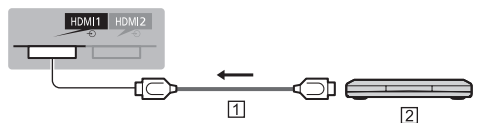

1 HDMI cable

2 Blu-ray Disc Player

■ Amplifier (to listen with speakers)

- Use HDMI1 or HDMI2 for connecting an amplifier and match the output setting in [ARC Output] (Sound Menu). This connection is applicable when using an amplifier that has ARC (Audio Return Channel) function. If an amplifier supports 4K (60p, 50p) 4:4:4 output, use HDMI1 for connecting and set [ARC Output] to [HDMI1].

As for an amplifier without ARC function, use DIGITAL AUDIO.

- To enjoy multi-channel sound from external equipment (e.g. Dolby Digital 5.1ch), connect the equipment to the amplifier. For the connections, read the manuals of the equipment and amplifier.

TV

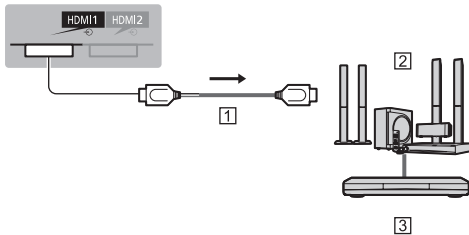

① HDMI cable

② Amplifier with speaker system

③ External equipment (DVD Player, etc.)

■ Headphones

- To adjust volume
➔ **[Headphone Volume] in the Sound Menu**
- To select the sound output to adjust volume
➔ **[Speaker Setting] in the Sound Menu**

TV



■ Common Interface

- Turn the TV off with Mains Power On / Off switch whenever inserting or removing the CI module.
- If a smart card and a CI module come as a set, first insert the CI module, then insert the smart card into the CI module.
- Insert or remove the CI module completely in the correct direction as shown.
- Normally encrypted channels will appear. (The viewable channels and its features depend on the CI module.)

If encrypted channels do not appear

➔ **[Common Interface] in the Setup Menu**

- There might be some CI modules in the market with older firmware versions that do not work fully interoperable with this new CI+ v1.3 TV. In this case, please contact your content provider.
- For more information, refer to [eHELP] (Functions > Common Interface), read the manual of the CI module, or check with the content provider.

TV

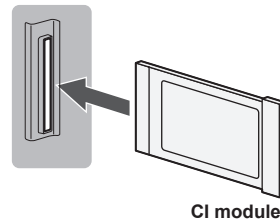

CI module

■ Communication Camera

- Use USB 1 for connecting the Communication Camera.
- For more information, refer to [eHELP] (Support > Optional accessories > Communication Camera).

■ USB HDD (for recording)

- Use USB 2 for connecting the USB HDD.
- For more information, refer to [eHELP] (Recording).

■ VIERA Link

- Use HDMI1 - 3 for VIERA Link connection.
- For more information, refer to [eHELP] (Functions > VIERA Link "HDAVI Control™").

Identifying Controls

Remote Control

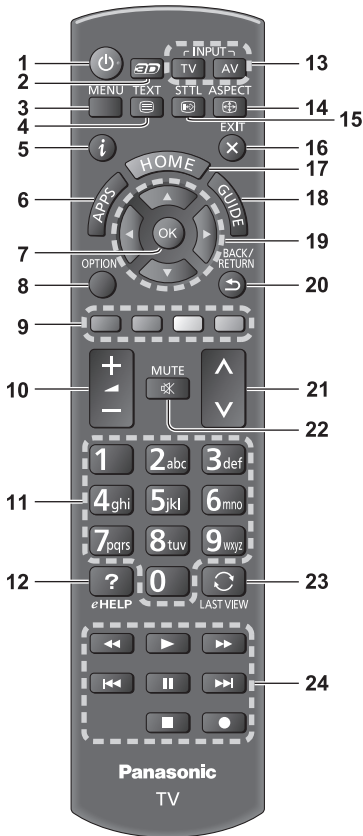

1 Standby On / Off switch

2 3D button

- Switches the view between 2D and 3D.

3 [Main Menu]

- Press to access Picture, Sound, Network, Timer, Setup and Help Menus.

4 Text service button

5 Information

- Displays channel and programme information.

6 APPS

- Displays [APPS List] (applications list).

7 OK

- Confirms selections and choices.
- Press after selecting channel positions to quickly change channel.

8 [Option Menu]

- Easy optional setting for viewing, sound, etc.

9 Coloured buttons

(red-green-yellow-blue)

- Used for the selection, navigation and operation of various functions.

10 Volume Up / Down

11 Numeric buttons

- Changes channel and teletext pages.
- Sets characters.
- When in Standby mode, switches TV on.

12 [eHELP]

- Displays [eHELP] (Built-in Operating Instructions).

13 Input mode selection

- TV - switches to DVB / Analogue mode.
- AV - switches to AV input mode from Input Selection list.

14 Aspect

- Changes aspect ratio.

15 Subtitles

- Displays subtitles.

16 Exit

- Returns to [Home Screen].

17 HOME

- Displays [Home Screen].

18 TV Guide

- Displays Electronic Programme Guide.

19 Cursor buttons

- Makes selections and adjustments.

20 Return

- Returns to the previous menu / page.

21 Channel Up / Down

22 Sound Mute On / Off

23 Last view

- Switches to previously viewed channel or input mode.

24 Operations for contents, connected equipment, etc.

■ Installing / Removing batteries

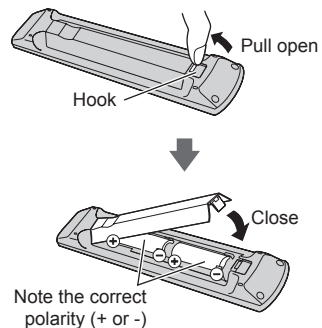

Touch Pad Controller

Touch Pad Controller is designed for the convenient operations, especially, on Home Screen or internet contents. You can operate the TV intuitively with this controller.

- Touch Pad Controller can be used by registering to this TV with Bluetooth wireless technology.
The registration starts automatically when you press any buttons (except Standby On / Off switch) after installing batteries.
- After registering, you can operate the TV without pointing this controller at the TV (except Standby On / Off switch).
- To use Standby On / Off switch, point the controller directly at the TV's remote control signal receiver because it works with the infrared. (You can operate the switch without registration.)
- It is recommended to speak within about 15 cm from microphone of Touch Pad Controller when using Voice Control function.
- For more information, refer to [eHELP] (Functions > Touch Pad Controller).

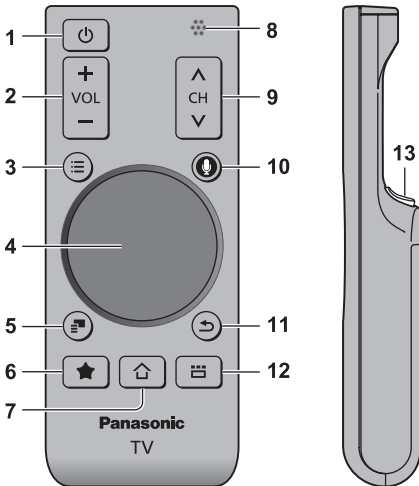

1 Standby On / Off switch

2 Volume Up / Down

3 [Main Menu]

4 Touch pad (p. 13)

5 [Option Menu]

6 My button

- Press to register the content as your favourite.
- For more information of my button, refer to [eHELP] (Functions > Touch Pad Controller > My button).

7 HOME

- Displays [Home Screen].

8 Microphone

9 Channel Up / Down

10 Voice Control button

- Press to use Voice Control function.

11 Return

- Returns to [Home Screen].

12 APPS

- Displays [APPS List] (application list).

13 OK

- Confirms selections and choices.

■ Touch Pad



- Tap the centre of the pad for "OK".

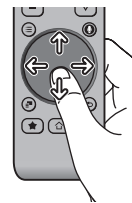

- Slide your finger to move the cursor (on internet contents or [Cursor Settings] in [VIERA Touch Pad Controller] (Setup Menu)), select the item, adjust levels, etc.

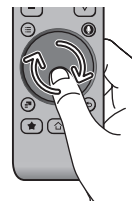

- Trace the fringe to scroll.

■ Installing / Removing batteries

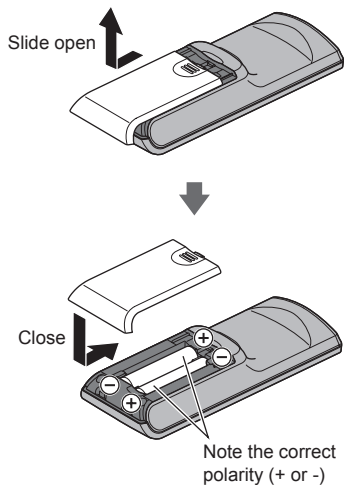

Note

- It is recommended to hold Touch Pad Controller with your hand when using.
- The battery power will be used whenever you use Touch Pad Controller (including the touch of the touch pad) even if not operating the TV. It may decrease the battery life.
- Some operations differ depending on the application.

Indicator / Control panel

- When pressing 4, 5, 6 buttons, the control panel guide appears on the right side of the screen for 3 seconds to highlight the pressed button.

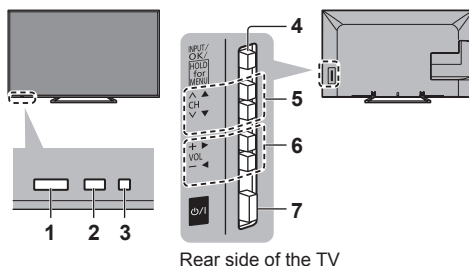

1 Remote control signal receive

- Do not place any objects between the TV remote control signal receiver and remote control.

2 Ambient sensor

- Senses brightness to adjust picture quality when [Ambient Sensor] in the Picture Menu is set to [On].

3 Power LED

Red: Standby

Green: On

Orange: Standby with some functions (recording, etc.) active

- The LED blinks when the TV receives a command from the remote control.

4 Input mode selection

- Press repeatedly until you reach the desired mode.

[Main Menu]

- Press and hold for about 3 seconds to display main menu.

OK (when in the menu system)

5 Channel Up / Down

Cursor Up / Down (when in the menu system)

6 Volume Up / Down

Cursor Left / Right (when in the menu system)

7 Mains power On / Off switch

- Use to switch the mains power.

First time Auto Setup

Automatically sets up the TV and searches for available TV channels when the TV is turned on for the first time.

- These steps are not necessary if the setup has been completed by your local dealer.
- Please complete connections (p. 8 - 11) and settings (if necessary) of the connected equipment before starting Auto Setup. For details of settings for the connected equipment, read the manual of the equipment.

1 Plug the TV into mains socket and turn power on



- Takes a few seconds to be displayed.



2 Select the following items

Set up each item by following the on-screen instructions.

Example:



■ How to use remote control



Move the cursor



Access the item / store the setting

BACK/
RETURN



Return to the previous item (if available)

Select [Home]

Select [Home] viewing environment to use in your home environment.

- [Shop] is for shop display.
- To change viewing environment later on, you will need to initialise all settings by accessing Shipping Condition.

Set up the network connection

Select your country

- Auto Setup screen varies depending on the country and the signal mode.

Select your region

3 Select the type of [Home Screen]

The demonstration to explain how to use [my Home Screen] is displayed. Confirm the demonstration by following the on-screen instructions, and then select the desired [Home Screen].

Example: [Home Screen Selection]



Example: [TV Home Screen]



Auto Setup is now complete and your TV is ready for viewing.

If tuning has failed, check the connection of the network, RF cable, and then follow the on-screen instructions.

Note

- The TV will automatically go into Standby mode when no operation is performed for 4 hours if [Auto Standby] in the Timer Menu is set to [On].
- The TV will automatically go into Standby mode when no signal is received and no operation is performed for 10 minutes if [No signal Power off] in the Timer Menu is set to [On].
- To retune all channels
➔ **[Auto Setup] in [Tuning Menu] (Setup Menu)**
- To initialise all settings
➔ **[Shipping Condition] in [System Menu] (Setup Menu)**

Operations

Turn power on

⏻/I (TV)

or

 (Remote Control)

- Mains power On / Off switch should be on. (p. 14)
- The last viewed [Home Screen] is displayed.

Example: [TV Home Screen]



Example: Selected content screen



- To return to [Home Screen] at any time



- You can set up or make [Home Screen] to display desired information, to access specific features easily, to select the default [Home Screen], etc. For details, follow the on-screen instructions or refer to [eHELP] (my Home Screen > my Home Screen).

Watching TV

1 Select the TV viewer from [Home Screen]



2 Select DVB or Analogue

TV

- The selectable modes vary depending on the stored channels and selected country.



- You can also select the mode pressing the TV button repeatedly.

3 Select a channel

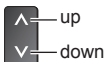

or



- DVB channel position begins from number 1 upward. Analogue channel position numbers are in the 0 - 99 range.

To access each feature

Access [APPS List] and select a feature



Example: [APPS List]



APPS is the applications (features) of the TV.

- For operations of each feature and the setup of [APPS List], follow the on-screen instructions or refer to [eHELP] (my Home Screen > APPS List).

How to Use eHELP

[eHELP] is the detailed operating instructions built into the TV, and helps you to get more understanding of the operations for each feature.

1 Display [eHELP]



or



[Help]



[eHELP]

- If this is not the first time to view [eHELP] from when the TV is turned on, the confirmation screen is displayed to select whether [First Page] or [Last Page].

2 Select the category and item

Category field

Item field



Sub item field

Description

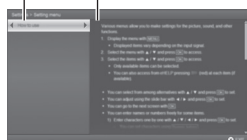

- To return to the previous field



- To scroll the description (if more than 1 page)
While the description is highlighted



- To display the menu related to the description (only for some descriptions)



Viewing 3D images

You can enjoy viewing 3D images with contents or programmes corresponding to the 3D effect by wearing the 3D Eyewear (optional).

- The 3D Eyewear must be worn to view 3D images.
- When using the 3D Eyewear, please also read the manual of the 3D Eyewear.
- This TV supports [Frame Sequential]*, [Side by Side] and [Top and Bottom] 3D formats. (3D content of 4K format is not supported.)
- For more information, refer to [eHELP] (Watching > 3D).

*: The 3D format that the images for the left and right eyes are recorded with the high definition quality and alternately played back.

To view the 3D images

Use the Panasonic 3D Eyewear that supports Bluetooth wireless technology.

■ Playing back 3D-compatible Blu-ray disc (Frame Sequential format)

- Connect the 3D-compatible player via a fully wired HDMI compliant cable. (If you use the non 3D-compatible player, the images will be displayed in 2D mode.)
- If the input mode is not switched automatically, select the input mode connected to the player using the AV button.

■ 3D-supported broadcast

- Please consult the suppliers of contents or programmes for availability of this service.

■ 3D photos and 3D videos taken by 3D-compatible Panasonic products

- Available in Media Player and Network services.

■ 2D images converted to 3D

- Press the 3D button and set to [2D→3D] mode in [3D Mode Selection]. (Contents of 4K format cannot be changed to 3D mode.)

Ensure that the registration of the 3D Eyewear has been completed. For details, read the manual of the 3D Eyewear.

1 Turn the 3D Eyewear on and put it on

Connection status and battery status are displayed on the bottom right of the screen.

2 View the 3D images

Safety precautions will be displayed when you first watch the 3D image. Select [Yes] or [No] to continue to view 3D images.

Note

- Turn off the 3D Eyewear after using it.
- Use the 3D Eyewear within approximately 3.2 m from the TV. You cannot view the 3D images with the 3D Eyewear too far from the TV, because of the difficulty of receiving radio waves from the TV.
- The range may be shortened depending on the obstacles between the TV and the 3D Eyewear, or the surrounding environment.
- When viewing 3D images, make sure your eyes are at an approximately horizontal level and keep a position where you do not see double images.
- If light appears to flicker under fluorescents or dimmers when using the 3D Eyewear, change the setting of [3D Refresh Rate] in [3D Settings] (Picture Menu).
- There are differences in the viewing range of the 3D Eyewear among individuals.

FAQs

Before requesting service or assistance, please follow these simple guides to solve the problem.

- For more information, refer to [eHELP] (Support > FAQs).

The TV does not switch on

- Check the mains lead is plugged into the TV and the socket outlet.
- The fuse in the mains plug may have blown. Replace it with one of an identical rating. ➔ (p. 4)

The TV goes into Standby mode

- Auto power standby function is activated.

The remote control does not work or is intermittent

- Are the batteries installed correctly? ➔ (p. 12)
- Has the TV been switched on?
- The batteries may be running low. Replace them with new ones.
- Point the remote control directly at the TV's remote control signal receiver (within about 7 m and a 30 degree angle of the signal receiver).
- Situate the TV away from sunshine or other sources of bright light not to shine on the TV's remote control signal receiver.

No image can be displayed

- Check the TV is turned on.
- Check the mains lead is plugged into the TV and the socket outlet.
- Check the correct input mode is selected.
- Check the setting of [AV2] ([COMPONENT] / [VIDEO]) in [Input Selection] to match the output of the external equipment.
- Is [Contrast], [Brightness] or [Colour] in the Picture Menu set to the minimum?
- Check all required cables and connections are firmly in place.

Unusual image is displayed

- Turn the TV off with Mains power On / Off switch, then turn it on again.
- If the problem persists, initialise all settings.
➔ **[Shipping Condition] in [System Menu] (Setup Menu)**

Parts of the TV become hot

- Even if the temperature of parts of the front, top and rear panels has risen, these temperature rises do not cause any problems in terms of performance or quality.

The display panel moves slightly and clattered sound is heard when it is pushed with a finger

- There is a little gap around the panel to prevent damage to the panel. This is not a malfunction.

Check you can get Freeview HD in your area. Text your postcode, followed by your house number or name to **80560***. Or visit **freeview.co.uk**

*e.g. NW96NY1 (Costs no more than a normal text.)

To get the most up to date service from Freeview it is important for Freeview customers to retune from time to time.

How do I re-tune my Freeview TV ?

This is a quick reference. If you have any problems, check the Operating Instructions or ask a friend or family member to show you how. Alternatively, go to your local electrical retailer, contact your local Panasonic dealer or visit **freeview.co.uk/retune**

Re-tuning only takes a few minutes, just follow the steps below:

1. Press the TV button to select DVB mode.
2. Press the MENU button to open the main menu.
3. [Setup] ➔ [DVB Tuning Menu] ➔ [Auto Setup]

Please note: most digital TV recorders will keep your original recordings after running a re-tune but you will need to reset any future recordings.

Maintenance

First, remove the mains plug from the socket outlet.

Display panel, Cabinet, Pedestal

Regular care:

Gently wipe the surface of the display panel, cabinet, or pedestal by using a soft cloth to clean the dirt or fingerprints.

For stubborn dirt:

- (1) First clean the dust on the surface.
- (2) Dampen a soft cloth with clean water or diluted neutral detergent (1 part detergent to 100 parts water).
- (3) Wring the cloth firmly. (Please note liquids do not enter the TV inside. May lead to product failure.)
- (4) Finally, wipe away all the moisture.

Caution

- Do not use a hard cloth or rub the surface too hard, otherwise this may cause scratches on the surface.
- Take care not to subject the surfaces to insect repellent, solvent, thinner or other volatile substances. This may degrade surface quality or cause peeling of the paint.
- The surface of the display panel is specially treated and may be easily damaged. Take care not to tap or scratch the surface with your fingernail or other hard objects.
- Do not allow the cabinet and pedestal to make contact with a rubber or PVC substance for a long time. This may degrade surface quality.

Mains plug

Wipe the mains plug with a dry cloth at regular intervals. Moisture and dust may cause fire or electrical shock.

Specifications

■ TV

Model No.

40-inch model : TX-40AX630B

48-inch model : TX-48AX630B

55-inch model : TX-55AX630B

Dimensions (W × H × D)

40-inch model

919 mm × 582 mm × 202 mm (With Pedestal)

919 mm × 537 mm × 60 mm (TV only)

48-inch model

1 087 mm × 677 mm × 214 mm (With Pedestal)

1 087 mm × 632 mm × 60 mm (TV only)

55-inch model

1 242 mm × 761 mm × 292 mm (With Pedestal)

1 242 mm × 716 mm × 62 mm (TV only)

Mass

40-inch model

11.0 kg Net (With Pedestal)

10.0 kg Net (TV only)

48-inch model

15.0 kg Net (With Pedestal)

14.0 kg Net (TV only)

55-inch model

18.5 kg Net (With Pedestal)

17.0 kg Net (TV only)

Power source

AC 220-240 V, 50 / 60 Hz

Panel

LED LCD panel

Sound

Speaker output

20 W (10 W + 10 W)

Headphones

M3 (3.5 mm) stereo mini Jack × 1

Connection terminals

AV1 input / output

SCART (Audio/Video in, Audio/Video out, RGB in)

AV2 input (COMPONENT / VIDEO)

VIDEO

RCA PIN Type × 1
1.0 V[p-p] (75 Ω)

AUDIO L - R

RCA PIN Type × 2
0.5 V[rms]

Y

1.0 V[p-p] (including synchronisation)

Pb/Cb, Pr/Cr

±0.35 V[p-p]

HDMI 1 / 2 / 3 input

TYPE A Connectors

HDMI1 / 2: 4K, 3D (3D content of 4K format is not supported.), Content Type, Audio Return Channel

HDMI3: 4K, 3D (3D content of 4K format is not supported.), Content Type

- This TV supports "HDAVI Control 5" function.

Card slot

SD Card slot × 1
Common Interface slot (complies with CI Plus) × 1

ETHERNET

RJ45, IEEE802.3 10BASE-T / 100BASE-TX

USB 1 / 2

USB1 / 2: DC 5 V, Max. 500 mA [Hi-Speed USB (USB 2.0)]

DIGITAL AUDIO output

PCM / Dolby Digital / DTS, Fibre optic

Receiving systems / Band name

Check the latest information on the available services at the following website.

<http://panasonic.net/viera/support>

DVB-T / T2

Digital terrestrial services

UK

PAL I

UHF E21 - 68

Ireland

PAL I

VHF A - J
CATV S1 - S20
UHF E21 - E69
CATV S21 - S41 (Hyperband)

PAL 525/60

Playback of NTSC tape from some PAL Video recorders (VCR) or NTSC disc playback from DVD player and recorder

M.NTSC

Playback from M.NTSC Video recorders (VCR)

NTSC (AV input only)

Playback from NTSC Video recorders (VCR)

Aerial input

UK

UHF

Ireland

VHF / UHF

Operating conditions

Temperature

0 °C - 35 °C

Humidity

20 % - 80 % RH (non-condensing)

Built-in wireless LAN

Standard compliance and Frequency range*1

IEEE802.11a/n
5.180 GHz - 5.320 GHz, 5.500 GHz - 5.580 GHz,
5.660 GHz - 5.700 GHz
IEEE802.11b/g/n
2.412 GHz - 2.472 GHz

Security

WPA2-PSK (TKIP/AES)
WPA-PSK (TKIP/AES)
WEP (64 bit/128 bit)

Bluetooth wireless technology*2

Standard Compliance

Bluetooth 3.0

Frequency Range

2.402 GHz - 2.480 GHz

*1: The frequency and channel differ depending on the country.

*2: Not all the Bluetooth compatible devices are available with this TV. Up to 5 devices can be used simultaneously (except Touch Pad Controller).

Note

- Touch Pad Controller uses Bluetooth wireless technology.
- Design and Specifications are subject to change without notice. Mass and Dimensions shown are approximate.
- For the information of power consumption, display resolution, etc., please refer to Product fiche.
- For the information of the open source software, refer to [eHELP] (Support > Licence).
- This equipment complies with the EMC standards listed below.

EN55013, EN61000-3-2, EN61000-3-3, EN55020, EN55022, EN55024

■ When using the wall-hanging bracket

Please contact your local Panasonic dealer to purchase the recommended wall-hanging bracket.

- Holes for wall-hanging bracket installation

Rear of the TV

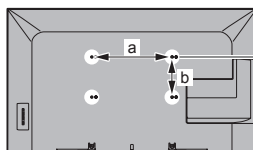

40-inch model

a: 200 mm

b: 200 mm

48-inch model

55-inch model

a: 400 mm

b: 200 mm

(View from the side)

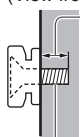

Depth of screw

40-inch model

48-inch model

minimum: 8 mm

maximum: 18 mm

55-inch model

minimum: 10 mm

maximum: 20 mm

Diameter: M6

Screw for fixing the TV onto the wall-hanging bracket (not supplied with the TV)



Information for Users on Collection and Disposal of Old Equipment and used Batteries



These symbols on the products, packaging, and/or accompanying documents mean that used electrical and electronic products and batteries should not be mixed with general household waste. For proper treatment, recovery and recycling of old products and used batteries, please take them to applicable collection points, in accordance with your national legislation and the Directives 2002/96/EC and 2006/66/EC.



By disposing of these products and batteries correctly, you will help to save valuable resources and prevent any potential negative effects on human health and the environment which could otherwise arise from inappropriate waste handling.



For more information about collection and recycling of old products and batteries, please contact your local municipality, your waste disposal service or the point of sale where you purchased the items.

Penalties may be applicable for incorrect disposal of this waste, in accordance with national legislation.

For business users in the European Union

If you wish to discard electrical and electronic equipment, please contact your dealer or supplier for further information.

[Information on Disposal in other Countries outside the European Union]

These symbols are only valid in the European Union. If you wish to discard these items, please contact your local authorities or dealer and ask for the correct method of disposal.

Note for the battery symbol (bottom two symbol examples):

This symbol might be used in combination with a chemical symbol. In this case it complies with the requirement set by the Directive for the chemical involved.



Cd

Sales and Support Information

Customer Communications Centre

- For customers within the UK: **0844 844 3899**
- For customers within Ireland: **01289 8333**
- Monday – Friday 9:00am – 5:00pm, (Excluding public holidays).
- For further support on your product, please visit our website: **www.panasonic.co.uk**

Direct Sales at Panasonic UK

- Order accessory and consumable items for your product with ease and confidence by phoning our Customer Communications Centre Monday – Friday 9:00am – 5:00pm, (Excluding public holidays).
- Or go on line through our Internet Accessory ordering application at **www.pas-europe.com**.
- Most major credit and debit cards accepted.
- All enquiries transactions and distribution facilities are provided directly by Panasonic UK.
- It couldn't be simpler!
- Also available through our Internet is direct shopping for a wide range of finished products. Take a browse on our website for further details.

Customer's Record

The model number and serial number of this product may be found on its rear panel. You should note this serial number in the space provided below and retain this book, plus your purchase receipt, as a permanent record of your purchase to aid in identification in the event of theft or loss, and for Warranty Service purposes.

Model Number

Serial Number

Panasonic UK, a branch of Panasonic Marketing Europe GmbH

Willoughby Road, Bracknell, Berkshire, RG12 8FP

Web Site: <http://panasonic.net>

English