

Panasonic®

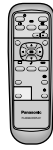
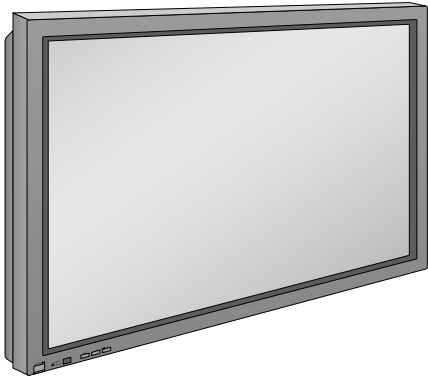

Wide Plasma Display Operating Instructions

Model No.

TH-42PW3 TH-42PWD3

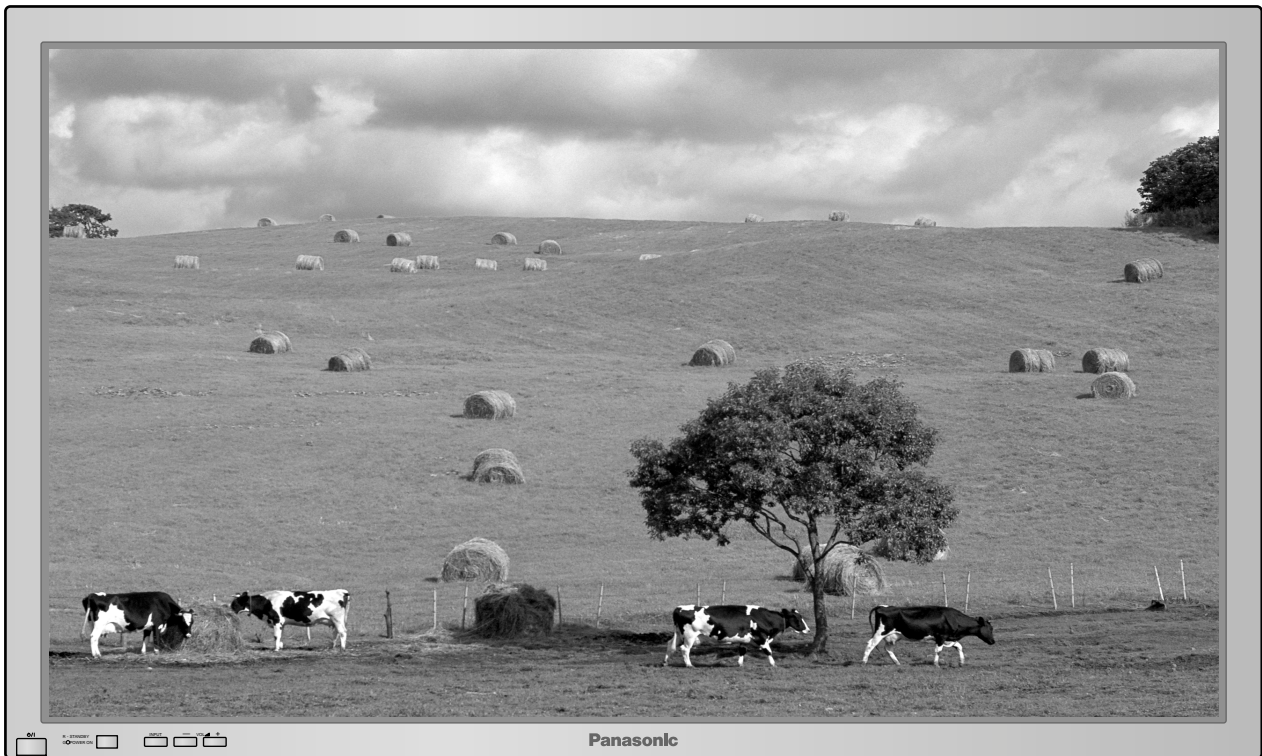

Before connecting, operating or adjusting this product, please read these instructions completely. Please keep this manual for future reference.

English

Dear Panasonic Customer

Welcome to the Panasonic family of customers. We hope that you will have many years of enjoyment from your new Wide Plasma Display.

To obtain maximum benefit from your set, please read these Instructions before making any adjustments, and retain them for future reference.

Retain your purchase receipt also, and note down the model number and serial number of your set in the space provided on the rear cover of these instructions.

Please confirm the model number of your Wide Plasma Display

This manual is made for model number "TH-42PW3" or "TH-42PWD3", therefore some contents may not be for your model type. Please refer to the sections intended for your model.

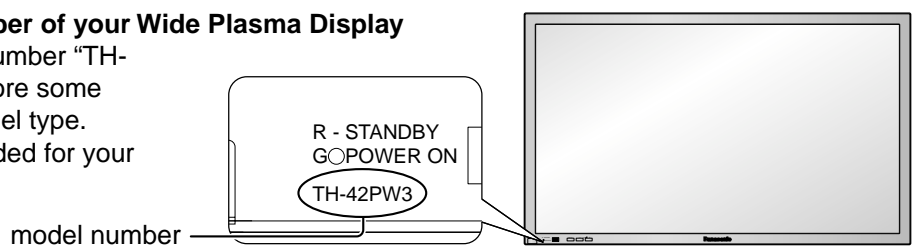

Trademark Credits

- VGA is a trademark of International Business Machines Corporation.
 - Macintosh is a registered trademark of Apple Computer, USA.
 - S-VGA is a registered trademark of the Video Electronics Standard Association.
- Even if no special notation has been made of company or product trademarks, these trademarks have been fully respected.

Note:

Do not allow a still picture to be displayed for an extended period, as this can cause a permanent after-image to remain on the Wide Plasma Display. Examples of still pictures include logos, video games, computer images, teletext and images displayed in 4:3 mode.

Table of Contents

Warnings and Precautions	4	Adjusting Picture Pos./Size	22
Accessories	7	Sound Adjustment	24
Accessories Supply	7	Mute	24
Optional Accessories	7	Surround Controls	25
Remote Control Batteries	8	Picture Adjustments	26
Basic Controls	9	Advanced settings (Model "TH-42PWD3" only)	27
Connections	10	Setup for input signals	28
How to connect the AV Input Terminals	11	Component/RGB-in select	28
How to connect the COMPONENT/RGB Input Terminals	13	Adjusting unnatural video images (3D Y/C Filter)	28
How to connect the PC Input Terminals	14	Colour system / Panasonic Auto	29
How to connect the SERIAL Terminals	15	[Sync]	30
Power On/Off and input signal selection	16	[Pull-in range]	30
Power On/Off	16	[Clamp position]	30
Select the input signal	17	[H-Freq. (kHz)/V-Freq. (Hz)]	30
On screen Menu Display from Remote Control	18	Troubleshooting	31
Selecting the On-Screen Menu Language	19	Specifications	32
ASPECT Controls	20		

Warnings and Precautions

WARNING: To prevent damage which may result in fire or shock hazard, do not expose this appliance to rain or moisture.

WARNING: 1) To prevent electric shock, do not remove cover. No user serviceable parts inside. Refer servicing to qualified service personnel.
2) Do not remove the earthing pin on the power plug. This apparatus is equipped with a three pin earthing-type power plug. This plug will only fit an earthing-type power outlet. This is a safety feature. If you are unable to insert the plug into the outlet, contact an electrician.
Do not defeat the purpose of the earthing plug.

Warning

This is a class A product. In a domestic environment this product may cause radio interference in which case you may be required to take adequate measures.

IMPORTANT: THE MOULDED PLUG

FOR YOUR SAFETY, PLEASE READ THE FOLLOWING TEXT CAREFULLY.

This appliance is supplied with a moulded three pin mains plug for your safety and convenience. A 5 amp fuse is fitted in this plug. Shall the fuse need to be replaced, please ensure that the replacement fuse has a rating of 5 amps and that it is approved by ASTA or BSI to BS1362..

Check for the ASTA mark  or the BSI mark  on the body of the fuse.

If the plug contains a removable fuse cover, you must ensure that it is refitted when the fuse is replaced.

If you lose the fuse cover the plug must not be used until a replacement cover is obtained

A replacement fuse cover can be purchased from your local Panasonic Dealer..

If the fitted moulded plug is unsuitable for the socket outlet in your home, then the fuse shall be removed and the plug cut off and disposed of safely. There is a danger of severe electrical shock if the cut off plug is inserted into any 13 amp socket.

If a new plug is to be fitted, please observe the wiring code as shown below.

If in any doubt, please consult a qualified electrician.

WARNING: — THIS APPARATUS MUST BE EARTHED.

IMPORTANT: — The wires in this mains lead are coloured in accordance with the following code: —

Green-and-Yellow:	Earth
Blue:	Neutral
Brown:	Live

As the colours of the wire in the mains lead of this appliance may not correspond with the coloured markings identifying the terminals in your plug, proceed as follows.

The wire which is coloured GREEN-AND-YELLOW must be connected to the terminal in the plug which is marked with the letter E or by the Earth symbol  or coloured GREEN or GREEN-AND-YELLOW.

The wire which is coloured BLUE must be connected to the terminal in the plug which is marked with the letter N or coloured BLACK.

The wire which is coloured BROWN must be connected to the terminal in the plug which is marked with the letter L or coloured RED.

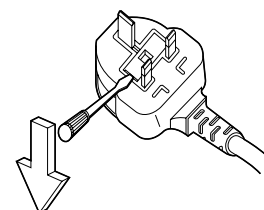

How to replace the fuse. Open the fuse compartment with a screwdriver and replace the fuse.

WARNING

Setup

This Wide Plasma Display is for use only with the following optional accessories. Use with any other type of optional accessories may cause instability which could result in the possibility of injury.

(All of the following accessories are manufactured by Matsushita Electric Industrial Co., Ltd.)

- Speakers TY-SP42PM3W (for Model No. TH-42PW3)
..... TY-SP42PWD3W (for Model No. TH-42PWD3)
- Pedestal TY-ST42PT3-S (for Model No. TH-42PW3)
..... TY-ST42PT3-K (for Model No. TH-42PWD3)
- Wall stand TY-ST42PW1
- Mobile stand TY-ST42PF3
- Wall-hanging bracket (vertical) TY-WK42PV1
- Wall-hanging bracket (angled) TY-WK42PR1
- Ceiling unit TY-CE42PS1

Always be sure to ask a qualified technician to carry out set-up.

Do not place the Wide Plasma Display on sloped or unstable surfaces.

- The Wide Plasma Display may fall off or tip over.

Do not place any objects on top of the Wide Plasma Display.

- If water is spilled onto the Wide Plasma Display or foreign objects get inside it, a short-circuit may occur which could result in fire or electric shock. If any foreign objects get inside the Wide Plasma Display, please consult your local Panasonic dealer.

If using the pedestal (optional accessory), leave a space of at least 10 cm at the top, left and right, at least 6 cm at the bottom, and at least 7 cm at the rear. If using some other setting-up method, leave a space of at least 10 cm at the top, bottom, left and right, and at least 1.9 cm at the rear.

When using the Wide Plasma Display

The Wide Plasma Display is designed to operate on 220 - 240 V AC, 50/60 Hz.

Do not cover the ventilation holes.

- Doing so may cause the Wide Plasma Display to overheat, which can cause fire or damage to the Wide Plasma Display.

Do not stick any foreign objects into the Wide Plasma Display.

- Do not insert any metal or flammable objects into the ventilations holes or drop them onto the Wide Plasma Display, as doing so can cause fire or electric shock.

Do not remove the cover or modify it in any way.

- High voltages which can cause severe electric shocks are present inside the Wide Plasma Display. For any inspection, adjustment and repair work, please contact your local Panasonic dealer.

Securely insert the power cord plug as far as it will go.

- If the plug is not fully inserted, heat may be generated which could cause fire. If the plug is damaged or the wall socket plate is loose, they should not be used.

Do not handle the power cord plug with wet hands.

- Doing so may cause electric shocks.

Do not do anything that may damage the power cable. When disconnecting the power cable, pull on the plug body, not the cable.

- Do not damage the cable, make any modifications to it, place heavy objects on top of it, heat it, place it near any hot objects, twist it, bend it excessively or pull it. To do so may cause fire and electric shock. If the power cable is damaged, have it repaired at your local Panasonic dealer.

If the Wide Plasma Display is not going to be used for any prolonged length of time, unplug the power cord plug from the wall outlet.

Warnings and Precautions

If problems occur during use

If a problem occurs (such as no picture or no sound), or if smoke or an abnormal odour starts to come out from the Wide Plasma Display, immediately unplug the power cord plug from the wall outlet.

- If you continue to use the Wide Plasma Display in this condition, fire or electric shock could result. After checking that the smoke has stopped, contact your local Panasonic dealer so that the necessary repairs can be made. Repairing the Wide Plasma Display yourself is extremely dangerous, and shall never be done.

If water or foreign objects get inside the Wide Plasma Display, if the Wide Plasma Display is dropped, or if the cabinet becomes damaged, disconnect the power cord plug immediately.

- A short circuit may occur, which could cause fire. Contact your local Panasonic dealer for any repairs that need to be made.

CAUTION

When using the Wide Plasma Display

Do not bring your hands, face or objects close to the ventilation holes of the Wide Plasma Display.

- Heated air comes out from the ventilation holes at the top of Wide Plasma Display will be hot. Do not bring your hands or face, or objects which cannot withstand heat, close to this port, otherwise burns or deformation could result.

Be sure to disconnect all cables before moving the Wide Plasma Display.

- If the Wide Plasma Display is moved while some of the cables are still connected, the cables may become damaged, and fire or electric shock could result.

Disconnect the power cord plug from the wall socket as a safety precaution before carrying out any cleaning.

- Electric shocks can result if this is not done.

Clean the power cable regularly to prevent it becoming dusty.

- If dust built up on the power cord plug, the resultant humidity can damage the insulation, which could result in fire. Pull the power cord plug out from the wall outlet and wipe the mains lead with a dry cloth.

Cleaning and maintenance

The front of the display panel has been specially treated. Wipe the panel surface gently using only a cleaning cloth or a soft, lint-free cloth.

- If the surface is particularly dirty, wipe with a soft, lint-free cloth which has been soaked in pure water or water to which a small amount of neutral detergent has been added, and then wipe it evenly with a dry cloth of the same type until the surface is dry.
- Do not scratch or hit the surface of the panel with fingernails or other hard objects, otherwise the surface may become damaged. Furthermore, avoid contact with volatile substances such as insect sprays, solvents and thinner, otherwise the quality of the surface may be adversely affected.

If the cabinet becomes dirty, wipe it with a soft, dry cloth.

- If the cabinet is particularly dirty, soak the cloth in water to which a small amount of neutral detergent has been added and then wring the cloth dry. Use this cloth to wipe the cabinet, and then wipe it dry with a dry cloth.
- Do not allow any detergent to come into direct contact with the surface of the Wide Plasma Display. If water droplets get inside the unit, operating problems may result.
- Avoid contact with volatile substances such as insect sprays, solvents and thinner, otherwise the quality of the cabinet surface may be adversely affected or the coating may peel off. Furthermore, do not leave it for long periods in contact with articles made from rubber or PVC.

CAUTION

This appliance is intended for use in environments which are relatively free of electromagnetic fields. Using this appliance near sources of strong electromagnetic fields or where electrical noise may overlap with the input signals could cause the picture and sound to wobble or cause interference such as noise to appear. To avoid the possibility of harm to this appliance, keep it away from sources of strong electromagnetic fields.

Accessories

Accessories Supply

Check that you have the accessories and items shown

Operating Instruction book

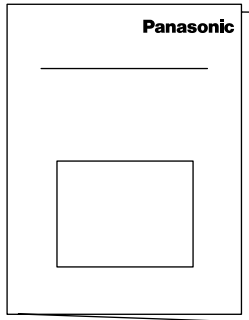

Remote Control Transmitter
EUR646525

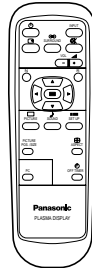

Batteries for the Remote
Control Transmitter
(2 × R6 Size)

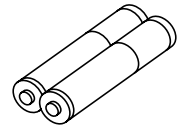

Guarantee Card
(for Model No. TH-42PW3 only)

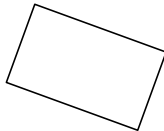

RCA-BNC adapter plug
(for Model No. TH-42PW3 only)



Optional Accessories

- Speakers

TY-SP42PM3W (for Model No. TH-42PW3)
TY-SP42PWD3W (for Model No. TH-42PWD3)

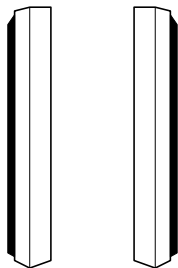

- Pedestal

TY-ST42PT3-S (for Model No. TH-42PW3)
TY-ST42PT3-K (for Model No. TH-42PWD3)



- Wall stand

TY-ST42PW1

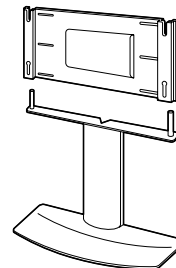

- Mobile stand
TY-ST42PF3

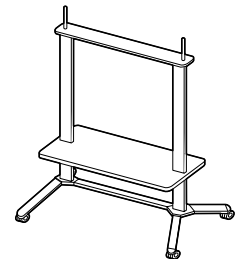

- Wall-hanging bracket
(vertical)

TY-WK42PV1

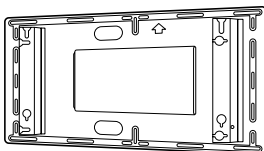

- Wall-hanging bracket
(angled)

TY-WK42PR1

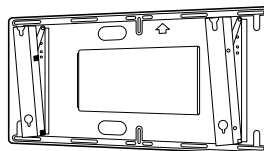

- Ceiling unit
TY-CE42PS1

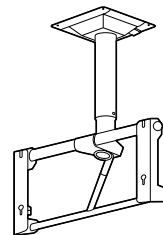

- Receiver
TU-PTA300B



For assembling

Full instructions are supplied with each optional accessory for use with this Wide Plasma Display.

Remote Control Batteries

Requires two R6 batteries.

1. Turn the transmitter face down. Press and slide off the battery cover.
2. Install the batteries as shown in the battery compartment. (Polarity + or – must match the markings in the compartment).
3. Replace the cover and slide in reverse until the lock snaps.

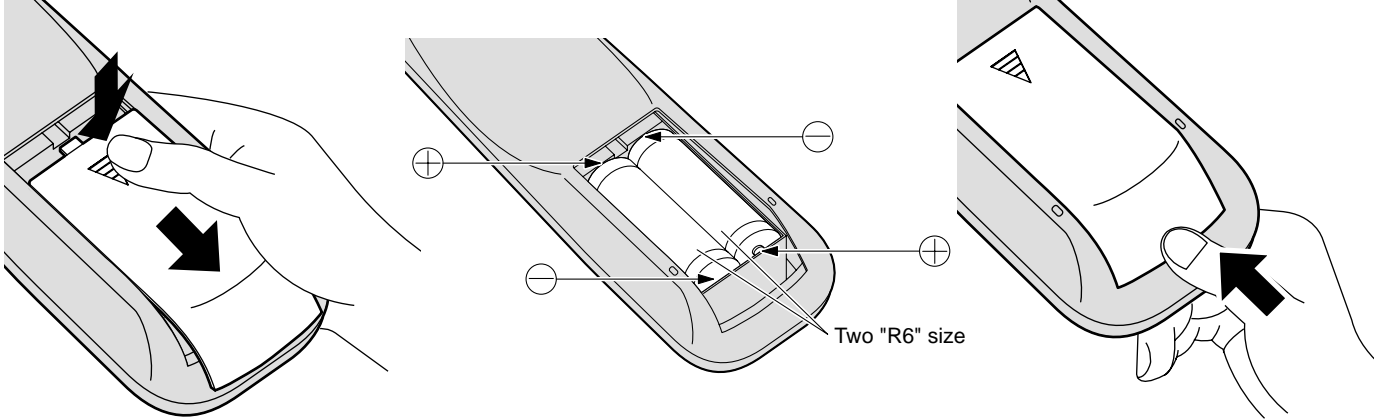

Helpful Hint:

For frequent remote control users, replace old batteries with Alkaline batteries for longer life.

⚠ Precaution on battery use

Incorrect installation can cause battery leakage and corrosion that will damage the remote control transmitter.

Observe the following precaution:

1. Batteries shall always be replaced as a pair. Always use new batteries when replacing the old set.
2. Do not combine a used battery with a new one.
3. Do not mix battery types (example: "Zinc Carbon" with "Alkaline").
4. Do not attempt to charge, short-circuit, disassemble, heat or burn used batteries.
5. Battery replacement is necessary when remote control acts sporadically or stops operating the Plasma Display set.

Basic Controls

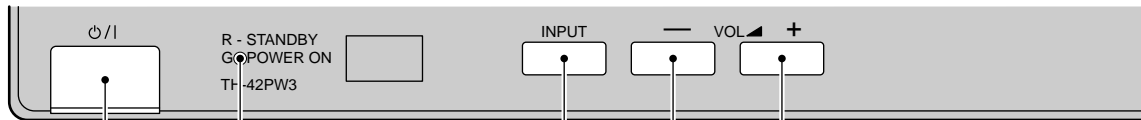

Main Power On/Off Switch

Power Indicator

The Power Indicator will light.

- Power-OFF ... Indicator not illuminated (The unit will still consume some power as long as the power cord is still inserted into the wall outlet.)
- Stand-by ϕ Red, Power-ON ... Green

Input button

(VIDEO (S-VIDEO)/COMPONENT, RGB/PC Mode Selection)

Push the "INPUT" button to select VIDEO(S-VIDEO)/COMPONENT or RGB/PC input signal modes sequentially.

Volume Adjustment

Push the Volume Up "+" or Down "-" button to increase or decrease the sound volume level.

Stand-by (ON/OFF) button

The Wide Plasma Display must first be plugged into the wall outlet and turn on at the power switch (see page 16).

Push this button to turn the Wide Plasma Display ON, from STANDBY mode. Push it again to turn the Wide Plasma Display OFF to STANDBY mode.

Status button

Push the "Status" button to display the current system status.

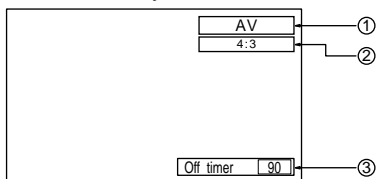

- ① VIDEO(S-VIDEO)/COMPONENT, RGB/PC mode
- ② Aspect mode (see page 20)
- ③ Off timer

The off timer indicator is displayed only when the off timer has been set.

N button

(see page 23, 24, 26, 27)

PICTURE button

(see page 26)

PICTURE POS./SIZE button

(see page 22)

PC button

Push the "PC" mode selection button to select the PC mode. This button is used to switch directly to PC mode.

SURROUND button (see page 25)

Input button (VIDEO(S-VIDEO)/COMPONENT, RGB/PC Mode Selection)

Press to select VIDEO(S-VIDEO)/COMPONENT or RGB/PC input signal modes sequentially. (see page 17)

Sound mute On/Off (see page 24)

Volume Adjustment

Press the Volume Up "+" or Down "-" button to increase or decrease the sound volume level.

R button

Access button

Press to make selections

POSITION buttons

SET UP button (see page 28)

SOUND button (see page 24)

ASPECT button

Press to adjust the aspect. (see page 20)

OFF TIMER button

The Wide Plasma Display may be preset to switch to stand-by after a fixed period. The setting changes to 30 minutes, 60 minutes, 90 minutes and 0 minutes (off timer cancelled) each time the button is pressed.

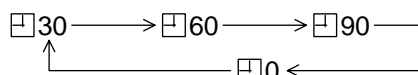

When three minutes remain, "Off timer 3" will flash. The off timer is cancelled if the main supply fails.

Connections

When connecting the speakers, be sure to use only the optional accessory speakers. Refer to the speaker's Installation Manual for details on speaker installation.

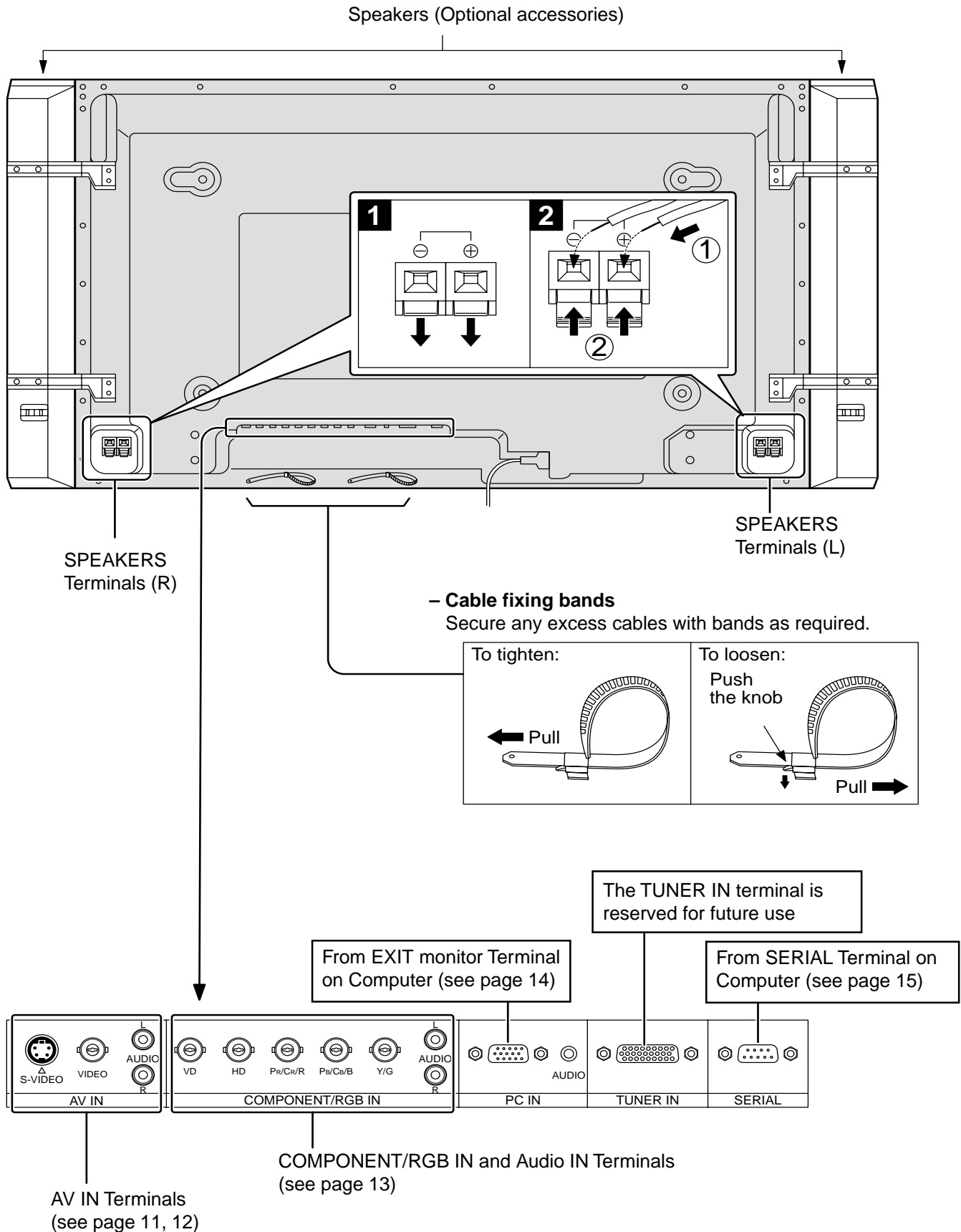

How to connect the AV Input Terminals

S-VIDEO Signal Connection

(Example) When connecting a S-Video VCR

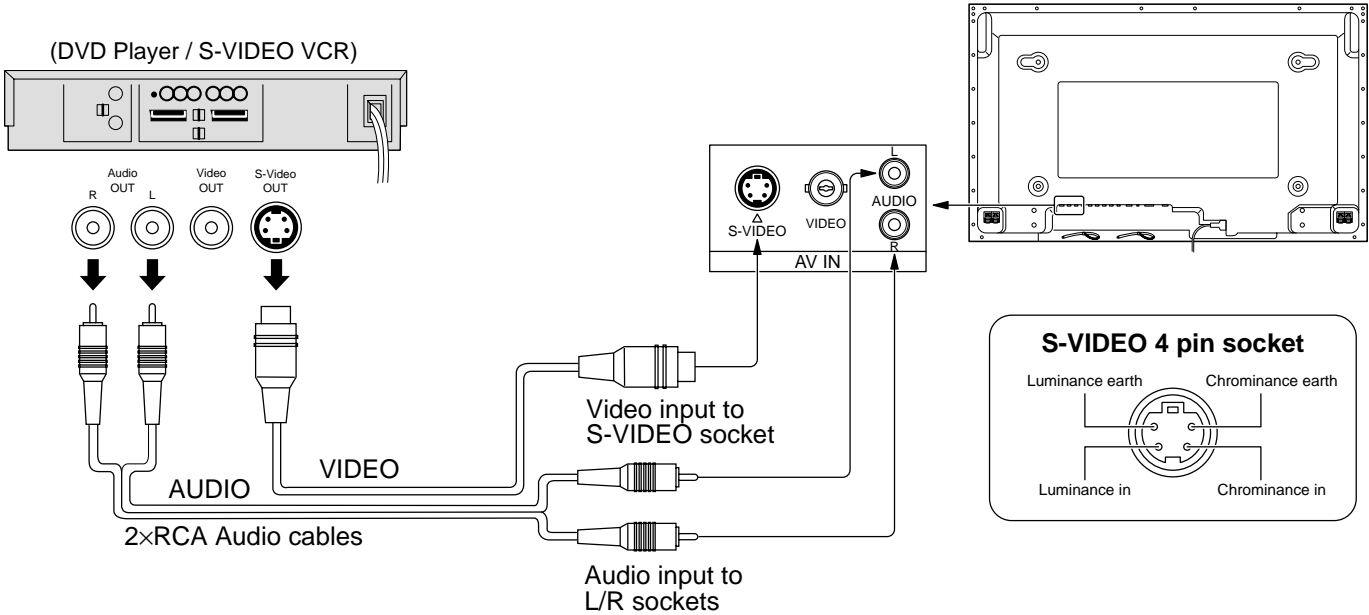

VIDEO Signal Connection

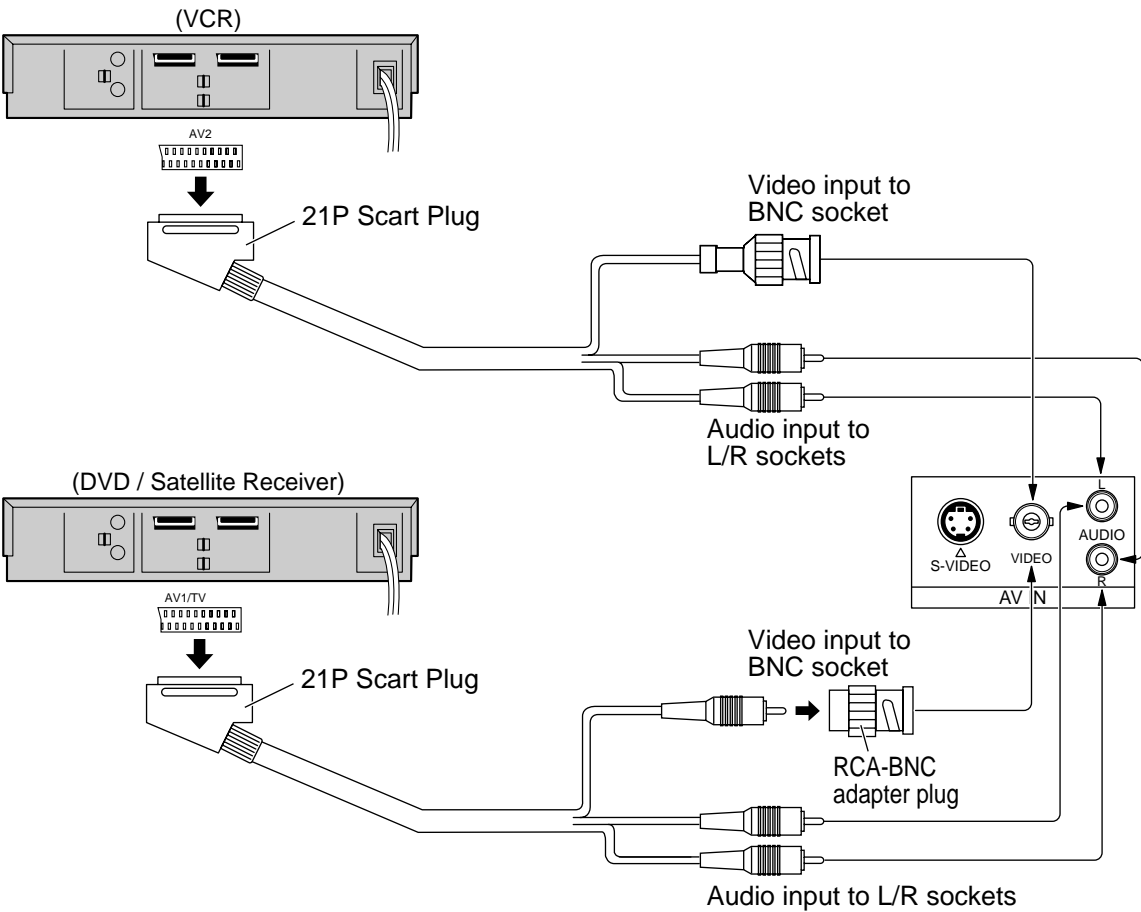

Note:
21 pin connectors / and 21 pin scart plugs are connectors used in Europe.

How to connect the COMPONENT/RGB Input Terminals

COMPONENT signal Connection

Example of input signal source

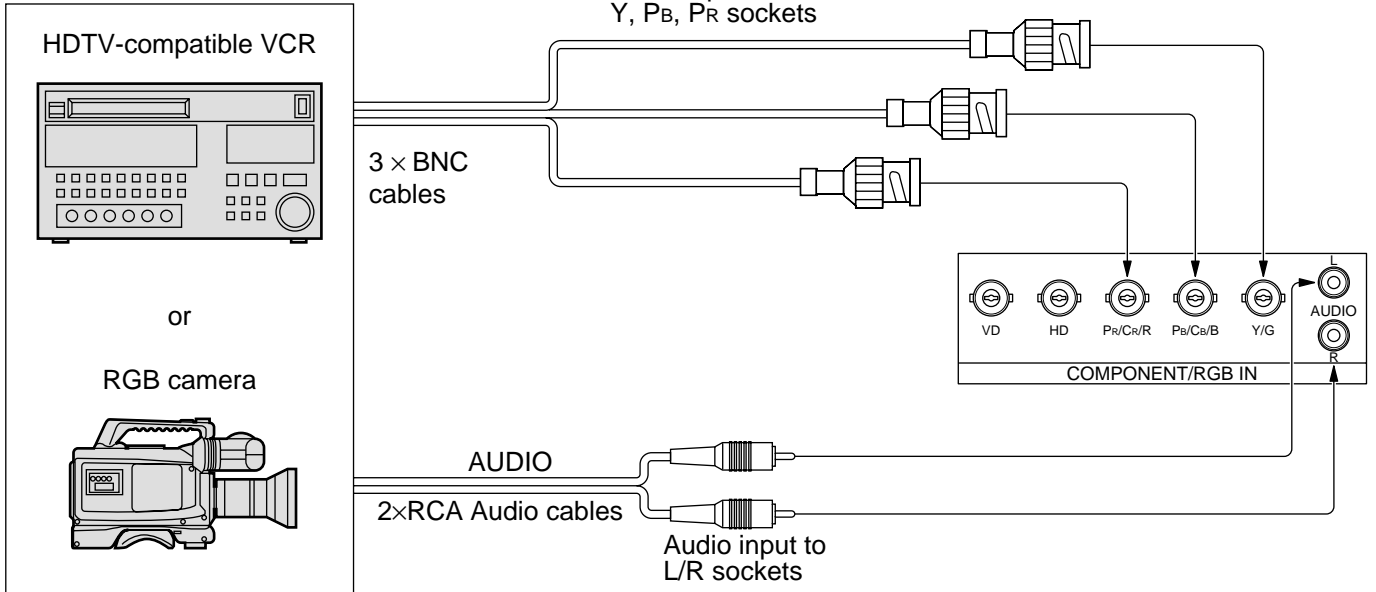

RGB signal (R, G, B, HD, VD) Connection

The TUNER input terminal is reserved for use with future external compatible components.

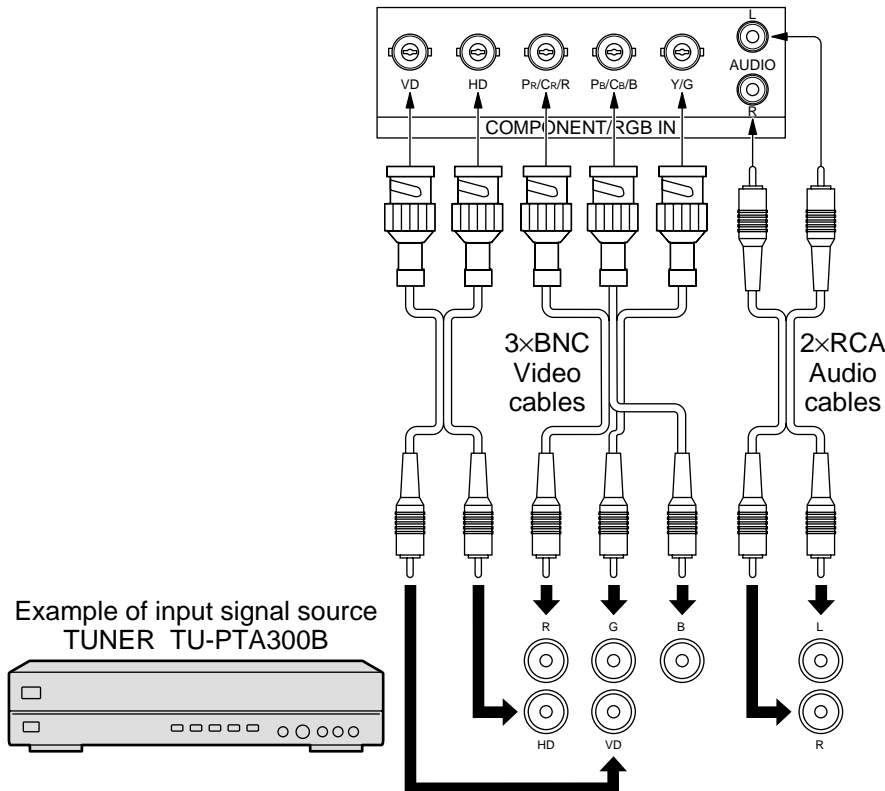

Notes:

- (1) Change the "Component/RGB in" setting in the "Setup" menu to "RGB". (see page 28, 30)
- (2) Additional equipment and cables shown are not supplied with this set.

VIDEO Signal Connection

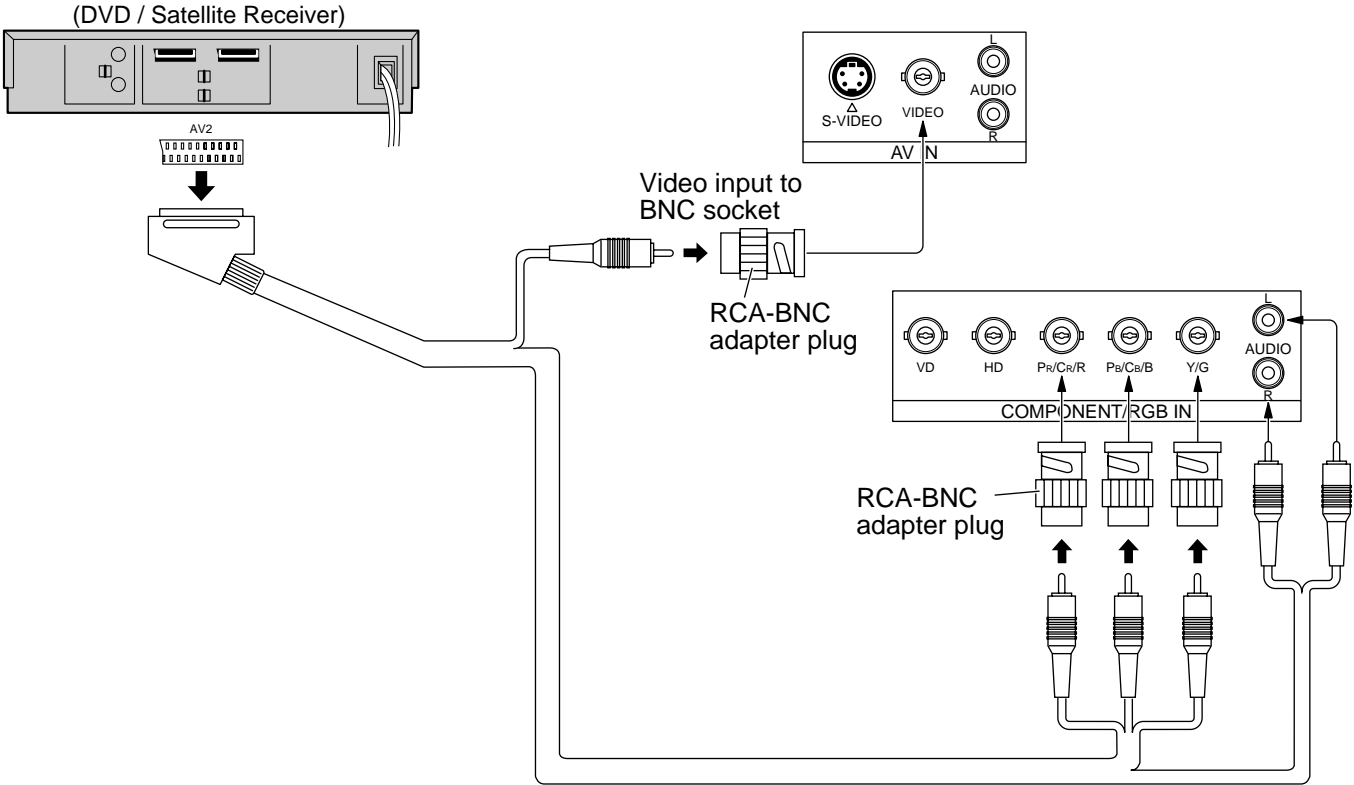

The cable shown is for connection detail only. If you wish to use this connection method, please consult your Dealer for the cable.
Select sync of VIDEO (see page 30).

Notes:

- (1) Additional equipment and cables shown are not supplied with this set.
- (2) 21 pin connectors and 21 pin scart plugs are connectors used in Europe.

How to connect the PC Input Terminals

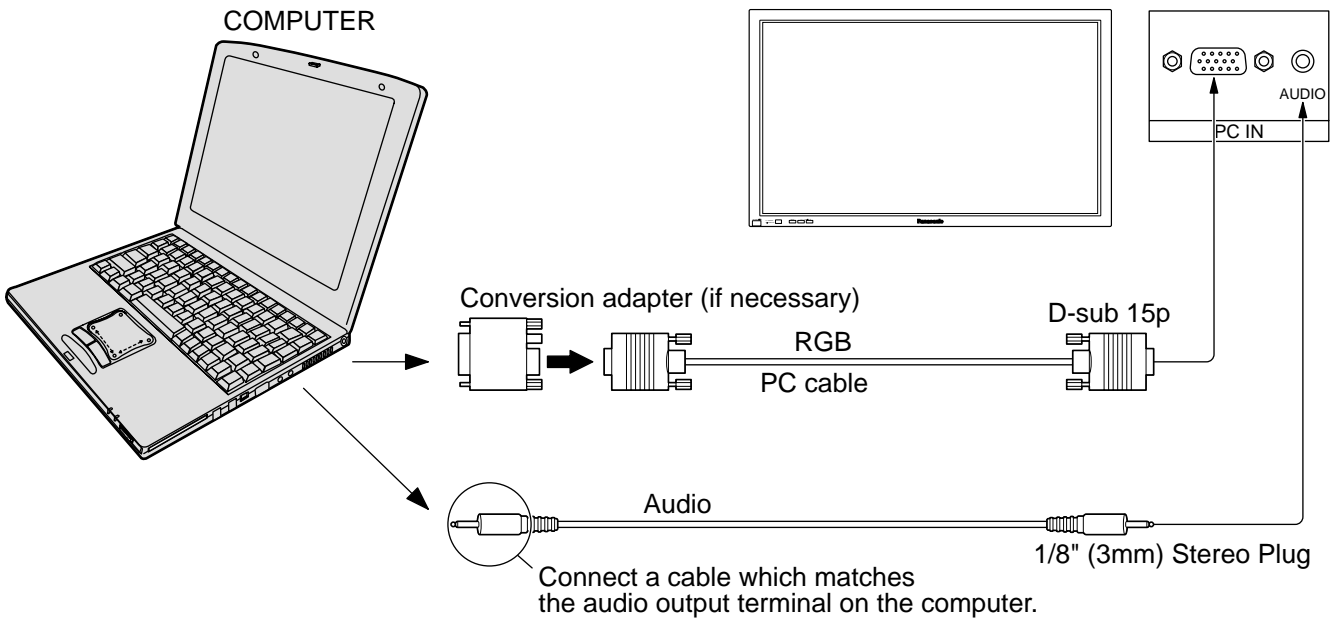

Notes:

- (1) Computer signals which can be input are those with a horizontal scanning frequency of 15.5 to 110 kHz and vertical scanning frequency of 48 to 120 Hz. (However, signals exceeding 1200 lines will not be displayed properly.)
- (2) The display resolution is a maximum 640×480 dots when the aspect mode is set to "4:3", and 852×480 dots when the aspect mode is set to "16:9". If the display resolution exceeds these maximums, it may not be possible to show fine detail with sufficient clarity.
- (3) The PC input terminals are DDC1/2B-compatible. If the computer being connected is not DDC1/2B-compatible, you will need to make setting changes to the computer at the time of connection.
- (4) Some PC models cannot be connected to the set.
- (5) An adapter is required to use the PC cable (D-sub 15P) to connect a Macintosh computer to the set.
- (6) There is no need to use an adapter for computers with DOS/V compatible D-sub 15P terminal.
- (7) The computer shown in the illustration is for example purposes only.
- (8) Additional equipment and cables shown are not supplied with this set.
- (9) Do not set the horizontal and vertical scanning frequencies for PC signals which are above or below the specified frequency range.

Signal Names for D-sub 15P Connector

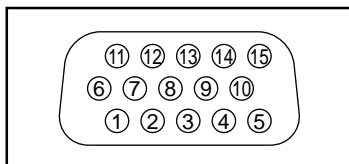

Pin Layout for PC Input Terminal

Pin No.	Signal Name	Pin No.	Signal Name	Pin No.	Signal Name
①	R	⑥	GND (Ground)	⑪	GND (Ground)
②	G	⑦	GND (Ground)	⑫	SDA
③	B	⑧	GND (Ground)	⑬	HD/SYNC
④	GND (Ground)	⑨	NC (not connected)	⑭	VD
⑤	GND (Ground)	⑩	GND (Ground)	⑮	SCL

How to connect the SERIAL Terminals

The SERIAL terminal is used when the Wide Plasma Display is controlled by a computer.

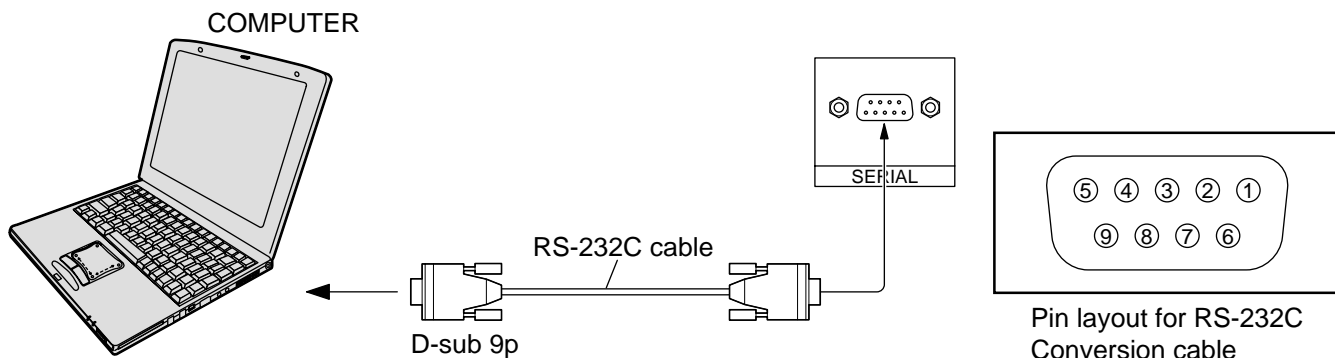

Notes:

- (1) Use the RS-232C cable to connect the computer to the Wide Plasma Display.
- (2) The computers shown is for example purposes only.
- (3) Additional equipment and cables shown are not supplied with this set.

The SERIAL terminal conforms to the RS-232C interface specification, so that the Wide Plasma Display can be controlled by a computer which is connected to this terminal. The computer will require software which allows the sending and receiving of control data which satisfies the conditions given below. Use a computer application such as a programming language to software. Refer to the documentation for the computer application for details.

Communication parameters

Signal level	RS-232C compliant
Synchronization method	Asynchronous
Baud rate	9600 bps
Parity	None
Character length	8 bits
Stop bit	1 bit
X parameter	None
S parameter	None

RS-232C Conversion cable	
D-sub 9-pin female	Details
②	R X D
③	T X D
⑤	GND
④ ⑥	Shorted
⑦ ⑧	Shorted
① • ⑨	NC

Basic format for control data

The transmission of control data from the computer starts with a STX signal, followed by the command, the parameters, and lastly an ETX signal in that order. If there are no parameters, then the parameter signal does not need to be sent.

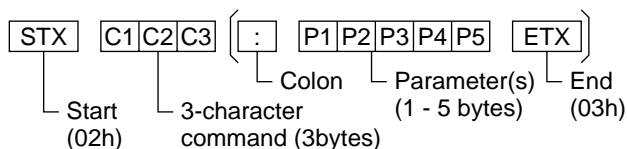

Notes:

- (1) If multiple commands are transmitted, be sure to wait for the response for the first command to come from this unit before sending the next command.
- (2) If an incorrect command is sent by mistake, this unit will send an "ER401" command back to the computer.

Command

Command	Parameter	Control details
PON	None	Power ON
POF	None	Power OFF
AUU	None	Volume increase
AUD	None	Volume decrease
AMT	None	Mute (toggle)
IIS	None VID YP1 RG1	Input select (toggle) AV Mode Component / RGB mode (processed as a Y/Pb/Pr or RGB signals as set by this unit) PC mode
DAM	None NORM ZOOM FULL JUST SELF	Screen mode select (toggle) Normal (4:3) Zoom Full Just Panasonic Auto

Power On/Off and input signal selection

Power On/Off

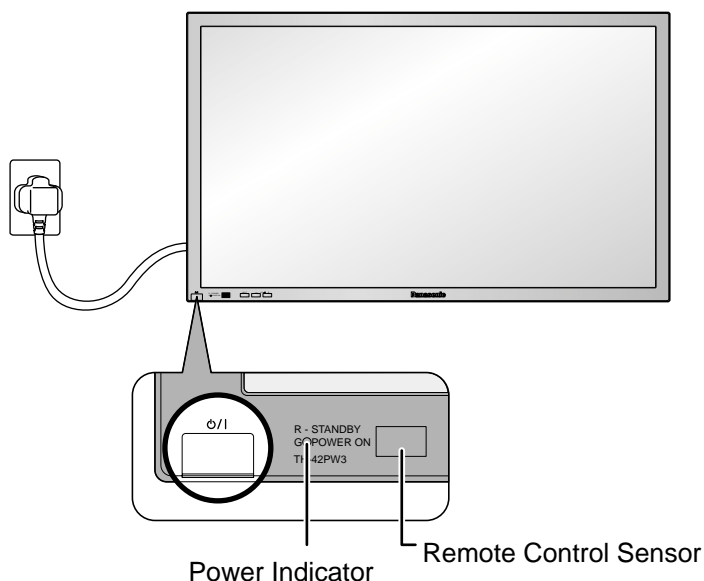

Connecting the plug to the Wall Outlet

Push the Power switch on the Wide Plasma Display to turn the set on Power-On

Power Indicator: Green

Example: The screen below is displayed for a while after the Wide Plasma Display is turned on. (setting condition is an example.)

When the Power is turned on for the first time, the Language selection screen is displayed.

From the second time on, language selection can be done from the setup menu. (see page 19)

Select the desired language using the ▲ and ▼ keys and press the store (■) button.



From the second time on, the below screen is displayed for a while (setting condition is an example).

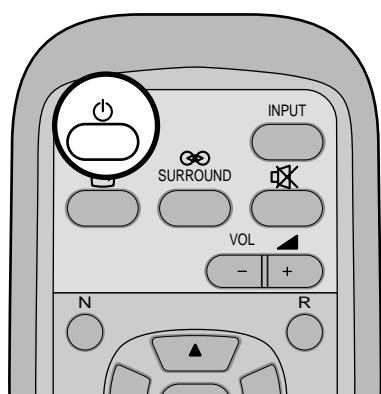
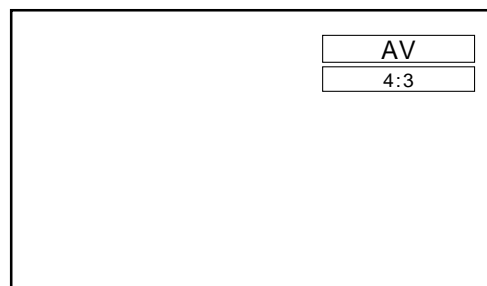

Press the  button on the remote control to turn the Wide Plasma Display off

Power Indicator: Red (standby)

Press the  button on the remote control to turn the Wide Plasma Display on

Power Indicator: Green

Turn the power to the Wide Plasma Display set off by pressing the  switch on the Wide Plasma Display, when the Wide Plasma Display is on or in standby mode.

Select the input signal

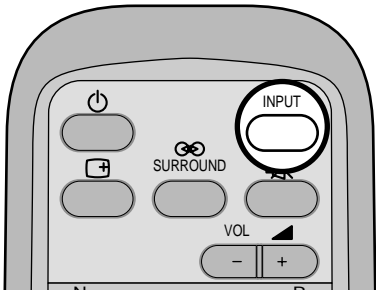
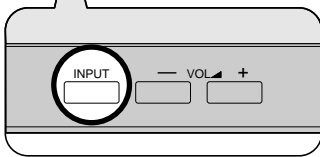
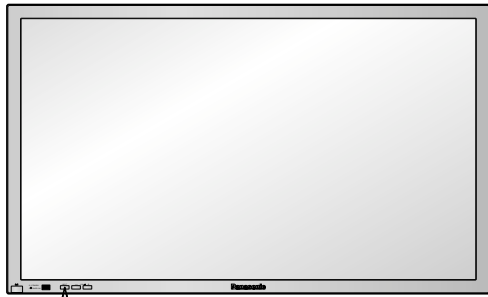

Press the INPUT button to select the input video signal to be played back from the equipment such as a VCR which has been connected to the Wide Plasma Display.

Input signals will change as follows:

For Component INPUT (see page 28)



For RGB INPUT (see page 28)



On screen Menu Display from Remote Control

To Picture adjust menu (see page 26)

For model No.TH-42PWD3

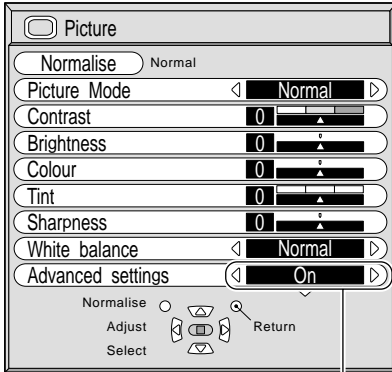

For model No.TH-42PW3

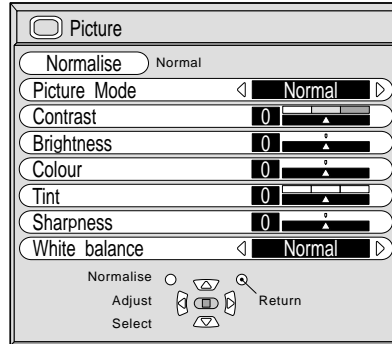

To Advanced settings menu (see page 27)

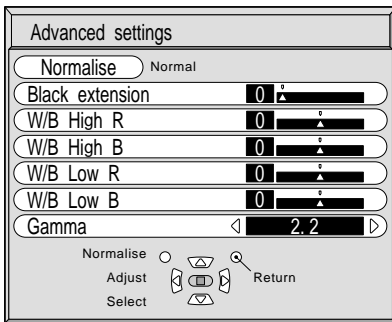

To Picture Pos./Size adjust menu (see page 22)

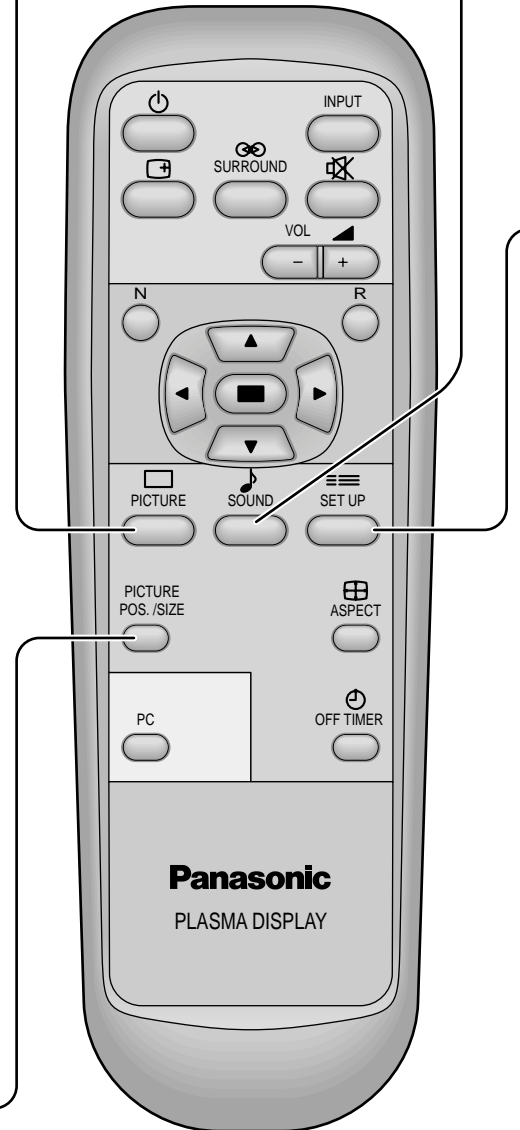
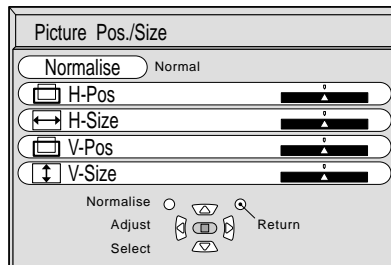

To Sound adjust screen (see page 24)

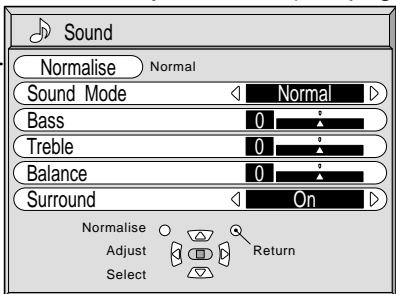

To Signal screen for AV (see page 29)

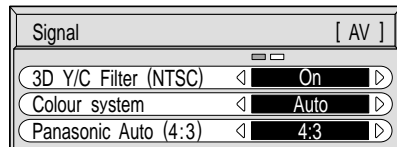

To Signal screen for Component (see page 30)

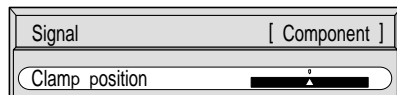

To Signal screen for RGB (see page 30)

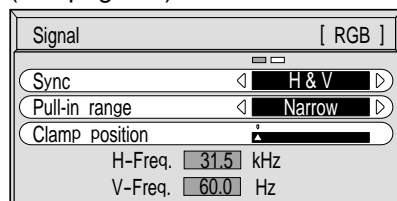

To Signal screen for PC (see page 30)

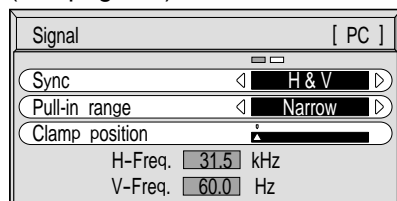

To Setup menu screen (see page 28)

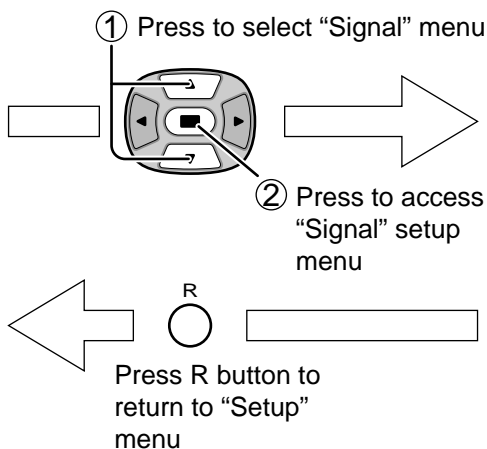
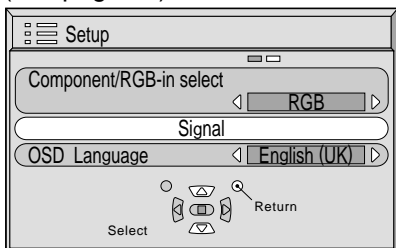

Note:
"Signal" setup menu is displayed by different setting condition for each input signals. (see page 17)

Selecting the On-Screen Menu Language

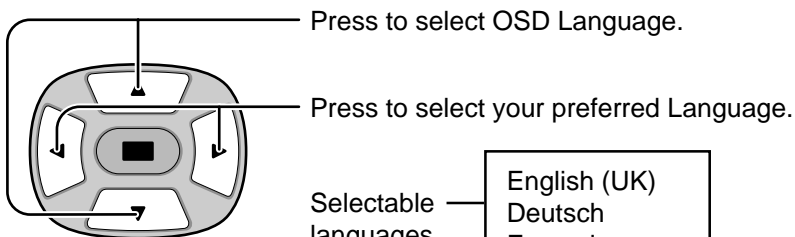
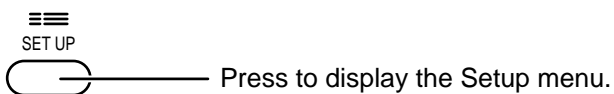

- Selectable languages
- English (UK)
 - Deutsch
 - Français
 - Italiano
 - Español
 - ENGLISH (US)
 - 日本語
- (Japanese)

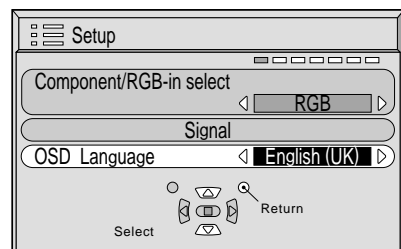

ASPECT Controls

Wide Plasma Display will allow you to enjoy viewing the picture at its maximum size, including wide screen cinema format picture.

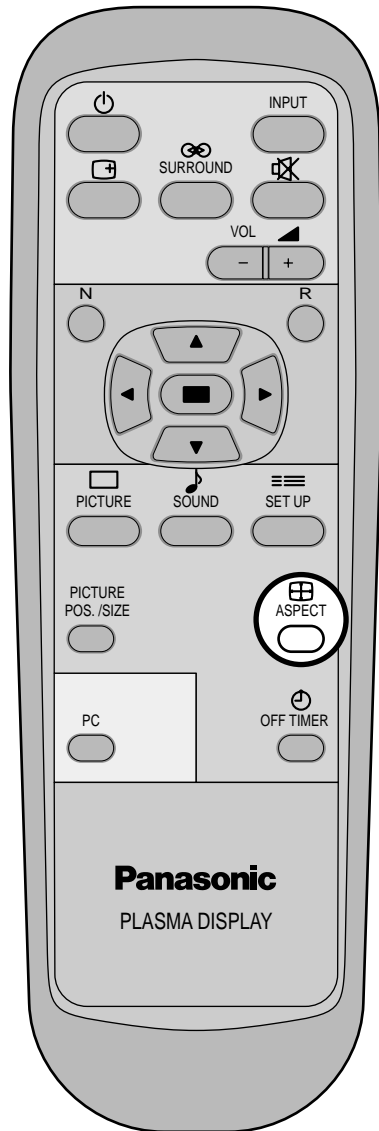

ASPECT button

The aspect mode changes each time the ASPECT button is pressed.

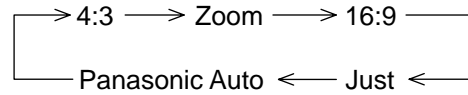

Notes:

- (1) During RGB and PC input signal mode, the mode switches between "4:3" and "16:9" only.
- (2) For a 525p (480p) signal input during "Component" input signal mode, the mode switches between "Zoom" and "16:9" only.
- (3) For a 1125i (1080i), 750p (720p) signal input during "Component" input signal mode, the mode is set to "16:9" mode, and switching is not possible.
For a 525i (480i), 625i (575i) signal input during "Component" input signal mode, "Panasonic Auto" can not be selected.
- (4) The aspect mode is memorized separately for each input terminal (AV, Component, RGB and PC).

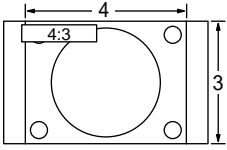
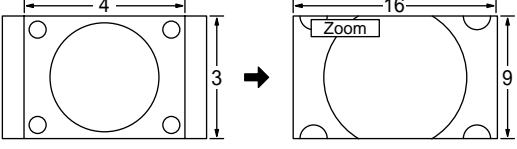
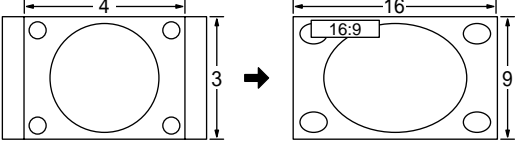
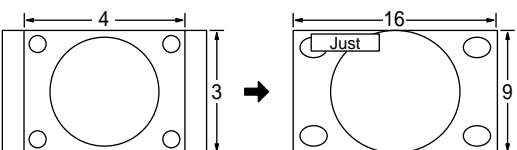
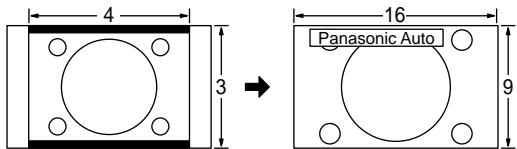
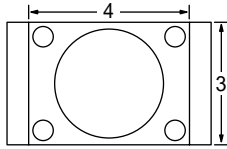
Mode	Picture	Explanation
4:3		4:3 will display a 4:3 picture at its standard 4:3 size.
Zoom		Zoom mode magnifies the central section of the picture.
16:9		16:9 will display the picture at its maximum size but with slight elongation.
Just		Just mode will display a 4:3 picture at its maximum size but with aspect correction applied to the center of the screen so that elongation is only apparent at the left and right edges of the screen. The size of the picture will depend on the original signal.
Panasonic Auto	 <p>For an elongated image</p> <p>Image is expanded</p>  <p>For a 4:3 image</p> <p>Changes in accordance with the Panasonic Auto mode setting (see page 29)</p>	<p>The display will automatically become enlarged (depending on the picture source), allowing you to view the picture at its maximum size.</p> <p>Note: Panasonic Auto Mode is designed to automatically adjust the aspect ratio to handle a mix of 16:9 and 4:3 program material. Certain 4:3 program material, such as stock market data screens, may occasionally cause the image size to change unexpectedly. When viewing such programs, it is recommended that the ASPECT be set to 4:3.</p>

Notes:

- (1) Do not allow the picture displayed in 4:3 mode for an extended period, as this can cause a permanent after-image to remain on the Plasma Display Panel.
- (2) The S-VIDEO terminal on this set can detect specially encoded signals that are compatible with a wide screen monitor. When a full image from the S-VIDEO terminal of specially encoded video is detected by the set, the screen size is automatically set to 16:9 mode.

Adjusting Picture Pos./Size

Adjusting screen

1



Press to select the screen mode to adjust. (see next page)

2

PICTURE
POS./SIZE



Press to display the Picture Pos./Size menu.

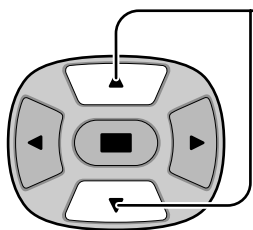

Press to select H-Pos/H-Size/V-Pos/V-Size/Clock Phase.

During "AV" and "Component"
input signal modes.

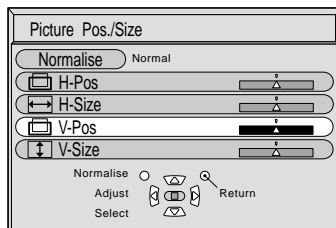

During "RGB" and "PC"
input signal modes.

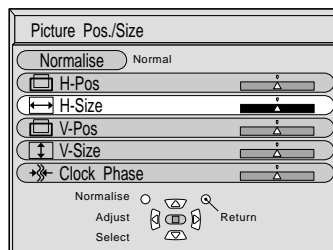

3

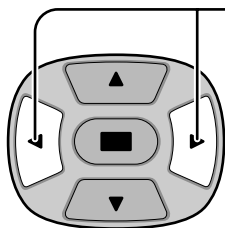

Press to adjust screen/position.
(see next page)



Press to exit from adjust mode.

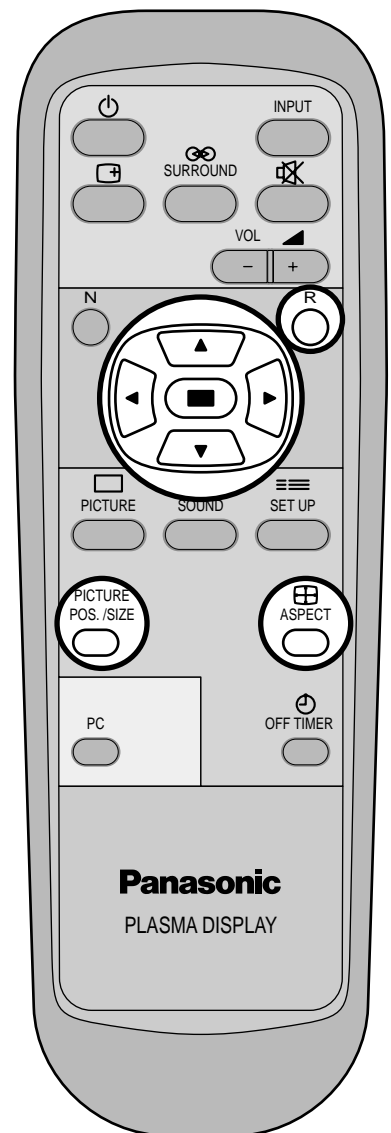

Notes:

- (1) Adjustment details are memorized separately for different input signal formats (Adjustments for component signals are memorized for 525i (480i), 625i (575i), 525p (480p), 1125i (1080i) and 750p (720p) each, and RGB/PC signals are memorized for each frequency.)
- (2) If a "Cue" or "Rew" signal from a VCR or DVD player is received, the picture position will shift up or down. This picture position movement cannot be controlled by the Picture Pos./Size function.

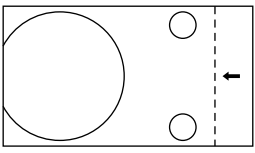
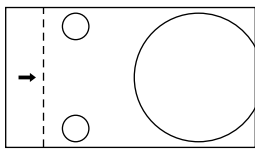
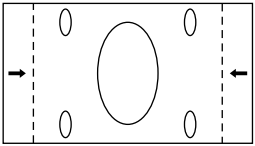
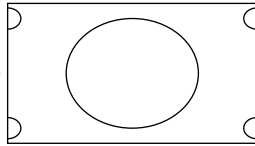
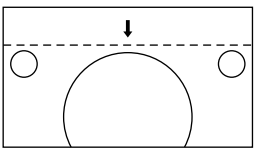
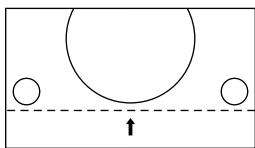
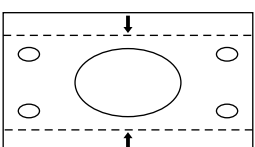
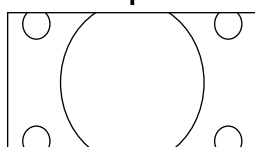
H-Pos	When the Position Left “◀” button is pressed 	When the Position Right “▶” button is pressed 
H-Size	When the Position Left “◀” button is pressed 	When the Position Right “▶” button is pressed 
V-Pos	When the Position Left “◀” button is pressed 	When the Position Right “▶” button is pressed 
V-Size	When the Position Left “◀” button is pressed 	When the Position Right “▶” button is pressed 
Clock Phase (RGB/PC in Mode)	Flickering and distortion can be eliminated by using the Position Left “◀” or Right “▶” button to carry out adjustment.	

Helpful Hint (/ Normalisation)

On the remote control unit, while the Picture Pos./Size display is active, if either the N button is pressed at any time or the  (Access button) is pressed during “Normalize”, then all adjustment values are returned to the factory settings.

Sound Adjustment

1 Press the SOUND  button to display the Sound Menu.

2 Select to adjust each item.

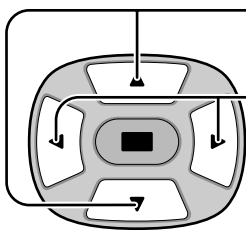

Press to select the desired adjustment menu to adjust.

Select the desired level by listening to the sound.

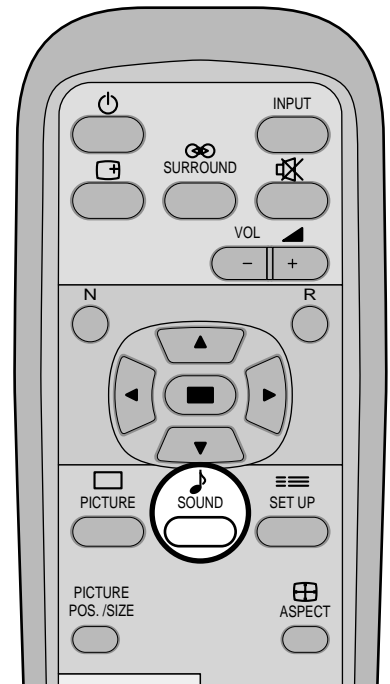

Bass

Adjusts low sounds

Treble

Adjusts high sounds

Balance

Adjusts left and right volumes

Surround (see next page)

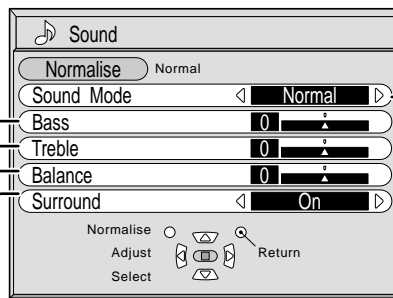

Normal

Emits the original sound.



Auto

Automatically proper controls volume level.

- To end adjustments



Press R button

Note:

Press the Surround button to directly turn the surround effect On and Off. (see next page)



Helpful Hint (/ Normalisation)

On the remote control unit, while the "Sound" menu is displayed, if either the N button is pressed at any time or the  (Access button) is pressed during "Normalise", then all adjustment values are returned to the factory settings.

Mute

Useful when answering the phone or receiving unexpected visitors



Press this button to mute the sound.

Press again to reactivate sound. Sound is also reactivated when power is turned off or volume level is changed.

Surround Controls



SURROUND Button

The benefits of surround sound are enormous. You can be completely enveloped in sound; just as if you were at a concert hall or cinema.

The surround setting switches on and off each time the SURROUND button is pressed.

On \longleftrightarrow Off

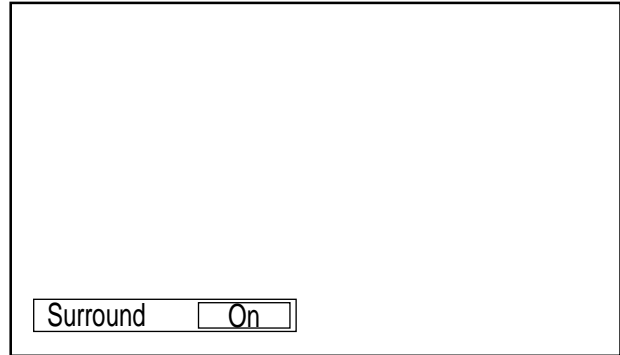

Note:

The surround setting are memorized separately for each Sound Mode (Auto, Normal).

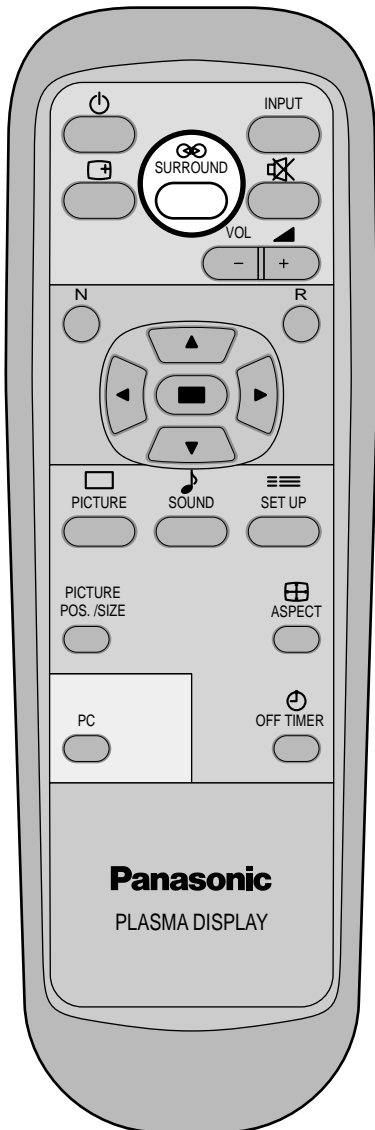

Picture Adjustments

1  Press to display the Picture menu.

2 Select to adjust each item.

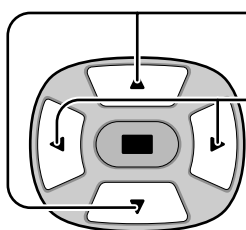
 Press to select the menu to adjust.
Select the desired level by looking at the picture behind the menu.

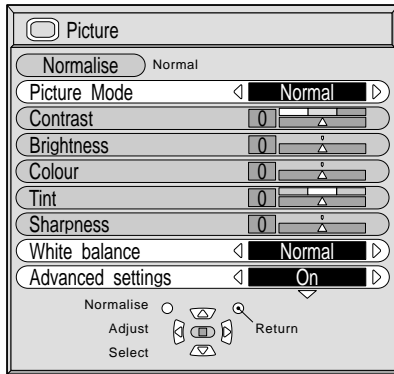
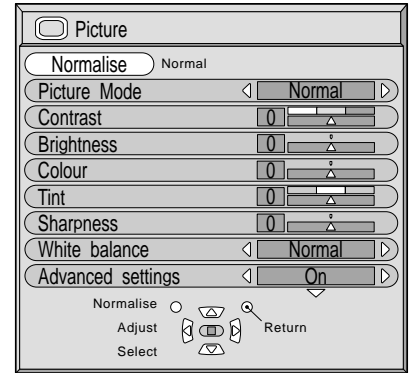

“TH-42PWD3” only
Press the left ◀ or right ▶ button to select “On”. Press the down ▼ button to enter Advanced Settings mode.
Advanced settings On
Enables fine picture adjustment at a professional level. (see next page)

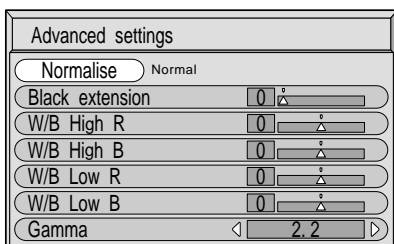

Advanced settings Off
Displays images with the selected setting of the Picture menu.

Press the left ◀ or right ▶ button to switch between modes.

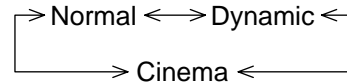

Normal

Normal

For viewing in standard (evening lighting) environments.
This menu selects the normal levels of Brightness and Contrast.

Dynamic

Dynamic

For viewing in brighter environments.
This menu select higher than normal levels of Brightness Contrast.

Cinema

Cinema

Ideal for movies.
● Can be selected for AV/Component.

Note:

If you would like to change the picture and colour of the selected Picture menu to something else, adjust using the “Picture” menu command in the Menu. (see next page)

Press the left ◀ or right ▶ button to switch between modes.

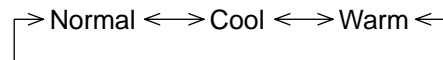

Helpful Hint (/ Normalisation)

On the remote control unit, while the “Picture” menu is displayed, if either the N button is pressed at any time or the  (Access button) is pressed during “Normalise”, then all adjustment values are returned to the factory settings.

Item	Effect	Adjustments
Contrast	Less More	Selects proper brightness and density for the room.
Brightness	Darker Brighter	Adjusts for easier viewing of dark pictures such as night scenes and hair.
Colour	Less More	Adjusts slightly to a lighter colour.
Tint (NTSC only)	Reddish Greenish	Adjust for nice skin colour.
Sharpness	Less More	Displays a sharp image.

Notes:

- (1) "Colour" and "Tint" and "Sharpness" settings cannot be adjusted "RGB" and "PC" input signal modes.
- (2) You can change the level of each Function (Contrast, Brightness, Colour, Tint, Sharpness) for each Picture Menu.
- (3) The setting details for Normal, Dynamic and Cinema respectively are memorized separately for each input terminal (AV, Component, RGB and PC).
- (4) The "Tint" setting can be adjusted for NTSC signal only.

Note:

There is little change when contrast is increased with a bright picture or reduced with a dark picture.

Advanced settings (Model "TH-42PWD3" only)

Item	Effect	Details
Black Extension	Less More	Adjusts the dark shades of the image in gradation.
W/B High R	Less More	Adjusts the white balance for light red areas.
W/B High B	Less More	Adjusts the white balance for light blue areas.
W/B Low R	Less More	Adjusts the white balance for dark red areas.
W/B Low B	Less More	Adjusts the white balance for dark blue areas.
Gamma	Down Up	2.0 ↔ 2.2 ↔ 2.5

Notes:

- (1) Carry out "W/B" adjustment as follows.
 - Ⓐ Adjust the white balance of the bright sections using the "W/B High R" and "W/B High B" settings.
 - Ⓑ Adjust the white balance of the dark sections using the "W/B Low R" and "W/B Low B" settings.
 - Ⓒ Repeat steps Ⓐ and Ⓑ to adjust.

Steps Ⓐ and Ⓑ affect each other's settings, so repeat each step in turn to make the adjustment.
- (2) The adjustment values are memorized separately for each input terminal (AV, Component, RGB and PC).
- (3) The adjustment range values should be used as an adjustment reference.

Helpful Hint (/ Normalisation)

On the remote control unit, while the "Advanced settings" menu is displayed, if either the N button is pressed at any time or the (Access button) is pressed during "Normalise", then all adjustment values are returned to the factory settings.

Setup for input signals

Component/RGB-in select

Select to match the signals from the source connected to the Component/RGB input terminals.

Y, PB, PR signals ⇨ "Component"

R, G, B, HD, VD signals ⇨ "RGB"

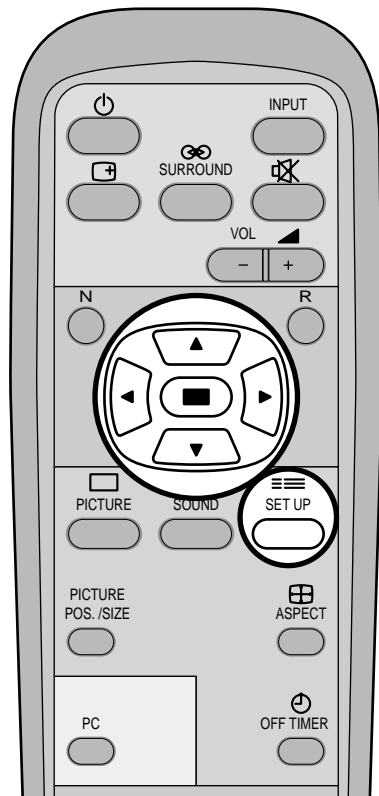

1  Press to display the Setup menu screen.

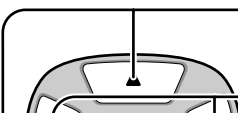
2  Press to select the "Component/RGB-in select".
Press to select the required mode.

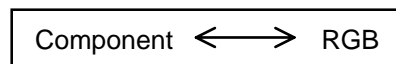
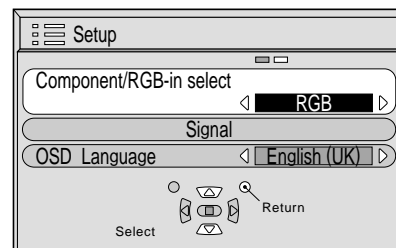

 Press to exit from adjust mode.

Adjusting unnatural video images (3D Y/C Filter)

Select the Signal from the "Setup" menu during AV (S-Video) input signal mode. ("Signal [AV]" menu is displayed.)

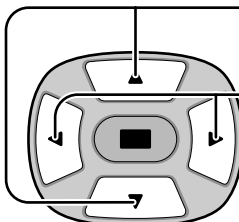
 Press to select the "3D Y/C Filter (NTSC)"
Press to set On/Off.

 Press to exit from adjust mode.

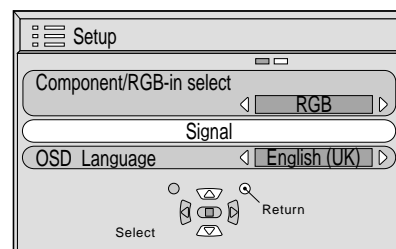

↓ Press  (store) button

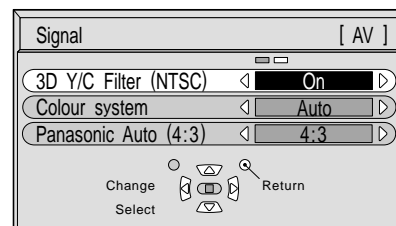

Colour system / Panasonic Auto

Select the Signal from the "Setup" menu during AV (S-Video) input signal mode. ("Signal [AV]" menu is displayed.)

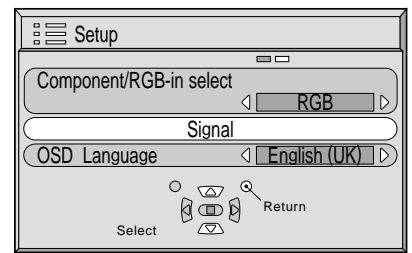
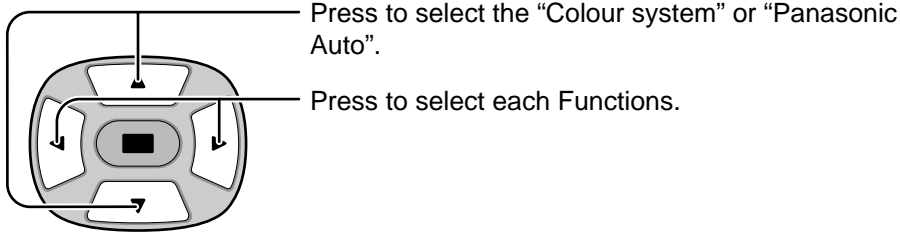

↓ Press (store) button

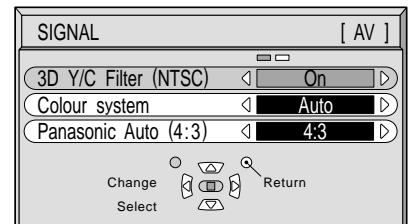

Mode	Function
Colour system	Set the colour system to match the input signal. If set to "Auto", the colour system is determined automatically. <div style="text-align: center;"> </div>
Panasonic Auto (4:3)	Set to "4:3" to view 4:3 images in an unchanged format when Panasonic Auto is selected. If you would like to view 4:3 images in "Just" format, set to "Just".

Setup for input signals

Select the Signal from the "Setup" menu during RGB or PC input signal mode.

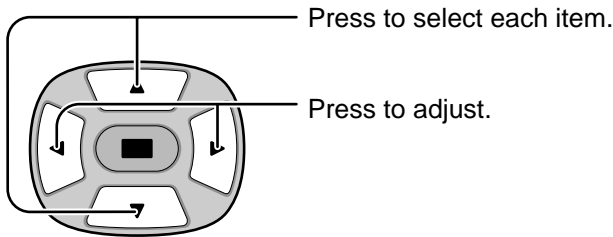

The following operation methods are the same for both the Signal [RGB] and Signal [PC].

(TH-42PWD3 only)

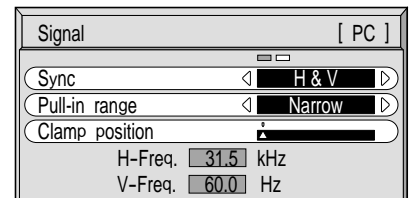
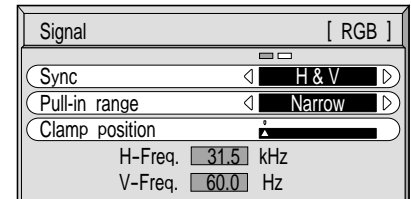
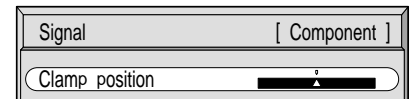

SYNC

Setting RGB sync signal setting:

Confirm that the input is set to RGB input (this setting is valid only for RGB input).

- H&V: The H and V sync signals are input from the HD/VD (BNC) connector.
- On G: Uses a synchronized signal on the Video G signal, which is input from the G (BNC) connector.
- On VIDEO: Compatible with the scart plug (Europe)
The composite video signal input from the VIDEO input terminal is used by dividing the sync signals.

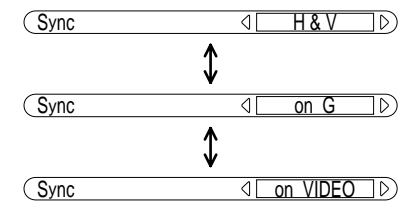

Setting PC sync signal setting:

Confirm that the input is set to PC input (this setting is valid only for PC input).

- H&V: The H and V sync signals are input from the HD/VD (BNC) connector.
- ON G: Uses a synchronized signal on the Video G signal, which is input from the G (BNC) connector.

Pull-in range

Sets the width for different frequencies.

(This setting is the same for both Signal [RGB] and Signal [PC].)

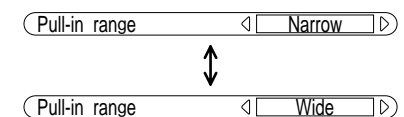

Clamp position

Adjusts the clamp position.

The following operation methods are the same for "Signal" menu during Component (TH-42PWD3 only), RGB and PC input signal mode. Normally, these adjustments are set to appropriate levels and therefore do not need to be altered.



H-Freq. (kHz)/V-Freq. (Hz)

Displays the H (horizontal)/V (vertical) frequencies.

This display is valid only for RGB input and PC input.





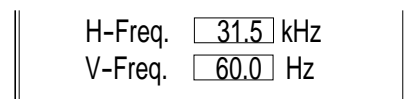

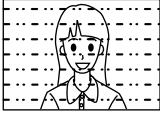
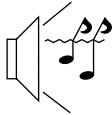

Display range:

- Horizontal 15.5 - 110 kHz
- Vertical 48 - 120 Hz

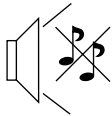

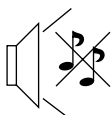

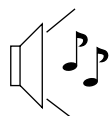
Troubleshooting

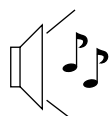
Before you call for service, determine the symptoms and make a few simple checks as shown below.

Symptoms		Checks
Picture	Sound	
 Interface	 Noisy Sound	Electrical Appliances Cars/Motorcycles Fluorescent light
 Normal Picture	 No Sound	Volume (Check whether the mute function has been activated on the Remote Control.)
 No Picture	 No Sound	Not plugged into AC outlet Not switched on Contrast and Brightness/Volume setting (Check by pushing the Power Switch or Stand-by Button on the Remote Control.)
 No Picture	 Normal Sound	If a signal with a non-applicable colour system format, or frequency is input, only the input terminal indication is displayed.
 No Colour	 Normal Sound	Colour controls set at minimum level. Colour System (see page 26, 27)

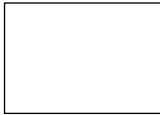
Plasma Display panel

Symptoms	Check
 Some parts of the screen do not light up	The plasma display panel is manufactured using an extremely high level of precision technology, however sometimes some parts of the screen may be missing picture elements or have luminous spots. This is not a sign of a malfunction.
 Afterimages appear	Do not allow a still picture to be displayed for an extended period, as this can cause a permanent after-image to remain on the Wide Plasma Display. Examples of still pictures include logos, video games, computer images, teletext and images displayed in 4:3 mode.

Specifications

	TH-42PW3	TH-42PWD3
Power Source	220 – 240 V AC, 50/60 Hz	
Power Consumption		
Normal use	295 W	
Stand-by condition	2.3 W	
Power off condition	1.4 W	
Plasma Display panel	Drive method AC type 42-inch, 16:9 aspect ratio	
Contrast Ratio	3000:1	
Brightness Capability	(Panel only) 650 / m ² (As a set) 400 / m ²	
Screen size	920 mm (W) × 518 mm (H) × 1056 mm (diagonal) No. of pixels 408,960 (852 (W) × 480 (H)) [2,556 × 480 dots]	
Operating condition		
Temperature	0 °C - 40 °C	
Humidity	20 % - 80 %	
Applicable signals		
Colour System	NTSC, PAL, PAL60, SECAM, Modified NTSC	
Scanning format	525i (480i), 625i (575i), 525p (480p), 750p (720p), 1125i(1080i)	
PC signals	VGA SVGA, XGA, SXGA, UXGA (compressed) Horizontal scanning frequency 15.5 - 110 kHz Vertical scanning frequency 48 - 120 Hz	
Connection terminals		
AV	Video IN (BNC) S-Video IN (MINI DIN 4PIN) AUDIO IN (RCA PIN JACK × 2)	1.0 Vp-p Y: 1 Vp-p (75 Ω), C: 0.286 Vp-p (75 Ω) 0.5 Vrms
COMPONENT/RGB	Y/G (BNC) Pb/B (BNC) Pr/R (BNC) HD VD AUDIO IN (RCA PIN JACK × 2)	1.0 Vp-p/0.7 Vp-p ± 0.35 Vp-p/0.7 Vp-p ± 0.35 Vp-p/0.7 Vp-p ± 1.0 - 5.0 Vp-p ± 1.0 - 5.0 Vp-p 0.5 Vrms
PC	(HIGH-DENSITY D-SUB 15PIN) AUDIO IN (M3.5 JACK)	R,G,B Video/0.7 Vp-p HD, VD/± 1.0 - 5.0 Vp-p 0.5 Vrms
TUNER	OPTIONAL (HIGH-DENSITY D-SUB 26PIN)	
SERIAL	EXTERNAL CONTROL TERMINAL (D-SUB 9PIN) RS-232C COMPATIBLE	
SPEAKERS (6 Ω)	16W [8 W + 8 W] (10 % THD) For TY-SP42PM3W only	16W [8 W + 8 W] (10 % THD) For TY-SP42PWD3W only
Accessories Supplied		
Remote control Transmitter	EUR646525	EUR646525
Batteries	2 × R6 Size	2 × R6 Size
RCA-BNC adaptor plug	TJS1A4270	—

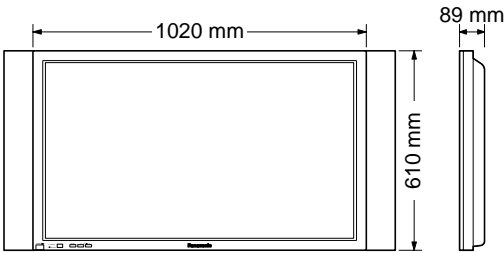
	TH-42PW3	TH-42PWD3
Optional Supplied		
Speakers	TY-SP42PM3W	TY-SP42PWD3W
Pedestal	TY-ST42PT3-S	TY-ST42PT3-K
Wall stand	TY-ST42PW1	
Mobile stand	TY-ST42PF3	
Wall-hanging bracket (vertical)	TY-WK42PV1	
Wall-hanging bracket (angled)	TY-WK42PR1	
Ceiling unit	TY-CE42PS1	
Terminal Cover	–	TY-UPS200
Dimensions (W × D × H)	1020 mm × 610 mm × 89 mm 	
Weight (Mass)	approx. 29.5 kg net (main unit only) approx. 33.7 kg (with speakers)	

Notes:

- (1) Design and specifications are subject to change without notice. Weight and dimensions shown are approximate.
- (2) This equipment complies with the EMC standards listed below.
 EN55022, EN61000-3-2, EN61000-3-3, EN61000-6-2.

MEMO

A series of horizontal dashed lines for writing.

Lined area for writing notes, consisting of 20 horizontal dashed lines.

Customer' Record

The model number and serial number of this product can be found on its back cover. You should note this serial number in the space provided below and retain this book, plus your purchase receipt, as a permanent record of your purchase to aid in identification in the event of theft or loss, and for Warranty Service purposes.

Model Number _____

Serial Number _____

Panasonic (U.K.) Ltd.Willoughby Road, Bracknell,
Berks RG12 8FP**Matsushita Electric Industrial Co., Ltd.**

Central P.O. Box 288, Osaka 530-8692, Japan