

The illustration shows SC-HT545.



Operating Instructions DVD Home Theater Sound System

Model No. **SC-HT545/
SC-HT545W**

Region number

The player plays DVD-Video marked with labels containing the region number or "ALL".

Region	Number
Continental Europe	2
Australia and N.Z.	4

Example: **Continental Europe**



*Wireless system and digital transceiver** page **6**
Wireless surround speaker connection. (*Sold separately for SC-HT545.)

Advanced progressive scan page **8**
Provides a smoother and sharper image.

Compatible with a variety of media formats page **12**
DVD-RAM, DVD-Audio, DVD-Video, DivX and more.

High-performance sound effects page **28**
Sound quality enhancement, Dolby Pro Logic II and more.

Before connecting, operating or adjusting this product, please read the instructions completely. Please keep this manual for future reference.

Dear customer

Thank you for purchasing this product. For optimum performance and safety, please read these instructions carefully.

- These operating instructions are applicable to models SC-HT545 and SC-HT545W for a variety of regions.
- Unless otherwise indicated, illustrations in these operating instructions are of SC-HT545.
- Operations in these instructions are described mainly with the remote control, but you can perform the operations on the main unit if the controls are the same.

HT545 : indicates features applicable to SC-HT545 only.
HT545W : SC-HT545W only.

System	SC-HT545	SC-HT545W
Main unit	SA-HT545	SA-HT545
Front speakers	SB-FS440	SB-FS640
Center speaker	SB-PC640	SB-PC545
Surround speakers	SB-FS441	SB-FS545
Subwoofer	SB-W440	SB-W545
Wireless system	—	SE-FX60
Digital transceiver	—	SH-FX80T

CAUTION!

THIS PRODUCT UTILIZES A LASER.
 USE OF CONTROLS OR ADJUSTMENTS OR PERFORMANCE OF PROCEDURES OTHER THAN THOSE SPECIFIED HEREIN MAY RESULT IN HAZARDOUS RADIATION EXPOSURE.
 DO NOT OPEN COVERS AND DO NOT REPAIR YOURSELF.
 REFER SERVICING TO QUALIFIED PERSONNEL.

WARNING:

TO REDUCE THE RISK OF FIRE, ELECTRIC SHOCK OR PRODUCT DAMAGE, DO NOT EXPOSE THIS APPARATUS TO RAIN, MOISTURE, DRIPPING OR SPLASHING AND THAT NO OBJECTS FILLED WITH LIQUIDS, SUCH AS VASES, SHALL BE PLACED ON THE APPARATUS.

CAUTION!

- DO NOT INSTALL OR PLACE THIS UNIT IN A BOOKCASE, BUILT-IN CABINET OR IN ANOTHER CONFINED SPACE. ENSURE THE UNIT IS WELL VENTILATED. TO PREVENT RISK OF ELECTRIC SHOCK OR FIRE HAZARD DUE TO OVERHEATING, ENSURE THAT CURTAINS AND ANY OTHER MATERIALS DO NOT OBSTRUCT THE VENTILATION VENTS.
- DO NOT OBSTRUCT THE UNIT'S VENTILATION OPENINGS WITH NEWSPAPERS, TABLECLOTHS, CURTAINS, AND SIMILAR ITEMS.
- DO NOT PLACE SOURCES OF NAKED FLAMES, SUCH AS LIGHTED CANDLES, ON THE UNIT.
- DISPOSE OF BATTERIES IN AN ENVIRONMENTALLY FRIENDLY MANNER.



LUOKAN 1 LASERLAITE KLASS 1 LASER APPARAT

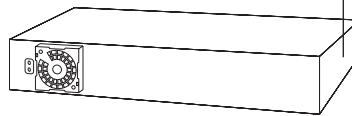

(Side of product)

CAUTION	- LASER RADIATION WHEN OPEN. DO NOT STARE INTO BEAM.	FDA 21 CFR / Class
CAUTION	- CLASS 1M VISIBLE AND INVISIBLE LASER RADIATION WHEN OPEN. DO NOT VIEW DIRECTLY WITH OPTICAL INSTRUMENTS.	IEC60825-1 +A2/ Class 1M
VARNING	- KLASS 1M SYNLAG OCH OSYNLAG LASERSTRÅLNING NÄR DENNA DEL ÄR ÖPPNAD. BETRÄKTA EJ STRÅLEN DIREKT GENOM OPTISKT INSTRUMENT.	
FORSIGTIG	- SPILIG OG OSYNLIG LASERSTRÅLING KLASS 1M. NÅR LAGET ER ÅBENT, UNDGÅ AT SE UDEN OPTISKE INSTRUMENTER.	
VARO!	- HUHTAESSA OLET SUORITTA LUOKAN 1M NÄKYNÄKÄ JA NÄKYMÄTÖNTÄ LASERSÄTELLÄ. ÄLÄ KATSO OPTISELLÄ LAITTEELLA SUORAAN SÄTEESEEN.	
VORSICHT	- SICHTBARE UND UNSICHTBARE LASERSTRÄHLUNG KLASSE 1M. WENN ABDECKUNG GEÖFFNET, NICHT DIREKT MIT OPTISCHEN INSTRUMENTEN BETRACHTEN.	
ATTENTION	- RAYONNEMENT LASER VISIBLE ET INVISIBLE - CLASSE 1M. EN CAS D'OUVERTURE, NE PAS REGARDER DIRECTEMENT À L'AVEC D'INSTRUMENTS D'OPTIQUE.	
注意	- ここを開くと可視及び不可視レーザー光が出ます。 ビームを覺たり、離れたりしないでください。	
注意	- 打开時可见及不可见激光辐射。避免直视照射。	GB7243.1-2001/3B 类 RCLX50075

(Inside of product)
 (Produktets insida)
 (Tuotteen sisällä)

Accessories

Please check and identify the supplied accessories.



- 1 Remote control
HT545 (N2QAYZ000004)
HT545W (N2QAYZ000005)



- 2 Remote control batteries



- 1 AM loop antenna



- 1 FM indoor antenna



- 1 Video cable



- 1 Sheet of speaker cable stickers

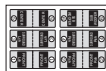

- HT545** 1 AC mains lead



- HT545W** 2 AC mains leads



TABLE OF CONTENTS

Getting Started



Accessories 2

Simple Setup

STEP 1 Positioning the speakers 4

Speaker installation options 5

STEP 2 Speaker connections 6

HT545W Connecting the surround speaker cables to the wireless system 6

STEP 3 Radio and digital transceiver connections 7

HT545W Connecting the digital transceiver .. 7

STEP 4 Audio and video connections. 8

Basic audio connection 8

Basic video connection 8

STEP 5 AC mains lead connections 9

STEP 6 Preparing the remote control ... 10

STEP 7 Performing QUICK SETUP 10

Control reference guide 11

Discs that can be played. 12

Disc caution 12

Maintenance..... 12

Glossary 13



Playing Discs



Basic play 14

Using the main unit 14

Using the remote control 15

Convenient functions 16

Displaying current playback condition..... 16

All group, Program and Random play..... 16

Playing data discs using navigation menus ... 17

Playing data discs..... 17

Selecting a track using CD text..... 18

Playing HighMAT™ discs 18

Playing RAM and DVD-R/-RW (DVD-VR) discs 18

Using on-screen menus 20

Main menu 20

Other Settings 21

Changing the player settings 23

Changing the delay time of the speakers..... 25



Other Operations



Using the radio 26

Presetting stations automatically 26

Selecting the preset channels 26

Manual tuning 26

RDS broadcasting 27

Using an outdoor antenna (optional) 27

Using sound effects 28

Changing the sound quality: Sound Field Control ... 28

Enhancing the sound from the center speaker:

Center Focus 28

Enhancing the stereo sound: Dolby Pro Logic II ... 28

Adjusting the amount of bass: Subwoofer level 28

HT545 Enhancing the bass sound: H.BASS 29

Adjusting the volume of each speaker:

Speaker level adjustments..... 29

Using other useful functions 30

Setting the sleep timer 30

Muting the sound 30

Using headphones 30

Using the Music Port 30

Operating other equipment 31

Operating the television 31



Reference



Safety precautions 32

About DivX VOD content 32

Troubleshooting guide 33

Specifications 36



STEP 1 Positioning the speakers

How you set up your speakers can affect the bass and the sound field. Note the following points:

- Place speakers on flat secure bases.
- Placing speakers too close to floors, walls, and corners can result in excessive bass. Cover walls and windows with thick curtains.
- Left and right speakers are interchangeable, but front and surround speakers are not.
- Place the front, center, and surround speakers at approximately the same distance from the seating position.

The angles in the diagram are approximate.

HT545

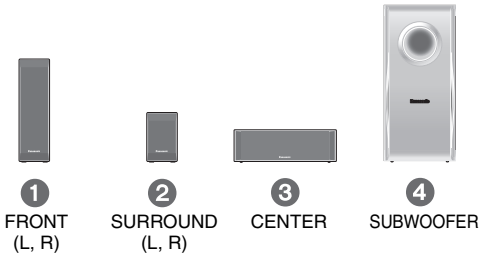

HT545W

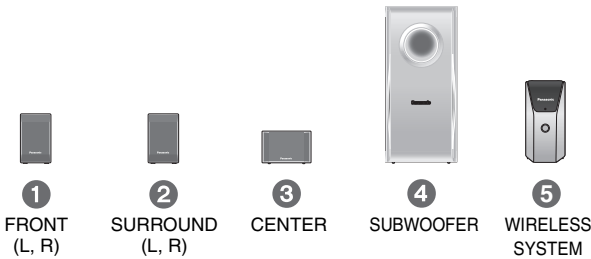

Setup example

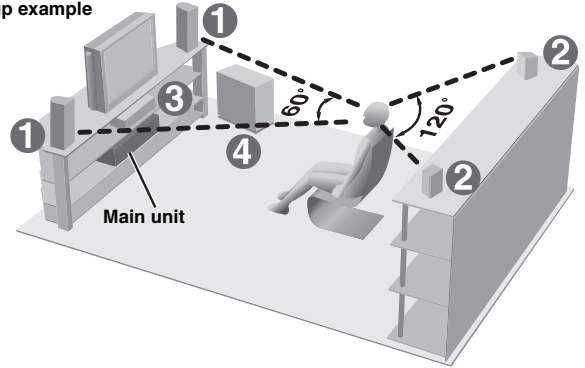

Setup example

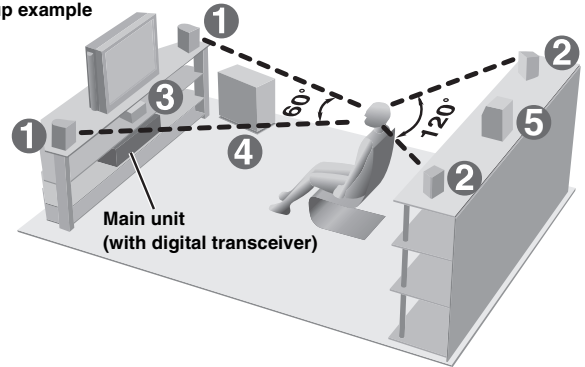

• Use only supplied speakers

- Using other speakers can damage the unit, and sound quality will be negatively affected.
- Set the speakers up on an even surface to prevent them from falling. Take proper precautions to prevent the speakers from falling if you cannot set them up on an even surface.

Main unit

Note

- Keep your speakers at least 10 mm away from the system for proper ventilation.
- To allow for proper ventilation and to maintain good airflow around the main unit, position it with at least 5 cm of space on all sides.
- Do not block the ventilation holes of the main unit.

Center speaker

- Vibration caused by the center speaker can disrupt the picture if it is placed directly on the television. Put the center speaker on a rack or shelf.
- To prevent the speakers from falling, do not place directly on top of the television.

HT545W Wireless system

- Place the wireless system within approximately 10 m from the main unit.
- Do not use the wireless system or the digital transceiver in a metal cabinet or bookshelf.

Subwoofer

Place to the right or left of the television, on the floor or a sturdy shelf so that it will not cause vibration. Leave about 30 cm from the television.

Caution

Do not touch the netted area of the speakers.

e.g. Surround speaker



Notes on speaker use

- You can damage your speakers and shorten their useful life if you play sound at high levels over extended periods.
- Reduce the volume in the following cases to avoid damage:
 - When playing distorted sound.
 - When the speakers are reverberating due to a record player, noise from FM broadcasts, or continuous signals from an oscillator, test disc, or electronic instrument.
 - When adjusting the sound quality.
 - When turning the unit on or off.

If irregular coloring occurs on your television

The front and center speakers are designed to be used close to a television, but the picture may be affected with some televisions and setup combinations.

If this occurs, turn the television off for about 30 minutes.

The demagnetizing function of the television should correct the problem. If it persists, move the speakers further away from the television.

Caution

- The main unit and supplied speakers are to be used only as indicated in this setup. Failure to do so may lead to damage to the amplifier and/or the speakers, and may result in the risk of fire. Consult a qualified service person if damage has occurred or if you experience a sudden change in performance.
- Do not attempt to attach these speakers to walls using methods other than those described in this manual.

HT545W Avoiding interference

To avoid possible interference, do not place the wireless system near any of the following devices.

The wireless system uses the same radio frequencies as other devices that may be present in your home.

e.g.

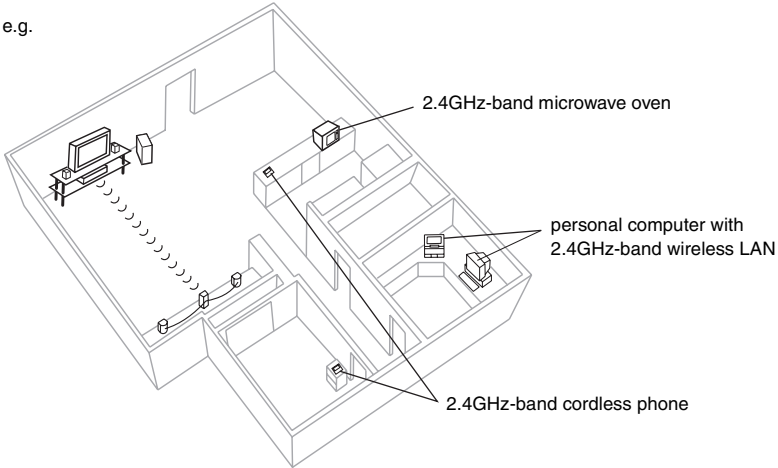

The wireless system will automatically seek a clear channel if any of these other devices interfere with its communication. When this happens, the wireless link indicator (“W”) flashes on the main unit, and there is a brief interruption in audio coming from the surround speakers.

This is the normal operation of the product working to assure the best possible performance of your Home Theater System.

If the interference persists, try moving the other devices to another location outside the range of the wireless system.

Speaker installation options

Attaching to a wall

You can attach all of the speakers (except subwoofer) to a wall.

- The wall or pillar on which the speakers are to be attached should be capable of supporting over 10 kg per screw. Consult a qualified building contractor when attaching the speakers to a wall. Improper attachment may result in damage to the wall and speakers.

1 Drive a screw (not included) into the wall.

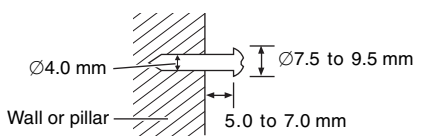

2 Fit the speaker securely onto the screw(s) with the hole(s).

HT545 Front speaker

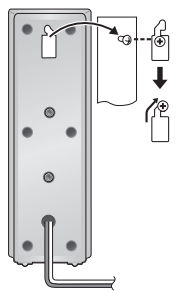

HT545 Center speaker

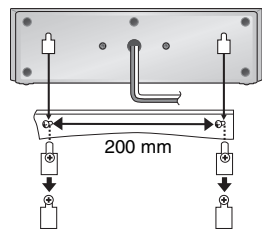

HT545 Surround speaker

HT545W Front and surround speakers

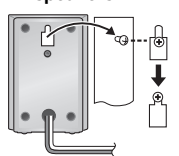

HT545W Center speaker

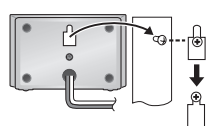

Fitting speaker stands (not included)

Ensure the stands meet these conditions before purchasing them. Note the diameter and length of the screws and the distance between screws as shown in the diagram.

- The stands must be able to support over 10 kg.
- The stands must be stable even if the speakers are in a high position.

e.g. HT545 Center speaker

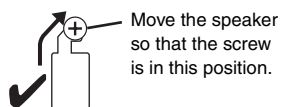
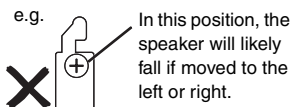
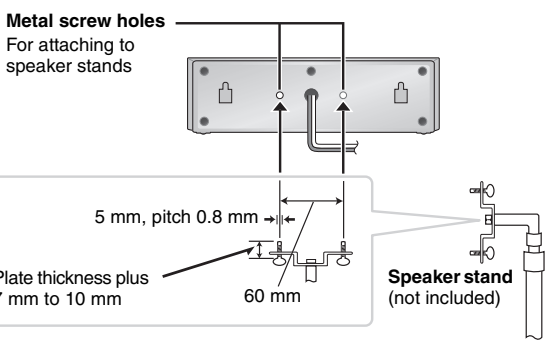

STEP 2 Speaker connections

1 sheet of speaker cable stickers

- Attach the speaker-cable stickers to make connection easier.



The illustration shows SC-HT545.



Be careful not to cross (short-circuit) or reverse the polarity of the speaker wires as doing so may damage the speakers.

⑥ SUBWOOFER

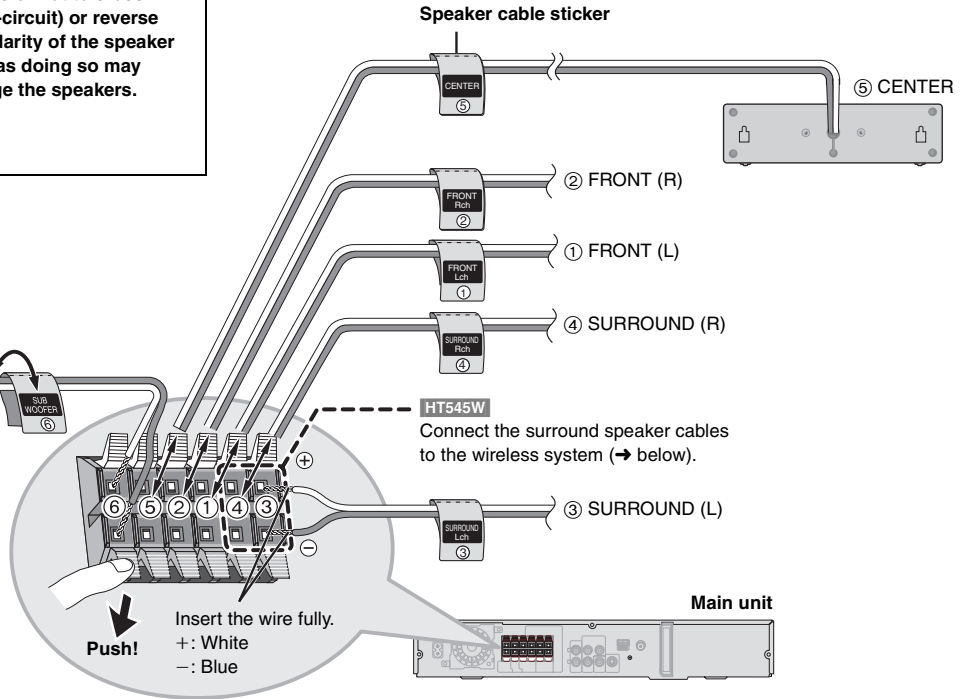
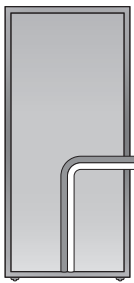

HT545W Connecting the surround speaker cables to the wireless system

Wireless system

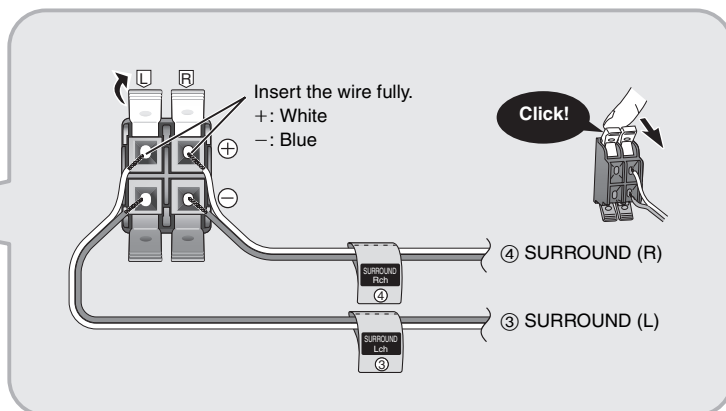

STEP 3

Radio and digital transceiver connections

[For SC-HT545, an optional wireless accessory is required to make the digital transceiver connection (→ below).]

AM loop antenna



FM indoor antenna



HT545W

Digital transceiver



- Using an outdoor antenna (optional) (→ page 27).

The illustration shows SC-HT545.

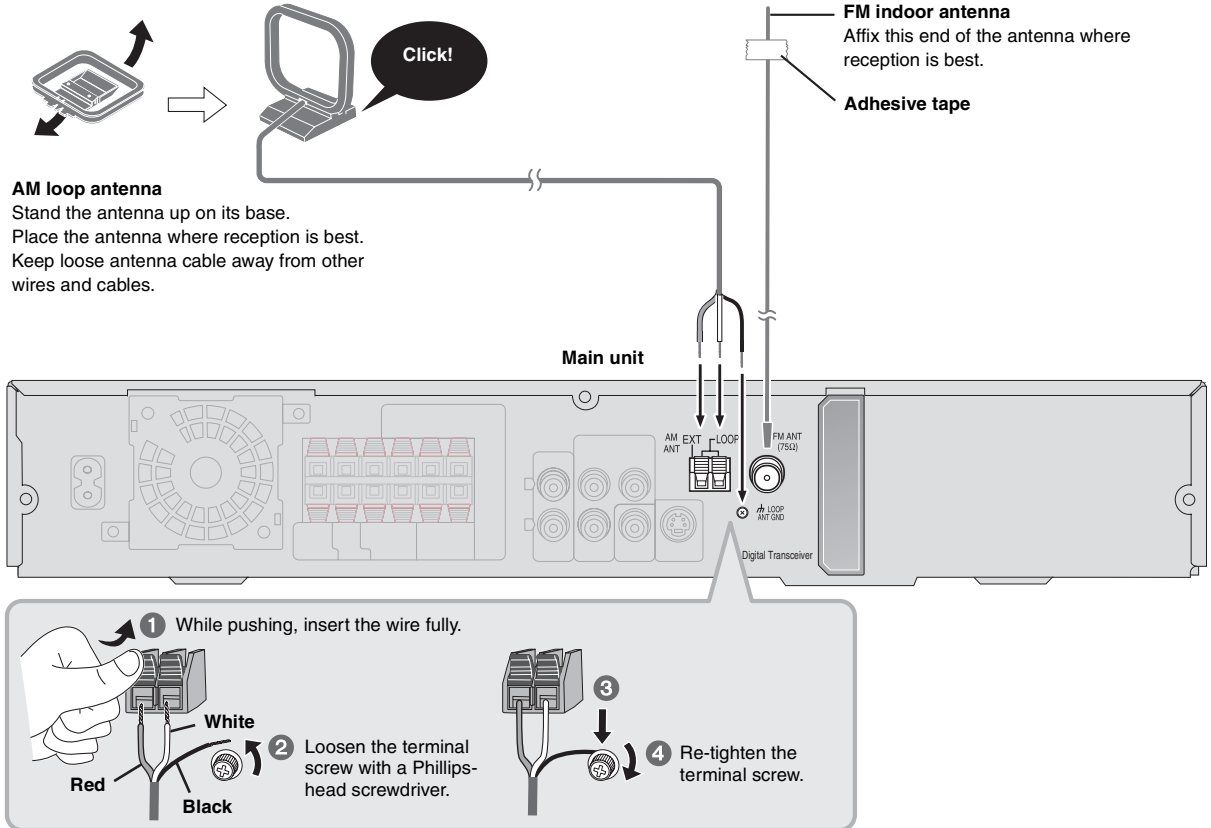

HT545



Set your surround sound free!

Optional Panasonic wireless accessory (e.g. SH-FX60)

You can enjoy surround speaker sound wirelessly when you use the optional Panasonic wireless accessory (e.g. SH-FX60). For details, please refer to the operating instructions for the optional Panasonic wireless accessory.

HT545W Connecting the digital transceiver

The illustration shows SC-HT545W.

Main unit

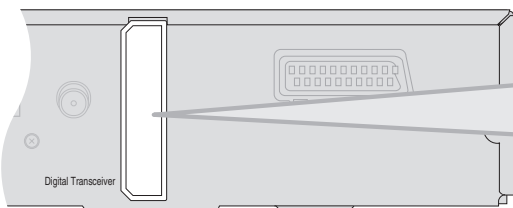

Insert the digital transceiver into the slot.

Do not insert or remove while the main unit is on.

Digital transceiver
Insert fully until you hear a click.



STEP 4 Audio and video connections

- Do not connect through the video cassette recorder. Due to copy guard protection, the picture may not be displayed properly.
- Turn the television off before connecting, and refer to the television's operating instructions.

Video cable



Basic audio connection

Television (not included)

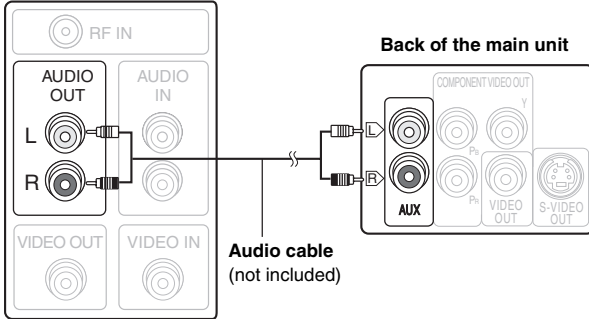

Audio cable
(not included)

- This audio connection will enable you to play audio from your television through your home theater system. Refer to "Operating other equipment" (→ page 31).

Basic video connection

Television (not included)

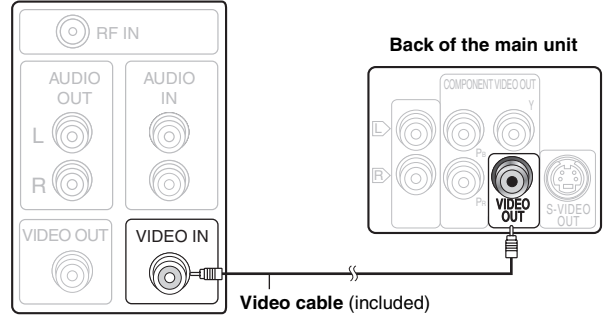

Video cable (included)

- Refer also to "Other video connections for improved picture quality" (→ below).

Other video connections for improved picture quality

COMPONENT VIDEO OUT

Television
(not included)

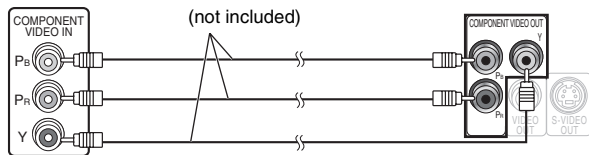

Video cables
(not included)

• Using the COMPONENT VIDEO OUT terminals

The COMPONENT VIDEO OUT terminals provides a purer picture than the S-VIDEO OUT terminal. These terminals can be used for either interlaced or progressive output. Connection using these terminals outputs the color difference signals (P_B/P_R) and luminance signal (Y) separately in order to achieve high fidelity in reproducing colors.

- The description of the component video input terminals depends on the television or monitor (e.g. Y/P_B/P_R, Y/B-Y/R-Y, Y/C_B/C_R). Connect to terminals of the same color.

Continental Europe

- When making this connection, select "Video/YPbPr" or "S-Video/YPbPr" from QUICK SETUP (→ page 10). If "RGB/No Output" is selected, the RGB signal is output from the SCART (AV) terminal, but no signal is output from the component video output terminals.

To enjoy progressive video

- Connect to a progressive output compatible television.
- Set "Video Output Mode" to "480p" or "576p", and then follow the instructions on the menu screen (→ page 21, Picture Menu).

Continental Europe

- Panasonic televisions with 625 (576)/50i-50p, 525 (480)/60i-60p input terminals are progressive compatible. Consult the manufacturer if you have another brand of television.

Other video connections for improved picture quality

S-VIDEO OUT

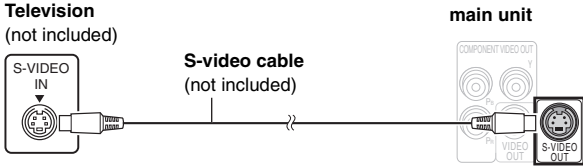

• Using the S-VIDEO OUT terminal

The S-VIDEO OUT terminal achieves a more vivid picture than the VIDEO OUT terminal by separating the chrominance (C) and luminance (Y) signals. (Actual results depend on the television.)

Continental Europe

SCART

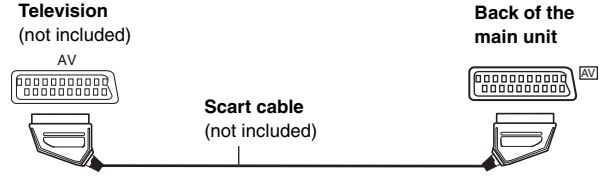

• Using the SCART (AV) terminal

To improve picture quality, you can change the video signal output from the SCART (AV) terminal from "Video" to either "S-Video" or "RGB" to suit the type of television you are using. Select "S-Video/YPbPr" or "RGB/No Output" from QUICK SETUP (→ page 10).

This connection will also enable you to play audio from your television through your home theater system. Refer to "Operating other equipment" (→ page 31).

■ Cable TV box or video cassette recorder connection

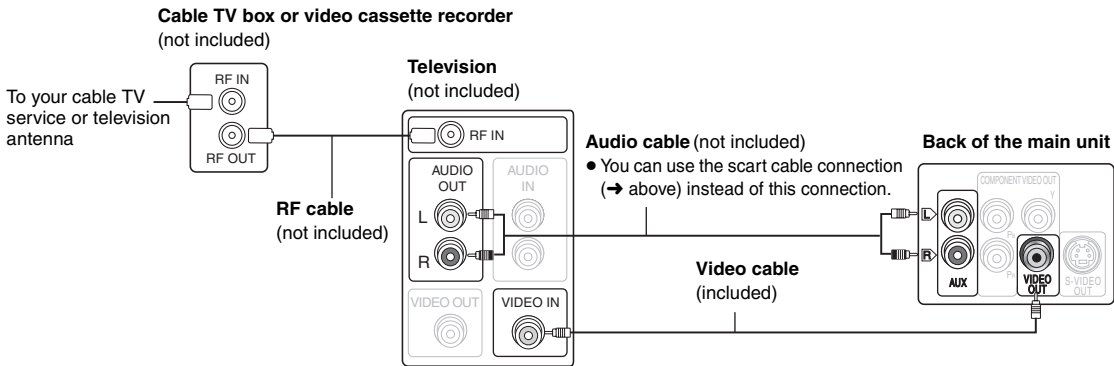

• You can use the scart cable connection (→ above) instead of this connection.

STEP 5 AC mains lead connections

HT545

1 AC mains lead



Main unit

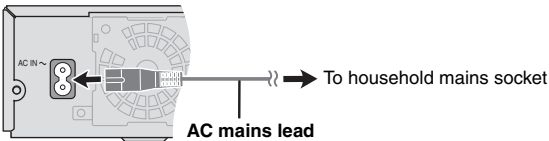

HT545W

2 AC mains leads



HT545W

Wireless system

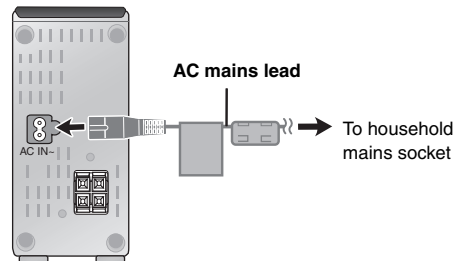

Conserving power

The main unit and the wireless system consume a small amount of power when they are in standby mode (main unit: approx. 0.5 W, wireless system: approx. 1.2 W). To save power when they are not to be used for a long time, unplug them from the household mains socket. You will need to reset some memory items after plugging in the main unit.

Note

The included AC mains leads are for use with the main unit and wireless system only. Do not use them with other equipment. Also, do not use cords for other equipment with the main unit or wireless system.

STEP 6 Preparing the remote control

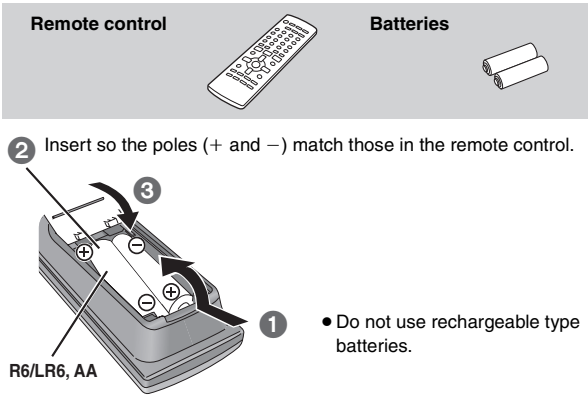

Do not:

- mix old and new batteries.
- use different types at the same time.
- heat or expose to flame.
- take apart or short circuit.
- attempt to recharge alkaline or manganese batteries.
- use batteries if the covering has been peeled off.

Mishandling of batteries can cause electrolyte leakage which can severely damage the remote control.

Remove the batteries if the remote control is not going to be used for a long period of time. Store in a cool, dark place.

Use

Aim at the remote control signal sensor (→ page 11), avoiding obstacles, at a maximum range of 7 m directly in front of the unit.

STEP 7 Performing QUICK SETUP

The QUICK SETUP screen assists you to make necessary settings.

To display the picture from the main unit, turn on your television and change its video input mode (e.g. VIDEO 1, AV 1, etc.).

- To change your television's video input mode, refer to its operating instructions.
- This remote control can perform some basic television operations (→ page 31).

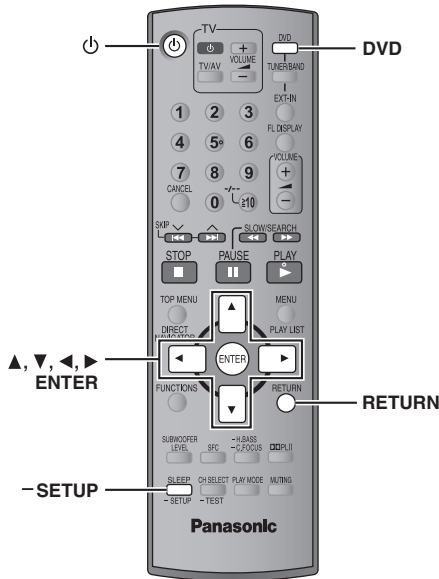

1		Turn on the unit.
2		Select "DVD/CD".
3		Press and hold to show the QUICK SETUP screen.
4		Follow the messages and make the settings.
5		Press to finish QUICK SETUP.
6		Press repeatedly to exit.

To change these settings later

Select "QUICK SETUP" in the "Others" tab (→ page 24).

See page references in parentheses.

The illustration shows SC-HT545.

Television operations (31)

Turn the unit on/off (10)

Change the television's video input mode (31)

Select disc's title numbers etc./Enter numbers (15)

Cancel (15)

Select preset radio stations (26)

Show a disc top menu (17) or program list (18)

Frame-by-frame/Select or register menu items on the television screen (15)

Show on-screen menu (20) or display RDS text data (Continental Europe only) (27)

Adjust the television volume (31)

Select the source
DVD: DVD/CD (10)
TUNER/BAND: FM/AM (26)
EXT-IN: MUSIC P. (30), TV* (31), AUX (31)

Change the unit's display (15)

Adjust the volume of the main unit (15)

Basic operations for play (14, 15)

Show a disc menu (17) or play list (18)

Return to previous screen (15)

HT545W			
SUBWOOFER LEVEL (28)	SFC (28)	-H.BASS -C.FOCUS (29, 28)	DOLBII (28)
SLEEP -SETUP (30, 23)	CH SELECT -TEST (29)	PLAY MODE (16)	MUTING (30)

To use functions labeled with "—":
 Press and hold the button for at least 2 seconds.

Standby/on switch [⏻/⏻]

Press to switch the unit from on to standby mode or vice versa. In standby mode, the unit is still consuming a small amount of power. (14)

MUSIC PORT

Connect an external device (30)



Remote control signal sensor

AC supply indicator [AC IN]

This indicator lights when the unit is connected to the AC mains supply.

■ / -TUNE MODE / —FM MODE

Stop playing (14)/Select the tuning mode (26)
 Adjust the FM reception condition (26)

▶ / MEMORY

Play discs (14)/Memorize the receiving radio stations (26)

▲ OPEN/CLOSE

Open/Close the disc tray (14)

⏮/⏪, ⏩/⏭ / √ TUNING ^

Skip or slow-search play (14)/
 Select the radio stations (26)

Phones

Connect headphones (30)

VOLUME

Turn up/down the volume (14)

SELECTOR (26)

DVD/CD → FM → AM → TV* → AUX → MUSIC P. →
 Return to DVD/CD

* **Continental Europe** "TV" works only when the scart cable is connected (→ page 9).

HT545W

The illustration shows the wireless system for SC-HT545W.

AC supply indicator [AC IN]

This indicator lights when the unit is connected to the AC mains supply.

The unit is in the standby condition when the AC power supply cord is connected. The primary circuit is always "live" as long as the power cord is connected to an electrical outlet.









Lighting Ring

Lights when the wireless link is active.

Discs that can be played

Operations in these instructions are described mainly with formats. Icons such as **DVD-V** show the formats.

	DVD-Video DVD-V —
	DVD-Audio DVD-A DVD-V • DVD-V Some DVD-Audio discs contain DVD-Video content. To play DVD-Video content, select "Play as DVD-Video" in Other Menu (→ page 22).
	Video CD VCD • Including SVCD (Conforming to IEC62107)
	DVD-RAM DVD-VR MP3 JPEG MPEG4 DivX *1 • DVD-VR Recorded with devices using Version 1.1 of the Video Recording Format (a unified video recording standard), such as DVD video recorders, DVD video cameras, personal computers, etc. • JPEG Recorded with Panasonic SD multi cameras or DVD video recorders using the DCF (Design rule for Camera File system) Standard Version 1.0. • MPEG4 Recorded with Panasonic SD multi cameras or DVD video recorders [conforming to SD VIDEO specifications (ASF standard)/MPEG4 (Simple Profile) video system/G.726 audio system].
	DVD-R (DVD-Video)*2/DVD-RW (DVD-Video) DVD-V • Discs recorded and finalized*3 on DVD video recorders or DVD video cameras. DVD-R (VR)*2/DVD-RW (VR) DVD-VR • Discs recorded and finalized*3 on DVD video recorders or DVD video cameras using Version 1.1 (or 1.2 DVD-R DL only) of the Video Recording Format (a unified video recording standard). DVD-R/DVD-RW MP3 JPEG MPEG4 DivX *1 • Finalize*3 the disc after recording.
—	+R (Video)*2/+RW (Video) DVD-V • Discs recorded and finalized*3 on DVD video recorders or DVD video cameras.
	CD CD WMA MP3 JPEG VCD MPEG4 DivX *1 • This unit can play CD-R/RW recorded with the above formats. Close the sessions or finalize*3 the disc after recording. • CD This unit is compatible with HDCD, but does not support the Peak Extend function (a function which expands the dynamic range of high-level signals). HDCD-encoded CDs sound better because they are encoded with 20 bits, as compared with 16 bits for all other CDs. • WMA MP3 JPEG This unit also plays HighMAT discs. • WMA This unit does not support Multiple Bit Rate (MBR: a file that contains the same content encoded at several different bit rates).

*1 Functions added with DivX Ultra are not supported.

*2 Includes single-sided, dual-layer discs.

*3 A process that allows play on compatible equipment.

• It may not be possible to play all the above-mentioned discs in some cases due to the type of disc or condition of the recording.

Discs that cannot be played

DVD-RW version 1.0, DVD-ROM, CD-ROM, CDV, CD-G, SACD and Photo CD, DVD-RAM that cannot be removed from their cartridge, 2.6-GB and 5.2-GB DVD-RAM, and "Chaoji VCD" available on the market including CVD, DVCD and SVCD that do not conform to IEC62107.

Video systems

- This unit can play PAL and NTSC, but your television must match the system used on the disc.
- PAL discs cannot be correctly viewed on an NTSC television.
- This unit can convert NTSC signals to PAL 60 for viewing on a PAL television (→ page 24, "NTSC Disc Output" in "Video" tab).

Disc caution

To clean discs

Wipe with a damp cloth and then wipe dry.

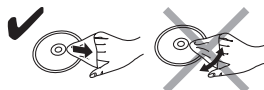

Disc handling precautions

- Do not attach labels or stickers to discs. This may cause disc warping, rendering it unusable.
- Do not write on the label side with a ball-point pen or other writing instrument.
- Do not use record cleaning sprays, benzene, thinner, liquids which prevent static electricity, or any other solvent.
- Do not use scratch-proof protectors or covers.
- Do not use the following discs:
 - Discs with exposed adhesive from removed stickers or labels (rented discs, etc).
 - Discs that are badly warped or cracked.
 - Irregularly shaped discs, such as heart shapes.

Maintenance

Clean this unit with a soft, dry cloth.

- Never use alcohol, paint thinner or benzene to clean this unit.
- Before using chemically treated cloth, carefully read the instructions that came with the cloth.

Do not use commercially available lens cleaners as they may cause malfunction. Cleaning of the lens is generally not necessary although this depends on the operating environment.

Before moving the unit, ensure the disc tray is empty. Failure to do so will risk severely damaging the disc and the unit.



Decoder

A decoder restores the coded audio signals on DVDs to normal. This is called decoding.

DivX

DivX is a popular media technology created by DivX, Inc. DivX media files contain highly compressed video with high visual quality that maintains a relatively small file size.

Dolby Digital

This is a method of coding digital signals developed by Dolby Laboratories. Apart from stereo (2-channel) audio, these signals can also be multi-channel audio. A large amount of audio information can be recorded on one disc using this method.

DTS (Digital Theater Systems)

This surround system is used in many movie theaters around the world. There is good separation between the channels, so realistic sound effects are possible.

Dynamic range

Dynamic range is the difference between the lowest level of sound that can be heard above the noise of the equipment and the highest level of sound before distortion occurs.

Film and video

DVD-Videos are recorded using either film or video. This unit can determine which type has been used, then uses the most suitable method of progressive output.

Film: Recorded at 25 frames per second (PAL discs) or 24 frames per second (NTSC discs). (NTSC discs recorded at 30 frames per second as well). Generally appropriate for motion picture films.

Video: Recorded at 25 frames/50 fields per second (PAL discs) or 30 frames/60 fields per second (NTSC discs). Generally appropriate for TV drama programs or animation.

Frame still and field still

Frames are the still pictures that go together to make a moving picture. There are about 30 frames shown each second.

One frame is made up of two fields. A regular television shows these fields one after the other to create frames.

A still is shown when you pause a moving picture. A frame still is made up of two alternating fields, so the picture may appear blurred, but overall quality is high.

A field still is not blurred, but it has only half the information of a frame still so picture quality is lower.

I/P/B

MPEG 2, the video compression standard adopted for use with DVD-Video, codes frames using these 3 picture types.

I: Intra coded picture

This picture has the best quality and is the best to use when adjusting the picture.

P: Predictive coded picture

This picture is calculated based on past I- or P-pictures.

B: Bidirectionally-predictive coded picture

This picture is calculated by comparing past and future I- and P-pictures so it has the lowest volume of information.

JPEG (Joint Photographic Experts Group)

This is a system used for compressing/decoding color still pictures. If you select JPEG as the storage system on digital cameras, etc., the data will be compressed to 1/10–1/100 of its original size. The benefit of JPEG is less deterioration in picture quality considering the degree of compression.

Linear PCM (pulse code modulation)

These are uncompressed digital signals, similar to those found on CDs.

MP3 (MPEG Audio Layer 3)

An audio compression method that compresses audio to approximately one tenth of its size without any considerable loss of audio quality.

MPEG4

A compression system for use on mobile devices or a network, that allows highly efficient recording at a low bit rate.

Playback control (PBC)

If a Video CD has playback control, you can select scenes and information with menus.

Progressive/Interlaced

The PAL video signal standard has 576 interlaced (i) scan lines, whereas progressive scanning, called 576p, uses twice the number of scan lines. For the NTSC standard, these are called 480i and 480p respectively.

Using progressive output, you can enjoy the high-resolution video recorded on media such as DVD-Video.

Your television must be compatible to enjoy progressive video.

Sampling frequency

Sampling is the process of converting the heights of sound wave (analog signal) samples taken at set periods into digits (digital encoding).

Sampling frequency is the number of samples taken per second, so larger numbers mean more faithful reproduction of the original sound.

WMA (Windows Media™ Audio)

WMA is a compression format developed by Microsoft Corporation. It achieves the same sound quality as MP3 with a file size that is smaller than that of MP3.

Basic play

To display the picture from the main unit, turn on your television and change its video input mode (e.g. VIDEO 1, AV 1, etc.).

- To change your television's video input mode, refer to its operating instructions.

Using the main unit

1 Turn the unit on.



2 Select "DVD/CD".

SELECTOR



- Select "AUX" (HT545W "AUX" or "TV") to enjoy video cassette recorder, television or cable TV programs. (Refer to page 9 for the necessary connections.)

3 Open the disc tray.

OPEN/CLOSE



4 Load the disc.

- Load double-sided discs so the label for the side you want to play is facing up.
- For DVD-RAM, remove the disc from its cartridge before use.

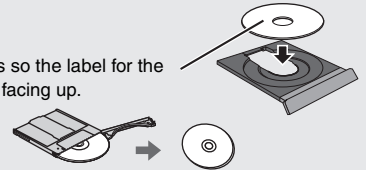

5 Start play.



The tray is automatically closed.

To change the sound quality → page 28

6 Adjust the volume.



Press to skip.
Press and hold to

- search during play
- start slow-motion play during pause (Motion picture part)
- Press [▶] (Play) to start normal play.



Note

- Discs continue to rotate while menus are displayed. To preserve the unit's motor and your television screen, press [■] (Stop) when you are finished with the menus.
- Total title number may not be displayed properly on +R/+RW.



Using the remote control

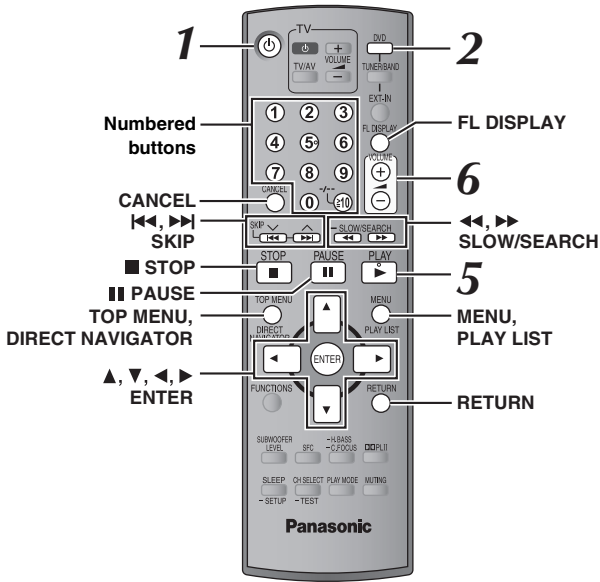

On-screen item select

Select

Register

Enter number

1 2 3
4 5 6
7 8 9
0 (≠10)

DVD-VR DVD-A DVD-V VCD CD
e.g. To select 12:
[≧10] → [1] → [2]

VCD with playback control
Press [STOP] to cancel the PBC function, and then press the numbered buttons.

WMA MP3 JPEG MPEG4 DivX
e.g. To select 123:
[1] → [2] → [3] → [ENTER]

ENTER
CANCEL

• Press [CANCEL] to cancel the number(s).

Stop

STOP

The position is memorized while "RESUME" is on the display.

- Press [PLAY] to resume.
- Press [STOP] again to clear the position.

Pause

PAUSE

- Press [PLAY] to restart play.

Skip

SKIP

- WMA MP3 JPEG MPEG4 DivX
[This feature does not work during program and random play (→ page 16).]
- [▲, ▼]: Group skip
- [◀, ▶]: Content skip

Search (during play)

SLOW/SEARCH

- Up to 5 steps.
- Press [PLAY] to start normal play.
- VCD Slow-motion: forward direction only.
- MPEG4 DivX Slow-motion: Does not work.

Frame-by-frame (during pause)

DVD-A (Motion picture part)
DVD-VR DVD-V VCD

- VCD Forward direction only.

Disc menu

TOP MENU
DIRECT NAVIGATOR

DVD-A DVD-V
Shows a disc top menu.

DVD-VR
Press the button to show the programs (→ page 18).

Disc menu

MENU
PLAY LIST

DVD-V
Shows a disc menu.

DVD-VR
Press the button to show a playlist (→ page 18).

RETURN
VCD with playback control
Shows a disc menu.

Return to previous screen

RETURN

Main unit display

FL DISPLAY

DVD-VR DVD-A DVD-V WMA
MP3 MPEG4 DivX
Time display
↔ Information display (e.g. DVD-VR Program number)

JPEG
When Slideshow (→ page 20) is on:
SLIDE ↔ Contents number
When Slideshow is off:
PLAY ↔ Contents number



Basic play

Convenient functions

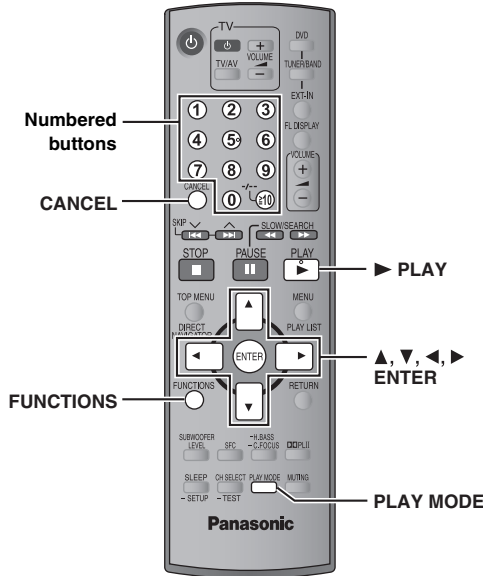

Displaying current playback condition

FUNCTIONS

Press [FUNCTIONS].

Each time you press the button:

Main menu (→ page 20) → Basics → Details
 ↑ off (No on-screen display) ↓

Basics

e.g. DVD-V

Current playback number Elapsed play time

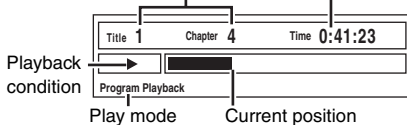

Details

e.g. DVD-V

Details-DVD-Video	
Audio information	Audio 1 ---DTS 3/2.1ch
Subtitle information	Subtitle ---
Angle information	Angle 1/1
Aspect of current title	Source Aspect 4:3
Total play time of current title	Title Total Time 0:54:28

- [MPEG4] [DivX] Video and audio information is not displayed during search.

All group, Program and Random play

PLAY MODE

- Selecting "Play as Data Disc" in Other Menu (→ page 22) will be effective if the following functions are not available to play WMA, MP3, JPEG, MPEG4 or DivX video contents.
- [DVD-V] Some items cannot be played even if you have programmed them.
- [DVD-A] Some discs contain bonus groups. If a password screen appears after selecting a group, enter the password with the numbered buttons to play the bonus group. Refer also to the disc's jacket.

Press [PLAY MODE] while stopped.

All group, program and random playback screens appear sequentially.

All group ([DVD-A]) → Program → Random
 ↑ off (Normal play) ↓

To exit the all group, program and random mode
 Press [PLAY MODE] several times while stopped.

All group play

[DVD-A]

Press [▶] [PLAY].

All Group Playback

Press PLAY to start

Program play (up to 32 items)

1 Press the numbered buttons to select the item.

([WMA] [MP3] [JPEG] [MPEG4] [DivX]) Press [ENTER] to register the selection.)

e.g. [DVD-V]

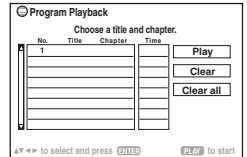

- Repeat this step to program other items.

- To select a 2-digit number

e.g. To select 12: [≥10] → [1] → [2]

[WMA] [MP3] [JPEG] [MPEG4] [DivX] [1] → [2] → [ENTER]

2 Press [▶] [PLAY].

To select an item using the cursor buttons

Press [ENTER] and [▲, ▼] to select an item, and then press [ENTER] again to register.

To select all the items

While the "Chapter", "Track" or "Content" field is highlighted, press [▲, ▼] to select "ALL". Then press [ENTER] again to register.

e.g. [DVD-V]

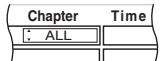

To change the selected program

1 Press [▲, ▼] to select the program number.

2 Press the numbered buttons to change each item.

([WMA] [MP3] [JPEG] [MPEG4] [DivX]) Press [ENTER] to register the selection.)

To clear the selected program

1 Press [▲, ▼] to select the program number.

2 Press [CANCEL] (or press [▲, ▼, ◀, ▶] to select "Clear" and press [ENTER]).

To clear the whole program

Select "Clear all" with [▲, ▼, ◀, ▶] and press [ENTER].

The whole program is also cleared when the disc tray is opened, the unit is turned off or another source is selected.

Random play

1 [DVD-A] [DVD-V] [WMA] [MP3] [JPEG] [MPEG4] [DivX]

Press the numbered buttons to select a group or title.

([WMA] [MP3] [JPEG] [MPEG4] [DivX]) Press [ENTER] to register the selection.)

e.g. [DVD-V]

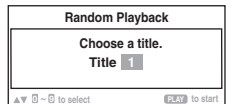

[DVD-A]

- To enter all groups, press [◀, ▶] to select "All" and press [ENTER].

- To deselect a group, press numbered buttons corresponding to the group you want to clear.

2 Press [▶] [PLAY].

Playing data discs using navigation menus

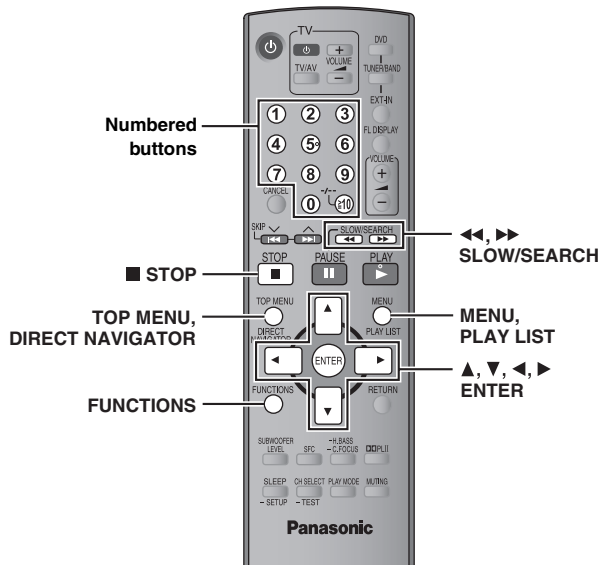

Playing data discs

WMA MP3 JPEG MPEG4 DivX



Selecting "Play as Data Disc" in Other Menu (→ page 22) will be effective if the following functions are not available to play WMA, MP3, JPEG, MPEG4 or DivX video contents.

- Playing HighMAT™ discs (→ page 18)

Playing items in order (Playback Menu)

1 Press [TOP MENU].

- To exit the screen, press [TOP MENU].

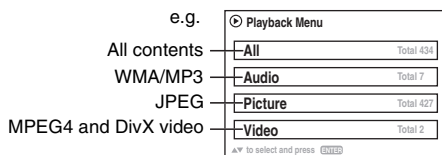

2 Press [▲, ▼] to select "All", "Audio", "Picture" or "Video" and press [ENTER].

Playing from the selected item (Navigation Menu)

1 Press [MENU].

- To exit the screen, press [MENU].

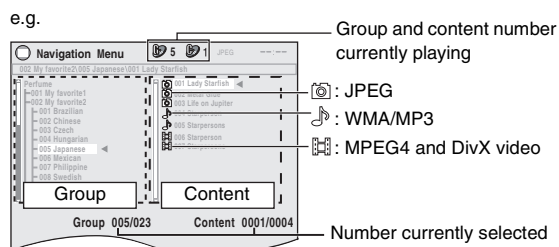

2 Press [◀] followed by [▲, ▼] to select the group and press [ENTER].

3 To play content in the group in order

Press [ENTER].

To start play from the selected content

Press [▲, ▼] to select and [ENTER].

To enjoy listening to WMA/MP3 contents while showing a JPEG image on the screen, select a JPEG file first and then select audio contents. (The opposite order is not effective.)

■ Using the submenu

① While Navigation Menu is displayed

Press [FUNCTIONS].

② Press [▲, ▼] to select an item and press [ENTER].

Items shown differ depending on the type of disc.

Multi	Groups and contents are displayed.
List	Contents only
Tree	Groups only
Thumbnail	Thumbnail images [JPEG]
Next group	To go to next group
Previous group	To go to previous group
All	WMA/MP3, JPEG, MPEG4 and DivX video
Audio	WMA/MP3 only
Picture	JPEG only
Video	MPEG4 and DivX video only
Help display	To switch between guide messages and the elapsed play time indicator
Find	To search by content or group title (→ below)

■ Searching by a content or group title

Highlight a group title to search the group, or a content title to search its content.

① While the submenu is displayed (→ above)

Press [▲, ▼] to select "Find" and press [ENTER].

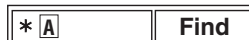

② Press [▲, ▼] to select a character and press [ENTER].

- Repeat to enter another character.
- Lower case characters are also searched.
- Press [◀, ▶] SLOW/SEARCH] to skip between A, E, I, O and U.
- Press [◀] to erase a character.
- Leave the asterisk (*) when you search for the titles including the character you enter.
- Erase the asterisk (*) to search for the titles starting with the character you enter. To add the asterisk (*) again, display the submenu again and select "Find".

③ Press [▶] to select "Find" and press [ENTER].

The search result screen appears.

④ Press [▲, ▼] to select the content or group and press [ENTER].

(Continued on next page)

Selecting a track using CD text

CD

TOP MENU / MENU



Titles appear with CD Text disc playback.

1 Press [TOP MENU] or [MENU].

- To exit the screen, press [TOP MENU] or [MENU].

e.g. CD text

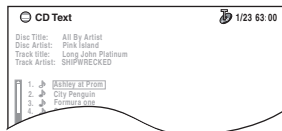

2 Press [▲, ▼] to select the track and press [ENTER].

- Press [FUNCTIONS] to show the playback condition and current position.

Playing HighMAT™ discs

WMA MP3 JPEG

TOP MENU / MENU



1 Press [TOP MENU].

- To exit the screen, press [■ STOP].
- To change the menu background to the one recorded on the disc, press [FUNCTIONS].

2 Press [▲, ▼, ◀, ▶] to select the item, and then press [ENTER].

- Repeat this step if necessary.

e.g.

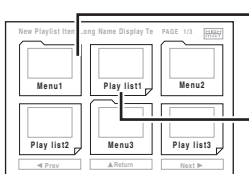

Menu: Takes you to the next menu which shows playlists or another menu

Playlist: play starts

Selecting from the list

1 During play

Press [MENU].

- To exit the screen, press [MENU].

e.g.

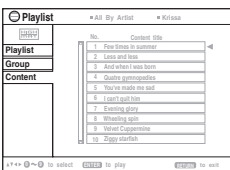

2 Press [◀] followed by [▲, ▼] to switch among "Playlist", "Group" and "Content" lists.

3 Press [▶] followed by [▲, ▼] to select an item and press [ENTER].

Playing RAM and DVD-R/-RW (DVD-VR) discs

DVD-VR

DIRECT NAVIGATOR / PLAY LIST

- Titles appear only if the titles are recorded on the disc.
- You cannot edit programs, playlists and disc titles.

Playing the programs

1 Press [DIRECT NAVIGATOR].

- To exit the screen, press [DIRECT NAVIGATOR].

e.g.

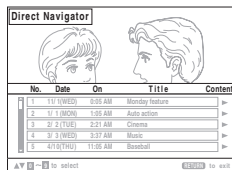

2 Press [▲, ▼] or the numbered buttons to select the program.

- To select a 2-digit number
e.g. 12: [≧10] → [1] → [2]
- Press [▶] to show the contents of the program and the disc.

3 Press [ENTER].

Playing a playlist

This works only when the disc contains a playlist.

1 Press [PLAY LIST].

- To exit the screen, press [PLAY LIST].

e.g.



2 Press [▲, ▼] or the numbered buttons to select the playlist.

- To select a 2-digit number
e.g. 12: [≧10] → [1] → [2]

3 Press [ENTER].

■ Playing scenes one by one

- While the playlist menu is displayed
Press [▶].
- Press [▲, ▼] to select "Scene List" and press [ENTER].
• "Contents" shows playlist information.
- Press [▲, ▼, ▶, ▶] to select a scene and press [ENTER].

Tips for making data discs

- When there are more than 8 groups, the eighth group onwards will be displayed on one vertical line in the menu screen.
- There may be differences in the display order on the menu screen and computer screen.
- This unit cannot play files recorded using packet write.

DVD-RAM

- Discs must conform to UDF 2.0.

DVD-R/RW

- Discs must conform to UDF bridge (UDF 1.02/ISO9660).
- This unit does not support multi-session. Only the default session is played.

CD-R/RW

- Discs must conform to ISO9660 level 1 or 2 (except for extended formats).
- This unit supports multi-session but if there are many sessions it takes more time for play to start. Keep the number of sessions to a minimum to avoid this.

Naming folders and files

(Files are treated as contents and folders are treated as groups on this unit.)

At the time of recording, prefix folder and file names. This should be with numbers that have an equal number of digits, and should be done in the order you want to play them (this may not work at times).

Files must have the extension (→ below).

WMA (Extension: “.WMA” or “.wma”)

- Compatible compression rate: between 48 kbps and 320 kbps
- You cannot play WMA files that are copy-protected.
- This unit does not support Multiple Bit Rate (MBR).

MP3 (Extension: “.MP3” or “.mp3”)

- Compatible compression rate: between 32 kbps and 320 kbps
- This unit does not support ID3 tags.
- Compatible sampling rates:
 - DVD-RAM, DVD-R/RW: 11.02, 12, 22.05, 24, 44.1 and 48 kHz
 - CD-R/RW: 8, 11.02, 12, 16, 22.05, 24, 32, 44.1 and 48 kHz

JPEG (Extension: “.JPG”, “.jpg”, “.JPEG” or “.jpeg”)

- JPEG files taken on a digital camera that conform to DCF Standard (Design rule for Camera File system) Version 1.0 are displayed. Files that have been altered, edited or saved with computer picture editing software may not be displayed.
- This unit cannot display moving pictures, MOTION JPEG and other such formats, and still pictures other than JPEG (e.g. TIFF), or play pictures with attached audio.

MPEG4 (Extension: “.ASF” or “.asf”)

- You can play MPEG4 data [conforming to SD VIDEO specifications (ASF standard)/MPEG4 (Simple Profile) video system/G.726 audio system] recorded with Panasonic SD multi cameras or DVD video recorders with this unit.
- The recording date may differ from that of the actual date.

DivX (Extension: “.DIVX”, “.divx”, “.AVI” or “.avi”)

- You can play all versions of DivX® video (including DivX®6) [DivX video system/MP3, Dolby Digital or MPEG audio system] with standard playback of DivX® media files. Functions added with DivX Ultra are not supported.
- GMC (Global Motion Compensation) is not supported.
- DivX files greater than 2 GB or have no index may not be played properly on this unit.
- This unit supports all resolutions up to maximum of 720 × 480 (NTSC)/720 × 576 (PAL).
- You can select up to 8 types of audio and subtitles on this unit.

e.g. **MP3**

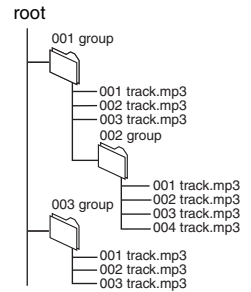

Using on-screen menus

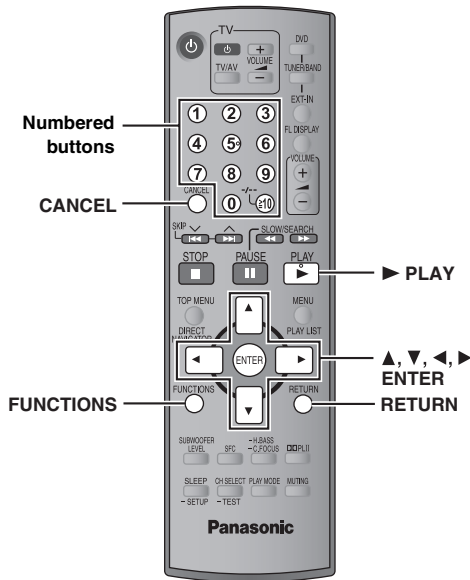

1	FUNCTIONS	Show the Main menu.
2	Select Go to the next menu Register Return to the previous menu	Select the menu. e.g. DVD-V
3	Select Register 1 2 3 4 5 6 7 8 9 0 E10	Make the settings. e.g. DVD-V
4	RETURN	Press to exit.

Main menu
Items shown differ depending on the type of disc.

Program Group Title Chapter Track Playlist Content	To start from a specific item e.g. DVD-VR To select Program 12 Press the numbered buttons: [1] → [2] → [ENTER]
--	--

Time	(Time Slip and Time Search do not work with +R/+RW discs.) To skip incrementally or decrementally (Time Slip for play only) 1 Press [ENTER] twice to show the Time Slip indicator. 2 Press [▲, ▼] to select the time and press [ENTER]. • To change the steps more quickly, press and hold [▲, ▼]. To start from a specific time (Time Search) To change remaining/elapsed time display
Video	MPEG4 DivX To display pixel number DivX fps (frame per second) is also displayed.
Audio	DVD-A DVD-V DivX (with multiple soundtracks) To select audio soundtrack DVD-VR VCD DivX To select "L", "R" or "LR" DVD-V (Karaoke disc) To select "On" or "Off" for vocals • Read the disc's instructions for details. Signal type/data LPCM/PPCM/Digital/DTS/MP3/MPEG: Signal type kHz (Sampling frequency)/bit/ch (Number of channels) e.g. 3/2 .1ch .1: Low frequency effect (not displayed if there is no signal) 0: No surround 1: Mono surround 2: Stereo surround (left/right) 1: Center 2: Front left+ Front right 3: Front left+ Front right+ Center • DivX It may take some time for play to start if you change the audio on a DivX video disc.
	WMA MP3 To display the current bitrate or sampling frequency
Still Picture	To switch still pictures
Thumbnail	To show thumbnail images
Subtitle	DVD-V DivX (with multiple subtitles) VCD (SVCD only) To select subtitle language • On +R/+RW, a subtitle number may be shown for subtitles that are not displayed. • DVD-VR "On" or "Off" appears only with discs that contain subtitle on/off information (Subtitle on/off information cannot be recorded using Panasonic DVD Recorders).
Marker (VR)	DVD-VR To recall a marker recorded on DVD-Video recorders Press [▲, ▼] → Press [ENTER].
Angle	(with multiple angles) To select a video angle
Rotate Picture	To rotate a picture
Slideshow	To turn on/off slideshow On ↔ Off To change the slideshow timing 1 (Fast) to 5 (Slow)
Other Settings	(→ page 21)

Using on-screen menus

Play Speed	<p>DVD-A (Motion picture part) DVD-VR DVD-V</p> <p>To change play speed</p> <p>– from “×0.6” to “×1.4”</p> <ul style="list-style-type: none"> ● Press [▶] PLAY) to return to normal play. ● After you change the speed <ul style="list-style-type: none"> – Dolby Pro Logic II and Sound Enhancement have no effect. – Audio output switches to 2-channel stereo. – Sampling frequency of 96 kHz is converted to 48 kHz. ● This function may not work depending on the disc's recording.
-------------------	---

■ **Play Menu**

This works only when the elapsed play time can be displayed. It also works with all JPEG content.

Repeat	<p>DVD-VR: Program→All→Off</p> <ul style="list-style-type: none"> ● During playlist play: Scene→Playlist→Off <p>DVD-A: Track→Group*→Off</p> <p>DVD-V: Chapter→Title*→Off</p> <p>VCD CD: Track→All→Off</p> <p>WMA MP3 MPEG4 DivX: Content→Group*→Off</p> <p>JPEG: Group*→Off</p> <p>*“All” is displayed during all group (DVD-A), program or random play.</p>
	<p>Except JPEG DVD-VR (Still picture part) MPEG4 DivX</p> <p>To repeat a specified section</p> <p>Press [ENTER] at the starting and ending points. Press [ENTER] again to cancel.</p>
Marker	<p>Except DVD-VR</p> <p>To mark up to 5 positions to play again</p> <p>Press [ENTER] (The unit is now ready to accept markers.)</p> <p>To mark a position: Press [ENTER] (at the desired point).</p> <p>To mark another position: Press [◀, ▶] to select “*” → Press [ENTER].</p> <p>To recall a marker: Press [◀, ▶] → Press [ENTER].</p> <p>To erase a marker: Press [◀, ▶] → Press [CANCEL].</p> <ul style="list-style-type: none"> ● This feature does not work during program and random play. ● Markers you add are cleared when you open the disc tray or switch the unit to standby.
	<p>DVD-VR (Except still picture part)</p> <p>DVD-V (Except +R/+RW)</p> <p>Allows you to browse the disc contents and start playing from the selected position. You can select either “Intro Mode” or “Interval Mode” in “Advanced Disc Review” in the “Disc” tab (→ page 23).</p> <p>When you find a title/program to play</p> <p>Press [▶] PLAY).</p> <ul style="list-style-type: none"> ● This may not work depending on the disc and the play position. ● DVD-VR This does not work when playing a playlist (→ page 18).
Advanced Disc Review	

■ **Picture Menu**

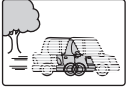
Picture Mode	<p>Normal</p> <p>Cinema1: Mellows images and enhances detail in dark scenes.</p> <p>Cinema2: Sharpens images and enhances detail in dark scenes.</p> <p>Animation: Suitable for animation.</p> <p>Dynamic: Enhances the contrast for powerful images.</p> <p>User: Press [ENTER] to select “Picture Adjustment” (→ below).</p>
	<p>Picture Adjustment</p> <p>Contrast: Increases the contrast between light and dark parts of the picture.</p> <p>Brightness: Brightens the picture.</p> <p>Sharpness: Adjusts the sharpness of the edges of horizontal lines.</p> <p>Colour: Adjusts the shade of the picture's color.</p> <p>Gamma: Adjusts the brightness of dark parts.</p> <p>Depth Enhancer: Reduces the rough noise in the background to give a greater feeling of depth.</p>
Video Output Mode	<p>To select suitable picture quality with your television</p> <p>*480p/576p (progressive)</p> <p>*480i/576i (interlace)</p> <p>When you select “xxx”p (progressive) and a confirmation screen appears, select “Yes” only if connecting to a progressive output compatible television.</p> <p>* The numbers displayed depend on the disc being played. One of the above numbers is displayed.</p>
	<p>If you have chosen “xxx”p (progressive) (→ above), select the method of conversion for progressive output to suit the type of material.</p> <ul style="list-style-type: none"> ● The setting will return to Auto or Auto1 when the disc tray is opened, the unit is turned off or another source is selected. <p>When playing PAL discs, MPEG4 or DivX video contents</p> <p>Auto: Automatically detects the film and video content, and appropriately converts it.</p> <p>Video: Select when using Auto, and the content is distorted.</p> <p>Cinema: Select this if the edges of the film content appear jagged or rough when Auto is selected.</p> <p>However, if the video content is distorted as shown in the illustration to the right, then select Auto.</p> 
Transfer Mode	<p>When playing NTSC discs</p> <p>Auto1: Automatically detects the film and video content, and appropriately converts it.</p> <p>Auto2: In addition to Auto1, automatically detects film contents with different frame rates and appropriately converts it.</p> <p>Video: Select when using Auto1 and Auto2, and the content is distorted.</p>
	<p>When you select “Auto” the constructing method of the DivX contents is automatically distinguished and output. If the picture is distorted, select “I (Interlace)” or “P (Progressive)” depending on which constructing method was used when the contents were recorded to disc.</p> <p>Auto, I (Interlace), P (Progressive)</p>
Source Select	<p>DivX</p>



Other Settings

Items shown differ depending on the type of disc.

Audio Menu

Dolby Pro Logic II	(→ page 28, Enhancing the stereo sound: Dolby Pro Logic II)
Dialogue Enhancer	<p>To make the dialogue in movies easier to hear</p> <p>DVD-V (Dolby Digital, DTS, MPEG, 3-channel or higher, with the dialogue recorded in the center channel)</p> <p>DivX (Dolby Digital, 3-channel or higher, with the dialogue recorded in the center channel)</p> <p>On ↔ Off</p>
Sound Enhancement	<p>To enjoy comfortable, analog-like sound</p> <p>DVD-VR DVD-V (Discs recorded with 48 kHz only)</p> <p>WMA MP3 (Disc recording is other than 8 kHz, 16 kHz or 32 kHz)</p> <p>VCD CD</p> <p>On ↔ Off</p> <ul style="list-style-type: none"> • This may have no effect depending on the disc's recording. • This does not work with MP3 on DVD-RAM or DVD-R/RW.

Manual Zoom	<p>To zoom in and out manually</p> <ul style="list-style-type: none"> – in 0.01-unit steps from “×1.00” to “×1.60” – in 0.02-unit steps from “×1.60” to “×2.00” – in 0.05-unit steps from “×2.00” to “×4.00” (MPEG4 DivX only) <ul style="list-style-type: none"> • To change the steps more quickly, press and hold [▲, ▼]. • MPEG4 DivX It may not be possible to zoom up to “×4.00” depending upon the connected television and its settings.
Bit Rate Display	<p>DVD-A (Motion picture part)</p> <p>DVD-VR DVD-V VCD MPEG4 DivX</p> <p>On ↔ Off</p>
GUI See-through	To make the on-screen menu transparent Off, On, Auto
GUI Brightness	To adjust the on-screen menu brightness –3 to +3

Display Menu

Information	JPEG On ↔ Off
Subtitle Position	0 to –60 (in 2 unit steps)
Subtitle Brightness	Auto, 0 to –7
4:3 Aspect	<p>To select how to show images made for 4:3 aspect screens on a 16:9 aspect television</p> <p>Normal: Laterally stretches images.</p> <p>Auto: Expands 4:3 letterbox images to fill more of the screen. Other images appear in full in the center of the screen.</p> <p>Shrink: Images appear in the center of the screen.</p> <p>Zoom: Expands to 4:3 aspect ratio. If your television has a similar feature, use it instead for a better effect.</p>
Just Fit Zoom	<p>To select the appropriate screen size to fit your television screen</p> <p>DVD-A (Motion picture part)</p> <p>DVD-VR DVD-V VCD</p> <p>Auto, 4:3 Standard, European Vista, 16:9 Standard, American Vista, Cinemascope1, Cinemascope2</p> <p>e.g.</p> <p>MPEG4 DivX</p> <p>Standard (×0.25 full-screen), Original (actual recorded size), Full (full-screen)</p> <ul style="list-style-type: none"> • This may not work depending on the discs recording.

Other Menu

Setup	(→ page 23)
Play as DVD-Video or Play as DVD-Audio	To play DVD-Video contents of DVD-Audio Select “Play as DVD-Video”.
Play as DVD-VR, Play as HighMAT or Play as Data Disc	To use functions for data discs (→ page 17) (To play JPEG, MP3, MPEG4 or DivX video contents on DVD-RAM, or to play a HighMAT disc without using HighMAT function) Select “Play as Data Disc”.

Changing the player settings

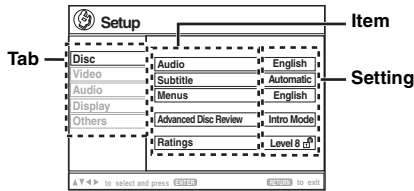
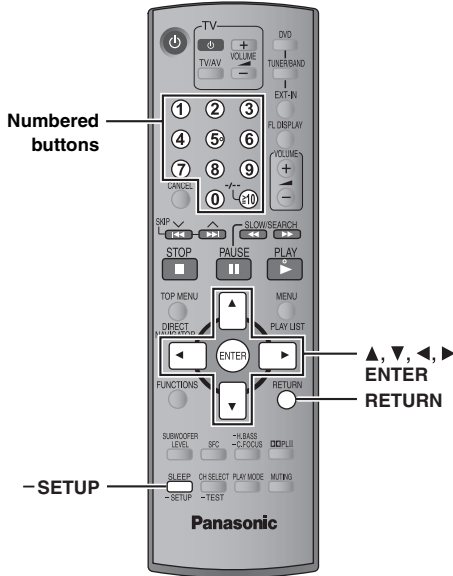

- The settings remain intact even if you switch the unit to standby.
- Underlined items are the factory settings in the following table.

1		<p>Press and hold to show the Setup menu. If you have not performed QUICK SETUP (→ page 10), the QUICK SETUP screen appears.</p>
2	<p>Select</p> <p>Go right</p>	<p>Select the tab.</p>
3	<p>Select</p> <p>Register</p>	<p>Select the item.</p>
4	<p>Select</p> <p>Register</p>	<p>Make the settings.</p>
5		<p>Press repeatedly to exit.</p>

QUICK SETUP enables successive settings of the items in the shaded area.

■ “Disc” tab

<p>Audio Choose the audio language.</p>	<ul style="list-style-type: none"> • <u>English</u> • (Language options)*¹ • Original*² • Other** ** ** *³
<p>Subtitle Choose the subtitle language.</p>	<ul style="list-style-type: none"> • <u>Automatic</u>*⁴ • English • (Language options)*¹ • Other** ** ** *³
<p>Menus Choose the language for disc menus. Changing the menu language in QUICK SETUP also changes this setting.</p>	<ul style="list-style-type: none"> • <u>English</u> • (Language options)*¹ • Other** ** ** *³
<p>Advanced Disc Review (→ page 21)</p>	<ul style="list-style-type: none"> • Intro Mode: Reviews each title/program. • Interval Mode: Reviews not only each title/program but also each 10-minute interval within a title/program.
<p>Ratings Set a rating level to limit DVD-Video play.</p>	<p>Setting ratings (When level 8 is selected)</p> <ul style="list-style-type: none"> • <u>8 No Limit</u> • 1 to 7 • 0 Lock All: To prevent play of discs without rating levels. <p>When you select your ratings level, a password screen is shown. Follow the on-screen instructions. Do not forget your password. A message screen will be shown if a DVD-Video disc exceeding the rating level is inserted in the unit. Enter your password and then follow the on-screen instructions.</p>

*¹ Language options

Continental Europe: French, German, Italian, Spanish, Polish, Swedish and Dutch

Australia and N.Z.: French, German, Italian, Spanish, Portuguese, Russian and Dutch

*² The original language designated on the disc is selected.

*³ Input the appropriate code from the language code list (→ page 25).



*⁴ If the language selected for “Audio” is not available, subtitles appear in that language (if available on the disc).

(Continued on next page)

Changing the player settings

QUICK SETUP enables successive settings of the items in the shaded area.

■ “Video” tab

TV Aspect Choose the setting to suit your television and preference.	<ul style="list-style-type: none"> ● 4:3 Pan&Scan: Regular aspect television (4:3) The sides of the widescreen picture are cut off so it fills the screen (unless prohibited by the disc). 
	<ul style="list-style-type: none"> ● 4:3 Letterbox: Regular aspect television (4:3) Widescreen picture is shown in the letterbox style. 
	<ul style="list-style-type: none"> ● 16:9: Widescreen television (16:9)
TV Type Select to suit the type of television.	<ul style="list-style-type: none"> ● Standard (Direct View TV) ● Projection TV ● CRT Projector ● Plasma TV ● LCD TV/Projector
Time Delay When connected with a Plasma display, adjust if you notice the audio is out of sync with the video.	<ul style="list-style-type: none"> ● 0ms ● 20ms ● 40ms ● 60ms ● 80ms ● 100ms
Video Out (AV/Component) ^{*6} Choose the video signal format to be output from the SCART (AV) and Component terminal.	<ul style="list-style-type: none"> ● Video/YPbPr ● RGB/No Output ● S-Video/YPbPr
Still Mode Specify the type of picture shown when paused.	<ul style="list-style-type: none"> ● Automatic ● Field^{*5}: The picture is not blurred, but picture quality is lower. ● Frame^{*5}: Overall quality is high, but the picture may appear blurred.
NTSC Disc Output Choose PAL 60 or NTSC output when playing NTSC discs (→ page 12, Video systems).	<ul style="list-style-type: none"> ● PAL60: When connected to a PAL television. ● NTSC: When connected to an NTSC television.
Picture/Video Output Change the video signal format to be output for JPEG, MPEG4 and DivX video if picture output is not smooth during playback.	<ul style="list-style-type: none"> ● Automatic ● NTSC/PAL60: Output will depend on “NTSC Disc Output” setting (→ above). ● PAL

■ “Audio” tab

Dynamic Range Compression	<ul style="list-style-type: none"> ● Off ● On: Adjusts for clarity even when the volume is low by compressing the range of the lowest sound level and the highest sound level. Convenient for late night viewing. (Only works with Dolby Digital)
Speaker Settings (→ page 25) Set the delay time for your center and surround speakers.	<ul style="list-style-type: none"> ● Center: 0.0/1.0/2.0/3.0/4.0/5.0 ms ● Surround (L/R): 0.0/5.0/10.0/15.0 ms

■ “Display” tab

Menu Language	<ul style="list-style-type: none"> ^{*6} ● English ● Français ● Deutsch ● Italiano ● Español ● Polski ● Svenska ● Nederlands ^{*7} ● English ● Français ● Deutsch ● Italiano ● Español ● Português ● Русский ● Nederlands
On-Screen Messages	<ul style="list-style-type: none"> ● On ● Off
Background during Play Select background during JPEG, MPEG4 and DivX video playback.	<ul style="list-style-type: none"> ● Black ● Grey

■ “Others” tab

FL Dimmer Change the brightness of the unit's display.	<ul style="list-style-type: none"> ● Bright ● Dim ● Auto: The display is dimmed, but brightens when you perform some operations.
DivX Registration Display the unit's registration code.	You need this registration code to purchase and play DivX Video-on-Demand (VOD) content (→ page 32, About DivX VOD content).
QUICK SETUP	<ul style="list-style-type: none"> ● Yes ● No
Re-initialise Setting Return all values in the Setup menus to the default settings.	<ul style="list-style-type: none"> ● Yes: The password screen is shown if “Ratings” (→ page 23) is set. Please enter the same password. After “INIT” on the display disappears, turn the unit off and on again. ● No

^{*5} Refer to “Frame still and field still” (→ page 13, Glossary).

^{*6} **Continental Europe**

^{*7} **Australia and N.Z.**

Changing the delay time of the speakers

(Effective when playing multi-channel audio)

(Center and surround speakers only)

For optimum listening with 5.1-channel sound, all the speakers, except for the subwoofer, should be the same distance from the seating position.

If you have to place the center or surround speakers closer to the seating position, adjust the delay time to make up for the difference.

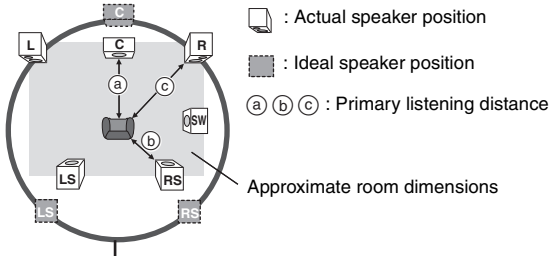

Circle of constant primary listening distance

If either distance (a) or (b) is less than (c), find the difference in the table and change to the recommended setting.

a) Center speaker		b) Surround speaker	
Difference (Approx.)	Setting	Difference (Approx.)	Setting
30 cm	1.0 ms	150 cm	5.0 ms
60 cm	2.0 ms	300 cm	10.0 ms
90 cm	3.0 ms	450 cm	15.0 ms
120 cm	4.0 ms		
150 cm	5.0 ms		

- 1 Press [▲, ▼] to select the delay time box and press [ENTER].
- 2 Press [▲, ▼] to adjust the delay time and press [ENTER].

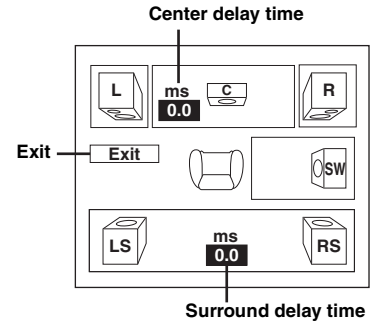

To finish the speaker setting

Press [◀] to select "Exit" and press [ENTER].

When you change the surround speaker setting for Dolby Digital, the setting also changes for Dolby Pro Logic II.

e.g., the settings for Music are the same as those for Dolby Digital.

Dolby Digital	Dolby Pro Logic II	
	Music	Movie
0 ms	0 ms	10 ms
5 ms	5 ms	15 ms
10 ms	10 ms	20 ms
15 ms	15 ms	25 ms

Language code list

Abkhazian: 6566	Danish: 6865	Italian: 7384	Norwegian: 7879	Swedish: 8386
Afar: 6565	Dutch: 7876	Japanese: 7465	Oriya: 7982	Tagalog: 8476
Afrikaans: 6570	English: 6978	Javanese: 7487	Pashto, Pushto: 8083	Tajik: 8471
Albanian: 8381	Esperanto: 6979	Kannada: 7578	Persian: 7065	Tamil: 8465
Ameharic: 6577	Estonian: 6984	Kashmiri: 7583	Polish: 8076	Tatar: 8484
Arabic: 6582	Faroese: 7079	Kazakh: 7575	Portuguese: 8084	Telugu: 8469
Armenian: 7289	Fiji: 7074	Kirghiz: 7589	Punjabi: 8065	Thai: 8472
Assamese: 6583	Finnish: 7073	Korean: 7579	Quechua: 8185	Tibetan: 6679
Aymara: 6589	French: 7082	Kurdish: 7585	Rhaeto-Romance: 8277	Tigrinya: 8473
Azerbaijani: 6590	Frisian: 7089	Laotian: 7679	Romanian: 8279	Tonga: 8479
Bashkir: 6665	Galician: 7176	Latin: 7665	Russian: 8285	Turkish: 8482
Basque: 6985	Georgian: 7565	Latvian, Lettish: 7686	Samoan: 8377	Turkmen: 8475
Bengali, Bangla: 6678	German: 6869	Lingala: 7678	Sanskrit: 8365	Twi: 8487
Bhutani: 6890	Greek: 6976	Lithuanian: 7684	Scots Gaelic: 7168	Ukrainian: 8575
Bihari: 6672	Greenlandic: 7576	Macedonian: 7775	Serbian: 8382	Urdu: 8582
Breton: 6682	Guarani: 7178	Malagasy: 7771	Serbo-Croatian: 8372	Uzbek: 8590
Bulgarian: 6671	Gujarati: 7185	Malay: 7783	Shona: 8378	Vietnamese: 8673
Burmese: 7789	Hausa: 7265	Malayalam: 7776	Sindhi: 8368	Volapük: 8679
Byelorussian: 6669	Hebrew: 7387	Maltese: 7784	Singhalese: 8373	Welsh: 6789
Cambodian: 7577	Hindi: 7273	Maori: 7773	Slovak: 8375	Wolof: 8779
Catalan: 6765	Hungarian: 7285	Marathi: 7782	Slovenian: 8376	Xhosa: 8872
Chinese: 9072	Icelandic: 7383	Moldavian: 7779	Somali: 8379	Yiddish: 7473
Corsican: 6779	Indonesian: 7378	Mongolian: 7778	Spanish: 6983	Yoruba: 8979
Croatian: 7282	Interlingua: 7365	Nauru: 7865	Sundanese: 8385	Zulu: 9085
Czech: 6783	Irish: 7165	Nepali: 7869	Swahili: 8387	

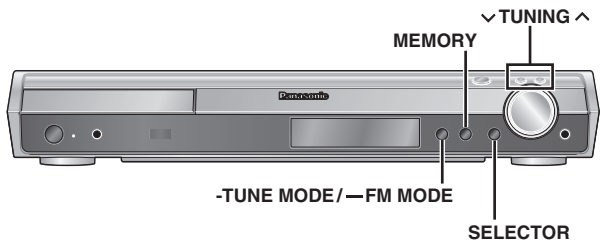
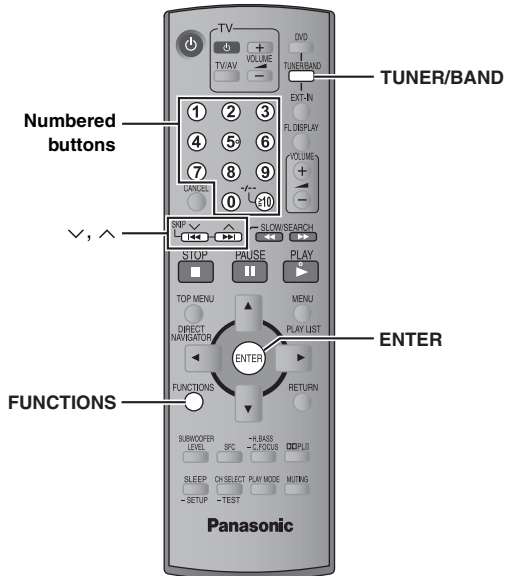

Selecting the preset channels

- 1 Press [TUNER/BAND] to select "FM" or "AM".
- 2 Press the numbered buttons to select the channel.
 - To select a 2-digit number
e.g. 12: [≥ 10] → [1] → [2]
 Alternatively, press [\vee , \wedge].



When a stereo FM broadcast is being received, "ST" lights in the display.

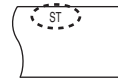

■ If noise is excessive

When "FM" is selected

Press and hold [—FM MODE] on the main unit to display "MONO".



Press and hold [—FM MODE] again to cancel the mode.

- The mode is also canceled when you change the frequency.

When "AM" is selected

Press [FUNCTIONS] on the remote control.

Each time you press the button: BP 2 ↔ BP 1

Manual tuning

Main unit only

- 1 Press [SELECTOR] to select "FM" or "AM".
- 2 Press [-TUNE MODE] to select "MANUAL".
- 3 Press [\vee TUNING \wedge] to select the frequency.
 - To start automatic tuning, press and hold [\vee TUNING \wedge] until the frequency starts scrolling. Tuning stops when a station is found.

■ Presetting the channel

Up to 15 stations can be set in each band, FM and AM.

- ① While listening to the radio broadcast
Press [ENTER].
- ② While the frequency and "PGM" are flashing on the display
Press the numbered buttons to select a channel.
 - To select a 2-digit number
e.g. To select 12:
[≥ 10] → [1] → [2]
 Alternatively, press [\vee , \wedge], and then press [ENTER].

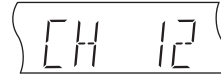

The station occupying a channel is erased if another station is preset to that channel.

Presetting stations automatically

Main unit only

Up to 15 stations can be set in each band, FM and AM.

- 1 Press [SELECTOR] to select "FM" or "AM".
- 2 Press [-TUNE MODE] to select "MANUAL".
Each time you press the button: MANUAL ↔ PRESET
- 3 Press [\vee TUNING \wedge] to tune to the lowest frequency (FM: 87.50, AM: 522).
- 4 Press and hold [MEMORY].
Release the button when "FM AUTO" or "AM AUTO" is displayed.

The tuner presets all the stations it can receive into the channels in ascending order.

- "SET OK" is displayed when the stations are set, and the radio tunes to the last preset station.
- "ERROR" is displayed when automatic presetting is unsuccessful. Preset the channels manually (→ right).

RDS broadcasting

Continental Europe

The unit can display the text data transmitted by the radio data system (RDS) available in some areas.
If the station you are listening to is transmitting RDS signals, "RDS" will light up on the display.

When "FM" is selected

Press **[FUNCTIONS]** to display the text data.

Each time you press the button:

PS (factory preset) → PTY → Frequency display

PTY displays			
NEWS	VARIED	FINANCE	COUNTRY
AFFAIRS	POP M	CHILDREN	NATIONAL
INFO	ROCK M	SOCIAL A	OLDIES
SPORT	M.O.R. M*	RELIGION	FOLK M
EDUCATE	LIGHT M	PHONE IN	DOCUMENT
DRAMA	CLASSICS	TRAVEL	TEST
CULTURE	OTHER M	LEISURE	ALARM
SCIENCE	WEATHER	JAZZ	

*"M.O.R. M"=Middle of the road music

Note

RDS displays may not be available if reception is poor.

Using an outdoor antenna (optional)

Use outdoor antennas if radio reception is poor.

- Disconnect the antenna when the unit is not in use.
- Do not use the outdoor antenna during an electrical storm.

The illustration shows SC-HT545.

FM outdoor antenna (Using a television antenna)

- Disconnect the FM indoor antenna.
- The antenna should be installed by a competent technician.

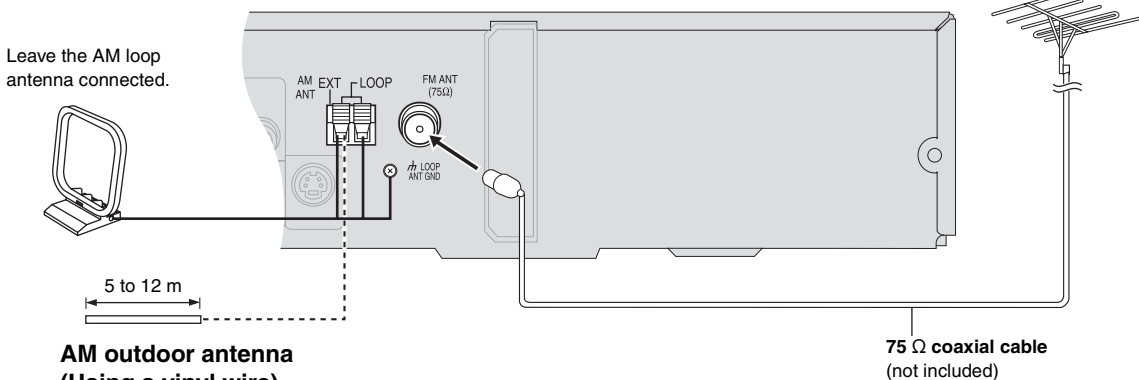

AM outdoor antenna (Using a vinyl wire)

Run a piece of vinyl wire horizontally across a window or other convenient location.



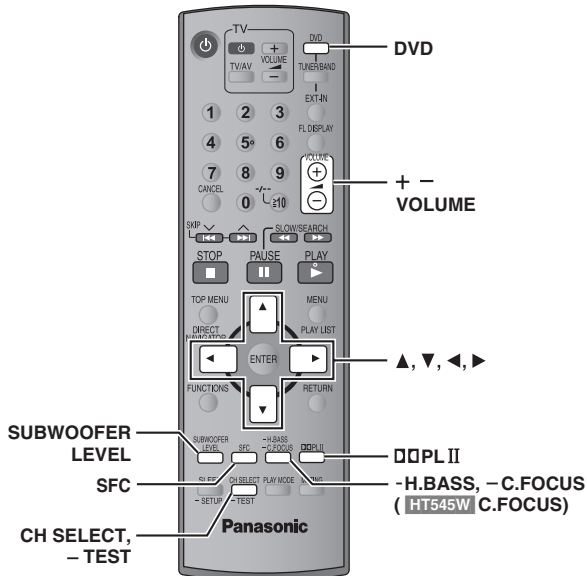

Enhancing the sound from the center speaker: Center Focus

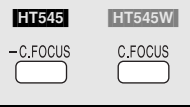

This applies to discs where the dialogue is recorded in the center channel.

You can make the sound of the center speaker seem like it is coming from within the television.

HT545

Press and hold [**-C.FOCUS**].

Each time you press and hold the button:
C FOCUS ON ↔ C FOCUS OFF



HT545W

Press [**C.FOCUS**].

Each time you press the button:
C FOCUS ON ↔ C FOCUS OFF

- This does not work when Sound Field Control (MOVIE, SPORT or MUSIC) is turned on.
- This also works when Dolby Pro Logic II is turned on.

Enhancing the stereo sound: Dolby Pro Logic II



Except **DivX**

Dolby Pro Logic II is an advanced decoder that derives 5-channel surround (Left and Right Front, Center, Left and Right Surround) from stereo sound sources, whether or not it has been specifically Dolby Surround encoded.

Press [**DOLBY II**].

Each time you press the button:

Movie: Movie software, recorded in Dolby Surround.
Music: Stereo sources
Off: Cancel



- This works only in DVD/CD mode.
- "DOLBY II" lights when there is effect.

Adjusting the amount of bass: Subwoofer level



You can adjust the amount of bass. The unit automatically selects the most suitable setting according to the type of playing source.

Press [**SUBWOOFER LEVEL**].

- **[DVD-V]** **[DVD-VR]**
SUB W 4 (factory preset) → SUB W 1 → SUB W 2 → SUB W 3
- **When another source is selected**
SUB W 2 (factory preset) → SUB W 3 → SUB W 4 → SUB W 1

- To check the current setting, press [**SUBWOOFER LEVEL**].
- The setting you make is retained, and recalled every time you play the same type of source, except when Sound Field Control (MOVIE, SPORT or MUSIC) is turned on.

- * When Sound Field Control (MOVIE, SPORT or MUSIC) is on, the factory presets are as follows:
- MOVIE: SUB W 4
 - SPORT: SUB W 2
 - MUSIC: SUB W 1

Note

- The following sound effects may not be available or have no effect depending on the type of source, or when headphones are used.
- You may experience a reduction in sound quality when these sound effects are used with some sources. If this occurs, turn the sound effects off.

Changing the sound quality: Sound Field Control



Press [**SFC**].

Each time you press the button:

- FLAT:** Cancel (no effect is added) (factory preset).
- MOVIE:** Use this mode when playing movie software.
- SPORT:** Simulates sound to make you feel like you are at a sports event.
- MUSIC:** Adds surround effects to stereo sources.
- HEAVY:** Adds punch to rock.
- CLEAR:** Clarifies higher sounds.
- SOFT:** For background music.

- To check the current setting, press [**SFC**].
- MOVIE, SPORT and MUSIC are not available when Dolby Pro Logic II is on, or when playing a disc recorded with a multi-channel source.
- You can adjust the volume of the surround speakers to get the best surround effect (→ page 29, Adjusting the volume of each speaker: Speaker level adjustments).
- When MOVIE, SPORT or MUSIC is turned on, you can enjoy audio from your television in 5.1-channel surround sound (→ page 31).

HT545 Enhancing the bass sound: H.BASS

-H.BASS
-C.FOCUS

You can enhance low-frequency sound so that heavy bass sound can be heard clearly, even if the acoustics of your room are not optimal. The unit automatically selects the most suitable setting according to the type of playing source.

Press [-H.BASS].

- **DVD-V** **DVD-VR**

H.BASS ON (factory preset) ←→ H.BASS OFF

- **When another source is selected**

H.BASS OFF (factory preset) ←→ H.BASS ON



The setting you make is retained, and recalled every time you play from the same type of source.

Adjusting the volume of each speaker: Speaker level adjustments

CH SELECT

-TEST

This is one of the ways to get appropriate surround effects.

Preparation

Press [DVD].

- 1 While stopped and no on-screen display is shown
Press and hold [-TEST] to output a test signal.

- To stop the test signal, press and hold [-TEST] again.

L: Front left C: Center R: Front right
RS: Right surround LS: Left surround

- There is no output from SW (subwoofer) channel.

- 2 **Press [VOLUME, +] or [-] to set the volume level normally used for listening.**

- 3 **Press [▲] (increase) or [▼] (decrease) to adjust the speaker level for each speaker.**

- Adjust the speaker levels to the same level as the front speakers.

C, RS, LS: -6 dB to +6 dB

■ To adjust speaker level during play

[Effective when playing multi-channel audio or when Dolby Pro Logic II or Sound Field Control (MOVIE, SPORT or MUSIC) is on.]

- ① **Press [CH SELECT] to select the speaker.**

L → C → R → RS → LS → SW
↑

SW: Subwoofer

- You can adjust SW only if the disc includes a subwoofer channel.
 - "SW" does not appear on the display and is not adjustable when "DOLBY II" is lit.
 - "S" appears on the display when "MOVIE", "SPORT" or "MUSIC" is selected with Sound Field Control (→ page 28). In this case, you can adjust both surround speaker levels at the same time using [▲, ▼].
- S: -6 dB to +6 dB

- ② **Press [▲] (increase) or [▼] (decrease) to adjust the speaker level for each speaker.**

C, RS, LS, SW: -6 dB to +6 dB

(L, R: Only the balance is adjustable.)

- To adjust the balance of the front speakers, while "L" or "R" is selected, press [◀, ▶].



Using other useful functions

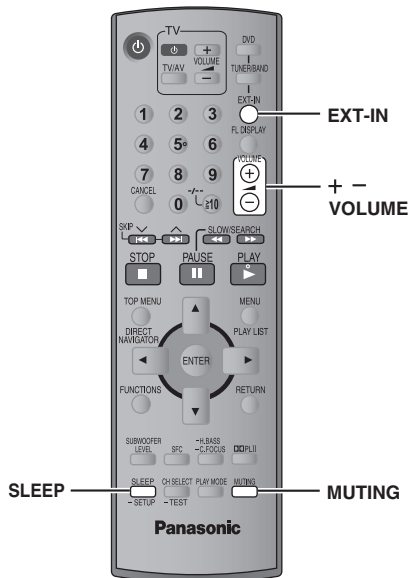

Setting the sleep timer

SLEEP

Press [SLEEP] to select the time (in minutes).

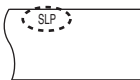
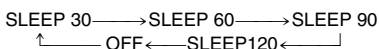

To cancel the timer

Press [SLEEP] to select "OFF".

To confirm the remaining time

Press [SLEEP] again.

To change the setting

Repeat the procedure from the beginning.

Muting the sound

MUTING

Press [MUTING].

"MUTING" flashes on the unit's display.



To cancel

- Press [MUTING] again or reduce the volume to minimum "VOL 0", and then raise it to the required level.
- Muting is canceled when you switch the unit to standby.

Using headphones

Main unit only

- 1 Reduce the volume and connect the headphones (not included).

Headphone plug type: Ø3.5 mm stereo mini plug



- 2 Adjust headphone volume with [VOLUME].

- Audio is automatically switched to 2-channel stereo.

Note

To prevent hearing damage, avoid listening for prolonged periods of time.

Using the Music Port

The Music Port allows you to connect and enjoy music from an external device (e.g. MP3 player) through your home theater system.

Preparation

To avoid distorted sound, make sure that any equalizer function of your external device is turned off.

- 1 Reduce the volume and connect the external device (not included).

Plug type: Ø3.5 mm stereo mini plug

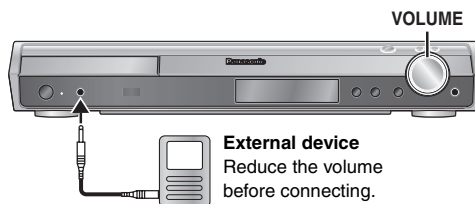

External device
Reduce the volume before connecting.

- 2 Press [EXT-IN] to select "MUSIC P."

Continental Europe

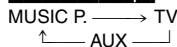

Australia and N.Z.

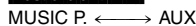

- 3 Adjust the external device volume to a normal listening level, and then adjust the volume of the main unit with [VOLUME].

- You can enjoy surround sound when you turn on Sound Field Control (MOVIE, SPORT or MUSIC) (→ page 28).

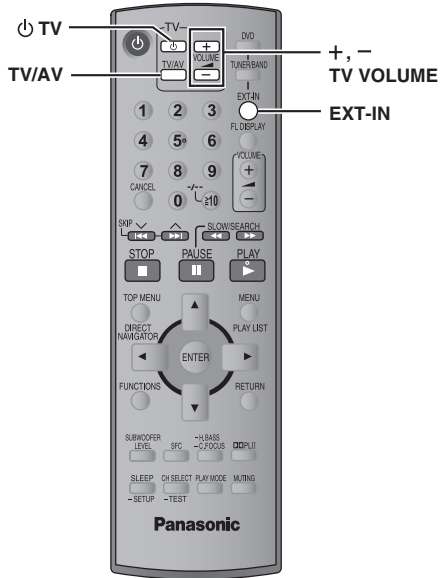

Operating the television

You can use the remote control to operate a Panasonic television. Connect your equipment referring to "Cable TV box or video cassette recorder connection" (→ page 9).

Note

The remote control may not work properly with some models.

Aim the remote control at the television.

Turning the television on/off

Press [TV].

Switching the television's video input mode

Press [TV/AV].

Adjusting the volume

Press [+ , - TV VOLUME].

To play audio from your television through your home theater system

Press [EXT-IN] to select "AUX" or "TV"^{*} as the source, reduce the volume on the television to its minimum, and control the volume on the main unit.

Each time you press the button:

Continental Europe

MUSIC P. → TV^{*}
 ↑ AUX ↓

Australia and N.Z.

MUSIC P. ← → AUX

* "TV" works only when the scart cable is connected (→ page 9).

- You can enjoy 5.1-channel surround sound when you turn on Sound Field Control (MOVIE, SPORT or MUSIC) (→ page 28).



Safety precautions

Placement

Set the unit up on an even surface away from direct sunlight, high temperatures, high humidity, and excessive vibration. These conditions can damage the cabinet and other components, thereby shortening the unit's service life.

Do not place heavy items on the unit.

Voltage

Do not use high voltage power sources. This can overload the unit and cause a fire.

Do not use a DC power source. Check the source carefully when setting the unit up on a ship or other places where DC is used.

AC mains lead protection

Ensure the AC mains lead is connected correctly and not damaged. Poor connection and lead damage can cause fire or electric shock. Do not pull, bend, or place heavy items on the lead.

Grasp the plug firmly when unplugging the lead. Pulling the AC mains lead can cause electric shock.

Do not handle the plug with wet hands. This can cause electric shock.

Foreign matter

Do not let metal objects fall inside the unit. This can cause electric shock or malfunction.

Do not let liquids get into the unit. This can cause electric shock or malfunction. If this occurs, immediately disconnect the unit from the power supply and contact your dealer.

Do not spray insecticides onto or into the unit. They contain flammable gases which can ignite if sprayed into the unit.

Service

Do not attempt to repair this unit by yourself. If sound is interrupted, indicators fail to light, smoke appears, or any other problem that is not covered in these instructions occurs, disconnect the AC mains lead and contact your dealer or an authorized service center. Electric shock or damage to the unit can occur if the unit is repaired, disassembled or reconstructed by unqualified persons.

Extend operating life by disconnecting the unit from the power source if it is not to be used for a long time.

About DivX VOD content

DivX Video-on-Demand (VOD) content is encrypted for copyright protection. In order to play DivX VOD content on this unit, you first need to register the unit.

Follow the online instructions for purchasing DivX VOD content to enter the unit's registration code and register the unit. For more information about DivX VOD, visit www.divx.com/vod.

Display the unit's registration code

(→ page 24, "DivX Registration" in "Others" tab)

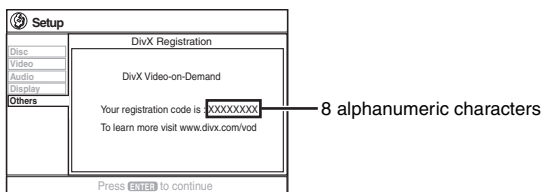

- We recommend that you make a note of this code for future reference.
- After playing DivX VOD content for the first time, another registration code is then displayed in "DivX Registration". Do not use this registration code to purchase DivX VOD content. If you use this code to purchase DivX VOD content, and then play the content on this unit, you will no longer be able to play any content that you purchased using the previous code.
- If you purchase DivX VOD content using a registration code different from this unit's code, you will not be able to play this content. ("Authorization Error" is displayed.)

Regarding DivX content that can only be played a set number of times

Some DivX VOD content can only be played a set number of times. When you play this content, the remaining number of plays is displayed. You cannot play this content when the number of remaining plays is zero. ("Rented Movie Expired" or "Rental Expired" is displayed.)

When playing this content

- The number of remaining plays is reduced by one if
 - you press [⏪] or press and hold [—SETUP].
 - you press [■ STOP]. (Press [■ PAUSE] to pause play.)
 - you press [◀◀, ▶▶] SKIP or [◀◀, ▶▶] SLOW/SEARCH] etc. and arrive at another content or the start of the content being played.
- Resume (→ page 15, Stop) and Marker (→ page 21, Play Menu) functions do not work.



Troubleshooting guide

Before requesting service, make the following checks. If you are in doubt about some of the check points, or if the solutions indicated in the table do not solve the problem, consult your dealer for instructions.

Power		Page
No power.	<ul style="list-style-type: none"> ● Insert the AC mains lead securely. 	9
The unit is automatically switched to standby mode.	<ul style="list-style-type: none"> ● The Sleep timer was working and had reached the set time limit. 	30

Unresponsive or inoperable function

No response when any buttons are pressed.	<ul style="list-style-type: none"> ● This unit cannot play discs other than the ones listed in these operating instructions. ● The unit may not be operating properly due to lightning, static electricity or some other external factor. Turn the unit off and then back on. Alternatively, turn the unit off, disconnect the AC mains lead, and then reconnect it. ● Condensation has formed. Wait 1 to 2 hours for it to evaporate. 	12 — —
No response when remote control buttons are pressed.	<ul style="list-style-type: none"> ● Check that the batteries are installed correctly. ● The batteries are depleted. Replace them with new ones. ● Aim the remote control at the remote control signal sensor and operate. 	10 10 11
No picture or sound.	<ul style="list-style-type: none"> ● Check the video or speaker connection. ● Check the power or input setting of the connected equipment and the main unit. ● Check that the disc has something recorded on it. 	6, 8, 9 — —
You have forgotten your ratings password. Reset all the settings to Factory Preset.	<ul style="list-style-type: none"> ● While stopped and "DVD/CD" is the source, press and hold [■] (Stop) on the main unit and [≥10] on the remote control until "Initialised" disappears from the television. Turn the unit off and on again. All settings will return to the default values. 	—

Specific operation undesirable or unexpected

It takes time before play starts.	<ul style="list-style-type: none"> ● Play may take time to begin when an MP3 track has still picture data. Even after the track starts, the correct play time will not be displayed. This is normal. [MP3] ● This is normal on DivX video. [DivX] 	— —
Folders on a data CD are not displayed correctly. [WMA] [MP3] [JPEG] [MPEG4] [DivX]	<ul style="list-style-type: none"> ● Folders deeper than the eighth layer are displayed as the eighth layer. 	—
A menu screen appears during skip or search. [VCD]	<ul style="list-style-type: none"> ● This is normal for Video CDs. 	—
Playback control menu does not appear. [VCD] with playback control	<ul style="list-style-type: none"> ● Press [■ STOP] twice and then press [▶ PLAY]. 	—
Program and Random play do not work. [DVD-V]	<ul style="list-style-type: none"> ● These functions do not work with some DVD-Videos. 	—
Selecting audio soundtrack "2" does not change the audio. [DVD-A]	<ul style="list-style-type: none"> ● Even if a second soundtrack is not recorded, two numbers are normally shown. 	—
Play does not start.	<ul style="list-style-type: none"> ● This unit may not play WMA and MPEG4 that contains still picture data. ● If playing DivX VOD content, refer to the homepage where you purchased the DivX VOD content. (Example: www.divx.com/vod) [DivX] ● If a disc contains CD-DA and other formats, proper playback may not be possible. 	— — —
Play restarts from the beginning when the soundtrack is changed. [DVD-A]	<ul style="list-style-type: none"> ● This is normal for DVD-Audio. 	—
Scenes are skipped intermittently. [DVD-VR] [DVD-V]	<ul style="list-style-type: none"> ● If you change the volume or sound effects during Advanced Disc Review, the function continues without the on-screen display. Cancel the function. 	21

Subtitle

Subtitle position is wrong.	<ul style="list-style-type: none"> ● Adjust the position. ("Subtitle Position" in Display Menu) 	22
No subtitles.	<ul style="list-style-type: none"> ● Display the subtitles. ("Subtitle" in Main menu) ● Subtitles may not be displayed depending on the disc. [DivX] 	20 —

(Continued on next page)



Marker		Page	
Cannot add markers.	<ul style="list-style-type: none"> You cannot add markers with DVD-RAM or DVD-R/-RW (DVD-VR) discs. If the disc's elapsed play time does not appear on the unit's display, you cannot add markers. 	—	
A-B repeat			
Point B is automatically set.	<ul style="list-style-type: none"> The end of an item becomes point B when it is reached. 	—	
Sound abnormal or improper			
Sound is distorted.	<ul style="list-style-type: none"> Noise may occur when playing WMA. 	—	
Effects do not work.	<ul style="list-style-type: none"> Some audio effects do not work or have less effect with some discs. 	—	
Humming is heard during play.	<ul style="list-style-type: none"> An AC mains lead or fluorescent light is near the main unit. Keep other appliances and cables away from the main unit (and wireless system HT545W). 	—	
No sound.	<ul style="list-style-type: none"> There may be a slight pause in sound when you change the play speed. Audio may not be output due to how files were created. DivX 	—	
Menus			
The Setup menu cannot be accessed.	<ul style="list-style-type: none"> Select "DVD/CD" as the source. Cancel All group, Program and Random play. 	— 16	
Picture abnormal or unviewable			
The picture on the television is not displayed correctly or disappears.	<ul style="list-style-type: none"> The unit and television are using different video systems. Use a multi-system or PAL television. The system used on the disc does not match your television. <ul style="list-style-type: none"> PAL discs cannot be correctly viewed on an NTSC television. This unit can convert NTSC signals to PAL 60 for viewing on a PAL television ("NTSC Disc Output" in "Video" tab). Ensure that the unit is connected directly to the television, and is not connected through a video cassette recorder. Mobile telephone chargers can cause some disturbance. If you are using an indoor television antenna, change to an outdoor antenna. The television antenna wire is too close to the unit. Move it away from the unit. Change "Source Select" in Picture Menu. DivX 	— — 24 8, 9 — — — 21	
	Picture size does not fit the screen.	<ul style="list-style-type: none"> Change "TV Aspect" in the "Video" tab. 	24
		<ul style="list-style-type: none"> Use the television to change the aspect. If your television does not have that function, change "4:3 Aspect" in Display Menu. 	22
		<ul style="list-style-type: none"> Change the zoom setting. ("Just Fit Zoom" or "Manual Zoom" in Display Menu) 	22
	Picture stops. DivX	<ul style="list-style-type: none"> Picture may stop if the DivX files are greater than 2 GB. 	—
	Menu is not displayed correctly.	<ul style="list-style-type: none"> Restore the zoom ratio to "×1.00". ("Manual Zoom" in Display Menu) 	22
<ul style="list-style-type: none"> Set "Subtitle Position" in Display Menu to "0". 		22	
<ul style="list-style-type: none"> Set "4:3 Aspect" in Display Menu to "Normal". 		22	
Auto zoom function does not work well.	<ul style="list-style-type: none"> Turn off television zoom function. 	—	
	<ul style="list-style-type: none"> Use the other preset aspect ratios or manual adjustment. Zoom function may not work well, especially in dark scenes and may not work depending on the type of disc. 	22 —	
When playing PAL disc, picture distorted.	<ul style="list-style-type: none"> Set "Transfer Mode" in Picture Menu to "Auto". 	21	
Progressive video			
There is ghosting when progressive output is on.	<ul style="list-style-type: none"> This problem is caused by the editing method or material used on DVD-Video, but should be corrected if you use interlaced output. Set "Video Output Mode" in Picture Menu to "480i" or "576i". (Alternatively, press and hold [CANCEL] to switch to "480i" or "576i".) 	21	
Pictures not in progressive output.	<ul style="list-style-type: none"> Select "480p" or "576p" in "Video Output Mode" in Picture Menu. The unit's VIDEO OUT, S-VIDEO OUT [or SCART (AV) Continental Europe] terminal outputs the interlaced signal even if "PRG" is displayed. 	21 8, 9	



Listening to the radio

Page

Distorted sound or noise is heard. “ST” flickers or does not light.	<ul style="list-style-type: none"> Adjust the position of the FM or AM antenna. Use an outdoor antenna. 	— 27
A beat sound is heard.	<ul style="list-style-type: none"> Turn the television off or move it away from the unit. 	—
A low hum is heard during AM broadcasts.	<ul style="list-style-type: none"> Separate the antenna from other cables. 	—

HT545W Wireless system

No sound.	<ul style="list-style-type: none"> Ensure that the digital transceiver is fully inserted into the slot of the main unit. Ensure that the wireless system is connected to the mains socket, and “W” is displayed on the main unit’s display. 	7 9
-----------	---	--------

Unit displays

The display is dark.	<ul style="list-style-type: none"> Select “Bright” in “FL Dimmer” in the “Others” tab. 	24
“NO PLAY”	<ul style="list-style-type: none"> You inserted a disc the unit cannot play; insert one it can. You inserted a blank disc. You inserted a disc that has not been finalized. 	12 — —
“NO DISC”	<ul style="list-style-type: none"> You have not inserted a disc; insert one. You have not inserted the disc correctly; insert it correctly. 	— 14
“F61”	<ul style="list-style-type: none"> Check and correct the speaker cable connections. If this does not fix the problem, consult the dealer. 	6
“DVD U11”	<ul style="list-style-type: none"> Disc may be dirty. Wipe it clean. 	12
“ERROR”	<ul style="list-style-type: none"> Incorrect operation performed. Read the instructions and try again. 	—
“DVD H□□” “DVD F□□□” □ stands for a number.	<ul style="list-style-type: none"> Trouble may have occurred. The numbers following “H” and “F” depend on the status of the unit. Turn the unit off and then back on. Alternatively, turn the unit off, disconnect the AC mains lead, and then reconnect it. If the service numbers fail to clear, note the service number and contact a qualified service person. 	— —
HT545W “W” is flashing.	<ul style="list-style-type: none"> There is no link between the main unit and the wireless system. Check that the wireless system is connected to the mains socket. Ensure that the digital transceiver is fully inserted into the slot of the main unit. 	9 7
“D.MIX” is flashing. DVD-A	<ul style="list-style-type: none"> Down-mixing is the process of remixing the multiple-channel audio found on some discs into two channels. The disc contains single-channel or multiple-channel signals which may not be reproduced authentically. 	—

Television displays

“⊘”	<ul style="list-style-type: none"> The operation is prohibited by the unit or disc. 	—
“Cannot play group xx, content xx” “Cannot display group xx, content xx”	<ul style="list-style-type: none"> You are trying to display incompatible group or content. 	—
“This disc may not be played in your region”	<ul style="list-style-type: none"> Only DVD-Video discs that include or have the same region number as the one on the rear panel of this unit can be played. 	Cover page
No on-screen display.	<ul style="list-style-type: none"> Select “On” in “On-Screen Messages” in the “Display” tab. 	24
“Group xx content xx is protected”	<ul style="list-style-type: none"> You are trying to play protected group or content. You cannot play it. 	—
“Check the disc”	<ul style="list-style-type: none"> This disc may be dirty. 	12
“Authorization Error” DivX	<ul style="list-style-type: none"> You are trying to play the DivX VOD content that was purchased with a different registration code. You cannot play the content on this unit. 	32
“Rented Movie Expired” DivX	<ul style="list-style-type: none"> The DivX VOD content has zero remaining plays. You cannot play it. 	32



AMPLIFIER SECTION

HT545

RMS Output Power: Dolby Digital Mode

Front Ch	110 W per channel (3 Ω), 1 kHz, 10 % THD
Surround Ch	90 W per channel (4 Ω), 1 kHz, 10 % THD
Center Ch	225 W per channel (6 Ω), 1 kHz, 10 % THD
Subwoofer Ch	225 W per channel (6 Ω), 100 Hz, 10 % THD
Total RMS Dolby Digital mode power	850 W

DIN Output Power: Dolby Digital Mode

Front Ch	80 W per channel (3 Ω), 1 kHz, 1 % THD
Surround Ch	65 W per channel (4 Ω), 1 kHz, 1 % THD
Center Ch	75 W per channel (6 Ω), 1 kHz, 1 % THD
Subwoofer Ch	75 W per channel (6 Ω), 100 Hz, 1 % THD
Total DIN Dolby Digital mode power	440 W

HT545W

RMS Output Power: Dolby Digital Mode

Front Ch	110 W per channel (3 Ω), 1 kHz, 10 % THD
Surround Ch ^{#8}	110 W per channel (3 Ω), 1 kHz, 10 % THD
Center Ch	110 W per channel (3 Ω), 1 kHz, 10 % THD
Subwoofer Ch	110 W per channel (3 Ω), 100 Hz, 10 % THD
Total RMS Dolby Digital mode power	660 W

DIN Output Power: Dolby Digital Mode

Front Ch	75 W per channel (3 Ω), 1 kHz, 1 % THD
Surround Ch ^{#8}	65 W per channel (3 Ω), 1 kHz, 1 % THD
Center Ch	75 W per channel (3 Ω), 1 kHz, 1 % THD
Subwoofer Ch	75 W per channel (3 Ω), 100 Hz, 1 % THD
Total DIN Dolby Digital mode power	430 W

FM/AM TUNER, TERMINALS SECTION

Preset Memory

FM 15 stations
AM/MW 15 stations

Frequency Modulation (FM)

Frequency range	87.50–108.00 MHz (50-kHz step)
Sensitivity	
Continental Europe	1.8 μV (IHF)
Others	2.5 μV (IHF)
S/N 26 dB	
Continental Europe	1.4 μV
Others	2.2 μV
Antenna terminals	75 Ω (unbalanced)

Amplitude Modulation (AM/MW)

Frequency range	522–1629 kHz (9-kHz step)
AM Sensitivity S/N 20 dB at 999 kHz	560 μV/m

Phone jack

Terminal	Stereo, 3.5 mm jack
----------	---------------------

Front Music Port

Sensitivity	100 mV, 15 kΩ
Terminal	Stereo, 3.5 mm jack

DISC SECTION

Discs played (8 cm or 12 cm)

- DVD (DVD-Video, DVD-Audio, DivX^{®1,2})
 - DVD-RAM (DVD-VR, MP3^{®2,6}, JPEG^{®2,3}, MPEG4^{®2,4}, DivX^{®1,2})
 - DVD-R (DVD-Video, DVD-VR, MP3^{®2,6}, JPEG^{®2,3}, MPEG4^{®2,4}, DivX^{®1,2})
 - DVD-R DL (DVD-Video, DVD-VR)
 - DVD-RW (DVD-Video, DVD-VR, MP3^{®2,6}, JPEG^{®2,3}, MPEG4^{®2,4}, DivX^{®1,2})
 - +R/+RW (Video)
 - +R DL (Video)
 - CD, CD-R/RW [CD-DA, Video CD, SVCD^{®5}, MP3^{®2,6}, WMA^{®2,7}, JPEG^{®2,3}, MPEG4^{®2,4}, DivX^{®1,2}, HighMAT Level 2 (Audio and Image)]
- ^{#1} Plays all versions of DivX[®] video (including DivX^{®6}) with standard playback of DivX[®] media files. Certified to the DivX Home Theater Profile.
GMC (Global Motion Compensation) is not supported.
- ^{#2} The total combined maximum number of recognizable audio, picture and video contents and groups: 4000 audio, picture and video contents and 400 groups.
- ^{#3} Exif Ver 2.1 JPEG Baseline files
Picture resolution: between 160×120 and 6144×4096 pixels (Sub sampling is 4:0:0, 4:2:0, 4:2:2 or 4:4:4). Extremely long and narrow pictures may not be displayed.
- ^{#4} MPEG4 data recorded with Panasonic SD multi cameras or DVD video recorders
Conforming to SD VIDEO specifications (ASF standard)/MPEG4 (Simple Profile) video system/G.726 audio system
- ^{#5} Conforming to IEC62107
- ^{#6} MPEG-1 Layer 3, MPEG-2 Layer 3
- ^{#7} Windows Media Audio Ver.9.0 L3
Not compatible with Multiple Bit Rate (MBR)

Pick up

Wavelength (DVD/CD)	662/785 nm
Laser power (DVD/CD)	CLASS 1/CLASS 1M

NORSK

Bølgelengde (DVD/CD)	662/785 nm
Laserstyrke	Ingen farlig stråling sendes ut

Audio output (Disc)

Number of channels	5.1ch (FL, FR, C, SL, SR, SW)
--------------------	-------------------------------

VIDEO SECTION

Video system PAL625/50, PAL525/60, NTSC

Composite video output

Output level	1 Vp-p (75 Ω)
Terminal	Pin jack (1 system)
Continental Europe	Scart jack (1 system)

S-video output

Y output level	1 Vp-p (75 Ω)
C output level	PAL; 0.3 Vp-p (75 Ω)
	NTSC; 0.286 Vp-p (75 Ω)
Terminal	S terminal (1 system)
Continental Europe	Scart jack (1 system)

Component video output (NTSC: 480p/480i, PAL: 576p/576i)

Y output level	1 Vp-p (75 Ω)
P _B output level	0.7 Vp-p (75 Ω)
P _R output level	0.7 Vp-p (75 Ω)
Terminal	Pin jack (Y: green, P _B : blue, P _R : red) (1 system)

Continental Europe

RGB video output

R output level	0.7 Vp-p (75 Ω)
G output level	0.7 Vp-p (75 Ω)
B output level	0.7 Vp-p (75 Ω)
Terminal	Scart jack (1 system)



SPEAKER SECTION

HT545 Front speakers SB-FS440

Type	1 way, 1 speaker system (Bass reflex)
Speaker unit(s)	Impedance 3 Ω
Full range	6.5 cm Cone type
Input power (IEC)	110 W ^{*9} (Max)
Output sound pressure	80 dB/W (1.0 m)
Frequency range	102 Hz–25 kHz (–16 dB) 113 Hz–22 kHz (–10 dB)
Dimensions (W×H×D)	92 mm×273 mm×95.4 mm
Mass	0.84 kg

HT545 Surround speakers SB-FS441

Type	1 way, 1 speaker system (Bass reflex)
Speaker unit(s)	Impedance 4 Ω
Full range	6.5 cm Cone type
Input power (IEC)	90 W ^{*9} (Max)
Output sound pressure	80 dB/W (1.0 m)
Frequency range	96 Hz–25 kHz (–16 dB) 120 Hz–22 kHz (–10 dB)
Dimensions (W×H×D)	92 mm×135 mm×95.4 mm
Mass	0.75 kg

HT545 Center speaker SB-PC640

Type	1 way, 2 speaker system (Bass reflex)
Speaker unit(s)	Impedance 6 Ω
1. Full range	6.5 cm Cone type
2. Full range	6.5 cm Cone type
Input power (IEC)	250 W ^{*9} (Max)
Output sound pressure	84 dB/W (1.0 m)
Frequency range	105 Hz–25 kHz (–16 dB) 125 Hz–22 kHz (–10 dB)
Dimensions (W×H×D)	270 mm×92 mm×95.4 mm
Mass	1.3 kg

HT545 Subwoofer SB-W440

Type	1 way, 1 speaker system (Bass reflex)
Speaker unit(s)	Impedance 6 Ω
Woofer	16 cm Cone type
Input power (IEC)	250 W (Max)
Output sound pressure	80 dB/W (1.0 m)
Frequency range	32 Hz–220 Hz (–16 dB) 38 Hz–180 Hz (–10 dB)
Dimensions (W×H×D)	183 mm×396 mm×267 mm
Mass	4 kg

HT545W Front speakers SB-FS640

Type	1 way, 1 speaker system (Bass reflex)
Speaker unit(s)	Impedance 3 Ω
Full range	6.5 cm Cone type
Input power (IEC)	110 W ^{*9} (Max)
Output sound pressure	80 dB/W (1.0 m)
Frequency range	110 Hz–25 kHz (–16 dB) 122 Hz–22 kHz (–10 dB)
Dimensions (W×H×D)	92 mm×135 mm×95.4 mm
Mass	0.75 kg

HT545W Surround speakers SB-FS545

Type	1 way, 1 speaker system (Bass reflex)
Speaker unit(s)	Impedance 3 Ω
Full range	6.5 cm Cone type
Input power (IEC)	110 W ^{*9} (Max)
Output sound pressure	80 dB/W (1.0 m)
Frequency range	110 Hz–25 kHz (–16 dB) 122 Hz–22 kHz (–10 dB)
Dimensions (W×H×D)	92 mm×135 mm×95.4 mm
Mass	0.75 kg

HT545W Center speaker SB-PC545

Type	1 way, 1 speaker system (Bass reflex)
Speaker unit(s)	Impedance 3 Ω
Full range	6.5 cm Cone type
Input power (IEC)	110 W ^{*9} (Max)
Output sound pressure	80 dB/W (1.0 m)
Frequency range	92 Hz–25 kHz (–16 dB) 110 Hz–22 kHz (–10 dB)
Dimensions (W×H×D)	135 mm×92 mm×95.4 mm
Mass	0.75 kg

HT545W Subwoofer SB-W545

Type	1 way, 1 speaker system (Bass reflex)
Speaker unit(s)	Impedance 3 Ω
Woofer	16 cm Cone type
Input power (IEC)	110 W (Max)
Output sound pressure	80 dB/W (1.0 m)
Frequency range	29 Hz–165 Hz (–16 dB) 35 Hz–140 Hz (–10 dB)
Dimensions (W×H×D)	183 mm×396 mm×267 mm
Mass	4 kg

GENERAL

Power supply	HT545W AC 230 V, 50 Hz
	HT545 AC 230–240 V, 50 Hz
Power consumption	HT545W Main unit 75 W
	HT545 Main unit 115 W
Dimensions (W×H×D)	430 mm×60 mm×354 mm
Mass	HT545W Main unit 3.3 kg
	HT545 Main unit 3.35 kg
Operating temperature range	+5 °C to +35 °C
Operating humidity range	5 % to 90 % RH (no condensation)

Power consumption in standby mode	approx. 0.5 W
-----------------------------------	---------------

HT545W

WIRELESS SYSTEM AND DIGITAL TRANSCEIVER

Power supply	AC 230–240 V, 50 Hz
Power consumption	Digital transceiver 0.85 W
	Wireless system 30 W
Dimensions (W×H×D)	Digital transceiver 97 mm×47.5 mm×8.5 mm
	Wireless system 89 mm×189 mm×180 mm
Mass	Digital transceiver 0.03 kg
	Wireless system 0.7 kg
Wireless module	Frequency range 2.403–2.425 GHz
	RF Output Power 14 dBm (Max)
Operating temperature range	+5 °C to +35 °C
Operating humidity range	5 % to 90 % RH (no condensation)

Power consumption in standby mode	approx. 1.2 W
-----------------------------------	---------------

*8 Power output of the wireless system amplifier SE-FX60

*9 Rating with low-cut filter equipped amplifier

Note

- Specifications are subject to change without notice. Mass and dimensions are approximate.
- Total harmonic distortion is measured by a digital spectrum analyzer.



Manufactured under license from Dolby Laboratories. "Dolby", "Pro Logic" and the double-D symbol are trademarks of Dolby Laboratories.

"DTS" and "DTS Digital Surround" are registered trademarks of Digital Theater Systems, Inc.

This product incorporates copyright protection technology that is protected by method claims of certain U.S. patents and other intellectual property rights owned by Macrovision Corporation and other rights owners. Use of this copyright protection technology must be authorized by Macrovision Corporation, and is intended for home and other limited viewing uses only unless otherwise authorized by Macrovision Corporation. Reverse engineering or disassembly is prohibited.

MPEG Layer-3 audio decoding technology licensed from Fraunhofer IIS and Thomson multimedia.

Windows Media, and the Windows logo are trademarks, or registered trademarks of Microsoft Corporation in the United States and/or other countries.

WMA is a compression format developed by Microsoft Corporation. It achieves the same sound quality as MP3 with a file size that is smaller than that of MP3.



HighMAT™ and the HighMAT logo are either trademarks or registered trademarks of Microsoft Corporation in the United States and/or other countries.



HDCD®, High Definition Compatible Digital® and Pacific Microsonics™ are either registered trademarks or trademarks of Pacific Microsonics, Inc. in the United States and/or other countries.

HDCD system manufactured under license from Pacific Microsonics, Inc. This product is covered by one or more of the following: In the USA: 5,479,168, 5,638,074, 5,640,161, 5,808,574, 5,838,274, 5,854,600, 5,864,311, 5,872,531, and in Australia: 669114, with other patents pending.

This product is licensed under the MPEG-4 Visual patent portfolio license for the personal and non-commercial use of a consumer for (i) encoding video in compliance with the MPEG-4 Visual Standard ("MPEG-4 Video") and/or (ii) decoding MPEG-4 Video that was encoded by a consumer engaged in a personal and non-commercial activity and/or was obtained from a video provider licensed by MPEG LA to provide MPEG-4 Video. No license is granted or shall be implied for any other use. Additional information including that relating to promotional, internal and commercial uses and licensing may be obtained from MPEG LA, LLC. See <http://www.mpegla.com>.

Official DivX® Certified product. Plays all versions of DivX® video (including DivX®6) with standard playback of DivX® media files. DivX, DivX Certified, and associated logos are trademarks of DivX, Inc. and are used under license.



**DIGITAL TRANSCEIVER SH-FX80T
WIRELESS SYSTEM SE-FX60
CE1177Φ
OPERATING AT 2403MHz TO 2425MHz**

English**Declaration of Conformity (DoC)**

Hereby, Panasonic AVC Networks Singapore Pte. Ltd. (PAVCSG) declares that this product is in compliance with the essential requirements and other relevant provisions of Directive 1999/5/EC. Customers can download a copy of the original DoC to our R&TTE products from our DoC server: <http://www.doc.panasonic.de>

Contact in the EU: Panasonic Services Europe, a Division of Panasonic Marketing Europe GmbH, Panasonic Testing Centre, Winsbergring 15, 22525 Hamburg, F. R. Germany

This product is intended to be used in the following countries: AT (Austria), BE (Belgium), CH (Switzerland), CZ (Czech Republic), DE (Germany), DK (Denmark), EE (Estonia), ES (Spain), FI (Finland), FR (France), GR (Greece), HU (Hungary), IT (Italy), LT (Lithuania), LV (Latvia), NL (Netherlands), NO (Norway), PL (Poland), PT (Portugal), SE (Sweden), SI (Slovenia), SK (Slovakia)

Suomi**Yhdenmukaisuusilmoitus**

Panasonic AVC Networks Singapore Pte. Ltd. (PAVCSG) ilmoittaa täten, että tämä tuote on direktiivin 1999/5/EY olennaisista vaatimusten ja muiden asiaan kuuluvien määräysten mukainen. Asiakkaat voivat ladata radio- ja telepääätuotteidemme alkuperäisen yhdenmukaisuusilmoituksen palvelimestamme: <http://www.doc.panasonic.de>

Yhteystiedot Euroopan unionissa: Panasonic Services Europe, a Division of Panasonic Marketing Europe GmbH, Panasonic Testing Centre, Winsbergring 15, 22525 Hamburg, F. R. Germany

Tämä tuote on tarkoitettu käytettäväksi seuraavissa maissa: AT (Itävalta), BE (Belgia), CH (Sveitsi), CZ (Tšekin tasavalta), DE (Saksa), DK (Tanska), EE (Viro), ES (Espanja), FI (Suomi), FR (Ranska), GR (Kreikka), HU (Unkari), IT (Italia), LT (Liettua), LV (Latvia), NL (Alankomaat), NO (Norja), PL (Puola), PT (Portugali), SE (Ruotsi), SI (Slovenia), SK (Slovakia)

Ελληνικά**Δήλωση περί συμμόρφωσης**

Με το παρόν, η Panasonic AVC Networks Singapore Pte. Ltd. (PAVCSG) δηλώνει ότι αυτό το προϊόν συμμορφώνεται με τις βασικές προϋποθέσεις και τις σχετικές διατάξεις της Ευρωπαϊκής Οδηγίας 1999/5/ΕΚ.

Οι πελάτες μπορούν να πραγματοποιήσουν λήψη της δήλωσης περί συμμόρφωσης για τα προϊόντα R&TTE από τον διακομιστή μας στη διεύθυνση: <http://www.doc.panasonic.de>

Επικοινωνία στην ΕΕ: Panasonic Services Europe, a Division of Panasonic Marketing Europe GmbH, Panasonic Testing Centre, Winsbergring 15, 22525 Hamburg, F. R. Germany

Αυτό το προϊόν προορίζεται για χρήση στις ακόλουθες χώρες: AT (Αυστρία), BE (Βέλγιο), CH (Ελβετία), CZ (Δημοκρατία της Τσεχίας), DE (Γερμανία), DK (Δανία), EE (Εσθονία), ES (Ισπανία), FI (Φινλανδία), FR (Γαλλία), GR (Ελλάδα), HU (Ουγγαρία), IT (Ιταλία), LT (Λιθουανία), LV (Λετονία), NL (Ολλανδία), NO (Νορβηγία), PL (Πολωνία), PT (Πορτογαλία), SE (Σουηδία), SI (Σλοβενία), SK (Σλοβακία)

Português**Declaração de Conformidade (DoC)**

A Panasonic AVC Networks Singapore Pte. Ltd. (PAVCSG) declara que este produto está em conformidade com os requisitos essenciais e outras provisões relevantes da Directiva 1999/5/EC.

Os clientes podem transferir uma cópia da DoC original para os nossos produtos R&TTE a partir do nosso servidor de DoC: <http://www.doc.panasonic.de>

Contactos na UE: Panasonic Services Europe, a Division of Panasonic Marketing Europe GmbH, Panasonic Testing Centre, Winsbergring 15, 22525 Hamburg, F. R. Germany

Este produto destina-se a ser utilizado nos seguintes países: AT (Áustria), BE (Bélgica), CH (Suíça), CZ (República Checa), DE (Alemanha), DK (Dinamarca), EE (Estónia), ES (Espanha), FI (Finlândia), FR (França), GR (Grécia), HU (Hungria), IT (Itália), LT (Lituânia), LV (Letónia), NL (Holanda), NO (Noruega), PL (Polónia), PT (Portugal), SE (Suécia), SI (Eslovénia), SK (Eslováquia)

Lietuviškai**Atitikties deklaracija (DoC)**

*Panasonic AVC Networks Singapore Pte. Ltd., (PAVCSG) patvirtina, kad šis gaminytis atitinka svarbiausius direktyvos 1999/5/EB reikalavimus ir kitas taikytinas nuostatas. Klientai gali atsisiųsti mūsų R&TTE gaminių DoC originalą iš DoC serverio: <http://www.doc.panasonic.de>

ES kontaktiniai duomenys: Panasonic Services Europe, a Division of Panasonic Marketing Europe GmbH, Panasonic Testing Centre, Winsbergring 15, 22525 Hamburg, F. R. Germany

Šis gaminytis yra skirtas naudoti šiose šalyse: AT (Austrija), BE (Belgija), CH (Šveicarija), CZ (Čekija), DE (Vokietija), DK (Danija), EE (Estija), ES (Ispanija), FI (Suomija), FR (Prancūzija), GR (Graikija), HU (Vengrija), IT (Italija), LT (Lietuva), LV (Latvija), NL (Nyderlandai), NO (Norvegija), PL (Lenkija), PT (Portugalija), SE (Švedija), SI (Slovėnija), SK (Slovakija)

Slovenščina**Izjava o skladnosti (DoC)**

Štem, Panasonic AVC Networks Singapore Pte. Ltd. (PAVCSG) izjavlja, da je ta izdelke v skladu s temeljnimi zahtevami in drugimi ustreznimi določbami Direktive 1999/5/ES. Kupci si lahko za naše izdelke naložijo kopijo izjave o skladnosti iz našega serverja: <http://www.doc.panasonic.de>

Stiki v EU: Panasonic Services Europe, a Division of Panasonic Marketing Europe GmbH, Panasonic Testing Centre, Winsbergring 15, 22525 Hamburg, F. R. Germany

Ta izdelke je namenjen za uporabo v naslednjih državah: AT (Avstrija), BE (Belgija), CH (Švicca), CZ (Češka republika), DE (Nemčija), DK (Danska), EE (Estonija), ES (Španija), FI (Finska), FR (Francija), GR (Grčija), HU (Madžarska), IT (Italija), LT (Litva), LV (Latvija), NL (Nizozemska), NO (Norveška), PL (Poljska), PT (Portugalska), SE (Švedska), SI (Slovenija), SK (Slovaška)

Norsk**Samsvarserklæring**

Panasonic AVC Networks Singapore Pte. Ltd. (PAVCSG) erklærer herved at dette produktet samsvarer med de vesentlige krav og andre relevante bestemmelser i direktiv 1999/5/EF. Kundene kan laste ned en kopi av den originale samsvarserklæringen til vårt radio- og teleterminalnystyr (R&TTE) fra serveren (DoC-serveren) vår: <http://www.doc.panasonic.de>

Kontakt i EU: Panasonic Services Europe, a Division of Panasonic Marketing Europe GmbH, Panasonic Testing Centre, Winsbergring 15, 22525 Hamburg, F. R. Germany

Dette produktet er beregnet på bruk i følgende land: AT (Østerrike), BE (Belgia), CH (Sveits), CZ (Tsjekiske republikk), DE (Tyskland), DK (Danmark), EE (Estland), ES (Spania), FI (Finland), FR (Frankrike), GR (Hellas), HU (Ungarn), IT (Italia), LT (Litauen), LV (Latvia), NL (Nederland), NO (Norge), PL (Polen), PT (Portugal), SE (Sverige), SI (Slovenia), SK (Slovakia)

Magyar**Megfelelőségi nyilatkozat (DoC)**

Az Panasonic AVC Networks Singapore Pte. Ltd. (PAVCSG) ezúton kijelenti, hogy ez a termék megfelel az 1999/5/EK irányelv alapvető követelményeinek és egyéb vonatkozó rendelkezéseinek.

Az ügyfelek letölthetik a Rádió- és Távközlési Végberendezés (R&TTE) termékeinkre vonatkozó, eredeti DoC-k másolatát DoC kiszolgálónkról: <http://www.doc.panasonic.de>

Európai Unió kapcsolatok: Panasonic Services Europe, a Division of Panasonic Marketing Europe GmbH, Panasonic Testing Centre, Winsbergring 15, 22525 Hamburg, F. R. Germany

Ezt a terméket az alábbi országokban történő használatra szánják. AT (Ausztria), BE (Belgium), CH (Svájc), CZ (Cseh Köztársaság), DE (Németország), DK (Dánia), EE (Esztorozság), ES (Spanyolország), FI (Finnország), FR (Franciaország), GR (Görögország), HU (Magyarország), IT (Olaszország), LV (Litvánia), LT (Lettország), NL (Hollandia), NO (Norvégia), PL (Lengyelország), PT (Portugália), SE (Svédország), SI (Szlovénia), SK (Szlovákia)

Slovensky**Prehlásenie konformity (DoC)**

Týmto spoločnosť Panasonic AVC Networks Singapore Pte. Ltd. (PAVCSG) prehlasuje, že tento produkt je v súlade s dôležitými požiadavkami a inými ustanoveniami Smernice 1999/5/EC. Zákazníci si môžu prebrať kópiu originálu DoC pre naše R&TTE produkty s nášho DoC servera. <http://www.doc.panasonic.de>

Kontakt v EU: Panasonic Services Europe, a Division of Panasonic Marketing Europe GmbH, Panasonic Testing Centre, Winsbergring 15, 22525 Hamburg, F. R. Germany

Tento produkt je určený pre požitie v nasledujúcich krajinách: AT (Rakúsko), BE (Belgicko), CH (Švajčiarsko), CZ (Česko), DE (Nemecko), DK (Dánsko), EE (Estónsko), ES (Španielsko), FI (Fínsko), FR (Francúzsko), GR (Grécko), HU (Maďarsko), IT (Taliansko), LT (Litva), LV (Lotyšsko), NL (Holandsko), NO (Nórsko), PL (Poľsko), PT (Portugalsko), SE (Švédsko), SI (Slovensko), SK (Slovensko)

Eesti**Vastavusdeklaratsioon (VD)**

Käesolevaga deklareerib Panasonic AVC Networks Singapore Pte. Ltd. (PAVCSG), et antud toode vastab 1999/5/EÜ direktiivi põhinõuete ning muudes olulistates sätetes toodud nõuetele. Klientidel on võimalik meie R&TTE-toodete originaalvastavus-deklaratsiooni äratrükki meie VD-serverilt alla laadida: <http://www.doc.panasonic.de>

Kontaktandmed EÜ-s: Panasonic Services Europe, a Division of Panasonic Marketing Europe GmbH, Panasonic Testing Centre, Winsbergring 15, 22525 Hamburg, F. R. Germany

Käesolev toode on ette nähtud kasutamiseks alljärgnevatel riikides: AT (Austria), BE (Belgia), CH (Sveits), CZ (Tšehhi Vabariik), DE (Saksamaa), DK (Taani), EE (Eesti), ES (Hispaania), FI (Soome), FR (Prantsusmaa), GR (Kreeka), HU (Ungari), IT (Itaalia), LT (Leedu), LV (Läti), NL (Holland), NO (Norra), PL (Poola), PT (Portugal), SE (Rootsi), SI (Sloveenia), SK (Slovakkia)

Latviešu**Pazinājums par atbilstību (DoC)**

Ar šo "Panasonic AVC Networks Singapore Pte. Ltd. (PAVCSG), paziņo, ka šis izstrādājums atbilst direktīvas 1999/5/EK prasībām un citiem ar to saistītajiem nolikumiem. Klienti var lejupielādēt mūsu radio un telekomunikāciju termināļu aprīkojuma (R&TTE) izstrādājuma oriģinālu paziņojuma kopiju no mūsu DoC servera: <http://www.doc.panasonic.de>

Saziņa ES valstīs: Panasonic Services Europe, a Division of Panasonic Marketing Europe GmbH, Panasonic Testing Centre, Winsbergring 15, 22525 Hamburg, F. R. Germany

Šis izstrādājums ir paredzēts lietošanai šādās valstīs: AT (Austrija), BE (Belģija), CH (Šveice), CZ (Čehija), DE (Vācija), DK (Dānija), EE (Igaunija), ES (Spānija), FI (Somija), FR (Francija), GR (Griekija), HU (Ungārija), IT (Itālija), LT (Lietuva), LV (Latvija), NL (Nīderlande), NO (Norvēģija), PL (Polija), PT (Portugāle), SE (Zviedrija), SI (Slovēnija), SK (Slovākija)



This product may receive radio interference caused by mobile telephones during use. If such interference is apparent, please increase separation between the product and the mobile telephone.

The socket outlet shall be installed near the equipment and easily accessible or the mains plug or an appliance coupler shall remain readily operable.

THIS UNIT IS INTENDED FOR USE IN MODERATE CLIMATES.

-If you see this symbol-

Information on Disposal for Users of Waste Electrical & Electronic Equipment (private households)



This symbol on the products and/or accompanying documents means that used electrical and electronic products should not be mixed with general household waste.

For proper treatment, recovery and recycling, please take these products to designated collection points, where they will be accepted on a free of charge basis. Alternatively, in some countries you may be able to return your products to your local retailer upon the purchase of an equivalent new product. Disposing of this product correctly will help to save valuable resources and prevent any potential negative effects on human health and the environment which could otherwise arise from inappropriate waste handling. Please contact your local authority for further details of your nearest designated collection point. Penalties may be applicable for incorrect disposal of this waste, in accordance with national legislation.

For business users in the European Union

If you wish to discard electrical and electronic equipment, please contact your dealer or supplier for further information.

Information on Disposal in other Countries outside the European Union

This symbol is only valid in the European Union. If you wish to discard this product, please contact your local authorities or dealer and ask for the correct method of disposal.

SUOMI

VAROITUS!

LAITTEEN KÄYTTÄMINEN MUULLA KUIN TÄSSÄ KÄYTTÖOHJEESSA MAINITULLA TAVALLA SAATTAÄ ALTISTAA KÄYTTÄJÄN TURVALLISUUSLUOKAN 1 YLITTÄVÄLLE NÄKYMÄTTÖMÄLLE LASERSÄTEILYLLE.

VAROITUS:

TULIPALO-, SÄHKÖISKUVAARAN TAI TUOTETTA KOHTAAVAN MUUN VAHINGON VÄHENTÄMISEKSI EI LAITETTA SAA ALTISTAA SATEELLE, KOSTEUELLE, VESIPISAROILLE TAI ROISKEELLE, EIKÄ NESTETTÄ SISÄLTÄVIÄ ESINEITÄ, KUTEN ESIMERKIKSI MALJAKOITA, SAA ASETTAA LAITTEEN PÄÄLLE.

VAROITUS!

- ÄLÄ ASENNATA TAI LAITTA TÄTÄ LAITETTA KABINETTITYYPPISEEN KIRJAKAAPPIIN TAI MUUHUN SULJETTUUN TILAAN, JOTTA TUULETUS ONNISTUISI. VARMISTA, ETTÄ VERHO TAI MIKÄÄN MUU MATERIAALI EI HUONONNA TUULETUSTA, JOTTA VÄLTETTÄISIIN YLIKUUMENEMISESTÄ JOHTUVA SÄHKÖISKU- TAI TULIPALOVAARA.
- ÄLÄ PEITÄ LAITTEEN TUULETUSAUKKOJA SANOMALEHDELLÄ, PÖYTÄLIINALLA, VERHOLLA TAI MUULLA VASTAAVALLA ESINEELLÄ.
- ÄLÄ ASETA PALAVAA KYNTTILÄÄ TAI MUUTA AVOTULEN LÄHDETTÄ LAITTEEN PÄÄLLE.
- HÄVITÄ PARISTOT LUONTOA VAHINGOITTAMATTOMALLA TAVALLA.

TÄMÄ LAITE ON TARKOITETTU KÄYTETTÄVÄKSI LEUDOSSA ILMASTOSSA.

Laite tulee asettaa lähelle verkkopistorasiaa ja pistokkeen täytyy olla sellaisessa asennossa, että siihen on helppo tarttua ongelman sattuessa.

NORSK

ADVARSEL!

DETTE PRODUKTET ANVENDER EN LASER. BETJENING AV KONTROLLER, JUSTERINGER ELLER ANDRE INNGREP ENN DE SOM ER BESKREVET I DENNE BRUKSANVISNING, KAN FØRE TIL FARLIG BESTRÅLING. DEKSLER MÅ IKKE ÅPNES, OG FORSØK ALDRI Å REPARERE APPARATET PÅ EGENHÅND. ALT SERVICE OG REPARASJONSARBEID MÅ UTFØRES AV KVALIFISERT PERSONELL.

ADVARSEL:

FOR Å REDUSERE FAREN FOR BRANN, ELEKTRISK STØT ELLER SKADER PÅ PRODUKTET, MÅ DETTE APPARATET IKKE UTSETTES FOR REGN, FUKTIGHET, VANNDRÅPER ELLER VANNSPRUT. DET MÅ HELLER IKKE PLASSERES GJENSTANDER FYLT MED VANN, SLIK SOM BLOMSTERVASER, OPPÅ APPARATET.

ADVARSEL!

- APPARATET MÅ IKKE PLASSERES I EN BOKHYLLE, ET INNEBYGGET KABINETT ELLER ET ANNET LUKKET STED HVOR VENTILASJONSFORHOLDENE ER UTILSTREKKELIGE. SØRG FOR AT GARDINER ELLER LIGNENDE IKKE FORVERRER VENTILASJONSFORHOLDENE, SÅ RISIKO FOR ELEKTRISK SJOKK ELLER BRANN FORÅRSAKET AV OVERHETING UNNGÅS.
- APPARATETS VENTILASJONSÅPNINGER MÅ IKKE DEKKES TIL MED AVISER, BORDDUKER, GARDINER OG LIGNENDE.
- PLASSER IKKE ÅPEN ILD, SLIK SOM LEVENDE LYS, OPPÅ APPARATET.
- BRUKTE BATTERIER MÅ KASSERES UTEN FARE FOR MILJØET.

DETTE APPARATET ER BEREGNET TIL BRUK UNDER MODERATE KLIMAFORHOLD.

Utstyret bør plasseres i nærheten av AC-stikkontakten, og støpslet må være lett tilgjengelig hvis det skulle oppstå problemer.

Matsushita Electric Industrial Co., Ltd.

Web Site: <http://panasonic.net>

(En)

RQT8654-1B

F0406KN1056