

Panasonic

DVD Home Theater Sound System

Operating Instructions

Model No. **SC-DM3**



Before connecting, operating or adjusting this product, please read these instructions completely.

Please keep this manual for future reference.



As an ENERGY STAR® Partner, Panasonic has determined that this product meets the ENERGY STAR® guidelines for energy efficiency.

The region number of this unit is "1".

You can play DVD-Video marked "1", "ALL", or with a region number including "1".

Example:



See page 4 for details.

For U.S.A. only

The warranty can be found on page 34.

Dear customer

Thank you for purchasing this product.
For optimum performance and safety, please read these instructions carefully.

Operations in these instructions are described mainly with the remote control, but you can do the operations on the main unit if the controls are the same.

System	SC-DM3
Main unit	SA-DM3
Front and center speakers	SB-FDM3
Surround speakers	SB-RDM3
Subwoofer	SB-WDM3

Getting started

CAUTION!
THIS PRODUCT UTILIZES A LASER.
USE OF CONTROLS OR ADJUSTMENTS OR PERFORMANCE OF PROCEDURES OTHER THAN THOSE SPECIFIED HEREIN MAY RESULT IN HAZARDOUS RADIATION EXPOSURE.
DO NOT OPEN COVERS AND DO NOT REPAIR YOURSELF. REFER SERVICING TO QUALIFIED PERSONNEL.

WARNING:
TO REDUCE THE RISK OF FIRE, ELECTRIC SHOCK OR PRODUCT DAMAGE, DO NOT EXPOSE THIS APPARATUS TO RAIN, MOISTURE, DRIPPING OR SPLASHING AND THAT NO OBJECTS FILLED WITH LIQUIDS, SUCH AS VASES, SHALL BE PLACED ON THE APPARATUS.

CAUTION:
TO PREVENT ELECTRIC SHOCK MATCH WIDE BLADE OF PLUG TO WIDE SLOT, FULLY INSERT.

CAUTION!
DO NOT INSTALL, OR PLACE THIS UNIT, IN A BOOKCASE, BUILT-IN CABINET OR IN ANOTHER CONFINED SPACE. ENSURE THE UNIT IS WELL VENTILATED. TO PREVENT RISK OF ELECTRIC SHOCK OR FIRE HAZARD DUE TO OVERHEATING, ENSURE THAT CURTAINS AND ANY OTHER MATERIALS DO NOT OBSTRUCT THE VENTILATION VENTS.



CAUTION
RISK OF ELECTRIC SHOCK
DO NOT OPEN

CAUTION: TO REDUCE THE RISK OF ELECTRIC SHOCK, DO NOT REMOVE SCREWS. NO USER-SERVICEABLE PARTS INSIDE. REFER SERVICING TO QUALIFIED SERVICE PERSONNEL.

The lightning flash with arrowhead symbol, within an equilateral triangle, is intended to alert the user to the presence of uninsulated "dangerous voltage" within the product's enclosure that may be of sufficient magnitude to constitute a risk of electric shock to persons.

The exclamation point within an equilateral triangle is intended to alert the user to the presence of important operating and maintenance (servicing) instructions in the literature accompanying the appliance.

DANGER	- VISIBLE AND INVISIBLE LASER RADIATION WHEN OPEN. AVOID DIRECT EXPOSURE TO BEAM. (FDA 21 CFR)
CAUTION	- VISIBLE AND INVISIBLE LASER RADIATION WHEN OPEN. AVOID EXPOSURE TO BEAM. (IEC60825-1)
ATTENTION	- RAYONNEMENT LASER VISIBLE ET INVISIBLE EN CAS D'OUVERTURE. EXPOSITION DANGEREUSE AU FAISCEAU.
ADVARSEL	- SYNLIG OG USYNLIG LASERSTRÅLING VED ÅBNING. UNDGÅ UDSÆTTELSE FOR STRÅLING.
VARO!	- AVATTAESSA OLET ALLTIINA NÄKYVÄÄ JA NÄKYMÄTÖN LASERSÄTEILYLLÄ. ÄLÄ KATSO SÄTEESEEN.
VARNING	- SYNLIG OCH OSYNLIG LASERSTRÅLNING NÄR DENNA DEL ÄR ÖPPNAD. BETRÄKTA EJ STRÅLEN.
ADVARSEL	- SYNLIG OG USYNLIG LASERSTRÅLING NÄR DEKSEL ÅPNES. UNNGÅ EKSPONERING FOR STRÅLEN.
VORSICHT	- SICHTBARE UND UNSICHTBARE LASERSTRAHLUNG, WENN ABDECKUNG GEÖFFNET. NICHT DEM STRAHL AUSSETZEN.
注意	- 打开时有可见及不可见激光辐射。避免激光束照射。
注意	- ここを開くと可視及び不可視のレーザー光が出ます。ビームを直接見たり、触れたりしないでください。 RAL50233

(Inside of product)

THE FOLLOWING APPLIES ONLY IN THE U.S.A.:

CAUTION:
This equipment has been tested and found to comply with the limits for a Class B digital device, pursuant to Part 15 of the FCC Rules.
These limits are designed to provide reasonable protection against harmful interference in a residential installation. This equipment generates, uses and can radiate radio frequency energy and, if not installed and used in accordance with the instructions, may cause harmful interference to radio communications. However, there is no guarantee that interference will not occur in a particular installation. If this equipment does cause harmful interference to radio or television reception, which can be determined by turning the equipment off and on, the user is encouraged to try to correct the interference by one or more of the following measures:

- Reorient or relocate the receiving antenna.
- Increase the separation between the equipment and receiver.
- Connect the equipment into an outlet on a circuit different from that to which the receiver is connected.
- Consult the dealer or an experienced radio/TV technician for help.

Any unauthorized changes or modifications to this equipment would void the user's authority to operate this device.

This device complies with Part 15 of the FCC Rules. Operation is subject to the following two conditions: (1) This device may not cause harmful interference, and (2) this device must accept any interference received, including interference that may cause undesired operation.

Notice:
This product has parts that contains a small amount of mercury. It also contains lead in some components. Disposal of these materials may be regulated in your community due to environmental considerations.
For disposal or recycling information please contact your local authorities, or the Electronics Industries Alliance:
<<http://www.eiae.org>.>

Accessories

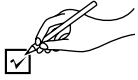

Please check and identify the supplied accessories. Use numbers indicated in parentheses when asking for replacement parts.

(Only for U.S.A.)

To order accessories contact 1-800-332-5368 or web site (<http://www.panasonic.com>).

(Only for Canada)

To order accessories, call the dealer from whom you have made your purchase.

- 1 Remote control
(N2QAJB000055)



- 2 Batteries
for remote control

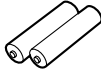

- 1 AC power supply cord
(RJA0065-1D)

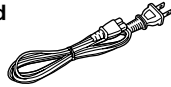

- 1 AM loop antenna
(N1DAAAA00001)

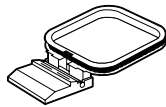

- 1 FM indoor antenna
(N1EAYY000002)

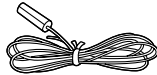

- 1 Video cable
(RJL1P016B15A)



- 1 Sheet of feet (4 feet)
for main unit
(RFA0631A-K)

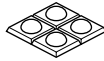

- 1 Stand
for main unit
(RYK1173-H)

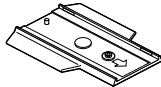

- 1 Cleaning cloth
for main unit
(RFE0088-1)



- 1 Antenna plug
(K2RC021B0001)



- 1 Sheet of speaker-cord stickers



Note

The included AC power supply cord is for use with this unit only. Do not use it with other equipment.

User memo:

DATE OF PURCHASE _____
DEALER NAME _____
DEALER ADDRESS _____
TELEPHONE NUMBER _____

The model number and serial number of this product can be found on either the back or the bottom of the unit. Please note them in the space provided below and keep for future reference.

MODEL NUMBER _____

SERIAL NUMBER _____

Getting started

Accessories	3
IMPORTANT SAFETY INSTRUCTIONS	4
Disc information	4
Simple setup	
STEP 1 Setup	5
STEP 2 Locating	5
STEP 3 Speakers	6
STEP 4 Television	7
STEP 5 Antennas and AC power supply cord ...	8
STEP 6 The remote control	9
STEP 7 Selecting TV screen type	9

Control reference guide	10
-------------------------------	----

Disc operations

Discs—Basic play	11
Playing MP3	12
Resume function	12
Skipping chapters or tracks	13
Fast forward and rewind—SEARCH	13
Slow-motion play	13
Frame-by-frame viewing	13
Starting play from a selected track or title	13
Cinema/Dialogue Enhancer	13

Changing soundtracks, subtitle languages and angles	14
--	----

Discs—Convenient functions	15
A-B repeat play/Repeat play	15
All group play/Program play	16
Random play	17
Selecting groups to play	17
Selecting still pictures—Page Skip	17

Using On-Screen Menu Icons	18
Common procedures/Shuttle screen	18
Disc information/Unit information	19

Radio operations

The radio: manual tuning	20
The radio: preset tuning	21

Sound quality/sound field operations

Sound field	22
DOLBY DIGITAL and DTS/DOLBY PRO LOGIC	23
SUPER SURROUND	24
Changing sound field and quality	24
Adjusting the bass	24

Other functions

Convenient functions	25
Muting the volume	25
Turning the display's light off	25
Adjusting the display's contrast	25
Operating a television	25
The sleep timer	25
Using headphones	25
Changing settings	26
Common procedures	27
Entering a password (Ratings)/Changing the delay time	28
Language code list	28

Optional audio/video equipment connections ..	29
Optional antenna connections	29

Reference

Troubleshooting guide	30
Maintenance	31
Glossary	32
Disc handling	32
Specifications	33
Limited Warranty (U.S.A.)	34
Product Service	35

IMPORTANT SAFETY INSTRUCTIONS





Read these operating instructions carefully before using the unit. Follow the safety instructions on the unit and the applicable safety instructions listed below. Keep these operating instructions handy for future reference.

- 1) Read these instructions.
- 2) Keep these instructions.
- 3) Heed all warnings.
- 4) Follow all instructions.
- 5) Do not use this apparatus near water.
- 6) Clean only with dry cloth.
- 7) Do not block any ventilation openings. Install in accordance with the manufacturer's instructions.
- 8) Do not install near any heat sources such as radiators, heat registers, stoves, or other apparatus (including amplifiers) that produce heat.
- 9) Do not defeat the safety purpose of the polarized or grounding-type plug. A polarized plug has two blades with one wider than the other. A grounding-type plug has two blades and a third grounding prong. The wide blade or the third prong are provided for your safety. If the provided plug does not fit into your outlet, consult an electrician for replacement of the obsolete outlet.
- 10) Protect the power cord from being walked on or pinched particularly at plugs, convenience receptacles, and the point where they exit from the apparatus.
- 11) Only use attachments/accessories specified by the manufacturer.
- 12) Use only with the cart, stand, tripod, bracket, or table specified by the manufacturer, or sold with the apparatus. When a cart is used, use caution when moving the cart/apparatus combination to avoid injury from tip-over. 
- 13) Unplug this apparatus during lightning storms or when unused for long periods of time.
- 14) Refer all servicing to qualified service personnel. Servicing is required when the apparatus has been damaged in any way, such as power-supply cord or plug is damaged, liquid has been spilled or objects have fallen into the apparatus, the apparatus has been exposed to rain or moisture, does not operate normally, or has been dropped.

Getting started

Disc information

■ Discs that can be played

Disc type	Logo	Indication used in instructions
DVD-Audio		DVD-A
DVD-Video		DVD-V
DVD-R		
Audio CD		CD (Including CD-R/RW and discs recorded with MP3)
Video CD		VCD

■ Discs that cannot be played

PAL discs (the audio on DVD-Audio can be played), DVD-ROM, DVD-RAM, CD-ROM, CDV, CD-G, +RW, DVD-RW, CVD, SVCD, SACD, Divx Video Discs and Photo CD.

■ Region Management Information (DVD-Video only)

This unit responds to the Region Management Information recorded on DVD-Video. This unit's region number is "1". You cannot play the disc if the region number on the DVD-Video does not correspond to the region number on the unit.

You can play discs with labels containing the region number "1" and "ALL". Read the disc's instructions carefully.

e.g.



■ Playing DVDs and Video CDs

The producer of these discs can control how they are played so you may not always be able to control play as described in these operating instructions. Read the disc's instructions carefully.

■ CD-R and CD-RW discs

This unit can play CD-DA (digital audio) and video CD format audio CD-R and CD-RW that have been finalized (a process that enables CD-R/CD-RW players to play audio CD-R and CD-RW) upon completion of recording.

It may not be able to play some CD-R or CD-RW due to the condition of the recording.

■ DVD-R discs

Panasonic DVD-R recorded and finalized on a Panasonic DVD video recorder are played as DVD-Video on this unit.

It may not be possible to play these discs in all cases due to the type of disc or condition of the recording.

Simple setup

STEP 1 Setup

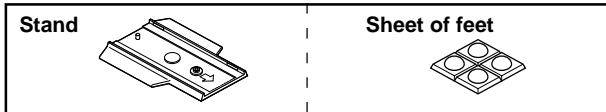

This unit can be setup standing or lying down.

Prepare the unit as follows according to the setup you choose.

Turn the unit off before changing the setup.

Standing

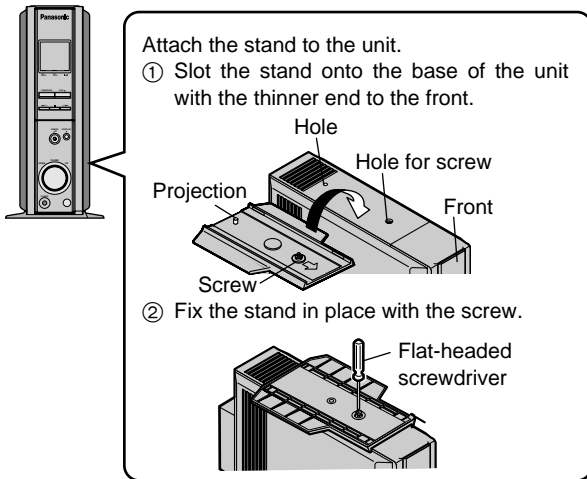

Lying down

Attach the feet to the base of the unit (left side when standing). Do not set up the unit upside down as this can cause malfunction.

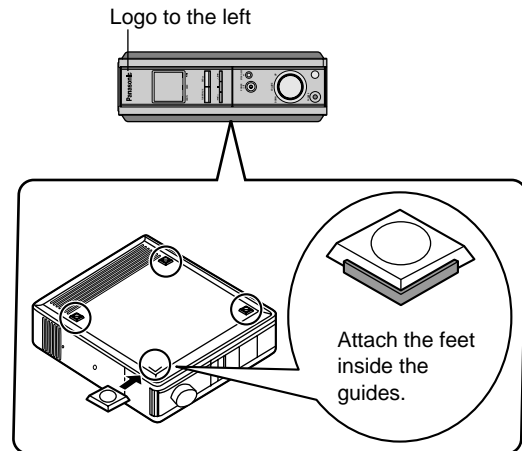

The display changes automatically to suit the setup you choose.

After setup, turn the unit on and check that the display is correct. If you set the unit up incorrectly, "SETTING ERROR/CHANGE SETTING" flashes on the unit's display.

STEP 2 Locating

Use only supplied speakers

Using other speakers can damage the unit and sound quality will be negatively affected.

- Set the speakers up on an even surface to prevent them from falling. Take proper precautions to prevent the speakers from falling if you cannot set them up on an even surface.
- Place the front, center, and surround speakers at approximately the same distance from the seating position. The angles in the diagram are approximate.
- Use the speakers with the short cords (SB-FDM3) for the front and center, and the ones with the long cords (SB-RDM3) for the surround speakers.

Center speaker (5) SB-FDM3

- You can also put this speaker directly under the television.
- Do not place the center speaker on the main unit as sound quality will be affected.
- Vibration caused by the center speaker can disrupt the picture if it is placed directly on the television. Put the center speaker on a rack or shelf.

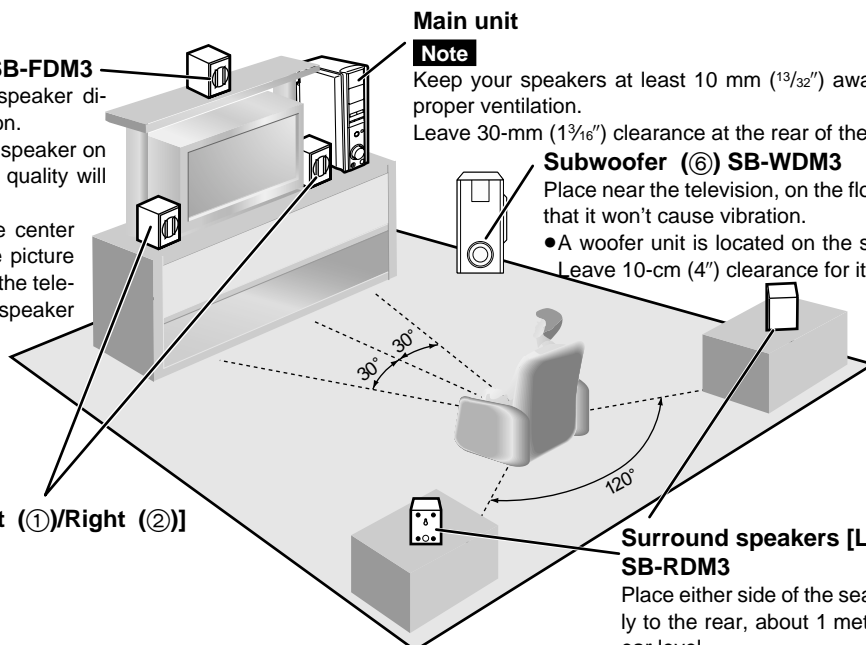

Front speakers [Left (1)/Right (2)] SB-FDM3

Subwoofer (6) SB-WDM3

- Place near the television, on the floor or a sturdy shelf so that it won't cause vibration.
- A woofer unit is located on the side of the subwoofer. Leave 10-cm (4") clearance for it to be effective.

Surround speakers [Left (3)/Right (4)] SB-RDM3

Place either side of the seating position, or slightly to the rear, about 1 meter (3 feet) higher than ear level.

Positioning for best effect

How you set up your speakers can affect the bass and the sound field. Note the following points.

- Place speakers on flat secure bases.
- Placing speakers too close to floors, walls, and corners can result in excessive bass. Cover walls and windows with thick curtain.

STEP 3 Speakers

Sheet of speaker-cord stickers



1 Attaching the stickers to the speaker cords

Attach the speaker-cord stickers to make connection easier.

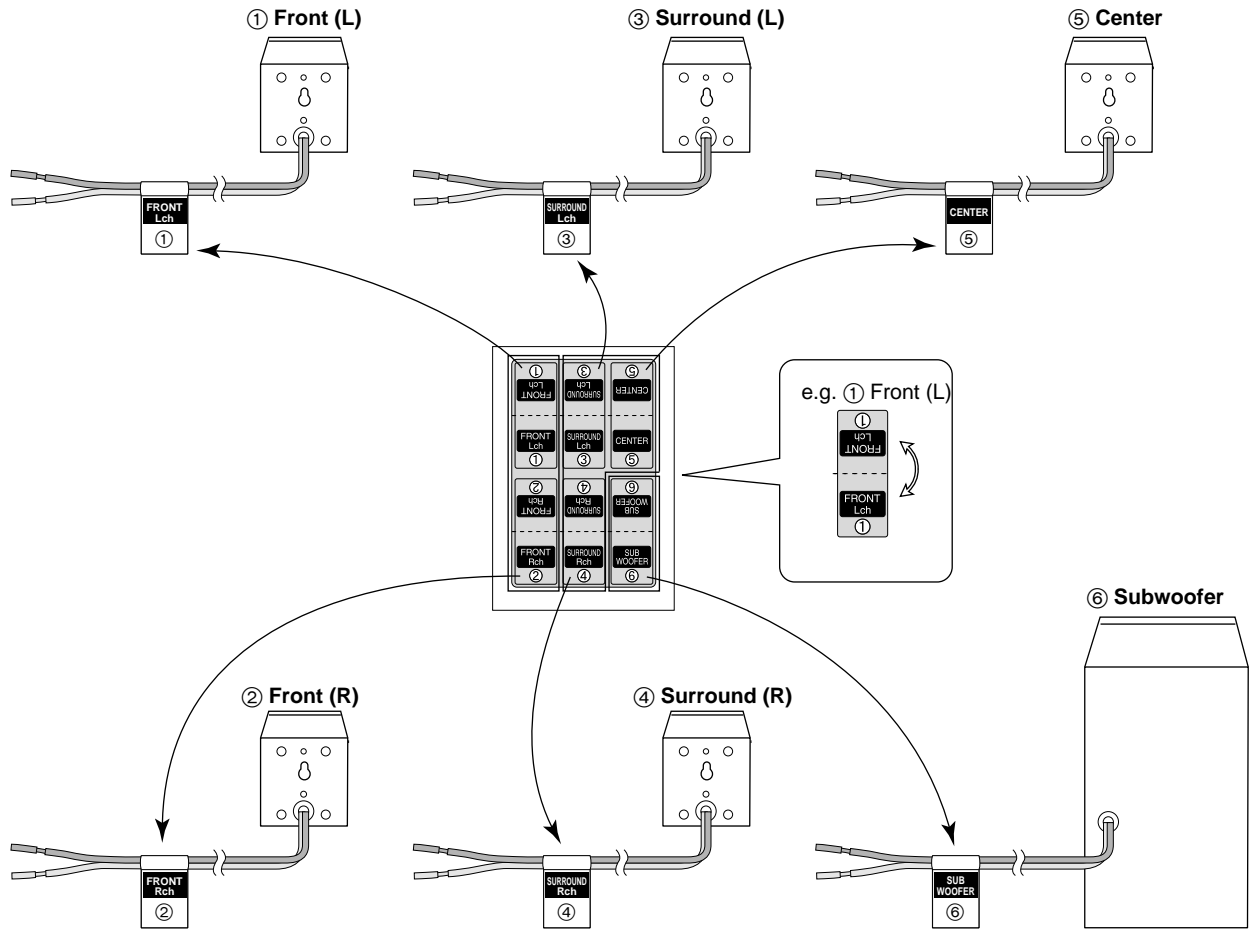

Attaching to a wall

Front and surround speakers can be attached to a wall. Set the speaker onto screw and slide through bracket to lock into position.

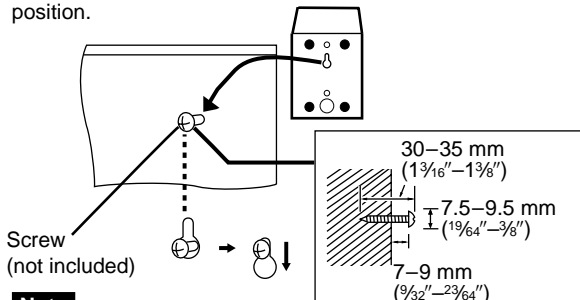

Note

The wall or pillar on which the speakers are to be attached should be capable of supporting 5 kg (11 lb.) per screw.

If irregular coloring occurs on your television

These speakers are designed to be used close to a television, but the picture may be affected with some televisions and setup combinations.

If this occurs, turn the television off for about 30 minutes.

The television's demagnetizing function should correct the problem. If it persists, move the speakers further away from the television.

Notes on speaker use

- You can damage your speakers and shorten their useful life if you play sound at high levels over extended periods.
- Reduce the volume in the following cases to avoid damage.
 - When playing distorted sound.
 - When the speakers are receiving howling from a microphone or record player, noise from FM broadcasts, or continuous signals from an oscillator, test disc, or electronic instrument.
 - When adjusting the sound quality.
 - When turning the unit on or off.



Caution

- Use the speakers only with the recommended system. Failure to do so may lead to damage to the amplifier and/or the speakers, and may result in the risk of fire. Consult a qualified service person if damage has occurred or if you experience a sudden change in performance.
- Do not attempt to attach these speakers to walls using methods other than those described in this manual.

2 Connecting: Connect in numeric order, top to bottom.

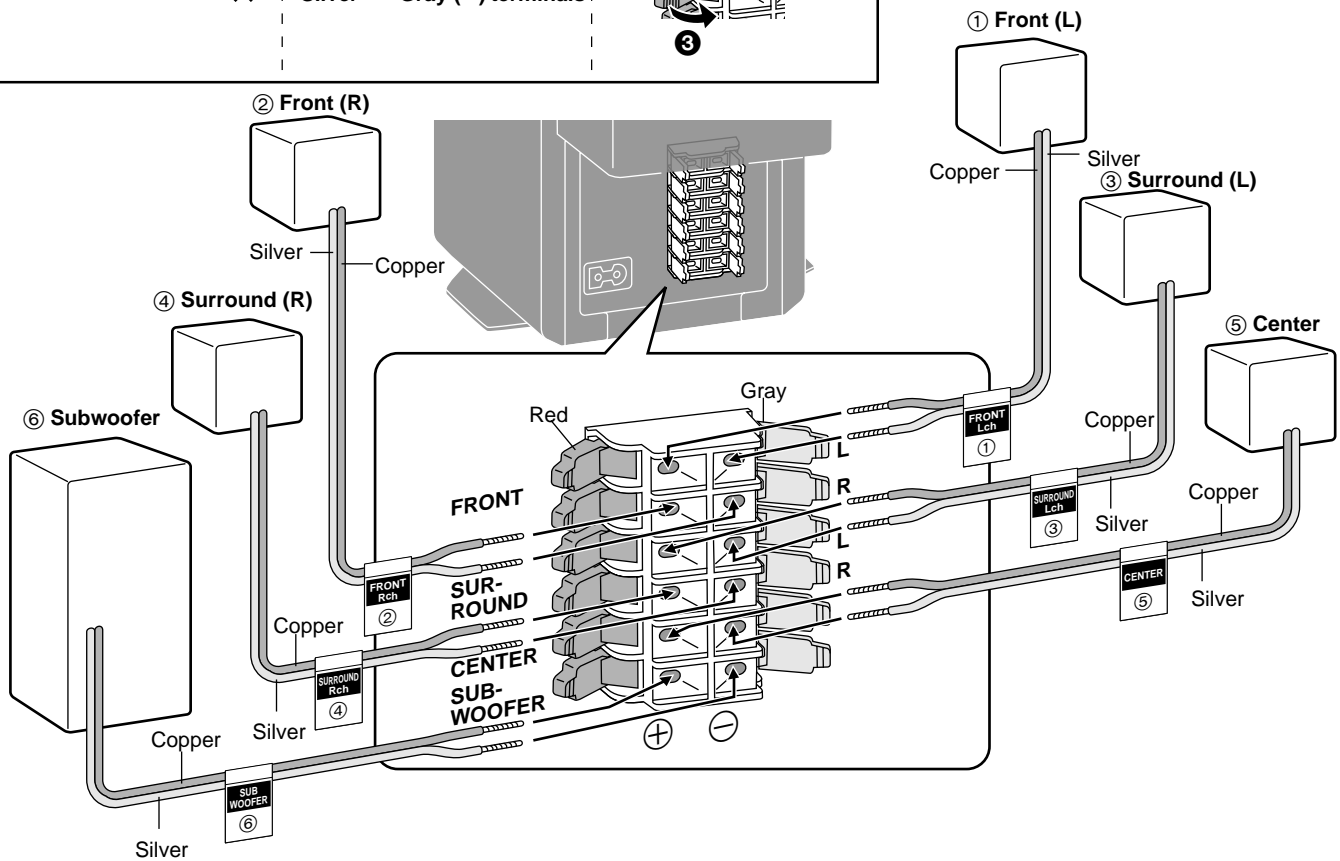
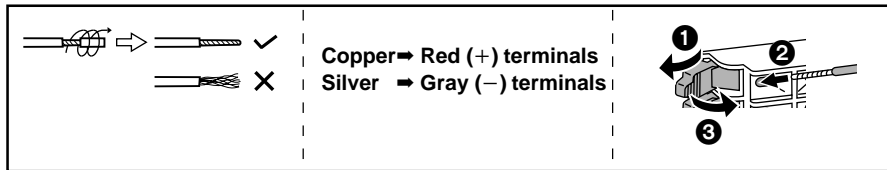

Note

- Never short-circuit positive (+) and negative (-) speaker wires.
- Be sure to connect only positive (copper) wires to positive (+) terminals and negative (silver) wires to negative (-) terminals. Incorrect connection can damage the speakers.

- After you have completed setup and connection, wind the excess cord and keep together with string.

STEP 4 Television

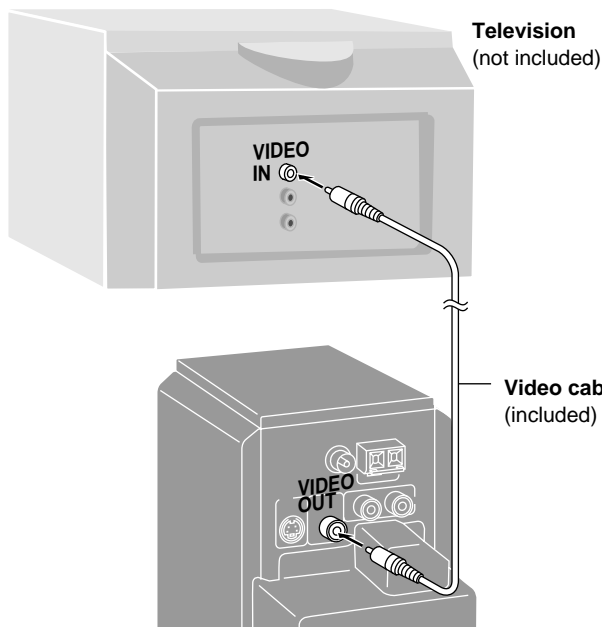

Video cable



- You can connect through the S-VIDEO OUT terminal if your television has an S-VIDEO terminal (→ page 29).
- **Connect directly to your television.** Do not connect the unit through a video cassette recorder, because the picture may not be played correctly due to the copy guard.

STEP 5

Antennas and AC power supply cord

AM loop antenna

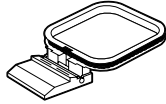

FM indoor antenna



AC power supply cord

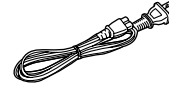

Simple setup

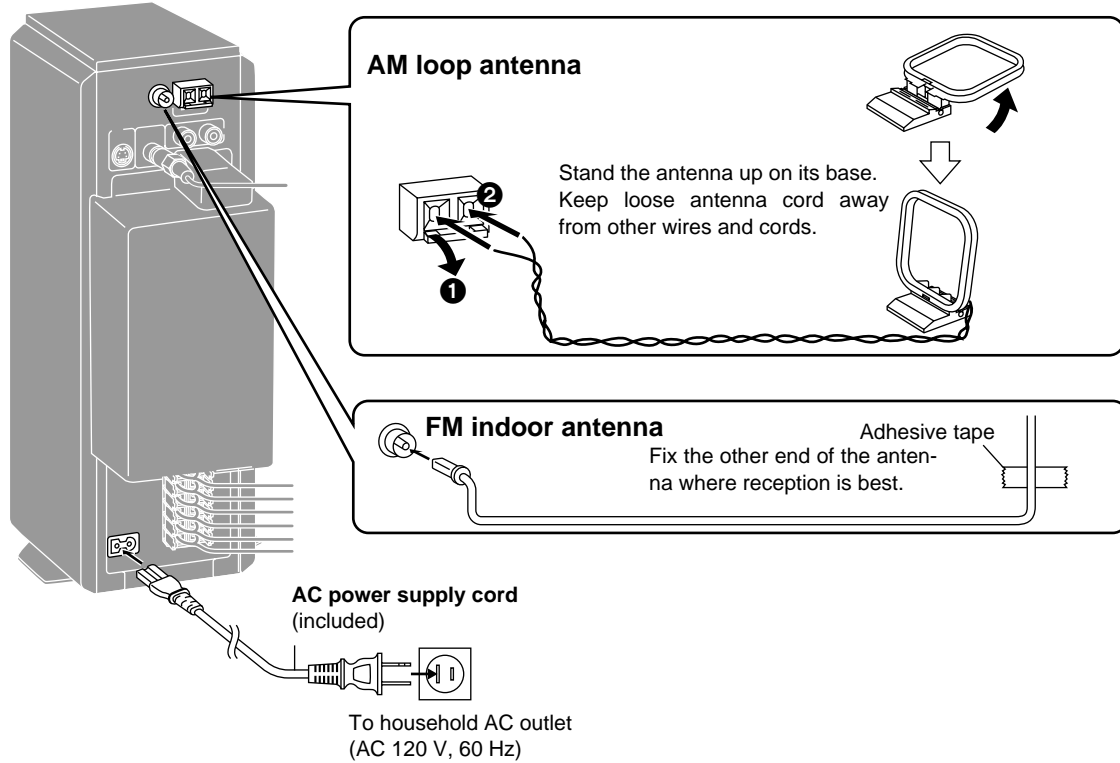

Conserving power

The unit consumes power (approx. 0.5 W) even when it is turned off with [⏻]. To save power when the unit is not to be used for a long time, unplug it from the household AC outlet. Remember to reset the radio stations and any other memory items before using the unit again.

For your reference

Information you enter into the unit's memory remains intact for up to a week after the AC power supply cord is disconnected.

Auto Power Off

The unit switches itself off after 30 minutes in the stop mode when the source is DVD/CD.

STEP 6 The remote control

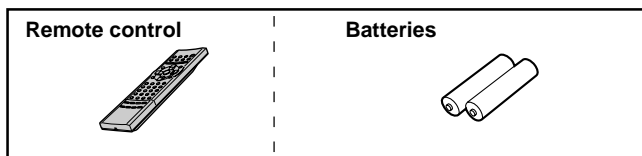

■ Batteries

Do not;

- mix old and new batteries.
 - use different types at the same time.
 - heat or expose to flame.
 - take apart or short circuit.
 - attempt to recharge alkaline or manganese batteries.
 - use batteries if the covering has been peeled off.
- Mishandling of batteries can cause electrolyte leakage which can damage items the fluid contacts and may cause a fire.

Remove if the remote control is not going to be used for a long period of time. Store in a cool, dark place.

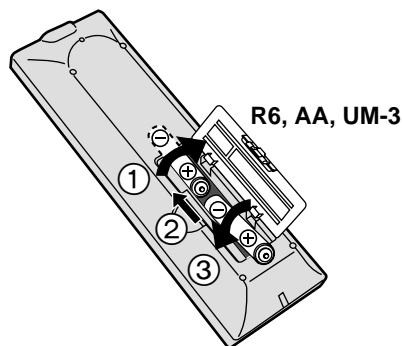

- Insert so the poles (+ and -) match those in the remote control.
- Do not use rechargeable type batteries.

■ Use

Aim at the sensor, avoiding obstacles, at a maximum range of 7 m (23 feet) directly in front of the unit.

STEP 7 Selecting TV screen type

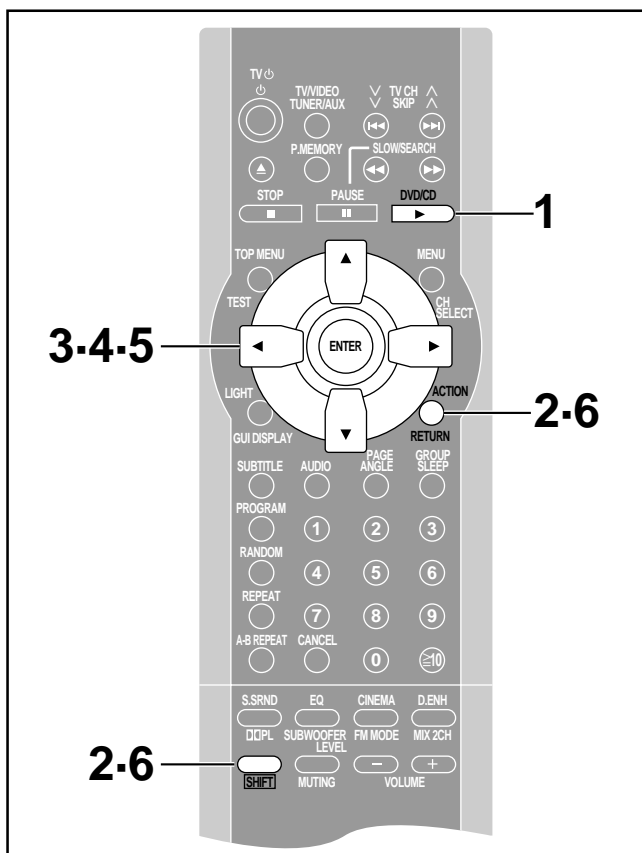

Remote control only

Change the setting to suit your television.

The menu language is set to English, but you can change it to French or Spanish (→ page 26, Display—Menu Language). English is used in the examples.

Preparation

Turn on the television and select the appropriate video input on the television to suit the connections for the unit.

- 1 Press [▶ DVD/CD] to turn on the unit. The unit comes on automatically and “DVD/CD” is selected as the source.

- 2 Press [SHIFT] + [ACTION] to show the menus.

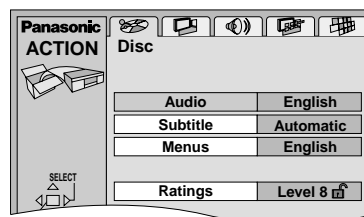

- 3 Press [◀, ▶] to select the “Video” tab.
- 4 Press [▲, ▼] to select “TV Aspect” and press [ENTER].
- 5 Press [▲, ▼] to select the item and press [ENTER].

- 4:3 Pan&Scan (Factory preset)
Select if you have a regular television and to view 16:9 software in the pan and scan style.



16:9 software prohibited from being shown in the pan and scan style will appear in the letterbox style despite the setting here.

- 4:3 Letterbox
Select if you have a regular television and to view 16:9 software in the letterbox style.



- 16:9
Select if you have a widescreen (16:9) television. Use the television’s screen modes to change the way the picture is shown.

- 6 Press [SHIFT] + [ACTION] to end the settings.

To return to the previous screen
Press [RETURN].

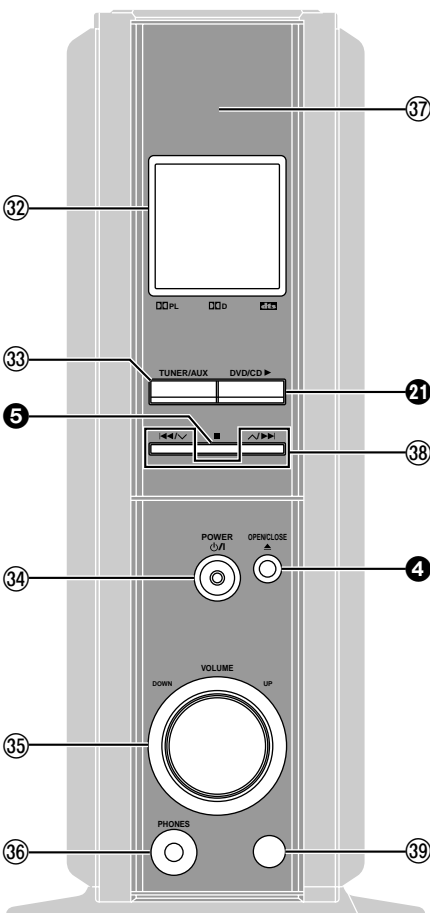
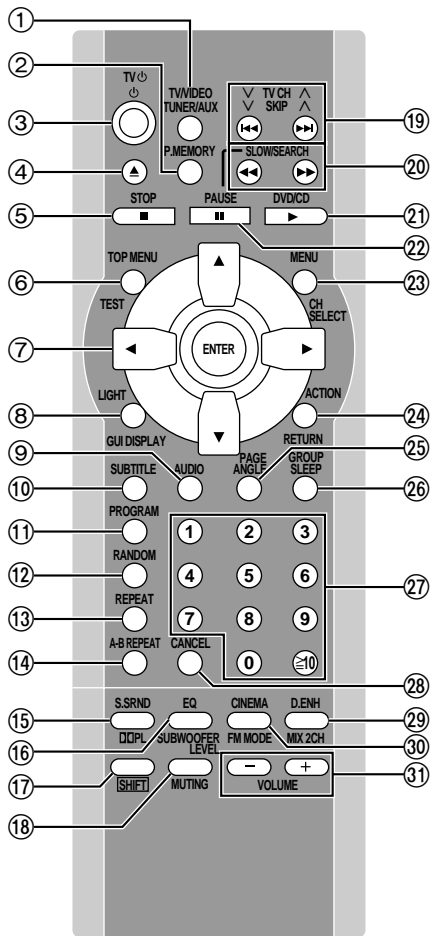

Remote control

- ① Tuner/Aux + TV/Video button
[TUNER/AUX, TV/VIDEO] 20, 25
Pressing [TUNER/AUX] also turns the unit on.
 - ② Position memory button [P.MEMORY] 12
 - ③ Power + TV power button [⏻, TV ⏻] 11, 25
 - ④ Open/close button [▲] 11
 - ⑤ Stop button [■ STOP] 11
 - ⑥ Top menu + Test button [TOP MENU, TEST] 12, 23
 - ⑦ Cursor buttons [▲, ▼, ◀, ▶]/Enter button [ENTER] 9
 - ⑧ GUI display + Light button
[GUI DISPLAY, LIGHT] 18, 25
 - ⑨ Audio button [AUDIO] 14
 - ⑩ Subtitle button [SUBTITLE] 14
 - ⑪ Program button [PROGRAM] 16, 21
 - ⑫ Random button [RANDOM] 17
 - ⑬ Repeat button [REPEAT] 15
 - ⑭ A-B repeat button [A-B REPEAT] 15
 - ⑮ Super surround + Pro Logic button
[S.SRND, DDPL] 23, 24
 - ⑯ Equalizer + Subwoofer level button
[EQ, SUBWOOFER LEVEL] 24
 - ⑰ Shift button [SHIFT]
- To use functions labeled in orange:
While pressing [SHIFT], press the corresponding button.
- ⑱ Muting button [MUTING] 25
 - ⑲ Skip, preset channel + TV channel buttons
[|◀▶|, v SKIP ▲, v TV CH ▲] 13, 21, 25
 - ⑳ Slow/search, tuning buttons
[◀◀, ▶▶ SLOW/SEARCH] 13, 20
 - ㉑ Disc play button [▶ DVD/CD] 9
Pressing [▶ DVD/CD] also turns the unit on.
 - ㉒ Pause button [|| PAUSE] 11
 - ㉓ Menu + Channel select button
[MENU, CH SELECT] 12, 23
 - ㉔ Return + ACTION menu button [RETURN, ACTION] .. 9, 27
 - ㉕ Angle + Page button [ANGLE, PAGE] 14, 17
 - ㉖ Sleep + Group button [SLEEP, GROUP] 17, 25
 - ㉗ Numbered buttons [1-9, 0, ≥10] 12
 - ㉘ Cancel button [CANCEL] 16
 - ㉙ Dialogue enhancer + Mix 2ch button
[D.ENH, MIX 2CH] 13, 23
 - ㉚ Cinema + FM mode button [CINEMA, FM MODE] ... 13, 20
 - ㉛ Volume buttons [-, +, VOLUME] 11, 20

Main unit

Buttons ④, ⑤ and ㉑ function the same as the controls on the remote control.

- ㉜ Display
- ㉝ Tuner/Aux button [TUNER/AUX] 20
- ㉞ Standby/on switch [POWER ⏻/⏻]
- Press to switch the unit from on to standby mode or vice versa. In standby mode, the unit is still consuming a small amount of power.
- Standby/on indicator**
When the unit is connected to the AC mains supply, this indicator lights red in standby mode and lights green when the unit is turned on.
- ㉟ Volume control [VOLUME, DOWN, UP] 11, 20
- ㊱ Headphone jack [PHONES] 25
- ㊲ Disc compartment 11
- ㊳ Skip, preset channel buttons [|◀◀/v, ▲/▶▶|] 13, 21
- ㊴ Remote control signal sensor

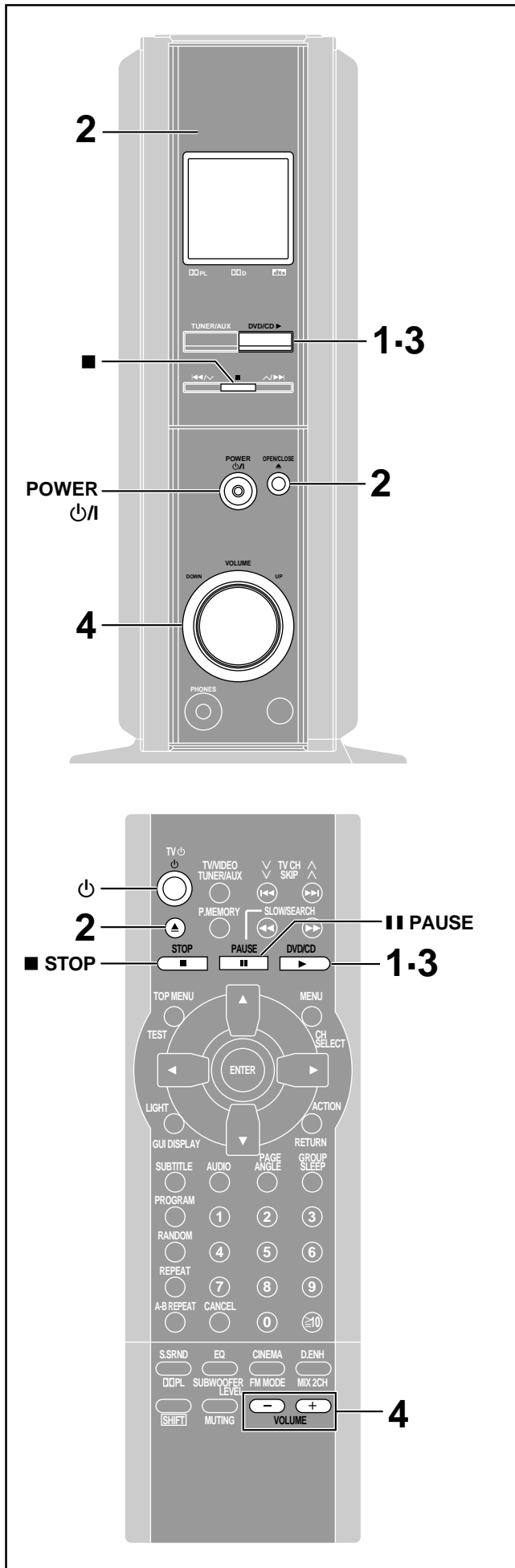

DVD-A DVD-V CD VCD

Preparation

- Turn on the television and select the appropriate video input on the television to suit the connections for the unit.
- Press [POWER \odot /I] to turn on the unit.

- 1 Press [DVD/CD \blacktriangleright] to select “DVD/CD” as the source.**
- 2 Press [\blacktriangle OPEN/CLOSE] to open the disc tray and place the disc.**

Standing [12 cm (5") disc]

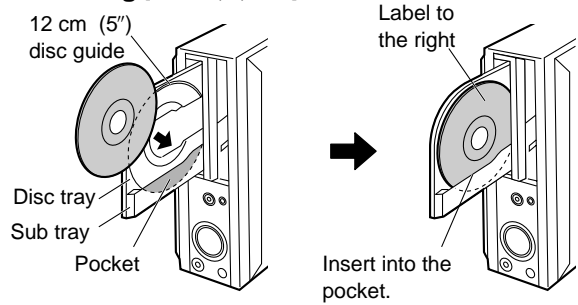

Standing [8 cm (3") disc]

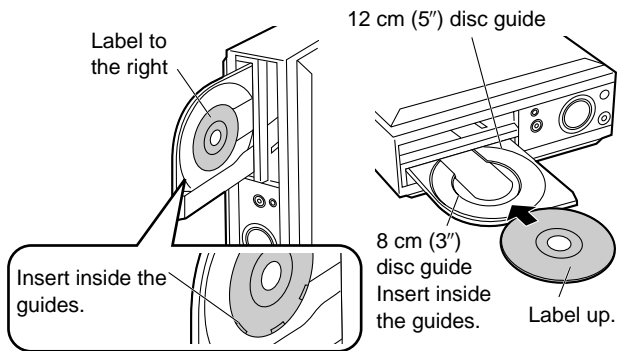

Press [\blacktriangle OPEN/CLOSE] again to close and start play.

- 3 If play doesn't start after step 2 Press [DVD/CD \blacktriangleright].**

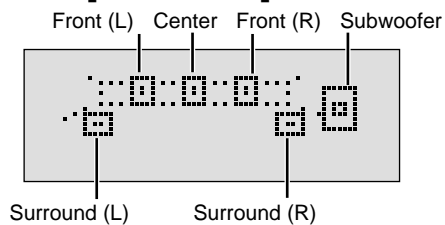

- 4 Adjust the volume.**

■ When “D.MIX” is flashing (\Rightarrow page 23)

■ One touch play

When a disc is loaded and the unit is off, press [DVD/CD \blacktriangleright]. The unit comes on and starts play.

■ To stop play

Press [■] (\Rightarrow page 12, Resume function).

■ To pause play

Press [||] during play.

Press [DVD/CD \blacktriangleright] to restart play.

■ Auto standby

The unit switches to standby mode after about 30 minutes in the stop mode. Note that it may be switched to standby earlier by the sleep timer (\Rightarrow page 25).

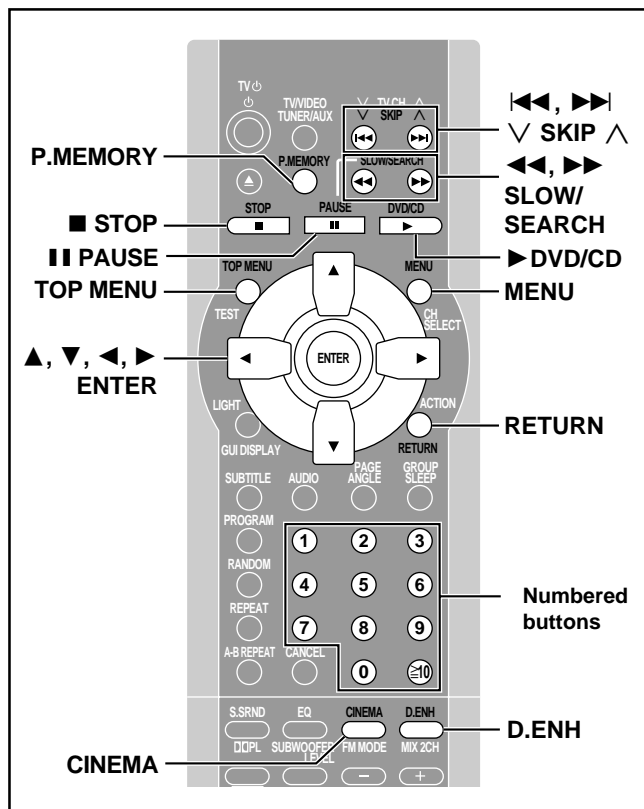

Note

- If “⊙” appears on the television
The operation is prohibited by the unit or disc.
- The disc continues to rotate while the menu is displayed even after you finish playing an item. Press [■] when you finish to preserve the unit’s motor and your television screen.
- Volume may be lower when playing DVDs than when playing other discs or during television broadcasts. If you turn the volume up, be sure to reduce the volume again before playing other sources so that a sudden increase in output does not occur.

When a menu appears on the television

DVD-A DVD-V VCD

Remote control only

Press the numbered buttons to select an item.

To select a 2-digit number

Example: To select item 23, press [≧10] → [2] → [3].

- When playing DVDs, you can also use [▲, ▼, ◀, ▶] to select items. Press [ENTER] to confirm your selection.

Play of the selected item now begins.

Other buttons used to operate menu

Read the disc’s instructions for further details about operation.

[▶▶]: Shows the next menu.

[◀◀]: Shows the previous menu.

[RETURN]: Shows the menu screen. **VCD**

[TOP MENU]: Shows the first menu screen. **DVD-A DVD-V**

[MENU]: Shows the menu screen. **DVD-V**

Playing MP3

CD

Discs recorded using MP3 differ to CDs in the following ways.

- Structure of the disc (example)

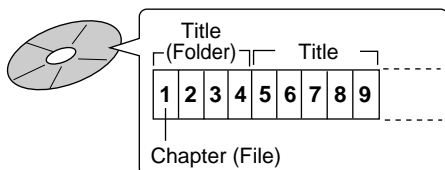

Starting play from a selected chapter

Press the numbered buttons and press [ENTER].

Example: Chapter 23: [2] → [3] → [ENTER]

(Pressing [≧10] is unnecessary.)

Repeat play

You can use chapter repeat or title repeat (→ page 15).

Program play, random play

You cannot use program play or random play.

The information displayed in the On-Screen Menu Icons

Total number of chapters



Chapter playing Elapsed playing time (cannot be changed)

Note

- If you play an MP3 track that includes still picture data, it will take some time before the music itself starts playing and the elapsed time will not be displayed during this time. Even after the track starts, the correct play time will not be displayed.
- This unit is not compatible with ID3 tags.
- This unit is not compatible with files with a sampling rate of 32 kHz.

Refer to the glossary on page 32 for more information about MP3.

Resume function

DVD-A DVD-V CD VCD

(When the elapsed play time is displayed)

“RESUME” lights on the display when the unit has recorded the position at which you stopped play.

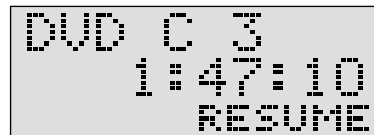

Press [▶ DVD/CD] to start play from that position.

(When playing DVD-Video → Chapter Preview below)

- The position is cleared when you:
 - Turn the unit off.
 - Open the disc tray or select another source.
- Press [■] to clear the position.

Position Memory function

DVD-V CD VCD

(When the elapsed play time is displayed)

Remote control only

During play

Press [P.MEMORY] to memorize a position.

Position memorized

This position is saved even if you turn the unit off or change the source. When you turn the unit on or reselect “DVD/CD”, “RESUME” lights on the display. Press [▶ DVD/CD] to start play from the memorized position. The position is cleared.

(When playing DVD-Video → Chapter Preview below)

- The position is cleared when you open the disc tray.

Chapter Preview

DVD-V

The following message appears

immediately after you press [▶ DVD/CD].

Press PLAY to Preview Chapters

Press [▶ DVD/CD] while the message is displayed and the beginning portions of each chapter up to the current one are played.

Full play resumes from the point where you pressed [■] or [P.MEMORY].

(This feature works only within a title.)

If you do not press [▶ DVD/CD], the message disappears and play starts from where you pressed [■] or [P.MEMORY].

Skipping chapters or tracks

DVD-A DVD-V CD VCD

During play or while paused

Press [**⏮**] or [**⏭**].

- Each press increases the number of skips.

Fast forward and rewind—SEARCH

DVD-A DVD-V CD VCD

During play

Press [**⏮**] or [**⏭**].

- Press and hold [**⏮/v**] or [**⏭/▶**] on the main unit.
- Audio will be heard during search for most discs. You can turn this audio off if you want to (➔ page 26, Audio—Audio during Search).

Slow-motion play

DVD-A DVD-V VCD

While paused

Press [**⏮**] or [**⏭**].

Press and hold [**⏮/v**] or [**⏭/▶**] on the main unit.

Frame-by-frame viewing

DVD-A DVD-V VCD

Remote control only

While paused

Press [**◀**] or [**▶**].

The frame changes each time you press the button.

- The frames change in succession if you press and hold the button.
- Pressing [**⏭**] also activates forward frame-by-frame.

Notes

- The speed of search and slow-motion increases up to 5 steps.
- Press [**▶** DVD/CD] to restart play.
- You cannot move backwards with Video CD during frame-by-frame and slow-motion.
- Frame-by-frame and slow-motion only work on the moving picture parts of DVD-Audio.

When playing Video CDs with playback control

Pressing buttons to perform skip, search or slow-motion may take you to a menu screen.

Starting play from a selected track or title

DVD-A DVD-V CD VCD

Remote control only

Press the numbered buttons to select the item.

To select a 2-digit number

Example: To select track 23, press [**≥10**] ➔ [**2**] ➔ [**3**].

Play starts from the selected item.

Note

This works only when stopped with some discs.

Cinema

DVD-A DVD-V VCD

Remote control only

You can change the picture quality for movie viewing.

Press [**CINEMA**].

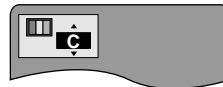

Each time you press the button:

C: Mellows images and enhances detail in dark scenes.



N: Normal mode (Factory preset)

For your reference

You can make finer adjustments to the picture if desired (➔ page 19, Unit information—Video menu—Digital picture mode—User mode).

Dialogue Enhancer

DVD-V

(Dolby Digital/DTS, 3-channel or over, where the dialogue is recorded in the center channel)

Remote control only

This mode makes the dialogue in movies easier to hear.

Press [**D.ENH**].

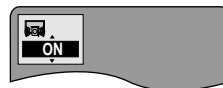

Each time you press the button:

ON ↔ **OFF** (Factory preset)

Note

Dialogue Enhancer will not work or will have less effect with some discs, even if you select "ON".

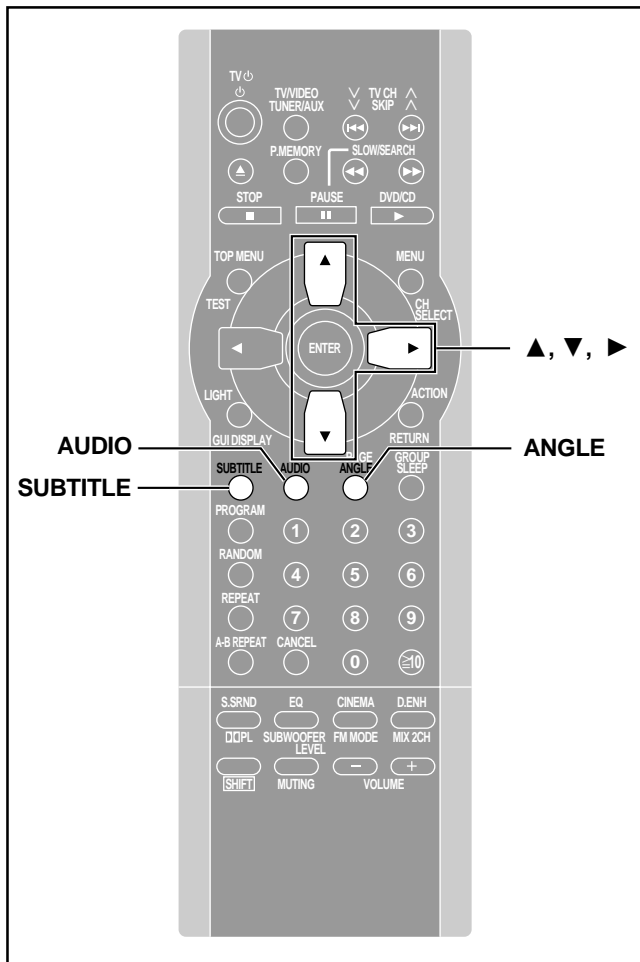

DVD-A DVD-V

Remote control only

Some DVDs have multiple soundtracks, subtitle languages and camera angles, and you can change these during play.

- “—” or “--” is displayed instead of the language number in circumstances such as when no language is recorded on the disc.

Soundtracks

During play

Press [AUDIO].

The number changes each time you press the button.



Soundtrack selected

Soundtrack playing

- Play restarts from the beginning of the soundtrack when changing DVD-Audio soundtracks that are accompanied by still pictures.
- Even if a second soundtrack isn't recorded on a DVD-Audio, two soundtrack numbers will normally be shown when you press [AUDIO]. The soundtrack currently playing is number 1.
- You can also use this button to turn the vocals on and off on karaoke discs. Read the disc's instructions for details.
- Refer to **A** and **B** on page 19 for language abbreviations and audio signal type details.

VCD

Audio changes as follows each time you press [AUDIO]:

LR → L → R

Subtitles

During play

Press [SUBTITLE].

The number changes each time you press the button.

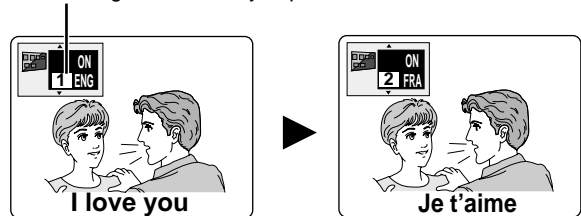

- In some cases, the subtitle language is not changed to the selected one immediately.
- If the subtitles overlap closed captions recorded on discs, turn the subtitles off.
- Refer to **A** on page 19 for language abbreviations.

To clear/display the subtitles

1. Press [SUBTITLE].
2. Press [▶].
3. Press [▲, ▼] to select “OFF” or “ON”.

Angles

During play

Press [ANGLE].

The number changes each time you press the button.

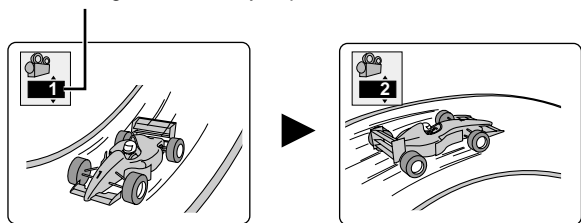

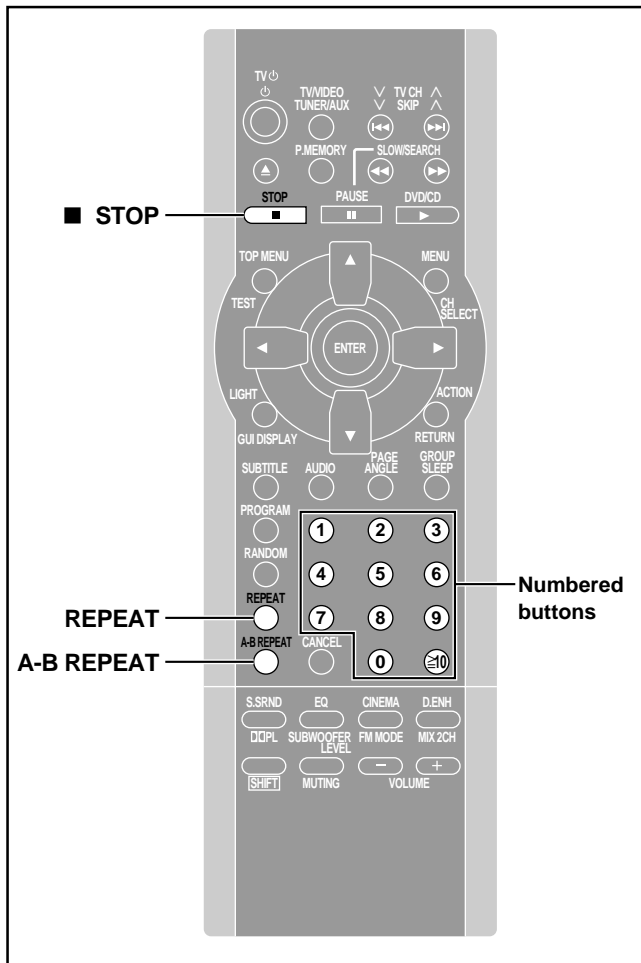

(When the elapsed play time is displayed)

Remote control only

A-B repeat play

DVD-A DVD-V CD VCD

You can repeat a section between points A and B within a title or track.

- During play
Press **[A-B REPEAT]** at the starting point (A).

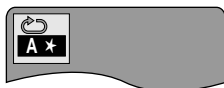

- Press **[A-B REPEAT]** at the finishing point (B).



A-B repeat starts.

To cancel

Press **[A-B REPEAT]** until “” is displayed.

Note

- Some subtitles recorded around point A or B may fail to appear.
- The unit automatically determines the end of a title/track as point B when the end of the title/track is reached.

Repeat play

DVD-A DVD-V CD VCD

During play

Press **[REPEAT]**.

Each time you press the button:

DVD-A

•Normal play



•All group play



•Program play

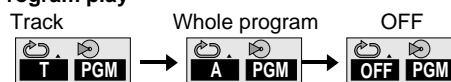

•Random play

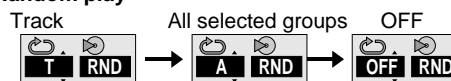

DVD-V

CD (MP3 disc)

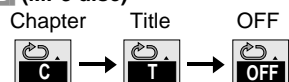

CD VCD (There is no on-screen display.)



If the Video CD has playback control

- Press **[■]**.
- Press the numbered buttons to select a track to start play (⇒ page 13).
- Press **[REPEAT]** (⇒ above).

Note

You cannot use repeat play to repeat an entire DVD-Video or an entire MP3 disc.

To repeat only your favorite tracks

DVD-A CD VCD

Start program play (⇒ page 16) and press **[REPEAT]** to select the repeat mode.

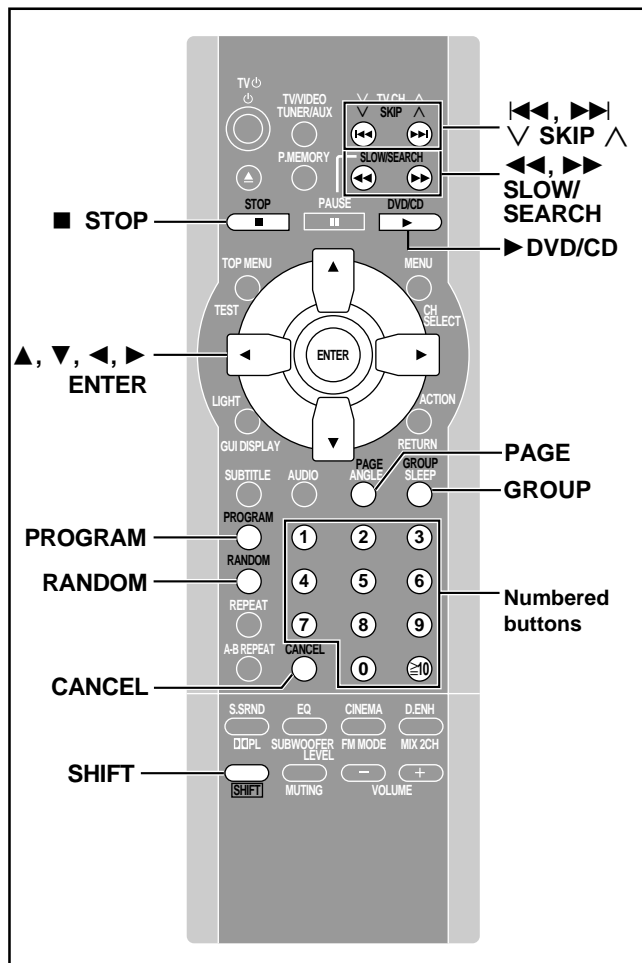
**Remote control only****DVD-A**

If you select bonus groups, you will have to enter a 4-digit password (→ page 17).

All group play**DVD-A**

To play all the groups on a disc

- 1 While stopped
Press **[PROGRAM]** until the all group play screen appears.



- 2 Press **[▶ DVD/CD]**.

Program play**DVD-A**

CD **VCD** (There is no on-screen display.)

To play a maximum of 24 tracks in a programmed order

- 1 While stopped
Press **[PROGRAM]** until the following display appears.

e.g. **DVD-A**

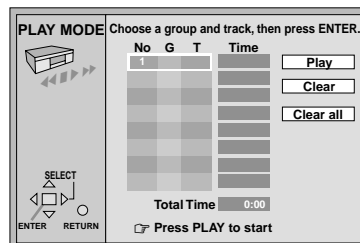

- 2 **DVD-A**
Press the numbered buttons to select a group.

- 3 Press the numbered buttons to select a track.

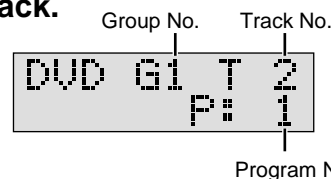

- Repeat steps 2 and 3 to program other tracks.
- **DVD-A** To select a track using the cursor buttons
Press **[ENTER]** and **[▲, ▼]** to select a group or track, then press **[ENTER]** again to register the number.
All the tracks in the selected group are selected when you select "ALL".

- 4 Press **[▶ DVD/CD]**.

Play now begins in the programmed sequence.

DVD-A (Follow the on-screen instructions.)

To add or change groups or tracks

Press **[▲, ▼]** to select an available item, then repeat steps 2 and 3.

To move to the page before or after the one shown

Press **[◀, ▶]**.

To clear a track

1. Select the item you want to clear with **[▲, ▼]**.
2. Press **[CANCEL]**, or select "Clear" with **[▲, ▼, ◀, ▶]** and press **[ENTER]**.

To clear the whole program

Select "Clear all" with **[▲, ▼, ◀, ▶]** and press **[ENTER]**.

CD **VCD** (On the unit's display)

To add tracks

Repeat step 3.

To clear the last track

Press **[CANCEL]**.

To clear the whole program

Press **[■]**.

To check the contents of the program

After stopping play, press **[◀, ▶]**. The track numbers and program positions are displayed in order.

To exit the program mode

Press **[PROGRAM]** while stopped.

Note

When playing DVD-Audio, the program is cleared when you switch the unit to standby, open the disc tray, select another source, or exit the program mode.

Random play

DVD-A CD VCD

Remote control only

DVD-A

- 1 While stopped
Press [RANDOM].
e.g. three groups



- 2 Press [◀, ▶] to select a group and press [ENTER].
 - You can select more than one group.
 - To clear a group, select it again and press [ENTER].
- 3 Press [▶ DVD/CD].
Play now begins in random order.

CD VCD (There is no on-screen display.)

While stopped

Press [RANDOM].

Play now begins in random order.



To cancel

Press [■] until "RND" goes out.

Selecting groups to play

DVD-A

Remote control only

The tracks on DVD-Audio are divided into groups. How these groups are played differs with the disc so read the instructions that came with the disc for further details.

- 1 Press [SHIFT] + [GROUP].

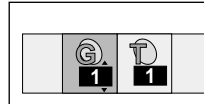

- 2 Press the numbered buttons to select the group and press [ENTER].
- 3 Press the numbered buttons to select the track number and press [ENTER].
The selected group and track begin to play.

Playing all the groups in succession (⇒ page 16, All group play)

Playing bonus groups

Some discs contain bonus groups. To enjoy these groups you may have to enter a password. Refer to the disc's jacket.

1. Repeat steps 1 and 2 above to select the bonus group.
2. Enter the 4-digit password with the numbered buttons and press [ENTER].
 - If you enter the wrong password, you can erase a digit by pressing [CANCEL].
3. Press the numbered buttons to select a track and press [ENTER].

- The bonus group can be played as many times as you like after the password has been entered until you:
 - Turn the unit off.
 - Open the disc tray or select another source.

Selecting still pictures—Page Skip

DVD-A

Remote control only

During play

Press [SHIFT] + [PAGE].

The page changes each time you press the buttons.

PAGE 1

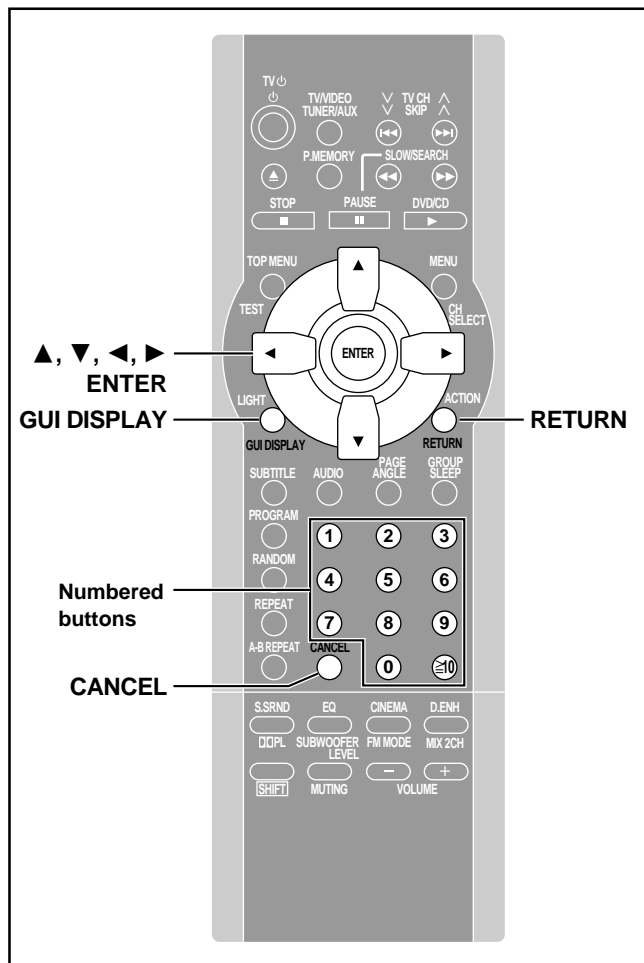

DVD-A DVD-V CD VCD

Remote control only

On-Screen Menu Icons are menus that contain information about the disc or unit. These menus allow you to perform operations by changing this information.

Common procedures

1 Press [GUI DISPLAY].

Each time you press the button:

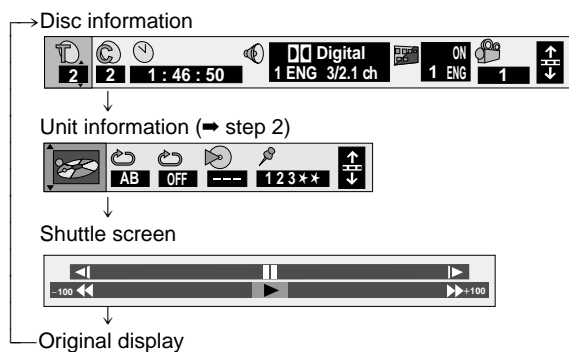

• The screens depend on disc contents.

2 Unit information only

While the leftmost icon is highlighted
Press [▲, ▼] to select the menu.

Each time you press the button:

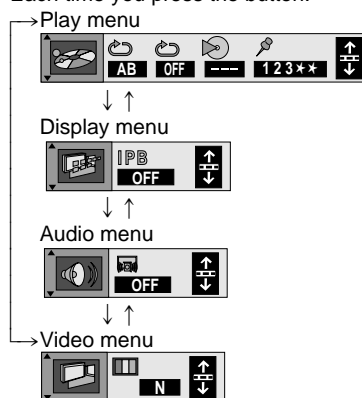

3 Press [◀, ▶] to select the item.

4 Press [▲, ▼] to select the setting.

- Items with "▲" or "▼" above and below can be changed by [▲, ▼].
- Press [ENTER] if the setting does not change after pressing [▲, ▼].
- Some items require different operations. Read the explanations on the following pages.

For your reference

- Depending on the condition of the unit (playing, stopped, etc.) and the type of software you are playing, there are some items that you cannot select or change.
- When numbers are displayed (e.g. title No.), the numbered buttons are also effective for setting. After entering the numbers, press [ENTER] to register the setting.

To clear the menus

Press [RETURN] until the menu disappears.

■ To change the position of the menus

1. Press [◀, ▶] to select the rightmost icon.
 2. Press [▲, ▼] to move the menu.
- (There are 5 positions.)

Shuttle screen

There are five speeds for both backward and forward slow-motion and search.

The numbers on either side of the shuttle screen indicate the maximum speeds of the search.

Icon	Content
	Pause
	Slow-motion play ◀: Backward DVD-A DVD-V ▶: Forward DVD-A DVD-V VCD
	Play
	Search ◀◀: Backward ▶▶: Forward

Disc information

e.g. DVD-V



	DVD-A Group number
	DVD-A CD VCD Track number DVD-V Title number
	DVD-V Chapter number
	DVD-A DVD-V Time Select a position to start play by specifying a time with the numbered buttons. DVD-A CD VCD Changing the time display Press [▲, ▼] to show the elapsed play time, remaining time for the track, or remaining time for the disc/group.
	DVD-A DVD-V Soundtrack a) Soundtrack language (See A at right for language abbreviations.) b) Audio signal type (See B at right for details.)
	Karaoke vocal on/off (Karaoke DVD only) Solo: OFF or ON Duet: OFF, V1+V2, V1 or V2
	DVD-A DVD-V Subtitle language (See A at right for language abbreviations.)

	DVD-A DVD-V Subtitles on/off ON ↔ OFF
	DVD-A DVD-V Angle number
	DVD-A Still picture number Selected picture is shown during play.
	VCD Audio mode LR ↔ L ↔ R ↑ ↔ ↓
	VCD (with playback control only) Menu play Indicates whether menu play (playback control) is on or off.

A Audio/Subtitle language

ENG: English	SVE: Swedish	CHI: Chinese
FRA: French	NOR: Norwegian	KOR: Korean
DEU: German	DAN: Danish	MAL: Malay
ITA: Italian	POR: Portuguese	VIE: Vietnamese
ESP: Spanish	RUS: Russian	THA: Thai
NLD: Dutch	JPN: Japanese	*: Others

B Signal type/data

LPCM/PPCM/DD Digital/DTS: Signal type

k (kHz): Sampling frequency

b (bit): Number of bits ch (channel): Number of channels

Example:

3/2 .1ch

- .1: Subwoofer signal
(not displayed if there is no subwoofer signal)
- 0: No surround
- 1: Mono surround
- 2: Stereo surround (left/right)
- 1: Center
- 2: Front left+Front right
- 3: Front left+Front right+Center

Unit information

	Play menu
	A-B repeat (⇒ page 15) [ENTER] (start point) ⇒ [ENTER] (finish point) To cancel: [ENTER]
	Repeat play (⇒ page 15)
	DVD-A CD VCD Play mode display (⇒ pages 16 and 17) ---: Normal play PGM: Program play RND: Random play ALL: All group play (DVD-A)
	Marker You can mark up to 5 positions to play again. [ENTER] (The unit is now ready to accept markers.) To mark a position: [ENTER] (at the desired point) To mark another position: [◀, ▶] ⇒ [ENTER] To recall a marker: [◀, ▶] ⇒ [ENTER] To erase a marker: [◀, ▶] ⇒ [CANCEL]

Notes on marker

- Only when the elapsed play time is displayed.
- Some subtitles may fail to appear around the marker.
- All the markers are cleared when you:
 - Turn the unit off.
 - Open the disc tray or select another source.

	Display menu
	I/P/B display (⇒ page 32) ON ↔ OFF Displays the picture type (I/P/B) in the still picture mode.
	Audio menu
	DVD-V Dialogue Enhancer (⇒ page 13) ON ↔ OFF
	Video menu
	DVD-A DVD-V VCD Digital picture mode N: Normal mode C: Cinema mode (⇒ page 13) U: User mode The following items are also displayed when you select "U".
	Contrast (–7 to +7) Increases the contrast between white and black parts of the picture.
	Brightness (0 to +15) Brightens the picture.
	Color (–7 to +7) Adjusts the shade of the picture's color.

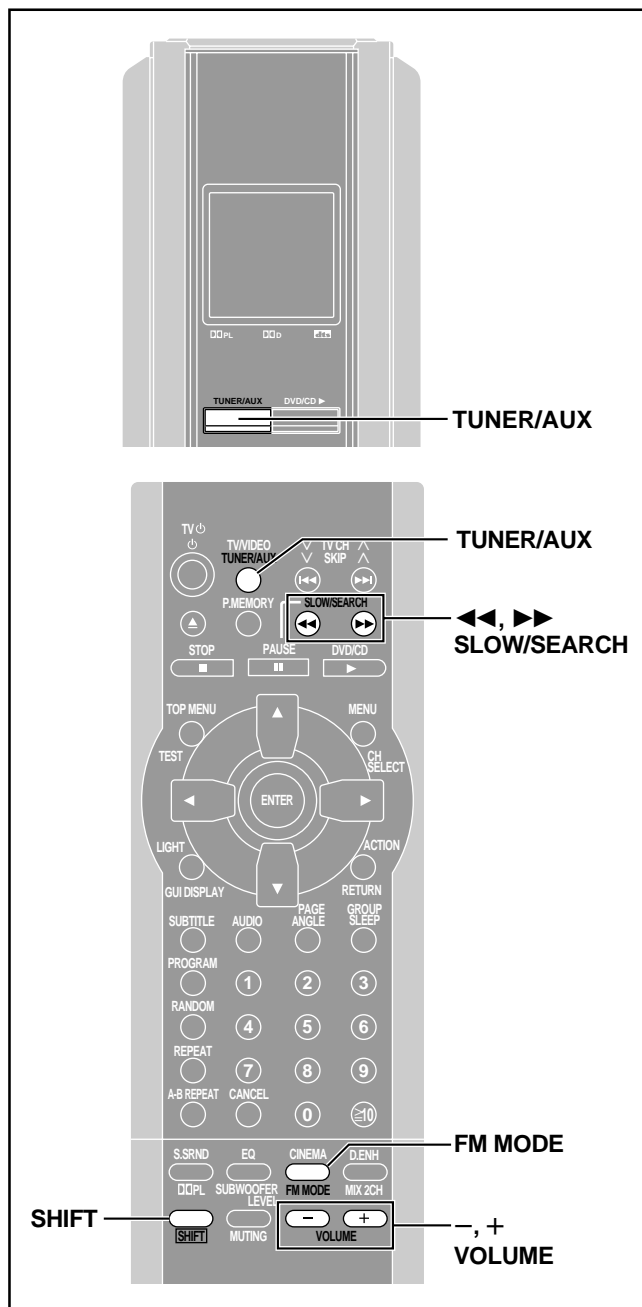

Remote control only

Radio stations can be tuned manually by selecting the station's frequency or they can be preset into channels to make it easy to tune (→ page 21).

1 Press [TUNER/AUX] to select "FM" or "AM".

Each time you press the button:

FM → AM → AUX

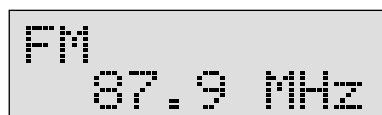

2 Press [◀◀] or [▶▶] to select the frequency of the required station.



Displayed when a radio station is tuned.

Displayed when a stereo FM broadcast is being received.

Press and hold [◀◀] or [▶▶] until the frequency starts scrolling to start automatic tuning. Tuning stops when a station is found.

3 Adjust the volume.

If noise is excessive in FM

Press [SHIFT] + [FM MODE] to display "MONO".

MONO

This mode improves sound quality if reception is weak but broadcasts are heard in monaural.

Press [SHIFT] + [FM MODE] again to cancel the mode.

The mode is also canceled when you changed the frequency.

Turn "MONO" off for normal listening.

Stereo and monaural broadcasts are automatically played as they are received.

FM frequency step

Main unit only

The step is factory-set to 0.2 MHz, but you can change it to receive broadcasts allocated 0.1-MHz steps.

- ① Press [TUNER/AUX] to select "FM".
- ② Press and hold [TUNER/AUX].
After a few seconds the display changes to show the current minimum frequency. Continue to hold the button down. The minimum frequency changes and the step is changed.

To return to the original step, repeat the above steps.

Note

Any FM frequencies preset in channels will be changed by this procedure. Preset them again.

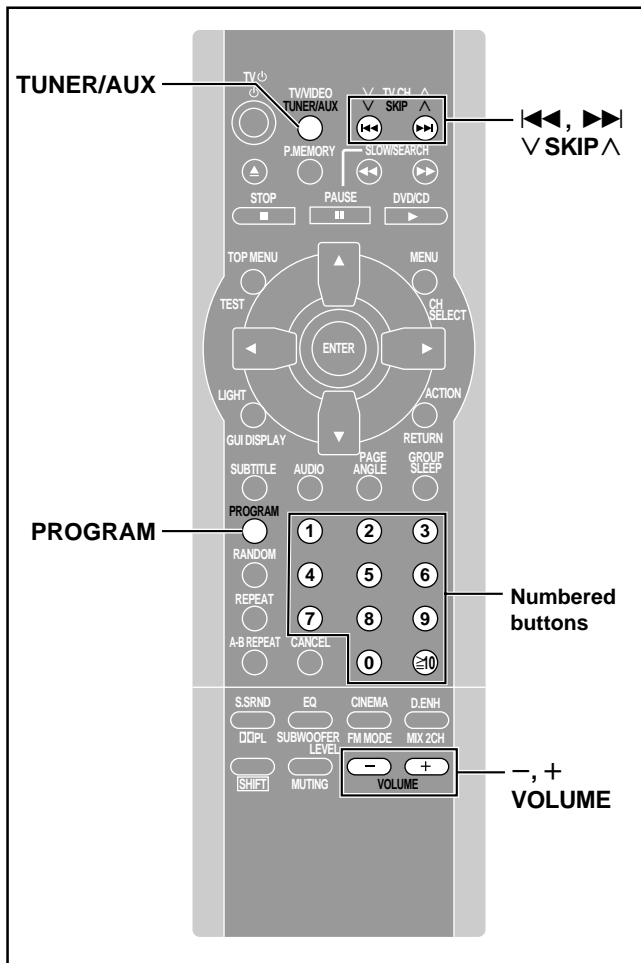

There are two methods of presetting stations.

Automatic presetting: The stations the tuner can receive are preset.

Manual presetting: You can select the stations to preset and the order they are preset in.

Up to 15 stations can each be set in the FM and AM bands.

Automatic presetting

Remote control only

1 Tune to “FM 87.9 MHz” or “FM 87.5 MHz”(⇒ page 20).

2 Press and hold [PROGRAM].

Release the button when the frequency starts changing.



“PGM” flashes while the stations are set. The last station to be set is then played.

3 Tune to “AM 520 kHz”.

4 Press and hold [PROGRAM].

Release the button when the frequency starts changing.



“PGM” flashes while the stations are set. The last station to be set is then played.

The tuner presets all the stations it can receive into the channels in ascending order. FM and AM stations are preset into channels 1 to 15.

Manual presetting

Remote control only

Preset the stations one at a time.

1 Tune to the station (⇒ page 20).

2 Press [PROGRAM].

3 Press the numbered buttons to select a channel.

Alternatively, press [◀◀, v] or [▶▶, ^] then press [PROGRAM].

The station occupying a channel is erased if another station is preset in that channel.

Selecting channels

1 Press [TUNER/AUX] to select “FM” or “AM”.

Each time you press the button:

FM → AM → AUX

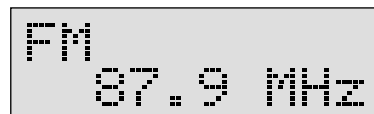

2 Press the numbered buttons or [◀◀, v] or [▶▶, ^] to select the channel.

To select a 2-digit number

Example: To select channel 12, press [≥10] ⇒ [1] ⇒ [2]

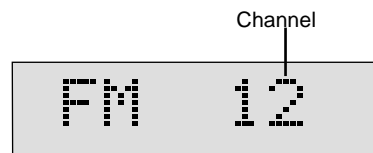



3 Adjust the volume.

Note

- Dolby Pro Logic and Super Surround cannot be used if headphones are connected.
- You may experience a reduction in sound quality when these sound field systems are used with some sources. If this occurs, turn the sound field system off.

Sound quality/sound field operations

Sound field system	Features	Software			
<p>DOLBY DIGITAL and DTS (→ page 23)</p>	<ul style="list-style-type: none"> •Dolby Digital and DTS are digital encoding systems used on DVD to carry surround sound. Both were originally developed for use in cinemas. •This unit automatically recognizes and decodes these systems. 	<p>Software encoded with Dolby Digital can be identified with this mark.</p>  <p>Software encoded with DTS can be identified with this mark.</p>  <ul style="list-style-type: none"> •DVD 			
<p>DOLBY PRO LOGIC (→ page 23)</p>	<p>Dolby Pro Logic is a decoding system that was developed to get a better sense of presence from sources encoded with Dolby Surround. The feeling of position has been improved by the addition of a separate center speaker channel.</p>	<p>Software encoded with Dolby Surround can be identified with this mark.</p>  <ul style="list-style-type: none"> •DVD •CD, Video CD •Laser Disc •Video tape 			
<table border="1"> <tr> <td rowspan="2" style="vertical-align: middle;"> <p>SUPER SURROUND (→ page 24)</p> </td> <td style="text-align: center;"> <p>MUSIC</p> </td> </tr> <tr> <td style="text-align: center;"> <p>MOVIE</p> </td> </tr> </table>	<p>SUPER SURROUND (→ page 24)</p>	<p>MUSIC</p>	<p>MOVIE</p>	<ul style="list-style-type: none"> •This mode adds surround effects to stereo sources. •You can adjust the volume of the surround speakers to get the best surround effect. •This mode adds surround effects to movie software that hasn't been recorded with the above systems. •You can adjust the volume of the surround speakers to get the best surround effect. 	<p>Any stereo sound source.</p>
<p>SUPER SURROUND (→ page 24)</p>		<p>MUSIC</p>			
	<p>MOVIE</p>				
<p>Sound field control (→ page 24)</p>	<p>Use sound field control effects to change the sound quality and add reverberation.</p>	<p>Any source.</p>			

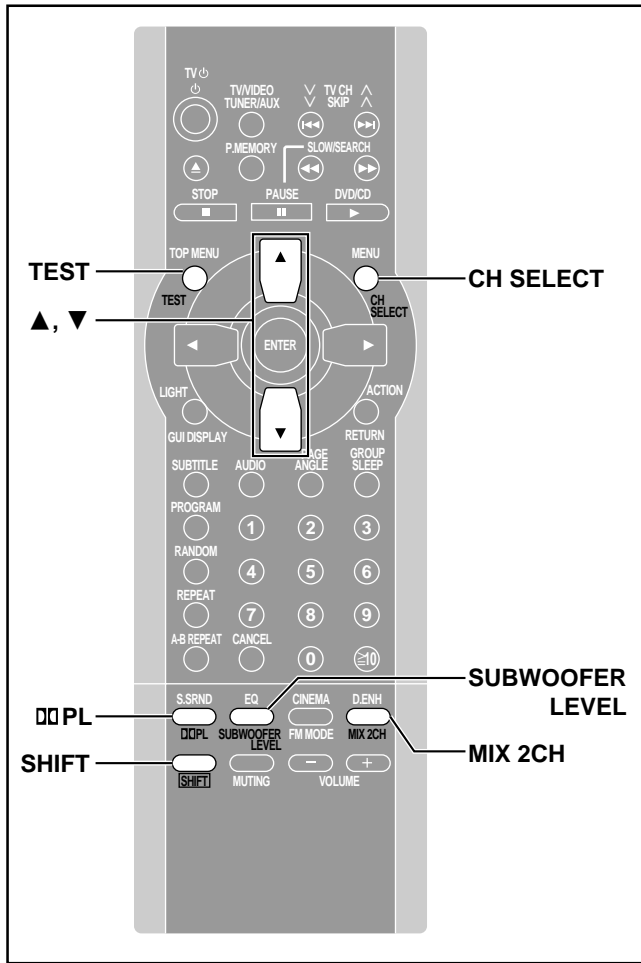

Remote control only

DOLBY DIGITAL and DTS

Play a DOLBY DIGITAL or DTS source.

The unit automatically determines the type of signal and processes it.

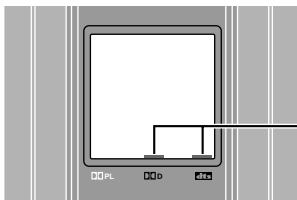

The Dolby Digital or DTS indicator lights.

To add power to the bass from the subwoofer ➔ page 24.

To down-mix Dolby Digital or DTS (5.1 ch) signals to 2 channels

Press [SHIFT] + [MIX 2CH] during play.
To cancel, press [SHIFT] + [MIX 2CH] again.

DVD-A

When "D.MIX" flashes on the display

The DVD-Audio contains multiple-channel signals that cannot be down-mixed.

DOLBY PRO LOGIC

1 Press [SHIFT] + [DOLPL].

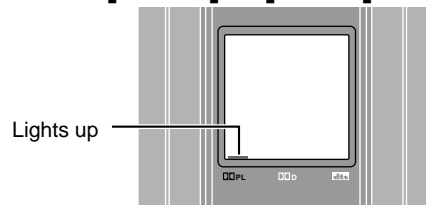

Lights up

2 Play a Dolby Surround source.

To cancel

Press [SHIFT] + [DOLPL].

Note

Turn Dolby Pro Logic off when playing a DVD recorded with Dolby Digital or DTS. The surround effects will not be reproduced correctly if this is left on.

Speaker level adjustments

If the level of the speakers appears to be different while listening to a source, adjust the level of the speakers to the same apparent level.

Preparation

DOLBY DIGITAL and DTS: Turn off the other surround systems.

DOLBY PRO LOGIC: Press [SHIFT] + [DOLPL].

- Press [SHIFT] + [TEST] to output a test signal.
Lch: Front left
Cch: Center
Rch: Front right
RSch: Right surround
LSch: Left surround
 - The surround channel for Dolby Pro Logic is monaural so the indicator appears as "Sch" instead.
- Press [▲] (to increase) or [▼] (to decrease).
L, R: -16 dB to 0 dB
C, RS, LS, S: -10 dB to +6 dB

To stop the test signal, press [SHIFT] + [TEST] again.

To adjust speaker level during play

- Press [SHIFT] + [CH SELECT] to select the speaker.

Lch → Cch → Rch → RSch → LSch → SWch

SWch: Subwoofer

Dolby Pro Logic

- The surround channel is monaural so the indicator appears as "Sch" instead.
 - "SWch" does not appear.
- Press [▲] (to increase) or [▼] (to decrease).
L, R: -16 dB to 0 dB
C, RS, LS, S: -10 dB to +6 dB
SW: -10 dB to +10 dB

Note

You can also adjust subwoofer level by pressing [SHIFT] + [SUBWOOFER LEVEL].

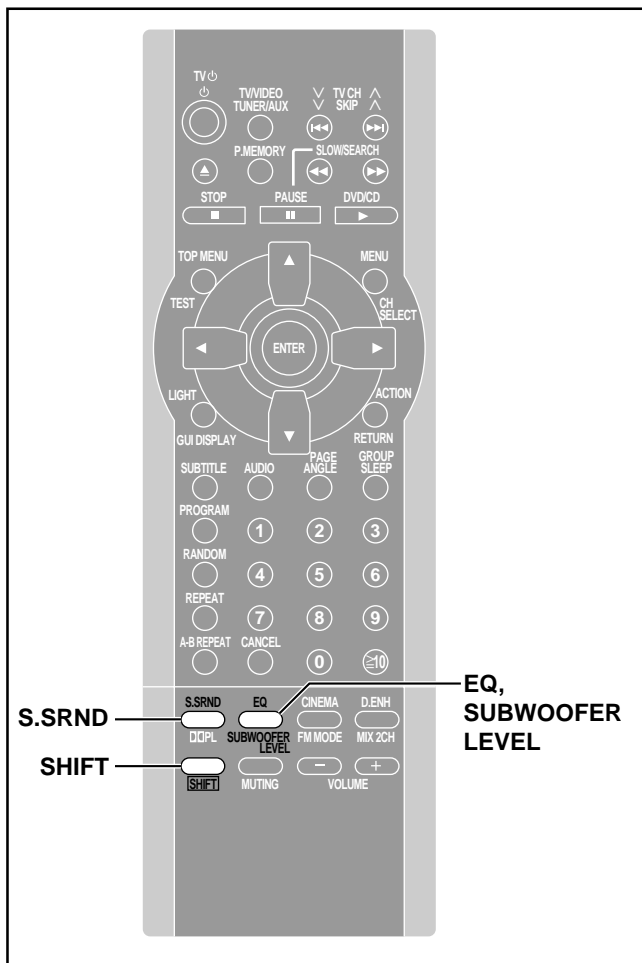

Changing sound field and quality

Press [EQ] to select a setting.



- Each time you press the button:
- HEAVY:** Adds punch to rock (factory preset).
- CLEAR:** Clarifies higher sounds.
- SOFT:** For background music.
- DISCO:** Reverberates sound to make you feel like you were in a disco.
- LIVE:** Makes vocals more alive.
- HALL:** Expands sound to make you feel like you were in a hall.
- FLAT:** Canceled (no effect is added).

Adjusting the bass

Press [SHIFT] + [SUBWOOFER LEVEL].



Each time you press the button:
 SUB W 1 → SUB W 2 → SUB W 3 → SUB W 0 (off)

Note
 You cannot adjust the bass while you are using headphones ("ERROR" appears on the display).

Remote control only

SUPER SURROUND

Press [S.SRND] to select "MUSIC" or "MOVIE".



Each time you press the button:
 MUSIC → MOVIE → STEREO SOUND (off)

To cancel
 Press [S.SRND] to select "STEREO SOUND".

Note
 Turn super surround off when playing a DVD recorded with Dolby Digital or DTS. The surround effects will not be reproduced correctly if this is left on.

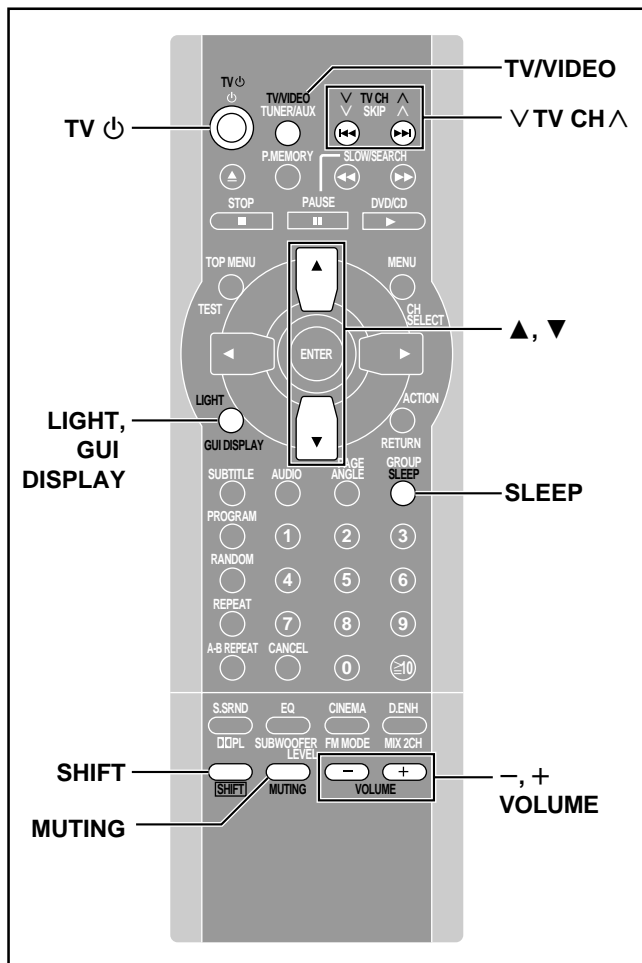

Operating a television

Remote control only

You can use the remote control to operate a Panasonic television.

Turning the television on/off

Press [SHIFT] + [TV ⏻].

Switching the television's video input mode

Press [SHIFT] + [TV/VIDEO].

Changing channels

Press [SHIFT] + [v TV CH ^].

Note

Some models cannot be operated by this remote control.

The sleep timer

Remote control only

This timer turns the unit off after a set time.

Press [SLEEP] to select the time (minutes).



Each time you press the button:
 SLEEP 30 → SLEEP 60 → SLEEP 90
 ↑ SLEEP OFF ← SLEEP 120 ←

To cancel the timer

Press [SLEEP] to select "SLEEP OFF".

To check the SLEEP setting

Press [SLEEP] once.

- The time remaining appears.

To change the setting

Press [SLEEP] to display the remaining time, then press again to select the required time.

Muting the volume

Remote control only

Press [MUTING].



Volume is reduced to minimum.

To cancel

Press [MUTING] again or reduce the volume to minimum (--- dB), then raise it to the required level.

Muting is also canceled when the unit is turned off.

Turning the display's light off

Remote control only

Press [SHIFT] + [LIGHT].

To turn the display's light on again, press [SHIFT] + [LIGHT].

Adjusting the display's contrast

Remote control only

1 Press and hold [GUI DISPLAY] until "CONTRAST" appears on the display.

2 Press [▲, ▼].

The contrast changes (up to 20 steps) each time you press the button.

Using headphones

1 Reduce the volume and connect the headphones (not included).

Headphone plug type: 3.5 mm (1/8") stereo

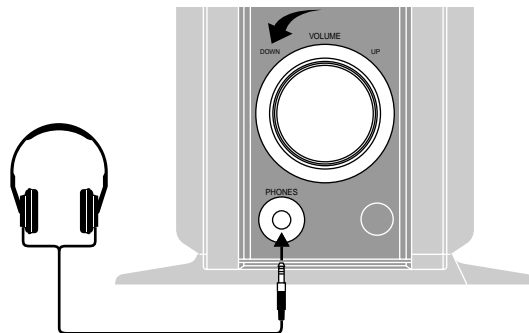

2 Adjust headphone volume with [VOLUME].

Audio is automatically switched to stereo (2-channel). If sound is distorted, turn on dynamic range compression (➡ page 26, Audio—D. Range Compression).





Note

Avoid listening for prolonged periods of time to prevent hearing damage.

Changing settings

This chart shows the settings for this unit. Change the settings to suit your preferences and to suit the unit to the environment in which it is being used. These settings are retained in memory until they are changed, even if the unit is turned off. See page 27 for details on menu operation.

• Underlined items are the factory preset.

Menus	Items	Options
Disc 	Audio <u>DVD-A</u> <u>DVD-V</u> Choose the preferred audio language.	<u>English</u> French Spanish Original Other **** Original: The original language of each disc will be selected. Other ****: Input a code number with the numbered buttons (⇒ page 28).
	Subtitle <u>DVD-A</u> <u>DVD-V</u> Choose the preferred subtitle language.	<u>Automatic</u> English French Spanish Other **** Automatic: If the language selected for "Audio" is not available, subtitles of that language will automatically appear if available on that disc.
	Menus <u>DVD-A</u> <u>DVD-V</u> Choose the preferred language for disc menus.	<u>English</u> French Spanish Other ****
	Ratings <u>DVD-V</u> (⇒ page 28) Set a ratings level to limit DVD-Video play. • The password screen is shown if you choose levels 0 to 7 or if you choose "Ratings" when levels 0 to 7 have been selected. • Select "Level 0" to prevent play of discs that do not have ratings levels recorded on them.	Setting ratings (When level 8 is selected) 8 <u>No Limit</u> : All DVD-Video can be played. 1 to 7: Prohibits play of DVD-Video with corresponding ratings recorded on them. 0 <u>Lock All</u> : Prohibits play of all DVD-Video. <hr/> Changing ratings (When level 0–7 is selected) Unlock Player Change Level Change Password Temporary Unlock
Video 	TV Aspect (⇒ page 9) Choose the setting to suit your television and preference.	<u>4:3 Pan&Scan</u> 4:3 Letterbox 16:9
	Still Mode (⇒ page 32) Specify the type of picture shown when paused.	<u>Automatic</u> Field Frame
	Black Level Control Change the black level of the picture.	<u>Lighter</u> Darker
Audio 	Speaker Setting <u>DVD-V</u> (⇒ page 28) (Dolby Digital only) Set the delay time for your center and surround speakers.	Center: 0/1.3/2.6/3.9/5.3 ms Surround (L/R): 0/5.3/10.6/15.9 ms
	D. Range Compression <u>DVD-V</u> (Dolby Digital only) Change the dynamic range for late night viewing.	<u>Off</u> On Turn dynamic range compression on in the following cases. • For clear dialogue when listening at low volume. • When sound is distorted while playing multi-channel DVD audio through two channels (when headphones are connected or when using the MIX 2CH mode).
	Audio during Search <u>DVD-A</u> <u>DVD-V</u> <u>VCD</u> Choose whether to have sound during search.	<u>On</u> Off: Audio will still be heard during search with some DVD-Audio.
Display 	Menu Language Choose the preferred language for these menus and the on-screen messages.	<u>English</u> Français Español
	On-Screen Messages Choose whether to show on-screen messages or not.	<u>On</u> Off
Others 	DVD-Video Mode <u>DVD-A</u> Select how to play pictures contained on some DVD-Audio. The setting returns to "Off" when you remove the disc, turn the unit off or change the source.	<u>Off</u> : DVD-Audio are played as DVD-Audio. On: DVD-Video contents found on DVD-Audio can be played.

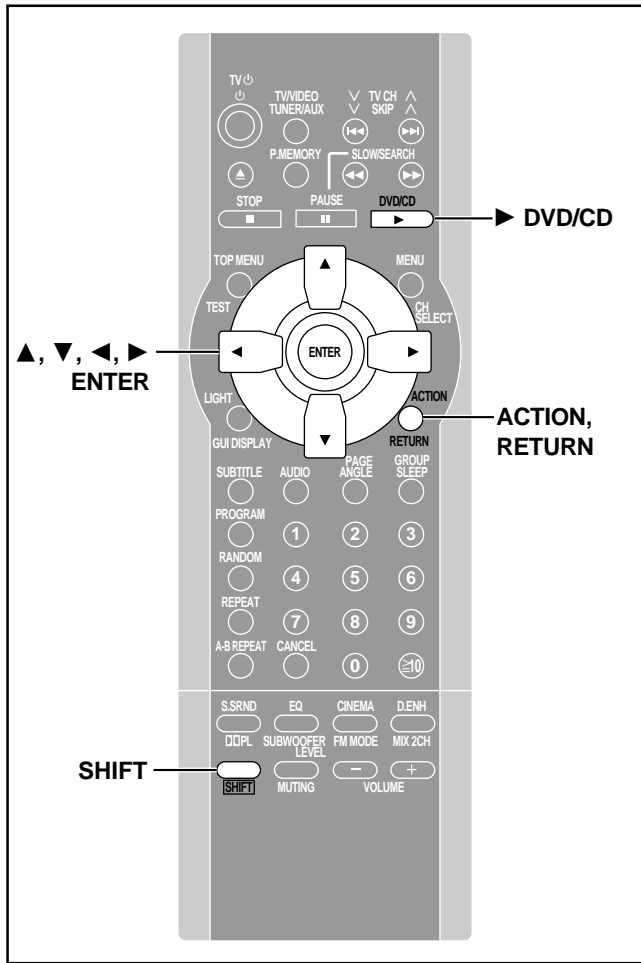

Common procedures

Remote control only

See page 26 for menu and option details.

Preparation

Press [DVD/CD] to select "DVD/CD".

- 1 Press [SHIFT] + [ACTION] to show the menus.

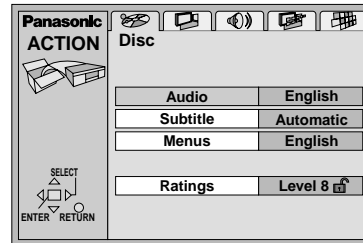

- 2 Press [LEFT], [RIGHT] to select the menu's tab.
The screen changes to display the menu.

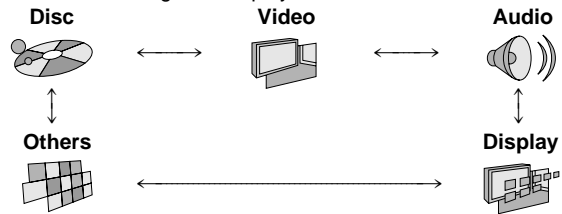

- 3 Press [UP], [DOWN] to select the item you want to change and press [ENTER].
- 4 Press [UP], [DOWN] to select the option and press [ENTER].
The screen now shows the menu again.

To return to the previous screen

Press [RETURN].

When you are finished

Press [SHIFT] + [ACTION].

Entering a password (Ratings)

DVD-V

The password screen is shown when you select levels 0 to 7.

- Input a 4-digit password with the numbered buttons and press [ENTER].
 - If you enter a wrong number, press [CANCEL] to erase it before you press [ENTER].
 - The lock symbol appears closed to show the rating is locked.
 - Do not forget your password.**
- Press [ENTER] to confirm the 4 digits.

Now, when you insert a DVD-Video that exceeds the ratings limit you set, a message appears on the television. Follow the on-screen instructions.

Changing the delay time

DVD-V

(Dolby Digital, center and surround speakers only)

For optimum listening with 5.1-channel sound, all the speakers, except for the subwoofer, should be the same distance from the seating position. If you have to place the center or surround speakers closer to the seating position, adjust the delay time to make up for the difference.

Center delay time

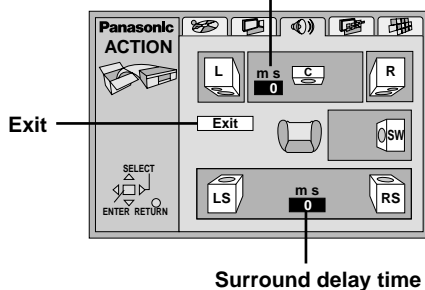

Surround delay time

Changing the delay time

- Press [▲, ▼, ◀, ▶] to select the delay time box and press [ENTER].
- Press [▲, ▼] to adjust the delay time and press [ENTER].

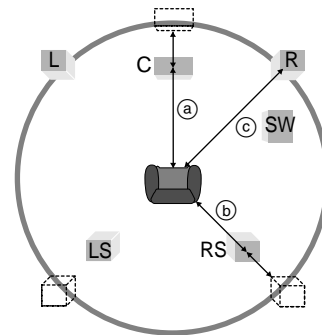

Values

If distance (a) or (b) is greater than or equal to distance (c), set to "0". If distance (a) or (b) is less than distance (c), set as follows.

(a) Center speaker

Difference	Setting
Approx. 50 cm (1½ feet)	1.3 ms
Approx. 100 cm (3 feet)	2.6 ms
Approx. 150 cm (5 feet)	3.9 ms
Approx. 200 cm (6 feet)	5.3 ms

(b) Surround speakers

Difference	Setting
Approx. 200 cm (6 feet)	5.3 ms
Approx. 400 cm (12 feet)	10.6 ms
Approx. 600 cm (18 feet)	15.9 ms

When you are finished

Press [▲, ▼, ◀, ▶] to select "Exit" and press [ENTER].

Language code list

Abkhazian: 6566	Chinese: 9072	Hausa: 7265	Lithuanian: 7684	Romanian: 8279	Telugu: 8469
Afar: 6565	Corsican: 6779	Hebrew: 7387	Macedonian: 7775	Russian: 8285	Thai: 8472
Afrikaans: 6570	Croatian: 7282	Hindi: 7273	Malagasy: 7771	Samoan: 8377	Tibetan: 6679
Albanian: 8381	Czech: 6783	Hungarian: 7285	Malay: 7783	Sanskrit: 8365	Tigrinya: 8473
Ameharic: 6577	Danish: 6865	Icelandic: 7383	Malayalam: 7776	Scots Gaelic: 7168	Tonga: 8479
Arabic: 6582	Dutch: 7876	Indonesian: 7378	Maltese: 7784	Serbian: 8382	Turkish: 8482
Armenian: 7289	English: 6978	Interlingua: 7365	Maori: 7773	Serbo-Croatian: 8372	Turkmen: 8475
Assamese: 6583	Esperanto: 6979	Irish: 7165	Marathi: 7782	Shona: 8378	Twai: 8487
Aymara: 6588	Estonian: 6984	Italian: 7384	Moldavian: 7779	Sindhi: 8368	Ukrainian: 8575
Azerbaijani: 6590	Faroese: 7079	Japanese: 7465	Mongolian: 7778	Singhalese: 8373	Urdu: 8582
Bashkir: 6665	Fiji: 7074	Javanese: 7487	Nauru: 7865	Slovak: 8375	Uzbek: 8590
Basque: 6985	Finnish: 7073	Kannada: 7578	Nepali: 7869	Slovenian: 8376	Vietnamese: 8673
Bengali; Bangla: 6678	French: 7082	Kashmiri: 7583	Norwegian: 7879	Somali: 8379	Volapük: 8679
Bhutani: 6890	Frisian: 7089	Kazakh: 7575	Oriya: 7982	Spanish: 6983	Welsh: 6789
Bihari: 6672	Galician: 7176	Kirghiz: 7589	Pashto, Pushto: 8083	Sundanese: 8385	Wolof: 8779
Breton: 6682	Georgian: 7565	Korean: 7579	Persian: 7065	Swahili: 8387	Xhosa: 8872
Bulgarian: 6671	German: 6869	Kurdish: 7585	Polish: 8076	Swedish: 8386	Yiddish: 7473
Burmese: 7789	Greek: 6976	Laotian: 7679	Portuguese: 8084	Tagalog: 8476	Yoruba: 8979
Byelorussian: 6669	Greenlandic: 7576	Latin: 7665	Punjabi: 8065	Tajik: 8471	Zulu: 9085
Cambodian: 7577	Guarani: 7178	Latvian, Lettish: 7686	Quechua: 8185	Tamil: 8465	
Catalan: 6765	Gujarati: 7185	Lingala: 7678	Rhaeto-Romance: 8277	Tatar: 8484	

Optional audio/video equipment connections

- Turn the unit off before making connections.
- Refer to the manual of the other unit for details.
(Cables and equipment not included.)

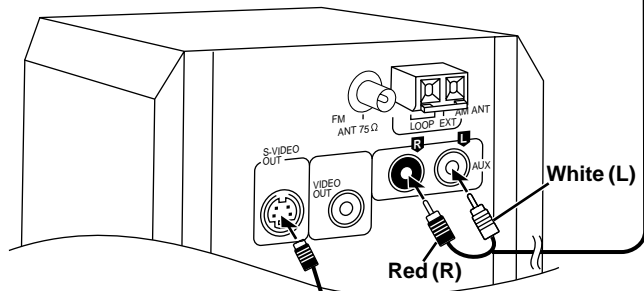

S-VIDEO IN



S-VIDEO cable

TV with an S-VIDEO terminal

The S-VIDEO OUT terminal achieves a more vivid picture than VIDEO OUT terminal by separating the chrominance (C) and luminance (Y) signals before transmitting them to the television. (Actual results depend on the television.)

AUDIO OUT

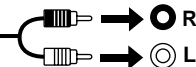

Audio cable

Laser disc player/Video cassette recorder, etc.

You can playback the sound from a laser disc player/video cassette recorder, etc. through this unit's speakers. This unit has Dolby Pro Logic circuitry. The sound will be reproduced with the same powerful stereophonic effects found in movie theaters.

When connecting a record player

We recommend using a record player with a built-in phono equalizer. If your player doesn't have a built-in equalizer, connect it first to a separate equalizer and then connect that to this unit.

To playback

- 1 Press [TUNER/AUX] to select "AUX".

Each time you press the button:

FM → AM → **AUX**

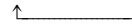

- 2 Start play.

Optional antenna connections

Use outdoor antennas if radio reception is poor.

Note

Disconnect the antenna when the unit is not in use.
Do not use the outdoor antenna during an electrical storm.

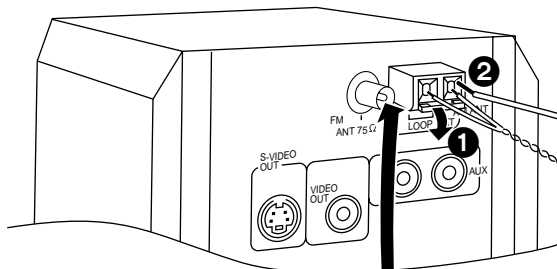

AM outdoor antenna (Using a vinyl wire)

Run a piece of vinyl wire horizontally across a window or other convenient location.

Leave the loop antenna connected.

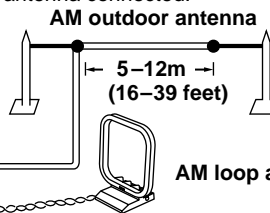

FM outdoor antenna (Using a television antenna)

- Disconnect the FM indoor antenna.
- The antenna should be installed by a competent technician. Rework your outdoor antenna's 75 Ω coaxial cable as follows.

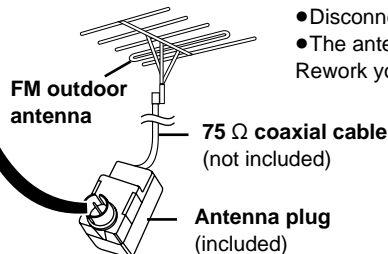

- 1 Remove a piece of the outer vinyl insulator.

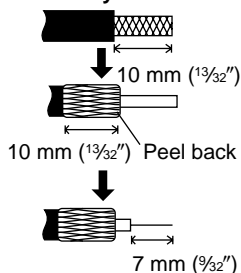

- 2 Carefully pull the tabs apart to remove the cover.

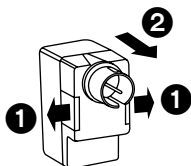

- 3 Install the coaxial cable.

Clamp the cable conductor, and wind it on so that it does not contact anything else.

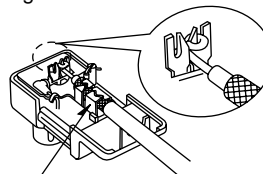

Clamp with pliers

- 4 Attach the cover.

Troubleshooting guide

Before requesting service, make the below checks. If you are in doubt about some of the check points, or if the remedies indicated in the chart do not solve the problem:

In the U.S.A., contact the Panasonic Customer Call Center at 1-800-211-7262, or e-mail consumerproducts@panasonic.com, or web site (<http://www.panasonic.com>).

In Canada, contact Panasonic Canada Inc. Customer Care Centre at 1-800-561-5505, web site (www.panasonic.ca), or an authorized Servicentre closest to you.

Reference pages are shown as black circled numbers ❸.

Power

No power.	<ul style="list-style-type: none"> ● Insert the AC power supply cord securely into the household AC outlet. ❸
The unit is automatically switched to the standby mode.	<ul style="list-style-type: none"> ● To conserve power, the unit automatically switches to standby after approximately 30 minutes in the stop mode. Turn the power back to ON. ● The unit was switched to standby by the sleep timer. ❷

Operation

No response when buttons pressed.	<ul style="list-style-type: none"> ● Some operations may be prohibited by the disc. ● The unit may not be operating properly due to lightning, static electricity or some other external factor. <p>Reset procedure: Press [⏻] to switch the unit to the standby mode and then back to ON. Alternatively, press [⏻] to switch the unit to the standby mode, disconnect the AC power supply cord, and then reconnect it.</p>
No operations can be performed with the remote control.	<ul style="list-style-type: none"> ● Check the batteries are installed correctly. ❸ ● The batteries are depleted: Replace them with new ones. ❸ ● Point the remote control at the remote control sensor and operate.
Play fails to start even when [▶ DVD/CD] is pressed. Play starts but then stops immediately.	<ul style="list-style-type: none"> ● Condensation has formed: Wait 1 to 2 hours for it to evaporate. ● This unit cannot play discs other than DVD-Audio, DVD-Video, CD and Video CD. ❹ ● This unit cannot play DVD-Video with a region number other than "1", "ALL" or multiple region numbers including "1". ❹ ● The disc may be dirty and may require cleaning. ❷ ● Ensure that the disc is inserted correctly: label facing right if the unit is standing or up if lying down. ❶
Alternative languages fail to be selected.	<ul style="list-style-type: none"> ● An alternative language is not selected with discs which do not contain more than one language. ● In the case of some discs, the alternative language cannot be selected with [AUDIO] or [SUBTITLE]. Try selecting it from the disc's menu if one is available. ❶
No menu play.	<ul style="list-style-type: none"> ● Menus are only displayed if they are recorded on the disc.
No subtitles.	<ul style="list-style-type: none"> ● Subtitles appear only with discs that contain them. ● Subtitles are cleared from the television. Display the subtitles. ❶
Soundtrack and/or subtitle language is not the one selected with the ACTION menus.	<ul style="list-style-type: none"> ● The language is not recorded on the disc.
Angle cannot be changed.	<ul style="list-style-type: none"> ● This function is dependent on software availability. Even if a disc has a number of angles recorded, these angles may be recorded for specific scenes only.
The ACTION menu cannot be accessed.	<ul style="list-style-type: none"> ● Select "DVD/CD" as the source. ● Cancel all group, program and random play. ❶ ❷
You have forgotten your ratings password. Reset all the settings to Factory Preset.	<ul style="list-style-type: none"> ● While stopped, press and hold [■] on the unit and [≧10] on the remote control for about 3 seconds until "Initialized" disappears from the television. Turn the unit off and on again. All settings will return to the default values.

Sound

No sound. Distorted sound.	<ul style="list-style-type: none"> ● Check the connections. ❷ ❸ ❷ ● Turn the volume up. ● Turn muting off. ❷ ● Switch off the unit, determine and correct the cause, then switch the unit on. <p>Causes include:</p> <ul style="list-style-type: none"> – Shorting (bare wires touching) of positive and negative speaker wires. ❷ – Using speakers with an impedance lower than that rated for this unit. ❷ – Straining of the speakers through excessive volume or power. – Using the unit in a hot environment without proper ventilation.
Humming heard during play.	<ul style="list-style-type: none"> ● An AC power supply cord or fluorescent light is near the cables. Keep other appliances and cords away from this unit's cables.
No sound from the subwoofer.	<ul style="list-style-type: none"> ● Check that the subwoofer has not been set to "SUB W 0". ❷

Picture

Picture distorted.	<ul style="list-style-type: none"> Some distortion is normal during SEARCH.
No picture.	<ul style="list-style-type: none"> Ensure that the television is connected properly. 7 Make sure the television is on. Ensure the television's video input setting (e.g., VIDEO 1) is correct.
The picture shown on the television is not normal. (The sides of the picture are cut off or black bands appear at the top and bottom of the screen.)	<ul style="list-style-type: none"> Go to the Video menu in the ACTION screen, and change "TV Aspect" to suit your television. You may also need to change the screen mode on the television itself. 9 Ensure that the unit is connected directly to the television, and is not connected through a video cassette recorder.
Picture quality is poor.	<ul style="list-style-type: none"> Check the settings in the On-Screen Menu Icons' video menu. 19
The picture on the television disappears or stripes appear on the screen.	<ul style="list-style-type: none"> The location and orientation of the antenna are incorrect. If you are using an indoor antenna, change to an outdoor antenna. 29 The television antenna wire is too close to the unit. Separate the antenna wire of the television from the unit.

Listening to the radio

Noise is heard. "STEREO" flickers or doesn't light. Sound is distorted.	<ul style="list-style-type: none"> Adjust the position of the FM or AM antenna. Use an outdoor antenna. 29
A beat sound is heard.	<ul style="list-style-type: none"> Turn the television off or separate it from the unit.
A low hum is heard during AM broadcasts.	<ul style="list-style-type: none"> Separate the antenna from other cables and cords.

Unit displays

The display is dark.	<ul style="list-style-type: none"> Press [SHIFT] + [LIGHT] to turn the backlight on, or press and hold [GUI DISPLAY] and press [▲, ▼] to adjust the contrast. 25
"NO PLAY"	<ul style="list-style-type: none"> You inserted a disc the unit cannot play; insert one it can. 4
"NO DISC"	<ul style="list-style-type: none"> You haven't inserted a disc; insert one. You haven't inserted the disc correctly; insert it correctly. 11
"F61"	<ul style="list-style-type: none"> Check and correct the speaker cord connections. 7 If this does not fix the problem, there is a power supply problem. Consult the dealer.
"DVD U11"	<ul style="list-style-type: none"> The disc is dirty. Wipe it with a soft cloth. 32
"ERROR"	<ul style="list-style-type: none"> Incorrect operation performed. Read the instructions and try again.
"DVD H□□" □□ stands for a number.	<ul style="list-style-type: none"> Trouble is likely to have occurred. The number following "H" depends on the status of the unit. Reset procedure: Press [⏻] to switch the unit to the standby mode and then back to ON. Alternatively, press [⏻] to switch the unit to the standby mode, disconnect the AC power supply cord, and then reconnect it. If the service numbers fail to clear, note the service number and contact a qualified service person.
"SETTING ERROR/ CHANGE SETTING"	<ul style="list-style-type: none"> You have setup the unit upside down. Turn it over. 5 (The unit switches to standby after 10 minutes in this condition.)

Television displays

No on-screen display.	<ul style="list-style-type: none"> Go to Display in the ACTION menus, and select "On" for "On-Screen Messages". 26
On-Screen Menu Icons not displayed or only partially displayed on the television.	<ul style="list-style-type: none"> Press [▲, ▼] while the rightmost icon is highlighted to move them down. 18
The disc's menu is displayed in a different language.	<ul style="list-style-type: none"> Go to Disc in the ACTION menus, and select the preferred language for "Menus". 26

Maintenance

The surface of the cabinet is polished.
Use the included cloth to clean it.

- Never use alcohol, paint thinner or benzine to clean this unit.

Before moving the unit, ensure the disc tray is empty.
Failure to do so will risk severely damaging the disc and the unit.

Bitstream

This is the digital form of multiple channel audio data (e.g., 5.1 channel) before it is decoded into its various channels.

Decoder

A decoder restores the coded audio signals on DVDs to normal. This is called decoding.

Dolby Digital

This is a method of coding digital signals developed by Dolby Laboratories. Apart from stereo (2-channel) audio, these signals can also be 5.1-channel audio. A large amount of audio information can be recorded on one disc using this method.

Dolby Pro Logic

A surround system where a 4-channel audio track is recorded as 2 channels and then is restored to 4 channels for play. The surround channel is monaural and can reproduce up to 7 kHz.

DTS (Digital Theater Systems)

This surround system is used in many movie theaters around the world. There is good separation between the channels, so realistic sound effects are possible.

Dynamic range

Dynamic range is the difference between the lowest level of sound that can be heard above the noise of the equipment and the highest level of sound before distortion occurs.

Frame still and field still

Frames are the still pictures that go together to make a moving picture. There are about 30 frames shown each second.

One frame is made up of two fields. A regular television shows these fields one after the other to create frames.

A still is shown when you pause a moving picture. A frame still is made up of two alternating fields, so the picture may appear blurred, but overall quality is high.

A field still is not blurred, but it has only half the information of a frame still so picture quality is lower.

I/P/B

MPEG 2, the video compression standard adopted for use with DVD-Video, codes frames using these 3 picture types.

I: Intra coded picture (I-picture)

This is the standard picture and is a complete picture in itself.

This means it has the best picture quality and is the best to use when adjusting the picture.

P: Predictive coded picture (P-picture)

This picture is calculated based on past I or P-pictures.

B: Bidirectionally-predictive coded picture (B-picture)

This picture is calculated by comparing past and future I and P-pictures so it has the lowest volume of information.

Linear PCM (pulse code modulation)

These are uncompressed digital signals, similar to those found on CDs.

MP3

A method of compressing audio, MPEG Audio Layer 3 (MP3) allows audio to be reduced to up to one tenth its original size without overtly hurting audio quality.

When creating MP3 files to play on this unit

- Disc formats: ISO9660 level 1 and level 2 (except for extended formats)

Files: MP3 files with the suffix “.mp3” or “.MP3”

- To have this unit play files in a certain order, prefix folder and file names with numbers in the order you want to play them. This may not work in all cases.

Not compatible with multi-session recordings

If you record MP3 onto CD-R/CD-RW over a number of sessions, this unit can play only the recordings made in the first session.

Playback control (PBC)

If a Video CD has playback control, you can select scenes and information with menus.

Disc handling

Do not use irregularly shaped discs, such as heart-shaped. (These can damage the unit.)

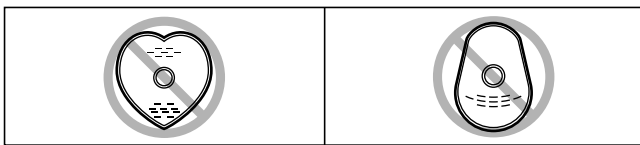

How to hold a disc

Do not touch the recorded surface.

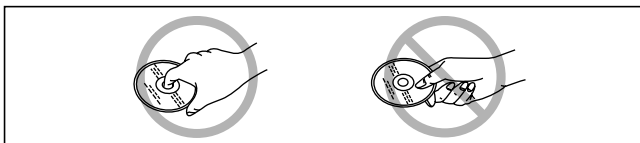

If the surface is dirty

Wipe it with a damp cloth and then wipe dry.

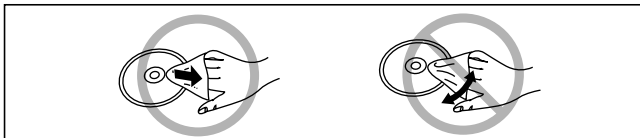

If the disc is brought from a cold to a warm environment, moisture may form on the disc

Wipe with a soft, dry, lint-free cloth before using the disc.

Handling precautions

- Do not write on the label side with a ball-point pen or other writing instrument.
- Do not use record cleaning sprays, benzene, thinner, static electricity prevention liquids or any other solvent.
- Do not attach labels or stickers to discs. (Do not use discs with exposed adhesive from tape or left over peeled-off stickers.)
- Do not use scratch-proof protectors or covers.
- Do not use discs printed with label printers available on the market.

Do not place or store discs in the following places

- Locations exposed to direct sunlight
- Humid or dusty locations
- Locations directly exposed to a heat vent or heating appliance

AMPLIFIER SECTION

FTC TTL POWER OUTPUT	170 W
120 Hz–20 kHz 1.0 % total harmonic distortion	
FRONT	15 W per channel (8 Ω)
CENTER	45 W (8 Ω)
SURROUND	20 W per channel (8 Ω)
45 Hz–120 Hz 1.0 % total harmonic distortion	
SUBWOOFER	55 W (8 Ω)
RMS TTL POWER OUTPUT	200 W
1 kHz 10 % total harmonic distortion	
FRONT	20 W per channel (8 Ω)
CENTER	50 W (8 Ω)
SURROUND	25 W per channel (8 Ω)
100 Hz 10 % total harmonic distortion	
SUBWOOFER	60 W (8 Ω)
Input sensitivity/Input impedance	
AUX	250 mV, 10 kΩ

FM TUNER SECTION

Frequency range	87.9–107.9 MHz (200-kHz step)
	87.5–108.0 MHz (100-kHz step)
Antenna terminals	75 Ω (unbalanced)

AM TUNER SECTION

Frequency range	520–1710 kHz (10-kHz step)
------------------------	----------------------------

DISC SECTION

Disc played	DVD-AUDIO, DVD-VIDEO, DVD-R (DVD-VIDEO formatted discs), CD (CD-DA), VIDEO-CD, CD-R/RW (CD-DA, VIDEO-CD, MP3 formatted discs)
Audio	
Number of channels	5.1 (FL, FR, SL, SR, C, SW)
Video	
Signal system	NTSC
Output terminal	RCA (composite video) S terminal (Y, C)
Pick up	
Beam Source	Semiconductor Laser
Wavelength	
DVD	658 nm
VCD/CD	790 nm

SPEAKER SECTION

Front/Center speakers SB-FDM3

Type	1 way, 1 speaker, Closed
Speakers	
Full range	6.5 cm (2 ¹ / ₂ " cone type
Impedance	8 Ω
Input power	60 W (Music)
Output sound pressure level	80 dB/W (1.0 m)
Frequency range	150 Hz–25 kHz (–16 dB) 200 Hz–22 kHz (–10 dB)
Dimensions (W×H×D)	83×108×99 mm (3 ⁹ / ₃₂ "×4 ¹ / ₄ "×3 ²⁹ / ₃₂ ")
Mass	0.7 kg (1.5 lb.)

Surround speakers SB-RDM3

Type	1 way, 1 speaker, Closed
Speakers	
Full range	6.5 cm (2 ¹ / ₂ " cone type
Impedance	8 Ω
Input power	60 W (Music)
Output sound pressure level	80 dB/W (1.0 m)
Frequency range	150 Hz–25 kHz (–16 dB) 200 Hz–22 kHz (–10 dB)
Dimensions (W×H×D)	83×108×99 mm (3 ⁹ / ₃₂ "×4 ¹ / ₄ "×3 ²⁹ / ₃₂ ")
Mass	0.7 kg (1.5 lb.)

Subwoofer SB-WDM3

Type	1 way, 1 speaker, Bass-ref.
Speaker unit	
Super woofer	17 cm (6 ³ / ₄ " cone type
Impedance	8 Ω
Input power	60 W (Music)
Output sound pressure level	80 dB/W (1.0 m)
Frequency range	42 Hz–1.5 kHz (–16 dB) 46 Hz–0.9 kHz (–10 dB)
Dimensions (W×H×D)	164×297×320 mm (6 ¹⁵ / ₃₂ "×11 ¹¹ / ₁₆ "×12 ¹⁹ / ₃₂ ")
Mass	3.7 kg (8.2 lb.)

GENERAL

Power supply	AC 120 V, 60 Hz
Power consumption	120 W
Dimensions (W×H×D)	
Vertically with stand	135×298×390 mm (5 ⁵ / ₁₆ "×11 ²³ / ₃₂ "×15 ¹¹ / ₃₂ ")
Horizontally with feet attached	292×100×390 mm (11 ¹ / ₂ "×3 ¹⁵ / ₁₆ "×15 ¹¹ / ₃₂ ")
Mass	6.2 kg (13.7 lb.)

Power consumption in standby mode	0.5 W
--	-------

Note

- Specifications are subject to change without notice.
Mass and dimensions are approximate.
- Total harmonic distortion is measured by the digital spectrum analyzer.

Limited Warranty (U.S.A.)

Panasonic Consumer Electronics Company,
Division of Matsushita Electric Corporation of America
One Panasonic Way Secaucus, New Jersey 07094

Panasonic Sales Company, Division of Matsushita Electric
of Puerto Rico, Inc.
Ave. 65 de Infantería, Km. 9.5
San Gabriel Industrial Park, Carolina, Puerto Rico 00985

Panasonic/Technics Audio Products Limited Warranty

Limited Warranty Coverage

If your product does not work properly because of a defect in materials or workmanship, Panasonic Consumer Electronics Company or Panasonic Sales Company (collectively referred to as "the warrantor") will, for the length of the period indicated on the chart below, which starts with the date of original purchase ("warranty period"), at its option either (a) repair your product with new or refurbished parts, or (b) replace it with a new or a refurbished product. The decision to repair or replace will be made by the warrantor.

Product or Part Name	Parts	Labor
Audio Products (except items listed below)	One (1) year	One (1) year
All Audio Racks (cabinets)	Thirty (30) days	Not Applicable
Technics Stand Alone Speakers, Subwoofer Speakers	Three (3) years	Three (3) years
USB Reader-Writer, Personal Computer Card Adapters (in exchange for defective item)	One (1) year	Not Applicable
Accessories: Headphones, Cartridges, Microphones, Adapters	Ninety (90) days	Ninety (90) days
Rechargeable Batteries (in exchange for defective item)	Ten (10) days	Not Applicable
SD Memory Cards, Rechargeable Battery Packs (in exchange for defective item)	Ninety (90) days	Not Applicable

During the "Labor" warranty period there will be no charge for labor. During the "Parts" warranty period, there will be no charge for parts. You must carry-in or mail-in your product during the warranty period. If non-rechargeable batteries are included, they are not warranted. This warranty only applies to products purchased and serviced in the United States or Puerto Rico. This warranty is extended only to the original purchaser of a new product which was not sold "as is". A purchase receipt or other proof of the original purchase date is required for warranty service.

Carry-In or Mail-In Service

For Carry-In or Mail-In Service in the United States call 1-800-211-PANA (1-800-211-7262) or visit Panasonic web site: <http://www.panasonic.com>
For assistance in Puerto Rico call Panasonic Sales Company (787)-750-4300 or fax (787)-768-2910.

Limited Warranty Limits And Exclusions

This warranty ONLY COVERS failures due to defects in materials or workmanship, and DOES NOT COVER normal wear and tear or cosmetic damage. The warranty ALSO DOES NOT COVER damages which occurred in shipment, or failures which are caused by products not supplied by the warrantor, or failures which result from accidents, misuse, abuse, neglect, mishandling, misapplication, alteration, faulty installation, set-up adjustments, misadjustment of consumer controls, improper maintenance, power line surge, lightning damage, modification, or commercial use (such as in a hotel, office, restaurant, or other business), rental use of the product, service by anyone other than a Factory Servicer or other Authorized Servicer, or damage that is attributable to acts of God.

THERE ARE NO EXPRESS WARRANTIES EXCEPT AS LISTED UNDER " LIMITED WARRANTY COVERAGE". THE WARRANTOR IS NOT LIABLE FOR INCIDENTAL OR CONSEQUENTIAL DAMAGES RESULTING FROM THE USE OF THIS PRODUCT, OR ARISING OUT OF ANY BREACH OF THIS WARRANTY. (As examples, this excludes damages for lost time, travel to and from the servicer, loss of media or images, data or other memory content. The items listed are not exclusive, but are for illustration only.) **ALL EXPRESS AND IMPLIED WARRANTIES, INCLUDING THE WARRANTY OF MERCHANTABILITY, ARE LIMITED TO THE PERIOD OF THE LIMITED WARRANTY.**

Some states do not allow the exclusion or limitation of incidental or consequential damages, or limitations on how long an implied warranty lasts, so the exclusions may not apply to you. This warranty gives you specific legal rights and you may also have others rights which vary from state to state. If a problem with this product develops during or after the warranty period, you may contact your dealer or Servicer. If the problem is not handled to your satisfaction, then write to the warrantor's Consumer Affairs Department at the addresses listed for the warrantor.

PARTS AND SERVICE WHICH ARE NOT COVERED BY THIS LIMITED WARRANTY ARE YOUR RESPONSIBILITY.

**For Product Information, Operating Assistance, Literature Request, Dealer Locations, and all Customer Service inquiries please contact:
1-800-211-PANA (7262), Monday-Friday 9 am-9 pm; Saturday-Sunday 9 am-7 pm, EST.**

**Web Site: <http://www.panasonic.com>
You can purchase parts, accessories or locate your nearest servicer by visiting our Web Site.**

Accessory Purchases:

1-800-332-5368 (Customer Orders Only)
Panasonic Services Company 20421 84th Avenue South, Kent, WA 98032
(6 am to 5 pm Monday-Friday; 6 am to 10:30 am Saturday; PST)
(Visa, MasterCard, Discover Card, American Express, Check)

Service in Puerto Rico

**Matsushita Electric of Puerto Rico, Inc. Panasonic Sales Company/Factory Servicer:
Ave. 65 de Infantería, Km. 9.5, San Gabriel Industrial Park, Carolina, Puerto Rico 00985
Phone (787) 750-4300 Fax (787) 768-2910**

1. **Damage requiring service**—The unit should be serviced by qualified service personnel if:
 - (a) The AC power supply cord or AC adaptor has been damaged; or
 - (b) Objects or liquids have gotten into the unit; or
 - (c) The unit has been exposed to rain; or
 - (d) The unit does not operate normally or exhibits a marked change in performance; or
 - (e) The unit has been dropped or the cabinet damaged.
2. **Servicing**—Do not attempt to service the unit beyond that described in these operating instructions. Refer all other servicing to authorized servicing personnel.
3. **Replacement parts**—When parts need replacing ensure the servicer uses parts specified by the manufacturer or parts that have the same characteristics as the original parts. Unauthorized substitutes may result in fire, electric shock, or other hazards.
4. **Safety check**—After repairs or service, ask the servicer to perform safety checks to confirm that the unit is in proper working condition.

The servicer will require all components to service your system.

Therefore, should service ever be necessary, be sure to bring the entire system.

Product information

For product information or assistance with product operation:

In the U.S.A., contact the Panasonic Customer Call Center at 1-800-211-7262, or e-mail consumerproducts@panasonic.com, or web site (<http://www.panasonic.com>).

In Canada, contact Panasonic Canada Inc. Customer Care Centre at 1-800-561-5505, web site (www.panasonic.ca), or an authorized Servicentre closest to you.

Listening caution



Selecting fine audio equipment such as the unit you've just purchased is only the start of your musical enjoyment. Now it's time to consider how you can maximize the fun and excitement your equipment offers. This manufacturer and the Electronic Industries Association's Consumer Electronics Group want you to get the most out of your equipment by playing it at a safe level. One that lets the sound come through loud and clear without annoying blaring or distortion—and, most importantly, without affecting your sensitive hearing.

We recommend you to avoid prolonged exposure to excessive noise.

Sound can be deceiving. Over time your hearing "comfort level" adapts to higher volumes of sound. So what sounds "normal" can actually be loud and harmful to your hearing.

Guard against this by setting your equipment at a safe level BEFORE your hearing adapts.

To establish a safe level:

- Start your volume control at a low setting.
- Slowly increase the sound until you can hear it comfortably and clearly, and without distortion.

Once you have established a comfortable sound level:

- Set the dial and leave it there.

Taking a minute to do this now will help to prevent hearing damage or loss in the future. After all, we want you listening for a lifetime.

Manufactured under license from Dolby Laboratories. "Dolby", "Pro Logic" and the double-D symbol are trademarks of Dolby Laboratories.

Manufactured under license from Digital Theater Systems, Inc. US Pat. No. 5,451,942, 5,956,674, 5,974,380, 5,978,762 and other world-wide patents issued and pending. "DTS" and "DTS Digital Surround" are registered trademarks of Digital Theater Systems, Inc. © 1996, 2000 Digital Theater Systems, Inc. All rights reserved.

Apparatus Claims of U.S. Patent Nos. 4,631,603, 4,577,216, and 4,819,098, licensed for limited viewing uses only.

This product incorporates copyright protection technology that is protected by method claims of certain U.S. patents and other intellectual property rights owned by Macrovision Corporation and other rights owners. Use of this copyright protection technology must be authorized by Macrovision Corporation, and is intended for home and other limited viewing uses only unless otherwise authorized by Macrovision Corporation. Reverse engineering or disassembly is prohibited.

Panasonic Consumer Electronics Company, Division of Matsushita Electric Corporation of America
One Panasonic Way Secaucus,
New Jersey 07094
<http://www.panasonic.com>

Panasonic Sales Company, Division of Matsushita Electric of Puerto Rico, Inc. ("PSC")
Ave. 65 de Infantería, Km. 9.5
San Gabriel Industrial Park, Carolina,
Puerto Rico 00985

Panasonic Canada Inc.
5770 Ambler Drive
Mississauga, Ontario
L4W 2T3
www.panasonic.ca

En