

Panasonic®

Operating Instructions Blu-ray Disc™ Recorder

Model No. **DMR-BWT460**



Getting started

Watching broadcasts

Recording

Playing back video

Editing video

Copying video

Photo and Music

With Other Equipment

Convenient functions

Setup

Reference

Thank you for purchasing this product.
Please read these instructions carefully before using this product, and save this manual for future use.

Software (Firmware) Update



To support the latest features, it's very important you install the latest updates to maintain proper operation of your unit. For details, refer to "Software (Firmware) Update" (⇒ 56) or <http://panasonic.jp/support/global/cs/> (This site is in English only.)

Safety precautions

WARNING

Unit

- To reduce the risk of fire, electric shock or product damage,
 - Do not expose this unit to rain, moisture, dripping or splashing.
 - Do not place objects filled with liquids, such as vases, on this unit.
 - Use only the recommended accessories.
 - Do not remove covers.
 - Do not repair this unit by yourself. Refer servicing to qualified service personnel.
 - Do not let metal objects fall inside this unit.
 - Do not place heavy items on this unit.

AC mains lead

- To reduce the risk of fire, electric shock or product damage,
 - Ensure that the power supply voltage corresponds to the voltage printed on this unit.
 - Insert the mains plug fully into the socket outlet.
 - Do not pull, bend, or place heavy items on the lead.
 - Do not handle the plug with wet hands.
 - Hold onto the mains plug body when disconnecting the plug.
 - Do not use a damaged mains plug or socket outlet.
- The mains plug is the disconnecting device. Install this unit so that the mains plug can be unplugged from the socket outlet immediately.

CAUTION

Unit

- This unit utilizes a laser. Use of controls or adjustments or performance of procedures other than those specified herein may result in hazardous radiation exposure.
- Do not place sources of naked flames, such as lighted candles, on this unit.
- This unit may receive radio interference caused by mobile telephones during use. If such interference occurs, please increase separation between this unit and the mobile telephone.
- This unit is intended for use in moderate climates.

Placement

- Place this unit on an even surface.
- To reduce the risk of fire, electric shock or product damage,
 - Do not install or place this unit in a bookcase, built-in cabinet or in another confined space. Ensure this unit is well ventilated.
 - Do not obstruct this unit's ventilation openings with newspapers, tablecloths, curtains, and similar items.
 - Do not expose this unit to direct sunlight, high temperatures, high humidity, and excessive vibration.

Batteries

- Danger of explosion if battery is incorrectly replaced. Replace only with the type recommended by the manufacturer.
- Mishandling of batteries can cause electrolyte leakage and may cause a fire.
 - Do not mix old and new batteries or different types at the same time.
 - Do not heat or expose to flame.
 - Do not leave the battery(ies) in a car exposed to direct sunlight for a long period of time with doors and windows closed.
 - Do not take apart or short circuit.
 - Do not recharge alkaline or manganese batteries.
 - Do not use batteries if the covering has been peeled off.
 - Remove batteries if you do not intend to use the remote control for a long period of time. Store in a cool, dark place.
- When disposing of the batteries, please contact your local authorities or dealer and ask for the correct method of disposal.

Indemnity concerning recorded content

Panasonic does not accept any responsibility for damages directly or indirectly due to any type of problems that result in loss of recording or edited content (data), and does not guarantee any content if recording or editing does not work properly. Likewise, the above also applies in a case where any type of repair is made to the unit (including any other non-HDD related component).

Supplied accessories

Please check and identify the supplied accessories.

(Product numbers are correct as of March 2016. These may be subject to change.)

Remote control (N2QAYB001078):	1 pc.
Batteries for remote control:	2 pcs.
AC mains lead:	1 pc.
RF coaxial cable:	1 pc.

- Do not use AC mains lead with other equipment.

Insert batteries

Insert so the poles (+ and -) match those in the remote control.

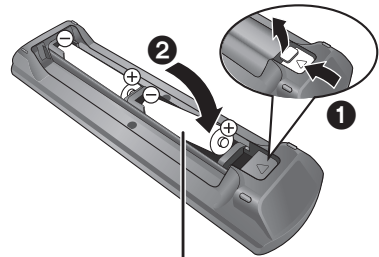

R6/LR6, AA
(Alkaline or manganese batteries)

Table of contents

Safety precautions	2
Supplied accessories	3
Getting started	
Unit care	5
Main unit	6
Remote Control	8
Connection	9
Settings	11
HDD and media information	13
FUNCTION MENU screen	18
Watching broadcasts	
Watching broadcasts	19
Recording	
Recording TV programmes	22
Timer recording	24
Playing back video	
Playing titles on the HDD	28
Playing titles on the media	30
Operation during play	32
Playback menu	34
Editing video	
Deleting/Editing titles	36
Copying video	
Copying titles	40

Photo and Music

Photo	47
Music	50

With Other Equipment

Recording from external equipment	52
Copying the HD Video (AVCHD)	52
Registering the external HDD (USB HDD)	53

Convenient functions

VIERA Link functions	55
Software (Firmware) Update	56
Other operations	57

Setup

Basic Settings	60
----------------------	----

Reference

Troubleshooting guide	67
Specifications	72
Licenses	75
Limited Warranty (ONLY FOR AUSTRALIA)	77
Index	78

About descriptions in these operating instructions

- Pages to be referred to are indicated as "⇄ ○○".
- Images are for illustration purpose, contents may change without notice.

Unit care

HDD/USB HDD handling care

- The HDD is a high precision recording instrument and is easily susceptible to damage. Therefore, be careful of the following points while the unit is turned on, especially during operation, otherwise the HDD and the recorded content may be damaged:
 - Do not subject the unit to any vibration and shock.
 - Do not remove the AC mains lead from the household mains socket.
- **The HDD is a temporary storage device**
 - It is recommended to save the recorded content on a disc or to keep the original data or CDs that they were copied from.
 - If you notice a problem with the HDD such as repetitive strange sounds, immediately save (backup) all content and request service. If you continue using the HDD with a problem, the unit or the recorded content will be damaged.
- **If the HDD or USB HDD is damaged, the recorded content cannot be recovered.**

Setup precautions

- **Do not place on anything that generates heat like a Set Top Box, etc.**
- **Place in an area where condensation does not occur. Conditions where condensation may occur**
 - When there is an extreme change in temperature.

In the above situation, **without turning the unit on**, let the unit adjust to the room temperature and wait 2–3 hours until condensation is gone.

- **The unit may breakdown if cigarette smoke or bug spray/vapour, etc. gets inside the unit.**

When moving the unit

Before moving the unit, ensure the disc tray is empty.

- 1 Switch the unit to standby mode. (Wait until "BYE" disappears from the display.)
- 2 Remove the AC mains lead from the household mains socket.
- 3 Move only after the unit has come to a complete stop (approx. 3 minutes) in order to avoid subjecting to vibration and shock. (Even after the unit is switched to standby mode, the HDD continues operating for a short time.)

Cleaning

- Wipe with a soft, dry cloth.
- Never use alcohol, paint thinner or benzine to clean this unit.
- Before using chemically treated cloth, carefully read the instructions that came with the cloth.
- Use the lens cleaner (not supplied) to clean the unit's lens.

When requesting this unit for repair

The registration of the USB HDD may be cancelled in the process of repairing this unit. You can use the USB HDD again by re-registering, but all recorded content already on the USB HDD will be lost. In such cases, the recorded content (data) cannot be recovered.

To dispose or transfer this unit

This unit may contain private information. Before disposing of or transferring this unit, perform the following to delete the data, including personal or secret information:

- Format HDD (⇒ 62)
- Perform "Shipping Condition" (⇒ 66)

Main unit

Front

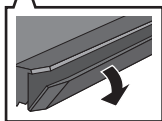
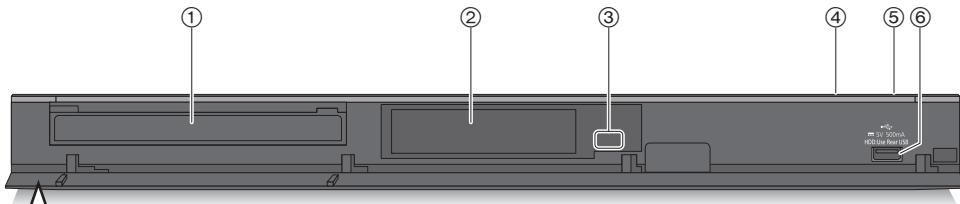

Pull to flip down the front panel.

Getting started

- ① Disc tray
- ② Display (⇒ 7)
- ③ Remote control signal sensor
 - Angle: Approx. 20° up and down, 30° left and right
 - Distance: Within approx. 7 m in front of the unit
- ④ Open/close disc tray
- ⑤ **Standby/on switch** (⏻/⏻)
 - Press to switch the unit from on to standby mode or vice versa. In standby mode, the unit is still consuming a small amount of power.
- ⑥ USB port (≡ DC 5 V 500 mA)

Inserting or removing media

■ Disc

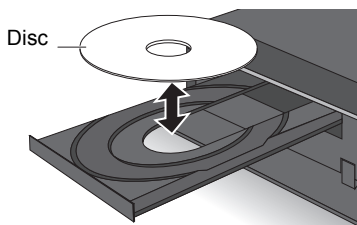

■ USB device

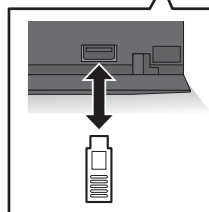

- While writing to/reading from the media, do not switch the unit to standby mode or remove the media. Such action may result in loss of the media contents.
- When inserting the media, ensure that it is facing the right way up.
- The USB port on the front side does not support USB HDDs. Connect a USB HDD to the USB port on the rear side. (⇒ 54, Connecting the USB HDD)

Display

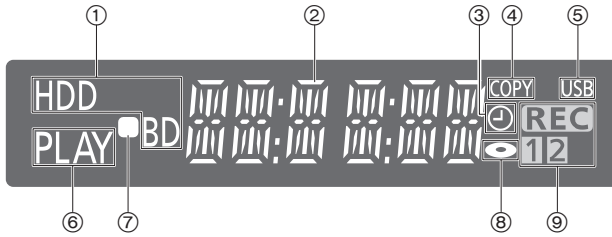

- ① Drive (HDD or BD) indicator
- ② Main display section indicator
 - Messages and other information are displayed. (⇒ 71)
- ③ Timer recording indicator
 - This indicator lights up when the timer recording standby is activated.
- ④ Copying indicator
- ⑤ USB port indicator
- ⑥ Playback indicator
- ⑦ Remote control signal indicator
- ⑧ Disc indicator
- ⑨ Recording indicator
 - “REC” lights up while recording is in progress.
 - “1” flashes when the first timer recording standby is activated or recording is paused, and lights up while recording is in progress. (In the same way as “1”, “2” lights up or flashes for the second recording.)

Rear

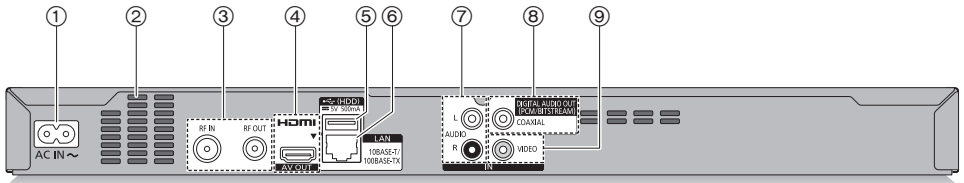

- ① AC IN terminal (~)
 - ② Ventilation hole
 - ③ RF IN/OUT terminal
 - ④ HDMI terminal
 - ⑤ USB port (≡ DC 5 V 500 mA)
 - Connect a USB HDD to this USB port.
 - ⑥ LAN port
 - ⑦ AUDIO IN terminal
 - ⑧ COAXIAL terminal
 - ⑨ VIDEO IN terminal
- Class II equipment (The construction of the product is double-insulated.)

Remote Control

Instructions for operations are generally described using the remote control.

Getting started

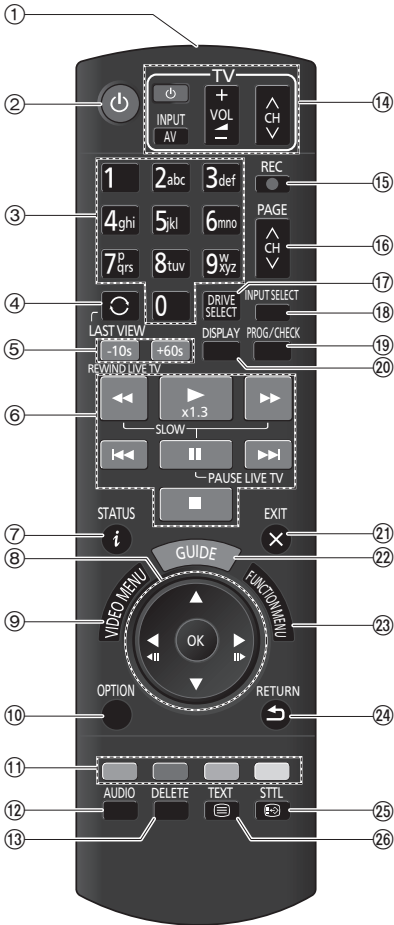

- ① Transmit the remote control signal
 - Point it at remote control signal sensor on this unit. (⇒ 6)
- ② Switch the unit from on to standby mode or vice versa
- ③ Select channels and title numbers, etc./Enter numbers or characters
- ④ Switch to the previously watched channel (⇒ 19)
- ⑤ Manual skip (⇒ 33)
 - 10s: Skip approx. 10 seconds backward
 - +60s: Skip approx. 1 minute forward
- ⑥ Basic operations for recording and play, REWIND LIVE TV/PAUSE LIVE TV (⇒ 21)
- ⑦ Show Information (⇒ 19, 29, 32)
- ⑧ Selection/OK, Frame-by-frame (⇒ 32)
- ⑨ Show Video Menu, Top Menu, Pop-up Menu (⇒ 28, 33)
- ⑩ Show OPTION menu (⇒ 34, 36, 49)
- ⑪ Colour buttons (red, green, yellow, blue) (Use in accordance with instruction on the screen.)
- ⑫ Select audio (⇒ 20, 33)
- ⑬ To delete unwanted recorded titles, timer programmes, video, photo or music (⇒ 36)
- ⑭ TV operation buttons (⇒ 11)
- ⑮ Start recording (⇒ 22, 52)
- ⑯ Channel select (⇒ 19)/Change pages in the Video Menu screen etc.
- ⑰ Select drive (HDD, Disc or USB)
- ⑱ Input select (⇒ 19, 52)
- ⑲ Show the Timer recording screen (⇒ 25)
- ⑳ Show Playback Menu (⇒ 34)
- ㉑ Exit the menu screen
- ㉒ Show the TV Guide screen (⇒ 20)
- ㉓ Show the FUNCTION MENU screen (⇒ 18)
- ㉔ Return to PREVIOUS screen
- ㉕ Show subtitles (⇒ 19, 33)
- ㉖ Show Teletext (⇒ 19)

Connection

3D programmes can be played back when this unit is connected to a 3D compatible TV.

- Before connection, turn off all equipment and read the appropriate operating instructions.
- Use the High Speed HDMI cables. Non-HDMI-compliant cables cannot be utilized.
It is recommended that you use Panasonic's HDMI cable.
When outputting 24p signal, please use HDMI cables 5.0 meters or less.
- When the unit is not to be used for a long time
To save power, unplug it from the household mains socket. This unit consumes a small amount of power, even when the unit is in standby mode. (⇒ 72)

Basic connections

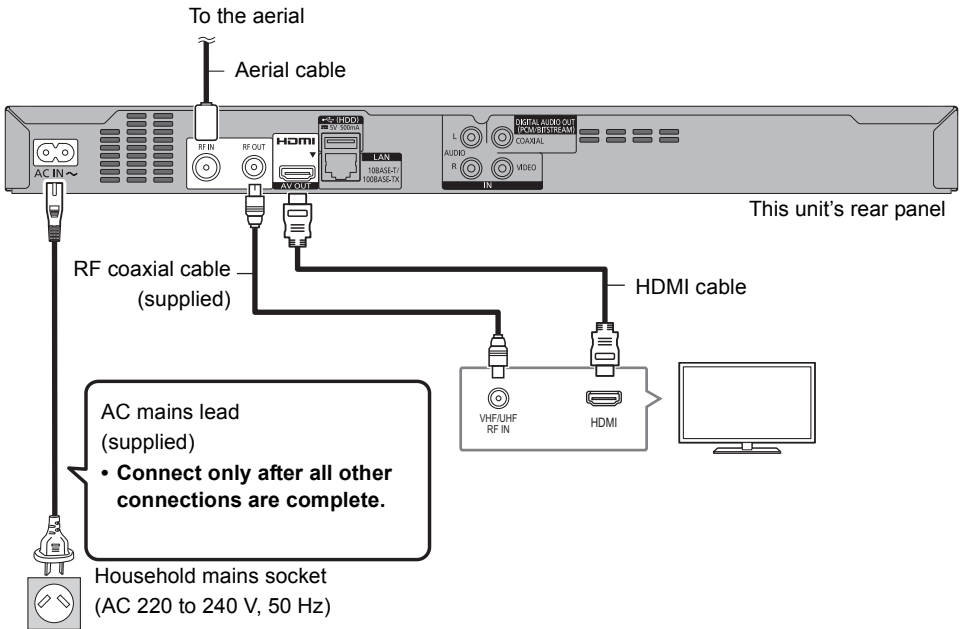

Getting started



- Keep the RF coaxial cables as far away as possible from other cables.

Connect the Set Top Box or video equipment

- Connect to terminals of the same colour.

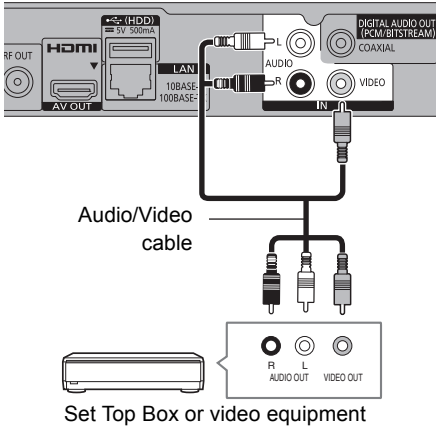

Getting started



- When using a TV or an amplifier/receiver that does not display "ARC" on the HDMI terminal, it is necessary to connect the TV and the amplifier/receiver with a digital audio cable to enjoy the TV audio on the amplifier/receiver.

DIGITAL AUDIO OUT terminal

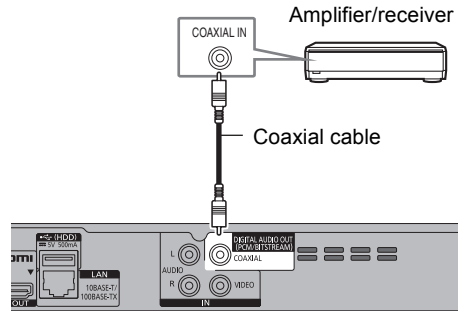

- When you do not want the audio to be output from the TV, set "HDMI Audio Output" to "Off" (⇒ 65).

Amplifier/receiver connections

HDMI terminal

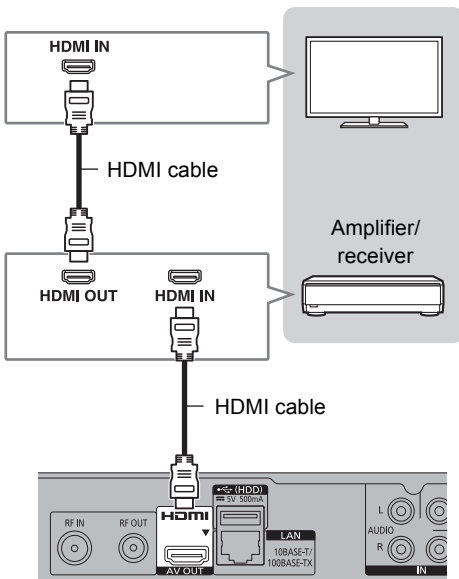

- You will not be able to view 3D programmes with this connection if your amplifier/receiver is not 3D compatible.

Network connection

We recommend that you connect this unit to a network. By doing so, you can:

- Enjoy BD-Live
- Keep this unit up to date at all times through software (firmware) updates (⇒ 56, Software (Firmware) Update)

For details about connection method, refer to the instructions supplied with the connected equipment.

After you make the LAN cable connection, the network setting is needed. (⇒ 12, Easy Network Setting)

LAN cable connection

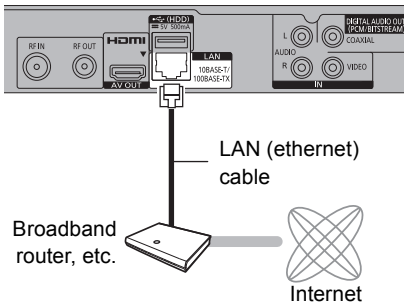

- Use category 5 or above straight LAN cables (STP) when connecting to peripheral devices.

Settings

TV operation buttons

The TV can be operated from the TV operation buttons of the remote control.

- Perform the setting if you cannot operate the TV with the TV operation buttons.

While pressing [TV ⏻], enter the code with the number buttons.

Manufacturer and Code No.

Manufacturer	Code	Manufacturer	Code
Panasonic	01/02/03/04	NEC	36
AIWA	35	NOBLEX	33
AKAI	27/30	NOKIA	25/26/27/60/61
BEKO	05/71/72/73/74	NORDMENDE	10
BENQ	58/59	OLEVIA	45
BRANDT	10/15	ONWA	30/39/70
BUSH	05	ORION	05
CENTREX	66	PEONY	49/69
CURTIS	05	PHILCO	41/48/64
DAEWOO	64/65	PHILIPS	05/06/46
DESMET	05	PHONOLA	05
DUAL	05	PIONEER	37/38
ELEMIS	05	PROVIEW	52
FERGUSON	10/34	PYE	05
FINLUX	61	RADIOLA	05
FISHER	21	SABA	10
FUJITSU	53	SALORA	26
FUNAI	63/67	SAMSUNG	32/42/43/65/68
GOLDSTAR	05/50/51	SANSUI	05
GOODMANS	05	SANYO	21/54/55/56
GRADIENTE	36	SCHNEIDER	05/29/30
GRUNDIG	09	SEG	05/69/75/76/77/78
HITACHI	05/22/23/40/41	SELECO	05/25
IRRADIO	30	SHARP	18
ITT	25	SIEMENS	09
JVC	17/30/39/70	SINUDYNE	05
KDS	52	SONY	08
KOLIN	45	TCL	31/33/66/67/69
KONKA	62	TELEFUNKEN	10/11/12/13/14
LG	05/50/51	TEVION	52
MAG	52	THOMSON	10/15/44
METZ	05/28/79	TOSHIBA	16/57
MITSUBISHI	05/19/20/47	WHITE WESTINGHOUSE	05
MIVAR	24	YAMAHA	18/41



- If your TV brand has more than one code listed, select the one that allows correct operation.
- If the brand of your TV is not listed or the code number is invalid for your TV, this remote control is not compatible with your TV.

Easy Setting

- 1 Turn on the TV, then select the appropriate AV input to suit the connections to this unit.
- 2 Press [⏻] on the remote control or [⏻/|] on this unit.
 - The Easy Setting will start at the initial power on.
- 3 Select the country you live in, and press [OK].
 - **For Australia**
If you select "Australia", the "Region Selection" will appear. Select the region you live in, and press [OK].
 - **For New Zealand**
If you select "New Zealand", a screen asking you to restart this unit will appear. Press [OK] to restart it. Wait until a screen appears again. After the screen appears, Easy Setting resumes.
- 4 Follow the on-screen instructions and perform the settings.

Auto Setup starts.

(This operation may take some time.)

e.g., **For Australia**

Digital TV Auto Tuning			
Progress	CH 6	<input type="text"/>	69
This will take about 3 minutes.			
RF Ch	Channel Name	Type	Quality
35	○○○○	Digital TV	10
35	○○○○	Digital TV	10
Digital TV: 2			
Searching			

- 5 Clock is set automatically.
If the clock setting screen appears, set the time manually. (⇒ 66, Clock)
- 6 Set "Quick Start" to "On", "Off" or "Timer Setting for Quick Start", then press [OK].
For details, refer to "Quick Start". (⇒ 65)
- 7 Select the aspect ratio that matches the connected TV.
For details, refer to "TV Aspect". (⇒ 64)

When "Easy Setting has been completed." appears, Easy Setting is completed.

- Select "Yes" to set network settings.
- Select "No" to finish the Easy Setting.

To stop partway

Press [RETURN ⊖].

To restart setup (⇒ 60, Auto Setup)



- If tuning is cancelled partway through, it may not be possible to receive the channels. Restart setup again.

Easy Network Setting

After Easy Setting is completed, select "Yes". Easy Network Setting will start automatically.













When "Easy Network Setting is finished." appears Press [OK].

HDD and media information





For more details, refer also to the specifications. (⇒ 72)

Recordable/playable contents

(-: Impossible)

Media type	Standard symbol	Recordable contents	Playable contents
Built-in hard disk drive (HDD) 	HDD	<ul style="list-style-type: none"> • Video • AVCHD/AVCHD 3D • MKV • MP4 • MPEG2 	<ul style="list-style-type: none"> • JPEG • MPO (3D photo) • AAC • MP3
External hard disk drive (USB HDD) (⇒ 16) 	USB HDD	<ul style="list-style-type: none"> • Video^{#1} 	<ul style="list-style-type: none"> • AVCHD/AVCHD 3D^{#2, 3} • MKV • MP4 • MPEG2 • JPEG • MPO (3D photo) • AAC • MP3
BD-Video  <i>Blu-ray Disc</i>	 BD-Video	BD-V	<ul style="list-style-type: none"> • Video
BD-RE BD-RE DL  <i>Blu-ray Disc</i>	 BD	BD-RE	<ul style="list-style-type: none"> • Video • AVCHD/AVCHD 3D • JPEG • MPO (3D photo)
BD-R BD-R DL  <i>Blu-ray Disc</i>		BD-R	<ul style="list-style-type: none"> • Video • AVCHD/AVCHD 3D^{#2}
DVD-Video^{#4}  VIDEO	 DVD-Video	DVD-V	<ul style="list-style-type: none"> • Video
DVD-RAM  R A M R A M 4.7	 DVD	RAM	<ul style="list-style-type: none"> • Video • JPEG • MPO (3D photo)
DVD-R DVD-R DL  R R 4.7		DVD-R	<ul style="list-style-type: none"> • Video • AVCHD^{#2}

Getting started

Media type	Standard symbol	Recordable contents	Playable contents
DVD-RW 		DVD-RW	• Video - • AVCHD ^{*2}
+R/+R DL		+R	- • AVCHD ^{*2} • AAC • JPEG • MP3 • MPO (3D photo)
+RW		+RW	• Video - • AVCHD ^{*2}
Audio CD (CD-DA) 		CD	- • Music
CD (including CD-R/RW)		- • MKV • AAC • JPEG • MP3 • MPO (3D photo)	
USB memory 	USB	-	• AVCHD/AVCHD 3D ^{*2,3} • MKV • JPEG • MP4 • MPO • MPEG2 (3D photo) • AAC • MP3

- ※1 It cannot be recorded directly. (Only compatible with copying from the built-in HDD)
- ※2 Recorded with AVCHD format compatible devices (Panasonic video camera, etc.). It may not be able to play back, add, or edit depending on the device.
- ※3 It cannot be played back directly from the USB HDD or USB memory. Playback is possible by copying to the built-in HDD. (⇒ 52)
- ※4 Includes finalised DVD-R, DVD-R DL, DVD-RW, +R and +R DL.



- **+RW** This unit cannot record to 8X Speed +RW disc.
- With certain recording states and folder structures, the play order may differ or playback may not be possible.
- It may not be possible to play the above media in some cases due to the type of media, the condition of the recording, the recording method, and how the files were created.

Information about contents

■ Broadcast Recordings

Numbers of titles that can be recorded:

Media	Maximum titles
HDD	1000
BD-RE, BD-R	200
DVD-RAM, DVD-R, DVD-RW	99
+R, +RW	49

- Maximum numbers of titles are including recordings of HD CAMCORDER.

■ HD CAMCORDER Recordings

MPEG-4 AVC/H.264 (based on AVCHD)

Numbers of titles that can be recorded:

Media	Maximum titles
HDD	1000
BD-RE, BD-R	200

- Maximum numbers of titles are including recordings of Broadcast.

■ Photo files

Compatible pixels:

Between 34×34 and 8192×8192 pixels

Sub sampling: 4:2:2, 4:2:0

(Motion JPEG is not supported.)

Maximum numbers of contents:

Media	Folders	Files
HDD	–	20000
BD-RE, DVD-RAM, DVD-R, +R, CD-R, CD-RW, USB device	500	10000

■ Video files/Audio files

Numbers of contents that can be copied to internal HDD:

Contents	Maximum numbers of folders and files
Video	20000
Audio	20000

USB device:

- Each folder can store up to 1000 files.
- We recommend that you limit the depth of folder trees to about five levels.







About extension of files

Contents	Example of file extension
MKV	“.mkv”
MKV (Subtitle text files)	“.srt” “.sub” “.txt”
MP4	“.mp4” “.mov”
MPEG2	“.mpg” “.mpeg” “.m2ts” “.mts” “.ts”
JPEG	“.jpg”
MPO	“.mpo”
AAC	“.m4a”
MP3	“.mp3”



- The video file and subtitle text files are inside the same folder, and the file names are the same except for the file extensions.
- Some files may not be played back even if they have these extensions.

Recording mode (Conversion)

Recording Mode	DR	HG/HX/HE/HL/HM	XP/SP/LP/EP/FR* ¹
Feature	Programmes can be recorded in a nearly perfect broadcasted state.	Recording can be done with reduced recording volume in High definition (HD) quality* ² .	Recording can be done with reduced recording volume in Standard definition (SD) quality.
Recordable media	  	   	
Multiple audio, Audio Description * ³	Record all multiple audio	Record only one audio* ⁴	
Subtitles	Can be recorded	Can be recorded (only one subtitle)* ⁵	
Surround audio	Surround audio as the broadcast	Stereo audio	

Getting started

*¹ FR (Flexible Recording Mode):

The unit automatically selects the best possible recording rate between XP mode and EP mode.

*² The SD quality programme cannot be converted to HD quality.

*³ **For New Zealand**

*⁴ You cannot select during play whether it activates or deactivates.

*⁵ You cannot select during play whether it appears or disappears.

Approximate recording times

Refer to "Recording modes and approximate recording times". (⇒ 72)

Notes

Notes for the USB device

You can use an external HDD (USB HDD) in the following two ways (A single HDD cannot handle those two ways simultaneously.), and a USB memory for data files.

• For recorded titles

Moving titles in the built-in HDD to a USB HDD to save the capacity of the built-in HDD.

- The USB HDD must first be registered on this unit. (⇒ 53)
- The USB HDD over 3 TB is not usable.

• For data files

Playing back MP4, JPEG, MP3, etc. in a USB device with this unit.

- The USB device must be formatted in FAT12, FAT16, FAT32 or NTFS file system.
- The USB device over 2 TB is not usable.



- This unit supports USB 2.0 High Speed.
- This unit can use USB 3.0 devices as USB 2.0 devices.
- This unit does not recognize USB HDDs other than those in which the size of one sector is 512-bytes or 4096-bytes. (For details, consult the dealer of your USB HDD.)
- This unit supports USB mass storage device class.
- This unit does not guarantee connection with all USB devices.

• Region management information

The unit can play back BD-Video/DVD-Video discs of the following regions codes, including "ALL":

e.g., BD-Video DVD-Video



• Disc recorded on another device

- It may be necessary to finalise the disc, create Top Menu or close the session on the equipment used for recording to play on this unit.
- **[DVD-RW]** Recorded in DVD Video Recording (DVD-VR) format
 - This unit can play back and copy to HDD.
 - This unit does not support editing or recording.
 - It is possible to record and edit with DVD-Video (DVD-V) format by formatting discs with this unit.
- Recording may not be possible to discs which were used for recording on other equipment.

• Play on other players

- **[BD-RE]** **[BD-R]** When these discs cannot be played back on other Blu-ray Disc players, etc. (e.g., title recorded with HE-AAC audio format), convert the recording mode to play them back. (⇒ 37, File Conversion)
- **[DVD-R]** **[DVD-RW]** **[+R]** Finalisation is needed. (⇒ 58)
- **[+RW]** If the disc failed to play on other equipment, we recommend you create a Top Menu. (⇒ 58)
- **[DVD-R]** The disc created in AVCHD format can only be played back on AVCHD compatible equipment.

• Regarding 8 cm Disc

This unit cannot record or edit the 8 cm disc. Only playback or copy to the HDD is possible.

• Discs that cannot be played

- DVD-RAM in a cartridge
- 2.6 and 5.2 GB DVD-RAM, 12 cm
- DVD-Audio
- Super Video CD, Super Audio CD, Video CD

- Wipe with a damp cloth and then wipe dry.



- Do not attach labels or stickers to discs.
- Do not use disc cleaning sprays, benzene, thinner, static electricity prevention liquids or any other solvent.
- Do not use the following discs:
 - Discs with exposed adhesive from removed stickers or labels (rental discs, etc.).
 - Discs that are badly warped or cracked.
 - Irregularly shaped discs, such as heart shapes.



- Operation and sound quality of CDs that do not conform to CD-DA specifications (copy control CDs, etc.) cannot be guaranteed.

FUNCTION MENU screen

You can easily access the desired functions, such as playback, timer recording, the unit's settings etc. via the FUNCTION MENU.

1 Press [FUNCTION MENU].

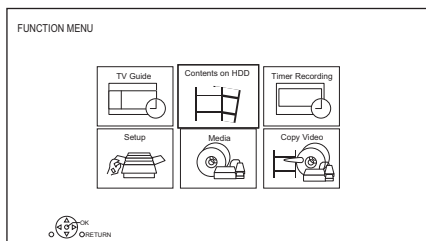

2 Select the item, then press [OK].

FUNCTION MENU list

- **TV Guide** (⇒ 20)
- **Contents on HDD**
 - Recorded Programmes (⇒ 28)
 - Video (AVCHD) (⇒ 28)
 - Video (MP4 / MKV) (⇒ 30)
 - Photo (⇒ 47)
 - Music (⇒ 51)
- **Timer Recording** (⇒ 25)
- **Setup**
 - Basic Settings (⇒ 60)
 - You can change the unit's settings of Digital TV Tuning, Sound, Display, Connection, Network etc.
 - Wallpaper
 - Personalise a background of the FUNCTION MENU.
 - To select from among "Photo", register photo in advance. (⇒ 47)
 - BD-Video Data Management (⇒ 31)
- **Media**
 - Disc
 - USB device
 - USB HDD
- **Copy Video**
 - Copy Menu (⇒ 42)
 - Copy Video (AVCHD) to DVD-R (⇒ 46)

Watching broadcasts

1 Press [INPUT SELECT] and select "TV", then press [OK].

2 Press [CH ^ v] to select the channel.

- You can also select the channel by the following operations
 - Using number buttons.
 - Using Channel Information (⇒ below)
 - Using TV Guide system (⇒ 20)
 - Using Channel List (⇒ 21)

To switch to the channel you have previously watched

Press [LAST VIEW].

- This function will work only for the channels you have watched for more than 10 seconds.

If this unit requests a PIN

If you have set a ratings level (⇒ 61, Child Lock (Parental Rating)), you may be asked to enter the PIN. In that case, enter the 4-digit PIN with the number buttons by following the on-screen instructions.

- **Make a note of the PIN you have decided on in case you forget it.**
- PIN can be changed via "PIN Entry". (⇒ 66)

Using Channel Information

While watching a programme
Press [STATUS].

Channel Information appears.

e.g.,

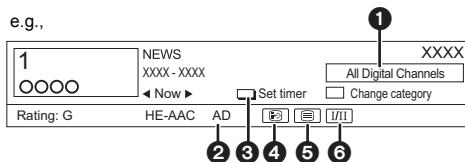

- 1 Current Category
- 2 Audio Description
- 3 Set timer (⇒ 26)
- 4 Subtitle
- 5 Teletext
- 6 Multiple audio

To show detailed information

Press [STATUS] again.

To hide the information screen

Press [EXIT].

To change Category

Press the blue button.

- To register your favourite channels (⇒ 60)

To switch between the current programme and the next programme

Press [,].

To switch to another channel

Press [, , then press [OK].

To show subtitle

When "" appears in Channel Information

Press [STTL].

- Press again to hide subtitle.

To show Teletext

When "" appears in Channel Information

- 1 Press [TEXT].
- 2 Use [, , , , number buttons or colour buttons, etc. according to on-screen instructions.



- You can change the display mode. (⇒ 64, Teletext)

Switching audio

Press [AUDIO].

- Audio will switch according to the contents of the programme every time it is pressed.

For New Zealand

To listen to the Audio Description

When "AD" appears in Channel Information (⇒ 19)

Audio Description adds an additional soundtrack to describe events on screen (narration) and aids understanding and enjoyment, particularly for visually-impaired viewers.

Press [AUDIO] to select the soundtrack of Audio Description.



- If "Audio Description" is set to "Automatic", Audio Description will be given priority when watching, if available. (⇒ 61)

Aspect

You can switch the aspect ratio of the screen mode. (⇒ 59)

Using TV Guide system

- 1 Press [GUIDE].
TV Guide screen appears.

e.g. Landscape view

For Australia

TV Guide		Landscape				TUE 05.01.2016		XXXXXX		Category: All Digital Channels	
		XXXXXX - XXXXX		Skillful workman						④	
TUE 05.01	XXXXXX	XXXXXX	XXXXXX	XXXXXX	XXXXXX	XXXXXX	XXXXXX	XXXXXX	XXXXXX	XXXXXX	Ⓛ
1	○○○○	Skillful workman			Penguin						
2	○○○○	Kitten	House dog		Will						
3	○○○○	Vacation	Hunting								
4	○○○○	Pampas grass	News		Top run						
5	○○○○	News	Com	Shopping	Area 91						
6	○○○○	Venus	Moon								
7	○○○○	Construction	Hippopotamus								
8	○○○○	Great river	Mr, Otter	Dodge							

OK
OPTION RETURN Portrait/Landscape Information Page Up Page Down
Timer Rec. +24 hours Search / Select

- 2 Select the programme, then press [OK].
- 3 Select "View", then press [OK].

To change TV Guide view

Press [GUIDE] to switch between "Landscape" view and "Portrait" view.

Page up/down

Press [CH ^ v].

To view a programme list for another day

Press the green button (Previous) or the yellow button (Next).

To see programme information

Press [STATUS ④].

To set a timer Recording using the TV Guide System

Refer to "Timer recording". (⇒ 24)

To search the programmes (⇒ 25)



- Selection of channel is made easy by creating a Favourite of the channels you watch often. (⇒ 60, Favourites Edit)

Using Channel List

You can select from the list of channel names.

- 1 Press [OK].

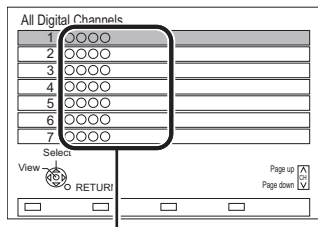

Channel names

- 2 Select the channel, then press [OK].

To edit the channel list

Refer to "Channel List". (→ 60)

REWIND LIVE TV/PAUSE LIVE TV

This unit temporarily saves a live TV programme you are watching with this unit's tuner on HDD.

REWIND LIVE TV

You can rewind live TV programme to the point where temporary save has started (up to 1.5 hours).

- REWIND LIVE TV does not work when watching a programme via external input.

PAUSE LIVE TV

You can pause live TV programme and restart watching from the paused position.

- 1 While watching TV

REWIND LIVE TV:

Press [◀◀] to rewind.

PAUSE LIVE TV:

Press [⏸] to pause.

- The maximum amount of the temporary save is 1.5 hours.

- 2 When you want to resume:

Press [▶ × 1.3].

- You can perform search or Quick View, etc.
- If temporary save stops, playback will be performed by that point.

Display information

While pausing or rewinding a broadcast:

Press [STATUS ⓘ].

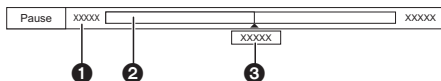

- Press [STATUS ⓘ] again.

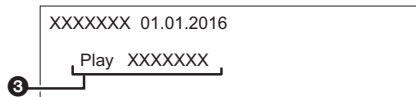

While pausing a programme via external input:

Press [STATUS ⓘ] twice.

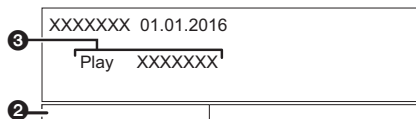

- 1 The time that you can rewind the live programme.

- 2 The amount of time temporarily saved on HDD.

- 3 The time of the current playback position.

To stop REWIND LIVE TV or PAUSE LIVE TV

- 1 Press [■].
- 2 Select "Yes", then press [OK].

To hide the display information

Press [EXIT ⊗].



- Temporary save stops in the following cases:

- When switching to other channels or other screen
- When the unit has started recording using all tuners
- When performing PAUSE LIVE TV or REWIND LIVE TV for more than 8 hours (This may vary depending on the HDD free space.)

- These functions do not work in the following cases:

- When the clock is not set
- When all tuners are being used to record programmes
- While copying
- While watching a programme being recorded
- When a radio programme is selected

Recording TV programmes



- This unit can record two programmes being broadcasted at the same time.

Preparation

If you want to change the recording mode (⇒ right)

- 1 Select the channel to record.**
- 2 Press [REC ●].**
Recording will start.
- 3 Select “Automatic Stop”, then press [OK].**
 - **One touch recording (OTR)**
Recording stops automatically when the programme ends.

e.g., [For Australia]

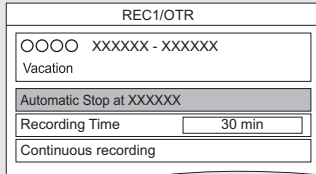

Recording



- If a timer recording reaches its start time when all tuners are being used for recording, the recording (OTR) of one of the programmes terminates.
- Teletext will not be recorded.
- Following contents or media cannot be played back while recording.
 - 3D video
 - video file
 - photo
 - USB HDD (For data files, ⇒ 16) and USB memory
- Copying cannot be performed while recording.
- When “Automatic Standby after OTR” is set to “On” (⇒ 65), this unit is turned to standby mode if this unit is not operated for approximately 5 minutes after completing “Automatic Stop” or “Recording Time”.

To set the recording time

- 1 Select “Recording Time” or “Continuous recording” in step 3 (⇒ above).

Recording Time:

You can set the length of recording time from 30 minutes to 4 hours.

- You can select the recording time with [◀, ▶].

- 2 Press [OK].

To change the recording (conversion) mode

This unit will record the programmes in DR mode once, and then automatically convert to the selected recording mode while this unit is in standby.

- 1 Press [OPTION].
- 2 Select “Recording Mode”.
- 3 Select the recording mode, then press [OK].
 - Recording mode (Conversion) (⇒ 16)

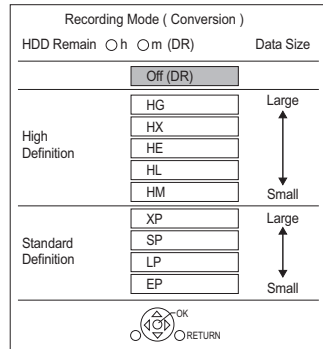

- The recording mode set here is used as an initial value for the next recording.

To convert the recording mode after recording in DR mode (⇒ 37, File Conversion)

To confirm whether the conversion is completed (⇒ 38)

To cancel a conversion (⇒ 38)



- The title before conversion (the title recorded in DR mode) will be deleted once the conversion is completed.
- Conversion will take about the same time as the recorded duration.
- When the HDD does not have enough remaining space, conversion will not start.
- Conversion is stopped when this unit is turned on. Conversion will start from the beginning again once the unit is switched to standby mode.
- When converted, audio content, subtitle and Audio Description [For New Zealand] will be converted with the same settings as at the start of recording.

Operation during Recording

To check the recording programme

Press [STATUS ①].

e.g., While recording two programmes simultaneously

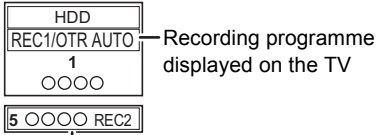

To stop recording

Press [■].

When recording one programme:

If the following screen appears

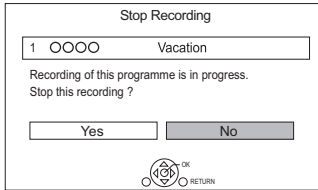

Select "Yes", then press [OK].

When recording two programmes:

Following screen appears

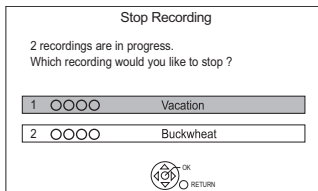

- 1 Select the programme, then press [OK].
- 2 Select "Yes", then press [OK].

To pause recording

After displaying the recording programme, press [II].

- Press again to restart recording.
(A title is not split into separate titles.)



- Timer recording programme cannot be paused.

To record two programmes simultaneously

While recording, perform steps 1–3 on page 22.



- Channel or input can only be switched between the recording programmes.

Simultaneous rec and play

You can play the recording title from the beginning or the titles previously recorded to the HDD.

- 1 Press [VIDEO MENU].

Channel	Date	Title Name
○○○○	04.10	Birds
○○○○	04.10	World news
○○○○	29.10	Foot ball
○○○○	29.10	Dogs and Cats

Start Time XXXXX Rec time 0:01
Prog.Type: XXXX

"●" (red) is displayed on the recording programme.

- 2 Select the title, then press [OK].

Timer recording



- You can enter up to 32 programmes within a month in advance. (Each daily, weekly or series programme is counted as one programme.)
- This unit can record two programmes being broadcasted at the same time.

Preparation

If you want to change the recording mode (⇒ 22)

- 1 Press [GUIDE].**
TV Guide screen appears.
- 2 Select the programme, then press the red button.**
The timer icon “⊖” (red) is displayed.
 - If on-screen instructions are displayed, follow them.



- Some broadcasters may not send programme information. When programme information is not displayed correctly, use manual timer recording. (⇒ 25)
- The receipt of the TV Guide data via Set Top Box is not possible.
- When timer recording from the external equipment, use manual timer recording. (⇒ 25)
- You can set the start and finish time to make the timer recording work successfully. (⇒ 62, Timer Record Start Buffer, Timer Record Stop Buffer)

To use TV Guide system (⇒ 20)

Operation during Recording (⇒ 23)

To edit the timer programme (⇒ 27)

If the screen for selecting single or series timer recording appears

Select “Single Timer Rec.” or “Series Timer Rec.” (⇒ 25), then press [OK].

To edit the timer recording on the TV Guide screen

- 1 Select the programme to edit, then press the red button.
- 2 Select “Timer Rec Edit”, then press [OK].
- 3 Go to step 3 on page 25, “Manually programming timer recording”.

To cancel a timer recording on the TV Guide screen

- 1 Select the programme to cancel, then press the red button.
- 2 Select “Timer Rec Cancel”, then press [OK]. (“⊖” disappears.)

If “Overlapped Timer Recording” screen appears

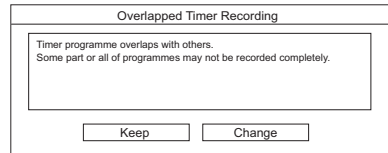

You can eliminate the overlapping or may change with repeat event for the duplicated programme.

- 1 Select “Change”, then press [OK].
- 2 Follow the on-screen instructions.

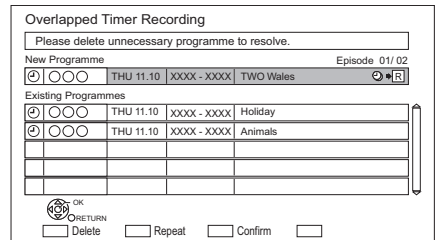

- The overlapped programmes are displayed with if their repeat programmes (the same programmes broadcast at different times) are available for timer recording.

Red: Delete programme

Green: Record repeat programme

Yellow: Exit (Overlapping is not resolved)

To search the programmes

- 1 On the TV Guide screen:
Press the blue button.
- 2 Select the item, then press [OK].

Keyword Search

Displays programmes including the input keyword.

- Refer to “Entering text”. (⇒ 58)

Prog.Type Search

Displays programmes of the selected type.

If, for example, you select “Arts/Culture”, only the programmes related to arts and culture are displayed. Use this search function to find the programme you want to watch quicker.

- Select the programme type, then press [OK].

Category Selection

Displays channels in the selected category. (Radio etc.) You can find the programme you want to watch quicker by narrowing down the channels to be displayed.

- To return to the previous TV Guide list
Select “All Digital Channels”.

- 3 Select the programme, then press the red button for timer recording.



- Category may not be assigned correctly depending on the programme information.

Various functions with TV Guide

This unit has several functions that enable timer recordings to be controlled by the signal sent from the broadcaster.

Guide Link

The recording's start and stop times can be controlled by the broadcaster, e.g. delayed start.

- The Guide Link function may not work if you manually change the start time or the stop time over 10 minutes.
- **For Australia** To use this function, set “Guide Link” to “ON”. (⇒ 26)

Series Timer Recording

You can record all the episodes of a series by setting just one timer recording.

For New Zealand Split Programme

You can record a programme separated into two or more parts by some other programmes, e.g. news.



- If the signal is not sent correctly, the recording may lack the beginning or the ending part of the programmes.
- If the same episode has already been set for series timer recording at a different time or on another channel (Repeat programmes), “Series Timer Rec.” will not be selectable.
- Titles recorded using “Series Timer Rec.” are bundled and displayed as a “group” in the Video Menu screen (⇒ 28).
- The series recording will be cancelled if there has been no episode of the series for 13 weeks.

Manually programming timer recording

- 1 Press [PROG/CHECK].

Channel Name	Schedule	Mode	Space
New Timer Programme			

Timer Recording HDD 30:30 DR TUE 05.01.2016 XXXXX

Total 0:02 Turn Off DELETE Delete Resolve overlap Info Page Up Page Down

- 2 Select “New Timer Programme”, then press [OK].

- 3 Select the items and change the items. (⇒ 26, Timer recording options)

- 4 Press [OK].
The timer programme is stored.

Channel Name	Schedule	Mode	Space

Timer Recording HDD 30:30 DR TUE 05.01.2016 XXXXX

Channel Name Schedule Mode Space

Programme Name SAT 16:01 DR OK

XXXXXXXX - XXXXX

New Timer Programme

To confirm and edit the timer programme (⇒ 27)

Operation during Recording (⇒ 23)



- When recording from the external equipment, “Mode” (recording mode) is XP, SP, LP, EP or FR.

Timer recording options

Select the items and change the settings.

e.g., **For Australia**

Channel	Day/Date	Start	Stop	Mode	Conv.	Subtitles
1	TUE 01.01	XXXXX	XXXXX	DR	OFF	OFF

Channel

You can select Category/AV with the red button.

Day/Date

You can select "Date" or "Weekly" by pressing the green button.

Auto Renewal Recording

(Only daily/weekly/series timer recording)

The unit will record the new programme over the old one.

Press the yellow button.

"Renew : ON" is displayed.

Start/Stop

Press and hold [▲, ▼] to alter in 15-minute increments.

Mode/Conv.

Refer to "To change the recording (conversion) mode". (⇒ 22)

Subtitles

You can choose whether or not to record the subtitle at conversion.

(Only when item other than "OFF" is selected in "Conv.")

Title Name

1 Select "Title Name", then press [OK].

2 Refer to "Entering text". (⇒ 58)

For Australia To use Guide Link

You can choose whether or not to use the Guide Link function by pressing the blue button.

Timer recording from Channel Information

You can make timer recording of the current or next programme.

- 1 While watching a programme
Press [STATUS Ⓢ].

e.g.,

1	NEWS	XXXX	XXXX	XXXX
○○○○	← Now →	Set timer	Change category	
Rating: G	Dolby D	AD	Dolby D	AD

- 2 Display the Channel Information of a programme to record.
 - Switch the programme with [◀, ▶].
- 3 Press the yellow button.
- 4 Go to step 3 on page 25, "Manually programming timer recording".

Notes on timer recording

- When you programme successive timer recordings to start, about last 1 minute of earlier programme will not be recorded.
- Timer recording will not start while:
 - copying a title in high speed mode [with finalising or creating Top Menu (+RW)]
 - copying a title in normal speed mode
 - copying HD Video (AVCHD) from USB device
 - converting a title in "File Conversion" (Only when "Now" is selected)
 - copying video/photos/music files
 - formatting
 - finalising/creating Top Menu
- When recording except in DR mode, the audio content etc. will be selected according to the following settings:
 - "Audio Type for Digital Broadcast" (⇒ 64)
 - **For New Zealand** "Multi Audio", "Subtitles" of "Preferred Language" (⇒ 61)
 - **For New Zealand** "Audio Description" (⇒ 61)

To confirm and edit a timer programme

1 Press [PROG/CHECK].

e.g.,

Timer Recording		HDD 30:30 DR	TUE 05.01.2016 XXXXXX
Channel Name	Schedule	Mode	Space
○○○○ World news	TUE 12.01 XXXXXX-XXXXXX	DR	OK
○○○○ Football	TUE 12.01 XXXXXX-XXXXXX	→HG	OK
○○○○ Star	TUE 12.01 XXXXXX-XXXXXX	DR	⊗ !
○○○○ Dogs and cats	TUE 12.01 XXXXXX-XXXXXX	DR	⊗
New Timer Programme			
Total 3/32			
OK RETURN	Turn Timer Off	DELETE Delete Resolve overlap	Info Page Up Page Down

2 Select the programme, then perform the operations.

- Red:
 - Deactivate a timer programme
 - The timer icon “⊗” will change from red to grey.
 - Press the red button again to activate timer recording standby. (The timer icon “⊗” will change to red.)
- Green:
 - Resolve an overlap timer programme
 - The overlapped timer recording list will appear. (⇒ 24)
- [DELETE]: Delete a timer programme
- [STATUS ⊕]: Show programme information

To edit a timer programme

- 1 Press [OK].
- 2 Change the timer recording options.
 - Refer to “Timer recording options”. (⇒ 26)
- 3 Press [OK].

To exit the timer recording list

Press [EXIT ⊗].

Screen icons

	Red: Timer recording standby is activated.
	Grey: Timer recording standby is deactivated.
	Currently recording programme
	A part or all of the programme will not be recorded since the programme is overlapping.
	The HDD is full.
	Copy-protected programme It was not recorded.
	The recording of the programme was not completed because of some reason.
	Auto Renewal Recording is set. (⇒ 26)
	Guide Link (⇒ 26)
	Series Timer Recording (⇒ 25)
OK	Displayed if the recording can fit in the remaining space
--> (Date)	Daily or weekly timer programme is set. <ul style="list-style-type: none"> • The timer remains active until the date indicated below -->.
	It may not be possible to record because: <ul style="list-style-type: none"> - there is not enough space left. - the number of possible titles has reached its maximum. (⇒ 15) - programmes are deactivated, etc.
	For New Zealand Split Programme (⇒ 25)

Playing titles on the HDD



* "For recorded titles (⇒ 16)" only

- 1** Press [FUNCTION MENU].
- 2** Select "Contents on HDD", then press [OK].

e.g.,



- 3** To play recorded titles: Select "Recorded Programmes", then press [OK].
The Video Menu screen appears (⇒ right).

To play HD Video (AVCHD):
Select "Video (AVCHD)", then press [OK].

The AVCHD tab appears on the Video Menu screen (⇒ right).

To play video files:
Select "Video (MP4 / MKV)", then press [OK].

The video list screen appears (⇒ 30).

- 4** Select the title, then press [OK].

Video Menu screen

e.g.,

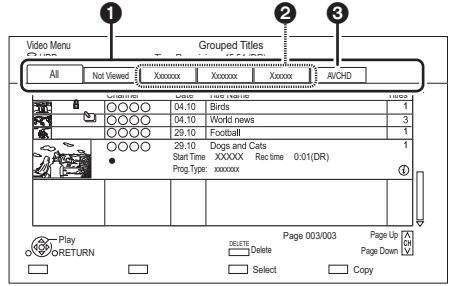

- 1** Tab (⇒ 29)
- 2** Programme type
- 3** AVCHD tab







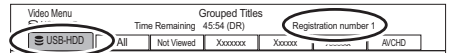







USB HDD

When connecting registered USB HDD, "USB HDD" tab and registration number appears. Select "USB HDD" tab.

e.g.,



Screen icons

	Currently recording programme
(Red)	
	Protected title
	Title was not recorded due to recording protection
×	Title cannot be played (When data is damaged etc.)
	Grouped titles
	Title has not yet been played
(Blue)	
	Title is recorded using a different encoding system from that of the unit.
	Change the "TV System" (⇒ 64).
	Radio programme
	3D contents
	Recorded in 1080/50p contents*
	Recorded in 1080/60p contents*
	Title is restricted by Child Lock (Parental Rating) (⇒ 61).
	Title has been recorded in Series timer recording.
	Title has been recorded in Series timer recording and has not yet been played.
	Recording did not complete as the timer recording has started.

*The contents are played back in 1080i.

Tab

You can quickly find the recorded titles by selecting the tab.

To select the tab

Press [◀, ▶].

To change the displayed programme type tab

- 1 Select the programme type, then press the green button.
- 2 Select the item, then press [OK].

Showing Information

Select the title, then press [STATUS ⓘ].

Showing grouped title

- 1 Press [OPTION].
- 2 Select "Grouped Titles" or "All Titles", then press [OK].

Grouped Titles:

- Two or more titles recorded in the daily/weekly/series timer recording mode are bundled and displayed as one item.

All Titles

Playing back grouped titles

- 1 On the Grouped Titles screen:
Select the item marked with .
- 2 **When playing all titles:**
Press [▶ × 1.3].

When playing the individual title:

Press [OK] and select the title, then press [OK].

Editing the grouped titles

- 1 Select the title or the group, then press the yellow button.
 - A check mark is displayed. Repeat this step.
 - Press the yellow button again to cancel.
- 2 Press [OPTION].
- 3 Select the item, then press [OK].

Create Group:

Selected titles are bundled to form a group.

Release Grouping:

All the titles in the group are released.

Remove:

Selected titles are removed from the group.

Playback from Chapter View

- 1 Select the title, then press [OPTION].
- 2 Select "Chapter View", then press [OK].
e.g., **HDD**

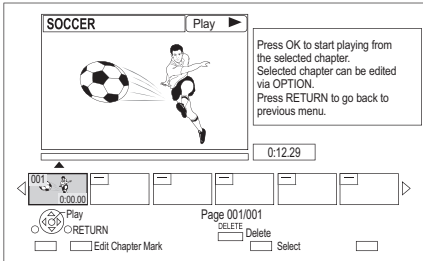

- 3 Select the chapter, then press [OK].

To edit the chapter in Chapter View

Refer to "Editing chapters". (⇒ 39)

Playing titles on the media



* "For data files (⇒ 16)" only

- 1 **Insert the media.**
 - AVCHD: If the menu screen is not displayed Press **[▶ × 1.3]**.
- 2 When the Video Menu screen or menu screen etc., appears:
 - **Select the item or title, then press [OK].**
 - Repeat this step if necessary.

To play back the playlist created on other equipment

- 1 Press [FUNCTION MENU].
- 2 Select "Disc" in "Media", then press [OK].
- 3 Select "Playlists", then press [OK].
- 4 Select the playlist, then press [OK].

Playing back video

Video list screen

e.g.,

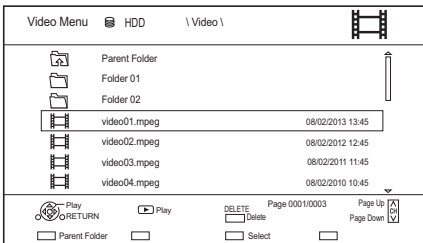

Screen icons



Folder



Titles



Move to the parent folder

Menu screen

Selecting screen for each operation is displayed when the media is inserted, and you can access the operation screen easily.

e.g., **USB**

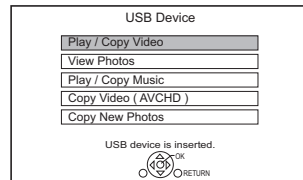

- Display items differ depending on what is recorded in each media.

If the menu screen is not displayed, display it by performing the following operation.

- 1 While stopped
Press [FUNCTION MENU].
- 2 Select "Media", then press [OK].
- 3 Select the media, then press [OK].

Video list screen

e.g.,

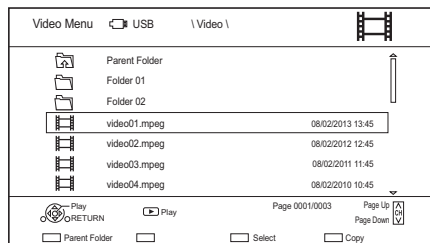

About screen icons

Refer to "Screen icons". (⇒ 30)

Video Menu screen

e.g.,

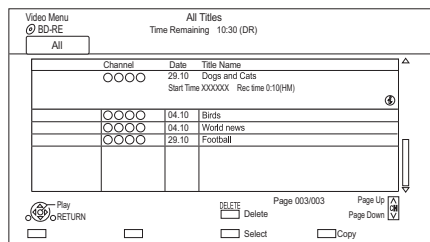

Showing Information

Select the title, then press [STATUS ⓘ].

Playback from Chapter View (⇒ 30)

Notes for BD-Live discs

BD-V

BD-Live allows you to enjoy more functions such as subtitles, exclusive images and online games.

Preparation

- 1 Perform network connection and settings.
(⇒ 11, 12)
- 2 Insert a disc.

For the playback method, refer to the instructions for the disc.

Delete BD-Video data

If you no longer need BD-Live data recorded on the built-in HDD, you can delete data with the following operation.

- 1 Press [FUNCTION MENU].
- 2 Select "BD-Video Data Management" in "Setup", then press [OK].
- 3 Select "Delete BD-Video data", then press [OK].
- 4 Select "Yes", then press [OK].
- 5 Select "Start", then press [OK].
- 6 Press [OK].



- You can restrict Internet access when BD-Live functions are used (⇒ 61, BD-Live).

Operation during play



- Discs continue to rotate while menus are displayed. Press [■] when you have finished playback to protect the unit's motor, your TV screen, etc.

General operations

Status messages

Press [STATUS Ⓢ] twice.

e.g.,

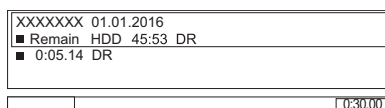

Stop

Press [■].

Resume play function

Press [▶ × 1.3] to restart from the stopped position.



- Discs:** Only previous stopped position is memorised. The position may be cleared if the tray is opened or the unit is switched to standby mode.

Quick View

Press and hold [▶ × 1.3].

- Press again to return to normal speed.



- MKV, MP4 and MPEG2:** Quick View is not effective.
- Quick View is not effective when playing back the DVD-RW disc.
- Quick View may not work when recording in XP or FR mode.

Search

Press [◀◀] or [▶▶].

- Press [▶ × 1.3] to restart play.



- The speed increases up to 5 steps.
(+R +RW): Up to 3 steps)
- MKV, MP4 and MPEG2:** Audio is not heard during all levels search.

Pause

Press [||].

- Press [▶ × 1.3] to restart play.

Slow-motion

While paused, press [◀◀] or [▶▶].

- Press [▶ × 1.3] to restart play.



- The speed increases up to 5 steps.
- MKV, MP4 and MPEG2:** Slow-motion is not effective.
- BD-V, AVCHD (DVD-R):** Forward direction [▶▶] only.

Frame-by-frame

While paused, press [◀] (◀◀) or [▶] (▶▶).

- Each press shows the next frame.
- Press and hold to change in succession forward or backward.
- Press [▶ × 1.3] to restart play.



- MKV, MP4 and MPEG2:** Frame-by-frame is not effective.
- BD-V, AVCHD (DVD-R):** Forward direction [▶] (▶▶) only.

Manual Skip

Skip forward 1 minute:

Press [+60s].

Skip backward 10 seconds:

Press [-10s].



- Depending on the content that you play back, this function is not available.
- **For New Zealand** This function does not work for titles containing recorded broadcasts.

To display menu

BD-V **DVD-V**

- 1 Press [OPTION].
- 2 Select "Playback Menu", then press [OK].
- 3 Select "Top Menu", "Pop-up Menu" or "Menu", then press [OK].

Skipping the title or chapter

Press [**◀◀**] or [**▶▶**].



- **HDD** **USB HDD** (For recorded titles, ⇒ 16): It will not skip the title. But the title in the grouped titles will be skipped. (⇒ 29)

Changing audio

Press [AUDIO].

- It will switch depending on the contents recorded every time it is pressed.
- **For New Zealand** If "Audio Description" is set to "Automatic", Audio Description will be given priority when playing, if available. (⇒ 61)

Switching subtitles

HDD **USB HDD** (For recorded titles, ⇒ 16)

BD-RE **BD-R**

- 1 Press [STTL].
 - 2 Press [OK].
 - 3 Select "On" or "Off", then press [OK].
- If you want to switch the subtitle language, select it in the Basic Operation menu (⇒ 35).

BD-V **DVD-V**, **MKV**:

Display with "Subtitle Settings" in the Basic Operation menu (⇒ 35).

Aspect

You can switch the aspect ratio of the screen. (⇒ 59)

3D video playback

Preparation

Connect 3D compatible TV to this unit. (⇒ 9)

- Perform the necessary preparations for the TV.

Play back following the instructions displayed on the screen.

Preparatory 3D settings

3D BD-Video Playback

It is also possible to play back 3D discs in 2D (conventional video). (⇒ 61)

3D Type

If 3D video cannot be played back in 3D, you may be able to play it in 3D by changing the setting. (⇒ 64)

3D AVCHD Output

If 2D AVCHD video is recognised as 3D video and cannot be played back correctly, you may be able to play it by changing the setting. (⇒ 64)

3D Playback Message

Hide the 3D viewing warning screen. (⇒ 64)

3D settings during playback

Change this setting when the screen is not correctly displayed for 3D compatible programmes.

- 1 Press [DISPLAY].
- 2 Select "3D Settings", then press [OK].
- 3 Select the item, then press [OK].

Signal Format

- Original:
Keep original picture format.
- Side by side:
3D picture format comprising of left and right screens.

Graphic Display Level

Adjust the 3D position for the playback menu or message screen etc.



- Please refrain from viewing 3D images if you do not feel well or are experiencing visual fatigue. In the event that you experience dizziness, nausea, or other discomfort while viewing 3D images, discontinue use and rest your eyes.
- Depending on the connected TV, the video being played back might switch to 2D video due to changes in resolution etc. Check the 3D setting on the TV.
- 3D video might not output the way it is set in "HDMI Video Format" (⇒ 64) and "24p Output" (⇒ 64).
- It may display as Side-by-Side (2 screen structure) when playback of the 3D video is started.
- 3D video cannot be played back while recording.

Playback menu

A variety of playback operations and settings can be performed from this menu.

Available options differ depending on the playing contents and the condition of the unit.

- 1 Display the Playback menu.
 - 1 Press [OPTION].
 - 2 Select "Playback Settings" in "Playback Menu" or select "Playback Settings", then press [OK].
 - The playback menu can be displayed directly by pressing [DISPLAY].

e.g.,

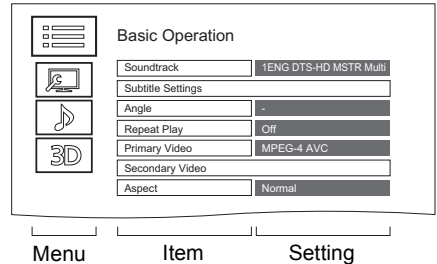

- 2 Select the menu, then press [OK].
- 3 Select the item, then press [OK].
- 4 Change the setting.

To clear the Playback menu

Press [RETURN ⊞] until the Playback menu disappears.

- The playback menu can be cleared directly by pressing [DISPLAY].

Display language list

ENG	English	JPN	Japanese	ARA	Arabic
FRA	French	CHI	Chinese	HIN	Hindi
DEU	German	KOR	Korean	PER	Persian
ITA	Italian	MAL	Malay	IND	Indonesian
ESP	Spanish	VIE	Vietnamese	MRI	Maori
NLD	Dutch	THA	Thai	BUL	Bulgarian
SVE	Swedish	POL	Polish	RUM	Romanian
NOR	Norwegian	CES	Czech	GRE	Greek
DAN	Danish	SLK	Slovak	TUR	Turkish
POR	Portuguese	HUN	Hungarian	*	Others
RUS	Russian	FIN	Finnish		

Basic Operation

Soundtrack*

Show or change the soundtrack.

For Australia Audio Selection

Switch in the case of multiple audio.

For New Zealand Audio Selection/AD

Switch in the case of multiple audio and Audio Description.

Audio Channel

Change audio (LR/L/R) during playback.

Subtitle Settings*

Turn the subtitle on/off, and change the language depending on the media.

Subtitle Settings

Subtitle Style

Subtitle Position

Subtitle Luminance

Subtitle Language

Select the subtitle language in the case of multiple languages.

Angle*

Change the number to select an angle.

Repeat Play

Select the item which you want to repeat.

Random

Select whether to play random or not.

Video

The original video recording method (MPEG-4 AVC etc.) appears.

Primary Video

The original video recording method appears.

Secondary Video

Video

Select on/off of images.

The original video recording method appears.

Soundtrack

Select on/off of audio and the language.

Aspect (⇒ 59)

- * With some discs, you may only be able to make changes using the menus on the disc.

Picture Settings

Picture Type

Select the picture quality mode during play.

Sharpness Adjustment

Noise Reduction

Luminance/Colour Adjustment

Progressive

Select the method of conversion for progressive output to suit the type of title being played.

• Auto

Automatically detects the film and video content, and appropriately converts it.

• Video

Select this setting when the content is distorted if "Auto" is selected.

• Film

Select this if the edges of the film content appear jagged or rough when "Auto" is selected. However, if the video content is distorted, then select "Auto".

Reset to Default Picture Settings

Restores the default settings of the Picture Settings menu.

Sound Settings

Sound Effects

- This function is effective when "Digital Audio Output" is set to "PCM". (⇒ 63)

Night Surround

Enjoy a movie with powerful sound even when the volume is kept low at night.

Re-master 1/Re-master 2

Sound becomes more natural by adding higher frequency signals not recorded on the track.

Dialogue Enhancer

The volume of the centre channel is raised to make dialogue easier to hear.

3D Settings (⇒ 34)

Signal Format

Graphic Display Level



- The menu is not displayed when playing photos.

Deleting/Editing titles

Once deleted, divided or partially deleted, content cannot be restored to its original state. Make certain before proceeding.



* "For recorded titles (⇒ 16)" only



- If the disc is protected, release the protection. (⇒ 57, Disc Protection)
- PIN is required to edit the titles with **G** in some functions. (⇒ 29)

Deleting recorded titles

- 1 On the Video Menu screen: Select the title.

e.g.,

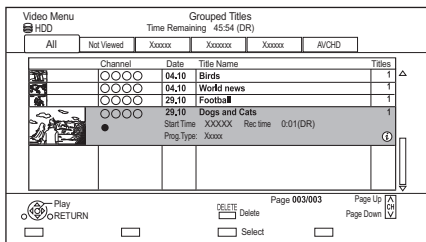

- 2 Press [DELETE].
- 3 Select "Delete", then press [OK].

Multiple selection

Select the title, then press the yellow button. A check mark is displayed. Repeat this step.

- Press the yellow button again to cancel.

Deleting during play

- 1 Press [DELETE] while playing.
- 2 Select "Delete", then press [OK].



- Available disc space after deleting
 - **HDD** **USB HDD** **BD-RE** **RAM**
 - The space deleted becomes available for recording.
 - **BD-R** **DVD-R** **+R**
 - Available space does not increase even after the contents are deleted.
 - **DVD-RW** **+RW**
 - Available recording space increases only when the last recorded title is deleted.

Editing recorded titles

- 1 On the Video Menu screen: Select the title.
 - Multiple selection (⇒ left)
 - 2 Press [OPTION].
 - 3 Select the item, then press [OK].
- e.g.,

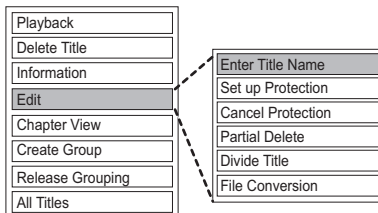

Entering title name

- 1 Select "Enter Title Name" in "Edit", then press [OK].
- 2 Refer to "Entering text". (⇒ 58)

Setting protection

HDD **USB HDD** **BD-RE** **BD-R** **RAM** **+R** **+RW**

Protection setting prevents the title from accidental deletion.

- 1 Select "Set up Protection" or "Cancel Protection" in "Edit", then press [OK].
- 2 Select "Yes", then press [OK].

A appears when setting the protection.

Partial deleting

HDD **USB HDD** **BD-RE** **BD-R** **RAM**

- 1 Select "Partial Delete" in "Edit", then press [OK].
- 2 Press [OK] at the start point and end point to delete.
 - You can find the desired point by using play, search, etc. (⇒ 32)
- 3 Select "Continue", then press [OK].
 - Select "Next", then press [OK] to delete other sections. Up to 20 sections can be set. (⇒ go to step 2)
- 4 Select "Delete", then press [OK].
- 5 Press [RETURN ⊕].



- Chapter Mark is generated in the scene that was partially deleted.

Dividing title

HDD **USB HDD** **BD-RE** **BD-R** **RAM**

- 1 Select "Divide Title" in "Edit", then press [OK].
- 2 Press [OK] at the point to divide the title.
 - You can find the desired point by using play, search, etc. (⇒ 32)
- 3 Select "Continue", then press [OK].
- 4 Select "Divide", then press [OK].

To confirm the division point

After performing step 2.

Select "Preview", then press [OK].

- The unit plays 10 seconds before and after the division point.

To change the division point

After performing step 2.

Restart play and select "Divide", then press [OK] at the division point.



- **HDD** **USB HDD** Divided titles will become a group of titles.

File Conversion

HDD **USB HDD**

File Conversion is a function to convert the recording mode of the title in DR mode and AVCHD contents. The size of the converted title will be small regularly. It will take about the same time as the recorded duration.

- 1 Select "File Conversion" in "Edit", then press [OK].

e.g., **For New Zealand**

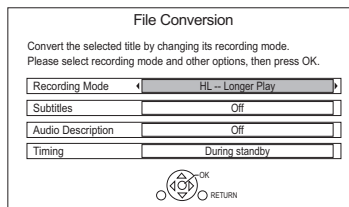

- 2 Set the conversion options, then press [OK].

Recording Mode (⇒ 16):

- **USB HDD** You cannot select XP, SP, LP and EP mode.

Subtitles:

- **Automatic**
Subtitles will be recorded if they are included in the title.
- **Off**
Subtitle will not be recorded.

For New Zealand Audio Description:

- **Automatic**
Audio Description will be recorded if they are included in the title.
- **Off**
Audio Description will not be recorded.

Timing:

- **Now**
Conversion begins immediately after step 4.
 - Timer recording will not be performed during conversion.
- **During standby**
Conversion will be performed after the unit is switched to standby mode.

3 Select the item, then press [OK].

Convert & Delete:

The original title will be deleted to save HDD capacity after conversion.

Convert Only:

The original title remains after conversion.

4 **“Now” conversion:**

Select “Start”, then press [OK].

“During standby” conversion:

Press [OK].

- Conversion will be performed after the unit is switched to standby mode.

“COPY” or “CONV” on the front panel display remains lighted during conversion.

To cancel a “Now” conversion

Press and hold [RETURN ⊖] for more than 3 seconds.

To confirm whether the conversion is completed

Press [VIDEO MENU].

e.g.,

Channel	Date	Title Name	Titles
○○○○	04.10	Birds	1
○○○○	04.10	World news	1
○○○○	29.10	Football	1
○○○○	29.10	Dogs and Cats	1
●	Start Time: XXXXX	Rec lin: 1:00(DR→HL)	ⓘ
	Prog.Type: Xxxxx		

When “○○ → ○○ (Recording mode for conversion)” is displayed, the conversion has not finished.

To cancel a “During standby” conversion

After performing steps 1–2 (⇒ 36, Editing recorded titles)

- 1 Select “File Conversion” in “Edit”, then press [OK].
- 2 Select “Yes”, then press [OK].



- To use “File Conversion”, the HDD needs enough storage capacity.
- File Conversion is stopped when this unit is turned on during performing “During standby” conversion. Conversion will start from the beginning again once the unit is switched to standby mode.
- When converted, 3D information may not be retained.
- When converted, the audio content will be selected according to the following settings:
 - “Audio Type for Digital Broadcast” (⇒ 64)
 - **For New Zealand** “Multi Audio” and “Subtitles” of “Preferred Language” (⇒ 61)

HDD **USB HDD** **BD-RE** **BD-R** **RAM**

- 1 Select "Chapter View", then press [OK].
- 2 Perform the editing operations.

Edit Chapter Mark:

Select the point where you want to start a new chapter while viewing the title.

- 1 Press the green button.
- 2 Press [OK] at the point you want to divide.
 - Repeat this step.
- 3 Press [RETURN ⊕] to go to Chapter View screen.

To delete the chapter:

- 1 Select the chapter, then press [DELETE].
 - Multiple selection (⇒ 36)
- 2 Select "Delete", then press [OK].

To combine chapters (Delete chapter mark):

- 1 Select the chapter, then press [OPTION].
- 2 Select "Combine Chapters", then press [OK].
- 3 Select "Combine", then press [OK].
The selected chapter is combined to the next chapter.

Playback from Chapter View

Refer to "Playback from Chapter View". (⇒ 30)



- The maximum number of chapters:
(Depends on the state of recording.)
HDD **USB HDD**: Approx. 1000 per title
BD-RE **BD-R** **RAM**: Approx. 1000 per disc
- **HDD** **USB HDD** When the title has the maximum number of chapters, you cannot perform the Resume play function (⇒ 32) with the title.

- 1 On the video list screen:
Select the file or folder.

e.g.,

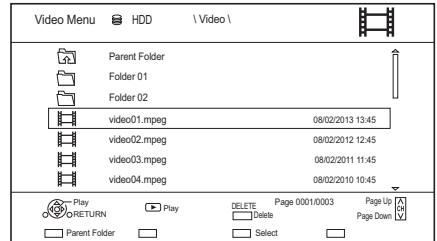

- Multiple selection (⇒ 36)
- 2 Press [DELETE].
 - 3 Select "Yes", then press [OK].



- All files in the folder will be deleted.

Copying titles

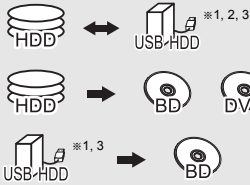

- *1 "For recorded titles (⇒ 16)" only
- *2 The title in the source media will be deleted.
- *3 The recording mode cannot be changed.

- 1** Insert or connect the media.
- 2** Press [FUNCTION MENU].
- 3** Select "Recorded Programmes" or "Video (AVCHD)" in "Contents on HDD", then press [OK].
- 4** Select the title.
 - **Multiple selection**
Select the title, then press the yellow button. A check mark is displayed. Repeat this step.
 - Press the yellow button again to cancel.
- 5** Press the blue button.

If the copy direction selection screen is displayed:
Select the copying direction, then press [OK].
- 6** Select "Yes", then press [OK].
 - If you select "No", you can change the selection. (⇒ right, To change the selection)
- 7** Set other settings, then press [OK]. (⇒ 41, Setting the copying options)
- 8** Select "Yes", then press [OK].

To register the external HDD (USB HDD) (⇒ 54)

To copy HD Video (AVCHD) to the DVD-R in High Definition (⇒ 46)

To copy video files (⇒ 46)

Release the disc protection (⇒ 57)

To change the selection

- 1** Select "No", then press [OK] in step 6 (⇒ left).
e.g., **HDD** → **BD-RE**

The order of copying

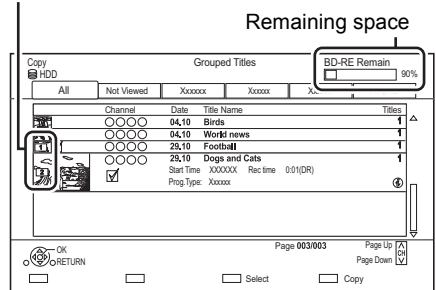

- 2** To change the selected titles:
Select the title, then press the yellow button. Repeat this step to select titles.

To change the picture quality:



- 1** Select the title, then press [OPTION].
- 2** Select "Conversion Select", then press [OK].
- 3** Select the picture quality, then press [OK].
Repeat steps if necessary.
- 3** Press the blue button.
- 4** Go to step 6 (⇒ left).



About screen icons on the Video Menu

Refer to "Screen icons". (⇒ 29)



- Simultaneous operation is not possible while copying with finalising or creating Top Menu.
- You cannot copy the following titles.
 - **USB HDD** Protected titles
 - **USB HDD** HD Video (AVCHD)
- **For New Zealand** If you wish to choose the audio language, select the language from "Multi Audio" or "Preferred Language" before copying (⇒ 61)

Setting the copying options

- 1 Select the item in step 7 (⇒ 40).

e.g.,

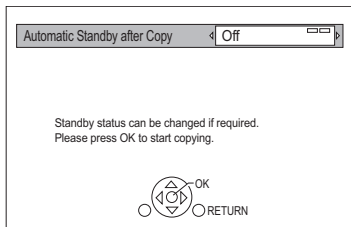

- 2 Press [◀, ▶] to change the settings.

• Automatic Standby after Copy

On:

This unit is turned to standby mode when it is not operated for approximately 5 minutes after completing copy.

• Subtitles

Automatic:

Subtitles will be recorded if they are included in the title.



- **For New Zealand** If you wish to choose the subtitle, select the language from "Subtitles" of "Preferred Language" before copying (⇒ 61).

• For New Zealand Audio Description

Automatic:

Audio Description will be recorded if they are included in the title.

• Finalise

On:

DVD-R **DVD-RW** **+R** The discs become play-only and you can also play them on other DVD equipment.

• Create Top Menu

On:

+RW You can play the disc on other DVD equipment.



- You can perform "Finalise" (⇒ 58) or "Create Top Menu" (⇒ 58) later.

Copying from media other than HDD with Video Menu

BD-RE **BD-R** **RAM** **+RW** → **HDD**

- 1 Insert a disc.
The menu screen appears. (⇒ 30)
- 2 Select "Play Video", then press [OK].
- 3 Select the title.
• Multiple selection (⇒ 40)
- 4 Press the blue button.

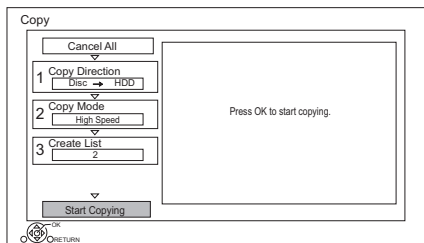

- To change the detailed settings for copy, refer to "Copying titles with copying list". (⇒ 42)

- 5 Select "Start Copying", then press [OK].
- 6 Select "Yes", then press [OK].

Copying titles with copying list

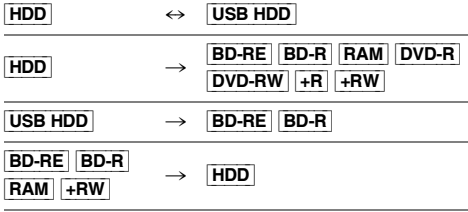

1 **HDD** ↔ **USB HDD**:

- 1 Press [FUNCTION MENU].
- 2 Select "Copy Menu" in "Copy Video", then press [OK].

Except "**HDD** ↔ **USB HDD**":

- 1 Insert a disc.
The menu screen appears. (⇒ 30)
- 2 Select "Copy", then press [OK].

2 Set the copy direction.

- 1 Select "Copy Direction", then press [▶] (right).
- 2 Set "Source" and "Destination".
- 3 Press [◀].

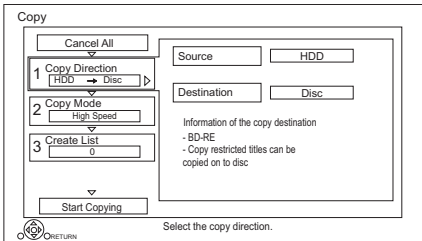

3 Set the recording mode (⇒ 16).

- 1 Select "Copy Mode", then press [▶] (right).
- 2 Set "Recording Mode".
- 3 Press [◀].

4 Register titles for copy.

- 1 Select "Create List", then press [▶] (right).
- 2 Select "New item", then press [OK].
- 3 Select the title, then press the yellow button.

Repeat this step to select titles.

e.g., **HDD**

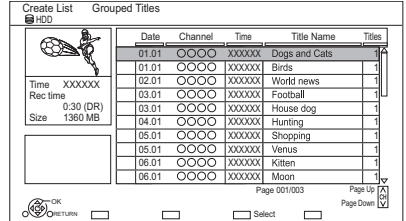

• To change the appearance of the list or show information of the title

- 1 Press [OPTION].
- 2 Select the item, then press [OK].



- The titles will be copied in the order of the copying list. If you want to specify the order, edit the copying list after the titles are selected. (⇒ 43, Editing the copying list)

4 Press [OK].

5 Press [◀].

Data size of each registered title

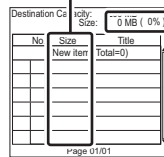

→ Data size recorded to the copy destination

5 Make other settings.

- 1 Select "Other Settings", then press [▶] (right).

e.g., **For Australia**

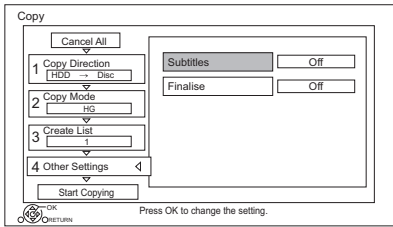

- This screen does not appear depending on the copying mode. (⇒ go to step 6)

- 2 Select the copying option, then press [OK].
(⇒ 41, Setting the copying options)
- 3 Select the item, then press [OK].
- 4 Press [◀].

6 Select "Start Copying", then press [OK].

7 Select "Yes", then press [OK].

To cancel all registered copying settings and lists

After performing step 1

- 1 Select "Cancel All", then press [OK].
- 2 Select "Yes", then press [OK].



- Titles in the grouped titles and other titles cannot be registered simultaneously.
- **RAM** Radio programme cannot copy.

Editing the copying list

- 1 Select the title after step 4-4 (⇒ 42).

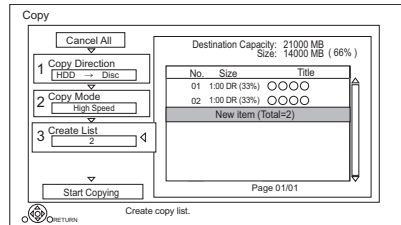

- 2 Press [OPTION].

- 3 Select the item, then press [OK].

Delete All:

All titles that you registered to copy are deleted.

Add:

Add new items to the copying list.

- 1 Select the titles with the yellow button.
- 2 Press [OK].

Delete:

Selected titles are deleted.

- Select the title, then press the yellow button before step 2.

Repeat this step to select titles.

Move:

Change the order of items on the copying list.

- Select the title to move before step 2.
Select the destination, then press [OK].

Screen icons



Titles that cannot be copied in high speed mode



Titles that cannot be copied



Title contains photos

- Photos cannot be copied.



(NTSC)

Title recorded using a different encoding system from that of the unit.



(PAL)

- Titles displaying these marks cannot be selected.

About other screen icons

Refer to "Screen icons". (⇒ 29)

High speed copy

High Speed Copying is the process of copying a title to disc in high speed while maintaining the original record mode and recording length.

- Converting the recording mode will result in a normal speed copy.
- The following recording mode and media combinations support high speed copying.

Original title's recording mode	Media
DR	
HG	
HX	
HE	
HL	
HM	
XP	
SP	
LP	
EP	
FR	

* DVD-RAM only

- High speed copy is possible only when there is enough recording capacity on the destination media.



• It is impossible to copy at high speed in the following cases:

- **HDD** → **BD-RE** **BD-R** :
 - Copying radio programmes
- **HDD** → **DVD-R** **DVD-RW** **+R** **+RW** :
 - Titles that contain many deleted segments
- **HDD** → **+R** **+RW** :
 - Titles recorded in "EP" mode and "FR (recordings 5 hours or longer)" mode
 - Titles recorded in 16:9 aspect
- **HDD** → **DVD-R** **DVD-RW** :
 - Titles recorded via AV input in 16:9 aspect using "EP" mode or "FR (recordings 5 hours or longer)" mode

Normal speed copy

- **DVD-R** **DVD-RW** **+R** **+RW** You cannot copy to the disc in the following cases.
 - When there is not enough free space on the HDD.
 - When the number of titles recorded on the disc will exceed its maximum limit if copying is performed. (⇒ 15)
- Copying will continue up to the point cancelled.
 - **DVD-R** **DVD-RW** **+R** **+RW** If copy is cancelled during the step while temporarily copying to the HDD, then nothing will be copied.
 - **BD-R** **DVD-R** **DVD-RW** **+R** **+RW** Even if the title was not copied to the disc, the amount of remaining writable disc space becomes less.
- When copying title recorded in 1080/50p or 1080/60p, it cannot copy in progressive.

Copying 3D programmes

- It may not display correctly in 3D when a copied 3D programme is played back. In such a case, change the "Signal Format" during the playback of the title. (⇒ 34)
- 3D information may not be copied.
- If you want to copy 3D AVCHD video to the disc in 3D, use BD-R or BD-RE and copying speed must be high speed.

About maintaining the chapter mark

- The position of the chapter might shift slightly.
- Maximum number of chapters on the disc is limited.
 - **BD-RE** **BD-R** **RAM** **DVD-R** **DVD-RW** : Approx. 1000
 - **+R** **+RW** : Approx. 254 (Depends on the state of recording.)

Copying a finalised disc

DVD-V → HDD

While playing a disc, the content being played is copied to the HDD according to the set time.

- 1 Press [FUNCTION MENU].
- 2 Select "Copy Menu" in "Copy Video", then press [OK].
- 3 Set "Copy Mode".
 - 1 Select "Copy Mode", then press [▶] (right).
 - 2 Press [OK], then select the recording mode (XP/SP/LP/EP).
 - 3 Press [◀].
- 4 Set "Copy Time".
 - 1 Select "Copy Time", then press [▶] (right).
 - 2 Select "Time Setting", then press [OK].
 - 3 Select "On" or "Off".

On:
Set the copying time.
• Set a few minutes longer than the source title, in order to include the operation time before play begins.

Off:
Copying all the content on the disc.
- 4 Press [◀].
- 5 Select "Start Copying", then press [OK].
- 6 Select "Yes", then press [OK].
 - When the Top Menu is displayed:
Select the title you want to start copying, then press [OK].



After the last title on the disc has finished playing the Top Menu is recorded until the set time is reached.

To stop copying

Press [■].

- If stopped partway, copying will be up to that point.



- Operations and on-screen displays during copy are also recorded.

Copying Title Playing

HDD → BD-RE | BD-RE | BD-R | RAM | DVD-R | DVD-RW | +R | +RW

- 1 Play back the title to copy.
 - Multiple audio and subtitle displayed during playback will be copied.
 - Select the multiple audio with "Audio Selection" (**For Australia**) or "Audio Selection/AD" (**For New Zealand**) in the Basic Operation menu (⇒ 35)
 - Select the subtitles with "Subtitle Settings" in the Basic Operation menu. (⇒ 35)
- 2 Press [OPTION].
- 3 Select "Copy Title Playing", then press [OK].
- 4 Select "Start", then press [OK].
Copying will start from the beginning of the title regardless of the playing position.

To stop copying

Press and hold [RETURN ⊕] for 3 seconds.



- You can record to or play HDD while high speed copying.
Press [OK] to exit the screen display.
- Press [STATUS ⓘ] to confirm the current progress.

• Speed and recording mode when copying

The high speed copy is performed if available. Refer to "Notes for copying". (⇒ 44)



- [BD-RE] [BD-R] When copying the titles in DR, HG, HX, HE, HL or HM modes and the copy destination does not have enough space, one from HG, HX, HE, HL or HM modes will be selected to match the available space.
- [RAM] [DVD-R] [DVD-RW] [+R] [+RW] When copying the titles in DR, HG, HX, HE, HL or HM modes, copy will be performed at normal speed in FR mode.
- When copying the titles in XP, SP, LP, EP or FR modes and the copy destination does not have enough space, copy will be performed at normal speed in FR mode.

Copying HD Video (AVCHD) to the DVD-R in High Definition

You can copy HD Video (AVCHD) recorded on HDD to a DVD-R in High Definition quality.

HDD → **DVD-R**

- 1 Insert an unformatted DVD-R or DVD-R DL. The menu screen appears. (⇒ 30)
- 2 Select “Copy Video (AVCHD) to Disc”, then press [OK].
- 3 Go to step 4 on page 42, “Copying titles with copying list”.

To copy HD Video (AVCHD) from other equipment

Refer to “Copying the HD Video (AVCHD)”. (⇒ 52)



- When a disc is named, formatting will be automatically performed. Therefore, do not name a disc before this operation. (⇒ 57, Disc Name)
- Discs will be automatically finalised after copy.
- The following HD Videos (AVCHD) cannot be copied to the disc in high definition.
 - Exceeding 18 Mbps
 - 1080/50p or 1080/60p
 - Without the AVCHD information (video recorded with certain non-Panasonic equipment, video copied to the HDD after copying it to BD-R or BD-RE once, etc.)
- 3D video may not be copied correctly.

Copying video files

USB → **HDD**

- 1 On the video list screen:
Select the file or folder.

e.g.,

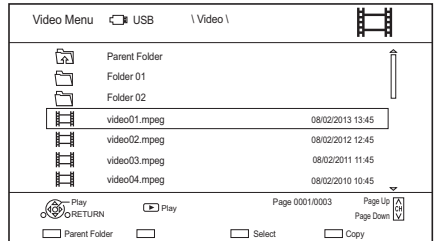

Multiple selection (⇒ 40)

- 2 Press the blue button.
- 3 Select “Yes”, then press [OK].

To stop copying

Press and hold [RETURN ⊕] for 3 seconds.

About the screen icons

Refer to “Screen icons”. (⇒ 30)



- All files in the folder will be copied.
- The names of folders/files cannot be changed after they are copied to the HDD. We recommend that you create a folder with an easily identifiable name on a PC or other device first and use the folder to perform copying.
- Up to 1000 files can be copied at once.
- While copying, no other operations can be performed. Timer recordings will not proceed.

Photo

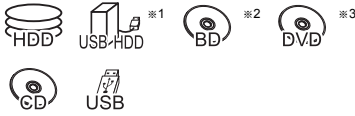

*1 "For data files (⇒ 16)" only (JPEG, MPO)

*2 **BD-RE** only

*3 **RAM** **DVD-R** **+R** only

Playing photos

- 1** **HDD**:
 - 1 Press [FUNCTION MENU].
 - 2 Select "Photo" in "Contents on HDD", then press [OK].Except **HDD**:
 - 1 Insert or connect the media.
The menu screen appears. (⇒ 30)
 - 2 Select "View Photos", then press [OK].
- 2** Select the folder, then press [OK].
 - Photo menu screen appears. (⇒ 48)
- 3** Select the photo, then press [OK].
 - Press [◀, ▶] to display the previous or next photo.

Photo play option

- 1** While displaying a photo:
Press [OPTION].
- 2** Select the item, then press [OK].

Graphic Display Level

You can change the 3D position of the screen display, etc., during the 3D photo playback.

Photo Menu

- **Start Slideshow**
You can start a slideshow.
- **Rotate RIGHT/Rotate LEFT**
 - The information of the rotated photos will not be stored depending on the media.
 - This function is not available during the 3D photo playback.
- **Information**
Information (shooting date etc.) is shown.
- **Wallpaper**
A photo being played back is registered as wallpaper on the FUNCTION MENU screen. (⇒ 18)

Photo Menu screen

e.g., **HDD**

Tab

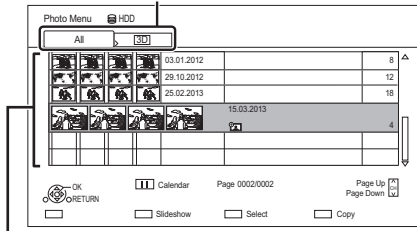

Photos imported to the HDD (⇒ 49) are managed using folders.

Folders and photos can be edited by pressing [OPTION]. (⇒ 49)

To select the tab

Press [◀, ▶].

To start Slideshow

Refer to "Slideshow settings". (⇒ right)

HDD To display or exit the Calendar screen

Press [■].

Screen icons

3D 3D photos (MPO)
(Tab) Select from this tab to play back in 3D.



Photo protected



New photo which is not viewed

Slideshow settings

- 1 On the Photo Menu screen:
Press the green button.

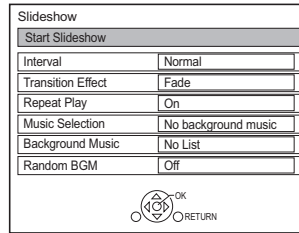

- 2 Select the item, then press [OK].

Start Slideshow

Interval

Set up the time until the next photo is to display.

Transition Effect*

Effect for the next photo to display can be set.

Repeat Play

Music Selection*

Select background music on (either from HDD or USB) or off.

Background Music*

Select background music from HDD or USB (Folder).

Random BGM*

Play back the BGM (Background Music) in random order.

* This function is not available during the 3D photo playback.

To pause the Slideshow

Press [■].

- Press [■] again to restart.

To stop the Slideshow

Press [RETURN ⊖].

HDD BD-RE RAM

1 On the Photo Menu screen:

To edit the folder:

Select the folder.

To edit the photo:

1 Select the folder, then press [OK].

2 Select the photo to edit.

• To select multiple folders or photos

Press the yellow button when selecting the folder or photo.

A check mark is displayed. Repeat this step.

- Press the yellow button again to cancel.

2 Press [OPTION].

- Selectable items will change depending on the media and the type of file.

3 Select the item, then press [OK].

Enter Folder Name

Refer to “Entering text”. (⇒ 58)

Combine Folders

HDD

Delete Folder

Move Photos

HDD

Select “Move to new folder” or “Move to another folder”, then press [OK].

- If “Move to another folder” is selected, set a destination folder.

Delete Photos

Set up Protection

BD-RE RAM

 appears.

- Even if the protection is set, the photo may be deleted by another unit.

Cancel Protection

BD-RE RAM

HDD

→ BD-RE RAM

BD-RE RAM DVD-R +R

→ HDD

CD

USB HDD USB

→ HDD BD-RE RAM

1 On the Photo Menu screen:

To copy the folder:

Select the folder, then press the blue button.

To copy the photo:

1 Select the folder, then press [OK].

2 Select the photos to copy, then press the blue button.

• To select multiple folders or photos

Press the yellow button when selecting the folder or photo.

A check mark is displayed. Repeat this step.

- Press the yellow button again to cancel.

If the copy destination selection screen is displayed:

Select the copying destination, then press [OK].

2 Select “Yes”, then press [OK].

Copying will start.

To stop copying

Press and hold [RETURN ⊕] for 3 seconds.



- The name of the copied photos will be changed.

Copying automatically



Newly added photos will automatically be copied to the HDD.

- 1 Insert the media.
The menu screen appears. (⇒ 30)
- 2 Select “Copy New Photos”, then press [OK].
e.g., **USB**

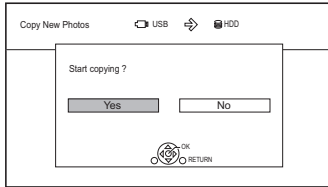

- 3 Select “Yes”, then press [OK].
Copying will start.
- 4 Once the copy is completed, select “Yes” or “No”, then press [OK].

To stop copying

Press and hold [RETURN ⊕] for 3 seconds.



- Photos without shooting date will be categorised using the creation date.
- The name of the copied photos will be changed.

Music



※1 “For data files (⇒ 16)” only

※2 **DVD-R** **+R** only

Playing music CD (CD-DA)

CD (CD-DA)

Insert the disc. Playback will automatically start.

e.g.,

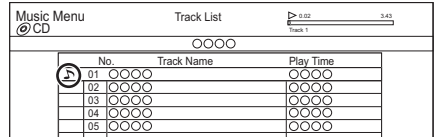

To play other music (track)

Select the item, then press [OK].

Playing music file on the media

USB HDD **DVD-R** **+R** **CD** **USB**

- 1 Insert or connect the media.
The menu screen appears. (⇒ 30)
- 2 Select “Play / Copy Music”, then press [OK].
The music list screen appears.

e.g.,

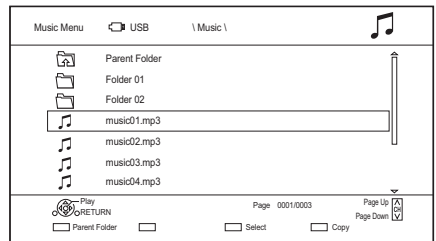

- 3 Select the item, then press [OK].
 - Repeat this step if necessary.
 Playback will start.



- The track/artist/album name will be displayed if the information is contained in music file.

Screen icons



Folder



Music



Move to the parent folder

Playing music file on the HDD

HDD

- 1 Press [FUNCTION MENU].
- 2 Select "Music" in "Contents on HDD", then press [OK].
The music list screen appears.
- 3 Go to step 3 (⇒ 50, Playing music file on the media).

Operations during music play

Stop

Press [■].

Pause

Press [⏸].

- Press [▶ × 1.3] to restart play.

Search

Press [◀◀] or [▶▶].

- Press [▶ × 1.3] to restart play.

Skip

Press [◀◀] or [▶▶].

Repeat Play/Random

Refer to "Repeat Play" or "Random" in Basic Operation menu (⇒ 35).

Sound Effects

Refer to "Sound Effects" in Sound Settings menu (⇒ 35).

To play music continuously even if the Power off link works

Refer to "Playing music continuously even after turning off power to the TV". (⇒ 55)

Copying music

USB HDD DVD-R +R CD* USB → HDD

* Except CD (CD-DA)

- 1 On the music list screen:
Select the file or folder.

e.g.,

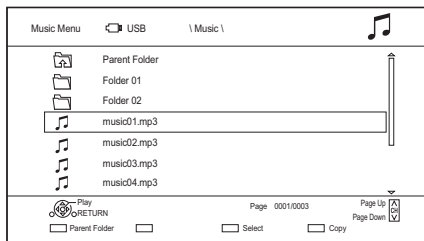

- 2 Press the blue button.
- 3 Select "Yes", then press [OK].

To stop copying

Press and hold [RETURN ⊕] for 3 seconds.

Multiple selection

Select the file or folder, then press the yellow button.

A check mark ✓ is displayed. Repeat this step.

- Press the yellow button again to cancel.



- While copying, no other operations can be performed.
Timer recordings will not proceed.
- All files in the folder will be copied.
- Up to 1000 files can be copied at once.

Deleting music

HDD

- 1 On the music list screen:
Select the file or folder.
 - Multiple selection (⇒ above)
- 2 Press [DELETE].
- 3 Select "Yes", then press [OK].



- All files in the folder will be deleted.

Recording from external equipment



Recording mode: XP, SP, LP, EP

Preparation

- Connect the Set Top Box or video equipment (⇒ 10)
- If you want to change the recording mode (⇒ 22, To change the recording (conversion) mode)

- 1 Press [INPUT SELECT] and select “AV”, then press [OK].
- 2 Select the channel on the Set Top Box or start play on the video equipment.
- 3 Press [REC ●].
Recording will start.
- 4 Set the time to record. (⇒ 22)

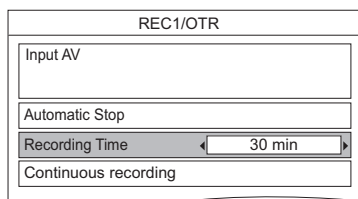

To stop recording

Press [■].

Manually programming timer recording from external equipment

Refer to “Manually programming timer recording” (⇒ 25).



- Following contents or media cannot be played back while recording from external equipment.
 - BD-Video
 - MKV and AVCHD file
 - photo
 - music files other than CD-DA
 - USB HDD (For data files, ⇒ 16) and USB memory

Copying the HD Video (AVCHD)



* “For data files (⇒ 16)” only

e.g., Connecting to the Panasonic video camera

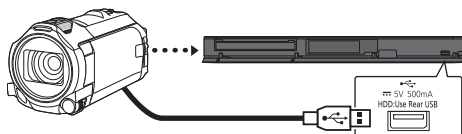

USB connection cable (optional)

- 1 Connect the video camera or insert the media.
 - Make the video camera ready for data transfer.

The menu screen appears. (⇒ 30)

- 2 Select “Copy Video (AVCHD)”, then press [OK].

- 3 When copying from a video equipment: Select “Copy to HDD” or “Copy to Blu-ray Disc”, then press [OK].

- 4 Select the title, then press the yellow button. A check mark is displayed. Repeat this step.
 - Press the yellow button again to cancel. (All the recordings on the same date become a title.)

5 Press [OK].

6 Select "Start", then press [OK].

It will automatically format the unformatted disc, such as a new disc.

- It may take time for the copying to start.

To stop copying

Press and hold [RETURN ⊖] for 3 seconds.

Screen icons

N
(NTSC) Title recorded using a different encoding system from that of the unit.

P
(PAL) • Titles displaying these marks cannot be selected.

About other screen icons

Refer to "Screen icons". (⇒ 29)

Registering the external HDD (USB HDD)



* "For recorded titles (⇒ 16)" only

If you intend to move recorded titles to a USB HDD, the USB HDD must be registered to this unit first.

Limitation information

- A USB HDD with a capacity of less than 160 GB cannot be used.
- Registering of a USB HDD will format the USB HDD and all the content already recorded will be deleted.
- Up to eight USB HDDs can be registered on this unit. If you have already registered eight USB HDDs, it will be necessary to delete one or more of them before registering a new USB HDD.
- Registered USB HDDs cannot be used with devices other than this unit.

Regarding the external HDD (USB HDD)

Please use a recommended USB HDD.

For the latest information on recommended USB HDDs, please check the following website.

<http://panasonic.jp/support/global/cs/>

- Certain non-recommended USB HDDs cannot be used with this unit.
- If a problem occurs with the USB HDD, please contact the manufacturer of the device.

Connecting the USB HDD

Connect this unit with optional **USB HDD**.

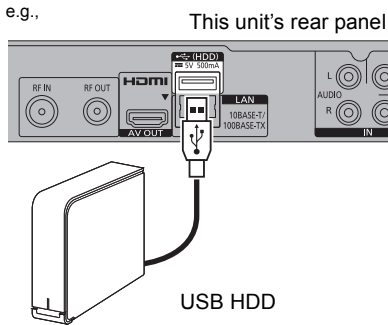

- Only one USB HDD (For recorded titles, ⇒ 16) can be connected at the same time.
- Do not connect additional HDDs using a USB hub.
- For details about connection method, refer to the instructions supplied with the USB HDD.
- The USB HDD can be connected to the USB port on the rear of this unit.

Disconnecting the USB HDD

Disconnecting without following this procedure may result in the loss of recorded content from the USB HDD or the internal HDD.

- 1 Press [FUNCTION MENU].
- 2 Select "Basic Settings" in "Setup", then press [OK].
- 3 Select "Settings for USB HDD" in "HDD / Disc / USB HDD", then press [OK].
- 4 Select "USB HDD Disconnection", then press [OK].
- 5 Select "Yes", then press [OK].
- 6 Disconnect the USB HDD from this unit.

With Other Equipment

Registering the USB HDD

- If the registering screen appears when connecting the USB HDD, go to step 5.

- 1 Press [FUNCTION MENU].
- 2 Select "Basic Settings" in "Setup", then press [OK].
- 3 Select "Settings for USB HDD" in "HDD / Disc / USB HDD", then press [OK].
- 4 Select "USB HDD Registration", then press [OK].
- 5 Select "Yes", then press [OK].
- 6 When the registering is complete, message screen appears. Press [OK].
- 7 The confirmation screen appears. Press [OK].

To cancel all USB HDD registrations (⇒ 63)



- It is not possible to play back the content on the USB HDD whose registration has been cancelled.
- You can check the registration number of the USB HDD on the Video Menu. (⇒ 28)

VIERA Link functions

What is VIERA Link?

VIERA Link is a convenient function which will link the operations of this unit and a Panasonic TV (VIERA) or an amplifier/receiver. You can use this function by connecting the equipment with the HDMI cable. See the operating instructions for connected equipment.

Automatic input switching/ Power on link

When the following operations are performed, the input channel of the TV will be automatically switched and the screen of this unit will be displayed. Additionally when the TV is off, the TV will automatically turn on.

- When play starts on this unit
- When an action that uses Video Menu etc, is performed

Power off link

When you set the TV to standby mode, this unit is also automatically set to standby mode.

- Power off link function does not work when manual recording, copying etc.

Playing music continuously even after turning off power to the TV

The following operations make it possible to keep the power of the unit on and to play music continuously.

When the unit is directly connected to an amplifier/receiver.

- 1 While playing music
Press [OPTION].
 - 2 Select "TV Power Off", then press [OK].
- Sound may be discontinued for several seconds when the power to the TV is turned off.

Easy control only with Panasonic TV's remote control

You can operate this unit using the TV remote control.

Refer to the operating instructions of the TV about the buttons that you can use.



- VIERA Link, based on the control functions provided by HDMI which is an industry standard known as HDMI CEC (Consumer Electronics Control), is a unique function that we have developed and added. As such, its operation with other manufacturers' equipment that supports HDMI CEC cannot be guaranteed.
- These functions may not work normally depending on the equipment condition.
- Use the remote control supplied with this unit if you cannot operate this unit using buttons on the TV remote control.

Software (Firmware) Update

You cannot operate the unit until the update is complete. Don't remove the AC mains lead during the update. Removing the AC mains lead while the update is in progress may damage the unit.

Update software (firmware) of this unit

Software of this unit can be updated automatically by the following methods at the specified time.

(Default setting is 3 a.m. ⇒ 66, Software Update in Standby)

• From broadcasts (For New Zealand)

Software of this unit will be updated from broadcasts if update information is detected.

• From Internet

Network connection and setting are required. (⇒ 11, 12)

If a software (firmware) update is available, a notification is displayed.

New software version has been found.
The software will be updated automatically after this unit is switched to standby.
Do not disconnect the AC mains lead.

- It is displayed on the Channel Information (⇒ 19) when the Software (Firmware) can be updated immediately.

e.g.,

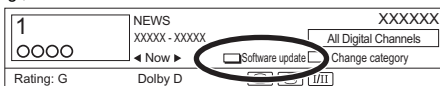

To execute, press the red button while the Channel Information is displayed, and follow the instructions on the screen.

Update of the software (firmware) will start when the unit is turned to standby mode.

To update the software (Firmware) immediately

Use the "Software Update Now (Broadcast)" (For New Zealand) function or "Software Update Now (Internet)" function. (⇒ 66)



- It may take up to a few hours until the update is completed depending on the network or broadcast environment.
- The timer recording always takes preference over the software (Firmware) download; if the timer recording is scheduled to start, the downloading will be performed at the next opportunity.
- You can also download the latest software (firmware) from the following website.
<http://panasonic.jp/support/global/cs/>

Other operations

Media management

BD-RE **BD-R** **RAM** **DVD-R** **DVD-RW** **+R** **+RW**

- 1 Press [FUNCTION MENU].
- 2 Select "Media", then press [OK].
- 3 Select the media, then press [OK].
- 4 Select the management item, then press [OK].
 - Selectable items will change depending on the selected item and inserted media.

Disc Name

BD-RE **BD-R** **RAM** **DVD-R** **DVD-RW** **+R** **+RW**

This function is to name a disc.
Refer to "Entering text". (⇒ 58)

- The disc name is displayed in the Blu-ray Disc Management/DVD Management window.
- **DVD-R** **DVD-RW** **+R** With a finalised disc, the name is displayed on the Top Menu.
- **+RW** The disc name is displayed only if you play the disc on other equipment after creating Top Menu.



- Do not perform this operation before copying HD Video (AVCHD) to DVD-R or DVD-R DL. (⇒ 46)

Disc Protection

BD-RE **BD-R** **RAM**

Select "Yes", then press [OK].

e.g.,

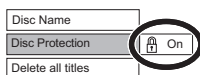

- To release the protection Repeat the same steps.
 - The screen icon will be switched to "Off".

Delete all titles

BD-RE **BD-R** **RAM**

- 1 Select "Yes", then press [OK].
- 2 Select "Start", then press [OK].



- Photo data (JPEG/MPO) or computer data cannot be deleted.

Format Disc

BD-RE **RAM** **DVD-RW** **+RW**

BD-R **+R** (New disc only)

Formatting deletes all contents (including computer data), and they cannot be restored. Check carefully before proceeding.

- 1 Select "Yes", then press [OK].
- 2 Select "Start", then press [OK].
- 3 Press [OK].

RAM To stop formatting

Press [RETURN ⊞].

- You can cancel formatting if it takes more than 2 minutes. The disc must be reformatted if you do this.



- **Do not disconnect the AC mains lead while formatting.** This can cause the disc unusable.
- The contents are deleted when you format a disc even if you have set protection.
- When a disc has been formatted using this unit, it may not be possible to use it on any other equipment.
- It will become DVD Video format when a DVD-RW recorded in DVD Video Recording format is formatted with this unit.
- **RAM** Formatting normally takes a few minutes; however, it may take up to a maximum of 70 minutes.

Top Menu

DVD-R **DVD-RW** **+R** **+RW**

You can select the background for DVD-Video Top Menu.

Select the background, then press [OK].

Auto-Play Select

DVD-R **DVD-RW** **+R** **+RW**

You can select whether to show the Top Menu after finalising or creating Top Menu.

Select "Top Menu" or "Title 1", then press [OK].

Top Menu:

The Top Menu appears first.

Title 1:

The disc content is played without displaying the Top Menu.

Finalise

DVD-R **DVD-RW** **+R** (You can play the disc on compatible DVD players by finalising it on the unit.)

BD-R (Finalising BD-R prevents accidental recording or editing.)

- 1 Select "Yes", then press [OK].
- 2 Select "Start", then press [OK].
- 3 Press [OK].

After finalising

- **BD-R** **DVD-R** **+R** The disc becomes play-only and you can no longer record or edit.
- **DVD-RW** You can record and edit the disc after formatting.



- **Do not disconnect the AC mains lead while finalising.** This can cause the disc unusable.
- You cannot cancel finalising.
- Finalising takes up to 15 minutes (Up to 60 minutes in case of DVD-R DL and +R DL).
- Depending on the disc, it may take longer than displayed on the confirmation screen (approximately four times longer).
- You cannot finalise discs recorded on other manufacturer's equipment.
- **DVD-R** **DVD-RW** **+R** If you finalise discs recorded on Panasonic equipment other than this unit, the background selected as "Top Menu" may not be displayed.
- Discs finalised on this unit may not be playable on other players due to the condition of the recording.

Create Top Menu

+RW

You can create Top Menu for displaying on other equipment.

Make selections from "Top Menu" and "Auto-Play Select" before creating Top Menu.

- 1 Select "Yes", then press [OK].
- 2 Select "Start", then press [OK].
- 3 Press [OK].



- You cannot use the Top Menu for playing on this unit.
- The created menu is deleted when you record or edit the disc.

Entering text

Preparation

- Show the "Enter Title Name" screen, etc.

- 1 Select a character, then press [OK]. Repeat this step to enter other characters.

e.g.,

Name field: shows the text you have entered

Enter Title Name

Shift	1	2	3	4	5	6	7	8	9	0	Delete
	q	w	e	r	t	y	u	i	o	p	Finish
	a	s	d	f	g	h	j	k	l	.	
	z	x	c	v	b	n	m	@	*	#	
	/	:	~	-	-	.	:	'	*		
	<input type="checkbox"/>	<input type="checkbox"/>	<input type="checkbox"/>	<input type="checkbox"/>	<input type="checkbox"/>	<input type="checkbox"/>	<input type="checkbox"/>	<input type="checkbox"/>	<input type="checkbox"/>	<input type="checkbox"/>	<input type="checkbox"/>

OK RETURN

- Red: Enter Symbols
- Green: Enter Alphanumeric characters
- Yellow: Enter Other Characters, such as umlaut mark or accent grave
- [█]: Delete a character
- [▶ × 1.3]: Shift the alphabetic characters on the screen to upper case/lower case

- 2 Press [█] (Finish). "Writing..." appears then the screen returns to the previous screen and so on.

To end partway

Press [RETURN ⊖]. (Text is not added.)



- The maximum number of characters depends on the media.

Switching the aspect ratio of the screen

When the image does not match the screen size of the TV, you can enlarge the image to fill the screen.

- 1** Display the Playback menu.
 - 1 Press [OPTION].
 - 2 Select "Playback Settings" in "Playback Menu", then press [OK].
 - The playback menu can be displayed directly by pressing [DISPLAY].
- 2** Select "Aspect" in "Basic Operation", then press [OK].
- 3** Select the item, then press [OK].

Normal:

Normal output

Side cut:

The black bars on the right and left sides of the 16:9 image disappear and the image is enlarged.

Zoom:

The black bars on the top and bottom sides of the 4:3 image disappear and the image is enlarged.



- This function does not work on 3D contents.
- The screen mode is switched to "Normal" in the following situations:
 - when you change the channel
 - when you start or end the playback of a title
 - when you switch the unit on or to standby mode.
- **BD-V** **DVD-V** "Side cut" does not have any effect.
- When "TV Aspect" (⇒ 64) is set to "Pan & Scan" or "Letterbox", the "Zoom" effect is disabled.

HOLD function

The HOLD function deactivates all buttons on the unit and remote control.

Press and hold [OK] and [RETURN ⊖] simultaneously until "X HOLD" appears on the front panel display.

To cancel the HOLD function

Press and hold [OK] and [RETURN ⊖] simultaneously until "X HOLD" disappears.

Basic Settings

You can change the unit's settings of Digital TV Tuning, Sound, Display, Connection, Network etc. in the menu.

- 1 Press [FUNCTION MENU].
- 2 Select "Basic Settings" in "Setup", then press [OK].

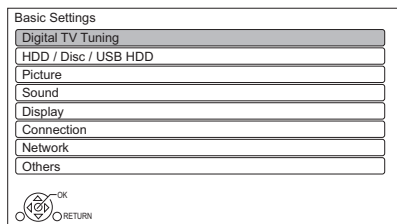

- 3 Select the menu, then press [OK].
- 4 Select the item, then make the setting.

To return to the previous screen

Press [RETURN ⊖].

Digital TV Tuning

Favourites Edit

You can create four favourites of channels for making viewing and recording easier.

After editing as follows, save the Favourites.
Press [RETURN ⊖], then press [OK].

- To select the other Favourites list:
Press the green button.
- To add channels to the Favourites list:
Select the channel in the "All Digital Channels" column, then press [OK]. Repeat this step.
 - Yellow: Add all the available channels to the Favourites. (This function is available only when there are no channels in the "Favourites".)
- To change the order of the channels list:
 - 1 Select the channel in the "Favourites" column to move, then press the green button.
 - 2 Select the new position, then press the green button.

- To delete channels:
Select the channel in the "Favourites" column, then press [OK].
 - Yellow: Delete all channels.
- To change the name of the Favourites list:
 - 1 Press the red button in the "Favourites" column.
 - 2 Press [▲, ▼, ◀, ▶] to select a character, then press [OK].
Repeat this step to enter other characters.
 - Red: Delete a character.
 - Blue: Delete all characters.
 - 3 Press [RETURN ⊖].

Channel List

You can edit the channel list.

- To hide unwanted channels
 - 1 Select the channel.
 - 2 Press [OK].
The check mark is removed.
 - Yellow: Reveal all channels.
- To change the channel number assignment
 - 1 Select the channel to change, then press the green button.
 - 2 Enter the channel number to reassign with the number buttons.
 - 3 Press [OK].
- To set the channel manually
 - 1 Press the red button.
 - 2 Refer to "Manual Tuning". (⇒ below)

Auto Setup

You can restart the Auto Setup. (⇒ 12)
Select "Yes", then press [OK].



- The timer recording programmes are cancelled.

Manual Tuning

You can add new channels manually.

- 1 Press [▲, ▼] to select the physical channel.
 - Adjust the frequency by checking the signal strength and signal quality displays.
- 2 Press [OK] to start scan.
 - The set channel is displayed in the table.

Update Channel List

You can update the channel list to the latest one.

Child Lock (Parental Rating)

You can restrict the viewing of channels unsuitable to children.

Set a ratings level to limit broadcast viewing and playback.

- PIN is required to change. (⇒ 19)

Signal Condition

You can check the quality and strength of signals. Press [CH ^ v] to select the channel.



- The channels you can receive are affected by weather conditions, seasons, time (day/night), region, length of the cable that is connected to the aerial, etc.
- When the signal is too strong (red bar), reduce the signal amplification at your aerial. (For details, consult your dealer.)

For Australia**New Channel Message**

Set whether to obtain the information automatically when a new digital channel is added.

For New Zealand**Preferred Language**

Select the language for multi broadcast.

If the selected language is not available, then the original language will be selected.

For New Zealand**Audio Description**

(When Audio Description is available in the programme)

When "Automatic" is selected, Audio Description will be set as default while watching. When timer recording and copying, Audio Description will be recorded.

Settings for Playback**3D BD-Video Playback**

Select the playback method of 3D compatible video software.

Soundtrack

Select the audio language.

- Enter a code with the number buttons when you select "Other ****".
(⇒ 74, Language code list)

Subtitles

Select the language for subtitle.

- Enter a code with the number buttons when you select "Other ****".
(⇒ 74, Language code list)

Menu

Select the language for disc menus.

- Enter a code with the number buttons when you select "Other ****".
(⇒ 74, Language code list)

BD-Live

You can restrict Internet access when BD-Live functions are used.

- If "On (Limit)" is selected, Internet access is permitted only for BD-Live contents which have content owner certificates.

BD-Video Parental Control

Set an age limit of BD-Video play.

- PIN is required to change. (⇒ 19)

DVD-Video Parental Control

Set a rating level to limit DVD-Video play.

- PIN is required to change. (⇒ 19)

Settings for Recording

Timer Record Start Buffer

This function sets the timer recording to start earlier than the TV Guide time.

Timer Record Stop Buffer

This function sets the timer recording to stop later than the TV Guide time.

REWIND LIVE TV

Turn on/off the REWIND LIVE TV function.

- When “Automatic Standby” is set to “Off” (⇒ 65), “On” cannot be selected.

Aspect for Recording

Sets the aspect ratio when recording or copying except in DR mode.

- “HG”, “HX”, “HE”, “HL” or “HM” mode:
If “Automatic” is selected, the title will be recorded with the original aspect ratio.
- “XP”, “SP”, “LP” or “FR (recordings less than 5 hours)” mode:
If “Automatic” is selected, the title will be recorded with the original aspect ratio at the time when recording started (including when recording started at a commercial, etc.).
- “EP” or “FR (recordings 5 hours or longer)” mode:
If “Automatic” is selected, aspect is fixed to 4:3.
- In the following cases, the programme will be recorded with the original aspect ratio.
 - **BD-RE** **BD-R** When the recording mode is set to “XP”, “SP”, “LP”, “EP” or “FR”
- In the following cases, aspect is fixed to 4:3.
 - When copying to a +R, +R DL and +RW.

For Australia

Chapter Creation

Set the Chapter Creation method.

- Even if “Automatic” is selected, depending on the programme to be recorded, the chapter may not be created correctly.

Disc Speed for High Speed Copy

Select the speed of high-speed copying.

HDD Management

Press and hold [OK] for 3 seconds to show the following settings.

Delete all titles

Delete all recorded programmes and AVCHD on the built-in HDD.

- Delete does not work if one or more titles are protected.

Delete all videos (MP4 / MKV)

Delete all videos (MP4/MKV) on the built-in HDD.

Delete all photos

Delete all photos on the built-in HDD.

Delete all music

Delete all Music on the built-in HDD.

Format HDD

Formatting deletes all contents on the built-in HDD, and they cannot be restored. Check carefully before proceeding.

Settings for USB HDD

USB HDD Registration

Register the USB HDD. (⇒ 54)

USB HDD Disconnection

This function puts the USB HDD in a state in which it can be safely disconnected. (⇒ 54)

USB HDD Management

Press and hold [OK] for 3 seconds to show the following settings.

Delete all titles

Delete all titles on the USB HDD.

- Delete does not work if one or more titles are protected.

Format USB HDD

Formatting deletes all contents, and they cannot be restored. Check carefully before proceeding.

Cancellation of all USB HDD Registrations

This function cancels the registrations of all the USB HDDs registered on this unit.

Only do this if you are going to dispose of this unit.



- Before operation, perform "USB HDD Disconnection" (⇒ 62) and remove the USB HDD.

Picture

Still Mode

Select the type of picture shown when you pause play.

- **Field:**
Select if jittering occurs when "Automatic" is selected. (The picture is coarser.)
- **Frame:**
Select if small text or fine patterns cannot be seen clearly when "Automatic" is selected. (The picture is clearer and finer.)

Sound

Dynamic Range Compression

To lower the dynamic range for playback (e.g., at night).

- This does not work depending on broadcasts and recorded titles.

Downmix

Select the downmix system of multi-channel to 2-channels sound.

- Select "Surround encoded", when the connected equipment supports the virtual surround function.
- There is no effect on "Bitstream" via HDMI AV OUT and DIGITAL AUDIO OUT terminal.
- The audio will be output in "Stereo" in the following cases.
 - AVCHD playback
 - **[BD-V]** : Playback of clicking sound on the menu and audio with secondary video in picture-in-picture mode.

Bilingual Audio Selection

Select whether to record the audio type ("M1" or "M2") when:

- File Conversion (⇒ 37)
- Copying to a DVD-R, DVD-RW, +R and +RW.

Digital Audio Output

PCM Down Conversion

Select how to output audio with a sampling frequency of 96 kHz.

- **On:**
Signals are converted to 48 kHz.
(Choose when the connected equipment cannot process signals with a sampling frequency of 96 kHz.)
- **Off:**
Signals are output as 96 kHz.
 - The signals will be converted to 48 kHz regardless of the setting in the following cases.
 - The signals have a sampling frequency of over 96 kHz.
 - The disc has copy protection.
 - "BD-Video Secondary Audio" is set to "On". (**[BD-V]**) (⇒ below)

Dolby D / Dolby D + / Dolby TrueHD

DTS / DTS-HD

MPEG

Select the audio signal to output.

- Select "PCM" when the connected equipment cannot decode the respective audio format.
- Not making the proper settings may result in noise.

System Volume Adjustment

If the volume of a programme being watched through this unit is different than the volume of a programme being watched directly on the TV, changing this setting may reduce the gap. (This function works only while you are watching a programme or playing back a programme recorded in DR mode with this unit.)

BD-Video Secondary Audio

Turn on/off the clicking sound on the menu and audio with secondary video.

Audio Delay

Mis-sync between the video and audio is corrected by delaying the audio output.

Audio Type for Digital Broadcast

If the programme has more than one track (Dolby Digital, etc.), you can set priorities.

- This setting will give effect in the following conditions.
 - The default setting when watching broadcasts.
 - The default setting when playing back the title recorded in DR mode.
 - File Conversion (⇒ 37)
 - Normal speed copy from the title recorded in DR mode. (⇒ 40)

Display

On-Screen Information

Select the time until the Channel Information screen (⇒ 19) disappears automatically.

Front Panel Display

Changes the brightness of the front panel display.

Screen Saver

This is to prevent image retention on the screen.

Teletext

Select the Teletext (⇒ 19) display mode.

Connection

3D Settings

3D Type

If 3D video cannot be played back in 3D, you may be able to play it in 3D by changing the setting.

- Change the settings for 3D on the TV also when “Side by side” is selected.

3D AVCHD Output

If 2D AVCHD video is recognised as 3D video and cannot be played back correctly, you may be able to play it by changing the setting.

3D Playback Message

Set to display or hide the 3D viewing warning screen.

TV Aspect

Set to match the type of TV connected.

- Pan & Scan:

Side picture is trimmed for 16:9 picture.



The pictures may be shown in the letterbox style depending on the content.

- Letterbox:

Black bands appear for 16:9 picture.



Aspect for 4:3 Video

To play a 4:3 title, set how to show pictures on a 16:9 TV.

- 4:3:
Picture output expands left or right.
- 16:9:
Picture is output as original aspect with side panels.

TV System

Set in accordance with the TV System for the connected TV.

HDMI Connection

HDMI Video Format

You can only select items compatible with the connected equipment.

- If “Automatic” is selected, the output resolution best suited to the connected TV (1080i, 720p or 576p/480p) is automatically selected.

24p Output

When playing BD-Video recorded in 24 frames, this unit displays each frame at 1/24 second intervals—the same interval originally shot with the film movie.

- When this unit is connected to a TV compatible with 1080/24p and “HDMI Video Format” is set to “Automatic” or “1080i”, images will be output in 1080/24p.



- When BD-Video images other than 24p are played, images are output at 60i.

Deep Colour Output

Deep Colour output when a TV that supports Deep Colour is connected.

HDMI Audio Output

Select "Off" when connected to an amplifier/receiver with a DIGITAL AUDIO OUT terminal.



- To enjoy BD-Video that supports Dolby Atmos® or DTS:X™

Connect this unit to an AV amplifier or similar device that supports it with an HDMI cable, and select the following settings:

- Dolby D / Dolby D + / Dolby TrueHD: "Bitstream"
- DTS / DTS-HD: "Bitstream"
- BD-Video Secondary Audio: "Off"

Dolby Atmos is a trademark of Dolby Laboratories.

Contents Type Flag

If "Automatic" is selected, the optimal method of playback depending on the TV (e.g. cinema) will automatically be selected (only when the TV supports Contents Type Flag).

VIERA Link

Select "Off" when you do not want to use VIERA Link.

Network

Easy Network Setting

Press [OK] to start Easy Network Setting. (⇒ 12)

Network Settings

IP Address / DNS Settings

Check the connection of the network or set the IP address and DNS.

- To set the IP address and DNS
 - 1 Set "IP Address Auto-Assignment" and "DNS-IP Auto-Assignment" to "Off".
 - 2 Select the item, then press [OK] to show the respective setting.
- When the router's DHCP server function is not activated, check the numbers of other connected devices such as personal computers, then assign a number different from those of other devices for the "IP Address" and assign the same number for "Subnet Mask" and "Gateway Address".

Proxy Server Settings

Check and set the connection to the Proxy server.

- Press [OK] to show the respective setting.

Note

Displays the terms of service for the cloud services.

- You must agree to the terms of use for the Internet function and the privacy policy.

Others

Standby Settings

Quick Start

- On:

It is possible to start quickly from standby mode.
- Off:

Power consumption in standby mode is minimized. (⇒ 72)
However, startup time from standby mode will be longer.
- Timer Setting for Quick Start:

"Quick Start" is activated when the set time comes.

Automatic Standby

Set the time to turn the unit to standby mode automatically.

When the unit is not operating, the unit will be turned to standby mode once the set time has passed.

- When "REWIND LIVE TV" is set to "On" (⇒ 62), "Off" cannot be selected.

Automatic Standby after OTR

- On:

This unit is turned to standby mode when it is not operated for approximately 5 minutes after completing "Automatic Stop" or "Recording Time" (⇒ 22).

Automatic Standby after Copy

- On:

This unit is turned to standby mode when it is not operated for approximately 5 minutes after completing copy (⇒ 41, Copying from media other than HDD with Video Menu, ⇒ 42, Copying titles with copying list).

RF OUT (Aerial Signal)

Set whether to output the broadcasting signal from RF OUT or not while in standby mode (When "Quick Start" is not activated).

- If "On" is selected, the aerial signal is output from this unit.

Remote Control

Change the remote control code on the main unit and the remote control if you place other Panasonic products close together.

- Use "BD 1", the factory set code, under normal circumstances.

- 1 Select the code, then press [OK].
- 2 While pressing [OK], press and hold the number button ([1] to [6]) for more than 5 seconds.
- 3 Press and hold [OK] for more than 5 seconds.
- 4 Press [OK].

Clock

If the time is not set correctly, use the settings listed in the method below.

- Automatic

This unit usually obtains time and date information from digital broadcasts.

- **For Australia** Region Selection

Select the region where you live to adjust the standard time.

- The time contained in the broadcast signal is UTC (Universal time, coordinated).
- Daylight Saving Time
Select time offset from the standard time for Summer Time.
- If there is a gap between displayed time and actual time, set this function.
- Manual Setting

- 1 Select "Off" of "Automatic", then press [OK].
- 2 Select the item you want to change.
- 3 Change the setting.
- 4 Press [OK] when you have finished the settings.

PIN Entry

You can set/change the PIN for parental control.

- 1 Enter your 4-digit PIN with the number buttons.
 - 2 Enter the new 4-digit PIN with the number buttons.
 - **Make a note of PIN in case you forget it.**
- e.g.,

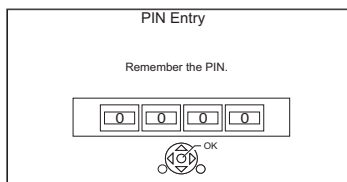

- 3 Press [OK].

System Update

Software Update in Standby

When you set this unit to standby mode, software (firmware) updates (⇒ 56) are downloaded automatically at the time you have specified.

For New Zealand

Software Update Now (Broadcast)

Refer to "Software (Firmware) Update". (⇒ 56)

Software Update Now (Internet)

Refer to "Software (Firmware) Update". (⇒ 56)

Software Licence

Information about the software licence is displayed.

System Information

Display Software (firmware) version of this unit.

Initialize

Shipping Condition

All the settings except for basic settings return to the factory preset.

- The timer recording programmes are also cancelled.

Default Settings

All the settings other than the tuning settings, clock settings, disc language settings, rating PIN, remote control code, etc. return to the factory presets.

Troubleshooting guide

Before requesting service, make the following checks. If the problem still persists, consult your dealer for instructions.

Updating to the latest software (firmware) may solve the problem. (⇒ 56)

The followings do not indicate a problem with this unit:

- Regular disc rotating sounds or HDD rotating sounds.
- Poor reception due to atmospheric conditions.
- When you switch the unit on or to standby mode, there may be an unexpected sound.

General operation

The unit does not work.

- Check the connections. (⇒ 9)
- One of the unit's safety devices may have been activated.

Reset the unit as follows:

- 1 Press [⏻/|] on the main unit to switch the unit to standby.
 - If the unit does not switch to standby, press [⏻/|] on the main unit for about 3 seconds. The unit is forcibly switched to standby. Alternatively, disconnect the AC mains lead, wait one minute, then reconnect it.
- 2 Press [⏻/|] on the main unit to switch it on. If the unit still cannot be operated, consult the dealer.

Cannot eject a disc.

- 1 Press and hold [⏻/|] on the main unit for at least 3 seconds when it is turned off.
- 2 Press and hold [OK], the yellow button and the blue button at the same time for more than 5 seconds.
 - "00 RET" is displayed on the front panel display.
- 3 Repeatedly press [▶] (right) until "06 FTO" is displayed on the front panel display.
- 4 Press [OK].

The remote control does not work.

- The remote control and main unit are using different codes. Change the code on the remote control.
"Remote Control □" appears on the right side of the screen.
("□" stands for a number.)



Front panel display

Press and hold [OK] and the indicated number button at the same time for more than 5 seconds. (⇒ 66)

Startup is slow.

- Startup takes time in the following situations:
 - A disc is inserted.
 - The clock is not set.
 - Immediately after a power failure or the AC mains lead is connected.
 - When a BD-J application is executing.
 - When the "Quick Start" is not activated. (⇒ 65)

Displays

"0:00" is flashing on the front panel display.

- Set the clock. (⇒ 66)

The clock does not display on the unit when switched to standby.

- The clock does not display when "Quick Start" is not activated. (⇒ 65)

TV screen and video

Screen size is wrong.

- Check the "TV Aspect" or "Aspect for 4:3 Video". (⇒ 64)
- Adjust the aspect ratio setting on TV.
- Adjust the aspect ratio setting on this unit. (⇒ 59)
- Check "Aspect for Recording" before recording or file conversion. (⇒ 62)

The black screen appears on the TV.

- This phenomenon may occur, depending on the TV setting, when "Quick Start" is activated. Depending on the TV, this phenomenon may be prevented by reconnecting to a different HDMI input terminal.

TV reception is not displayed.

- Broadcast signals are not output from this unit's RF OUT terminal. Select "On" in "RF OUT (Aerial Signal)". (⇒ 66)

The screen changes automatically.

- If "Screen Saver" set to "On", the screen saver function will be activated when there is no operation for 5 minutes or more. (⇒ 64)

There is a lot of image lag when playing video.

- Set to "0" all items in the "Noise Reduction". (⇒ 35)
- Set "Audio Delay". (⇒ 64)

The images do not appear on the TV.

The picture is distorted during play, or video is not played correctly.

- Check the connections. (⇒ 9)
- Check the settings of the connected TV, etc.
- An incorrect resolution is selected in "HDMI Video Format". (⇒ 64) Reset the setting as follows:
 - 1 While the unit is on, press and hold [OK], the yellow button and the blue button at the same time for more than 5 seconds.
 - "00 RET" is displayed on the front panel display.
 - 2 Repeatedly press [▶] (right) until "04 PRG" is displayed on the front panel display.
 - 3 Press and hold [OK] for at least 3 seconds. Set the item again.
 - When Dolby Digital Plus, Dolby TrueHD, and DTS-HD® audio are not output properly, select "Yes" in "Default Settings" and make proper settings. (⇒ 66)
- The unit's TV System is different from that of the disc. Change the TV System. (⇒ 64, TV System)
- The picture may be distorted or a black screen may appear between scenes recorded with different aspect ratios.
- Set "Deep Colour Output" (⇒ 65) or "Contents Type Flag" (⇒ 65) to "Off".
- The country setting is not set correctly. Perform "Shipping Condition" (⇒ 66) first, and then set the country you live in again.

3D video is not output correctly.

- 3D video may be output correctly by changing the following settings:
 - "3D Type" of "3D Settings" (⇒ 64)
 - "Signal Format" (⇒ 34, 3D settings during playback)
- Check the settings of the connected TV.
- When a non-3D compatible amplifier/receiver is connected between this unit and a TV, 3D video is not output. (⇒ 10)
- When "HDMI Audio Output" is set to "Off", 3D video may not be output correctly. (⇒ 65)

Sound

No sound.

Distorted sound.

- Check the connections. (⇒ 9)
- Check the settings of the connected TV, etc.
- Press [AUDIO] to select the audio. (⇒ 20, 33)
- To output audio from a device connected with an HDMI cable, set "HDMI Audio Output" to "On". (⇒ 65)

Cannot change audio channel.

- You cannot change the audio channel if "Digital Audio Output" is set to "Bitstream". (⇒ 63)

Recording, timer recording and copying

Cannot record.

Cannot copy.

- Some broadcasts are copyright protected.
- You cannot record to the disc by pressing the [REC ●] or timer recording.
- The disc is protected. (⇒ 57)
- **[DVD-R] [DVD-RW] [+R] [+RW]** Since it will copy to HDD temporarily, copying is not possible if there is insufficient available capacity on the HDD.
- This unit cannot record/copy NTSC signals to discs that already have PAL signal recordings.

Timer recording does not work properly.

- When ☒ is displayed on the screen. (⇒ 27)

Auto Renewal Recording does not work properly.

- The programme will not be overwritten in the following cases:
 - the programme is protected
 - any programme is being played back or copied
 - a screen such as Video Menu is displayed
- Instead, the programme will be saved as a separate programme and that will be overwritten.

A part or whole of a recorded title has been lost.

- If there is a power failure or the AC mains lead is disconnected from the household mains socket while recording or editing, the title may be lost or the HDD may become unusable. We cannot offer any guarantee regarding lost programmes.

An unusually loud sound is coming from the rotating disc.

- If you want copy to perform more quietly, select "Normal (Silent)" in "Disc Speed for High Speed Copy". (⇒ 62)

The time recorded on the disc and the available time shown do not add up.

- **[DVD-R] [+R]** If you record or edit many times, the remaining capacity is reduced and then recording or editing may be disabled.
- Available disc space display may be different from actual.

Play

Cannot play back.

- The disc is dirty. (⇒ 17)
- The disc is scratched or marked.
- The disc may not be able to play back if it was not finalised or a Top Menu was not created on the equipment used for recording.
- Refer to "Screen icons". (⇒ 29)

Audio and video momentarily pause.

- DVD-R DL and +R DL discs have two writable layers on one side. Video and audio may momentarily cut out when the unit is switching layers.

You have forgotten your rating PIN.

- The rating level returns to the factory preset.
 - 1 While the unit is on, press and hold [OK], the yellow button and the blue button at the same time for more than 5 seconds.
 - "00 RET" is displayed on the front panel display.
 - 2 Repeatedly press [▶] (right) until "03 VL" is displayed on the front panel display.
 - 3 Press [OK].
 - "INIT" is displayed on the front panel display.

Image for the Quick View is not smooth.

- Image may not be played back smoothly in case of high definition titles.

Cannot play the disc on other players.

- Refer to "Play on other players". (⇒ 17)

Edit

Cannot edit.

- You may not be able to edit on the HDD if there is no available space. Delete any unwanted titles to create empty space. (⇒ 36)

Photo

Photos do not play back normally.

- The images that were edited on the PC, such as Progressive JPEG, etc., may not play back. (⇒ 15)

USB

This unit does not recognize the USB device correctly.

- If inserted during playback the USB device may not be recognized by this unit. Disconnect and reconnect the USB device. If it still does not recognize the connection, switch the unit to standby mode and turn it on again.
- USB devices connected using a USB extension cable other than a dedicated one or a USB hub may not be recognized by this unit.

TV Guide

The TV Guide information is not displayed properly.

- Set the clock correctly. (⇒ 66, Clock)
- There was a programme change, or TV Guide information from a broadcast station was possibly not correctly transmitted.
- If signal quality is bad, the TV Guide system may not be able to receive any data.
- It may take time until the TV Guide screen is displayed correctly. Wait for about a day.

Broadcast

Picture regularly breaks up on some channels.

- Adjust the reception with "Manual Tuning". (⇒ 60)

Reset

To return all the settings to the factory preset

Perform "Shipping Condition" or "Default Settings". (⇒ 66)

Messages on the front panel display

The following messages or service numbers appear on the front panel display when something unusual is detected.

BD □

("□" stands for a number.)

The remote control and main unit are using different codes. Change the code on the remote control. (⇒ 67)

CONV

Selected titles in the USB HDD are being converted. Do not disconnect the USB HDD from this unit.

GUIDE

TV Guide data is being downloaded.

NoERAS

You cannot delete items on this disc. The disc may be damaged.

NoREAD

- The disc is dirty. (⇒ 17) The unit cannot read the disc.
- The lens cleaner has finished cleaning.
Press [▲ OPEN/CLOSE] on the main unit to eject the disc.

NoWRIT

You cannot write to this disc. The disc may be damaged. Use a new disc.

PLEASE WAIT

- Displayed when the unit is started and is switched to standby mode.
- There was a power failure or the AC plug was disconnected while the unit was on. The unit is carrying out its recovery process. Wait until the message disappears.

PROG FULL

There are already 32 timer programmes. Delete unnecessary timer programmes. (⇒ 27)

REMOVE

The USB device is drawing too much power. Remove the USB device.

START

Update of the software (firmware) is started. You cannot operate the unit until the update is complete. (⇒ 56)

SW-DL

Software (firmware) is downloading.
Download will stop when the unit is turned on, or the timer recording starts. (⇒ 56)
When "FINISH" is displayed, update of the software (firmware) has completed.

UNSUPPORT

The media is not supported.

UPD □□

("□" stands for a number.)

The software (firmware) is being updated. You cannot operate the unit until the update is complete. (⇒ 56)

U50

An error has occurred in the antenna's power supply. Check to see if the antenna's cable core and braided wire shield are in contact with each other.

U59

The unit is hot. The unit switches to standby for safety reasons. Wait for about 30 minutes until the message disappears.

Install or place this unit with good ventilation.

U61

(When a disc is not inserted) A malfunction has occurred. The unit is trying to restore to the normal operation. Once the message disappears you can use the unit again. If it remains displayed, consult the dealer.

U76

HDMI cannot be output because it is connected to a model that does not support copyright protection.

U77

Due to the current disc not having authorised copyright information, video output is not performed.

U88

(When a disc is inserted) There was something unusual detected with the disc or the unit. The unit is trying to restore to the normal operation. Once the message disappears you can use the unit again. If it remains displayed, consult the dealer.

U99

The unit fails to operate properly. Press [⏪/I] on the main unit to switch the unit to standby mode. Now press [⏩/I] on the main unit again to turn the unit on.

X HOLD

The HOLD function is activated. (⇒ 59)

Specifications

Specifications are subject to change without notice.

■ General

Dimensions: 430 mm (W)
41.5 mm (H)
(including the projecting parts)
193 mm (D)

Mass: Approx. 1.8 kg

Power supply: AC 220 V to 240 V, 50 Hz

Power consumption: Approx. 25 W

Power consumption in standby mode:

“Quick Start” is not activated and
“RF OUT (Aerial Signal)” is set to “Off”
Approx. 0.2 W

Operating temperature: 5 °C to 40 °C

Operating humidity range: 10 % to 80 % RH
(no condensation)

■ TV system

Tuner System: DVB-T

Country: Australia, New Zealand

Channel Coverage:

For Australia VHF 6~12
UHF 27~69

For New Zealand UHF 21~69

■ Video/Audio terminals

Analogue video input (pin jack): 1 pc.

Input level: 1 Vp-p (75 Ω)

Analogue audio L/R input (pin jack): 1 pc.

Input level: Full scale 2.0 Vrms at 1 kHz (> 10 kΩ)

Digital audio output (coaxial): 1 pc.

HDMI output (19 pin type A): 1 pc.

■ Internal HDD capacity

500 GB

■ Other terminals

USB Port (Type A): USB2.0
2 pcs.

LAN (Ethernet) Port: 1 pc.
10BASE-T/100BASE-TX

■ LASER specification

Class 1 LASER Product

Wave length:

405 nm (BDs)

661 nm (DVDs)

783 nm (CDs)

Laser power:

No hazardous radiation is emitted with
the safety protection

Recording modes and approximate recording times

Depending on the content being recorded, the recording time may become shorter than indicated.

■ DR mode

Recording time of DR mode may vary depending on the bit rate of broadcasting.

For Australia

Recording Mode	HDD (500 GB)	BD-RE, BD-R	
		Single Layer (25 GB)	Dual Layer (50 GB)
DR (HD quality)	69 hours	3 hours 20 min.	6 hours 40 min.
DR (SD quality)	131 hours	6 hours 30 min.	13 hours

• High Definition (HD) quality: estimated bit rate is 15 Mbps

• Standard Definition (SD) quality: estimated bit rate is 8 Mbps

For New Zealand

Recording Mode	HDD (500 GB)	BD-RE, BD-R	
		Single Layer (25 GB)	Dual Layer (50 GB)
DR (HD quality)	75 hours	3 hours 30 min.	7 hours 30 min.
DR (SD quality)	211 hours	10 hours 15 min.	21 hours

• High Definition (HD) quality: estimated bit rate is 14 Mbps

• Standard Definition (SD) quality: estimated bit rate is 5 Mbps

■ **HG, HX, HE, HL, HM modes**

Recording Mode	HDD (500 GB)	BD-RE, BD-R	
		Single Layer (25 GB)	Dual Layer (50 GB)
HG	78 hours	4 hours	8 hours
HX	117 hours	6 hours	12 hours
HE	176 hours	9 hours	18 hours
HL	235 hours	12 hours	24 hours
HM	341 hours	17 hours 30 min.	35 hours

■ **XP, SP, LP, EP modes**

Recording Mode	HDD (500 GB)	BD-RE, BD-R	
		Single Layer (25 GB)	Dual Layer (50 GB)
XP	107 hours	5 hours 15 min.	10 hours 30 min.
SP	215 hours	10 hours 30 min.	21 hours
LP	430 hours	21 hours	42 hours
EP	860 hours	42 hours	84 hours

Recording Mode	DVD-RAM	
	Single-sided (4.7 GB)	Double-sided (9.4 GB)
XP	1 hour	2 hours
SP	2 hours	4 hours
LP	4 hours	8 hours
EP	8 hours	16 hours

Recording Mode	DVD-R, DVD-RW, +R, +RW (4.7 GB)	DVD-R DL, +R DL (8.5 GB)
XP	1 hour	1 hour 45 min.
SP	2 hours	3 hours 35 min.
LP	4 hours	7 hours 10 min.
EP	8 hours	14 hours 20 min.

• **Regarding recording time remaining:**

This unit records using a VBR (Variable bit rate) data compression system to vary recorded data segments to match video data segments which may cause differences in the displayed amount of time and space remaining for recording.

Audio information

The audio output differs depending on the setting on this unit. (⇒ 63, Digital Audio Output)

- The number of channels listed is the maximum possible number of output channels when connected to amplifier/receiver compatible with the respective audio format.

Terminal	Digital Audio Output	
	Bitstream	PCM* ¹
HDMI AV OUT	Output using original audio* ²	BD-Video: 7.1ch PCM* ^{2,3}
		DVD-Video: 5.1ch PCM
DIGITAL AUDIO OUT	Dolby Digital/ DTS Digital Surround™	Down-mixed 2ch PCM

*¹ The maximum possible number of Dolby sound is 2ch PCM.

*² When “BD-Video Secondary Audio” is set to “On”, the audio will be output as Dolby Digital, DTS Digital Surround™ or 5.1ch PCM.

*³ The audio output is amplified from 5.1ch or 6.1ch to 7.1ch depending on the DTS, Inc. specifications.

Language code list

Abkhazian:	6566	Lingala:	7678
Afar:	6565	Lithuanian:	7684
Afrikaans:	6570	Macedonian:	7775
Albanian:	8381	Malagasy:	7771
Amharic:	6577	Malay:	7783
Arabic:	6582	Malayalam:	7776
Armenian:	7289	Maltese:	7784
Assamese:	6583	Maori:	7773
Aymara:	6589	Marathi:	7782
Azerbaijani:	6590	Moldavian:	7779
Bashkir:	6665	Mongolian:	7778
Basque:	6985	Nauru:	7865
Bengali; Bangla:	6678	Nepali:	7869
Bhutan:	6890	Norwegian:	7879
Bihari:	6672	Oriya:	7982
Breton:	6682	Pashto, Pushto:	8083
Bulgarian:	6671	Persian:	7065
Burmese:	7789	Polish:	8076
Byelorussian:	6669	Portuguese:	8084
Cambodian:	7577	Punjabi:	8065
Catalan:	6765	Quechua:	8185
Chinese:	9072	Rhaeto-Romance:	8277
Corsican:	6779	Romanian:	8279
Croatian:	7282	Russian:	8285
Czech:	6783	Samoan:	8377
Danish:	6865	Sanskrit:	8365
Dutch:	7876	Scots Gaelic:	7168
English:	6978	Serbian:	8382
Esperanto:	6979	Serbo-Croatian:	8372
Estonian:	6984	Shona:	8378
Faroese:	7079	Sindhi:	8368
Fiji:	7074	Singhalese:	8373
Finnish:	7073	Slovak:	8375
French:	7082	Slovenian:	8376
Frisian:	7089	Somali:	8379
Galician:	7176	Spanish:	6983
Georgian:	7565	Sundanese:	8385
German:	6869	Swahili:	8387
Greek:	6976	Swedish:	8386
Greenlandic:	7576	Tagalog:	8476
Guarani:	7178	Tajik:	8471
Gujarati:	7185	Tamil:	8465
Hausa:	7265	Tatar:	8484
Hebrew:	7387	Telugu:	8469
Hindi:	7273	Thai:	8472
Hungarian:	7285	Tibetan:	6679
Icelandic:	7383	Tigrinya:	8473
Indonesian:	7378	Tonga:	8479
Interlingua:	7365	Turkish:	8482
Irish:	7165	Turkmen:	8475
Italian:	7384	Twi:	8487
Japanese:	7465	Ukrainian:	8575
Javanese:	7487	Urdu:	8582
Kannada:	7578	Uzbek:	8590
Kashmiri:	7583	Vietnamese:	8673
Kazakh:	7575	Volapük:	8679
Kirghiz:	7589	Welsh:	6789
Korean:	7579	Wolof:	8779
Kurdish:	7585	Xhosa:	8872
Laotian:	7679	Yiddish:	7473
Latin:	7665	Yoruba:	8979
Latvian, Lettish:	7686	Zulu:	9085

Licenses

"AVCHD", "AVCHD 3D", "AVCHD Progressive" and "AVCHD 3D/Progressive" are trademarks of Panasonic Corporation and Sony Corporation.

Copyright 2004-2014 Verance Corporation. Cinavia™ is a Verance Corporation trademark. Protected by U.S. Patent 7,369,677 and worldwide patents issued and pending under license from Verance Corporation. All rights reserved.

DVB and the DVB logos are trademarks of the DVB Project.

Dolby, Dolby Audio, and the double-D symbol are trademarks of Dolby Laboratories.



For DTS patents, see <http://patents.dts.com>. Manufactured under license from DTS Licensing Limited. DTS, DTS-HD, the Symbol, & DTS and the Symbol together are registered trademarks, and DTS-HD Master Audio | Essential is a trademark of DTS, Inc. © DTS, Inc. All Rights Reserved.



"DVD Logo" is a trademark of DVD Format/Logo Licensing Corporation.

MPEG Layer-3 audio coding technology licensed from Fraunhofer IIS and Thomson.

This product is licensed under the AVC patent portfolio license for the personal use of a consumer or other uses in which it does not receive remuneration to (i) encode video in compliance with the AVC Standard ("AVC Video") and/or (ii) decode AVC Video that was encoded by a consumer engaged in a personal activity and/or was obtained from a video provider licensed to provide AVC Video.

No license is granted or shall be implied for any other use.
Additional information may be obtained from MPEG LA, L.L.C.
See <http://www.mpegla.com>

This product is licensed under the VC-1 patent portfolio license for the personal and non-commercial use of a consumer to (i) encode video in compliance with the VC-1 Standard ("VC-1 Video") and/or (ii) decode VC-1 Video that was encoded by a consumer engaged in a personal and non-commercial activity and/or was obtained from a video provider licensed to provide VC-1 video.

No license is granted or shall be implied for any other use. Additional information may be obtained from MPEG LA, L.L.C.
See <http://www.mpegla.com>

The terms HDMI and HDMI High-Definition Multimedia Interface, and the HDMI Logo are trademarks or registered trademarks of HDMI Licensing LLC in the United States and other countries.

Java is a registered trademark of Oracle and/or its affiliates.



This product incorporates the following software:

- (1) the software developed independently by or for Panasonic Corporation,
- (2) the software owned by third party and licensed to Panasonic Corporation,
- (3) the software licensed under the GNU General Public License, Version 2.0 (GPL V2.0),
- (4) the software licensed under the GNU LESSER General Public License, Version 2.1 (LGPL V2.1), and/or
- (5) open source software other than the software licensed under the GPL V2.0 and/or LGPL V2.1.

The software categorized as (3) - (5) are distributed in the hope that it will be useful, but WITHOUT ANY WARRANTY, without even the implied warranty of MERCHANTABILITY or FITNESS FOR A PARTICULAR PURPOSE. Please refer to the detailed terms and conditions thereof shown in the Basic Settings menu.

At least three (3) years from delivery of this product, Panasonic will give to any third party who contacts us at the contact information provided below, for a charge no more than our cost of physically performing source code distribution, a complete machine-readable copy of the corresponding source code covered under GPL V2.0, LGPL V2.1 or the other licenses with the obligation to do so, as well as the respective copyright notice thereof.

Contact Information: oss-cd-request@gg.jp.panasonic.com

The source code and the copyright notice are also available for free in our website below.

<http://panasonic.net/avc/oss/>

MS/PlayReady/Final Product Labeling

This product contains technology subject to certain intellectual property rights of Microsoft. Use or distribution of this technology outside of this product is prohibited without the appropriate license(s) from Microsoft.

MS/PlayReady/End User Notices

Content owners use Microsoft PlayReady™ content access technology to protect their intellectual property, including copyrighted content. This device uses PlayReady technology to access PlayReady-protected content and/or WMDRM-protected content. If the device fails to properly enforce restrictions on content usage, content owners may require Microsoft to revoke the device's ability to consume PlayReady-protected content.

Revocation should not affect unprotected content or content protected by other content access technologies. Content owners may require you to upgrade PlayReady to access their content. If you decline an upgrade, you will not be able to access content that requires the upgrade.

Vorbis, FLAC

The software licenses are displayed when "Software Licence" in the Basic Settings menu is selected. (⇒ 66)

Restriction on use of unauthorized copied content

This unit adopts the following technology for copyright protection.

Cinavia Notice

This product uses Cinavia technology to limit the use of unauthorized copies of some commercially-produced film and videos and their soundtracks. When a prohibited use of an unauthorized copy is detected, a message will be displayed and playback or copying will be interrupted. More information about Cinavia technology is provided at the Cinavia Online Consumer Information Center at <http://www.cinavia.com>. To request additional information about Cinavia by mail, send a postcard with your mailing address to:

Cinavia Consumer Information Center, P.O.

Box 86851, San Diego, CA, 92138, USA.

Limited Warranty (ONLY FOR AUSTRALIA)

Panasonic Warranty

1. The product is warranted for 12 months from the date of purchase. Subject to the conditions of this warranty Panasonic or its Authorised Service Centre will perform necessary service on the product without charge for parts or labour, if in the opinion of Panasonic, the product is found to be faulty within the warranty period.
2. This warranty only applies to Panasonic products purchased in Australia and sold by Panasonic Australia or its Authorised Distributors or Dealers and only where the products are used and serviced within Australia or its territories. Warranty cover only applies to service carried out by a Panasonic Authorised Service Centre and only if valid proof of purchase is presented when warranty service is requested.
3. This warranty only applies if the product has been installed and used in accordance with the manufacturer's recommendations (as noted in the operating instructions) under normal use and reasonable care (in the opinion of Panasonic). The warranty covers normal domestic use only and does not cover damage, malfunction or failure resulting from use of incorrect voltages, incorrect installation, accident, misuse, neglect, build-up of dirt or dust, abuse, maladjustment of customer controls, mains supply problems, thunderstorm activity, infestation by insects or vermin, tampering or repair by unauthorised persons (including unauthorised alterations), introduction of sand, humidity or liquids, commercial use such as hotel, office, restaurant, or other business or rental use of the product, exposure to abnormally corrosive conditions or any foreign object or matter having entered the product.
4. This warranty does not cover the following items unless the fault or defect existed at the time of purchase:
 - (a) Cabinet Part(s)
 - (b) Video or Audio Tapes
 - (c) SD cards or USB devices
 - (d) User replaceable Batteries
etc
 - (e) DVD, Blu-ray or Recordable Discs
 - (f) Video / Audio Heads from wear and tear in normal use
 - (g) Information stored on Hard Disk Drive, USB stick or SD card
 - (h) DTV reception issues caused by TV Aerial / Cabling / Wall socket(s)
5. Some products may be supplied with Ethernet connection hardware. The warranty is limited on such products and will not cover
 - (a) Internet and or DLNA connection / setup related problems
 - (b) Access fees and or charges incurred for internet connection
 - (c) The use of incompatible software or software not specifically stipulated in the product operations manual;
and
 - (d) Any indirect or consequential costs associated with the incorrect use or misuse of the hardware, its connection to the internet or any other device.
6. To claim warranty service, when required, you should:
 - Telephone Panasonic's Customer Care Centre on 132600 or visit our website referred to below and use the Service Centre Locator for the name/address of the nearest Authorised Service Centre.
 - Send or take the product to a Panasonic Authorised Service Centre together with your proof of purchase receipt as a proof of purchase date. Please note that freight and insurance to and / or from your nearest Authorised Service Centre must be arranged by you.
 - Note that home or pick-up/delivery service is available for the following products in the major metropolitan areas of Australia or the normal operating areas of the nearest Authorised Service Centres:
 - Plasma/LCD televisions / displays (screen size greater than 103 cm)
7. The warranties hereby conferred do not extend to, and exclude, any costs associated with the installation, de-installation or re-installation of a product, including costs related to the mounting, de-mounting or remounting of any screen, (and any other ancillary activities), delivery, handling, freighting, transportation or insurance of the product or any part thereof or replacement of and do not extend to, and exclude, any damage or loss occurring by reason of, during, associated with, or related to such installation, de-installation, re-installation or transit.

Panasonic Authorised Service Centres are located in major metropolitan areas and most regional centres of Australia, however, coverage will vary dependant on product. For advice on exact Authorised Service Centre locations for your product, please telephone our Customer Care Centre on 132600 or visit our website and use the Service Centre Locator.

In addition to your rights under this warranty, Panasonic products come with consumer guarantees that cannot be excluded under the Australian Consumer Law. If there is a major failure with the product, you can reject the product and elect to have a refund or to have the product replaced or if you wish you may elect to keep the goods and be compensated for the drop in value of the goods. You are also entitled to have the product repaired or replaced if the product fails to be of acceptable quality and the failure does not amount to a major failure.

If there is a major failure in regard to the product which cannot be remedied then you must notify us within a reasonable period by contacting the Panasonic Customer Care Centre. If the failure in the product is not a major failure then Panasonic may choose to repair or replace the product and will do so in a reasonable period of time from receiving notice from you.

**THIS WARRANTY CARD AND THE PURCHASE DOCKET (OR SIMILAR PROOF OF PURCHASE)
SHOULD BE RETAINED BY THE CUSTOMER AT ALL TIMES**

If you require assistance regarding warranty conditions or any other enquiries, please visit the **Panasonic Australia** website **www.panasonic.com.au** or contact by phone on **132 600**
If phoning in, please ensure you have your operating instructions available.

Panasonic Australia Pty. Limited

ACN 001 592 187 ABN 83 001 592 187

1 Innovation Road, Macquarie Park NSW 2113

PRO-031-F11 Issue: 4.0

01-01-2011

Index

A	
Aspect	20, 59
Audio	20, 33, 74
Audio Description (AD)	20, 35
Auto Setup	12, 60
AVCHD	28, 30, 46, 52
B	
Basic Settings	60
BD-Video	30
BD-Live	31, 61
3D	33
C	
Channel Information	19
Channel List	21, 60
Chapter	30, 39, 62
Child Lock	61
BD-Video Parental Control	61
DVD-Video Parental Control	61
HOLD function	59
Clock	66
Connection	9
Network	11
Copy	40
HD Video (AVCHD)	46, 52
D	
Delete	
Music	51, 62
Photo	49, 62
Video	36, 57, 62
Delete BD-Video data	31
Disc	
Finalise	58
Format	57
Media information	13
Protection	57
DVD-Video	30
E	
Easy setting	12
Entering text	58
F	
Favourites	60
Finalise	58
Format	
Disc	57
HDD	62
USB HDD	62
FUNCTION MENU	18
H	
HDD	
Format	62
Media information	13
L	
Language code list	74
Lens cleaner	5
M	
Manual Tuning	60
Menu screen	30
Music	50
N	
Network	
BD-Live	31
Connection	11
Easy Network Setting	12, 65
P	
PAUSE LIVE TV	21
Photo	47
PIN	19, 66
Playback menu	34
Protection	
Disc	57
Photo	49
Video	36

Q	
Quick Start	65
R	
Recording	22
From external equipment	52
Series Timer Recording	25
Timer recording	24
Recording mode (Conversion)	16
Recording time	72
Remote control	8
HOLD function	59
Remote control code	66
TV operation	11
Reset	66, 70
REWIND LIVE TV	21, 62
S	
Search the programmes	25
Series Timer Recording	25
Setting	
Auto Setup	12, 60
Easy setting	12
Slideshow	48
Software (Firmware) Update	56
T	
Timer recording	24
Top Menu	
Create Top Menu	58
Troubleshooting guide	67
Messages	71
Tuning	
Channel List	60
Manual Tuning	60
Parental Rating	61
Signal Condition	61
TV Guide	
Operation	20
Timer recording	24
TV System	64
U	
USB HDD	
Cancellation of all USB HDD Registrations	63
Disconnection	54, 62
Format	62
Media information	13, 16
Registration	54, 62
USB memories	
Media information	13, 16
V	
Video	
AVCHD	28, 30
BD-Video	30
Copy	40
Delete	36
DVD-Video	30
MKV	30
Playback	28, 30
Protection	36
Recording	22
Video Menu	28
3D	33
VIERA Link	55, 65
3D	33



**Disposal of Old Equipment and Batteries
Only for European Union and countries with recycle systems**

These symbols are only valid in the European Union and countries with recycle systems.

If you wish to discard this product, please contact your local authorities or dealer and ask for the correct method of disposal.

The recording and playback of content on this or any other device may require permission from the owner of the copyright or other such rights in that content. Panasonic has no authority to and does not grant you that permission and explicitly disclaims any right, ability or intention to obtain such permission on your behalf. It is your responsibility to ensure that your use of this or any other device complies with applicable copyright legislation in your country. Please refer to that legislation for more information on the relevant laws and regulations involved or contact the owner of the rights in the content you wish to record or playback.



DANGER	- VISIBLE AND INVISIBLE LASER RADIATION WHEN OPEN. AVOID DIRECT EXPOSURE TO BEAM. FDA21 CFR/CLASS III
CAUTION	- CLASS 3B VISIBLE AND INVISIBLE LASER RADIATION WHEN OPEN. AVOID EXPOSURE TO THE BEAM. IEC60825-1/CLASS 3B
ATTENTION	- RAYONNEMENT LASER VISIBLE ET INVISIBLE, CLASSE 3B, EN CAS D'OUVERTURE, EVITER UNE EXPOSITION AU FAISCEAU.
FORSIGTIG	- SYNLIG OG USYNLIG LASERSTRÅLING KLASSE 3B. NÅR LÅGET ER ÅBENT, UNDGÅ AT BLIVE UDSÅT FOR STRÅLEN.
VARO	- AVATTASSA OLET ALTIINNA LUKKAN 3B NÄKYVÄÄ JA NÄKYMÄTÖNTÄ LASERSÄTELYÄ, VARO ALTISTUMISTA SÄTEELLE.
VARNING	- KLASS 3B SYNLIG OCH OSYNLIG LASERSTRÅLNING NÄR DENNA DEL ÄR ÖPPNAD, UNDVIK EXPONERING FÖR STRÅLEN.
VORSICHT	- SICHTBARE UND UNSICHTBARE LASERSTRAHLUNG KLASSE 3B, WENN ABDECKUNG GEÖFFNET, NICHT DEM STRAHL AUSSETZEN.
注意	- 打开时有可见及不可见激光辐射。避免光束照射。
注意	- ここを開くとクラス3Bの可視及び不可視レーザー放射が出る。ビームの目又は皮膚への照射は危険！
	見たり触れたりしないこと VQL2Q40

(Inside of product)

Panasonic Corporation
Web Site: <http://www.panasonic.com>



SQT1111-1
F0316MH1046