

Table of Contents

Table of Contents	1	<i>OPTIONS Advanced</i>	38
Usage Notice	2	<i>OPTIONS Lamp Settings</i>	39
<i>Safety Information</i>	2	<i>OPTIONS Filter Settings</i>	40
<i>Precautions</i>	3	Appendices	41
<i>Eye Safety Warnings</i>	5	<i>Troubleshooting</i>	41
<i>Product Features</i>	5	<i>Replacing the lamp</i>	46
Introduction	6	<i>Compatibility Modes</i>	48
<i>Package Overview</i>	6	<i>Computer Compatibility</i>	48
<i>Product Overview</i>	7	<i>Video Compatibility</i>	49
<i>Main Unit</i>	7	<i>3D input Compatibility</i>	50
<i>Input/Output Connections</i>	8	RS232 Commands and Protocol	
<i>Remote Control</i>	9	<i>Function List</i>	51
Installation	10	<i>RS232 Pin Assignments</i>	51
<i>Connecting the Projector</i>	10	<i>RS232 Protocol Function List</i>	52
<i>Connect to Computer/Notebook</i>	10	<i>Optoma Global Offices</i>	55
<i>Connect to Video Sources</i>	11	<i>Regulation & Safety Notices</i>	57
<i>Powering the projector On / Off</i>	12		
<i>Powering On the Projector</i>	12		
<i>Powering off the projector</i>	13		
<i>Warning Indicator</i>	13		
<i>Adjusting the Projected Image</i>	14		
<i>Adjusting the Projector's Height</i>	14		
<i>Adjusting the Projector's Zoom /</i>			
<i>Focus</i>	15		
<i>Adjusting Projection Image Size</i>	15		
User Controls	17		
<i>Remote Control</i>	17		
<i>On-screen Display Menus</i>	19		
<i>How to operate</i>	19		
<i>Menu Tree</i>	20		
<i>IMAGE</i>	22		
<i>IMAGE Advanced</i>	24		
<i>IMAGE Advanced Signal (RGB)</i> ...	26		
<i>DISPLAY</i>	27		
<i>DISPLAY 3D</i>	30		
<i>SETUP</i>	31		
<i>SETUP Security</i>	33		
<i>SETUP Audio Settings</i>	35		
<i>SETUP Advanced</i>	36		
<i>OPTIONS</i>	37		

Safety Information

	The lightning flash with arrow head within an equilateral triangle is intended to alert the user to the presence of uninsulated "dangerous voltage" within the product's enclosure that may be of sufficient magnitude to constitute a risk of electric shock to persons.
	The exclamation point within an equilateral triangle is intended to alert the user to the presence of important operating and maintenance (servicing) instructions in the literature accompanying the appliance.

WARNING: TO REDUCE THE RISK OF FIRE OR ELECTRIC SHOCK, DO NOT EXPOSE THIS APPLIANCE TO RAIN OR MOISTURE. DANGEROUS HIGH VOLTAGES ARE PRESENT INSIDE THE ENCLOSURE. DO NOT OPEN THE CABINET. REFER SERVICING TO QUALIFIED PERSONNEL ONLY.

Class B emissions limits

This Class B digital apparatus meets all requirements of the Canadian Interference-Causing Equipment Regulations.

Important Safety Instruction

1. Do not block any ventilation openings. To ensure reliable operation of the projector and to protect from over heating, it is recommended to install the projector in a location that does not block ventilation. As an example, do not place the projector on a crowded coffee table, sofa, bed, etc. Do not put the projector in an enclosure such as a book case or a cabinet that restricts air flow.
2. Do not use the projector near water or moisture. To reduce the risk of fire and/or electric shock, do not expose the projector to rain or moisture.
3. Do not install near heat sources such as radiators, heaters, stoves or any other apparatus such as amplifiers that emits heat.
4. Clean only with dry cloth.
5. Only use attachments/accessories specified by the manufacturer.
6. Do not use the unit if it has been physically damaged or abused.
Physical damage/abuse would be (but not limited to):
 - Unit has been dropped.
 - Power supply cord or plug has been damaged.
 - Liquid has been spilled on to the projector.
 - Projector has been exposed to rain or moisture.
 - Something has fallen in the projector or something is loose inside.Do not attempt to service the unit yourself. Opening or removing covers may expose you to dangerous voltages or other hazards. Please call Optoma before you send the unit for repair.
7. Do not let objects or liquids enter the projector. They may touch dangerous voltage points and short out parts that could result in fire or electric shock.
8. See projector enclosure for safety related markings.
9. The unit should only be repaired by appropriate service personnel.

Precautions



Please follow all warnings, precautions and maintenance as recommended in this user's guide.

- Warning- Do not look into the projector's lens when the lamp is on. The bright light may hurt and damage your eyes.
- Warning- To reduce the risk of fire or electric shock, do not expose this projector to rain or moisture.
- Warning- Please do not open or disassemble the projector as this may cause electric shock.
- Warning- When replacing the lamp, please allow the unit to cool down. Follow instructions as described on pages 46-47.
- Warning- This projector will detect the life of the lamp itself. Please be sure to change the lamp when it shows warning messages.
- Warning- Reset the "Lamp Reset" function from the on-screen display "OPTIONS | Lamp Settings" menu after replacing the lamp module (refer to page 39).
- Warning- When switching the projector off, please ensure the cooling cycle has been completed before disconnecting power. Allow 90 seconds for the projector to cool down.
- Warning- Do not use lens cap when projector is in operation.
- Warning- When the lamp is approaching the end of its lifetime, the message "Lamp Warning: Lamp life exceeded." will show on the screen. Please contact your local reseller or service center to change the lamp as soon as possible.
- Warning- Do not look into or point the laser pointer on your remote control into your or someone's eyes. Laser pointer can cause permanent damage to eyesight.



- ❖ When the lamp reaches the end of its life, the projector will not turn back on until the lamp module has been replaced. To replace the lamp, follow the procedures listed under "Replacing the Lamp" section on pages 46-47.

Usage Notice

Do:

- ❖ Turn off and unplug the power plug from the AC outlet before cleaning the product.
- ❖ Use a soft dry cloth with mild detergent to clean the display housing.
- ❖ Disconnect the power plug from AC outlet if the product is not being used for a long period of time.

Do not:

- ❖ Block the slots and openings on the unit provided for ventilation.
- ❖ Use abrasive cleaners, waxes or solvents to clean the unit.
- ❖ Use under the following conditions:
 - In extremely hot, cold or humid environments.
 - ▶ Ensure that the ambient room temperature is within 5 - 40°C.
 - ▶ Relative Humidity is 5 - 40°C, 80% (Max.), non-condensing.
 - In areas susceptible to excessive dust and dirt.
 - Near any appliance generating a strong magnetic field.
 - In direct sunlight.

Eye Safety Warnings



- Avoid staring/facing directly into the projector beam at all times. Keep your back to the beam as much as possible.
- When projector is used in a classroom, adequately supervise students when they are asked to point out something on the screen.
- In order to minimize the lamp power, use room blinds to reduce ambient light levels.

Product Features

- SVGA (800x600) / XGA (1024x768) / WXGA (1280X800) Native resolution
- HD compatible – 720p and 1080p supported
- BrilliantColor™ Technology
- Kensington Lock
- RS232 control
- Rapid shutdown
- 3D Ready (See page 50)

Introduction

Package Overview

Unpack and inspect the box contents to ensure all parts listed below are in the box. If something is missing, please contact your nearest customer service center.

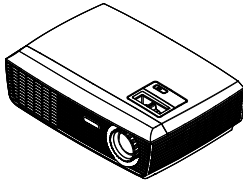

Projector

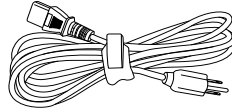

Power Cord 1.8m

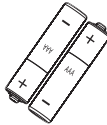

2 × AAA Batteries



IR Remote Control



❖ Due to different applications in each Country, some regions may have different accessories.

Documentation :

- User's Manual
- Warranty Card
- Quick Start Card
- WEEE Card
(for EMEA only)

Introduction

Product Overview

Main Unit

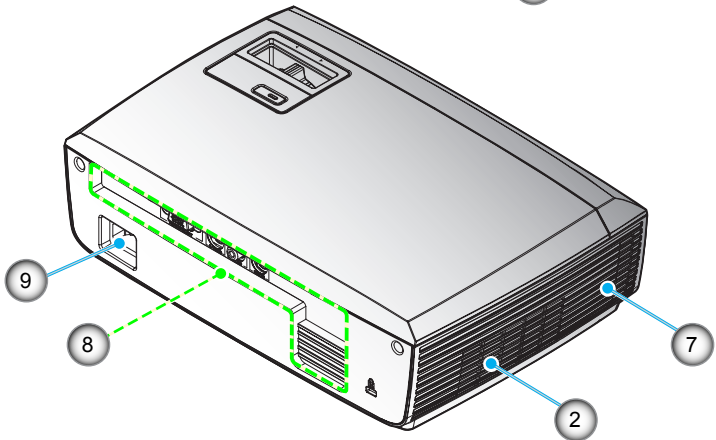
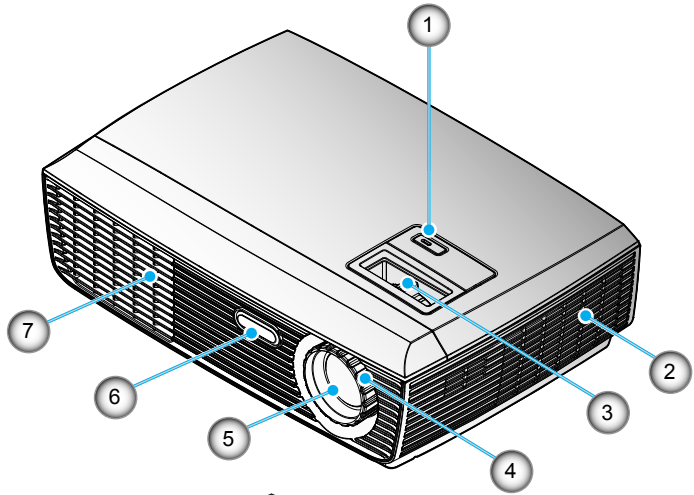

NOTE

- ❖ The interface is subject to model's specifications.
- ❖ Do not block projector in/out air vents.

- | | |
|-----------------------------------|-------------------------------|
| 1. POWER button and LED indicator | 5. Zoom Lens |
| 2. Ventilation (inlet) | 6. IR Receiver |
| 3. Zoom Ring | 7. Ventilation (outlet) |
| 4. Focus Ring | 8. Input / Output Connections |
| | 9. Power Socket |

Introduction

Input/Output Connections

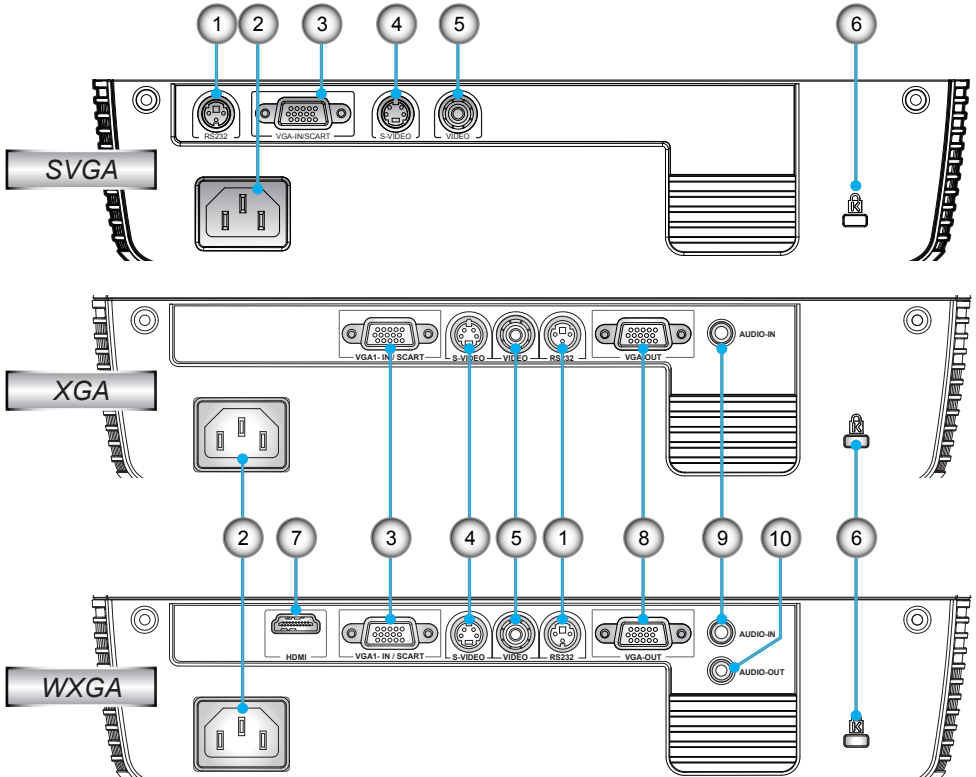

❖ Monitor loop through only supported in VGA-In/SCART.

1. RS-232 Connector (3-pin DIN Type)
2. Power Socket
3. VGA-In/SCART Connector
(PC Analog Signal/Component Video Input/HDTV/YPbPr/SCART)
4. S-Video Input Connector
5. Composite Video Input Connector
6. Kensington™ Lock Port
7. HDMI Connector
8. VGA-Out Connector (Monitor Loop-through Output)
9. Audio Input connector (3.5mm mini jack)
10. Audio Output Connector (3.5mm Mini Jack)

Introduction

Remote Control

1. LED Indicator
2. Power On/Off
3. No Function on this model
4. No Function on this model
5. Four Directional Select Keys
6. Re-Sync
7. No Function on this model
8. No Function on this model
9. Zoom
10. AV mute
11. Video
12. VGA
13. Freeze
14. S-Video
15. Contrast
16. Brightness
17. Menu
18. Keystone +/-
19. Source
20. Enter
21. No Function on this model
22. No Function on this model
23. Numbered keypad (for password input)

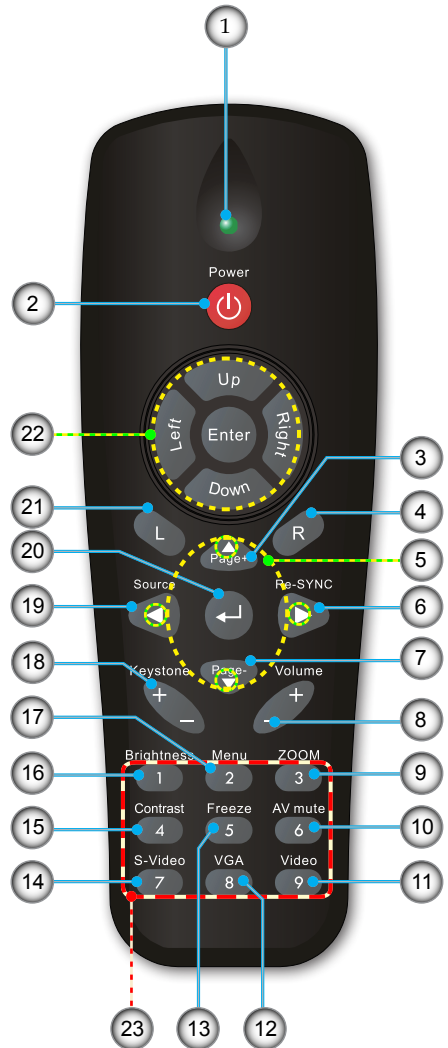

Installation

Connecting the Projector

Connect to Computer/Notebook

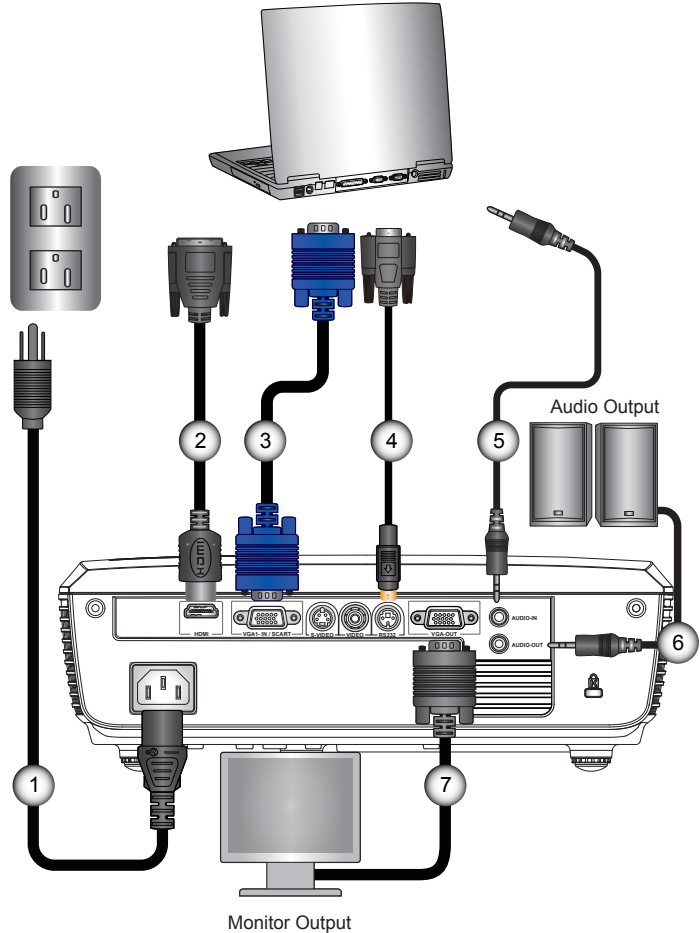

- ❖ Due to the difference in applications for each country, some regions may have different accessories.
- ❖ (*) Optional accessory
- ❖ The interface is subject to model's specifications .

1.....	Power Cord
2.....	*DVI/HDMI Cable
3.....	*VGA Cable
4.....	*RS232 Cable
5.....	*Audio Input Cable
6.....	*Audio Output Cable
7.....	*VGA Out Cable

Installation

Connect to Video Sources

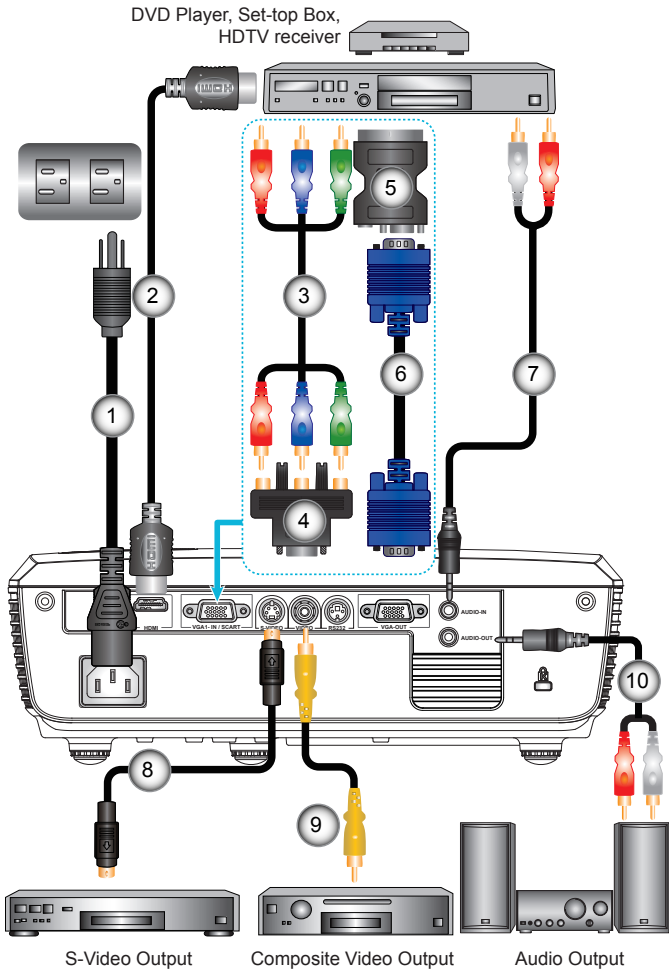

- ❖ Due to the difference in applications for each country, some regions may have different accessories.
- ❖ (*) Optional accessory
- ❖ The interface is subject to model's specifications .

1.....	Power Cord
2.....	*HDMI Cable
3.....	*3 RCA Component Cable
4.....	*15-Pin to 3 RCA Component/HDTV Adaptor
5.....	*SCART/VGA Adaptor
6.....	*VGA Cable
7.....	*Audio Input Cable
8.....	*S-Video Cable
9.....	*Composite Video Cable
10.....	*Audio Output Cable

Powering the projector On / Off

Powering On the Projector



❖ When Power mode (Standby) is set to Eco (<0.5W), the VGA output and Audio pass-through will be deactivated when the projector is in standby.

1. Securely connect the power cord and signal cable. When connected, the Power LED will turn Red.
2. Turn on the lamp by pressing “POWER” button either on the top of the projector or on the remote. The Power LED will now turn Blue. ❶

The startup screen will display in approximately 10 seconds. The first time you use the projector, you can select your preferred language from quick menu after the startup screen displays.

3. Turn on and connect the source that you want to display on the screen (computer, notebook, video player, etc). The projector will detect the source automatically. If not, push menu button and go to “OPTIONS”. Make sure that the “Source Lock” has been set to “Off”.
- ❖ If you connect multiple sources at the same time, press the “SOURCE” button or direct source keys on the remote control to switch between inputs.

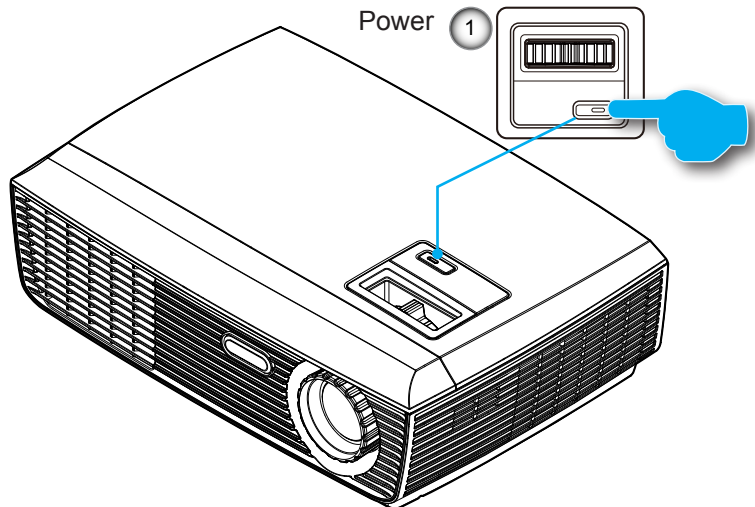

❖ Turn on the projector first and then select the signal sources.

Powering off the projector

1. Press the “POWER” button to turn off the projector lamp. The following message will be displayed on the screen.

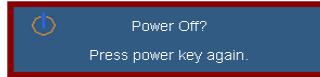

Press the “POWER” button again to confirm, otherwise the message will disappear after 15 seconds.

When you press the “POWER” button a second time, the system will show the countdown timer on the screen.

2. The cooling fans continue to operate for about 10 seconds for cooling cycle. When the Power LED turns Red, the projector has entered standby mode.

If you wish to turn the projector back on, you must wait until the projector has completed the cooling cycle and has entered standby mode. Once in standby mode, simply press “POWER” button to restart the projector.

3. Disconnect the power cord from the electrical outlet and the projector.
4. Do not turn on the projector immediately following a power off procedure.

Warning Indicator

- ❖ When the “POWER” indicator flashes red (0.5 sec off, 0.5 sec on), the projector will automatically shut down. Please call the nearest Optoma facility for assistance.
- ❖ When the “POWER” indicator flashes red (1.0 sec off, 1.0 sec on), it indicates the projector has overheated. The projector will shut down automatically. Under normal conditions, the projector can be switched on again after it has cooled down.
- ❖ When the “POWER” indicator flashes red (0.5 sec off, 2.0 sec on), it indicates the fan has failed.



- ❖ Contact the nearest service center if the projector displays these symptoms. See pages 55-56 for more information.

Adjusting the Projected Image

Adjusting the Projector's Height

The projector is equipped with elevator feet for adjusting the image height.

1. Locate the adjustable foot you wish to modify on the underside of the projector.
2. Rotate the adjustable ring clockwise to raise the projector or counter clockwise to lower it. Repeat with the remaining feet as needed.

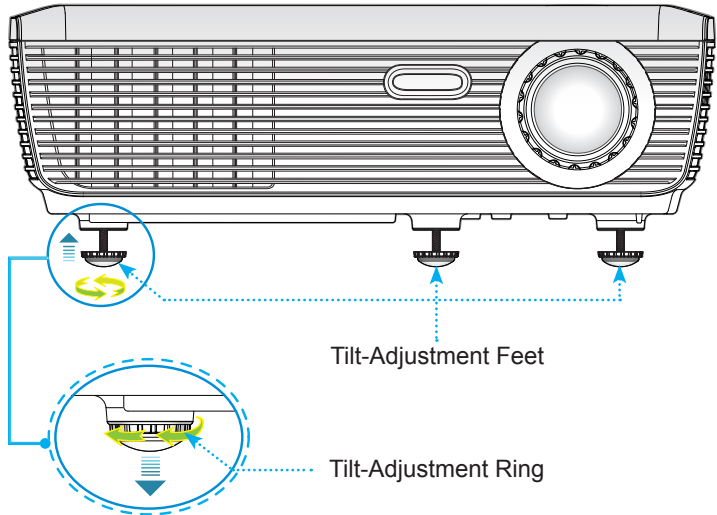

Installation

Adjusting the Projector's Zoom / Focus

You may turn the zoom ring to zoom in or out. To focus the image, rotate the focus ring until the image is clear.

- ▶ SVGA/XGA series: The projector will focus at distances from 3.28 to 39.4 feet (1.0 to 12.0 meters).
- ▶ WXGA series: The projector will focus at distances from 3.28 to 39.4 feet (1.0 to 12.0 meters).

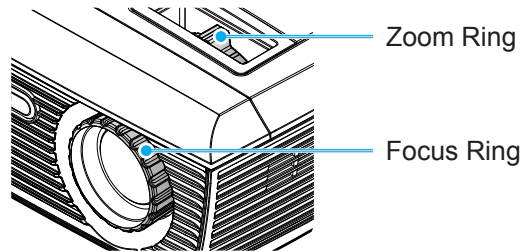

Adjusting Projection Image Size

- ▶ SVGA/XGA series: Projection Image Size from 22.9" to 300.0" (0.58 to 7.62 meters).
- ▶ WXGA series: Projection Image Size from 27.2" to 301.0" (0.69 to 7.65 meters).

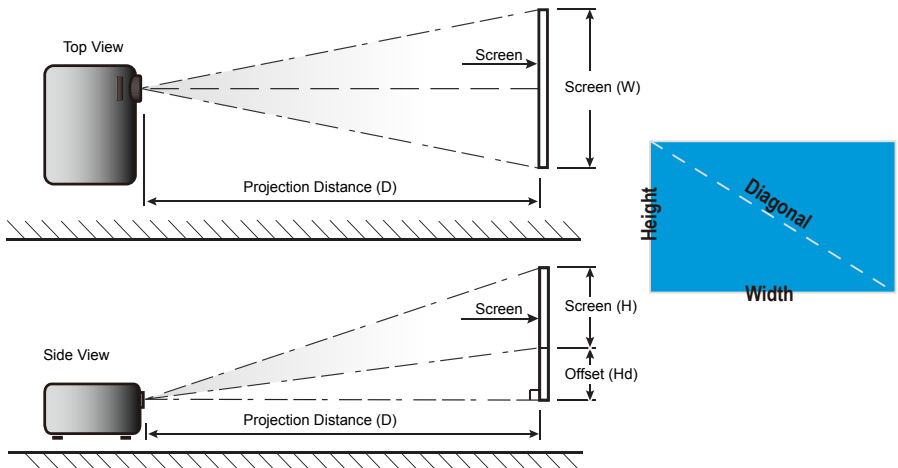

Installation

SVGA/XGA

Diagonal length (inch) size of 4:3 Screen	Screen Size W x H				Projection Distance (D)				Offset (Hd)	
	(m)		(inch)		(m)		(feet)			
	Width	Height	Width	Height	wide	tele	wide	tele	(m)	(inch)
30.00	0.61	0.46	24.00	18.00	1.19	1.31	3.90	4.30	0.07	2.70
40.00	0.81	0.61	32.00	24.00	1.58	1.75	5.20	5.73	0.09	3.60
60.00	1.22	0.91	48.00	36.00	2.38	2.62	7.80	8.60	0.14	5.40
70.00	1.42	1.07	56.00	42.00	2.77	3.06	9.10	10.03	0.16	6.30
80.00	1.63	1.22	64.00	48.00	3.17	3.50	10.40	11.46	0.18	7.20
90.00	1.83	1.37	72.00	54.00	3.57	3.93	11.70	12.90	0.21	8.10
100.00	2.03	1.52	80.00	60.00	3.96	4.37	13.00	14.33	0.23	9.00
120.00	2.44	1.83	96.00	72.00	4.75	5.24	15.60	17.20	0.27	10.80
150.00	3.05	2.29	120.00	90.00	5.94	6.55	19.50	21.49	0.34	13.50
180.00	3.66	2.74	144.00	108.00	7.13	7.86	23.39	25.79	0.41	16.20
250.00	5.08	3.81	200.00	150.00	9.91	10.92	32.49	35.82	0.57	22.49
300.00	6.10	4.57	240.00	180.00	11.89	13.11	38.99	42.99	0.69	26.99

WXGA

Diagonal length (inch) size of 16:10 Screen	Screen Size W x H				Projection Distance (D)				Offset (Hd)	
	(m)		(inch)		(m)		(feet)			
	Width	Height	Width	Height	wide	tele	wide	tele	(m)	(inch)
30.00	0.65	0.40	25.44	15.90	1.00	1.10	3.26	3.62	0.05	1.99
40.00	0.86	0.54	33.92	21.20	1.33	1.47	4.35	4.83	0.07	2.65
60.00	1.29	0.81	50.88	31.80	1.99	2.21	6.53	7.25	0.10	3.97
70.00	1.51	0.94	59.36	37.10	2.32	2.58	7.62	8.46	0.12	4.64
80.00	1.72	1.08	67.84	42.40	2.65	2.95	8.70	9.66	0.13	5.30
90.00	1.94	1.21	76.32	47.70	2.99	3.31	9.79	10.87	0.15	5.96
100.00	2.15	1.35	84.80	53.00	3.32	3.68	10.88	12.08	0.17	6.62
120.00	2.58	1.62	101.76	63.60	3.98	4.42	13.06	14.50	0.20	7.95
150.00	3.23	2.02	127.20	79.50	4.98	5.52	16.32	18.12	0.25	9.93
180.00	3.88	2.42	152.64	95.40	5.97	6.63	19.58	21.75	0.30	11.92
250.00	5.38	3.37	212.00	132.50	8.29	9.21	27.20	30.20	0.42	16.56
300.00	6.46	4.04	254.40	159.00	9.95	11.05	32.64	36.24	0.50	19.87







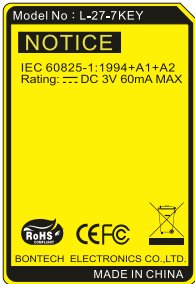

❖ This table is for user's reference only.

User Controls

Remote Control

Using the Remote Control



Power 	Refer to the “Power On/Off the Projector” section on pages 12-13.
L Button	No function.
R Button	No function.
Page +	No function.
Page -	No function.
Enter 	 Confirm your item selection.
Source	Press “Source” to select an input signal.
Re-SYNC	Automatically synchronizes the projector to the input source.
Four Directional Select Keys	Use     to select items or make adjustments to your selection.
Keystone +/-	Adjust image distortion caused by tilting the projector.
Volume +/-	No function.
Brightness	Adjust the brightness of the image.
ZOOM	Zoom in on an image. Press   buttons to alter zoom.
Menu	Press “Menu” to launch the on-screen display (OSD) menu. To exit OSD, press “Menu” again.
Contrast	Control the degree of difference between the lightest and darkest parts of the picture.
Freeze	Press “Freeze” to pause the screen image. Press this button again to unlock.

Using the Remote Control

AV mute	Momentarily turns off/on the audio and video.
S-Video	Press "S-Video" to choose S-Video source.
VGA	Press "VGA" to choose VGA sources.
Video	Press "Video" to choose Composite video source.

On-screen Display Menus

The Projector has multilingual On-screen Display menus that allow you to make image adjustments and change a variety of settings. The projector will automatically detect the source.

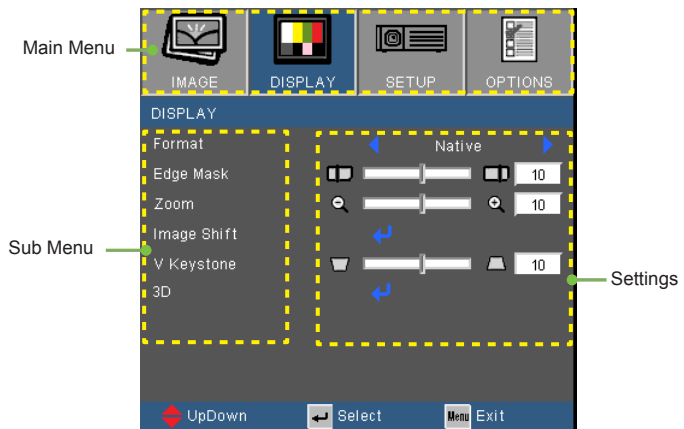

How to operate

1. To open the OSD menu, press “Menu” on the Remote Control or Projector Keypad.
2. When OSD is displayed, use ◀▶ keys to select any item in the main menu. While making a selection on a particular page, press ▼ or “Enter” key to enter sub menu.
3. Use ▲▼ keys to select the desired item and adjust the settings using ◀▶ key.
4. Select the next item to be adjusted in the sub menu and adjust as described above.
5. Press “Enter” to confirm, and the screen will return to the main menu.
6. To exit, press “MENU” again. The OSD menu will close and the projector will automatically save the new settings.



User Controls

Menu Tree

Main Menu	Sub Menu	Settings	
Image	Display Mode	Presentation / Bright / Movie / sRGB / Blackboard / User / 3D	
	Brightness	-50~50	
	Contrast	-50~50	
	Sharpness	1~15	
	#1 Color	-50~50	
	#1 Tint	-50~50	
	Advanced	Gamma	Film / Video / Graphics / Standard
		BrilliantColor™	1~10
		Color Temp.	Warm / Medium / Cold
		Color Settings	Red / Green / Blue / Cyan / Magenta / Yellow / Hue / Saturation / Gain
		White	R / G / B
		Reset	
		Exit	
		Color Space	AUTO / RGB / YUV #3 AUTO / RGB (0-255) / RGB (16-235) / YUV
		#2 Signal	Automatic On / Off
		Phase (VGA)	0~31
		Frequency (VGA)	-5~5
		H. Position (VGA)	-5~5
		V. Position (VGA)	-5~5
		Exit	
		Reset	
Display	Image Shift	#4 4:3 / 16:9 / Native / AUTO #5 4:3 / 16:9 or 16:10 / LBX / Native / AUTO	
	Edge Mask	0~10	
	Zoom	-5~25 (80%~200%)	
	Image Shift	H Image Shift -100~100 V Image Shift -100~100	
	V Keystone	-40~40	
	3D	3D Mode Off / DLP-Link / IR #6 3D Format Auto / SBS / Top and Bottom / Frame Sequential #6 3D Sync. Invert On / Off	
		Exit	
		Reset	
Setup	Language	English / Deutsch / Français / Italiano / Español / Português / Svenska / Nederlands / Norsk/Dansk / Polski / Suomi / Русский / ελληνικά / Magyar / Čeština / العربية / 繁體中文 / 简体中文 / 日本語 / 한국어 / ไทย / Türkçe / Việt / Bahasa Indonesia / Română	
	Projection		
	Menu Location		
	#5 Screen Type	16:10 / 16:9	

User Controls

Main Menu	Sub Menu	Settings		
Setup	Security	Security	On / Off	
		Security Timer	Month / Day / Hour	
		Change Password		
		Exit		
	Projector ID		0~99	
	Audio Settings	Internal Speaker	On / Off	
		Mute	On / Off	
		Volume	0~10	
	Advanced	Logo	Default / Neutral	
		Closed Captioning	Off / CC1 / CC2	
		Exit		
	Options	Input Source		^{#4} VGA / Video / S-Video ^{#5} VGA / Video / S-Video / HDMI
Source Lock			On / Off	
High Altitude			On / Off	
Information Hide			On / Off	
Test Pattern			None / Grid / White Pattern	
Background Color			Black / Red / Blue / Green / White	
Advanced		Direct Power On		On / Off
		Auto Power Off (min.)		0~180
		Sleep Timer (min.)		0~990
		Power Mode (Standby)		^{#7} Active / Eco
		Exit		
Lamp Settings		Lamp Hours		
		Lamp Reminder		On / Off
		Brightness Mode		Bright / Eco
		Lamp Reset		Yes / No
		Exit		
Optional Filter Settings		Optional Filter Installed		Yes / No
		Filter Usage Hours		0~9999
	Filter Reminder		Off / 300hr / 500hr / 800hr / 1000hr	
	Filter Reset		Yes / No	
	Exit			
Reset			Yes / No	



- ❖ Please note that the on-screen display (OSD) menus vary according to the signal type selected and the projector model you are using.
- ❖ (#1) "Color" and "Tint" are only supported in Video mode.
- ❖ (#2) "Signal" is only supported in Analog VGA (RGB) signal.
- ❖ (#3) For HDMI Source only.
- ❖ (#4) For XGA model only.
- ❖ (#5) For WXGA model only. 16:9 or 16:10 depend on "Screen Type" setting.
- ❖ (#6) "3D Sync Invert" is only available when 3D is enabled and this mode 3D is for DLP link glass only.
- ❖ (#7) For XGA/WXGA model only.

IMAGE



Display Mode

There are many factory presets optimized for various types of images.

- ▶ Presentation: Good color and brightness from PC input.
- ▶ Bright: Maximum brightness from PC input.
- ▶ Movie: For home theater.
- ▶ sRGB: Standardised accurate color.
- ▶ Blackboard: This mode should be selected to achieve optimum color settings when projecting onto a blackboard (green).
- ▶ User: User's settings.
- ▶ 3D: Recommend setting for 3D mode enabled. Any further adjustments by the user in 3D will be saved in this mode for further use.

Brightness

Adjust the brightness of the image.

- ▶ Press the ◀ to darken image.
- ▶ Press the ▶ to lighten the image.

Contrast

The contrast controls the degree of difference between the lightest and darkest parts of the picture.

- ▶ Press the ◀ to decrease the contrast.
- ▶ Press the ▶ to increase the contrast.



❖ “Color” and “Tint” functions are only supported under Video mode.

Sharpness

Adjust the sharpness of the image.

- ▶ Press the ◀ to decrease the sharpness.
- ▶ Press the ▶ to increase the sharpness.

Color

Adjust a video image from black and white to fully saturated color.

- ▶ Press the ◀ to decrease the amount of saturation in the image.
- ▶ Press the ▶ to increase the amount of saturation in the image.

Tint

Adjust the color balance of red and green.

- ▶ Press the ◀ to increase the amount of green in the image.
- ▶ Press the ▶ to increase the amount of red in the image.

IMAGE | Advanced

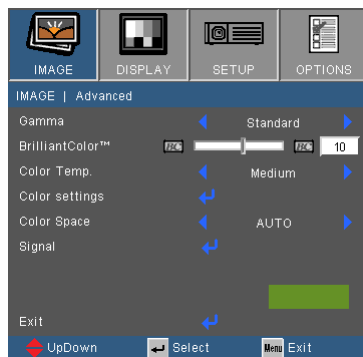

Gamma

This allows you to choose a degamma table that has been fine-tuned to bring out the best image quality for the input.

- ▶ Film: for home theater.
- ▶ Video: for video or TV source.
- ▶ Graphics: for image source.
- ▶ Standard: for PC or computer source.

BrilliantColor™

This adjustable item utilizes a new color-processing algorithm and system level enhancements to enable higher brightness while providing true, more vibrant colors in picture. The range is from “0” to “10”. If you prefer a stronger enhanced image, adjust toward the maximum setting. For a smoother, more natural image, adjust toward the minimum setting.

Color Temp

If set to cold temperature, the image looks more blue. (cold image)
If set to warm temperature, the image looks more red.
(warm image)

Color Settings

Press **↵** into the next menu as below and then use **▲** or **▼** to select item.

User Controls

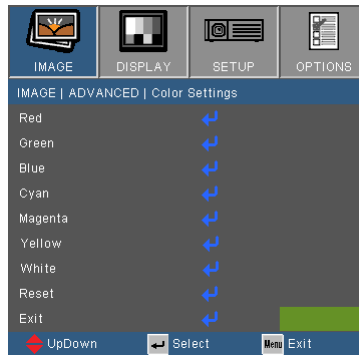

- ▶ Red/Green/Blue/Cyan/Magenta/Yellow: Use ◀ or ▶ to select Hue, Saturation and Gain Colors.



- ▶ White: Use ◀ or ▶ to select Red, Green and Blue Colors.



- ▶ Reset: Choose “Yes” to return the factory default settings for color adjustments.



❖ (*) For HDMI only.

Color Space

Select an appropriate color matrix type from AUTO, RGB, RGB(0-255)^(*), RGB(16-235)^(*) or YUV.

Reset

Choose “Yes” to return the display parameters on all menus to the factory default settings.

IMAGE | Advanced | Signal (RGB)

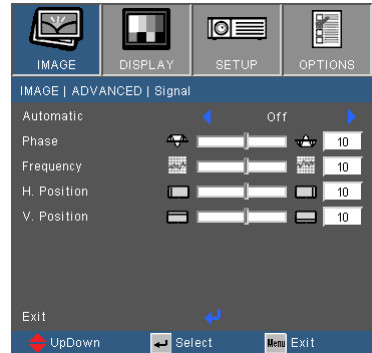

- ❖ “Signal” is only supported in Analog VGA (RGB) signal.

Automatic

Automatically selects the signal. If you use this function, the Phase, frequency items are grayed out, and if Signal is not automatic, the phase, frequency items will appear for user to manually tune and saved in settings after that for next time projector turns off and on again.

Phase

Synchronize the signal timing of the display with the graphic card. If the image appears to be unstable or flickers, use this function to correct it.

Frequency

Change the display data frequency to match the frequency of your computer's graphic card. Use this function only if the image appears to flicker vertically.

H. Position

- ▶ Press the ◀ to move the image left.
- ▶ Press the ▶ to move the image right.

V. Position

- ▶ Press the ◀ to move the image down.
- ▶ Press the ▶ to move the image up.

DISPLAY

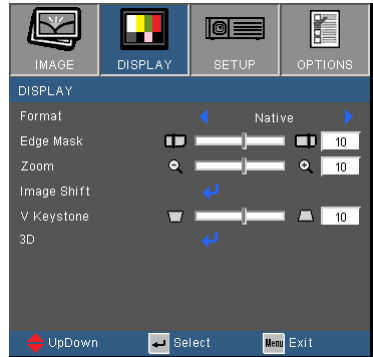

Format

Use this function to choose your desired aspect ratio.

SVGA/XGA

- ▶ 4:3: This format is for 4×3 input sources.
- ▶ 16:9: This format is for 16×9 input sources, like HDTV and DVD enhanced for Wide screen TV.
- ▶ Native: This format displays the original image without any scaling.
- ▶ AUTO: Automatically selects the appropriate display format.

Auto	Input resolution		Auto/Scale (SVGA)		Auto/Scale (XGA)	
	H	V	H	V	H	V
4:3	640	480	800	600	1024	768
	800	600	800	600	1024	768
	1024	768	800	600	1024	768
	1280	1024	800	600	1024	768
	1400	1050	800	600	1024	768
	1600	1200	800	600	1024	768
Wide Laptop	1280	720	800	450	1024	576
	1280	768	800	480	1024	614
	1280	800	800	500	1024	640
SDTV	720	576	800	450	1024	576
	720	480	800	450	1024	576
HDTV	1280	720	800	450	1024	576
	1920	1080	800	450	1024	576

User Controls

Aspect ratio (source detected)	Resize image (SVGA)	Resize image (XGA)
4:3	800 x 600 center	1024 x 768 center
16:9	800 x 450 center	1024 x 576 center
Native	No resize image, 1:1 mapping and centered. This format shows the original image without scaling.	

WXGA



❖ 16:9 or 16:10 depend on “Screen Type” setting.

- ▶ 4:3: This format is for 4×3 input sources.
- ▶ 16:9: This format is for 16×9 input sources, like HDTV and DVD enhanced for Wide screen TV.
- ▶ 16:10: This format is for 16×10 input sources, like widescreen laptops.
- ▶ LBX: This format is for non-16x9, letterbox source and for users who use external 16x9 lens to display 2.35:1 aspect ratio using full resolution.
- ▶ Native: This format displays the original image without any scaling.
- ▶ AUTO: Automatically selects the appropriate display format.

16:10 Screen	480i/p	576i/p	1080i/p	720p	PC
4:3	1066 x 800 center				
16:10	1280 x 800 center				
LBX	1280 x 960 center, then get the central 1280 x 800 image to display				
Native	1:1 mapping centered.		1:1 mapping (960 x 540) display 1280 x 800	1280 x 720 center	1:1 mapping centered.

16:9 Screen	480i/p	576i/p	1080i/p	720p	PC
4:3	960 x 720 center				
16:9	1280 x 720 center				
LBX	1280 x 960 center, then get the central 1280 x 720 image to display				
Native	1:1 mapping centered.		1:1 mapping (960 x 540) display 1280 x 720	1280 x 720 center	1:1 mapping centered.



- ❖ Each I/O has different setting of “Edge Mask”.
- ❖ “Edge Mask” and “Zoom” can’t work at same time.

Edge Mask

Edge mask function removes the noise in a video image. Edge mask the image to remove video encoding noise on the edge of video source.

Zoom

- ▶ Press the ◀ to reduce the size of an image.
- ▶ Press the ▶ to magnify an image on the projection screen.

Image Shift

Press ↩ into the next menu as below and then use ▲ or ▼ to select item.

- ▶ H: Use ◀ or ▶ to shift the projected image position horizontally.
- ▶ V: Use ◀ or ▶ to Shift the projected image position vertically.

V Keystone

Press the ◀ or ▶ to adjust image distortion vertically. If the image looks trapezoidal, this option can help make the image rectangular.

DISPLAY | 3D

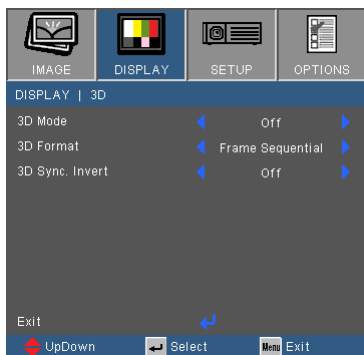

- ❖ “IR” options may vary according to model.
- ❖ “3D Sync Invert” is only available when 3D is enabled and this mode 3D is for DLP link glass only.
- ❖ Compatible 3D source, 3D content and active shutter glasses are required for 3D viewing.
- ❖ See page 50 for supported 3D formats.

3D Mode

- ▶ Off: Select “Off” to turn 3D settings off for 3D images.
- ▶ DLP Link: Select “DLP Link” to use optimized settings for DLP Link 3D images.
- ▶ IR: Select “IR” to use optimized settings for IR-based 3D images.

3D Format

- ▶ Auto : When a 3D identification signal is detected, the 3D format is selected automatically.
- ▶ SBS: Use this mode for “Side-by-side” format 3D content.
- ▶ Top and Bottom: Use this mode for “Top and Bottom” format 3D content.
- ▶ Frame Sequential: Use this mode for “Frame Sequential” format 3D content.

3D Sync. Invert

- ▶ Press the “On” to invert left and right frame contents.
- ▶ Press the “Off” for default frame contents.

SETUP

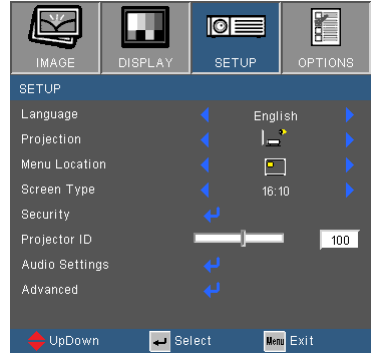

Language





Choose the multilingual OSD menu. Press ◀ or ▶ into the sub menu and then use the ▲ or ▼ key to select your preferred language. Press “Enter” to finalize the selection.



Projection



- ❖ Rear-Desktop and Rear-Ceiling are to be used with a translucent screen.

- ▶  **Front-Desktop**
This is the default selection. The image is projected straight on the screen.
- ▶  **Rear-Desktop**
When selected, the image will appear reversed.
- ▶  **Front-Ceiling**
When selected, the image will turn upside down.
- ▶  **Rear-Ceiling**
When selected, the image will appear reversed in upside down position.

User Controls

Menu Location

Choose the menu location on the display screen.

Screen Type

Choose the screen type from 16:10 or 16:9.

Projector ID

ID definition can be set up by menu (range 0-99), and allow user control an individual projector by RS232. Refer to page 51-54 for the complete list of RS232 commands.



- ❖ “Screen Type” is for WXGA only.

SETUP | Security

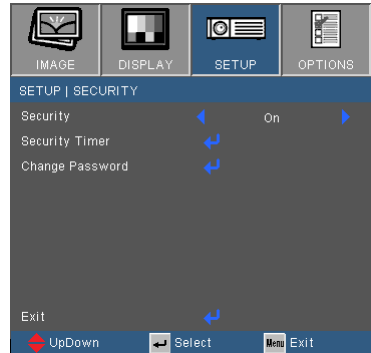

Security

- ▶ On: Choose “On” to use security verification when the turning on the projector.
- ▶ Off: Choose “Off” to be able to switch on the projector without password verification.









- ❖ Password default value is “1234” (first time).

Security Timer

Use this function to set the how long (Month/Day/Hour) the projector can be used. Once this time has elapsed you will be requested to enter your password again.

Change Password

- ▶ First time:
 1. Press “” to set the password.
 2. The password has to be 4 digits.
 3. Use number button on the remote to enter your new password and then press “” key to confirm your password.
- ▶ Change Password:
 1. Press “” to input old password.
 2. Use number button to enter current password and then press “” to confirm.
 3. Enter new password (4 digits in length) using the number buttons on the remote, then press “” to confirm.
 4. Enter new password again and press “” to confirm.

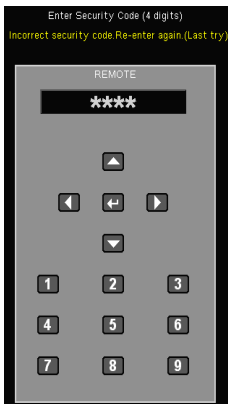

User Controls

- ▶ If the incorrect password is entered 3 times, the projector will automatically shut down.
- ▶ If you have forgotten your password, please contact your local office for support.

SETUP | Audio Settings



Internal Speaker

Choose the “On” or “Off” to turn on or off the internal speaker.

Mute

- ▶ Choose the “On” to turn mute on.
- ▶ Choose the “Off” to turn mute off.

Volume

- ▶ Press the ◀ to decrease the volume.
- ▶ Press the ▶ to increase the volume.

SETUP | Advanced

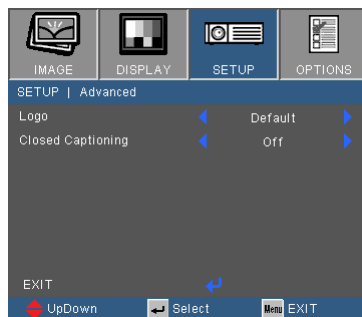

Logo

Press  to capture an image of the picture currently displayed on screen. If changes are made they will take effect the next time the projector is powered on.

- ▶ Default: The default startup screen.
- ▶ Neutral: Logo is not displayed on startup screen.

Closed Captioning

Use this function to set the desired startup screen. If changes are made they will take effect the next time the projector is powered on.

- ▶ Off: select "Off" to turn off the closed captioning feature.
- ▶ CC1:CC1 language: American English.
- ▶ CC2:CC2 language (depending on the TV channel of the user): Spanish, French, Portuguese, German, Danish.

OPTIONS

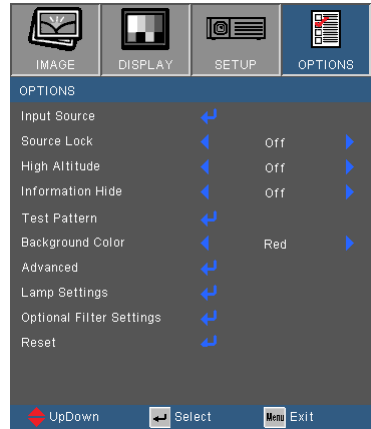

Input Source

Use this option to enable / disable input sources. Press  to enter the sub menu and select which sources you require. Press “Enter” to finalize the selection. The projector will not search for inputs that are not selected.

Source Lock

- ▶ On: The projector will only search current input connection.
- ▶ Off: The projector will search for other signals if the current input signal is lost.

High Altitude

When “On” is selected, the fans will spin faster. This feature is useful in high altitude areas where the air is thin.

Information Hide

- ▶ On: Choose “On” to hide the info message.
- ▶ Off: Choose “Off” to show the “searching” message.

Test Pattern

Display a test pattern. There are Grid, White pattern and None.

Background Color

Use this feature to display a “Black”, “Red”, “Blue”, “Green” or “White”, screen when no signal is available.

Reset

Choose “Yes” to return the display parameters on all menus to the factory default settings.

OPTIONS | Advanced

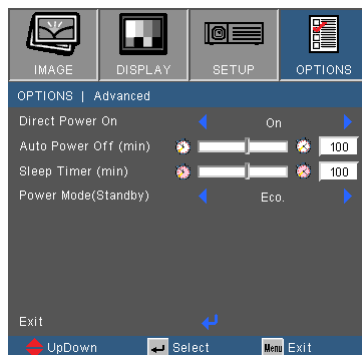

Direct Power On

Choose “On” to activate Direct Power mode. The projector will automatically power on when AC power is supplied, without pressing the “**⏻**” key on the projector control panel or on the remote control.

Auto Power Off (min)

Sets the countdown timer interval. The countdown timer will start, when there is no signal being sent to the projector. The projector will automatically power off when the countdown has finished (in minutes).

Sleep Timer (min)

Sets the countdown timer interval. The countdown timer will start, with or without a signal being sent to the projector. The projector will automatically power off when the countdown has finished (in minutes).

Power Mode (Standby)^(*)

- ▶ Eco.: Choose “Eco.” to save power dissipation further < 0.5W.
- ▶ Active: Choose “Active” to return to normal standby and the VGA out port will be enabled.



- ❖ (*) For XGA/WXGA model only.
- ❖ When Power mode (Standby) is set to Eco (<0.5W), the VGA output and Audio pass-through will be deactivated when the projector is in standby.

OPTIONS | Lamp Settings

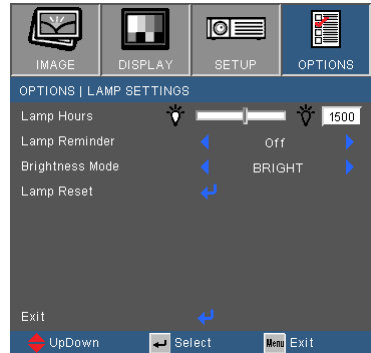

Lamp Hours

Display the projection time.

Lamp Reminder

Choose this function to show or to hide the warning message when the changing lamp message is displayed.

The message will appear 30 hours before suggested replacement of lamp.



❖ When ambient temperature is over 40°C in operating, the projector will switch to Eco automatically.

Brightness Mode

- ▶ Eco.: Choose “Eco.” to dim the projector lamp which will lower power consumption and extend the lamp life.
- ▶ BRIGHT: Choose “BRIGHT” to increase the brightness.

Lamp Reset

Reset the lamp hour counter after replacing the lamp.

OPTIONS | Optional Filter Settings

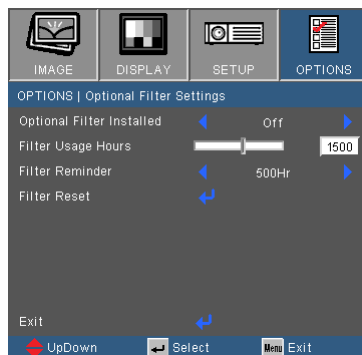

Optional Filter Installed

Select “Yes” to display warning message after 500 hours of use.
Select “No” to turn off warning message.

Filter Usage Hours

Display the filter time.

Filter Reminder

Choose this function to show or hide the warning message when the changing filter message is displayed. (Factory default setting: 500 hours)

Filter Reset

Reset the dust filter counter after replacing or cleaning the dust filter.

Troubleshooting

If you experience a problem with your projector, please refer to the following information. If a problem persists, please contact your local reseller or service center.

[?] No image appears on-screen

- ▶ Ensure all the cables and power connections are correctly and securely connected as described in the “Installation” section.
- ▶ Ensure all the pins of connectors are not bent or broken.
- ▶ Check if the projection lamp has been securely installed. Please refer to the “Replacing the lamp” section.
- ▶ Ensure that the “AV mute” feature is not turned on.

[?] Partial, scrolling or incorrectly displayed image

- ▶ Press “Re-SYNC” on the remote.
- ▶ If you are using a PC:

For Windows 95, 98, 2000, XP, Windows 7:

1. Open the “My Computer” icon, the “Control Panel” folder, and then double click on the “Display” icon.
2. Select the “Settings” tab.
3. Verify that your display resolution setting is lower than or equal to UXGA (1600 × 1200).
4. Click on the “Advanced Properties” button.

If the projector is still not projecting the whole image, you will also need to change the monitor display you are using. Refer to the following steps.

5. Verify the resolution setting is lower than or equal to UXGA (1600 × 1200).
6. Select the “Change” button under the “Monitor” tab.

Appendices

7. Click on “Show all devices”. Next, select “Standard monitor types” under the SP box; choose the resolution mode you need under the “Models” box.
 8. Verify that the resolution setting of the monitor display is lower than or equal to UXGA (1600 × 1200).
- ▶ If you are using a Notebook:
1. First, follow the steps above to adjust resolution of the computer.
 2. Press the appropriate keys listed below for your notebook manufacturer to send signal out from notebook to projector.
Example: [Fn]+[F4]

Acer ⇨	[Fn]+[F5]	IBM/Lenovo ⇨	[Fn]+[F7]
Asus ⇨	[Fn]+[F8]	HP/Compaq ⇨	[Fn]+[F4]
Dell ⇨	[Fn]+[F8]	NEC ⇨	[Fn]+[F3]
Gateway ⇨	[Fn]+[F4]	Toshiba ⇨	[Fn]+[F5]

Mac Apple:
System Preference ⇨ Display ⇨ Arrangement ⇨ Mirror display

- ▶ If you experience difficulty changing resolutions or your monitor freezes, restart all equipment including the projector.

[?] The screen of the Notebook or PowerBook computer is not displaying your presentation

- ▶ If you are using a Notebook PC
Some Notebook PCs may deactivate their own screens when a second display device is in use. Each has a different way to be reactivated. Refer to your computer’s manual for detailed information.

[?] Image is unstable or flickering

- ▶ Use “Phase” to correct it. See page 26 for more information.
▶ Change the monitor color setting on your computer.

[?] Image has vertical flickering bar

- ▶ Use “Frequency” to make an adjustment. See page 26 for more information.
▶ Check and re-configure the display mode of your graphic card to make it compatible with the projector.

[?] Image is out of focus

- ▶ Adjust the Focus Ring on the projector lens.
- ▶ Make sure the projection screen is between the required distance. See pages 15-16.

[?] The image is stretched when displaying 16:9 DVD title

- ▶ When you play anamorphic DVD or 16:9 DVD, the projector will show the best image when the projector display mode is set to 16:9 in the OSD.
- ▶ If you play 4:3 format DVD titles, please change the format to 4:3 in the projector OSD.
- ▶ If the image is still stretched, you will also need to adjust the aspect ratio by referring to the following:
- ▶ Please setup the display format as 16:9 (wide) aspect ratio type on your DVD player.

[?] Image is too small or too large

- ▶ Adjust the Zoom Ring on the top of the projector.
- ▶ Move the projector closer to or further from the screen.
- ▶ Press “Menu” button on the remote control, go to “Display → Format” and try the different settings.



❖ Use of Keystone is not recommended.

[?] Image has slanted sides

- ▶ If possible, reposition the projector so that it is horizontally centered on the screen and below the bottom of the screen.
- ▶ Press “Keystone +/-” button on the remote control until the sides are vertical.

[?] Image is reversed

- ▶ Select “SETUP → Projection” from the OSD and adjust the projection direction.

Appendices









[?] The projector stops responding to all controls

- ▶ If possible, turn off the projector, then unplug the power cord and wait at least 60 seconds before reconnecting power.

[?] Lamp burns out or makes a popping sound

- ▶ When the lamp reaches its end of life, it will burn out and may make a loud popping sound. If this happens, the projector will not turn on until the lamp module has been replaced. To replace the lamp, follow the procedures in the “Replacing the Lamp” section on pages 46-47.

[?] LED lighting message

Message	Power LED	Power LED
	(Red)	(Blue)
Standby State (Input power cord)		
Power on (Warming)		Flashing (0.5 sec off, 0.5 sec on)
Lamp lighting		
Power off (Cooling)		Flashing (1 sec off, 1 sec on) <10 sec to off
Error (Over Temp.)	Flashing (1 sec off, 1 sec on)	
Error (Fan fail)	Flashing (0.5 sec off, 2.0 sec on)	
Error (Lamp fail)	Flashing (0.5 sec off, 0.5 sec on)	



Steady light ⇒ 

No light ⇒ 

? On Screen Messages

▶ Temperature warning:

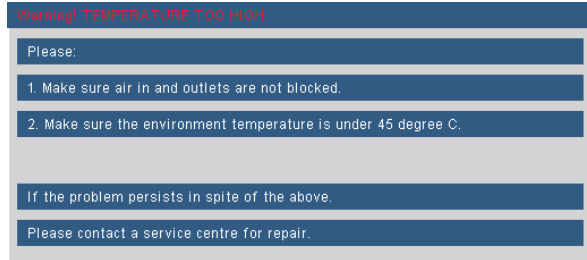

▶ Fan failed:

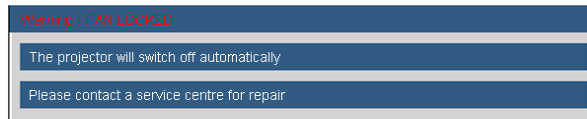

▶ Lamp warning:

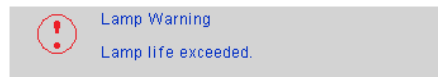

▶ Out of display range:

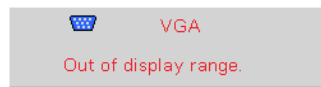

? If the remote control does not work

- ▶ Check the operating angle of the remote control is within $\pm 15^\circ$ both horizontally and vertically of one of the IR receivers on the projector.
- ▶ Make sure there are not any obstructions between the remote control and the projector. Move to within 7 m ($\pm 0^\circ$) of the projector.
- ▶ Make sure the batteries are inserted correctly.
- ▶ Replace batteries if they are exhausted.

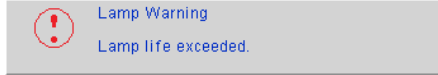

Replacing the lamp

The projector automatically detects the lamp life. When the lamp life is nearing the end of use, you will receive a warning message.



When you see this message, please contact your local reseller or service center to change the lamp as soon as possible. Make sure the projector has been cooled down for at least 30 minutes before changing the lamp.



-  Warning: If ceiling mounted, please use caution when opening the lamp access panel. It is recommended to wear safety glasses if changing the bulb when ceiling mounted. “Caution must be used to prevent any loose parts from falling out of projector.”
-  Warning: Lamp compartment may be hot! Allow it to cool down before changing the lamp!
-  Warning: To reduce the risk of personal injury, do not drop the lamp module or touch the lamp bulb. The bulb may shatter and cause injury if it is dropped.

NOTE

- ❖ The screws on the lamp cover and the lamp cannot be removed.
- ❖ The projector cannot be turned on if the lamp cover has not been placed back on the projector.
- ❖ Do not touch the glass area of the lamp. Hand oil can cause the lamp to shatter. Use a dry cloth to clean the lamp module if it was accidentally touched.

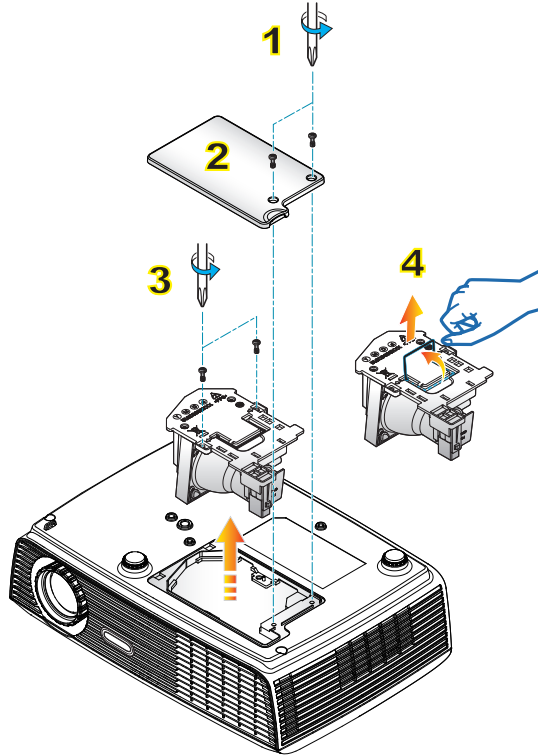

Lamp Replacement Procedure:

1. Switch off the power to the projector by pressing the “” button.
 2. Allow the projector to cool down for at least 30 minutes.
 3. Disconnect the power cord.
 4. Unscrew the two screws on the cover. **1**
 5. Lift up and remove the cover. **2**
 6. Unscrew the two screws on the lamp module. **3**
 7. Lift up the lamp handle and remove the lamp module slowly and carefully. **4**
- To replace the lamp module, reverse the previous steps.
8. Turn on the projector and reset the lamp timer.

Lamp Reset: (i) Press “Menu” → (ii) Select “OPTIONS” → (iii) Select “Lamp Settings” → (iv) Select “Lamp Reset” → (v) Select “Yes”.

Compatibility Modes

► Computer Compatibility



- ❖ For widescreen resolution (WXGA), the compatibility support is dependent on Notebook/PC models.
- ❖ Please note that using resolutions other than native 800 x 600 (SVGA), 1024 x 768 (XGA model), 1280 x 800 (WXGA model) may result in some loss of image clarity.

Mode	Resolution	Analog/Digital	
		V-Sync (Hz)	H-Sync (KHz)
VGA	640 × 350	70	31.50
VGA	640 × 350	85	37.90
VGA	640 × 400	85	37.90
VGA	640 × 480	60	31.50
VGA	640 × 480	67	-
VGA	640 × 480	72	37.90
VGA	640 × 480	75	37.50
VGA	720 × 350	70	31.50
SVGA	800 × 600	56	35.20
SVGA	800 × 600	60	37.90
SVGA	800 × 600	72	48.10
SVGA	800 × 600	75	46.90
SVGA	800 × 600	85	53.70
XGA	1024 × 768	60	48.40
XGA	1024 × 768	70	56.50
XGA	1024 × 768	75	60.00
XGA	1024 × 768	85	68.70
	1152 × 870	75	-
HD	1280 x 720	50	-
HD	1280 x 720	60	45.00
WXGA-800	1280 x 800	60	-
SXGA	1280 x 1024	60	64.00
SXGA+	1400 x 1050	60	-
UXGA	1600 × 1200	60	75.00

Appendices

► Computer Compatibility (Mac)

Resolution	V.Frequency [Hz]	Macbook	Macbook Pro	Power Mac G5	Power Mac G4
800x600	60	O	O	X	X
800x600	72	O	O	O	O
800x600	75	O	O	O	O
800x600	85	O	O	O	O
1024x768	60	O	O	O	O
1024x768	70	O	O	O	O
1024x768	75	O	O	O	O
1024x768	85	O	O	O	O
1280x720	60	O	O	O	O
1280x720	75	O	O	X	O
1280x720	85	O	O	X	O
1280x768	60	O	O	X	O
1280x768	75	O	O	O	O
1280x768	85	O	O	X	O
1280x800	60	O	O	O	O
1280x1024	60	X	O	O	O
1280x1024	75	X	O	O	X
1680x1050	60	X	O	O	X

► Video Compatibility

NTSC	M (3.58MHz), 4.43 MHz
PAL	B, D, G, H, I, M, N
SECAM	B, D, G, K, K1, L
SDTV	480i/p@60Hz, 576i/p@50Hz
HDTV	720p@50Hz/60Hz, 1080i@50Hz/60Hz, 1080p@24Hz/25Hz/30Hz/50Hz/60Hz

Appendices

▶ 3D input Compatibility

HDMI 1.4a 3D timing					
Formats	Modes	Resolution	V.Frequency [Hz]	H.Frequency [KHz]	Pixel Rate [MHz]
Frame Sequential	720p	1280x720	50	75	148.5
	720p	1280x720	60	90	148.5
	1080p	1920x1080	24	54	148.5
Top and Bottom	720p	1280x720	50	37.5	74.25
	720p	1280x720	60	45	74.25
	1080p	1920x1080	24	27	74.25
Side by Side (half)	1080i	1920x1080	50(25)	33.75	74.25
	1080i	1920x1080	60(30)	33.75	74.25

HDMI 1.3 3D timing					
Formats	Modes	Resolution	V.Frequency [Hz]	H.Frequency [KHz]	Pixel Rate [MHz]
Side by Side (half)	720p	1280x720	50	37.5	74.25
	720p	1280x720	60	45	74.25
	1080i	1920x1080	50(25)	33.75	74.25
	1080i	1920x1080	60(30)	33.75	74.25
Top and Bottom	720p	1280x720	50	37.5	74.25
	720p	1280x720	60	45	74.25
	1080i	1920x1080	50(25)	33.75	74.25
	1080i	1920x1080	60(30)	33.75	74.25
HQFS	480i	720x480	60		
	576i	720x576	50		

VGA 1.3 3D timing					
Formats	Modes	Resolution	V.Frequency [Hz]	H.Frequency [KHz]	Pixel Rate [MHz]
Frame Sequential	SVGA	800x600	120	76.3	73.25
	XGA	1024x768	120	97.6	115.5
	720p	1280x720	120		
Side by Side (half) or Top and Bottom	SVGA	800x600	60		
	XGA	1024x768	60		
	720p	1280x720	60		

Composite/S-Video					
Formats	Modes	Resolution	V.Frequency [Hz]	H.Frequency [KHz]	Pixel Rate [MHz]
HQFS	NTSC	720x480	60	15.73	
	PAL	720x576	50	15.63	

RS232 Commands and Protocol Function List

RS232 Pin Assignments

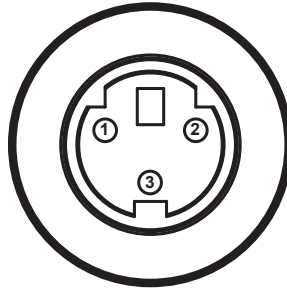

- ❖ RS232 shell is grounded.

Pin no.	Spec. (from projector side)
1	TXD
2	RXD
3	GND

Appendices

RS232 Protocol Function List



1. There is a <CR> after all ASCII commands.
2. 0D is the HEX code for <CR> in ASCII code.

Baud Rate : 9600

Data Bits: 8

Parity: None

Stop Bits: 1

Flow Control : None

UART16550 FIFO: Disable

Projector Return (Pass): P

Projector Return (Fail): F

XX=00-99, projector's ID,

XX=00 is for all projectors

SEND to projector

232 ASCII Code	HEX Code	Function	Description
~XX00 1	7E 30 30 30 30 20 31 0D	Power ON	
~XX00 0	7E 30 30 30 30 20 30 0D	Power OFF	(0/2 for backward compatible)
~XX00 1 ~nnnn	7E 30 30 30 30 20 31 20 a 0D	Power ON with Password	~nnnn = -0000 (a=7E 30 30 30 30) ~9999 (a=7E 39 39 39 39)
~XX01 1	7E 30 30 30 31 20 31 0D	Resync	
~XX02 1	7E 30 30 30 32 20 31 0D	AV Mute	On
~XX02 0	7E 30 30 30 32 20 30 0D		Off (0/2 for backward compatible)
~XX03 1	7E 30 30 30 33 20 31 0D	Mute	On
~XX03 0	7E 30 30 30 33 20 30 0D		Off (0/2 for backward compatible)
~XX04 1	7E 30 30 30 34 20 31 0D	Freeze	
~XX04 0	7E 30 30 30 34 20 30 0D	Unfreeze	(0/2 for backward compatible)
~XX05 1	7E 30 30 30 35 20 31 0D	Zoom Plus	
~XX06 1	7E 30 30 30 36 20 31 0D	Zoom Minus	
~XX12 5	7E 30 30 31 32 20 35 0D		VGA
~XX12 7	7E 30 30 31 32 20 37 0D		VGA SCART
~XX12 8	7E 30 30 31 32 20 38 0D		VGA Component
~XX12 10	7E 30 30 31 32 20 31 30 0D		Video
~XX20 1	7E 30 30 32 30 20 31 0D	Display Mode	Presentation
~XX20 2	7E 30 30 32 30 20 32 0D		Bright
~XX20 3	7E 30 30 32 30 20 33 0D		Movie
~XX20 4	7E 30 30 32 30 20 34 0D		sRGB
~XX20 5	7E 30 30 32 30 20 35 0D		User
~XX20 7	7E 30 30 32 30 20 37 0D		Blackboard
~XX20 8	7E 30 30 32 30 20 39 0D		3D
~XX21 n	7E 30 30 32 31 20 a 0D	Brightness	n = 0 (a=30) ~ 100 (a=31 30 30)
~XX22 n	7E 30 30 32 32 20 a 0D	Contrast	n = 0 (a=30) ~ 100 (a=31 30 30)
~XX23 n	7E 30 30 32 33 20 a 0D	Sharpness	n = 0 (a=30) ~ 31 (a=33 31)
~XX24 n	7E 30 30 32 34 20 a 0D	Color Settings	Red Gain n = -50 (a=2D 35 30) ~ 50 (a=35 30)
~XX25 n	7E 30 30 32 35 20 a 0D		Green Gain n = -50 (a=2D 35 30) ~ 50 (a=35 30)
~XX26 n	7E 30 30 32 36 20 a 0D		Blue Gain n = -50 (a=2D 35 30) ~ 50 (a=35 30)
~XX27 n	7E 30 30 32 37 20 a 0D		Red Bias n = -50 (a=2D 35 30) ~ 50 (a=35 30)
~XX28 n	7E 30 30 32 38 20 a 0D		Green Bias n = -50 (a=2D 35 30) ~ 50 (a=35 30)
~XX29 n	7E 30 30 32 39 20 a 0D		Blue Bias n = -50 (a=2D 35 30) ~ 50 (a=35 30)
~XX30 n	7E 30 30 33 30 20 a 0D		Cyan n = -50 (a=2D 35 30) ~ 50 (a=35 30)
~XX31 n	7E 30 30 33 31 20 a 0D		Yellow n = -50 (a=2D 35 30) ~ 50 (a=35 30)
~XX32 n	7E 30 30 33 32 20 a 0D		Magenta n = -50 (a=2D 35 30) ~ 50 (a=35 30)
~XX33 1	7E 30 30 33 33 20 31 0D		Reset
~XX34 n	7E 30 30 33 34 20 a 0D	BrilliantColor™	n = 0 (a=30) ~ 10 (a=31 30)
~XX35 1	7E 30 30 33 35 20 31 0D	Degamma	Film
~XX35 2	7E 30 30 33 35 20 32 0D		Video
~XX35 3	7E 30 30 33 35 20 33 0D		Graphics
~XX35 4	7E 30 30 33 35 20 34 0D		Standard
~XX36 1	7E 30 30 33 36 20 31 0D	Color Temp.	Warm
~XX36 2	7E 30 30 33 36 20 32 0D		Medium
~XX36 3	7E 30 30 33 36 20 33 0D		Cold
~XX37 1	7E 30 30 33 37 20 31 0D	Color Space	Auto
~XX37 2	7E 30 30 33 37 20 32 0D		RGB
~XX37 3	7E 30 30 33 37 20 33 0D		YUV
~XX45 n	7E 30 30 34 34 20 a 0D	Color (Saturation)	n = 0 (a=30) ~ 100 (a=31 30 30)
~XX44 n	7E 30 30 34 35 20 a 0D	Tint	n = 0 (a=30) ~ 100 (a=31 30 30)

Appendices

~XX60 1	7E 30 30 36 30 20 31 0D	Format	4:3		
~XX60 2	7E 30 30 36 30 20 32 0D		16:9		
~XX60 3	7E 30 30 36 30 20 33 0D		16:10 (W2005)		
~XX60 5	7E 30 30 36 30 20 35 0D		LBX		
~XX60 6	7E 30 30 36 30 20 36 0D		Native		
~XX60 7	7E 30 30 36 30 20 37 0D		Auto		
~XX61 n	7E 30 30 36 31 20 a 0D		Edge mask	n = 0 (a=30) ~ 10 (a=31 30)	
~XX62 n	7E 30 30 36 32 20 a 0D	Zoom	n = -5 (a=2D 35) ~ 25 (a=32 35)		
~XX63 n	7E 30 30 36 33 20 a 0D	H Image Shift	n = -100 (a=2D 31 30 30) ~ 100 (a=31 30 30)		
~XX64 n	7E 30 30 36 34 20 a 0D	V Image Shift	n = -100 (a=2D 31 30 30) ~ 100 (a=31 30 30)		
~XX66 n	7E 30 30 36 36 20 a 0D	V Keystone	n = -40 (a=2D 34 30) ~ 40 (a=34 30)		
~XX230 3	7E 30 30 32 33 30 20 31 0D	3D Mode	Off		
~XX230 1	7E 30 30 32 33 30 20 31 0D		DLP-Link		
~XX405 0	7E 30 30 34 30 35 20 30 0D	3D format	Off		
~XX405 1	7E 30 30 34 30 35 20 31 0D		SBS		
~XX405 2	7E 30 30 34 30 35 20 32 0D		Top and Bottom		
~XX405 3	7E 30 30 34 30 35 20 33 0D		Frame Sequential		
~XX231 1	7E 30 30 32 33 31 20 31 0D	3D Sync Invert	On		
~XX231 0	7E 30 30 32 33 31 20 30 0D		Off (0/2 for backward compatible)		
~XX70 1	7E 30 30 37 30 20 31 0D	Language	English		
~XX70 2	7E 30 30 37 30 20 32 0D		German		
~XX70 3	7E 30 30 37 30 20 33 0D		French		
~XX70 4	7E 30 30 37 30 20 34 0D		Italian		
~XX70 5	7E 30 30 37 30 20 35 0D		Spanish		
~XX70 6	7E 30 30 37 30 20 36 0D		Portuguese		
~XX70 7	7E 30 30 37 30 20 37 0D		Polish		
~XX70 8	7E 30 30 37 30 20 38 0D		Dutch		
~XX70 9	7E 30 30 37 30 20 39 0D		Swedish		
~XX70 10	7E 30 30 37 30 20 31 30 0D		Norwegian/Danish		
~XX70 11	7E 30 30 37 30 20 31 31 0D		Finnish		
~XX70 12	7E 30 30 37 30 20 31 32 0D		Greek		
~XX70 13	7E 30 30 37 30 20 31 33 0D		Traditional Chinese		
~XX70 14	7E 30 30 37 30 20 31 34 0D		Simplified Chinese		
~XX70 15	7E 30 30 37 30 20 31 35 0D		Japanese		
~XX70 16	7E 30 30 37 30 20 31 36 0D		Korean		
~XX70 17	7E 30 30 37 30 20 31 37 0D		Russian		
~XX70 18	7E 30 30 37 30 20 31 38 0D		Hungarian		
~XX70 19	7E 30 30 37 30 20 31 39 0D		Czechoslovak		
~XX70 20	7E 30 30 37 30 20 32 30 0D		Arabic		
~XX70 21	7E 30 30 37 30 20 32 31 0D		Thai		
~XX70 22	7E 30 30 37 30 20 32 32 0D		Turkish		
~XX70 23	7E 30 30 37 30 20 32 33 0D		Farsi		
~XX70 25	7E 30 30 37 30 20 32 33 0D		Vietnamese		
~XX70 26	7E 30 30 37 30 20 32 33 0D		Indonesian		
~XX70 27	7E 30 30 37 30 20 32 33 0D		Romanian		
~XX71 1	7E 30 30 37 31 20 31 0D		Projection	Front-Desktop	
~XX71 2	7E 30 30 37 31 20 32 0D	Rear-Desktop			
~XX71 3	7E 30 30 37 31 20 33 0D	Front-Ceiling			
~XX71 4	7E 30 30 37 31 20 34 0D	Rear-Ceiling			
~XX72 1	7E 30 30 37 32 20 31 0D	Menu Location	Top Left		
~XX72 2	7E 30 30 37 32 20 32 0D		Top Right		
~XX72 3	7E 30 30 37 32 20 33 0D		Centre		
~XX72 4	7E 30 30 37 32 20 34 0D		Bottom Left		
~XX72 5	7E 30 30 37 32 20 35 0D		Bottom Right		
(W2005 only)					
~XX90 1	7E 30 30 39 31 20 31 0D	Screen Type	16:10		
~XX90 0	7E 30 30 39 31 20 30 0D		16:9		
~XX73 n	7E 30 30 37 33 20 a 0D	Signal	Frequency	n = -5 (a=2D 35) ~ 5 (a=35) By signal	
~XX91 n	7E 30 30 39 31 20 a 0D		Automatic	n = 0 disable; n = 1 enable	
~XX74 n	7E 30 30 37 34 20 a 0D		Phase	n = 0 (a=30) ~ 31 (a=33 31) By signal	
~XX75 n	7E 30 30 37 35 20 a 0D		H. Position	n = -5 (a=2D 35) ~ 5 (a=35) By timing	
~XX76 n	7E 30 30 37 36 20 a 0D		V. Position	n = -5 (a=2D 35) ~ 5 (a=35) By timing	
~XX77 n	7E 30 30 37 37 20 aabbcc 0D		Security	Security Timer	Month/Day/Hour n = mm/dd/hh mm = 00 (aa=30 30) ~ 12 (aa=31 32) dd = 00 (bb=30 30) ~ 30 (bb=33 30) hh = 00 (cc=30 30) ~ 24 (cc=32 34)
~XX78 1	7E 30 30 37 38 20 31 0D		Security Settings	Enable Disable(0/2 for backward compatible)	
~XX78 0	7E 30 30 37 38 20 32 0D				
~XX79 n	7E 30 30 37 39 20 a 0D	Projector ID		n = 00 (a=30 30) ~ 99 (a=39 39)	
~XX80 1	7E 30 30 38 30 20 31 0D	Mute	On		
~XX80 0	7E 30 30 38 30 20 30 0D		Off (0/2 for backward compatible)		
~XX81 n	7E 30 30 38 31 20 a 0D		Volume	n = 0 (a=30) ~ 10 (a=31 30)	
~XX82 1	7E 30 30 38 32 20 31 0D	Logo	Default		
~XX82 3	7E 30 30 38 32 20 32 0D		Neutral		
~XX88 0	7E 30 30 38 38 20 30 0D		Closed Captioning	Off	
~XX88 1	7E 30 30 38 38 20 31 0D			cc1	

Appendices

~XX88 2	7E 30 30 38 38 20 32 0D		cc2
~XX100 1	7E 30 30 31 30 30 20 31 0D	Source Lock	On Off (0/2 for backward compatible)
~XX100 0	7E 30 30 31 30 30 20 30 0D		
~XX101 1	7E 30 30 31 30 31 20 31 0D	High Altitude	On Off (0/2 for backward compatible)
~XX101 0	7E 30 30 31 30 31 20 30 0D		
~XX102 1	7E 30 30 31 30 32 20 31 0D	Information Hide	On Off (0/2 for backward compatible)
~XX102 0	7E 30 30 31 30 32 20 30 0D		
~XX195 0	7E 30 30 31 39 35 20 30 0D	Test Pattern	None Grid White Pattern
~XX195 1	7E 30 30 31 39 35 20 31 0D		
~XX195 2	7E 30 30 31 39 35 20 32 0D		
~XX104 1	7E 30 30 31 30 34 20 31 0D	Background Color	Blue Black Red Green White
~XX104 2	7E 30 30 31 30 34 20 32 0D		
~XX104 3	7E 30 30 31 30 34 20 33 0D		
~XX104 4	7E 30 30 31 30 34 20 34 0D		
~XX104 5	7E 30 30 31 30 34 20 35 0D		
~XX105 1	7E 30 30 31 30 35 20 31 0D	Advanced	Direct Power On On Off (0/2 for backward compatible)
~XX105 0	7E 30 30 31 30 35 20 30 0D		
~XX106 n	7E 30 30 31 30 36 20 a 0D		Auto Power Off (min) n = 0 (a=30) ~ 180 (a=31 38 30) step:5
~XX107 n	7E 30 30 31 30 37 20 a 0D		Sleep Timer (min) n = 0 (a=30) ~ 995 (a=39 39 39) step:5
~XX114 1	7E 30 30 31 31 34 20 31 0D		Power Mode(Standby) Eco (<=0.5W)
~XX114 0	7E 30 30 31 31 34 20 30 0D		Active (0/2 for backward compatible)
~XX109 1	7E 30 30 31 30 39 20 31 0D		Lamp Reminder On Off (0/2 for backward compatible)
~XX109 0	7E 30 30 31 30 39 20 30 0D		
~XX110 1	7E 30 30 31 31 30 20 31 0D	Brightness Mode	Bright Eco (0/2 for backward compatible)
~XX110 0	7E 30 30 31 31 30 20 30 0D		
~XX111 1	7E 30 30 31 31 31 20 31 0D	Lamp Reset	Yes No (0/2 for backward compatible)
~XX111 0	7E 30 30 31 31 31 20 30 0D		
~XX112 1	7E 30 30 31 31 32 20 31 0D	Reset	Yes
~XX99 1	7E 30 30 39 39 20 31 0D	RS232 Alert Reset	Reset System Alert
~XX210 n	7E 30 30 32 30 30 20 n 0D	Display message on the OSD	n: 1-30 characters

SEND to emulate Remote

~XX140 10	7E 30 30 31 34 30 20 31 30 0D		Up
~XX140 11	7E 30 30 31 34 30 20 31 31 0D		Left
~XX140 12	7E 30 30 31 34 30 20 31 32 0D		Enter (for projection MENU)
~XX140 13	7E 30 30 31 34 30 20 31 33 0D		Right
~XX140 14	7E 30 30 31 34 30 20 31 34 0D		Down
~XX140 15	7E 30 30 31 34 30 20 31 35 0D		Keystone +
~XX140 16	7E 30 30 31 34 30 20 31 36 0D		Keystone -
~XX140 17	7E 30 30 31 34 30 20 31 37 0D		Volume -
~XX140 18	7E 30 30 31 34 30 20 31 38 0D		Volume +
~XX140 19	7E 30 30 31 34 30 20 31 39 0D		Brightness
~XX140 20	7E 30 30 31 34 30 20 32 30 0D		Menu
~XX140 21	7E 30 30 31 34 30 20 32 31 0D		Zoom

SEND from projector automatically

232 ASCII Code	HEX Code	Function	Projector Return	Description
		System status	INFOn	n : 0/1/2/3/4/6/7/8/9 = Standby/Warming/Cooling/Out of Range/ Lamp fail/Fan Lock/Over Temperature/Lamp Hours Running Out

READ from projector

232 ASCII Code	HEX Code	Function	Projector Return	Description
~XX121 1	7E 30 30 31 32 31 20 31 0D	Input Source Commands	OKn	n : 0/1/2/3/4 = None/VGA/S-Video/Video/HDMI (W2005)
~XX122 1	7E 30 30 31 32 32 20 31 0D	Software Version	OKdddd	dddd: FW version
~XX123 1	7E 30 30 31 32 33 20 31 0D	Display Mode	OKn	n : 0/1/2/3/4/5/7 = None/Presentation/Bright/Movie/sRGB/User/ Blackboard/3D n : 0/1 = Off/On
~XX124 1	7E 30 30 31 32 34 20 31 0D	Power State	OKn	
~XX125 1	7E 30 30 31 32 35 20 31 0D	Brightness	OKn	
~XX126 1	7E 30 30 31 32 36 20 31 0D	Contrast	OKn	
~XX127 1	7E 30 30 31 32 37 20 31 0D	Aspect Ratio	OKn	n : 0/1/2/3/4 = 4.3/16.9/Native/AUTO (S2005/X2005) n : 0/1/2/3/4 = 4.3/16.9 or 16:10/LBX/Native/AUTO (W2005) n : 0/1/2 = Warm/Medium/Cold
~XX128 1	7E 30 30 31 32 38 20 31 0D	Color Temperature	OKn	
~XX129 1	7E 30 30 31 32 39 20 31 0D	Projection Mode	OKn	n : 0/1/2/3 = Front-Desktop/Rear-Desktop/Front-Ceiling/Rear-Ceiling
~XX150 1	7E 30 30 31 35 30 20 31 0D	Information	OKabbbccddddd	a : 0/1 = Off/On bbbb: LampHour cc: source n : 0/1/2/3/4 = None/VGA/S-Video/Video/ HDMI (W2005) dddd: FW version e : Display mode 0/1/2/3/4/5/6/7 None/Presentation/Bright/Movie/sRGB/User/ Blackboard/3D
~XX151 1	7E 30 30 31 35 31 20 31 0D	Model name	OKn	n:1/2/3 =S2005/X2005/W2005
~XX108 1	7E 30 30 31 30 38 20 31 0D	Lamp Hours	OKbbbb	bbbb: LampHour
~XX108 2	7E 30 30 31 30 38 20 31 0D	Cumulative Lamp Hours	OKbbbbbb	bbbbbb: (5 digits) Total Lamp Hours

Optoma Global Offices

For service or support please contact your local office.

USA

3178 Laurelview Ct.
Fremont, CA 94538, USA
www.optomausa.com

 888-289-6786
 510-897-8601
 services@optoma.com

Canada

2420 Meadowpine Blvd., Suite #105
Mississauga, ON, L5N 6S2, Canada
www.optoma.ca

 888-289-6786
 510-897-8601
 services@optoma.com

Latin America

3178 Laurelview Ct.
Fremont, CA 94538, USA
www.optomausa.com

 888-289-6786
 510-897-8601
 services@optoma.com



Europe

42 Caxton Way, The Watford Business Park
Watford, Hertfordshire,
WD18 8QZ, UK
www.optoma.eu
Service Tel : +44 (0)1923 691865

 +44 (0) 1923 691 800
 +44 (0) 1923 691 888
 service@tsc-europe.com



Benelux BV

Randstad 22-123
1316 BW Almere
The Netherlands
www.optoma.nl

 +31 (0) 36 820 0253
 +31 (0) 36 548 9052

France

Bâtiment E
81-83 avenue Edouard Vaillant
92100 Boulogne Billancourt, France

 +33 1 41 46 12 20
 +33 1 41 46 94 35
 savoptoma@optoma.fr

Spain



C/ José Hierro,36 Of. 1C
28522 Rivas VaciaMadrid,
Spain

 +34 91 499 06 06
 +34 91 670 08 32

Appendices



Deutschland

Wiesenstrasse 21 W
D40549 Düsseldorf,
Germany

 +49 (0) 211 506 6670
 +49 (0) 211 506 66799
 info@optoma.de

Scandinavia



Lerpeveien 25
3040 Drammen
Norway

 +47 32 98 89 90
 +47 32 98 89 99
 info@optoma.no

PO.BOX 9515
3038 Drammen
Norway

Korea

WOOMI TECH.CO.,LTD.
4F,Minu Bldg.33-14, Kangnam-Ku,
seoul,135-815, KOREA

 +82+2+34430004
 +82+2+34430005



Japan

東京都足立区綾瀬3-25-18
株式会社オーエス
コンタクトセンター:0120-380-495

 info@os-worldwide.com
www.os-worldwide.com



Taiwan

12F., No.215,Sec. 3, Beixin Rd.,
Xindian Dist., New Taipei City 231,
Taiwan, R.O.C.
www.optoma.com.tw

 +886-2-8911-8600
 +886-2-8911-6590
 services@optoma.com.tw
asia.optoma.com



Hong Kong

Unit A, 27/F Dragon Centre,
79 Wing Hong Street,
Cheung Sha Wan,
Kowloon, Hong Kong

 +852-2396-8968
 +852-2370-1222
www.optoma.com.hk

China

5F, No. 1205, Kaixuan Rd.,
Changning District
Shanghai, 200052, China

 +86-21-62947376
 +86-21-62947375
www.optoma.com.cn

Regulation & Safety Notices

This appendix lists the general notices of your projector.

FCC notice

This device has been tested and found to comply with the limits for a Class B digital device pursuant to Part 15 of the FCC rules. These limits are designed to provide reasonable protection against harmful interference in a residential installation. This device generates, uses and can radiate radio frequency energy and, if not installed and used in accordance with the instructions, may cause harmful interference to radio communications.

However, there is no guarantee that interference will not occur in a particular installation. If this device does cause harmful interference to radio or television reception, which can be determined by turning the device off and on, the user is encouraged to try to correct the interference by one or more of the following measures:

- Reorient or relocate the receiving antenna.
- Increase the separation between the device and receiver.
- Connect the device into an outlet on a circuit different from that to which the receiver is connected.
- Consult the dealer or an experienced radio/television technician for help.

Notice: Shielded cables

All connections to other computing devices must be made using shielded cables to maintain compliance with FCC regulations.

Caution

Changes or modifications not expressly approved by the manufacturer could void the user's authority, which is granted by the Federal Communications Commission, to operate this projector.

Appendices

Operation conditions

This device complies with Part 15 of the FCC Rules. Operation is subject to the following two conditions:

1. This device may not cause harmful interference and
2. This device must accept any interference received, including interference that may cause undesired operation.

Notice: Canadian users

This Class B digital apparatus complies with Canadian ICES-003.

Remarque à l'intention des utilisateurs canadiens

Cet appareil numérique de la classe B est conforme à la norme NMB-003 du Canada.

Declaration of Conformity for EU countries

- EMC Directive 2004/108/EC (including amendments)
- Low Voltage Directive 2006/95/EC
- R & TTE Directive 1999/5/EC (if product has RF function)

Disposal instructions



Do not throw this electronic device into the trash when discarding. To minimize pollution and ensure utmost protection of the global environment, please recycle it.