







Contents

Introduction	5
Overview	5
LCD-TV	5
Front.....	5
Operating controls on the side	6
Rear.....	6
Remote control	7
General Information	8
Purpose of use.....	8
HD ready.....	8
Included in the box.....	8
Safety instruction	9
Safety.....	9
Point of use.....	9
Repair	10
Intended Environment	10
Power Supply.....	10
Standards/electro-magnetic compatibility	11
Batteries and Proper Treatment.....	11
Setting Up	12
Unpacking.....	12
Putting the batteries into the remote control	12
Connecting an antenna	12
Connecting the power supply	12
Basic Functions	13
Turning the LCD TV on and off	13
After switching on for the first time	13
Automatic channel seeking	13
Channel Search	13
Sound Settings	14
Setting the Picture	14
Zoom mode ( key).....	14
Zoom in PC mode.....	14
Other picture settings.....	14
Displaying information.....	15
Select external device	15
Video text	16
To operate video text.....	16
Select video text pages	16
Number keys	16
Channel selection keys	16
Colour buttons	16
Subpages.....	16

Useful features for video text.....	17
 Combination of video text and TV picture.....	17
 INDEX.....	17
 STOP.....	17
 Suppress TT Search.....	17
 Displaying hidden text.....	17
PIP and PAP.....	18
Sources for PIP and PAP.....	18
Activating and modifying the PIP function.....	19
The PIP menu.....	19
Activating and modifying the PAP function.....	20
The PAP menu.....	20
Der DVB-T Modus.....	21
Connecting DVB-T antenna.....	21
First Time Installation.....	21
The OSD menu.....	22
Navigating within the Menu.....	22
Menu PICTURE.....	23
Menu SOUND.....	24
Submenu EQUALIZER.....	25
Submenu HEADPHONE.....	25
Menu FUNCTION.....	26
Menu INSTALL.....	27
Save video recorder manually.....	28
PROGRAM TABLE.....	29
Menu SOURCE.....	30
Menu in PC mode.....	31
Menu PC POSITION.....	31
Menu in DVB-T mode.....	32
Menu CHANNEL LIST.....	32
Menu INSTALLATION.....	32
Menu CONFIGURATION.....	32
Menu TIMER.....	33
Menu TV-SETUP.....	33
Menu COMMON INTERFACE.....	33
Connections and examples of connections.....	34
Headphones.....	35
DVD player.....	35
Video recorder.....	36
DVD recorder.....	36
Receiver (SAT, DVB-T, decoder, etc.).....	37
DVD or video recorder and Sat-receiver.....	38
Camcorder.....	38
Device with HDMI or DVI output.....	39
External device with HDMI output.....	39
External device with DVI output.....	39
PC.....	39

The universal remote control	40
Scope of application.....	40
Programming device codes.....	40
General information	40
Enter the device code according to the code list	40
Manual code search.....	40
Automatic search	41
1 second or 3 second intervals.....	41
Code searching by brand name	41
Code identification	42
Normal operation	42
Operating individual devices.....	42
“All off” function	42
GUIDE - EPG – Electronic Programme Guide	42
Troubleshooting	43
Do you require additional Support?	44
Maintenance	44
Specifications.....	44
Recycling	45
Packaging.....	45
Device.....	45
Batteries.....	45
Pixel errors with LCD TVs.....	46
Wall Mounting	47
Accessories	47
Safety instructions for wall mounting	47
Mounting the hanging elements and the device	47
Remove base.....	48
Fixing the steel rails to the wall	48
Code list for universal remote control.....	49
TV	49
VCR.....	53
Cable.....	55
SAT	55
Laser Disc	58
DVD	58
CD	60
Audio Amplifiers/Tuners/Receivers.....	61
Audio Tape Players	61
MINI Systems.....	62
Miscellaneous.....	62
DVB-T Terrestrial Digital Television (DTV Freeview iDTV etc.)	62
DVD Recorders (DVD-R DVD-RW etc.)	62
HDD Digital Video Recorders (Hard Disk Drive DVR PVR etc.).....	63
Home Cinema Systems DVD & AUDIO	63
TV/VCR Combos.....	64
TV/DVD Combos.....	64
DVD/VCR Combos.....	64
Auxiliary Set-Top Boxes.....	65

Web & Computer TV 65
Media Receivers 65
Scart Switch Boxes 65
Digital Set Top Boxes..... 65
Miscellaneous Set Top Boxes..... 65
ADSL (BROADBAND) DTV Receivers..... 65
Home Automation 65

Introduction

1

Congratulations on choosing to buy a Tevion® product. By doing so you now have the assurance and peace of mind that comes with purchasing a product made by one of Europe's leading manufacturers.

All products brought to you by Tevion® are manufactured to the highest standards of performance and safety, and, as part of our philosophy of customer service and satisfaction, are backed by our comprehensive 3 Year Warranty.

Please fill in and return the Warranty Card to the address provided.

We hope you will enjoy using your purchase for many years to come.

Overview

2

LCD-TV

Front

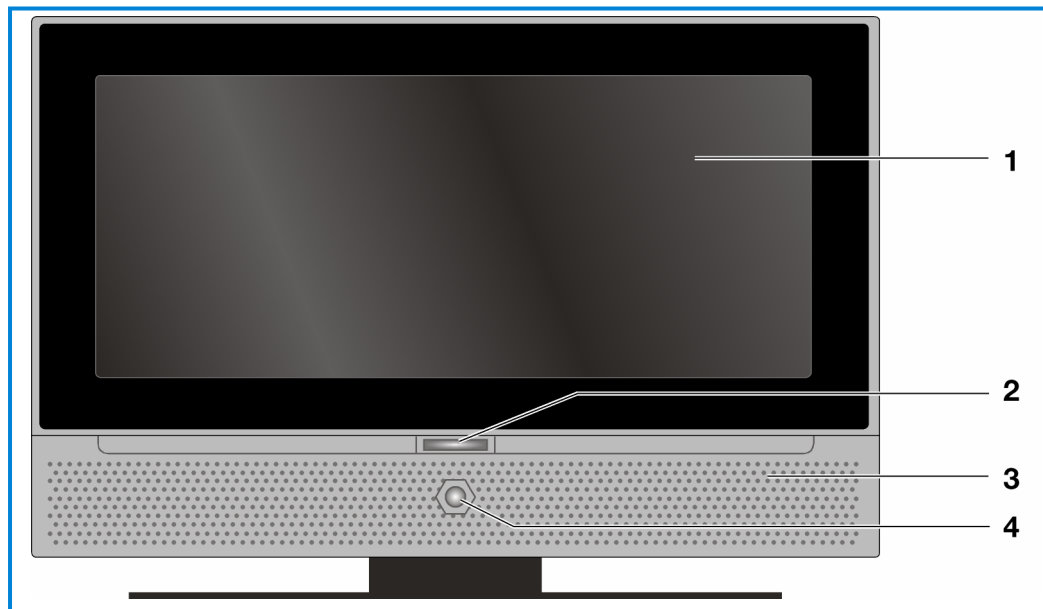

1. TFT screen
2. On/off light: the blue light will come on when the device is in stand-by mode. It will go off if the device is switched on.
3. Loudspeakers
4. Infra-red sensor: receiving area for infra-red signals from the remote control.

Operating controls on the side

1.  **STANDBY**: to switch the LCD-TV off temporarily.
2. **TV/AV**: to select the input signal: **TV** (antenna), **EXT-1**, **EXT-2**, **EXT-1 S**, **BAV**, **S-Video**, **HDMI 1**, **HDMI 2**, **YPbPr**, **PC**.
3. **MENU**: with this key you can display the screen menu to make adjustments to your equipment.
4. **+ P/CH -**: you can switch TV channel using these keys.
5. **+ ◀ ▶ -**: you can regulate the volume of your equipment with these keys.

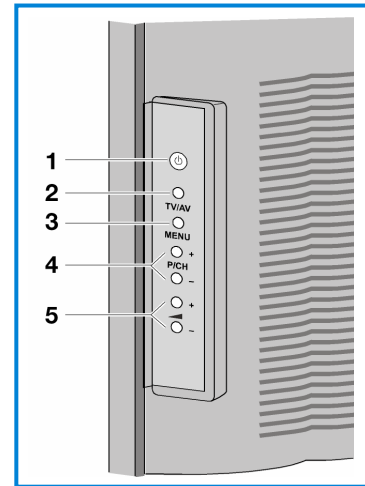



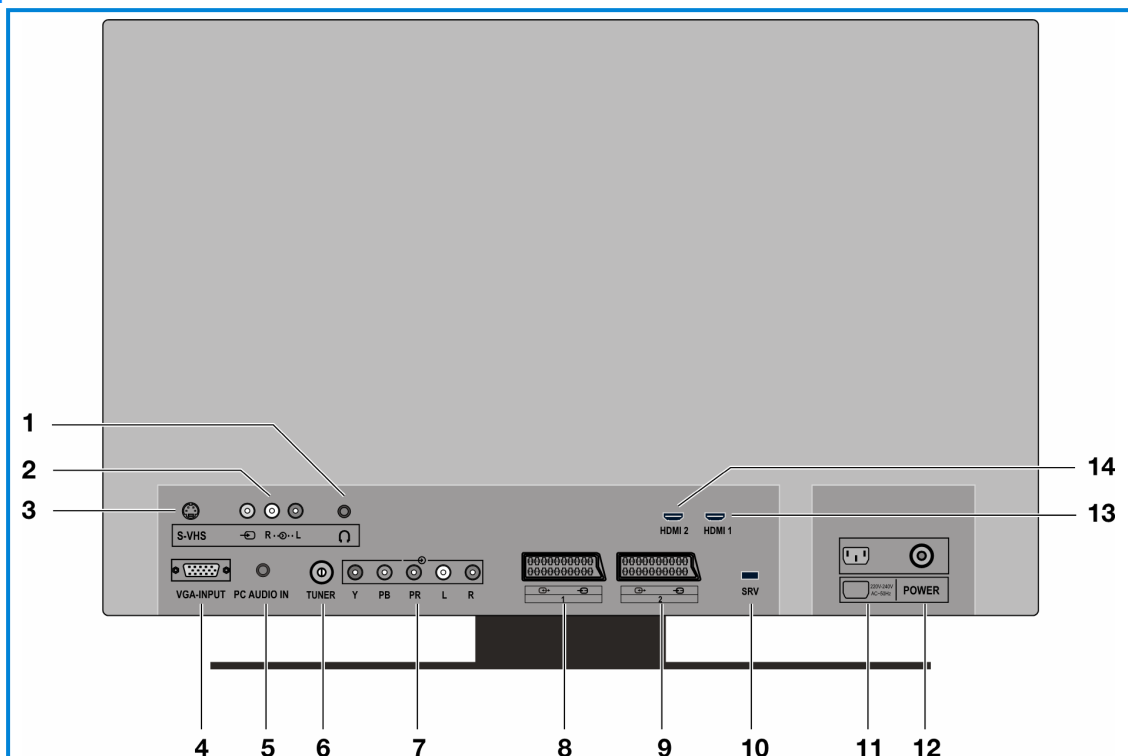









Rear



1. **Headphone connection**: to connect headphones with a 3.5 mm TRS stereo connector.
2. **VIDEO-input (yellow) and AUDIO-inputs (red/white)**: to connect a device using an RCA cable.
3. **S-VHS** input: to connect a device using an S-VHS cable.
4. **VGA-INPUT**: to connect a PC.
5. **PC AUDIO IN**: audio in for 3.5 mm TRS stereo connector, e.g. for PCs.
6. **TUNER**: to connect the aerial.
7. **Y - PB - PR - L - R**: Component inputs to connect devices with Component output.
8. **SCART 1**: 1st SCART connecting
9. **SCART 2**: 2nd SCART connection
10. **SRV**: only for servicing purposes. Do not try to connect a cable to this.
11. **Power in**: to connect the supplied power cable.
12. **On/off switch**: to put the device into stand-by mode and switch it off again.
13. **HDMI 1** input: to connect a device with an HDMI output.
14. **HDMI 2** input: to connect a device with an HDMI output.

Remote control

1.  STANDBY: to switch the LCD-TV off temporarily.
2. Source key for external device: **TV**
3. Source key for external device: **VCR**
4. Source key for external device: **DVD**
5. Source key for external device: **SAT**
6. Source key for external device: **AUX**
7. **INFO**: to display information, such as current channel number and picture format
8. Direction keys
9. **SELECT**: freeze television picture; **OK**. in certain menus to confirm selection
10. **M**: open menu.
11. **GUIDE**: call up EPG
: video text: call up index page
12. **EXIT**: close menu.
13. **I-II**: select sound mode
14. **P<P SWAP**: set previous TV channel
15. **CODE**: Enter code for other device types
16. **TV/DTV**: select TV or DTV operation
17. Light to confirm key has been pressed
18. Digit keys in the TV mode: channel selection; in video text mode: page selection
19. **-/--**: enter a number with two digits
20. **AV/SOURCE**: select input signal from connected devices
21. Channel selection keys **P/CH + / -**.
Select the following (+) or the previous (-) channel in TV mode.
Select the following (+) or the previous (-) channel in video text mode.
22. Switch volume off
23. **+ ◀ ▶ -**: to increase (+) or decrease (-) volume.
24. Blue key opens **INSTALLATION** menu; DVD/VCR mode: next track / chapter / forward
25. Yellow key opens **FUNCTIONS** menu; DVD/VCR mode: play
26. Red key opens **SOUND** menu; DVD/VCR mode: previous track / chapter / rewind
27. **PP**: select **PICTURE** mode ; DVD/VCR mode: record
28. : select picture format; DVD/VCR mode: pause
29. Green key opens **PICTURE** menu; DVD/VCR mode: stop
30. : video text: Mix (transparent picture); : switch on PIP window.
31. : video text: hidden searching; : switch on PAP window.
32. : video text: stop page; : no function
33. : Display time/Video text open sub-page
34. : video text: hidden text/switching from TV mode to PC mode
35. : Switch video text on and off

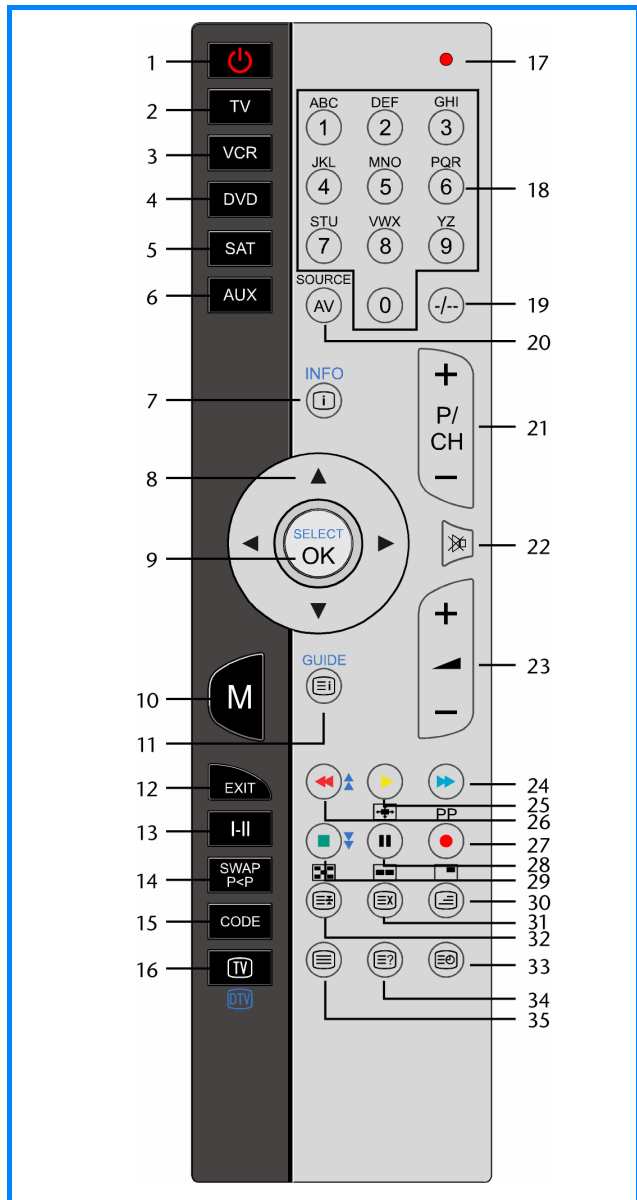



Read these instructions carefully under all circumstance and follow all the instructions listed. You will guarantee the reliable operation and a long life expectancy of your LCD TV in this way. Always keep these instructions at hand, close to your LCD TV. In the event that you transfer ownership of this LCD TV, please provide these instructions to the new owner.

Purpose of use

- This device serves to receive and transmit television channels. The different connection possibilities (receiver, DVD player, DVD recorder and VCR, etc.) will enable an additional expansion of the sources of reception and transmission (Receiver, DVD-Player, DVD-Recorder, Video Recorder etc.).
- This device is only suitable for using in dry, internal rooms.
- This device is not suitable as a data screen for office use.
- This device is intended for personal use only. It not intended for commercial use in a heavy industry environment. Use under extreme environmental conditions can result in damage to your device.

HD ready

Your LCD-TV is equipped with the 'HD ready' feature. This means that it can transmit high resolution television programmes (HDTV) in principle.

It is the prerequisite that an HDTV signal is sent to the LCD TV by an external set-top box (HD-STB).

Included in the box

Check that nothing is missing from the packaging and inform us of any missing parts within 14 days after purchase. The delivery of the LCD-TV you have purchased includes:

1. LCD-TV
2. Connection cable
3. Remote control incl. 2 batteries type R03 (AAA) 1,5V
4. Set for wall mounting (see Wall mounting).
5. Documentation

Safety

- Do not allow children to play unattended on electrical equipment. Children may not always correctly recognize danger.
- Keep the packing materials, such as foil away from children. The danger of suffocation could arise in the case of misuse.
- Never open the housing of the TFT display (electric shock, short-circuit and the danger of fire)!
- Do not insert any objects through the slots and openings into the inside of the TFT (electrical shock, short-circuit and the danger of fire)!
- The remote control has a class 1 infrared diode. Do not examine the LED with optical instruments!
- Slots and openings in the TFT display are for ventilation purpose. Do not cover these openings, as otherwise this may lead to overheating (overheating, danger of fire)!
- Never exert pressure on the display. This could damage the display.
- An injury hazard exists when the display breaks. Wear protective gloves to pack the broken parts and send them into your service center for proper disposal. Then wash your hands with soap, because it is possible for chemicals to escape.
- Do not touch the display with your fingers or with sharp objects to avoid damage.
- Please proceed as outlined in the service center section:
 - if the AC cable overheats or is damaged
 - if liquid has gotten into the display
 - if the device does not work properly
 - if the device is dropped or the housing damaged

Point of use

- In the first hours of operation, new devices may emit a typical, unavoidable but completely harmless smell, which will decline increasingly in the course of time.
- We recommend you to ventilate the room regularly, in order to counteract the formation of the smell. During the development of this product, we have made sure that the applicable limits are clearly fallen below.
- Keep your LCD TV and all units connected to it away from moisture and avoid dust, heat and direct sunlight. Failure to observe these instructions can lead to malfunctions or damage to the LCD TV.
- Do not operate your device in the open air, because external influences, such as rain, snow, etc. could damage the device.
- Do not subject the device to drops or splashes of water and do not place any vessels filled with water, such as vases, on the device. Water penetrating the device can impair its electrical safety.
- Do not place any open sources of fire (candles or similar objects) on the device.
- Pay attention to sufficiently large clearances in the wall cupboard. Maintain a minimum clearance of 10 cm around the device for sufficient ventilation.
- Place and operate all units on a stable, level and vibration-free surface in order to avoid the LCD TV from falling.
- Avoid dazzle, reflections, extreme light/dark contrast in order to save your eyes and ensure a pleasant, ergonomic work station.
- The optimum viewing distance is 5 times the screen diagonal.

Repair

- Leave all repairs of your LCD TV to authorized and qualified personnel only.
- Should a repair be necessary, please contact one of our authorized service center.

Intended Environment

- The device can be operated at an ambient temperature of between 5° C to 35° C and at a relative humidity between 20% and 85% (without condensation).
- When switched off, the monitor can be stored most reliably between -20° C - +60° C).
- Provide an interval of at least one meter from high-frequency and magnetic sources of interference (television sets, loudspeakers, mobile telephones, etc.) in order to avoid malfunctions and data loss.
- After transporting your LCD TV please wait until it has assumed the ambient temperature before connecting and switching it on.
- Large variations in temperature and humidity can cause condensation to occur inside the LCD-TV, which may cause an electrical short circuit.
- Disconnect the power plug from the power socket and the aerial from the aerial connection during storms or if the device is not being used for a long time.

Power Supply



Please pay attention: Parts of the device are still live, even if the mains switch is switched off. Pull the mains plug out of the socket, to interrupt the power supply to your LCD TV or to release the device from voltage completely.

- Operate your TFT display mains (power supply) only on grounded sockets with 230 V ~ 50 Hz. If you have doubts about the power supply in the location where the LCD-TV is installed, consult your energy supplier.
- For additional safety we recommend use of an excessive voltage protection device to protect your LCD TV from damage resulting from voltage surges or lightning.
- To interrupt the display from mains (power supply) disconnect the plug from the socket.
- The power socket must be in the vicinity of your LCD TV and within reach of the power cables.
- If you use an extension cable, please ensure that it complies with the VDE requirements. If necessary consult your electrical equipment supplier.
- You should lay the TFT Display cables in a manner that no one can trip or step on it.
- To avoid damage of cable do not place any objects or furniture on the cable.

Standards/electro-magnetic compatibility

Your display fulfils the requirements for electro-magnetic compatibility and electrical safety specified in the following standards:

Standards/electro-magnetic compatibility	
EN 55013	Limit values and measuring methods for radio interference by radios and television receivers and accessories
EN 55020	Electromagnetic immunity of broadcast receivers and associated equipment
EN 60065	Audio, video and similar electronic apparatus—Safety requirements
EN 61000-3-2	Electromagnetic compatibility (EMC)—Part 3-2:Limits—Limits for harmonic current emissions (equipment input current up to and including 16 A per phase)
EN 61000-3-3	Electromagnetic compatibility (EMC)—Part 3-3:Limits—Limitation of voltage changes, voltage fluctuations and flicker in public low-voltage supply systems, for equipment with rated current ≤ 16 A per phase and not subject to conditional connection

Batteries and Proper Treatment

Batteries may contain combustible materials. By misuse, this may cause battery leakage, heat, explosion or ignition, bringing about injury or damage to the device.

Please observe strictly the following matters:

- Keep children away from batteries. If by any chance, the batteries are swallowed, consult a doctor immediately.
- Do not charge batteries (except rechargeable batteries).
- Do not forcibly discharge batteries.
- Do not short-circuit batteries.
- Do not heat or dispose off in fire. .
- Do not disassemble or deform batteries. Your hands and fingers may be injured, or the liquid of the battery may get into your eyes or adhere to your skin. If this happens, rinse with a large quantity of water immediately and consult a doctor.
- Do not expose batteries to strong impact by dropping or throwing the batteries.
- Do not reverse the positive (+) and negative (-) terminals to avoid short-circuit.
- Do not mix used and new or different types of batteries together.
- Remove promptly the used batteries from the device.
- Remove the batteries from your device if it is not to be used for a longer period.
- Clean the battery and device contacts, if necessary, before inserting batteries.
- Replace all batteries with new batteries of the same type at the same time.

**NOTE:**

Read the Safety Information Chapter under all circumstances before bringing the device into operation.

Unpacking

Have someone help you when unpacking the equipment.

1. Do not carry the equipment alone, otherwise it could fall or cause personal injury.
2. Open the box very carefully to prevent the equipment from being damaged. Damage can occur if a knife with a long blade is used to open the box.
3. There are various small parts in the packaging (batteries, screws, etc.). Keep these out of the reach of children. There is a risk of swallowing the parts.
4. Please keep the packaging material well and use it exclusively to transport the television.

Putting the batteries into the remote control

1. Remove the small cover on the battery compartment on the back of the remote control.
2. Install two AAA size, type R03 batteries according to the correct polarity (marked in the battery compartment).
3. Close the battery compartment.

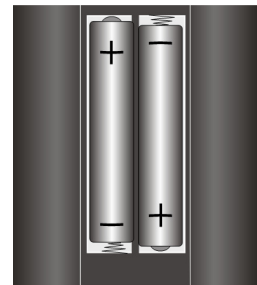
**ATTENTION!**

Remove the batteries from the remote, if the device will not be used for a longer period. The remote could be damaged by leaking batteries.

Connecting an antenna

Connect the aerial connection and the LCD-TV by means of a double screened aerial cable (not supplied) when connecting the device to the room aerial or cable system.

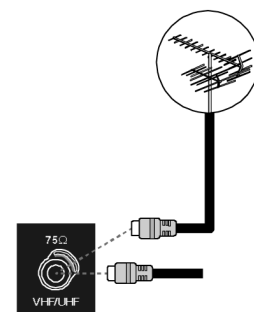

Connecting the power supply

Insert the plug on the supplied power cable into the connecting bush (220-240 V ~ 50 Hz) on the device and insert the other end into an easily accessible 230 V ~ 50 Hz power socket.

Turning the LCD TV on and off

1. Press the on/off switch on the back of the device. The stand-by mode will be activated and a blue light on the front will come on.
2. You can switch on the device by pressing a **DIGIT KEY** on the remote control or a **P/CH** channel selection key on the remote control or on the device itself. The light on the front will go out.
3. You can put the device back into stand-by mode with the stand-by key on the remote control or with the stand-by key on the right side of the device.
4. Press the on/off switch on the back of the device again to switch the device off completely.

After switching on for the first time

When you switch your LCD-TV on for the first time, the **First Time Installation** menu will appear. Enter the affordable information concerning **Language** and **Country** and start the automatic search. Follow the displayed instructions.

Automatic channel seeking

Automatic channel seeking will now commence. This takes a few minutes.

The channels are stored in a country-specific sequence in the channel locations. It is possible to store a maximum of 100 channels.

Channel Search

- You can select a channel by pressing the **P/CH** key (on the device or on the remote control) or by selecting the channel directly using a digit key.
- For a number with two digits first press the **-/--** key.
- You can select the most recent displayed channel with the **P<P/SWAP** key.

Sound Settings

- You can increase or decrease the volume with the volume keys **+** **▲** **—** on the remote control or on the device.
- You can switch off the sound completely and switch it on again with the  key (Switch sound off).
- You can choose between mono- and stereo reproduction, **Dual I** and **Dual II**, with the **I-II** key. **Dual I** and **Dual II** can only be reproduced if the current broadcast supports the DUAL mode (e.g. with bilingual broadcasts).

Setting the Picture

Zoom mode (key)

Press on the  key to switch between the following picture formats.

- **Auto**: the transmitted format is automatically set to the input signal.
- **16:9**: a picture in 16:9 format will be expanded to full screen size.
- **4:3**: for undistorted display of the picture in 4:3 format.
- **Panoramic**: the picture is stretched on the left and right sides to fill up the screen. In this case the upper and/or lower edges are somewhat cut off.
- **14:9 Zoom**: a picture in 14:9 format ("Letterbox") will be expanded to the upper and lower edges of the screen.
- **Cinema**: a picture in 16:9 format will be expanded to full screen size.
- **Subtitle**: As with the "Cinema" setting. The picture is only shifted up, so that any subtitles or running text become visible.
- **Zoom**: the picture is automatically expanded to full picture width.

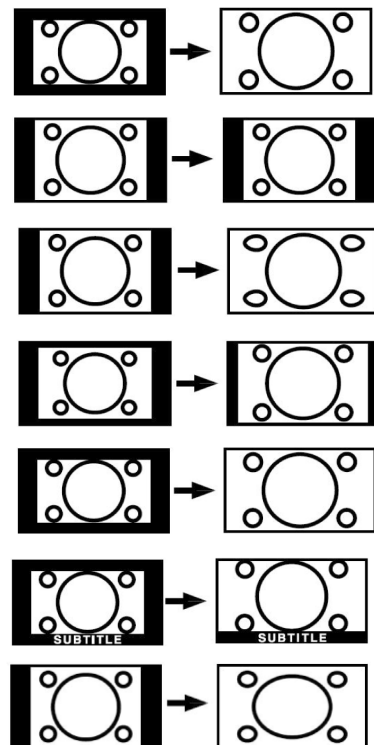

Zoom in PC mode

- You can make use of the **4:3** and **16:9** formats in PC mode.

Other picture settings

- You can pause and again release the picture with the **OK/SELECT** key.
- You can select the picture mode with the **PP** ("Personal Preferences") key: **Natural**, **Cinema**, **Dynamic**.

Displaying information

- Press on the **INFO** key to display the following current settings:
 - Channel location and channel name;
 - Volume setting (Mono of Stereo);
 - Picture setting.
- You will receive the same information when you switch over to another channel.
- You can display the time in **TV** mode by pressing the  key (Time/Sub-page videotext).

Select external device

- You can select the IN connections on the connected devices with the **AV/ SOURCE** key.



Note that the source (the connected device) will only be recognised if this source is highlighted in the **SOURCE** menu when switching through with **THE AV/ SOURCE** key.



- **P-** : TV function (aerial signal)
- **EXT - 1**: device on SCART 1 input
- **EXT - 2**: device on SCART 2-input
- **EXT-2 S**: device with S-Video output on SCART 2 connection
- **BAV**: device on yellow/white/red RCA inputs
- **S-VIDEO**: device on S-Video connection
- **HDMI-1**: HDMI input 1
- **HDMI-2**: HDMI input 2
- **YPBPR**: device on Component video and audio inputs
- **PC**: device on PC input

Video text

Your LCD-TV supports 1000 pages of Teletext. This means that the device does not need to search following input of one of these 1000 pages, but will immediately display the page in question.

Video text is a free service that is broadcast by the majority of television stations and offers current information in relation to news, the weather, television programs, share prices, subtitles and other subjects. Your LCD TV offers many useful functions for operating Video text and multi-page text, storing sub-pages or fast navigation.

To operate video text

1. Select a TV station on which video text is being transmitted.
2. Press on the  key to display the basic/index page of the video text.
3. The TV picture will be displayed on the left after you have pressed the  key again.
4. By pressing the  key again, you will switch over again to TV mode.

Press the TV key to return to TV mode.

Select video text pages

Number keys

- Enter the video text page required directly as three-digit number with the number keys.
- The page number selected will be displayed in the upper left corner of the screen. The video text counter will search un-til the page number selected has been found.

Channel selection keys

- You can scroll forwards and backwards through the video text pages with the channel selection keys.

Colour buttons

- If text is displayed in colour at the bottom of the screen, you can select the associated content immediately by pressing the associated **RED**, **GREEN**, **YELLOW** or **BLUE** keys.

Subpages

Some video text pages contain sub-pages. For example, **1/3** will be displayed at the lower edge of the screen. The sub-pages will be faded in successively at intervals of approx. 30 seconds.

You will also be able to call up the sub-pages yourself by pressing the  button. A four-digit entry field, into which you will be able to enter the number of a sub-page (e.g. 0002), will appear. You can scroll through the sub-pages with the directional keys **◀ ▶**.

Useful features for video text

Combination of video text and TV picture

- Press the  key to display Teletext transparently (the TV picture is visible in the background).

INDEX

- Press this button to select the index page that displays the list of Teletext contents.



STOP

The video text page that you have selected may contain more information than will fit on the screen. In this case the information will be sub-divided across several sub-pages. The sub-pages will be scrolled through with regular pauses in between.



- Press the **STOP** key to prevent pages from changing automatically. The **STOP** symbol will be displayed in the top left corner of the screen and the automatic switching over of pages will be interrupted.
- Press the **STOP** key again to resume automatic changing of pages.

Suppress TT Search

If you press the  key in video text mode, the video text display will move to the background. With this you can bridge waiting times until the required page displays.

- Select the required page number in the video text mode.
- Press on the  key to switch to TV mode while waiting for the video text page. A field will appear in the top left corner with the required page number or the  symbol while searching continues.
- The page number will be displayed as soon as the required page is found.
- Press the  key again to display the required page.

Displaying hidden text

- You can display hidden information, such as solutions to riddles, puzzles or quizzes, by pressing the  key once.
- If you press the  key again, the answers will be hidden again.

PIP and PAP

You can display two images from different sources simultaneously on the LCD-TV screen with the PIP and PAP functions (e.g. TV picture and picture from connected DVD player).

- PIP ("Picture in Picture"): A small picture (the PIP window) appears within the main picture.



- PAP ("Picture in Picture" = The pictures are displayed side by side.

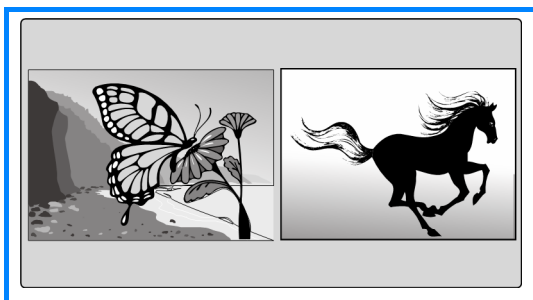



Sources for PIP and PAP

If you wish to display two pictures in the PIP or PAP mode, the picture from one source must come from one of the analogue connections and the picture from the other source from one of the digital connections on the LCD-TV.

- The following analogue sources are available: Aerial (**TV**, TV picture), SCART connections (**EXT-1**, **EXT-2** and **EXT-2 S**), Video-Audio RCA connections and (**BAV**), S-Video.
- The following digital sources are available: **HDMI 1** and **HDMI 2**, Component connections (**YPBPR**) and PC.

You can therefore combine the TV picture with the picture from a connected PC, or the picture from a DVD player on a SCART connection with the picture from a DVD player on a HDMI connection.

Activating and modifying the PIP function

1. Connect a device (e.g. a DVD player) to one of the digital inputs (HDMI 1, HDMI 2, YPbPr or PC).
2. If the LCD-TV does not itself display the picture from the external device, select the source with the **AV/SOURCE** key or in the **SOURCE** menu. The picture from the external device is now the main picture.
3. Press the  key. The PIP window (small picture) will now appear with the TV programme (aerial signal) within the main picture.
 - You can select another channel for the TV picture in the PIP window with the channel select keys.
 - You can select another source for the PIP window with the **AV/SOURCE** key (a device that is connected to one of the analogue inputs).
 - You can switch the sound reproduction between the main window (connected device) and the PIP window with the directional keys ◀ ▶.
 - You can swap the PIP window and the main picture with the **P>P/SWAP** key.
 - You can close the PIP window by pressing  again.

The PIP menu

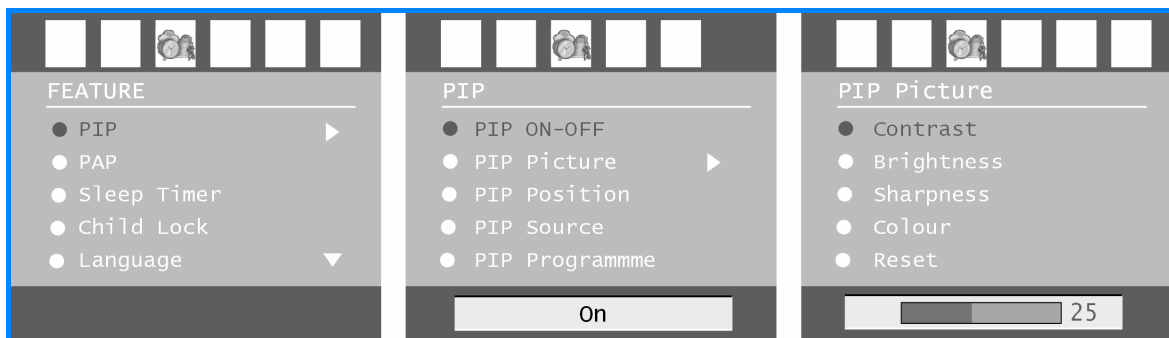

You can enter various settings for the PIP window.

- While the PIP window is displayed, press on the menu key **M** and open the **FEATURE** menu.
- Open the PIP menu with the directional key ▶.



Menu point	Settings
PIP ON-OFF	Switching the PIP function on or off.
PIP Picture	Open the PIP Picture sub-menu with the directional key ▶. The settings correspond with those on the PICTURE menu
PIP Position	Select a position within the main picture with the ◀ ▶ key.
PIP Source	Select the source for the PIP picture. If the main picture comes from an analogue source, then you can select from the digital sources here.
PIP Programme	Select the programme with the directional keys ◀ ▶ or the digit keys.
PIP Swap	With this you can swap the PIP picture and the main picture.

Activating and modifying the PAP function

1. Connect a device (e.g. a DVD player) to one of the digital inputs (HDMI 1, HDMI 2, YPbPr or PC).
2. If the LCD-TV does not itself display the picture from the external device, select the source with the **AV/SOURCE** key or in the **SOURCE** menu. The picture from the external device is now the main picture.
3. Press the  key. The PAP window with the TV programme (aerial signal) will now appear to the right of the main picture.
 - You can select another channel for the TV picture in the PAP window with the channel select keys.
 - You can select another source (a device that is connected to one of the analogue inputs) for the PAP window with the **AV/SOURCE** key.
 - You can switch the sound reproduction between the main window (connected device) and the PAP window (TV) with the directional select keys **◀ ▶**.
 - You can swap the PAP window and the main picture with the **P>P/SWAP** key.
 - You can close the PAP window by pressing  again.

The PAP menu

You can enter various settings for the PAP window.

- While the PAP window is displayed, press on the menu key **M** and open the **FEATURE** menu.
- Open the PAP menu with the directional key **▶**.

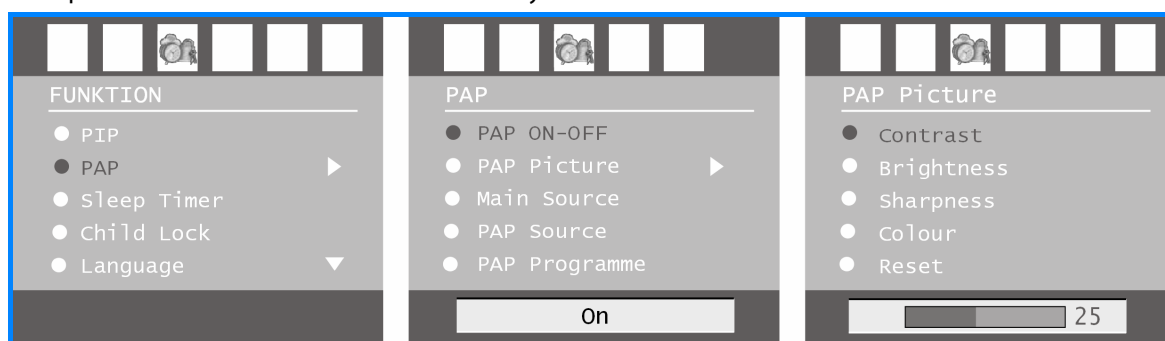

Menu point	Settings
PAP ON-OFF	Switching the PAP function on or off.
PAP Picture	Open the PAP Picture sub-menu with the directional key ▶ . The settings correspond with those on the PICTURE menu
PAP Position	Select a position within the main picture with the ◀ ▶ key.
PAP Source	Select the source for the PAP picture. If the main picture comes from an analogue source, then you can select from the digital sources here.
PAP Programme	Select the programme with the directional keys ◀ ▶ or the digit keys.
PAP Swap	With this you can swap the PAP picture and the main picture.

The DVB-T Mode

If a DVB-T signal is broadcasted in your area, then you can receive it using an appropriate antenna. An additional receiver is not required for the reception of DVB-T programs.

A suitable key card is required for the reception of encoded / pay-view programs. A CI (**COMMON INTERFACE**) module (available at specialized dealers) must be inserted into the bay on the left side of the device. After that you can insert the card of your provider into the CI module.

Connecting DVB-T antenna

Attach the plug of the DVB-T antenna to the antenna connector on your device.

First Time Installation

When you switch your LCD-TV on for the first time, the **First Time Installation** menu will appear.

Enter the affordable information concerning **Language** and **Country** and start the automatic search. Follow the displayed instructions.

You can set certain parameters on the LCD-TV using the OSD menu (On Screen Display).

Navigating within the Menu

1. Press the **M** button to activate the OSD.
2. Select the options from the main menu with the directional keys ◀ ▶ .
3. Select the options from a menu with the directional keys ▲ ▼ .
4. Go back to the main menu with the directional key ▲ .
5. Open a sub-menu with directional key ▶ (not available in every menu).
6. Go back to the menu above with the menu key **M**.
7. Set the required value or enter another selection with directional keys ◀ ▶ .

Close the menu with the menu key **M** and confirm the selection at the same time.

NB: the menu will close automatically after approx. 15, 30 or 60 seconds if no key is pressed (setting in menu **FEATURE**).



ATTENTION:

The menus described here may vary from the menus on your screen because of possible technical modifications.

Menu PICTURE

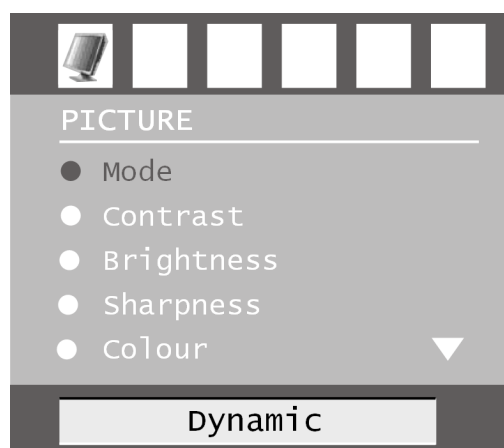

Menu point	Settings
Mode	Select image mode: Natural , Cinema , Dynamic . This function corresponds to the operation of the PP key.
Contrast	Reduce or increase the contrast (0-63).
Brightness	Reduce or increase the brightness (0-63).
Sharpness	Reduce or increase the sharpness (0-15).
Colour	Reduce or increase the saturation (0-63).
Colour Temp	Select hue: Normal , warm , Cold .
Noise Reduction	You can reduce noise in the image with this function and improve the image quality if the signal is weak. Select from Off , Low , Medium or High .
Film Mode	Films are recorded with a different number of images per second than are TV images. Select On when you watch a film to see the image quality of scenes with rapid movement better.
3 D Comb	The 3D comb filter is used to improve colour transitions and the colour quality of images. Select On or Off .
Zoom	Here you can select the image settings, as with the WIDE key.
Reset	Reset all image settings to the factory settings with ▶ or OK .
Store	Store the settings here with ▶ or OK .

Menu SOUND



Menu point	Settings
Volume	Basic setting of the volume when switching on (range 0-63). Select a limited basic volume.
Equalizer	Open EQUALIZER sub-menu: See following section
Balance	Balance between left and right loudspeaker (range -31 - 31).
Headphone	Opens HEADPHONE sub-menu: See next section but one.
Sound Mode	Sound mode: Choose between Stereo and Mono. If the current broadcast supports the DUAL mode (e.g. with bilingual broadcasts) then you can also choose here between Dual I and Dual II (original language and synchronisation). This function corresponds to the operation of the I-II key.
AVL	The AVL (Automatic Volume Limiting) function aligns the various volumes of the various transmissions with each other. Off : Original volumes; On : Equal volume
Effect	Switch sound effect on or off. If the current Sound Mode is set to Mono, the sound will be perceived as with stereo reproduction if the sound effect is switched on. If the current Sound Mode is set to Stereo, the sound will have greater depth.
Dynamic Bass	Set the bass sounds to Low , High or Off . The High setting is not recommended at high volume.
Store	Store the settings here with ▶ or OK .

Submenu EQUALIZER

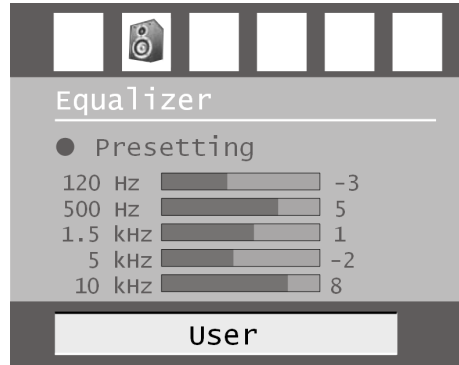

Menu point	Settings
Sound Mode	Make your choice from various Equalizer pre-sets. With the Pop , Rock , Jazz and Classic settings the sound settings are optimised for the type of music in question; Normal is the normal setting.
User	You can define your own setting with the User setting: Choose a frequency band with ▲ ▼ Choose a value with ◀ ▶.

Submenu HEADPHONE



Menu point	Settings
Volume	<p>Set the volume of the headphones (range 0-63). (You can only set the volume of the main speakers with the + ◀ — loudspeaker keys.)</p> <p> WARNING! In the first instance set the volume to a value at the lowest end of the scale before you put on the headphones. Then select a comfortable volume. Excessive volume can damage your hearing.</p>
Sound Mode	Choose between Stereo and Mono for the headphones. If the current broadcast supports the DUAL mode (e.g. with bilingual broadcasts) then you can also choose here between Dual I and Dual II (original language and synchronisation).
Balance	Balance between left and right loudspeaker for the headphones.

Menu FUNCTION

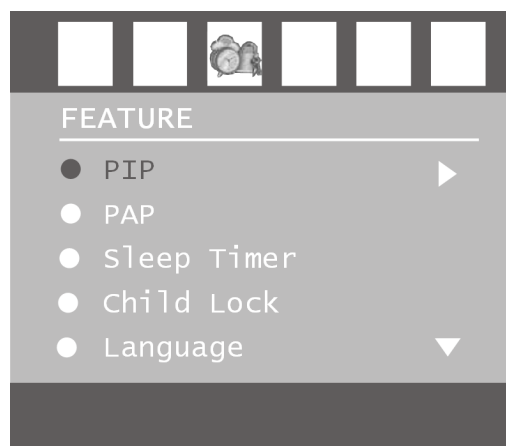

Menu point	Settings
Sleep Timer	Select the time after which the device is automatically turned off. You can set the time in steps of 10 minutes (maximum 2 hours) with the directional keys ◀ ▶. The time for the Sleep Timer will start to run as soon as you have set the switch off time. Select Off to switch off this function.
Child Lock	If you put the setting to On , then the keys on the device will be blocked (with the exception of the on/off switch)
Language	Choose the language for the OSD menu. This will change immediately.
Ext-2 Out	This sets which signal will be put out as the output signal via the SCART-2 connection. Choose between TV , EXT-1 , BAV , YPbPr Audio , PC and Audio . - If HDMI is selected as the input source, the HDMI Audio option is also available.
PC Audio In	This sets which signal will be input via the PC-AUDIO input. Choose between TV , EXT-1 , EXT-2 , BAV , YPbPr Audio and PC Audio .
Blue Background	If the LCD-TV does not receive any signal, a blue background will appear instead of "snow" or a black image.
Menu Background	Here you can make the menu background more or less transparent by means of the directional key ◀ ▶.
Menu Timeout	Here you can set the time after which the OSD menu will automatically close: 15, 30 or 60 seconds.
Teletext Language	The pre-set is West . If you are in a different language region, you can change the language setting: East , Turk/Gre , Cyrillic or Arabic .
Standard Format	Set the standard zoom here to Panorama , 16:9 , 4:3 or 14:9-Zoom .

Menu INSTALL

Under normal circumstances, the automatic channel seek function looks for the available channels and these are automatically stored on the channel locations in the order they are found. You can reorder the channel locations in the channel table (see menu "PROGRAM TABLE").

The **INSTALL** menu moreover puts you into a position to search for individual channels manually and to store them as well as to adjust the picture to the optimum setting.

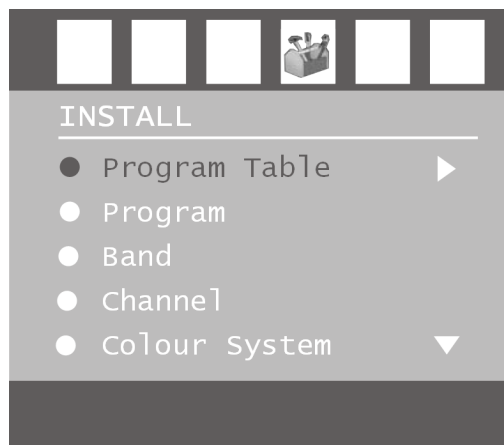

Menu point	Settings
Program Table	Open the channel table (see following section) with ►.
Program	<p>This displays the number of the channel location of the current channel. You can select another channel location with the directional keys ◀ ▶ or with the digit keys (0 to 99).</p> <p>Store the new channel location with the OK key or by selecting the Store option and pressing on ►. The Stored... message will then be displayed.</p> <p>Remember that the current channel will be saved onto the selected channel location. The channel will be stored under the channel number (e.g. "C-25") and not under the channel name.</p> <p>It is advisable to reserve channel location 0 if you want to connect a video recorder.</p>
Band	The television frequency band is sub-divided into channel types C (Normal channel) and S (Special channel). This displays the channel type of the currently set channel.
Channel	This displays the channel number of the currently set channel. You can select another channel with ◀ ▶.
Colour System	<p>Here you select a country-specific TV colour standard: Auto (the correct colour system is set automatically), PAL (for PAL 50 MHz), SECAM, PAL 60. If the video standard (see following option) is set to "I", then SECAM is not available.</p> <p>If an external source is selected (EXT - 1, etc.), NTSC 3.58 and NTSC 4.43 (usual colour format in North America) are also available.</p> <p>Choosing an incorrect colour system will result in an incorrect picture.</p>
Sound System	<p>Here you select a country specific TV system (video standard): BG (West Europe), I (Great Britain), L, L' (France) or DK (countries in Eastern Europe).</p> <p>Choosing an incorrect video standard can also result in an incorrect picture.</p>

Fine Tune

Here you can adjust the picture of the currently selected channel with ◀ ▶ .

Search

Here you can search channels manually.

Start a search up or down with the directional keys ◀ ▶ . The search will be interrupted with every programme that is found. The MHz value will be displayed.

You can assign a location to the channel under the **Program** menu option.

Remember that when you save a different channel that location will be written over.

You can adjust the channel further using the **Fine Tune** menu option (see previous section).

Store the channel by pressing the **OK** key or by selecting the **Store** option and pressing on ▶ . The **Stored . . .** message will then be displayed.

Store

Saving selected channel (see **Program** and **Search** options).

Save video recorder manually

The manual search function can, for example, be used to set a video recorder on the LCD-TV.

Once the LCD-TV and the video recorder are connected via the aerial, you should tune your video recorder to the test signal.

- Perform the manual search action on the LCD-TV.
- Once the test signal has been found, store the test signal under channel location **0** (no TV channel is stored on this channel location).

PROGRAM TABLE

The channel table displays the currently stored channels. The channels are displayed under their channel names, insofar as the TV channel supports this function. The channel number **S-** or **C-** if the name cannot be displayed. Here "S" stands for special channel and "C" for normal channel ("Channel").

The channel memory can store 100 channels. Activate the cursor in the table with the directional key **▼**. You can open another column by going to the right column with the directional key **▶** and pressing **▶** again.

Program Table			
P01	VTM	P11	S 02
P02	KANA2	P12	S 06
P03	EEN	P13	S 10
P04	KETNE	P14	S 11
P05	LAUNE	P15	C 07
P06	LADEU	P16	C 09
P07	RTLTV	P17	S 15
P08	VT4	P18	S 22
P09	VIJF	P19	C 18
P10	VITAY	P20	C 21

Name	Insert
Delete	APS

Menu point	Settings
Name	<p>Now you can change the channel name.</p> <p>Highlight the required channel name and press the red key. You can now change the first letter. Select a symbol with the directional keys ▲ ▼. – The symbols are displayed in the following sequence: A B C [t/m] Z a b c [t/m] z () * + , . / [space] - _ 0 1 2 [t/m] 9.</p> <p>Use the directional key ▶ to go to the next letter, and so on. At the end press the red key again to store the name.</p>
Delete	<p>Select the channel you wish to remove from the list and then press the yellow key. Press the yellow key again to confirm. The channels underneath will shift up one place in the table.</p>
Insert	<p>With this you can shift a channel to another location.</p> <p>Select the required channel and press the green key. Move the channel to the required location with ▲ ▼ and press the green key again. The other channels will move as well.</p>
APS	<p>You can search for channels automatically with APS.</p> <p>Press the blue key. A text will appear: "WARNING! All Prestored Programs will be deleted". Select another country if necessary with the directional keys ◀ ▶. The country setting has an effect on the sequence in which channels are stored.</p> <p>Press the blue key if you want to cancel the function. Press the red key or OK to start searching. The channel table will be displayed after the search is finished.</p>

Menu SOURCE

You can select another input source in this menu. You can also highlight a source so that you can select this directly with the **AV** key.

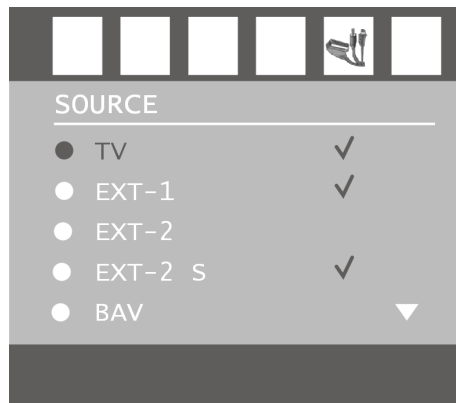

Menu point	Settings
TV	Aerial use (TV channel)
EXT-1	Left SCART connection (analogue)
EXT-2	Right SCART connection (analogue)
EXT-2 S	Right SCART connection with transmission of S-Video picture signals (analogue)
BAV	Video-Audio input - yellow/red/white (analogue)
S-VIDEO	S-Video input (analogue)
HDMI 1	Right HDMI input (digital)
HDMI 2	Left HDMI input (digital)
YPbPr	Component inputs (digital)
PC	PC input (digital)

- Select the required source with ▲ ▼ .
- You can switch over to this source by pressing on the directional ► .
- You can highlight a source by pressing **OK**.
If the menu is closed, you can immediately select all sources that are highlighted in the menu with the **AV** key.

Depending on the selected external source, the **INSTALL** menu is unavailable or available but with fewer options.

The OSD menu has the following option in PC mode:

Menu PC POSITION

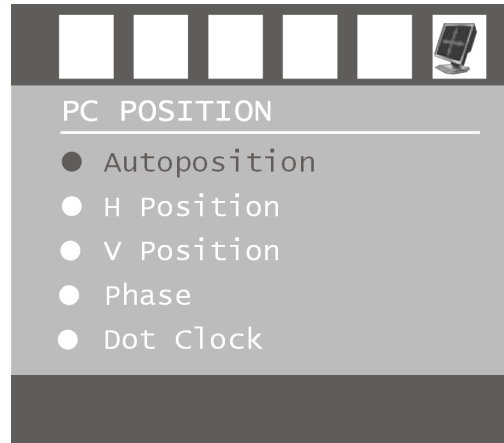

Menu point	Settings
Autoposition	If the picture has shifted, you can select the Autoposition option and press OK to move it back to the middle of the screen. This function has to be performed with a full picture, otherwise the settings will not match.
H Position	Here you can change the horizontal position of the picture with the use of ◀ ▶ .
V Position	Here you can change the vertical position of the picture with the use of ◀ ▶ .
Phase	If the PC picture does not display clearly, you can align the picture signal here with the pixels on the LCD-TV with the use of ◀ ▶ . This makes the picture sharper and more even.
Dot Clock	Pixel frequency. This setting synchronises the signal display with the pixel frequency of the screen. This corrects errors that can appear as vertical stripes with pixel intensive reproductions (such as tables or texts with small fonts). Adjust the pixel frequency with ◀ ▶ .

The OSD menu has the following option in DVB-T mode:

Menu CHANNEL LIST

The channel list displays the currently stored channels. The channels are displayed under their channel names, insofar as the TV channel supports this function.

The **Channel List** allows you to move, erase, rename and block programs or to add them to your favourites. Please follow the on-screen instruction to modify a setting.

Menu INSTALLATION

Under normal circumstances, the automatic channel seek function looks for the available channels and these are automatically stored on the channel locations in the order they are found. You can reorder the channel locations in the channel table (see menu "CHANNEL LIST").

The **INSTALLATION** menu moreover puts you into a position to search for individual channels manually and to store them.

Menu point	Settings
Automatic Search	You can search for channels automatically with automatic search. All previous channels will be deleted and replaced.
Manual Search	Here you can search channels manually.
First Time Installation	The first installation can be started here. All previous settings will be deleted.

Menu CONFIGURATION

Menu point	Settings
Favourite Mode	Opens the predefined lists of favourites, which you previously defined under the menu item Channel List.
Channel List	Preset for Channel list (TV , Radio or Text)
Language Settings	Select and configure System Language , Audio Language and Subtitle Language
Parental Settings	To block the program enter a PIN code here. Take a note of the PIN code and store it at a safe location.
Time Settings	Configure the time settings
Receiver Upgrade	Show the actual version and searches for upgrades.

Menu TIMER

This menu item allows you to program up to 5 broadcasts, which you want to view in the specified sequence. Follow the on-screen instructions to modify settings.

Menu TV-SETUP

This menu items opens the settings, which have already been described in the chapter "The OSD menu" on page 22.





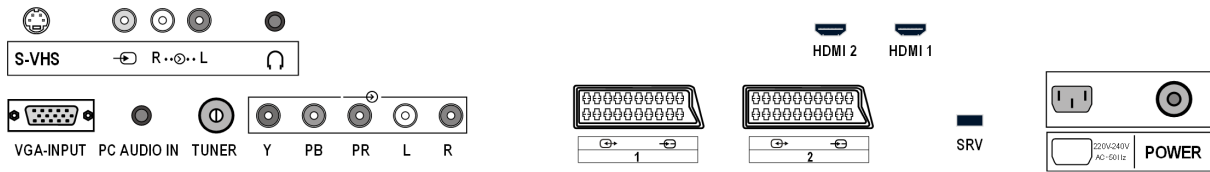

Menu COMMON INTERFACE

In case you have inserted a CI module with a key card of your provider into the LCD-TV for viewing encoded / pay-view programs, then you can modify settings here. Please refer to page 21.

Connections and examples of connections

The connections are on the rear of the device.

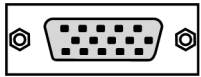

Connection	Name of source	Examples of connections
 S-VHS	S-VIDEO	S-VHS input (S-VIDEO) to connect a device to an S-VIDEO output (e.g. camcorder). You will need an S-Video cable for this connection.
 BAV	BAV	<p>VIDEO input (yellow) to connect devices such as camcorders, DVD players, decoders (e.g. satellite receivers), etc.</p> <p>AUDIO inputs L-R (red/white): Connect the left and right audio channels of the source here, if you want to reproduce the sound through the LCD-TV (e.g. camcorder). You will need RCA cables for these connections.</p> <p>Connect headphones or earphones here with a 3.5 mm TRS stereo connector to be able to hear the sound from your device via this connection. The main loudspeaker will remain switched on.</p>
 <p>Using this appliance at full volume for extended periods of time may cause damage to the hearing capacity of the listener.</p>		
 HDMI 2	HDMI 2	Digital connection: to connect an apparatus with an HDMI output. For this you need an HDMI cable.
 HDMI 1	HDMI 1	Same as HDMI 2 .
 VGA-INPUT	PC	VGA connection. Connect your PC or notebook here. For this you need a VGA cable.
 PC AUDIO IN		Audio input for 3.5 mm TRS stereo connector, e.g. for PCs. You can select an input source in the FEATURE menu for PC-AUDIO IN .
 TUNER	P- (Channel number)	TV function Now connect the aerial cable.

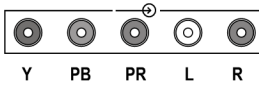

YPbPr

Y - PB - PR and AUDIO L - R (left - right): Component inputs to connect devices to Component output, such as camcorders, DVD players, decoders (e.g. satellite receivers), etc. You will need a green/blue/red Component cable for this connection for the video link, as well as a red/white RCA cable for the audio link.

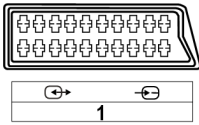

EXT-1

SCART input to connect devices such as video recorders, DVD players, games consoles, decoders (e.g. satellite receivers), etc. You will need a SCART cable for this connection.

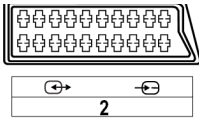

EXT-2

Same as **EXT-1**.

EXT-2 S

You can select an output source in the **FEATURE** menu for **EXT-2**. This SCART connection can also transmit better S-Video image signals (for devices with an S-Video output, e.g. camcorders). The S-Video picture signal is not, however, supported by all external devices.



SRV

This connection is only intended for servicing purposes. Do not try to connect a device to this.



Now connect the supplied mains cable.

Headphones

Connect the headphones to the headphone connection. The main loudspeakers will remain on when the headphones are connected. Regulate the volume level of the headphones by means of the volume keys and the Switch Off Sound key. You can adjust the volume of the headphones in the **SOUND** menu, **HEADPHONE** sub-menu, see Submenu **HEADPHONE**.

DVD player

Connect a DVD player with a SCART cable to the **SCART-1** or **SCART-2** connections.

You can also use red-white (for sound reproduction) and yellow (for picture transmission) RCA cables.

You can also use a S-VHS cable as an alternative to the yellow RCA cable.

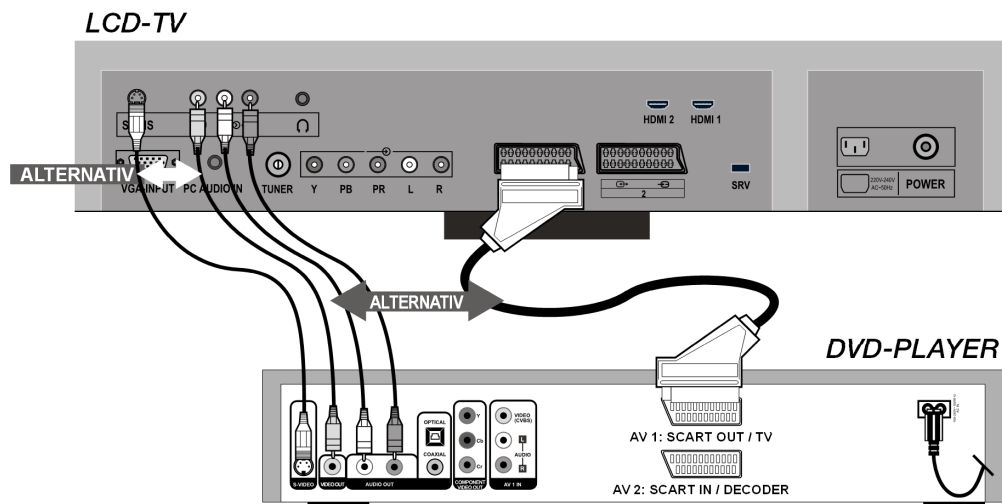

If the DVD player has YUV outputs (Y Pb Pr), it is advisable to connect these using a Component cable (green/blue/red RCA) to the **Y-Pb-Pr** and **L-R** Component inputs on the LCD-TV.

Video recorder

Connect an aerial cable to the aerial socket of the LCD TV and the aerial output of the video recorder, if you want to connect a video recorder to the LCD TV. Connect another aerial cable to the aerial input of the video recorder and the aerial socket on the wall.

In addition you can connect an LCD-TV and a video recorder with each other using a SCART cable.

If you want to transmit stereo sound you will need a SCART connection.

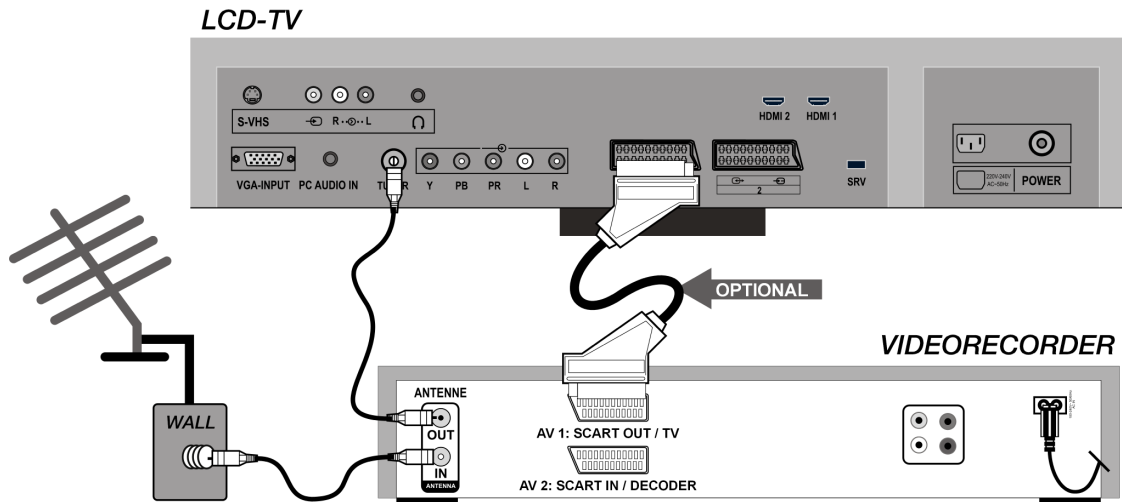

DVD recorder

You can connect a DVD recorder to one of the two SCART connections on the LCD-TV using a SCART cable.

In addition connect the aerial cable in the manner described in the "Video Recorder" section (see above.)

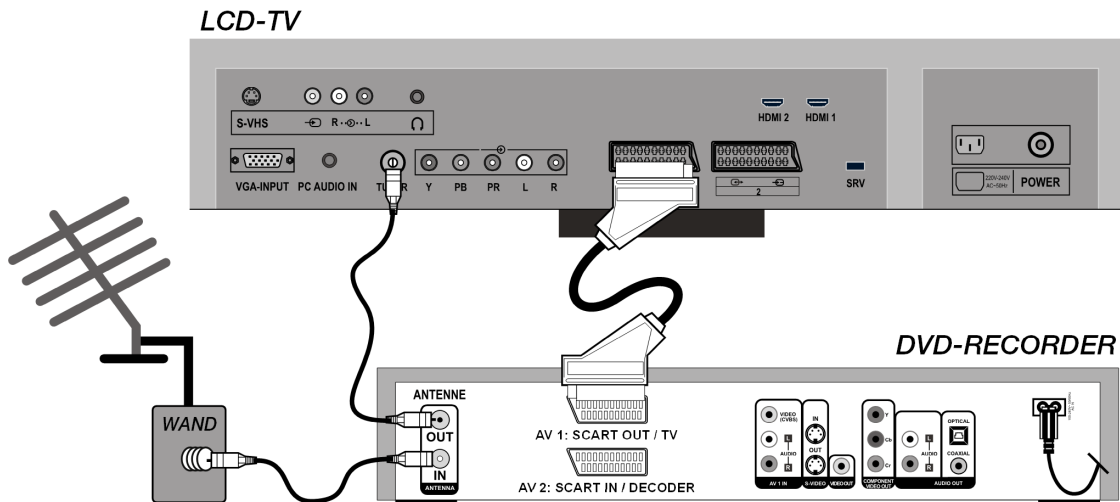

Receiver (SAT, DVB-T, decoder, etc.)

Connect a device that is intended to be used as a receiver for the LCD TV (e. g. SAT receiver, DVB-T receiver, decoder, set-top box) or a DVD recorder to the SCART socket, with a SCART cable.

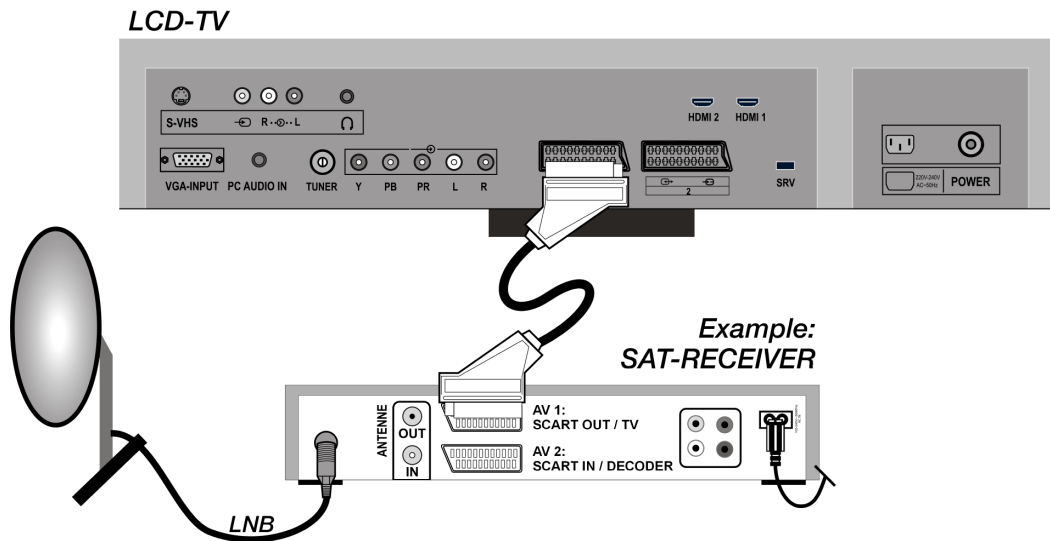

Apart from with SCART cables you can also connect the device with RCA cables:

- Connect (red-white) audio RCA cables to the audio inputs on the LCD-TV and the audio outputs on the external device.
- Connect a (yellow) video RCA cable to the video input on the LCD-TV and the audio output on the external device.
- Apart from using a video RCA cable you can also connect an S-Video video cable to the S-Video input on the LCD-TV and the S-Video output on the external device.

DVD or video recorder and Sat-receiver

If you want to connect a DVD or video recorder and a satellite receiver at the same time, you can use the following connection method:

LCD-TV

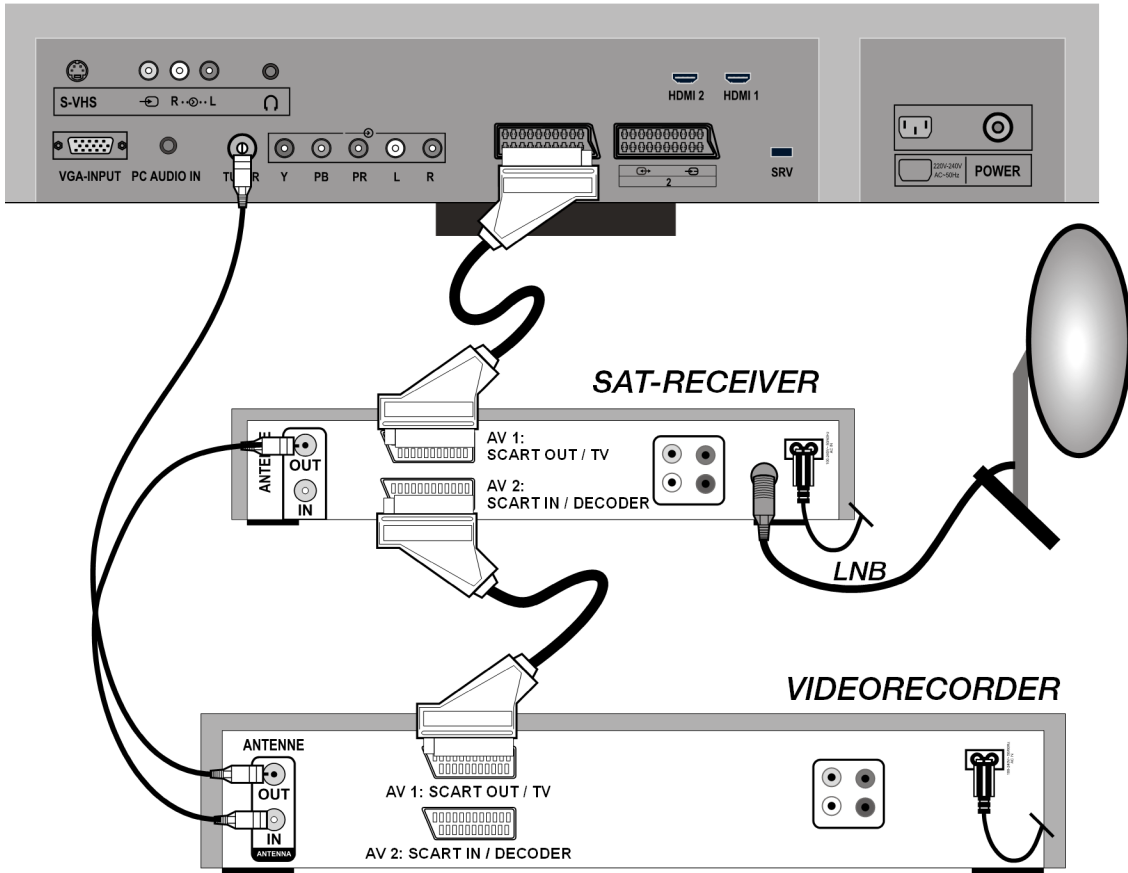

Camcorder

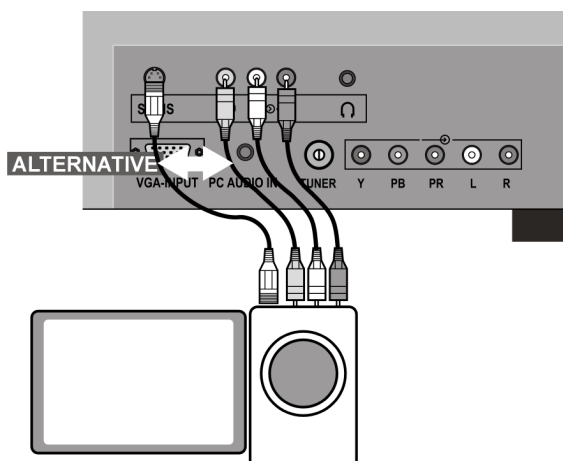

- You can reproduce the sound and pictures of a camcorder on your LCD-TV by connecting the camcorder to the AUDIO-IN connections and the VIDEO-IN connection on the LCD-TV.
- Apart from using a (yellow) video RCA cable you can also connect an S-Video video cable to the S-Video input on the LCD-TV and the S-Video output on the camcorder.

Device with HDMI or DVI output

HDMI ("High Definition Multimedia Interface") is the only interface in the entertainment electronics sector with which one can transmit audio and video data digitally at the same time. HDMI can process all picture and sound systems known at this time, including HDTV (High Definition Television), so that it can reproduce a resolution of 1080 i without loss of quality.

Many devices from the entertainment electronics sector, such as DVD players, are equipped these days with HDMI or DVI outputs.

External device with HDMI output

1. Connect an HDMI cable (not supplied) to one of the two HDMI inputs on the LCD-TV and the HDMI output on the external device.
2. Once you have connected the HDMI device, then switch on the LCD-TV.
3. Then switch on the external HDMI reproduction device.

External device with DVI output

If the external device has a DVI output, you can also connect it to the HDMI input (HDMI is backwards compatible with DVI - "Digital Visual Interface"). For this you need an HDMI-to-DVI adapter. Given that no sound can be transmitted via the DVI output, you also need to connect an audio cable with a TRS stereo connector to **PC AUDIO IN** and activate the **PC Audio** option in the **FEATURE** menu under **PC Audio In**.

PC

The LCD-TV can be connected as a screen or additional monitor to your PC or notebook. The image on your PC or notebook will then be displayed on the LCD-TV.

Connect the LCD-TV as follows:

1. Switch off both devices.
2. Connect a VGA cable (screen cable; not supplied) to the VGA input on the LCD-TV and to the output for the video card on the PC or the notebook.
3. Tighten the screws on the screen cable with your fingers so that the plug makes a good connection.
4. If you also want sound, connect an audio cable to the PC-AUDIO-IN input.
5. Switching the LCD-TV on first.
6. Only then switch on the PC or notebook.
7. Press the  key on the remote control in order to switch to PC mode. The PC image will appear on the LCD-TV. You can return to TV mode with the **TV** key.

If you use the LCD-TV as a second screen with your PC, then it may sometimes be necessary to adjust the screen settings in the operating system. You will find further information about matters you need to pay attention to when using more than one screen in the user manual for your PC or notebook.

The universal remote control

Scope of application

This universal remote control can operate the following types of devices:

- TV Television
- DVD DVD player MD 81777
- SAT, AUX Other devices (e. e. analogue satellite receivers, other DVD players, loudspeakers, tuners, etc.). The label indicates the device type to be programmed. It is used to provide an easier overview

Programming device codes

General information

For every device that you would like to operate using the universal remote control, you must program a four-digit device code to a source key (TV, SAT, AUX). You can assign any key to any device ("flex mode") with the exception of the TV button, which can only be assigned one television.

Video recorder: Perform the code search when a video is in the machine.

Enter the device code according to the code list

The codes of the corresponding devices can be found in the Code List at the end of these operating instructions. Proceed as follows:

1. Switch the relevant device on manually.
2. Keep the CODE key pressed for approx. 3 seconds until the red LED remains solid.
3. Briefly press the required source key (TV, SAT, AUX).
4. Enter the four-digit code from the Code Table.

The key lighting will extinguish briefly each time the key is pressed.

If the entered code was valid, the light of the source key will extinguish after the last digit has been entered. If an invalid code was entered, the red LED flashes for three seconds before extinguishing.

If the device does not respond as expected, repeat the programming, or try a different manufacturer's code. Select the code to which most of the remote control commands react correctly.

If this is also unsuccessful, try one of the search methods described in the following sections.

Manual code search

Carry out a manual search as follows:

1. Switch the relevant device on manually.
2. Keep the **CODE** key pressed for approx. 3 seconds until the red LED remains solid.
3. Briefly press the required source key (**TV**, **SAT**, **AUX**).
4. Keep pressing the (up to 350 times) **STANDBY** or **P/CH +/-** until the device that is to be controlled switches off, changes channels, or responds accordingly.
5. The code search begins at the currently stored number.
6. Briefly press **OK** to save the code.

Due to the considerable quantity of different code numbers, up to 350 different codes are pre-programmed per device type. In individual cases it may be possible that only the most common main functions are available. The process described here may not work for some special models.

Automatic search

If your device does not respond to the remote control, even though you have tried all of the codes listed for your device type and the relevant brand, then try using the automatic search. This will enable you to find codes for brands that were not listed in the device Code List.

1. Switch the relevant device on manually.
2. Keep the **CODE** key pressed for approx. 3 seconds until the red LED remains solid.
3. Briefly press the required source key (**TV, SAT, AUX**).
4. Point the remote control at the device and briefly press the button **P/CH +** once.
5. If the device has no program function, press **P/CH +** or STANDBY instead.
6. The remote control starts the code search after 6 seconds and transmits all codes consecutively at 1-second intervals. The source key will light up for each transmission.
7. As soon as the device responds to the remote control, press **OK**. – If you did not press **OK** at the right time, you can return to the code to which the device responded step by step by pressing **P/CH -** key. To cancel the search, press **EXIT**.

1 second or 3 second intervals

If you want the remote control to transmit a new code every 3 seconds instead of every second, proceed as follows:

Within 6 seconds of pressing the **P/CH +** (or STANDBY) key as described in Point 4 press the **P/CH +** or **P/CH -** key again. The remote control will now only transmit a new code every 3 seconds. This gives you more time, but the procedure will also take longer.

Code searching by brand name

This function gives you the option of searching by brand name (see code list). This is done as follows:

1. Switch the relevant device on manually.
2. Keep the **CODE** key pressed down for approx. 3 seconds until the background lighting of the source key briefly flashes and then remains on.
3. Briefly press the required source key (**TV, SAT, AUX**).
4. Enter the one-digit code according to the following table:
Key 1 = Medion, Tchibo
Key 2 = Philips, Radiola, Philco, Erres, Pye
Key 3 = Sony, Akai, Panasonic, JVC, Sharp, Toshiba, Daewo
Key 4 = Thomson, Brandt, Fergusson
Key 5 = Saba, Nordmende, Telefunken
Key 6 = Grundig, Blaupunkt
Key 0 = all brands.
5. Continue pressing the **P/CH +** key, until the device responds accordingly. Proceed quickly; otherwise the automatic code search will start.
6. Save the code by pressing **OK**.

If all the codes have been searched, the source key will flash for approx. 3 seconds.

Code identification

Code identification gives you the opportunity to determine codes that have already been entered and stored in the remote control. Proceed as follows:

Switch the relevant device on manually.

1. Keep the **CODE** key pressed for approx. 3 seconds until the red LED remains solid.
2. Briefly press the required source key (**TV, SAT, AUX**).
3. Briefly press the **CODE** button. The source key will briefly extinguish after the key has been pressed.
4. To find the first number, press the number keys from 0 to 9. If the source key extinguishes briefly, then it is the first stored number.
5. To determine the second number, press the number keys again from 0 to 9. Repeat the procedure for the third number.
6. The source key will extinguish as soon as the button for the third number has been pressed.

Code identification has now been completed.

Normal operation

Operating individual devices

After you have finished programming your remote control for your audio/video devices, the remote control will work in the common main functions just like the original remote control of the respective device.

Point your remote control at the desired device and press the relevant source key. The key will light up briefly but will not remain lit.

Activate the functions by pressing the corresponding function key of your universal remote control. The source key will light up briefly each time the key is pressed.

Please note:

- In certain circumstances, not every function of your original remote control may be directly available on the universal remote control.
- Especially for newer devices, it might be possible that the functions are stored to different keys than expected or may not even be available at all.

"All off" function

You can switch off all pre-programmed devices at the same time. This is done as follows:

1. Briefly press the STANDBY key. The selected device switches off and the relevant source key will light up.
2. Immediately press the (STANDBY) key again and keep it pressed for 3 seconds. Now all pre-programmed devices will be switched off consecutively. This takes about 3 seconds.

If a default device was switched off, it can be switched on via the "All off" function.

GUIDE - EPG – Electronic Programme Guide

The **GUIDE** (EPG - "Electronic Programme Guide") key has various functions depending on which code has been used:

- For DVD codes the button opens the title menu.
- For SAT- or VCR codes you can use the button for programming, if your device has an EPG function.

Troubleshooting

Many times, problems have simple causes. We would like to give you some tips to solve some common problems. Should these tips not help, please call us!

There is no picture or sound.

- Check whether the mains cable has been connected to the socket and the mains adapter correctly.
- Check whether the signal reception has been set to TV.
- Check whether the mains switch of the device on the rear of the device has been switched on.

There is no picture. There is no picture from AV.

- Make sure the Contrast/Brightness is properly adjusted.
- Make sure all external devices are connected properly.
- Check whether the correct AV setting has been selected.
- If you want to select an input source with AV you need to highlight this in the **SOURCE** menu.

There is no sound.

- Make sure the volume is not set to minimum.
- Make sure the sound is not set to mute.

There is no picture or sound, just noise.

- The reception may be weak. Make sure the aerial is not disconnected.

The picture is not clear.

- The reception may be weak.
- Make sure the aerial is not disconnected.

The picture is too bright or too dark.

- Check the contrast and brightness settings.

The remote control does not work.

- Check whether the batteries in the remote are operational and have been inserted correctly.
- Make sure the remote sensor window is not under strong lighting.
- Switch the device off and on again with the mains switch at the rear.

The picture is not sharp.

- The reception may be weak.
- Make sure the aerial is not disconnected.
- Check the sharpness and noise suppression settings in the **PICTURE** menu.

A double or triple image will be displayed.

- Check if the aerial is correctly oriented.
- The signal may be reflected off hills or buildings.

The picture is spotted.

- There may be interference from automobiles, trains, high voltage lines, neon light, etc.
- There may be interference between the antenna cable and power cable. Try moving them further apart.

There are stripes on the screen or colors fade.

- Is the unit receiving interference from other devices?
- Transmission antennas of radio broadcasting station and transmission antennas of amateur radio and cellular phones may also cause interference.
- Place the unit as far apart as possible from device that may cause possible interference.

The operating buttons on the device do not function.

- The child-lock may have been activated.

Do you require additional Support?

If the suggestions in the above section have not solved your problem, please contact the hotline. We will try and help you over the telephone. However, before you contact your Service Center, please keep the following information available:

- What external devices have been connected?
- What messages appear on your display?
- During which operating step has the problem arisen?
- When a PC has been connected to the device:
 - What is the system configuration?
 - Which software were you using when the problem arose?
- What steps have you already undertaken to solve the problem?
- If you have already been given a customer number, please keep this available.

Maintenance

16

The lifespan of the LCD-TV can be extended by the following means:

- Before cleaning, always remove the power adapter plug and all connecting cables.
- Do not use any solvents, corrosive or gaseous cleaning agents.
- Clean the display with a soft, lint-free cloth.
- Ensure that no water droplets remain on the screen. Water can cause permanent discoloration.
- Do not expose the screen to bright sunlight.
- Please keep the packaging material well and use it exclusively to transport the device.



ATTENTION!

There are no user-serviceable or user-cleanable parts inside the device.

Specifications

17

Input voltage:	230 V ~ 50 Hz
Visible display size:	40 inch (102 cm) TFT; 16:9-display
Power consumption:	240 W
Power consumption standby:	< 1 W
TV system:	PAL, SECAM, B/G, D/K, I, L/L'
Channels:	VHF (Band I/III) FM (BAND U) HYPERBAND KABEL-TV (S1-S20)/(S21-S41)
Audio:	Stereo
Channel positions:	100
Antenna interface:	75 Ohm
Dimensions (W x H x D, incl. stand):	1012 x 709 x 280 mm
Weight (incl. stand):	approx. 23 kg

Packaging



Your device is packaged to protect it against damage during transportation. The packaging is manufactured from materials that can be sent to a specialist recycling facility and disposed of in an environmentally-friendly way.

Device



At the end of its life, the appliance must not be disposed of in household rubbish. Enquire about the options for environmentally-friendly disposal.

Batteries



Do not dispose of used batteries in the household rubbish! They must be deposited at a collection point for used batteries.

Pixel errors with LCD TVs

Individual pixels or groups of them can fail in rare cases, in spite of the most up-to-date manufacture, because of the highly complex technology.

Active matrix LCDs (TFT) with a resolution of 1366 x 768 pixel, (WXGA) which are in turn composed of three sub-pixels each (red, green, blue), contain about 3 million addressable transistors. Because of this very high number of transistors and their extremely complex production process occasionally defective or incorrectly addressed pixels or sub-pixels may occur.

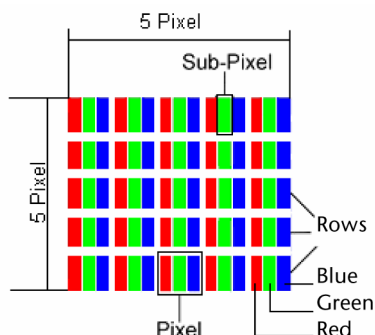

Description		Accepted Number
Bright sub-pixels	1 sub-pixel	Max. 2
	Two lying next to each other (horizontally/vertically)	0
Distance	Minimum distance between light and dark sub-pixels	Min. 5 mm
Dark sub-pixels	Individual	Max. 7
	Two lying next to each other	Max. 2
Distance	Minimum distance between light and dark sub-pixels	Min. 5 mm
Total number of bright and dark sub-pixels		Max. 7

The Table describes the maximum number of pixel faults that are permitted to arise on the screen, without involving a guarantee case. Under certain circumstances, a guarantee case will be present if the number of faults given above is exceeded in one category.

Copyright © 2007

All rights reserved.

This manual is protected by copyright. All rights reserved. Copying mechanically, electronically and any other way is prohibited unless written permission from the manufacturer is obtained.

The company MEDION® owns the copyright.

Subject to technical and optical changes as well as printing errors.

You can mount the LCD-TV onto a wall.

Accessories

The following accessories are supplied with the LCD-TV:

- 2 steel rails, 4 screws, 4 plastic hanging elements, 1 drill template,
- 1 illustrated mounting manual (applies to several types of device).
- You will also need 8 raw plugs and screws for fixing to the wall (available in trade shops).

Safety instructions for wall mounting

Be certain to adhere to the following safety instructions when mounting the unit on the wall:

- The LCD-TV must only be mounted onto straight perpendicular walls.
- Check before mounting if the load-bearing capacity of the wall equals at least three times the weight of the device (16 kg). Ask a qualified fitter for advice if in doubt.
- Switch the LCD-TV off before starting with mounting. The mains cable and aerial cable must be unplugged.
- At least two persons are required to carry out mounting.
- You will require an electric drill and a cross-head screwdriver to carry out the mounting.



ATTENTION!

Make sure that the raw plugs and screws that you select are suitable for your wall.

Mounting the hanging elements and the device

1. Push the supplied M4 x 10 screws through the plastic hanging elements. The side with the smallest diameter on the plastic hanging elements is to be found on the outside.
2. Tighten the screws with the plastic hanging elements in the correct screw holes on the rear of the device.

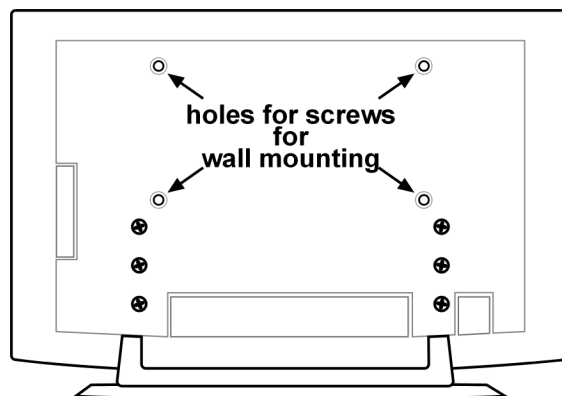
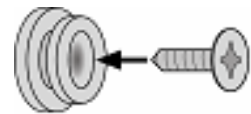

Remove base

The base of the device is fixed to the rear with six screws.

1. Undo the six screws with a cross-head screwdriver.
2. Lift up the device, away from the base.

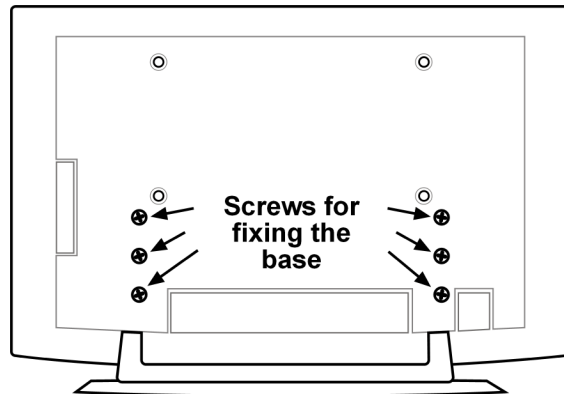

Fixing the steel rails to the wall

1. Select a location on the wall where there is sufficient distance between the LCD-TV and other objects (see section Point of use).
Bear in mind that the hanging elements on the rear of the device will fit into the narrow ends of the hanging openings in the steel rails.
2. Mark the eight drill holes in the wall with the supplied drill template.
3. Drill the eight holes for the raw plugs in the wall.
4. Insert the raw plugs.



ATTENTION!

The raw plugs must fit tightly! Do not hang the device on the wall if the raw plugs are not tightly fixed.

5. Attach the two steel rails each with four screws. The narrow sides of the hanging openings must face downwards.
6. Now you can hang the LCD-TV on the steel rails.

Code list for universal remote control

TV

ACME	0009	BLUE STAR	0120
ADA	0026	BONDSTEC	0129
ADC	0002 0007	BOOTS	0003
ADMIRAL	0019 0108 0002 0001 0047 0000	BPL	0120
ADYSON	0003	BRANDT	0127 0045 0022 0036 0126 0139 0046
AGAZI	0002	BRION VEGA	0051 0169 0000
AGB	0123	BRITANNIA	0003
AIKO	0003 0009 0004	BROKSONIC	0920
AIWA	0184 0248 0291	BRUNS0000	0007
AKAI	0011 0086 0009 0068 0004 0006 0008 0051 0061 0088 0169 0200 0133 0141 0069	BSR	0131 0026
AKIBA	0011	BTC	0011
AKURA	0169 0074 0002 0009 0011 0071	BUSH	0028 0027 0032 0009 0011 0019 0205 0039 0051 0068 0169 0107 0115 0131 0139 0167 0245 0248 0024 0132 0120 0062
ALBA	0028 0027 0009 0011 0003 0068 0083 0169 0047 0245 0248 0162 0062	CAPSONIC	0002
ALBIRAL	0037	CARREFOUR	0027
ALKOS	0164	CASCADE	0009
ALLORGAN	0157 0026	CATHAY	0051 0169
ALLSTAR	0051	CENTRUM	0168 0205
AMPLIVISION	0003	CENTURION	0051 0169
AMSTRAD	0011 0009 0068 0074 0002 0108 0071 0069 0030 0123 0013	CENTURY	0000
ANAM	0009 0065 0109	CGE	0129 0047 0131 0043
ANGLO	0009	CIMLINE	0009 0028
ANITECH	0009 0002 0043 0109	CITY	0009
ANSONIC	0009 0014	CLARIVOX	0169 0037
ARC EN CIEL	0126 0045 0139	CLATRONIC	0009 0011 0051 0002 0083 0003 0129 0030 0043
ARCAM	0003	COMBITECH	0248
ARISTONA	0169 0051	CONCORDE	0009
ARTHUR MARTIN	0158	CONDOR	0198 0051 0083 0003 0245
ASA	0017 0110 0016 0018 0000 0021	CONTEC	0003 0009 0027 0030 0029
ASBERG	0051 0043	CONTINENTAL EDISON	0022 0111 0036 0045 0126 0139 0046
ASTRA	0009	COSMEL	0009
ASUKA	0011 0002 0003	CROSLEY	0129 0131 0000 0043
ATLANTIC	0169 0003 0051 0157	CROWN	0009 0169 0083 0047 0051 0245 0121 0043
ATORI	0009	CS ELECTRONICS	0011 0129 0003
AUDIOSONIC	0009 0003 0169 0011 0051 0139 0157 0090 1062	CTC	0129
AUDIOTON	0003	CTC CLATRONIC	0014
AUSIND	0043	CYBERCOM	0177 0038 0171 0002 0009 0206 0205 0207 0208 0210 0169 0042 0044 0127 0047 0061 0063 0067 0068 0103 0107 0115 0154 0168 0185 0228 0209 0343 0924 0933 0248 0291
AUTOVOX	0003 0002 0101 0157 0000 0125 0043	CYBERMAXX	0177 0038 0171 0002 0009 0206 0200 0205 0207 0208 0210 0211 0169 0015 0042 0044 0047 0048 0049 0061 0063 0067 0068 0087 0103 0107 0115 0127 0154 0155 0168 0170 0185 0228 0229 0209 0218 1005 0894 0343 0924 0933 0248 0291
BAIRD	0111 0139 0245	CYBERTRON	0011
BANG & OLUFSON	0199 0000	CYTRON	0177 0038 0171 0002 0009 0206 0200 0205 0207 0208 0210 0211 0169 0015 0042 0044 0047 0048 0049 0061 0063 0067 0068 0087 0103 0107 0115 0127 0154 0155 0168 0170 0185 0228 0229 0209 0218 1005 0894 0343 0924 0933 0248 0291
BARCO	0112	DAEWOO	0094 0009 0191 0003 0051 0115 0245
BASIC LINE	0009 0011 0051 0245	DAINICHI	0011
BASTIDE	0003		
BAUR	0169 0118 0076 0141 0132		
BEKO	0042 0083 0034 1064 0007		
BEON	0169 0051		
BEST	0113		
BESTAR	0051 0245		
BINATONE	0003		
BLACK DIAMOND	0171		
BLACK PANTHER LINE	0245		
BLACK STAR	0129		
BLAUPUNKT	0117 0202 0135 0008 0022 0100		
BLUE SKY	0011		

KENDO	0019	0014	0028	0108	0245								0209	0218	1005	0894	0343	0924	0933					
KENNEDY	0131	0157											0248	0291										
KINGSLEY	0003												MICROSTAR	0177	0038	0171	0002	0009	0206	0200				
KNEISSEL	0174												0205	0207	0208	0210	0211	0169	0015					
KOLSTER	0051												0042	0044	0047	0048	0049	0061	0063					
KONKA	0047	0068	0229	0011									0067	0068	0087	0103	0107	0115	0127					
KORPEL	0051	0169											0154	0155	0168	0170	0185	0228	0229					
KORTING	0000												0209	0218	1005	0894	0343	0924	0933					
KOYODA	0009												0248	0291										
KTV	0003												MINERVA	0017	0101	0135								
KURO	0121												MINOKA	0051										
KYOTO	0037												MITSUBISHI	0000	0027	0030	0051	0054	0057	0060				
LENCO	0009	0245											0098	0101	0135	0205								
LENOIR	0003	0009											MIVAR	0055	0083	0003	0093	0123	0043					
LESA	0129												MOTION	0043										
LEYCO	0169	0002	0004	0051	0026								MT LOGIC	0090	1062									
LG	0084	0119	0129	0149	0019	0003	0051						MTC	0132										
	0088	0131	0169	0171	0009	0261	0093						MULTI SYSTEM	0169										
LIESENK	0169												MULTITECH	0003	0009	0014	0019	0169	0027	0045	0129	0131	0043	
LIFE	0002	0009	0061	0067	0068	0103	0107						MURPHY	0003	0133	0018								
	0111	0115	0154	0168	0169	0171	0177						NAD	0141										
	0205	0291											NAIKO	0099										
LIFETEC	0177	0038	0171	0002	0009	0206	0205						NAONIS	0019	0108									
	0207	0208	0210	0211	0169	0015	0042						NATIONAL	0064	0101									
	0044	0047	0048	0049	0061	0063	0067						NEC	0185	0027	0056								
	0068	0087	0103	0107	0115	0127	0154						NECKERMANN	0003	0169	0008	0019	0022	0051	0083	0118	0132	0000	
	0155	0168	0170	0185	0228	0229	0209						NEI	0051	0068	0169	0113							
	0218	1005	0894	0343	0924	0933	0248						NESCO	0129										
	0291												NEW WORLD	0011										
LOEWE	0097	0098	0051	0169	0000								NEWTECH	0009	0051									
LOGIK	0030												NICAMAGIC	0003										
LUMA	0019	0169	0141	0157									NIKKAI	0002	0003	0164	0004	0011	0051	0169				
LUMATRON	0002	0171	0019	0088	0051	0074	0169						NOBLIKO	0003	0014	0043								
	0107	0141	0157	0245									NOGAMATIC	0139										
LUX MAY	0051												NOKIA	0061	0143	0063	0141	0077	0133	0031	0021	0132	0142	
LUXOR	0141	0019	0047	0003	0077	0138	0093						NORDMENDE	0111	0127	0036	0045	0051	0126	0139	0046	0000	0021	
	0132												0024											
M+P	0133												NORDVISION	0169										
MAGNADYNE	0014	0129	0131	0169	0000	0123							OCEANIC	0141	1011	0142	0021	1089						
MAGNAFON	0003	0014	0043	0123									OKANO	0083										
MAGNUM	0002	0111	0009	0169	0171	0061	0067						ONCEAS	0003										
	0068	0103	0107	0115	0154	0168	0177						ONWA	0069										
	0200	0291											ORBIT	0051										
MANDOR	0002												ORION	0099	0147	0159	0009	0212	0028	0051	0154	0169	0171	
MANESTH	0002	0169	0003	0028	0051								0920	0248	0283	0123	0142	0030	0013	0062	0075	0026		
MARANTZ	0051	0169											ORMOND	0205										
MARELLI	0000												OSAKI	0011	0002	0003	0004	0074						
MARK	0051	0169											OSO	0011										
MATSUI	0173	0099	0091	0027	0180	0028	0147						OSUME	0004	0029									
	0003	0004	0009	0019	0051	0068	0101						OTTO VERSAND	0003	0169	0008	0001	0027	0051	0076	0111	0118		
	0164	0169	0248	0113	0123	0013	0062						0131	0139	0141	0120	0121	0132						
	0026	0030											PACKARD BELL	0204	0203									
MATSUSHITA	0065												PAEL	0003										
MCMICHAEL	0041												PALLADIUM	0003	0083	0012								
MEDIATOR	0051	0169											PANAMA	0002	0003	0009								
MEDION	0177	0038	0171	0002	0009	0206	1015						PANASONIC	0065	0067	0064	0197	0072	0186	0101	0141	0021	0151	
	0200	0205	0207	0208	0210	0211	0169						0142	0124	0152									
	0015	0042	0044	0047	0048	0049	0061						PATHE CINEMA	0003	0083	0131	0037							
	0063	0067	0068	0087	0103	0107	0115						PATHE MARCONI	0022	0045	0126	0139	0037	0046					
	0127	0148	0154	0155	0168	0170	0185						PAUSA	0009										
	0228	0229	0209	0218	1005	0894	0343						PERDIO	0004										
	0924	0933	0248	0291	1014								PHILCO	0047	0129	0131	0000	0043						
MELECTRONIC	0009	0016	0169	0018	0003	0036	0051						PHILHARMONIC	0003										
	0068	0110	0115	0139	0021	0109							PHILIPS	0200	0088	0217	0202	0020	0169	0003	0041	0181	0339	
MEMOREX	0009	0920											0051	0083	0111	0115	0131	0141	0154	0000	0043	0089		
MEMPHIS	0004	0009											PHOCUS	0042	0095	1064								
METZ	0201	0135	0151	0152	0000	0075							PHOENIX	0051	0169	0000								
MICROMAXX	0177	0038	0171	0002	0009	0206	0200						PHONOLA	0051	0169	0000								
	0205	0207	0208	0210	0211	0169	0015																	
	0042	0044	0047	0048	0049	0061	0063																	
	0067	0068	0087	0103	0107	0115	0127																	
	0154	0155	0168	0170	0185	0228	0229																	

PIONEER	0010 0145 0036 0051 0139 0169 0021	SIAREM	0014 0131 0000 0123
PLANTRON	0002 0051	SICATEL	0037
POPPY	0009	SIEMENS	0008 0022 0200 0135 0029
PORTLAND	0245	SIERRA	0051
PRANDONI-PRINCE	0019 0141 0123	SIESTA	0160
PRECISION	0003	SILVER	0027
PRIMA	0009 0021	SINGER	0014 0131 0129 0228 0000
PRINZ	0047	SINUDYNE	0014 0131 0169 0028 0000 0075 0013 0026
PRO2	0177 0038 0171 0002 0009 0206 0200 0205 0207 0208 0210 0211 0169 0015 0042 0044 0047 0048 0049 0061 0063 0067 0068 0087 0103 0107 0115 0127 0154 0155 0168 0170 0185 0228 0229 0209 0218 1005 0894 0343 0924 0933 0248 0291	SKANTIC	0138 0021
PROFEX	0009 0141 0043	SKYMASTER	0016
PROFILO	0171	SKYWORTH	0228
PROFI-TRONIC	0051	SOLAVOX	0092 0021
PROLINE	0004 0051 0062	SONITRON	0006 0031
PROSONIC	0161 0169 0003 0015 0042 0088 0107 0200 0068 0245	SONOKO	0009 0002 0169 0003 0051 0245
PROTECH	0002 0003 0009 0169 0014 0051 0129 0131 0132 0113	SONOLOR	0006 0021
PROVISION	0169 0171	SONTEC	0051 0169 0160
PYE	0169 0051 0068	SONY	0165 0130 0183 0106 0076 0027 0127 0009 0004 0182 0029 0030
PYMI	0009	SOUND & VISION	0011 0014
QUASAR	0129	SOUNDWAVE	0051 0169
QUELLE	0169 0205 0002 0003 0016 0022 0051 0129 0131 0135 0141 0017 0018 0026 0030	STANDARD	0003 0009 0011 0051 0245
QUESTA	0027	STARLIGHT	0169
RADIOLA	0051 0169	STENWAY	0120
RADIOMARELLI	0129 0000 0123	STERN	0019 0157 0021
RADIONETTE	0016 0018	SUNKAI	0009 0026 0062
RADIOTONE	0051 0007	SUNWOOD	0009 0051
RANK	0017 0027	SUPERLA	0003
RBM	0017	SUPERTECH	0118
RCA	0031	SUPRA	0009
REDIFFUSION	0141	SUSUMU	0011
REVOX	0051 0169	SUTRON	0009
REX	0019 0002 0108 0157 0021	SYDNEY	0003
RFT	0000 0007	SYSLINE	0169
R-LINE	0051 0169	TANDBERG	0157 0026
ROADSTAR	0002 0009 0011 0245	TANDY	0001 0003 0004 0011 0133 0021
ROBOTRON	0000	TASHIKO	0003 0019 0027 0041 0056 0128
RTF	0000	TATUNG	0051 0003 0004 0169 0123
SABA	0127 0111 0126 0036 0045 0139 0141 0245 0142 0046 0000 0123 0021	TCM	0177 0038 0171 0002 0009 0206 1015 1017 1119 0205 0207 0208 0210 0169 0042 0044 0047 0061 0063 0067 0068 0103 0107 0115 0127 0154 0168 0185 0211 0228 0209 1005 0343 0924 0933 0248 0291
SACCS	0037	TEC	0003 0009 0129 0131 0133
SAISHO	0028 0002 0003 0009 0248 0030 0123 0013	TECHNICS	0065
SALORA	0019 0031 0047 0061 0107 0108 0118 0131 0138 0141 0093 0121 0128 0132 0021	TECHNISAT	0154
SAMBERS	0014 0169 0043 0123	TELEAVIA	0022 0036 0045 0111 0126 0139
SAMSUNG	0090 0104 0009 0051 0172 0083 0002 0160 0003 0004 0312 0030 0105 0093	TELEFUNKEN	0166 0111 0127 0190 0022 0035 0163 0101 0102 0036 0050 0051 0052 0078 0108 0126 0139 0079
SANDRA	0003 0009	TELETECH	0169 0009 0088 0129 0113
SANSUI	0051 0920	TELETON	0003 0157 0118 0132
SANYO	0004 0006 0031 0003 0027 0016 0018 0083 0127 0160 0131 0029 0030 0040 0043	TENSAI	0011 0168 0018 0051 0026
SAVILLE	0248	TESMET	0051
SBR	0041 0169	TEVION	0177 0038 0171 0002 0009 0206 1015 0200 0205 0207 0208 0210 0211 0169 0015 0042 0044 0047 0048 0049 0061 0063 0067 0068 0087 0103 0107 0115 0127 0154 0155 0168 0170 0185 0228 0229 0209 0214 0218 1005 1016 0894 0343 0924 0933 0248 0291 1064
SCHAUB LORENZ	0141 0021 0142	TEXET	0003
SCHNEIDER	0177 0003 0169 0011 0051 0068 0131 0139 0160 0245 0264 0071 0125	THOMSON	0166 0127 0111 0003 0022 0036 0045 0176 0101 0102 0050 0051 0052 0126 0139 0163 0185 0245 0046
SCHWAIGER	1024	THORN	0004 0018 0169 0035 0054 0111 0127 0141 0164 0037
SEG	0171 0002 0205 0003 0169 0009 0014 0027 0088 0129 0131 0043	TOKAI	0004 0051
SEI-SINUDYNE	0014 0013 0021 0026 0075 0123 0000	TOKYO	0003
SELECO	0019 0027 0131 0108 0157 0021	TOMASHI	0120
SENCORA	0009	TOSHIBA	0117 0164 0189 0027 0146 0017 0920 0082
SENTRA	0164	TOWADA	0131 0021
SHARP	0001 0059 0005 0027 0187 0188 0029	TRIUMPH	0013 0123 0082
SHORAI	0026	UHER	0051 0157 0021 0043

ULTRAVOX 0003 0014 0129 0131 0133 0000
 UNITED 0088 0169
 UNITED QUICK STAR 0245
 UNIVERSUM 0102 0002 0016 0018 0051 0061 0169 0083 0110 0122
 0129 0131 0143
 UNIVOX 0037
 VESTEL 0019 0051 0169 0171 0083 0092 0103 0107 0118 0129
 0131 0138 0168 0195 0205 0021 1014
 VEXA 0169 0009
 VICTOR 0027 0051 0065
 VIDEO SYSTEM 0051
 VIDEOLIQUE 0011 0003
 VIDEON 0248
 VIDEOSAT 0129
 VISIOLA 0003
 VISION 0051
 VISOREX 0096
 VISTAR 0133
 VORTEC 0051 0169
 VOXSON 0019 0051 0108 0021 0043 0000
 WALTHAM 0003 0133 0138 0037
 WATSON 0051 0169
 WATT RADIO 0003 0014 0131 0037
 WEGA 0000 0027
 WELTBlick 0051 0169
 WESTON 0131
 WHARFEDALE 0099
 WHITE WESTINGHOUSE 0169 0003 0014 0043
 YAKUMO 1012
 YOKO 0009 0011 0051 0169 0002 0003
 YORX 0011
 ZANUSSI 0019 0157 0108

CYBERCOM 0233 0311 0262 0269 0319 0256 0248 0291 0338 0905
 0906
 CYBERMAXX 0233 0311 0262 0269 0319 0256 0248 0291 0338 0905
 0906
 CYTRON 0233 0311 0262 0269 0319 0256 0248 0291 0338 0905
 0906
 DAEWOO 0274 0250 0265 0319 0245 0971
 DANSAI 0275
 DANTAX 0233
 DAYTRON 0245
 DE GRAAF 0266 0257
 DECCA 0257 0231 0293
 DUAL 0233 0256 0257 0311 0262 0319 0293 0248 0291
 0338 0905 0906
 DUMONT 0266 0257 0231 0258
 ELTA 0275
 EMERSON 0231 0256 0301 0339
 ESC 0245
 ETZUKO 0275
 FERGUSON 0294 0259 0271 0278 0293 0281 0305
 FIDELITY 0311 0231
 FINLANDIA 0266 0257 0258
 FINLUX 0266 0298 0257 0231 0258 0293 0237
 FIRSTLINE 0266 0275 0233 0265 0298 0256
 FISHER 0258 0279
 FLINT 0233
 FORMENTI-PHEONIX 0257
 FRONTTECH 0250
 FUJITSU 0231
 FUNAI 0231 0339
 GALAXY 0231
 GBC 0275 0250
 GEC 0257
 GELOSO 0275
 GENERAL 0250
 GENERAL TECHNIC 0262 0233 0311 0248
 GOLDHAND 0275
 GOLDSTAR 0231 0256
 GOODMAN'S 0275 0250 0259 0256 0231 0245 0283 0282
 GO-VIDEO 0338 0367 0971
 GRAETZ 0258 0293
 GRANADA 0257 0266 0240 0258 0271
 GRANDIN 0275 0250 0256 0231 0245
 GRUNDIG 0273 0270 0263 0235 0243 0257 0260 0272 0275 0286
 0287 0290 0315 0271 0288
 HAAZ 0233
 HANSEATIC 0257 0256
 HCM 0275 0288
 HINARI 0275 0233 0248 0288 0301
 HISAWA 0233
 HITACHI 0266 0257 0268 0231 0293 0387
 HYPSON 0233 0275
 IMPEGO 0250
 IMPERIAL 0231
 INNO HIT 0250 0257 0275 0245
 INNOVATION 0233 0311 0262 0248 0291
 INTERBUY 0256
 INTERFUNK 0257 0258
 INTERVISION 0231
 IRRADIO 0275 0256
 ITT 0237 0293 0258 0292
 ITV 0256 0245
 JVC 0294 0295 0293 0400
 KAISUI 0275
 KARCHER 0257
 KENDO 0233 0250 0265 0300 0245 0236 0237

VCR

AIWA 0230 0233 0256 0293 0231 0248 0291
 AKAI 0300 0329 0307 0237 0236 0238 0239 0293
 AKIBA 0275
 AKURA 0275 0244 0293
 ALBA 0275 0233 0250 0245 0248 0246 0247
 ALLORGAN 0311
 AMBASSADOR 0250
 AMSTRAD 0253 0231 0254
 ANITECH 0275
 APEX 0949
 ASA 0257 0256
 ASUKA 0275 0257 0231 0256
 BAIRD 0259 0231 0258 0245 0237 0293
 BASIC LINE 0275 0233 0250 0245
 BAUR 0263 0257
 BESTAR 0250 0245
 BLACK PANTHER LINE 0245
 BLAUPUNKT 0263 0257 0262 0260 0309 0325 0271
 BONDSTEC 0250
 BRANDT 0303 0305
 BROKSONIC 0277 0967
 BUSH 0275 0233 0245 0248 0246 0247 0288
 CATRON 0250
 CGE 0231 0293
 CIMLINE 0275 0233
 CINEVISION 0256
 CLATRONIC 0250
 COMBITECH 0248
 CONDOR 0250 0245
 CROWN 0275 0250 0245

KENWOOD	0293	PROSONIC	0233 0245
KORPEL	0275	PYE	0257
LENCO	0245	QUARTZ	0258
LEYCO	0275	QUELLE	0257 0263 0258 0231 0271 0301
LG	0231 0256 0261 0907	RADIOLA	0257
LIFE	0291 0256	REX	0293
LIFETEC	0233 0311 0262 0269 0319 0256 0248 0291 0338 0905 0906	RFT	0250 0257
LOEWE	0267 0325 0262 0257 0256 0271	ROADSTAR	0275 0256 0245
LOGIK	0275	SABA	0324 0245 0281 0293 0303 0305
LUMATRON	0274 0245	SAISHO	0275 0233 0248 0301
LUXOR	0298 0258 0237 0281	SALORA	0298 0258 0237 0292
MAGNASONIC	0258	SAMSUNG	0311 0312 0338 0963
MAGNAVOX	0914 0285	SAMURAI	0250
MAGNUM	0291	SANSUI	0294 0244 0293 0920
MANESTH	0275 0265	SANYO	0284 0258 0279
MARANTZ	0257 0271 0281 0299	SAVILLE	0248
MATSUI	0233 0256 0248 0301	SBR	0257
MEDIATOR	0257	SCHAUB LORENZ	0258 0237 0231 0293
MEDION	0233 0311 0262 0269 0319 0256 0248 0291 0338 0905 0906	SCHNEIDER	0275 0233 0265 0250 0257 0256 0231 0264 0245
MELECTRONIC	0231	SEG	0275
MEMOREX	0240 0256 0231 0258 0279	SEI-SINUDYNE	0257
MEMPHIS	0275	SELECO	0293
METZ	0262 0263 0267 0273 0325 0271	SENTRA	0250
MICROMAXX	0233 0311 0262 0269 0319 0256 0248 0291 0338 0905 0906	SENTRON	0275
MICROSTAR	0233 0311 0262 0269 0319 0256 0248 0291 0338 0905 0906	SHARP	0240 0241 0328 0281
MIGROS	0231	SHINTOM	0275 0258
MINERVA	0263 0271	SHIVAKI	0256
MITSUBISHI	0298 0257 0289 0294 0231	SIEMENS	0263 0256 0258 0271
MULTITECH	0275 0250 0257 0231	SILVA	0256
MURPHY	0231	SINUDYNE	0257
NATIONAL	0262 0260	SOLAVOX	0250
NEC	0294 0293 0299	SONOKO	0245
NECKERMANN	0257 0293 0301	SONOLOR	0240
NEI	0257	SONTEC	0256
NESCO	0275	SONY	0232 0308 0309 0310 0313 0249 0251 0255 0402
NIKKAI	0250 0302	STANDARD	0245
NOKIA	0240 0300 0307 0258 0237 0292 0293	STRONG	0244
NORDMENDE	0294 0293 0303 0305	SUNKAI	0233
OCEANIC	0240 0231 0293	SUNSTAR	0231
OKANO	0233 0300	SUNTRONIC	0231
ORION	0234 0233 0304 0248 0283 0301 0246	SUNWOOD	0275
ORSON	0231	SYLVANIA	0339 0231
OSAKI	0275 0231 0256	TAISHO	0233
OTTO VERSAND	0257	TANDBERG	0263
PALLADIUM	0275 0300 0256 0271 0293	TASHIKO	0240 0231
PANASONIC	0262 0267 0260 0314 0321 0325 0970	TATUNG	0257 0231 0293
PATHE CINEMA	0301	TCM	0233 0256 0311 0262 0269 0319 0375 0248 0291 0338 0905 0906
PATHE MARCONI	0293	TEC	0250
PENTAX	0266	TECHNICS	0262 0260
PERDIO	0231	TELEAVIA	0293
PHILCO	0299	TELEFUNKEN	0306 0294 0324 0295 0323 0280 0293 0303 0305
PHILIPS	0235 0257 0290 0315 0327 0286 0285 0242 0271 0293 0969	TENOSAL	0275
PHONOLA	0257	TENSAI	0275 0231 0256
PIONEER	0294 0257 1084	TEVION	0233 0311 0262 0269 0319 0256 0248 0291 0338 0905 0906
POLAROID	0949	THOMSON	0294 0324 0295 0323 0326 0245 0242 0293 0305
PORTLAND	0250 0245	THORN	0258 0293 0301
PRINZ	0231	TIVO	0242
PRO2	0233 0311 0262 0269 0319 0256 0248 0291 0338 0905 0906	TOKAI	0275 0256
PROFEX	0275	TONSAI	0275
PROLINE	0231 0288	TOSHIBA	0320 0257 0265 0298 0319 0362 0293
		TOWADA	0275
		TOWIKA	0275
		TRIUMPH	0301

TVA 0250
 UHER 0256
 UNITED QUICK STAR 0245
 UNIVERSUM 0290 0235 0263 0257 0315 0256 0231 0237 0239 0253
 0271
 VICTOR 0294 0295
 VIDEON 0233 0262 0311 0248
 WELTBlick 0256
 YAMISHI 0275
 YOKAN 0275
 YOKO 0275 0250 0256
 ZENITH 0256

Cable

AUSTAR 0494
 BMB 0636
 BT 0554
 CABLE AND WIRELESS 0606
 CABLECRYPT 0474
 CABLETIME 0448 0449 0450
 CANAL PLUS 0474
 CLYDE CABLEVISION 0452
 COMCRYPT 0474
 CRYPTOVISION 0458
 EURODEC 0603
 FILMNET 0474
 FILMNET CABLECRYPT 0474
 FILMNET COMCRYPT 0474
 FOXTEL 0602
 GEC 0452
 GI 0494 0554
 IMPULSE 0554
 JERROLD 0554 0494
 KABELVISION 0554
 LYONNAISE 1183
 MARMITEK 0636
 MELITA 0554
 MNET 0602 0474
 MOTOROLA 0494
 MOVIE TIME 0551
 MULTICHOICE 0474 0602
 NOOS 1143 1158 1175 1183
 NTL 0606
 NUMERICABLE 0603
 OPTUS 0494
 PACE 0606
 PHILIPS 0487
 PIONEER 0518 0521
 PVP 0554
 SAMSUNG 1148
 SCIENTIFIC ATLANTA 0524 0525
 STS 0551
 TELE+1 0474
 TELEPIU 0474
 TELEWEST 0606 0554
 UNITED 0554
 UPC 1143 1175 1184
 VISIOSAT 0487

SAT

AKAI 0552
 ALBA 0508 0562 0405 0407
 ALDES 0408 0409

ALLSAT 0462 0410 0552
 ALLSONIC 0408 0428
 AMPERE 0422
 AMSTRAD 0584 0555 0541 0415 0416 0417 0419
 ANKARO 0408 0428 0424
 ANTTTRON 0405 0407
 APOLLO 0405
 ARCON 0415 0422 1155 1144 1153 0424 0463
 ARMSTRONG 0419
 ASAT 0552
 AST 0435
 ASTON 0594 0406
 ASTRA 0429 0419 0431 0432 0502
 ASTRO 0428 0439 0569 0407 0409
 AUDIOTON 0462 0407
 AURORA 0602
 AUSTAR 0602 0643 0642
 AXIS 0428 0415 0432 0456
 BARCOM 0424
 BEST 0428 0424
 BLAUPUNKT 0439
 BOCA 0419 0502
 BRAIN WAVE 0444 1131
 BRANDT 0565 0566 0567 0574
 BSKYB 0584 0555
 BT SATELLITE 0574
 BUSH 0508 0562 0410
 CANAL SATELLITE 0569 0599
 CANAL+ 0569 0599
 CHAPARRAL 0507
 CHESS 0547 0586
 CITYCOM 0508 0640 0459
 CLATRONIC 0444
 CLEMENS KAMPHUS 0491
 CNT 0409
 COLUMBUS 0477
 COMAG 0471
 COMMLINK 0408
 COMTECH 0456
 CONDOR 0428 0640
 CONNEXIONS 0438 0454
 CONRAD 0640 1156
 CONTEC 0456 0459
 COSAT 0462
 CROWN 0419
 CYBERCOM 0412 0413 0423 0428 0442 0493 0504 0511 0514 0546
 0566 0583 0586 0587 0618 0619
 CYBERMAXX 0412 0413 0423 0428 0442 0466 0478 0484 0493 0504
 0511 0514 0535 0546 0566 0583 0586 0587 0618 0619
 0644 0650 0652 0653 1130 1138 1137
 CYTRON 0412 0413 0423 0428 0442 0466 0478 0484 0493 0504
 0511 0514 0535 0546 0566 0583 0586 0587 0618 0619
 0644 0650 0652 0653 1130 1138 1137
 DAERYUNG 0438
 DANSAT 0410
 D-BOX 0564 0604
 DECCA 0460
 DEW 0456
 DIAMOND 0461
 DIGIALITY 0640
 DISKXPRESS 0424 0454
 DITRISTRAD 0462
 DMT 0412
 DNT 0438 0552
 DONG WOO 0501
 DRAKE 0557 0463

DREAMBOX	0658	ITT/NOKIA	0429 0508 0548 0454 0487 0537
DStv	0602	JOHANSSON	0444
DUAL	0412 0413 0423 0428 0493 0504 0511 0566 0583 0586 0587 0618 0514	JSR	0462
ECHOSTAR	0640 0581 0586 0425 0481 0578 0579 0580 0657 0659 0464 0465 0467	JVC	0483
EINHELL	0408 0417 0405 0419	KATHREIN	0549 0617 0631 0607 0635 0439 0459 0496 0498 0499 0507 0552
ELEKTA	0409	KOSMOS	0489 0491 0496
ELTA	0428 0462 0405 0552	KR	0407
EMANON	0405	KREISELMEYER	0439
EMME ESSE	0428 0508 0491	KYOSTAR	0405
EMTECH	1162	LASAT	0428 0565 0566 0567 1156 1157 0409 0500 0501 0502
EP SAT	0508 0491	LENCO	0405 0489 0503
E-TEK	1140	LENG	0444
EUROPHON	0640	LENNOX	0462
EUROSAT	0419	LENSON	0479
EUROSKY	0428 0640 1156 0419	LG	0489
EUROSPACE	0468	LIFE	0583
EUROSTAR	0438 0419	LIFESAT	0412 0413 0423 0428 0442 0493 0504 0511 0514 0546 0566 0583 0586 0587 0618 0619
EVA	0588 0589	LIFETEC	0412 0413 0423 0428 0442 0466 0478 0484 0493 0504 0511 0514 0535 0546 0566 0583 0586 0587 0618 0619 0644 0650 0652 0653 1130 1138 1137
EXATOR	0405 0407	LION	0468
FERGUSON	0508 0472 0603 0410 0473	LORENTZEN	1156
FIDELITY	0415 0417	LORRAINE	0489
FINLANDIA	0508	LUPUS	0428
FINLUX	0508 0429 0608 0475 0480 0487	LUXOR	0417 0429 0548 0537
FINNSAT	0603 0456	MACAB	0603
FORCE	0577 0553 0535	MANHATTAN	0462 0508 0557 0633 0421 0409
FORTEC STAR	0470	MARANTZ	0552
FOXTEL	0602 0643 0584	MARMITEK	0641
FRACARRO	0562	MARMITEK OCTOPUS	0655
FRANCE SATELLITE/TV	0477	MASCOM	0409
FREECOM	0405 0489	MASPRO	0483 0508 0507 0558
FTE	0422 0496	MATSUI	0483 0574
FUBA	0548 0439 0428 0438 0405 0424 0431 0477 0480 0552	MB	0504
FUNTACH	0587	MBOX	0442
GALAXIS	0428 0408 0462 0478 0484 0535 0582 0583 0602 0619 0432 0456	MEDIABOX	0569
GALAXY	0424	MEDIAMARKT	0419
GLOBECAST	1141	MEDIASAT	0569 0432
GLOBO	1156	MEDION	0412 0413 0423 0428 0442 0466 0478 0484 0493 0504 0511 0514 0535 0546 0566 0583 0586 0587 0618 0619 0644 0650 0652 0653 1130 1139 1138 1137 1181
GMI	0419	MEGA	0552
GOLDSTAR	0489	METRONIC	0408 0575 0612 0613 0614 0615 0632 0409 0424 0405 0407
GOODING	0483	METZ	0439
GOODMANS	0508	MICRO TECHNOLOGY	0468
GRANADA	0429	MICROMAXX	0412 0413 0423 0428 0442 0466 0478 0484 0493 0504 0511 0514 0535 0546 0566 0583 0586 0587 0618 0619 0644 0650 0652 0653 1130 1139 1138 1137
GROTHUSEN	0405 0489	MICROSTAR	0412 0413 0423 0428 0442 0466 0478 0484 0493 0504 0511 0514 0535 0546 0566 0583 0586 0587 0618 0619 0644 0650 0652 0653 1130 1138 1137
GRUNDIG	0439 0436 0483 0495 0508 0544 0469 0602 0584 0407 0550	MINERVA	0483 0439
HANDAN	0547 1167	MITSUBISHI	0508 0439 0574
HANSEATIC	0504	MITSUMI	0502
HANTOR	0444 0405 0501	MORETV	0644 0423 1130 1181
HANURI	0409	MORGAN SYDNEY	0611
HELIOCOM	0422	MORGANS	0611 0419 0502 0552
HIRSCHMANN	0439 0522 0547 0548 1156 1165 1174 0487 0488 0491 0558	MULTICHOICE	0602
HISAWA	0444	MULTISTAR	0496 0501
HITACHI	0508 0537	MULTITEC	0586 0587
HOUSTON	0462	MURATTO	0437 0489
HUMAX	0485 0517 0582	NAVEX	0444
HUTH	0408 0411 0444 0462 0419 0491	NEC	0509 0510
HYUNDAI	0486	NEUHAUS	0462 0479 0432
IMPERIAL	0562	NEXTWAVE	0414 0585
INNOVATION	0428 0493 0504 0511 0583 0586 0587 0618		
INTERTRONIC	0419		
INTERVISION	0462		
IRDETO	0602		

NIKKO	0419	SAT	0415 0435 0437
NOKIA	0530 0564 0425 0429 0508 0548 0563 0531 0454 0487	SATCOM	0640 0504 0523
NOMEX	0622	SATEC	0508
NORDMENDE	0549 0472 0508 0603 0405 0409	SATPARTNER	0444 0405 0407 0409 0489 0491
NOVIS	0444	SCHNEIDER	0428 0455 0511 0583 0586 0587 0618
OAK	0424	SCHWAIGER	0411 0412 0413 0427 0430 0433 0440 0504 0508 0516 0566 0573 0575 0576 0577 0582 0514 0583 0585 0587 0598 0616 0630 0631 0633 0635 1132 1133 1147 1152 1173 0459 0498
OCEANIC	0461 0468	SEEMANN	0438 0419 0432
OCTAGON	0405 0407 0456	SEG	0428 0444 0504 0541 0631 0634 0405
OKANO	0419 0491 0496	SELECO	0462
OPTEX	0462 0459 0656	SIEMENS	0439 1157
OPTUS	0602	SILVA	0489
ORBIT	0435	SKARDIN	0432 0586 0546 1160
ORBITECH	0405	SKY	0584 1151
ORIGO	0468	SKY DIGITAL	0584 0555
OSAT	0407	SKY+	0555
OTTO VERSAND	0439	SKYMASTER	0408 0504 0506 0546 0547 0586 0587 0588 0589 0590 0591 0592 0621 1140 1138 1159 1161 1160 1162 1167
PACE	0584 0555 0439 0559 0527 0508 0410 0617	SKYMAX	0552
PACIFIC	0461	SKYPEX	1156
PALCOM	0479 0431 0477	SKYVISION	0462
PALLADIUM	0483 0419	SM ELECTRONIC	0408 0412 0504 0506 0546 0547 0586 0587 0588 0589 0591 0621 1140 1138 0592 1159 1161 1160 1162 1167
PALTEC	0431	SONY	0584 0569 0418 0446
PANASONIC	0584 0508 0542	SR	0472 0419 0502
PANDA	0508 0410	STAR TRAK	0405
PANSAT	0490	STARLAND	0586
PANTECH	0591	STARRING	0444
PBI	1138	STRONG	0562 0428 0602 0545 0454 0489 0405 0407
PHILIPS	0552 0436 0483 0493 0495 0508 0543 0434 0569 0574 0605 0618 0455 0561 0550 0456 0515	SUMIDA	0419
PHOENIX	0456	SUNSTAR	0527 0419 0502
PHONOTREND	0408 0462 0491 0652	TANDBERG	0603
PINNACLE	0654	TANDY	0407
PIONEER	0569	TANTEC	0508 0479 0477
POLSAT	0603	TATUNG	0460
POLYTRON	0459	TCM	0412 0413 0423 0428 0442 0493 0504 0511 0514 0546 0566 0583 0586 0587 0618 0619
PREDKI	0444	TECHNIHALL	0416
PREMIER	0569	TECHNISAT	0438 0479 0569 0623 0528 0529
PREMIERE	0564 0462 0569 0542 0442 0604	TECHNOMATE	0441 1142
PREMIUM X	1134	TECO	0419 0502
PRIESNER	0445 0419	TELASAT	0640
PRO2	0412 0413 0423 0428 0442 0466 0478 0484 0493 0504 0511 0514 0535 0546 0566 0583 0586 0587 0618 0619 0644 0650 0652 0653 1130 1138 1137	TELEFUNKEN	0560 0508 0565 0566 0567 0574 0405
PROFI	0503	TELEKA	0438 0640 0407 0419
PROMAX	0508	TELEMASTER	0409
PROSAT	0408 0562	TELEMAX	0500
PROTEK	0461	TELESAT	0504
PROVISION	0409	TELESTAR	0479 0569
QUADRAL	0408 0428	TELEVES	0508 0610 0611
QUELLE	0439 0417	TELEWIRE	0462
QUIERO	0603	TEVION	0412 0413 0423 0428 0442 0466 0478 0484 0493 0504 0511 0514 0535 0546 0566 0583 0586 0587 0618 0619 0644 0650 0652 0653 1130 1140 1138 1137
RADIOLA	0552	THOMSON	0472 0601 0570 0574 0492 0508 0560 0568 0569 0603 0427 1156
RADIX	0630 0438 0632	THORENS	0461
RAINBOW	0407	THORN	0508 0410 0473
REDIFFUSION	0510	TIOKO	0459
REDPOINT	0432	TONBURY	0445 1159
REDSTAR	0428	TONNA	0508 0462
RFT	0408 0552	TOPFIELD	0497 0505 0506
RUEFACH	0503	TPS	0570
SAB	1137 1144 1145 1146 1147	TPS PLATINUM	1178
SABA	0472 0508 0543 0556 0562 0565 0571 0572 0573 0574 0575 0409 0468	TRIAD	0435 0437 0533 0489
SABRE	0508	TRIASAT	0480
SAGEM	0570 0604 0599 0603 0648		
SAKURA	0456		
SALORA	0429 0527 0509 0520		
SAMSUNG	0426 0405		

TRIAx	0439 0479 0565 0609 0619
TWINNER	0610 0611
UNIDEN	0534
UNISAT	0419 0456
UNITOR	0444 0424
UNIVERSUM	0439 0483 1156 0475 0487
VARIOSAT	0439
VECTOR	0468
VENTANA	0552
VIA DIGITAL	0568
VIA SAT	0568
VISIOSAT	0594 0444 0462 0586 0593 0595 0596 0597
VIVANCO	0536 0624
VORTEC	0405
V-TECH	0437 0435 0515 0537
WEVASAT	0508
WEWA	0508
WINERSAT	0444
WISI	0435 0437 0438 0439 0508 0533 0538 0539 0540 0597 0625 0626 0627 0628 0629
WITTENBERG	0415
WOORISAT	0409
WYSI	1156
ZEHNDER	0428 0437 0635 0541 0631 0632 0409 0424 0496 0498
ZODIAC	0407

Laser Disc

DENON	0252 0318
GRUNDIG	0318
mitsUBISHI	0318
NAD	0318
PIONEER	0318
TELEFUNKEN	0318
THORN	0322

DVD

ACCOUSTIC SOLUTIONS	0383 0350
AEG	0894 0333
AFREEY	0386
AIRIS	0357
AIWA	0383 0377
AKAI	0369 0333 0382 0350 0894
AKASHI	0346
ALBA	0384 0350 0381 0357 0370 0351
ALL-TEL	0333
AMES	0383
AMSTRAD	0350
AMW	1053 1054
ANABA	0961
ANSONIC	0356
APEX	0921 0384 0357 0911 0390 0913 1083 0949
ARENA	0923
ASPIRE	0952
A-TREND	0347
AUDIOSONIC	0382 1062
AUDIOVOX	0942
AXION	0942
B & K	0978
BAIER	0349
BAZE	0357
BEKO	1064
BLACK DIAMOND	0350
BLAUPUNKT	0384

BLUE NOVA INTERNATIONAL	1051
BLUE SKY	0373 0357 0350
BOMAN	0894 0351
BRANDT	0373 0360 0362
BROKSONIC	0920 0967
BUSH	0384 0382 0350 0381 0356
CAMBRIDGE	0376
CELESTIAL	0357
CENTREX	0357
CENTRIOS	0932 0951 0954 0955
CENTRON	0932
CENTRUM	0346 0926 0928 0350 0927
CINETEC	0350
CINEVISION	0375
CLASSIC	0383
CLATRONIC	0357 0894
CMI	0923
COBY	0332 0916 0946 0947 0357 1051 0948
CONTEL	0894
CRITERION	0344
CROWN	0373 0382
C-TECH	0341
CURTIS	0950 0948
CYBERCOM	0356 0930 0932 0330 0335 0339 0340 0341 0342 0345 0352 0358 0371 0923 0375 0343 0924 0933 0338 0334 0344 0664 0372 0373
CYBERHOME	0347 0912 0985 1075
CYBERLINK	1101
CYBERMAXX	0356 0930 0373 0932 0330 0335 0339 0340 0341 0342 0345 0352 0358 0371 0895 0896 0897 0898 0899 0900 0901 0902 0903 0904 0923 0893 0959 1069 1070 1071 1067 1066 1068 1117 1118 0905 0343 0924 0933 0375 0906 0338 0372 0334 0344 0664 0894
CYTRON	0356 0930 0373 0932 0330 0335 0339 0340 0341 0342 0345 0352 0358 0371 0380 0895 0896 0897 0898 0899 0900 0901 0902 0903 0904 0923 0893 0959 1069 1070 1071 1067 1066 1068 1117 1118 0905 0343 0924 0933 0375 0906 0338 0372 0334 0344 0664 0894
DAEWOO	0353 0354 0965 0355 0347 0380 0925 0971
DANSAI	0351
DAYTRON	0925
DCE	0356
DENON	0364 0389
DENVER	0381 1051 0894
DENZEL	0392
DESAY	0958
DIAMOND	0373 0341
DIGIFRAME	0930
DIGIHOME	0350
DIGITOR	0382
DIGITREX	0357
DIGITRON	0386
DIGIX	0962
DIK	0356
DISNEY	0339 0902
DiViDo	0380
DIVX	0375 0932
DK DIGITAL	0356
DMTECH	0351 0333
DRAGON SYSTEMS	0356
DUAL	0350 0356 0984 0383 0956 0373 0330 0335 0337 0340 0392 0341 0342 0345 0352 0358 0371 0923 0351 0333 0343 0338 0372 0334 0344 0664 0375 0924 0933
DURABRAND	0333 0375 0356 0933 1085 1086 1087 1088
DVD	1024 0929
ELTA	0365 0382 0894 0333
ELTAX	1051
EMERSON	0380 1057 0339 0375

ENCORE	0386	LINN	0336
ENZER	0392	LITEON	0982 1056 1059 0959
ESA	0956	LODOS	0350
EUROLINE	0894	LOEWE	0370 0375
FARENHEIT	0960	LOGIX	0351 0380
FERGUSON	0373	LUMATRON	0332 0342 1051 0350 0383 0380
FINLUX	0375 0357 0351	LUXMAN	0367
FINTEC	0350	LUXOR	0350 0383
FIRSTLINE	0373	MAGNAVOX	0362 0379 0979 0980 0981 0370 0350 0914
FISHER	0378	MANHATTAN	0350 0380
FUNAI	0339	MARANTZ	0370 0379 0981 0375 0362
GE	0384	MARK	0350
GOLDEN SPHERE	0341	MASTEC	0335
GOLDSTAR	0375 0907 0972	MATSUI	0373 0357 0350
GOODMANS	0373 0382 0350 0333 0351	MAXDORF	0894
GO-VIDEO	0383 1059 1061 0338 0367 0971 0351	MAXIM	0331 0350
GPX	0910	MBO	0396 0383 0382
GRADIENTE	0373	MEDION	0356 0930 0373 0932 0330 0335 0339 0340 0341 0342 0345 0352 0358 0371 0351 0895 0896 0897 0898 0899 0900 0901 0902 0903 0904 0923 0893 0959 1069 1070 1071 1067 1066 1068 1115 1116 1117 1118 0905 0343 0924 0933 0375 0906 0338 0372 0334 0344 0664 0894
GRAETZ	0392	MEMOREX	0356 0339 0920
GRAN PRIX	0356	MERIDIAN	0362
GRANDIN	0357	METZ	0368 0350 0922
GRUNDIG	0385 0370 0380 0373 0378 0376 0350 0333	MICROMAXX	0356 0893 0930 0373 0932 0330 0335 0339 0340 0341 0342 0345 0352 0358 0371 0895 0896 0897 0898 0899 0900 0901 0902 0903 0904 0923 0959 1069 1070 1071 1067 1066 1068 1117 1118 0905 0343 0924 0933 0375 0906 0338 0372 0334 0344 0664 0894
H & B	0350 0343	MICROMEGA	0370
HAAZ	0341 0342	MICROSOFT	0399
HANSEATIC	0375 0351 0333	MICROSTAR	0356 0930 0373 0932 0330 0335 0339 0340 0341 0342 0345 0352 0358 0371 0895 0896 0897 0898 0899 0900 0901 0902 0903 0904 0923 0893 0959 1069 1070 1071 1067 1066 1068 1117 1118 0905 0343 0924 0933 0375 0906 0338 0372 0334 0344 0664 0894
HARMON/KARDON	0395	MINATO	0349
HCM	0894	MINERVA	0380
HE	0383	MINTEK	0384
HITACHI	0367 0368 0392 0387 0350	MIRROR	0349
HITEKER	0357	MITSUBISHI	0350 0366
HOHER	0356	MONYKA	0392
HOME ELECTRONICS	0383	MT LOGIC	1062
HOMITA	0934 0935 0936 0937 0938	MUSTEK	0383
HOYO	0392	MxONDA	0373
HYUNDAI	0351	MYSTRAL	0356
ILO	0959	NAD	0375 0394
INITIAL	0384	NAKAMICHI	0398
INTEGRA	0374	NEC	0375
INTERTRONIC	0893 0933 0894	NEOTEK	0386
JATON	0392	NEUFUNK	0392
JBL	0395	NEVIR	0356
JDB	0383	NEXXTECH	0932 0954 0955 0956
JVC	0361 1058 0362 0400 0964 0662 1072	NORCENT	0332 0982 0944 0945 0948
JWIN	1076 1083	NORDMENDE	0356
KARCHER	0351	NORIKO	0349
KAWASHI	0333	OCEANIC	1089
KENDO	0356 0923 0350	OKANO	0349 0362
KENNEX	0350	OMNI	0382
KENWOOD	0393 0364	ONIX	0346
KISS	0392	ONKYO	0374 0975
KLH	0384	OPTIMUS	0368 0922
KONKA	0908 0909	ORION	0920 0335
KOSS	0358 0373	ORITRON	0373
LASONIC	0341	PACIFIC	0356 0350 0333
LAWSON	0341 0380	PACKARD BELL	0939 0940 1101 1052
LECSO	0376	PALSONIC	0357
LENCO	0373 0350 0356		
LENOXX	0931 0346 0382		
LG	0375 0907 0972		
LIFE	0372 0373 1117 1118		
LIFETEC	0356 0930 0373 0932 0330 0335 0339 0340 0341 0342 0345 0352 0358 0371 0895 0896 0897 0898 0899 0900 0901 0902 0903 0904 0923 0893 0959 1069 1070 1071 1067 1066 1068 1117 1118 0905 0343 0924 0933 0375 0906 0338 0372 0334 0344 0664 0894		
LIMIT	0341		

BUSH 0661
 CARRERA 0663
 CLASSIC 0807
 CONDOR 0860
 CYBERCOM 0843 0664 0668 0674 0675 0694 0730 0742 0743 0744
 0745 0746 0747 0801 0802 0803 0807 0809 0818 0819
 CYBERMAXX 0843 0664 0668 0674 0675 0694 0730 0742 0743 0744
 0745 0746 0747 0801 0802 0803 0807 0809 0818 0819
 CYTRON 0843 0664 0668 0674 0675 0694 0730 0742 0743 0744
 0745 0746 0747 0801 0802 0803 0807 0809 0818 0819
 DENON 0665 0666
 DUAL 0843 0848 0664 0668 0675 0694 0730 0742 0743 0744
 0745 0746 0747 0798 0801 0802 0803
 ELTA 0667 0668 0693 0694 0745
 EMERSON 0848 0859
 FISHER 0669
 GENEXXA 0859 0671 0672 0673 0675 0676 0677
 GOLDSTAR 0663
 GOODMANS 0678 0679
 GRUNDIG 0680 0697 0698 0732
 HARMON/KARDON 0683
 HITACHI 0848 0685 0686
 INNOVATION 0730 0742 0743 0744 0745 0746 0747
 JVC 0662 0687
 KENWOOD 0669 0688 0689 0690 0762
 LIFETEC 0843 0664 0668 0674 0675 0694 0730 0742 0743 0744
 0745 0746 0747 0801 0802 0803 0807 0809 0818 0819
 LG 0663
 LINN 0732
 LUXMAN 0691
 MAGNUM 0730 0742 0743 0744 0745 0746 0747
 MARANTZ 0695 0732
 MATSUI 0696 0732
 MEDION 0843 0664 0668 0674 0675 0694 0730 0742 0743 0744
 0745 0746 0747 0801 0802 0803 0807 0809 0818 0819
 MEMOREX 0848 0859 0677
 MERIDIAN 0732
 MICROMAXX 0843 0664 0668 0674 0675 0694 0730 0742 0743 0744
 0745 0746 0747 0801 0802 0803 0807 0809 0818 0819
 MICROMEGA 0732
 MICROSTAR 0843 0664 0668 0674 0675 0694 0730 0742 0743 0744
 0745 0746 0747 0801 0802 0803 0807 0809 0818 0819
 MISSION 0732
 NAD 0671 0733 0735 0736 0737 0800
 NAIM 0732
 NAKAMICHI 0699 0700
 NUVO 0866
 ONKYO 0840 0701 0702 0703 0785 0792
 PANASONIC 0661 0705
 PHILIPS 0847 0706 0732
 PHILIPS CD-V 0840
 PIONEER 0673 0677 0753
 PRO2 0843 0664 0668 0674 0675 0694 0730 0742 0743 0744
 0745 0746 0747 0801 0802 0803 0807 0809 0818 0819
 PROTON 0732
 QUAD 0732
 REALISTIC 0848 0859 0675
 ROADSTAR 0706 0708
 ROTEL 0732
 SABA 0848
 SAE 0732
 SAMSUNG 0768
 SANSUI 0847 0709 0710 0711 0732
 SCHNEIDER 0860 0732
 SCOTT 0859
 SHARP 0672 0712 0713 0714
 SHERWOOD 0782

SINGER 0803
 SKYMASTER 0778
 SONY 0671 0716 0717 0718 0741 0748 0749 0750
 TANDBERG 0732
 TCM 0843 0664 0668 0674 0675 0694 0730 0742 0743 0744
 0745 0746 0747 0801 0802 0803 0807 0809 0823 0824
 0825
 TEAC 0795
 TECHNICS 0705 0721 0763 0787
 TELEFUNKEN 0848
 TEVION 0843 0664 0668 0674 0675 0694 0730 0742 0743 0744
 0745 0746 0747 0801 0802 0803 0807 0809 0813 0814
 0816 0818 0819 0821 0822
 THEORIE & ANWENDING 0804
 THOMSON 0842 0848
 TOSHIBA 0722 0723
 UNIVERSUM 0732
 VECTOR RESEARCH 0663
 VICTOR 0687
 WELLTECH 0675 0694 0744
 YAMAHA 0712 0720 0725 0771
 YORX 0708

Audio Amplifiers/Tuners/Receivers

CENTRUM 0692
 CRITERION 0775
 CYBERCOM 0841 0775 0776
 CYBERMAXX 0841 0775 0776
 CYTRON 0841 0775 0776
 DENON 0779 0781
 DUAL 0841 0775 0797
 ELTA 0667 0668
 GRUNDIG 0697 0698 0727
 HARMON/KARDON 0682
 KENWOOD 0761
 LIFETEC 0841 0775 0776
 LINN 0857
 MARANTZ 0727
 MEDION 0841 0775 0776
 MICROMAXX 0841 0775 0776
 MICROSTAR 0841 0775 0776
 NAD 0735 0736 0737 0738 0799 0800
 NUVO 0862 0863 0864 0865
 ONKYO 0785 0792 0793
 PHILIPS 0846 0727
 PRO2 0841 0775 0776
 SANSUI 0727
 SCHNEIDER 0791
 SHERWOOD 0782
 SONY 0739 0740 0755 0757 0758 0759 0760
 TCM 0841 0775 0776 0806
 TEAC 0794 0796
 TECHNICS 0764 0777 0788
 TEVION 0775 0776 0815 0817 0841
 THEORIE & ANWENDING 0805
 THOMSON 0842 0766
 XANTECH 0867
 YAMAHA 0724 0752 0770 0771 0772

Audio Tape Players

AIWA 0790
 DENON 0780
 GRUNDIG 0729 0698
 HARMON KARDON 0681

KENWOOD	0761
MAGNAVOX	0729
MARANTZ	0729
NAD	0799
ONKYO	0784
PHILIPS	0729
SANSUI	0729
SHERWOOD	0783
SONY	0754 0755 0756
TEAC	0794
TECHNICS	0764 0777 0786
THOMSON	0842
YAMAHA	0724 0772

MINI Systems

AIWA	0773 0774
CYBERCOM	0852 0858 0704 0745 0808 0810 0820 0819
CYBERMAXX	0852 0858 0704 0745 0808 0810 0811 0812 0820 0819
CYTRON	0852 0858 0704 0745 0808 0810 0811 0812 0820 0819
DUAL	0852 0858 0704 0745 0797 0820 0819
ELTA	0693 0745
GRUNDIG	0707
INTERTRONIC	0811
LIFETEC	0852 0858 0704 0745 0808 0810 0811 0812 0820 0819
MEDION	0852 0858 0704 0745 0808 0810 0811 0812 0820 0819
MICROMAXX	0852 0858 0704 0745 0808 0810 0811 0812 0820 0819
MICROSTAR	0852 0858 0704 0745 0808 0810 0811 0812 0820 0819
PIONEER	0753
PRO2	0852 0858 0704 0745 0808 0810 0811 0812 0820 0819
SAMSUNG	0768
SHARP	0789
SONY	0741
TCM	0852 0858 0704 0745 0808 0810 0820 0819 0694 0823 0824 0825
TEVION	0852 0858 0704 0745 0808 0810 0811 0812 0820 0819 0821 0822
WELLTECH	0852 0810 0820 0819

Miscellaneous

APPLE IPOD	0885
AUDIO COMBI	0844
CAR RADIO	0861
CDR	0847 0675
DBS	0845
iPOD	0884
SWITCH BOX	0684
VIDEO CD	0840

DVB-T Terrestrial Digital Television (DTV Freeview iDTV etc.)

ALBA	0451 0646
BUSH	0451 0032
CANAL +	1177
CYBERMAXX	0645 0650
CYTRON	0645 0650
DIGENIUS	0645
DIGIFUSION	0647
DIGIO2	1150
DMT	0412
DURABRAND	0526
EHOSTAR	0657
FREEBOX	1182

FREEVIEW	0447 0451 0453 0457 0482 0512 0513 0519 0526 0532 0600 0646 0647 0648 0649 0651
GERICOM	0443
GOODMANS	0451 0526
GOODWAY	1163 1164
GRUNDIG	0512 1172
HAUPPAUGE	0482
HITACHI	0526
HUMAX	0651
JVC	0526
LABGEAR	0513
LIDCOM	0451
LIFETEC	0645 0650
MARMITEK OCTOPUS	0655
MATSUI	0649 0526 0451
MEDION	0645 0650
MICO	1135
MICROMAXX	0645 0650
MICROSTAR	0645 0650
NOKIA	0519 0531
NOOS	1183
OGGLE	1136
ON-DIGITAL	0527 0531 0620
OPTEX	0656
PACE	0453 0527
PACIFIC	0526
PANASONIC	0072 0403
PHILIPS	0600
PIONEER	0457 0620
PREMIERE	0600 0519
PRO2	0645 0650
REBOX	0476
SAGEM	0648 1143
SCHWAIGER	0630
SHARP	0059
SKARDIN	0656
SKYMASTER	0656 1165
SM ELECTRONIC	0412 0656 1165 1163 1164
SONY	0447
TCM	1017 1119
TEVION	0645 0650
THOMSON	0427 0532
TOP-UP TV	0527 0531 0657
YUNG FU	1166

DVD Recorders (DVD-R DVD-RW etc.)

APEX	0911
ARENA	0923
ASPIRE	0952
BLUE NOVA INTERNATIONAL	1051
CENTRIOS	0951
CMI	0923
COBY	1051
CYBERCOM	0923
CYBERHOME	0912
CYBERMAXX	0895 0905 0906 0923 0959 1071 1117
CYTRON	0895 0905 0906 0923 0959 1071 1117
DENVER	1051
DUAL	0923
ELTAX	1051
EMERSON	1057
GO-VIDEO	0383 1059 1061
HITACHI	0387
ILO	0959

JVC	1058 1072
KENDO	0923
LG	0907
LIFE	1117
LIFETEC	0895 0905 0906 0923 0959 1071 1117
LITEON	1056 1059 0959
LUMATRON	1051
MAGNAVOX	0979 0980
MEDION	0895 0905 0906 0923 0959 1071 1117
MICROMAXX	0895 0905 0906 0923 0959 1071 1117
MICROSTAR	0895 0905 0906 0923 0959 1071 1117
MUSTEK	0383
PACKARD BELL	0940 1052
PANASONIC	0403
PHILIPS	0979 0980 1080
PHOCUS	1063
PIONEER	0977 1084
PRO2	0895 0905 0906 0923 0959 1071
PROVISION	1051
RTL	0923
SAMPO	1051
SAMSUNG	1050
SANYO	1060
SHARP	1055
SONY	0987 0988 0989
TANGENT	1051
TCM	0923
TELEDEVICE	1051
TEVION	0890 0891 0895 0905 0906 0923 0959 1065 1071 1117
THOMSON	0360 0359
TINY	1051
TOSHIBA	0973 0983 0362 1111
TRANS-CONTINENTS	1051
YAKUMO	0905
YAMAHA	0979 0980
ZENITH	0907

LASAT	1156 1157
LIFE	1117
LIFESAT	0412 0423 0514
LIFETEC	0905 0412 0423 0514 0644 0653 1130 0959 1071 1117
LITEON	0959
LORENTZEN	1156
MARMIKTEK OCTOPUS	0655
MEDION	0905 0412 0423 0514 0644 0653 1130 0959 1071 1139 1115 1181 1117
MICROMAXX	0905 0412 0423 0514 0644 0653 1130 0959 1071 1139 1117
MICROSTAR	0905 0412 0423 0514 0644 0653 1130 0959 1071 1117
MORETV	0644 1130 1181
PACE	0555 0453
PACKARD BELL	1052
PANASONIC	0403
PHILIPS	0242
PHOCUS	1063
PINNACLE	0654
PIONEER	0977
PRO2	0905 0412 0423 0514 0644 0653 1130 0959 1071
PROCASTER	0905
SAGEM	0599 1143 1158
SCHWAIGER	0412 0514 1132 1152
SIEMENS	1157
SKARDIN	1160
SKY	1151
SKY DIGITAL	0555
SKY+	0555
SKYMASTER	0506 1165 1159 1160
SKYPEX	1156
SM ELECTRONIC	0412 0506 1165 1159 1160
SONY	0987 0988 0989
TCM	0412 0423 0514
TEVION	0890 0905 0412 0423 0514 0644 0653 1130 0959 1065 1071 1117
THOMSON	0532 0242 0326 1156
TIVO	0242
TONBURY	1159
TOPFIELD	0506
TOSHIBA	0983 1111
UNIVERSUM	1156
WYSI	1156
YAKUMO	0905

HDD Digital Video Recorders (Hard Disk Drive DVR PVR etc.)

AMSTRAD	0555
ARCON	1144
BSKYB	0555
CANAL SATELLITE	0599
CANAL+	0599
CONRAD	1156
CYBERCOM	0412 0423 0514
CYBERMAXX	0905 0412 0423 0514 0644 0653 1130 0959 1071 1117
CYTRON	0905 0412 0423 0514 0644 0653 1130 0959 1071 1117
DIGIFUSION	0647
DMT	0412
DREAMBOX	0658
DUAL	0412 0423 0514
EHOSTAR	0659
EUROSKY	1156
FORCE	0553
FORTEC STAR	0470
FREEBOX	1182
GLOBO	1156
HIRSCHMANN	1156
HUMAX	0651
HYUNDAI	0486
ILO	0959
JVC	1072

Home Cinema Systems DVD & AUDIO

(Home Cinema Systems operate with either a single DVD code or some require both [DVD & AUDIO] codes)

AIWA	0377
AMW	1054
CENTRUM	0927
COBY	0948
CRITERION	[0344 & 0775]
CURTIS	0948
CYBERCOM	0334 0372 [0344 & 0775]
CYBERMAXX	0334 0372 1069 1066 1118 [0344 & 0775]
CYTRON	0334 0372 1069 1066 1118 [0344 & 0775]
DUAL	0334 0372 [0344 & 0775]
DURABRAND	0375

FISHER	0378
JVC	0662 0964
KOSS	0373
LENOXX	0931
LG	0972
LIFE	1118
LIFETEC	0334 0372 1069 1066 1118 [0344 & 0775]
MEDION	0334 0372 1069 1066 1118 [0344 & 0775]
MICROMAXX	0334 0372 1069 1066 1118 [0344 & 0775]
MICROSTAR	0334 0372 1069 1066 1118 [0344 & 0775]
NORCENT	0948
ONKYO	0975
PANASONIC	0974
PIONEER	0968 0976
PRO2	0334 0372 1069 1066 [0344 & 0775]
SAMSUNG	0919
SONY	0986
TCM0334	[0344 & 0775]
TEVION	0334 0372 0892 0917 0918 1069 1066 1118 [0344 & 0775]

TV/VCR Combos

AIWA	0248 0291
ALBA	0245 0248
BAIRD	0245
BASIC LINE	0245
BESTAR	0245
BLACK PANTHER LINE	0245
BUSH	0245 0248
COMBITECH	0248
CONDOR	0245
CROWN	0245
CYBERCOM	0248 0291
CYBERMAXX	0248 0291
CYTRON	0248 0291
DAEWOO	0245
DAYTRON	0245
DUAL	0248 0291
ESC	0245
GENERAL TECHNIC	0248
GOLDSTAR	0261
GOODMANS	0245 0283
GRANDIN	0245
HINARI	0248
INNO HIT	0245
INNOVATION	0248 0291
ITV	0245
KENDO	0245
Lenco	0245
LG	0261
LIFE	0291
LIFETEC	0248 0291
LUMATRON	0245
MAGNUM	0291
MATSUI	0248
MEDION	0248 0291
MICROMAXX	0248 0291
MICROSTAR	0248 0291
ORION	0248 0283
PORTLAND	0245
PRO2	0248 0291

PROSONIC	0245
ROADSTAR	0245
SABA	0245
SAISHO	0248
SAMSUNG	0312
SAVILLE	0248
SCHNEIDER	0245 0264
SONOKO	0245
STANDARD	0245
TCM	0248 0291
TEVION	0248 0291
THOMSON	0245
UNITED QUICK STAR	0245
VIDEON	0248

TV/DVD Combos

(TV/DVD Combos operate with either a single DVD code or some require both [DVD & TV] codes)

AUDIOSONIC	[1062 & 0090]
BEKO	1064
BROKSONIC	0920
CYBERCOM	[0343 & 0228] [0924 & 0210] [0933 & 0228]
CYBERMAXX	0894 [0343 & 0228] [0924 & 0210] [0933 & 0228]
CYTRON	0894 [0343 & 0228] [0924 & 0210] [0933 & 0228]
DUAL	[0343 & 0228] [0924 & 0210] [0933 & 0228]
DURABRAND	[0933 & 0228] [1085 & 1006] [1085 & 1007] [1086 & 1008] [1087 & 1008] [1088 & 1009]
H & B	[0343 & 0228]
INTERTRONIC	0894
LIFETEC	0894 [0343 & 0228] [0924 & 0210] [0933 & 0228]
MEDION	0894 [0343 & 0228] [0924 & 0210] [0933 & 0228]
MEMOREX	0920
MICROMAXX	0894 [0343 & 0228] [0924 & 0210] [0933 & 0228]
MICROSTAR	0894 [0343 & 0228] [0924 & 0210] [0933 & 0228]
MT LOGIC	[1062 & 0090]
OCEANIC	[1089 & 1011]
ORION	0920
PHILIPS	[0339 & 0181]
PHOCUS	1064
PRO2	0894 [0343 & 0228] [0924 & 0210] [0933 & 0228]
SANSUI	0920
TCM	1119 [0343 & 0228] [0924 & 0210] [0933 & 0228]
TEVION	0894 1064 [0343 & 0228] [0924 & 0210] [0933 & 0228]
TOSHIBA	0920

DVD/VCR Combos

(DVD/VCR Combos operate with either a single DVD code or some require both [DVD & VCR] codes)

APEX	0949
BROKSONIC	0920 0967
CINEVISION	[0375 & 0256]
CYBERCOM	0338 [0375 & 0256]
CYBERMAXX	0338 0896 0906 [0375 & 0256]

CYTRON	0338 0896 0906 [0375 & 0256]
DAEWOO	0971
DUAL	0338 [0375 & 0256]
EMERSON	[0339 & 0231] [0375 & 0256]
FUNAI	[0339 & 0231]
GO-VIDEO	0338 0367 0971
GOLDSTAR	[0375 & 0256]
HITACHI	[0387 & 0231]
JVC	0400
LG	0907 [0375 & 0256]
LIFETEC	0338 0896 0906 [0375 & 0256]
MAGNAVOX	[0914 & 0285]
MEDION	0338 0896 0906 [0375 & 0256]
MICROMAXX	0338 0896 0906 [0375 & 0256]
MICROSTAR	0338 0896 0906 [0375 & 0256]
PANASONIC	0970
PHILIPS	[0969 & 0285]
PIONEER	1084
POLAROID	0949
PRO2	0338 0896 0906 [0375 & 0256]
SAMSUNG	0338 0963
SANSUI	0920
SANYO	[0378 & 0258]
SONY	0402
SSYLVANIA	[0339 & 0231]
TCM	0338 [0375 & 0256]
TEVION	0338 0896 0906 [0375 & 0256]
TOSHIBA	0362
ZENITH	[0375 & 0256]

TEVION	0650 0645 0423
YUNG FU	1166

Miscellaneous Set Top Boxes

PARDY LIGHT BOX 1171

ADSL (BROADBAND) DTV Receivers

ALICE TV	1158
FRANCE TELECOM	1158
FREEBOX TV	1176 1182
MALIGNE TV	1158 1180
NEUF TELECOM	1179
NEUF TV	1179
NOOS	1143 1158 1175 1183
NUMERICABLE	1183
ORANGE	1183 1158 1180
SAGEM	1158 1177
SAMSUNG	1149
THOMSON	1175 1180
TPS ADSL	1158 1179 1180
UPC	1143 1175
VERSATEL	1149

Home Automation

X10	0998
-----	------

Auxiliary Set-Top Boxes

Web & Computer TV

BUSH	0039
CYBERLINK	1101
GERICOM	0443
HAUPPAUGE	0482
PACKARD BELL	1101
PANASONIC	0542
PREMIERE	0542
THOMSON	0603

Media Receivers

SONY NETWORK MEDIA RECEIVER 0446

Scart Switch Boxes

COUNTRYMAN	1168
FUNK	1170
MARMITEK	0641
SKARDIN	1169
VIVANCO	0684

Digital Set Top Boxes

EHOSTAR	0657
---------	------