

## 22" LED TV

L22FE14





# WE KNOW HOW TO HELP YOU WITH YOUR TV

FOR UK

We want you to be able to enjoy your new TV for many years. From getting it home and setting it up, to helping you get the most out of your new purchase. And in the unlikely event your TV lets you down, we can get it working again in no time.

Here are some of our TV services, but if you want to know more look us up at [www.knowhow.com](http://www.knowhow.com) or call us on: 0344 561 1234.

## TV SET UP & DEMO

We'll assemble the stand and connect your new TV to the existing equipment. We'll tune your TV so it's ready to watch. We'll also give you a demonstration of your new TV's functions.

## TV WALLMOUNT & DEMO

We'll fix your TV to a suitable position on the wall and connect to your existing equipment, so it's all ready to go. We'll use neat wire management so you don't have to look at any untidy cabling and, to complete your fuss-free installation, we'll test and demonstrate your TV's functions.

## FREESAT INSTALLATION

We'll set up the Freesat receiver and connect it to your existing dish, TV and cabling. We'll then tune in all available channels.

## AERIAL INSTALLATION

We'll supply, install and align a new, high quality aerial and connect it to your Freeview receiver and TV. Then we'll scan and tune in all available digital channels.

## HOME CINEMA OR SOUNDBAR INSTALLATION

We'll un-box, connect and set up your new and existing equipment. We'll then configure, calibrate and optimise the equipment. To avoid ugly trailing cables we'll clip them to your skirting board if you'd like us to. Then we'll give you a demonstration.

## FAULT & FIX SERVICES

With our Fault & Fix services we can repair a wide range of products at our new state-of-the-art repair lab. This service is available for:

- Computer desktops
- Netbooks
- Laptops
- TVs



**KNOWHOW**<sup>®</sup>

Lifetime support for Currys PCWorld customers

# WE KNOWHOW TO HELP YOU WITH YOUR TV



We want you to be able to enjoy your new TV for many years. From getting it home and setting it up, to helping you get the most out of your new purchase. And in the unlikely event your TV lets you down, we can get it working again in no time.

Here are some of our TV services, but if you want to know more look us up at [www.knowhow.ie](http://www.knowhow.ie) or call us on: 1 890 818 575.

## TV SET UP & DEMO

We'll assemble the stand and connect your new TV to the existing equipment. We'll tune your TV so it's ready to watch. We'll also give you a demonstration of your new TV's functions.

## TV WALLMOUNT & DEMO

We'll fix your TV to a suitable position on the wall and connect to your existing equipment, so it's all ready to go. We'll use neat wire management so you don't have to look at any untidy cabling and, to complete your fuss-free installation, we'll test and demonstrate your TV's functions.

## TV & HOME CINEMA INSTALLATION

We'll un-box, connect and set up your new and existing equipment. We'll then configure, calibrate and optimise the equipment. To avoid ugly trailing cables we'll clip them to your skirting board if you'd like us to. Then we'll give you a demonstration.

## FAULT & FIX SERVICES

With our Fault & Fix services we can repair a wide range of products at our new state-of-the-art repair lab. This service is available for:

- Desktop PCs
- Laptops
- Netbooks
- TVs



**KNOWHOW**<sup>®</sup>

Lifetime support for Currys  PCWorld customers

# Contents

---

<b>Safety Warnings</b> .....	<b>7</b>
<b>Preparation</b> .....	<b>9</b>
Unpacking the TV .....	9
Installing / Removing the Base Stand .....	10
– Installing the Base Stand.....	10
– Mounting the TV to a Wall.....	10
Front / Right Side View and Controls.....	11
Rear View and Sockets.....	12
Installing Batteries in the Remote Control .....	13
Remote Control Operation Range.....	13
Remote Control .....	14
<b>Connections</b> .....	<b>16</b>
Making Video and Audio Connections.....	16
Connecting an AV Device Using an HDMI Cable.....	16
Connecting a Computer Using a VGA Cable .....	17
Connecting an AV Device Using a Component (YPbPr) Cable .....	17
Connecting an AV Device Using a SCART Cable .....	18
Connecting an AV Device Using Composite Cable.....	18
Connecting a Audio Receiver.....	19
Connecting Headphones.....	19
<b>Initial Setup</b> .....	<b>20</b>
Turning the TV On for the First Time .....	20
– Target Region Setting (UK Only) .....	21
– Selecting the Input Source.....	21
– Channel Selection .....	22
– Listening to the Radio (Radio Mode).....	22
– Display Channel Information .....	22
– Volume Adjustment.....	22
<b>Customising TV Settings</b> .....	<b>23</b>
Channel Setting (DTV, TV or Radio Mode).....	23
– Auto Tuning .....	23
– DTV Manual Tuning (DTV Mode).....	24
– ATV Manual Tuning (ATV Mode).....	24
– Channel Edit (DTV / ATV Mode).....	25
– Signal Information (DTV Mode).....	26
– CI (Common Interface) (DTV Mode).....	27
– Software Update.....	28
Picture Setting .....	29
Sound Setting .....	31
– Stereo / Dual Sound Reception (ATV Mode).....	32
– Speaker Sound Output Selection (DTV Mode).....	33
Time Settings.....	33
Option Setting .....	34
– OSD Language .....	34
– Audio Language (DTV Mode).....	35
– Subtitle Language (DTV Mode) .....	35
– Hearing Impaired.....	36
– Country.....	36
– PVR File System (DTV Mode).....	37
– Restore Factory Default.....	38
– HDMI CEC (Consumer Electronics Control).....	38
Lock Setting .....	39
– Lock System .....	39
– Set Password .....	40
– Block Channel .....	41
– Parental Guidance .....	42

<b>Using the Features .....</b>	<b>43</b>
EPG (Electronic Programme Guide) (DTV Mode) .....	43
– Switch On / Off EPG.....	43
– Select a Programme .....	43
Red Button (Interactive Services).....	44
– Accessing the Information .....	44
<b>Entertainment .....</b>	<b>45</b>
Connecting a USB Storage Device.....	45
Viewing Photos.....	45
Listening to Music.....	46
Viewing Movies .....	47
My Text.....	48
<b>PVR (Personal Video Recorder).....</b>	<b>49</b>
Time Shift Function.....	49
Recording DTV Programme onto a USB Storage Device .....	50
Timer Programming .....	51
Play Recorded Programme .....	52
<b>Others Information .....</b>	<b>53</b>
Maintenance.....	53
Hints and Tips.....	53
Display Modes.....	55
– YPbPr Mode .....	55
– PC Mode.....	55
– HDMI Mode .....	55
Product Fiche and Specifications .....	56
Remote Control Codes.....	58
– Sky Codes .....	58
Useful Information and Licences .....	58

# Safety Warnings

- Read all the instructions carefully before using the unit and keep them for future reference.
- Retain the manual. If you pass the unit onto a third party make sure to include this manual.
- Check that the voltage marked on the rating label matches your mains voltage.

## Damage

- Please inspect the unit for damage after unpacking.
- Do not continue to operate the unit if you are in any doubt about it working normally, or if it is damaged in any way - switch off, withdraw the mains plug and consult your dealer.

## Location of Unit

- The unit must be placed on a flat stable surface and should not be subjected to vibrations.
- Do not place the unit on sloped or unstable surfaces as the unit may fall off or tip over.
- The mains socket must be located near the unit and should be easily accessible.
- This unit is designed for indoor, domestic use only.

## Temperature

- Avoid extreme degrees of temperature, either hot or cold. Place the unit well away from heat sources such as radiators or gas / electric fires.
- Avoid exposure to direct sunlight and other sources of heat.

## Naked Flames

- Never place any type of candle or naked flame on the top of or near the unit.

## Moisture

- To reduce the risk of fire, electric shock or product damage, do not expose this unit to rain, moisture, dripping or splashing. No objects filled with liquids, such as vases, should be placed on the unit.
- If you spill any liquid into the unit, it can cause serious damage. Switch it off at the mains immediately. Withdraw the mains plug and consult your dealer.

## Ventilation

- To prevent the risk of electric shock or fire hazard due to overheating, ensure that curtains and other materials do not obstruct the ventilation vents.
- Do not install or place this unit in a bookcase, built-in cabinet or in another confined space. Ensure the unit is well ventilated.
- Make sure that there is a gap of at least 10 cm on both sides and a gap of 20 cm at the top.

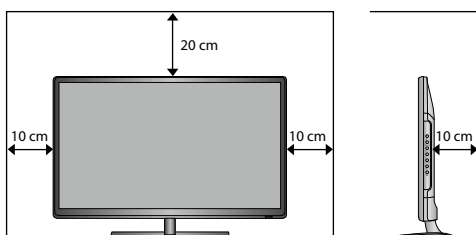

## Safety

- Always disconnect the unit from the mains supply before connecting / disconnecting other devices or moving the unit.
- Unplug the unit from the mains socket during a lightning storm.

## Mains Cable

- Make sure the unit or unit stand is not resting on top of the mains cable, as the weight of the unit may damage the mains cable and create a safety hazard.
- If the mains cable is damaged it must be replaced by the manufacturer, its service agent, or similarly qualified persons in order to avoid a hazard.

## Interference

- Do not place the unit on or near appliances which may cause electromagnetic interference. If you do, it may adversely affect the operating performance of the unit, and cause a distorted picture or sound.

## Optimum viewing

- View the unit in moderate light to prevent eye strain. It is recommended to watch the unit from a distance 3-7 times that of the screen height.

## LCD screen

- The LCD screen is manufactured using high-precision technology. However, some tiny black points and / or bright points (red, blue or green in colour) may constantly appear on the LCD screen. These points are generated in the manufacturing process and are normal.

## Screen Burn

- A characteristic of Plasma and TV Panels is that displaying the same image for a long time may cause a permanent after-image to remain on the screen. This is called screen burn. Most pictures shown on the unit will be constantly moving and fill the screen.
- Examples of images that you need to watch out for are as follows (this is not an all-inclusive list):
  1. **Black Bars:** If black bars appear at the left / right or top / bottom of the screen, it is recommended to change the format so that the picture fills the entire screen.
  2. **TV Channel Logos:** e.g. Shopping channel logos and pricing displays - especially if they are bright and stationary. Moving or low-contrast graphics are less likely to cause ageing of the screen.
  3. **Time Displays**
  4. **Teletext:** Do not view a stationary page for long periods of time.
  5. **TV Menus**
  6. **Pause Mode:** Do not leave the screen in pause mode for long periods of time, e.g. when watching videos.
- To prevent screen burn if viewing any of the above for long periods of time, reduce contrast and brightness when viewing. Once burn-in occurs it will never disappear completely.

### Earphones

- Listening to loud sounds for prolonged periods of time may permanently damage your hearing.
- Before putting on earphones, turn the volume down then put the earphones on and slowly increase the volume until you reach a comfortable listening level.

### Standby

- The  button on the remote control does not switch off the unit completely. The unit will continue to draw electricity from the mains supply while in standby. In the interests of safety and to avoid unnecessary energy consumption, never leave the unit in standby while unattended for long periods of time, e.g. overnight, while on holiday or while out of the house. Disconnect the mains plug from the mains socket.

### Batteries

- Batteries used in the remote control for this unit are easily swallowed by young children and this is dangerous.
- Keep loose batteries away from young children and make sure that the battery holder tray is secure in the remote control. Seek medical advice if you believe a cell has been swallowed.
- Please dispose of batteries correctly by following the guidance in this manual.
- The batteries shall not be exposed to excessive heat such as sunshine, fire or the like.

### Supervision

- Children should be supervised to ensure that they do not play with the unit and the remote control.
- Never let anyone especially children push anything into the holes, slots or any other openings in the case - this could result in a fatal electric shock.



The lightning flash with arrowhead symbol, within an equilateral triangle, is intended to alert the user to the presence of uninsulated "dangerous voltage" within the unit's enclosure that may be of sufficient magnitude to constitute a risk of electric shock.



The exclamation point within an equilateral triangle is intended to alert the user to the presence of important operating and maintenance (servicing) instructions in the manual accompanying the unit.

### Service

- To reduce the risk of electric shock, do not remove screws. The unit does not contain any user-serviceable parts. Please leave all maintenance work to qualified personnel.
- Do not open any fixed covers as this may expose dangerous voltages.

### Maintenance

- Ensure to unplug the unit from the mains socket before cleaning.
- Do not use any type of abrasive pad or abrasive cleaning solutions as these may damage the unit's surface.
- Do not use liquids to clean the unit.
- The wall socket plug is used as a disconnect device, the disconnect device should be readily accessible.
-  This equipment is a Class II or double insulated electrical appliance. It has been designed in such a way that it does not require a safety connection to electrical earth.



To prevent the spread of fire, keep candles or other open flames away from this product at all times.



## Thank you

for purchasing your new Logik TV.  
Your new TV has many features and incorporates the latest technology to enhance your viewing experience. We recommend that you spend some time reading this instruction manual so that you fully understand these features. You will also find some hints and tips to help you resolve any issues. Read all the safety instructions carefully before use and keep this instruction manual for future reference.

## Unpacking the TV

Remove all packaging from the TV. Retain the packaging. If you dispose of it please do so according to local regulations.

The following items are included:



TV



TV Stand Support



TV Base



Remote Control / AAA Batteries x 2



Screw A x 1



Screw B x 3



Instruction Manual

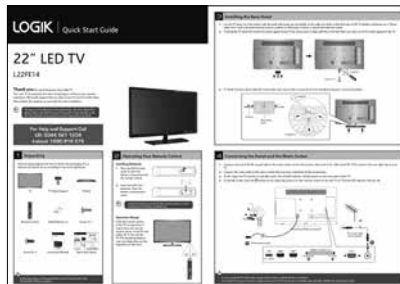

Quick Start Guide

GB

Preparation



- If items are missing, or damaged please contact Partmaster (UK only). Tel: 0344 800 3456 for assistance.
- if you require additional assistance:  
For UK, please call our UK Call Centre on **0344 561 1234**.  
For Ireland, please call our Ireland Call Center on **1 890 818 575**.

## Installing / Removing the Base Stand



The LCD display is very fragile, and must be protected at all times when installing and removing the base stand. Be sure that no hard or sharp object, or anything that could scratch or damage the LCD display, comes into contact with it. DO NOT exert pressure on the front of the TV at any time because the screen could crack.

1. Disconnect all cables connected to the TV.
2. Lay the TV down on a flat surface with the back side facing up, and ideally at the edge of a table so that the base of the TV slightly overhangs on it. Please make sure a soft cushioned material (such as a pillow or thick piece of foam) is placed beneath the screen.

### Installing the Base Stand

1. To install the TV stand, first attach the stand support to the TV by using screw A. Align with the screw hole then use screws to fix the stand support to the TV.

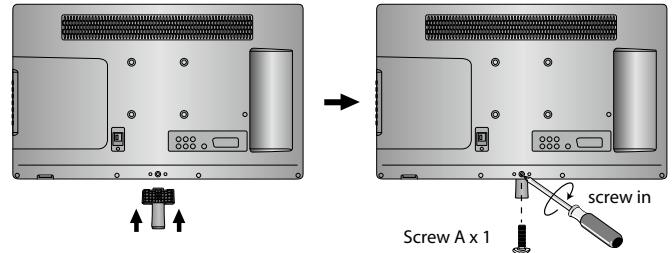

2. To install the base stand, align the screw holes, then secure with a screw driver (not included) using the 3 screw B provided.



The screw holes will only align if the front of the base stand is at the front of the TV.

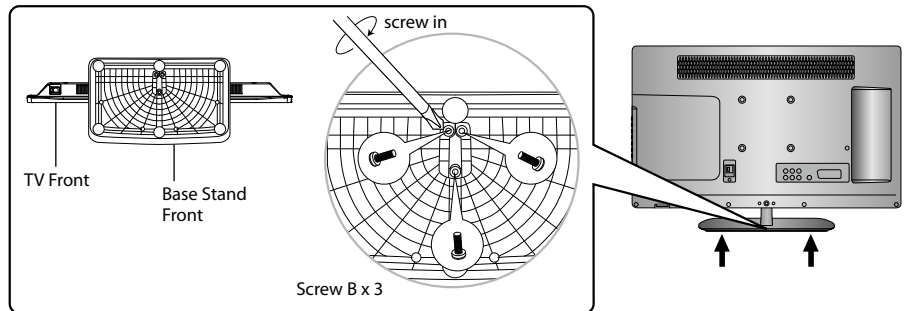

### Mounting the TV to a Wall



Remove the stand assembly before mounting the TV onto the wall.

1. To remove the stand assembly, untighten the screws holding the stand assembly to the rear of the TV. Slide the stand assembly out.



Keep all the spare screws should you want to use the stand assembly option.

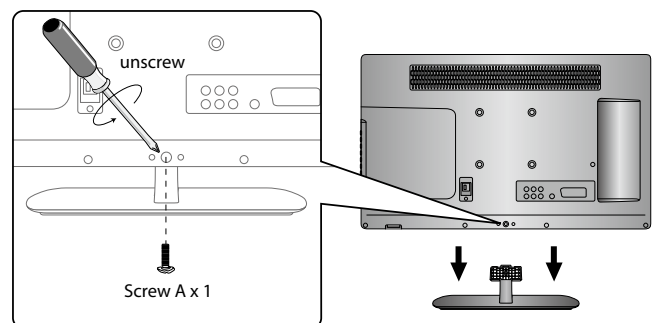

2. Mounting on the wall. This TV is designed to be wall-mounted with a standard 200 mm x 100 mm mounting kit (sold separately) designed for flat-panel TVs. Mount this TV according to the instructions included in the mounting kit. Due to space restrictions, we recommend that you make all connections (refer to page 16-19 and page 45 for details) before mounting on to the wall.

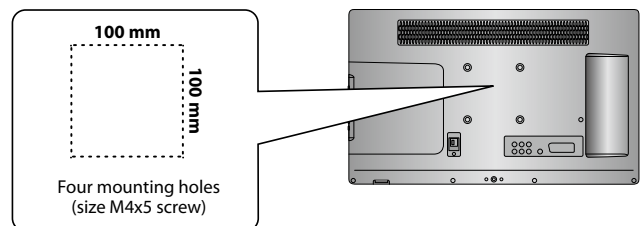

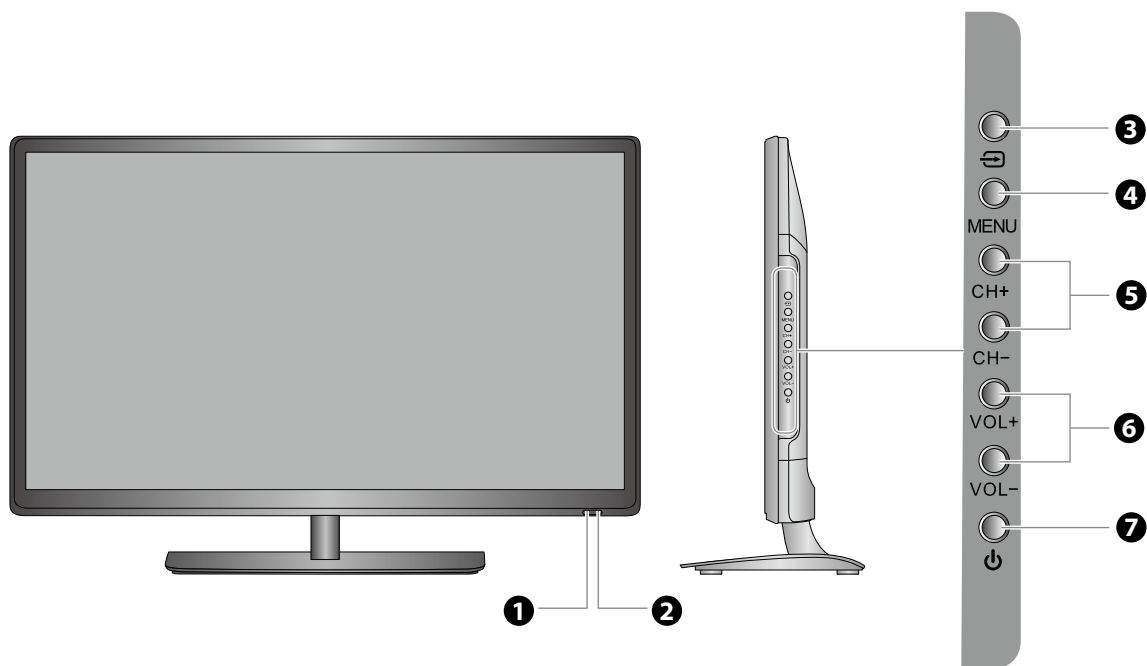

- Please read this instruction manual carefully while setting up your TV.
- If you require additional assistance:  
for UK, please call our UK Call Centre on **0344 561 1234**.  
for Ireland, please call our Ireland Call Center on **1 890 818 575**.

## Front / Right Side View and Controls



**GB**

Preparation

Item	Description
1 <b>POWER LED</b>	Illuminates red when the TV is in standby mode. The LED will illuminate blink red confirming that a timer recording programme has started in the standby mode.
2 <b>IR (Infrared Receiver)</b>	Receives IR signals from the remote control. Do not put anything near the sensor, as its function may be affected.
3 	Press to select among different input signal sources: DTV / ATV / AV / SCART / YPbPr / HDMI1 / HDMI2 / PC / USB. Use the ▲▼ buttons on the remote control to select the input, and then press the <b>OK</b> button to confirm.
4 <b>MENU</b>	Displays the OSD (on screen display) menu.
5 <b>CH + / -</b>	Press to select a channel or select a sub-menu from the OSD menu.
6 <b>VOL + / -</b>	Adjusts the volume. Press to select and adjust a setting in the OSD menu.
7 	Switches the TV on from standby mode. Switches the TV back to standby mode.

## Rear View and Sockets

GB

Preparation

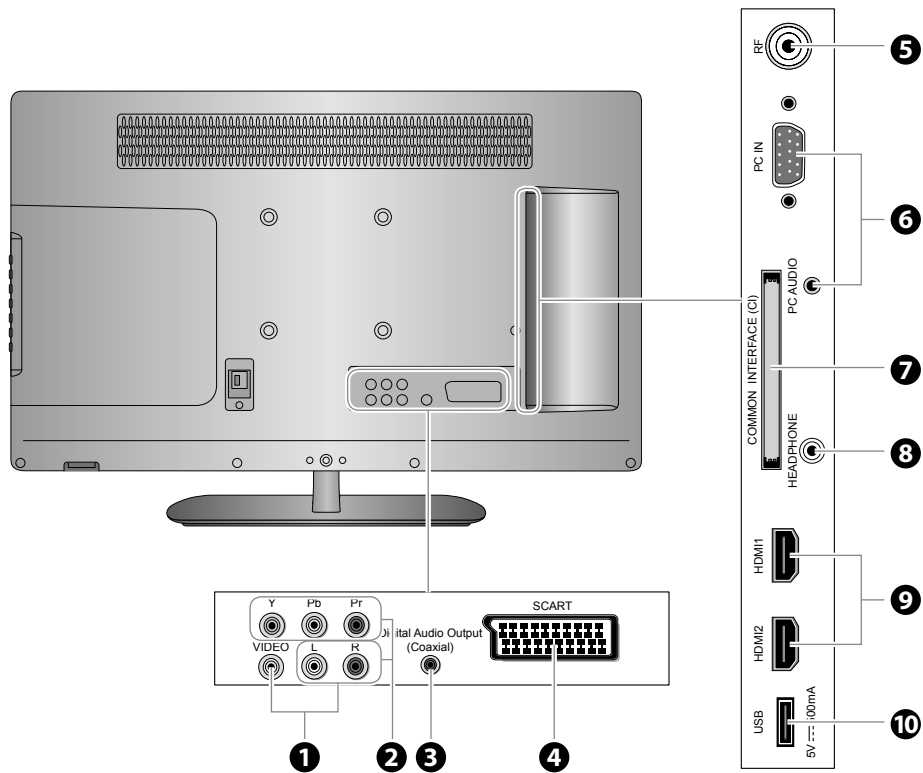

Item	Description
1 VIDEO / AUDIO (L/R)	Connects to the Composite VIDEO and AUDIO (L/R) output sockets on external video devices.
2 Y, PB, PR / AUDIO (L/R)	Connects to a DVD player, Digital Set-Top-Box, or other AV devices with component (YPbPr) video and audio output sockets.
3 Digital Audio Output (Coaxial)	To connect to the audio socket on the digital/standard 5.1 audio system.
4 SCART	Connects to a VCR, DVD Player, or other AV device with a SCART output socket.
5 RF Aerial	Connects to the aerial socket on the wall with the RF coaxial cable.
6 PC IN / PC AUDIO	Connects to a computer or other devices with a VGA interface.
7 COMMON INTERFACE	Allows the insertion of a Common Access Module. (Refer to page 27 for details.)
8 HEADPHONE	Connects to the headphones.
9 HDMI1/ HDMI2	Connects to a High-Definition (HD) signal output device, such as a set-top box, blu-ray disc player or AV receiver.
10 USB	Allows the insertion of a USB storage device to play video, audio, photo and text files (USB mode) and record DTV programmes on to a USB storage device.

## Installing Batteries in the Remote Control

1. Press and lift the back cover to open the battery compartment of the remote control.

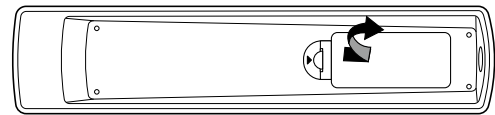

2. Insert two AAA size batteries. Make sure the (+) and (-) ends of the batteries match the (+) and (-) ends indicated in the battery compartment.

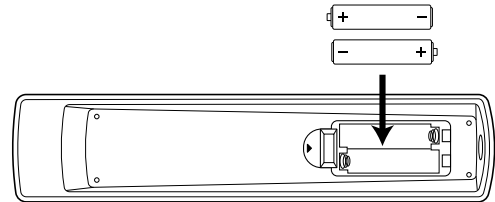

3. Close the battery compartment cover.



### Handling the Batteries

- Improper or incorrect use of batteries may cause corrosion or battery leakage, which could cause fire, personal injury or damage to property.
- Only use the battery type indicated in this manual.
- When the batteries are exhausted, the remote will not function. Replace both batteries at the same time with new ones.
- Do not install new batteries with used ones and do not mix different types of batteries.
- Do not dispose of used batteries as domestic waste. Dispose of them in accordance with local regulations.

### Handling the Remote Control

- Take care of your fingernails when you press and hold the battery release tab.
- Do not drop or cause impact to the remote control.
- Do not spill water or any liquid on the remote control.
- Do not place the remote control on a wet object.
- Do not place the remote control under direct sunlight or near sources of excessive heat.
- Remove the battery from the remote control when not in use for a long period of time, as it could cause corrosion or battery leakage and may result in physical injury and/or property damage including fire.

**GB**

Preparation

## Remote Control Operation Range

Point the remote control at the TV no more than 5 metres from the remote control sensor on the TV and within 60° in front of the TV. The operating distance may vary depending on the brightness of the room.

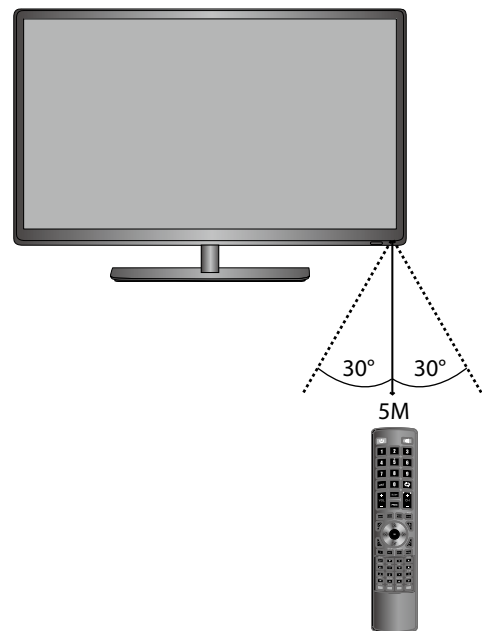

# Remote Control

GB

Preparation

1. Switch the TV between on and standby mode.
2. Mute and restore your TV sound.
3. **0-9 Number Button**
  - Press to select a programme.
  - Select numbered items in a menu. (DVD mode)
4. **LIST**  
Display the channel list. (ATV / DTV mode)
5.
  - Return to the previous viewing channel. (ATV / DTV mode)
  - Return to menu (DVD mode)
6. **SLEEP**  
Set the TV sleep timer: OFF / 10 / 20 / ... / 180 / 240 min.
7. **VOL + / -**  
Adjust the volume.
8. **CH + / -**  
Select a channel.
9. **PROG**
  - Display the channel edit menu. (ATV / DTV mode)
  - Programme the DVD. (DVD mode)
10. **S.MODE**  
Select sound mode: Standard / Music / Movie / Sports / User.
11. **ASPECT**  
Watch the screen in various formats: Auto / 4:3 / 16:9 / Full / Zoom / Subtitle / Smart Zoom.
12. **GUIDE**  
Displays the EPG Electronic Programme Guide. (DTV mode)
13. **TITLE**  
Display the DVD title content. (DVD mode)
14. **P.MODE**  
Select picture mode: Standard / Mild / User / Dynamic.
15. **MENU**  
Display the OSD (On Screen Display) menu.
16. **INPUT**  
Select among the different input signal sources:  
DTV / ATV / AV / SCART / YPbPr / HDMI1 / HDMI2 / PC / USB.
17. Allows you to navigate the OSD menus and adjust the system settings to your preference.
18. **OK**  
Confirm the selection in the OSD menus.
19. **BACK**  
Return to the previous menu in the OSD menus.
20. **Exit**  
Exit the OSD menu.
21. **FAV**  
Display the favourite channel list. (ATV / DTV mode)
- SETUP**  
Display and exit the DVD setup menu. (DVD mode)
22. **i**
  - Display the present channel information such as the current time and channel name. (ATV / DTV mode)
  - Display the present disc information. (DVD mode)
23. **TV.RD**  
A short-cut to switch input source to TV / Digital radio channels.
- ANGLE**  
Select different angles for the video. (DVD mode)

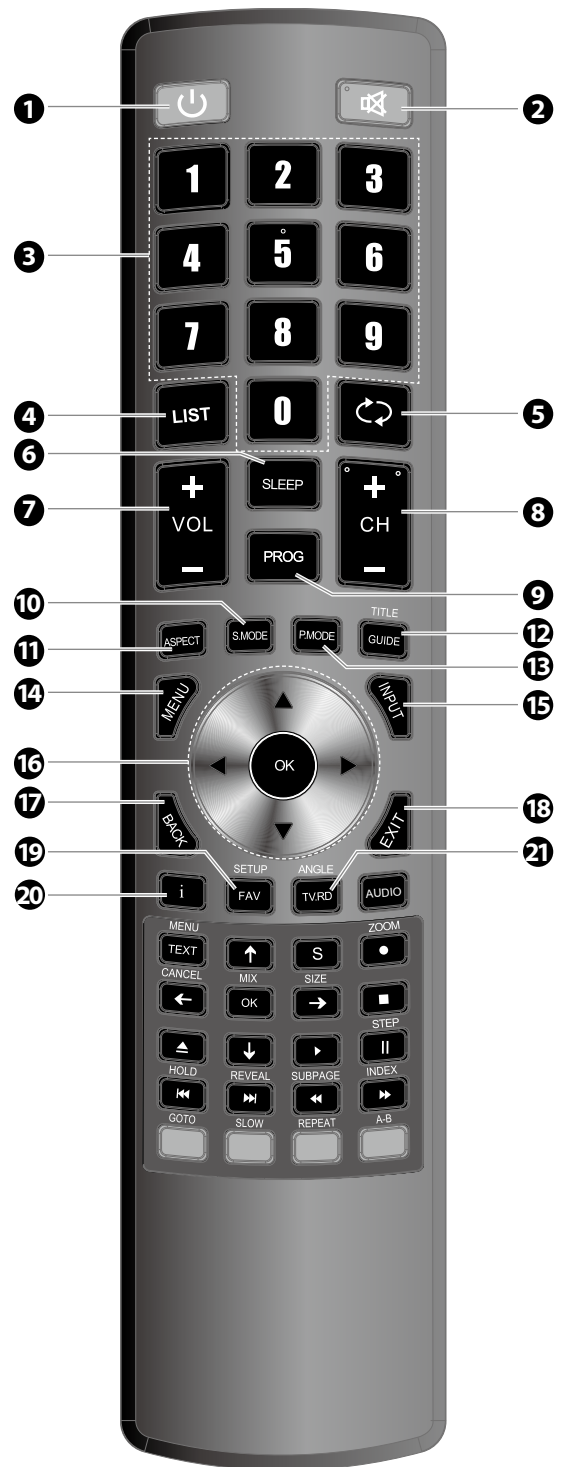

Please note that there are DVD mode functions on the remote control only operate on TV models with a built-in DVD player.

## 22. AUDIO (Audio Description)

- Turn on / off the Audio Description (AD) function (only applicable when the TV programme has this feature). (DTV mode)
- Select different Audio mode on DVD mode. (DVD mode)
- Select Stereo / Dual Sound Reception. (ATV mode)

## 23. TEXT

Turn on and off the teletext function. (DTV mode)

### MENU

Display the DVD menu. (DVD mode)

## 24. S (Subtitle)

- Display subtitles which are broadcast with the programme. (DTV mode)
- Display subtitles on the DVD. (DVD mode)

## 25. ● REC

Record the current programme. (DTV mode).

### ZOOM

Zoom in on the displayed frame. (DVD mode)

## 26. ←↑↓→

Navigate the DVD menu and adjust the system settings to your preference. (DVD mode)

### OK

Confirm the selection in the DVD menus. (DVD mode)

**CANCEL** (No Function)

**MIX** (No Function)

**SIZE** (No Function)

## 27. ■ Stop

Stop the playback or recording. (DVD / USB / DTV mode)

## 28. ▲

Eject a disc. (DVD mode)

## 29. || Pause

- Pause playback. (DVD / USB mode)
- Start the time-shift function (DTV mode)

### STEP

Play the playback forward frame by frame. (DVD mode)

## 30. ▶ PLAY

Start playback. (DVD / USB mode)

## 31. ►►

Skip to the beginning of the next chapter / track / photo. (DVD / USB mode)

**REVEAL** (No Function)

## 32. ◀◀

To skip to the beginning of the previous chapter / track / photo. (DVD / USB mode)

**HOLD** (No Function)

## 33. ◀◀

Reverse playback rapidly. (DVD / USB mode)

**SUBPAGE** (No Function)

## 34. ►►

Advance playback rapidly. (DVD / USB mode)

**INDEX** (No Function)

## 35. Coloured buttons

- Access the TELETEXT items (DTV mode)
- Access menu options.

### GOTO (RED)

Skip to a specific location on a DVD / CD. (DVD mode)

### SLOW (GREEN)

Play video slowly. (DVD mode)

### REPEAT (YELLOW)

Select between different repeat modes. (DVD mode)

### A-B (BLUE)

Repeat a segment between A and B. (DVD mode)

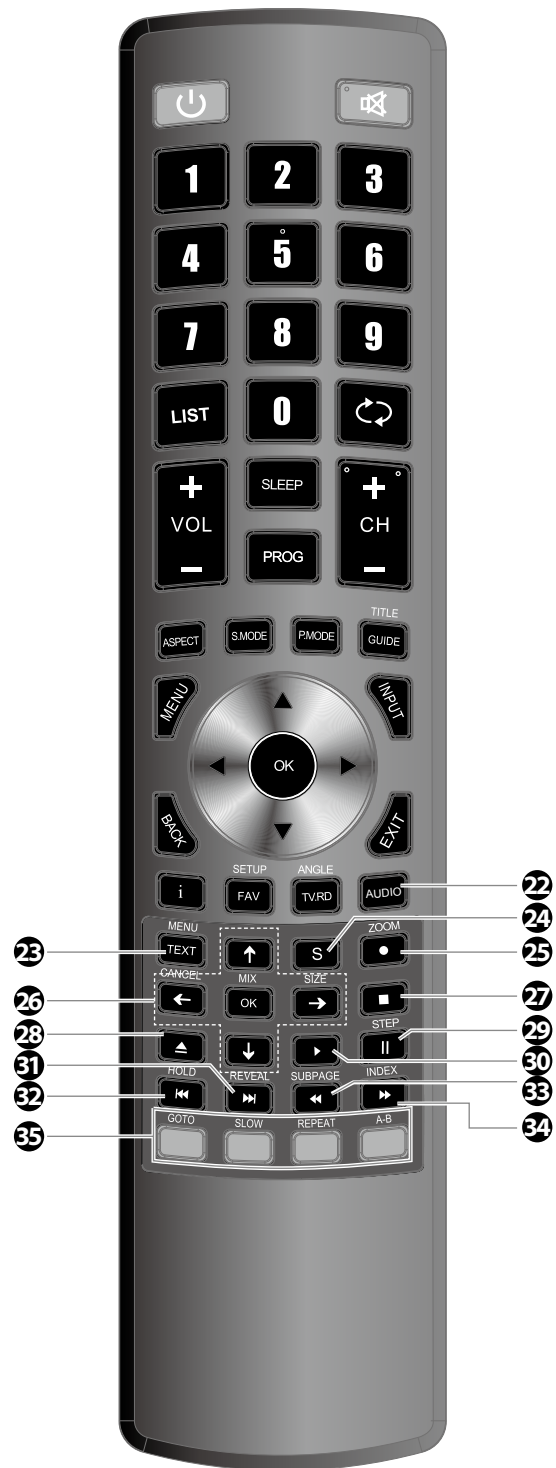









Please note that there are DVD mode functions on the remote control only operate on TV models with a built-in DVD player.

## Making Video and Audio Connections

Not all AV devices have the ability to connect to a TV, please refer to the owner's manual of your AV device for compatibility and connection procedures.

When connecting any external AV device, do not connect the mains cable to the mains socket until all other connections are complete.





Best Video Performance		Signal Type	Separate Audio Connection Required
↑	HDMI1 	HDMI (480i/480p/576i/576p/720p/1080i/1080p)	No
	PC IN 	PC	Yes  PC AUDIO
	Y PB PR 	Component Video (480i/480p/576i/576p/720p/1080i/1080p)	Yes 
	SCART 	SCART (RGB Input)	No
	VIDEO 	Composite Video	Yes 

GB

Connections

## Connecting an AV Device Using an HDMI Cable

- This TV can accept High-Definition Multimedia Interface (HDMI) supports HDCP (High-Bandwidth Digital Content Protection) Protocol.
- This TV has a total of 2 HDMI input sockets, please make sure the correct input source is selected and corresponds to your connected HDMI input socket.
- When you connect to the output of an HD ready player (blu-ray disc player, game console, set-top box or computer) switch to the HDMI function and the TV will automatically detect the resolution used by the HDMI source.
- To get the best picture quality, adjust the blu-ray disc player, game console or set-top box output resolution up to 1920 x 1080p.

- Use an HDMI cable to connect the TV's HDMI input socket to the external AV device's HDMI output socket.
- Plug the connected devices into the mains socket before switching on the TV.
- Press the  button on the rear panel of the TV or on the remote control to turn on your TV.
- Press the  button on the rear panel of the TV or the **INPUT** button on the remote control to display the Source List. Use the   buttons to select **HDMI1** / **HDMI2** and then press the **OK** button to confirm.



Although this TV is able to connect to an HDMI device, it is possible that some devices may not operate correctly.

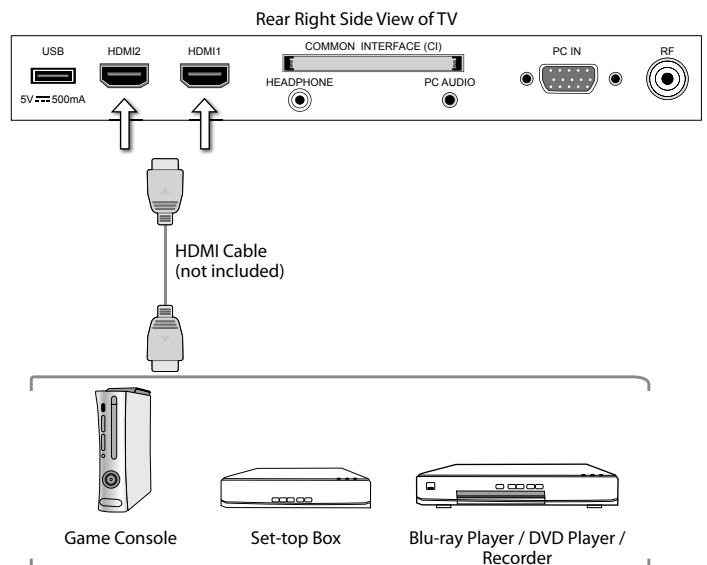



## Connecting a Computer Using a VGA Cable

1. Use a VGA cable to connect the TV's PC IN input socket to a computer's VGA output socket. Use an audio cable to connect the TV's PC AUDIO input socket to the computer's audio output socket.
2. Plug the connected devices into the mains socket before switching on the TV.
3. Press the **⏻** button on the rear panel of the TV or on the remote control to turn on your TV.
4. Press the **⏮** button on the rear panel of the TV or the **INPUT** button on the remote control to display the Source List. Use the **▲▼** buttons to select **PC** and then press the **OK** button to confirm.



- The best resolution is 1920 x 1080.
- If your computer is set to shut down after a few minutes in the idle mode, the TV will also switch to standby due to no signal being received, this is to save energy. Press the **⏻** button on the rear panel of the TV or on the remote control to restart the TV.

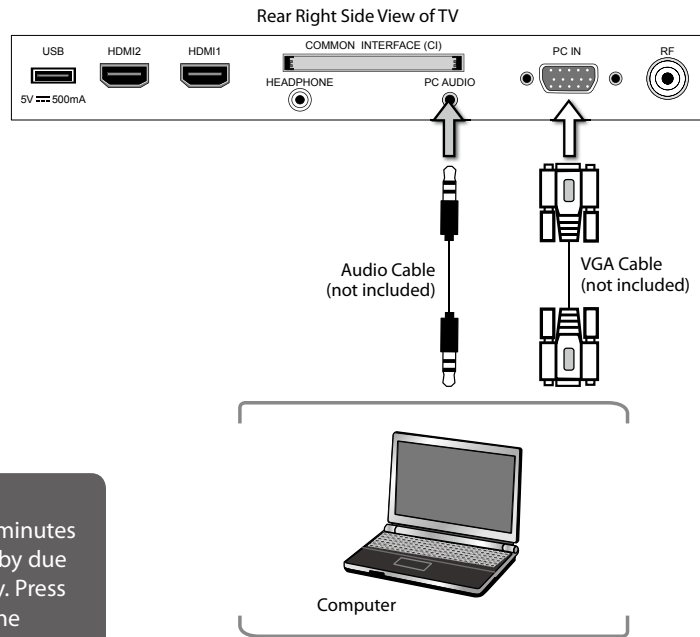

GB

Connections

## Connecting an AV Device Using a Component (YPbPr) Cable

1. Use a component cable to connect the TV's YPbPr input sockets to an external AV device's component output sockets.
2. Use an AV cable to connect the TV's AUDIO(L/R) input sockets to the external AV device's component audio output sockets. (Audio Left = white, and Audio Right = red)

Component port on the TV	Y	Pb	Pr
--------------------------	---	----	----

Video output ports on DVD player	Y	Pb	Pr
	Y	Cb	Cr

3. Plug the connected devices into the mains socket before switching on the TV.
4. Press the **⏻** button on the rear panel of the TV or on the remote control to turn on your TV.
5. Press the **⏮** button on the rear panel of the TV or the **INPUT** button on the remote control to display the Source List. Use the **▲▼** buttons to select **YPbPr** and then press the **OK** button to confirm.

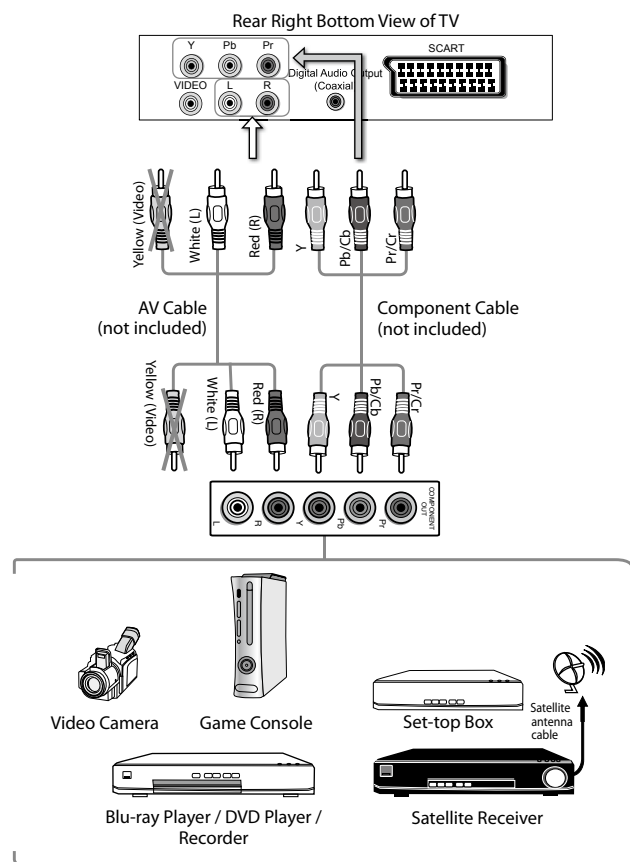

## Connecting an AV Device Using a SCART Cable

1. Use a SCART cable to connect the TV's SCART input socket to an external AV device's SCART output socket.
2. Plug the connected devices into the mains socket before switching on the TV.
3. Press the **⏻** button on the rear panel of the TV or on the remote control to turn on your TV.
4. The TV will change the input source to **SCART** automatically once the AV device is switched on.

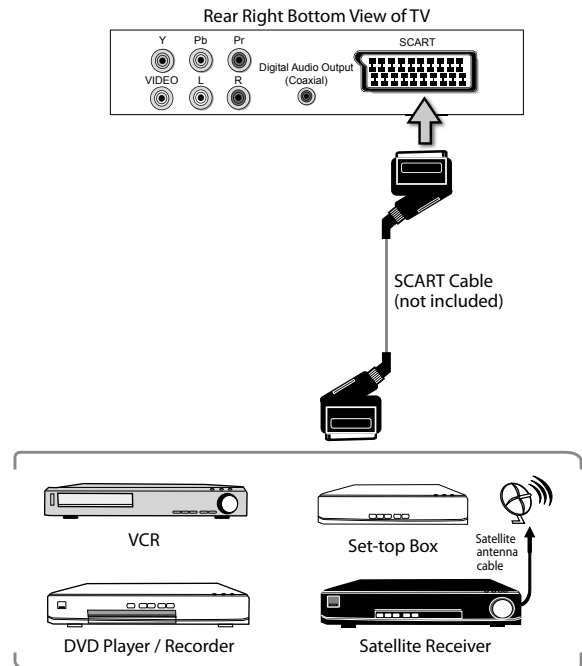

GB

Connections



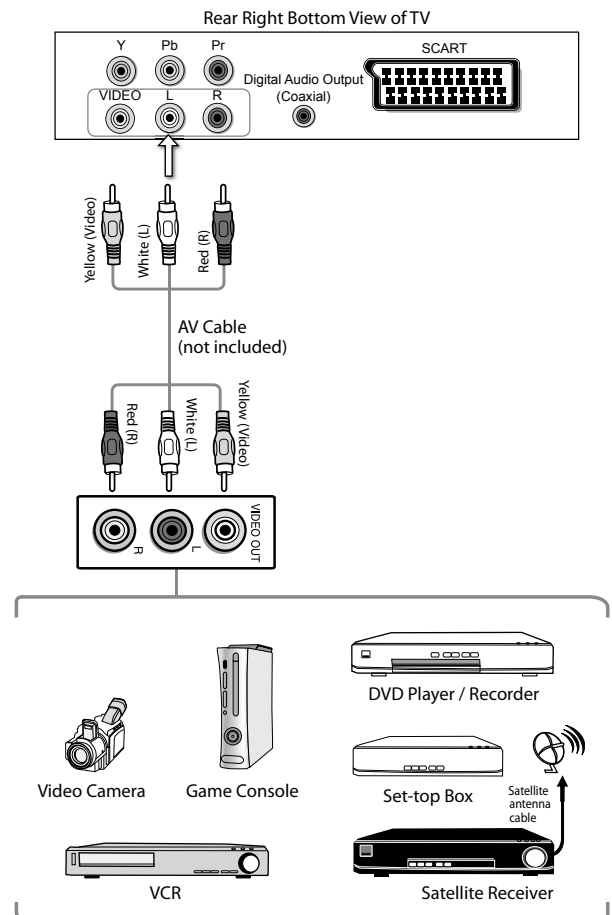

## Connecting an AV Device Using Composite Cable

1. Use an AV cable to connect the TV's AUDIO(L/R) / VIDEO input sockets to the external AV device's composite audio / video output sockets. (VIDEO = yellow, Audio Left = white, and Audio Right = red)
2. Plug the connected devices into the mains socket before switching on the TV.
3. Press the **⏻** button on the rear panel of the TV or on the remote control to turn on your TV.
4. Press the **⏮** button on the rear panel of the TV or the **INPUT** button on the remote control to display the Source List. Use the **▲▼** buttons to select **AV** and then press the **OK** button to confirm.



## Connecting a Audio Receiver

For better sound quality, you may want to play the audio through your multi-channel audio receiver.

1. Use an audio cable (not included) to connect the TV's Digital Audio Output (Coaxial) socket to an external audio receiver's audio coaxial input socket.
2. Plug the connected devices into the mains socket before switching on the TV.
3. Press the  button on the rear panel of the TV or on the remote control to turn on your TV.
4. Press the  button on the rear panel of the TV or the **INPUT** button on the remote control to display the Source List. Use the   buttons on the remote control to select any desired input source and then press the **OK** button to confirm.



The TV's volume will not be affected. You may control the audio level via the Audio Receiver.

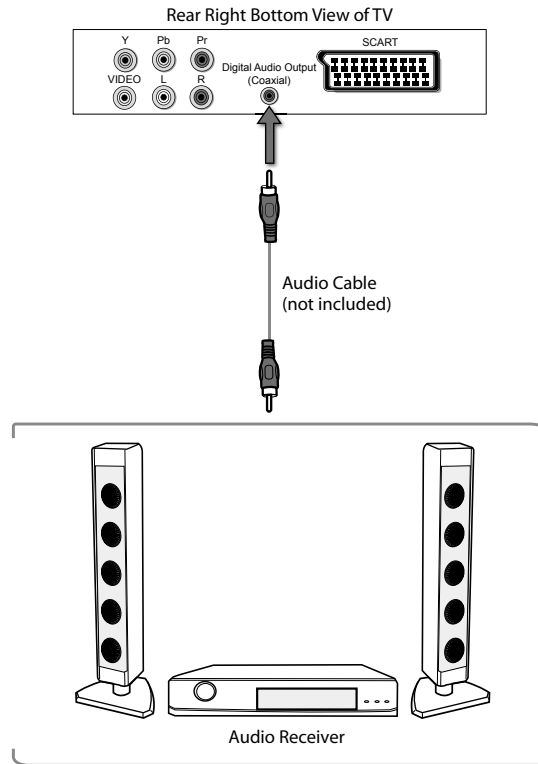

## Connecting Headphones

Connect your headphones to the TV's HEADPHONE socket.

Before putting on the headphones, turn the volume down then put the headphones on and slowly increase the volume until you reach a comfortable listening level.



Long-term exposure to loud music may cause hearing damage. It is best to avoid extreme volume when using headphones, especially for extended periods.

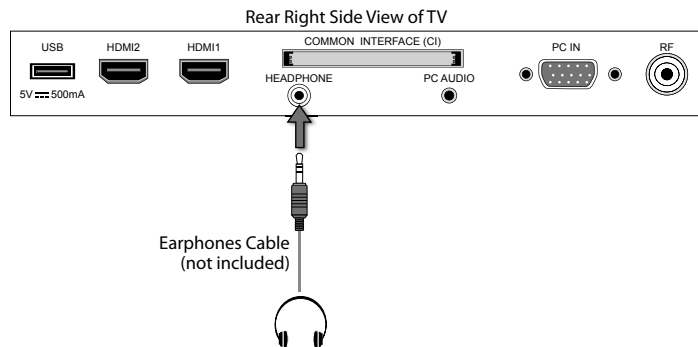

## Turning the TV On for the First Time





If you are going to watch TV using a set-top box, simply connect your TV and set-top box via a HDMI cable and select HDMI in the **Input Source** menu.

1. Connect one end of the RF coaxial cable to the aerial socket on the wall and the other end of the cable to the RF (75Ω) socket at the rear right side of your TV.

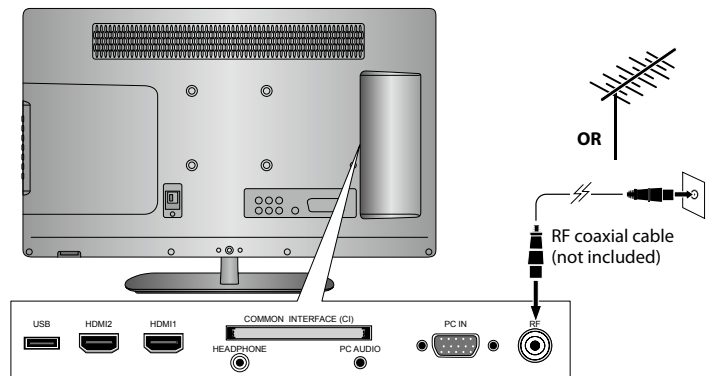

Do not connect the TV to the mains supply until you have completed all the connections.





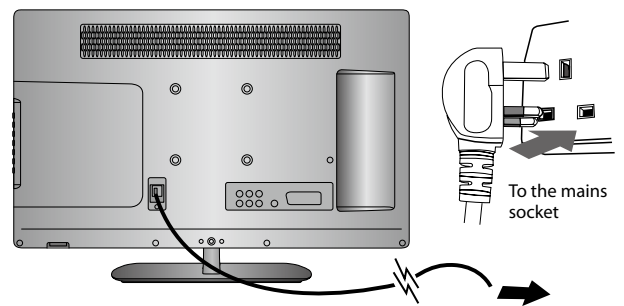

2. Connect the mains cable to the mains socket after you have completed all the connections.
3. At this stage, the TV switches to standby mode. The red LED indicator will illuminate on the front panel of the TV.
4. In standby mode, press the  button on the rear panel of the TV or on the remote control to turn the TV on. The red LED indicator will turn off.



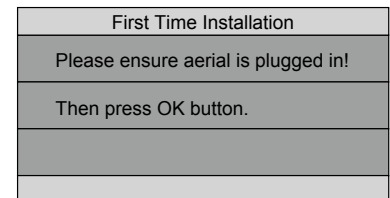



- Always disconnect the TV from the mains socket when not in use for a long period of time.
- The  button on the rear panel of the TV or on the remote control is only used for switching the TV into standby, it does not disconnect the TV from the mains power. To completely disconnect the mains power, please remove the mains plug from the mains socket.

5. The first time you turn the TV on, it will go straight into the **First Time Installation** menu. Please ensure the aerial is plugged in and then press the **OK** button. (If you have already installed the TV using the Quick Start Guide, please go to the section "**Selecting the Input Source**" on the next page.)

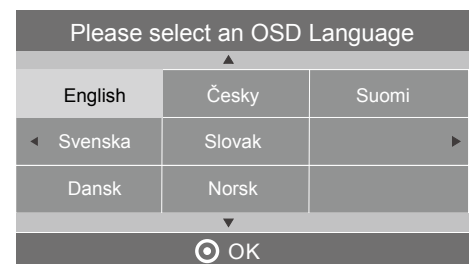

6. Press the     buttons to select your desired language to be displayed on the menu. The default on-screen menu language is set as **English**. Press the **OK** button to confirm.



7. Press the   buttons to select your desired mode and then press the **OK** button. Press the  button to select **Yes** to confirm or the  button to select **No** to cancel and return to the **Mode Select** menu.

<b>Home Mode</b>	Intended for use in home environment.
<b>Shop Mode</b>	Intended for use in retail environment.



- For the best picture quality in your home environment, we recommend setting the TV to **Home Mode**.
- In **Shop Mode**, the default **Picture Mode** under the **Picture** menu is set as **Dynamic** (please refer to p.28 for details) and the **Backlight** is set as 10 (please refer to p.30 for details).

8. In the **Tune Type** menu, press the ◀▶ buttons to select **DTV / ATV / DTV+ATV**. Press the ▼ button and then press the ▲◀▶▼ buttons to select the country where you will operate the TV. Press the **OK** button to confirm.



If you select Ireland as the country where you will operate the TV, a pop-up screen will be display. You will need a 4-digit activation code for Irish tuning. This code can be found in-store, on the back of your receipt (if bought in Ireland), or call the customer service team / **KNOWHOW**.

9. DTV Channel tuning will commence. This operation may take up to 3 minutes. The display will show the progress of the tuning and the number of channels found.
10. If you want to skip the DTV tuning, press the **MENU** button to interrupt the tuning half way. A pop-up screen will be displayed, press the ◀ button to select **YES** to confirm. If you want to go to ATV tuning, please refer to page 23 for details on **Auto Tuning**.
11. After tuning is complete, the channels are arranged in a preset order. If you wish to skip channels, modify the preset order or rename channels, select **Channel Edit** under the **Channel** menu (refer to page 25-26 for details).

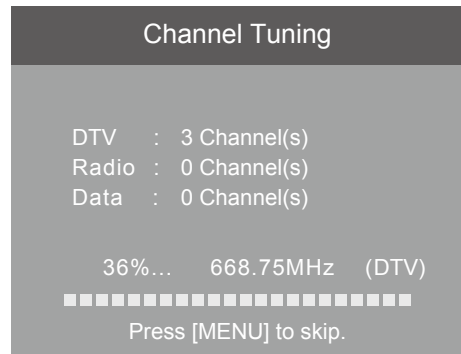
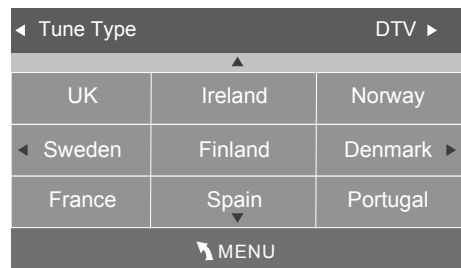

## Target Region Setting (UK Only)

During tuning your TV may have received signals from more than one transmitter. If this has occurred the Target Region Setting screen will be displayed. This will enable you to select the correct regional transmission for the local news service that you require.

Press the ◀▶ buttons to adjust each option's setting and then press the **OK** button to confirm.

<b>Country Code</b>	This will be shown as GBR for the UK.
<b>Primary Region</b>	This will show the regional country (e.g. England, Wales, Scotland, NI).
<b>Secondary Region</b>	This will allow you to set the region for your local news service.
<b>Tertiary Region</b>	You may receive signals from more than one transmitter within the Secondary Region, (e.g Beds and Cambs may have Luton or Sandy Heath).

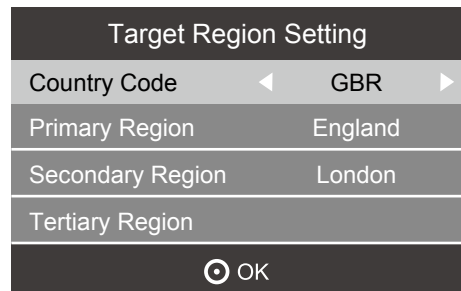

## Selecting the Input Source

- Press the  button on the rear panel of the TV or the **INPUT** button on the remote control to display the Input source list.
- Press the ▲▼ buttons to select the input source that you want: DTV / ATV / AV / SCART / YPbPr / HDMI1 / HDMI2 / PC / USB.
- Press the **OK** button to confirm your selection.



### Alternative

Press the **TV.RD** button to switch to TV / digital radio channels directly.

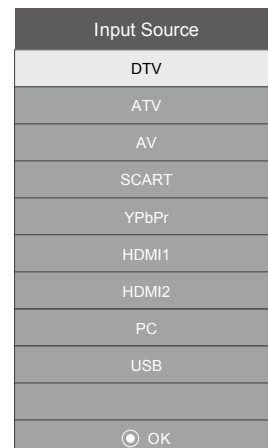

## Channel Selection

- Press the **CH + / -** buttons on the remote control repeatedly or the **0-9** buttons to select the channel.



### Alternative

---

Press the **LIST** button to enter the **Channel List**. Then use the **▲▼** buttons to highlight and select the channel. Press the **OK** button to view the selected channel.

- If a blocked channel is selected, the password screen will be displayed. Press the **0-9** buttons to enter the password, the channel will then be unlocked (refer to page 41 for details on **Block Channel**).
- Press the **FAV** button to view the **Favourite List**. Then use the **▲▼** buttons to highlight and select the channel. Press the **OK** button to view the selected channel (refer to page 25-26 for details on **Channel Edit**).
- Press the  button to return to the previously viewed channel.

## Listening to the Radio (Radio Mode)

- In DTV mode, press the **TV.RD** button to switch between DTV and Digital radio channel.
- Press the **CH ▲ / ▼** buttons on the remote control repeatedly to change the radio stations.



### Alternative

---



Press the **LIST** button to enter the **Channel List**. Then use the **▲▼** buttons to highlight and select the station. Press the **OK** button to listen to the selected station.

- Press the **GUIDE** button to see all the stations in the Programme Guide (refer to page 43 for details on EPG).

## Display Channel Information

- Press the **i** button to view the current information.

## Volume Adjustment

- Press the **VOL +** or **-** button on the side panel of the TV or on the remote control to adjust the volume.
- If you wish to switch the sound off, press the  button. You can turn the volume down while your TV is in mute mode. Press the **VOL -** button, you will see the volume level reduce, but you won't hear anything at the moment. To listen to your TV at the new lower level, press the  button again or **VOL +** button.

# Channel Setting (DTV, TV or Radio Mode)

## Auto Tuning

Use this to automatically find and store all available channels. This is normally recommended if some channels have been added or removed by the broadcaster or if you have moved.

1. Press the **MENU** button and then press the **▲▼** buttons to select the **CHANNEL** menu and then press the **OK** button.



2. Press the **▲▼** buttons to select **Auto Tuning** and then press the **OK** button.

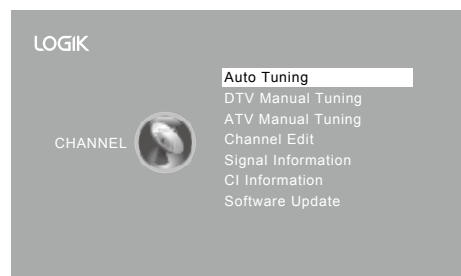

3. In the **Tune Type** menu, press the **◀▶** buttons to select **DTV / ATV / DTV+ATV**. Press the **▼** button and then press the **▲◀▶▼** buttons to select the country where you will operate the TV. Press the **OK** button to confirm.

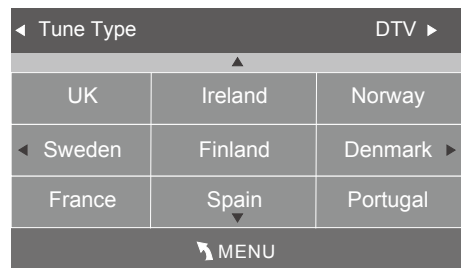

If you select Ireland as the country where you will operate the TV, a pop-up screen will be displayed. You will need a 4-digit activation code for Irish tuning. This code can be found in-store, on the back of your receipt (if bought in Ireland), or call the customer service team / **KNOWHOW**.

4. Channel tuning will commence. This operation may take up to 6 minutes. The display will show the progress of the tuning and the number of channels found.

5. If you want to skip the DTV tuning, press the **MENU** button to interrupt the tuning half way. A pop-up screen will be displayed, press the **◀** button to select **YES** to confirm. You will then go straight to ATV tuning. You may repeat the above step if you also want to skip the ATV tuning.

6. During DTV tuning, your TV may have received signals from more than one transmitter. If this has occurred, the Target Region Setting screen will be displayed. Please refer to the section "**Target Region Setting**" on page 21 for details.

7. After tuning is complete, the channels are arranged in a preset order. If you wish to skip channels, modify the preset order or rename channels, select **Channel Edit** under the channel menu (refer to page 25-26 for details).

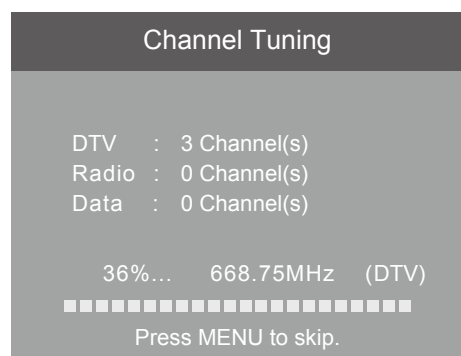

## DTV Manual Tuning (DTV Mode)

Allows you to make manual fine tuning adjustments to the channel under DTV mode.

1. Press the **MENU** button and then press the **▲▼** buttons to select the **CHANNEL** menu and then press the **OK** button.
2. Press the **▲▼** buttons to select **DTV Manual Tuning** and then press the **OK** button.
3. The DTV Manual Tuning screen will pop up. Press the **◀▶** buttons to select the desired UHF channel and then press the **OK** button to commence the search of that channel. When the signal has been tuned, the picture and signal strength will be displayed on the screen.
4. Press the **MENU** button to return to the main menu.
5. Press the **EXIT** button to exit the menu.

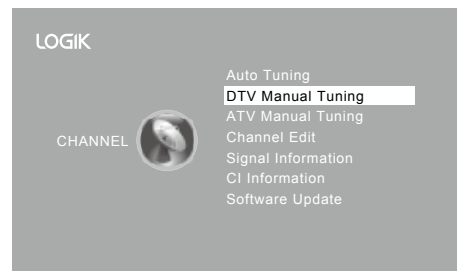

## ATV Manual Tuning (ATV Mode)

Allows you to make manual fine tuning adjustments if the channel reception is poor under ATV mode.

1. Press the **MENU** button and then press the **▲▼** buttons to select the **CHANNEL** menu and then press the **OK** button.
2. Press the **▲▼** buttons to select **ATV Manual Tuning** and then press the **OK** button.

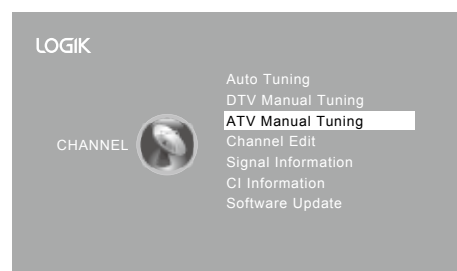
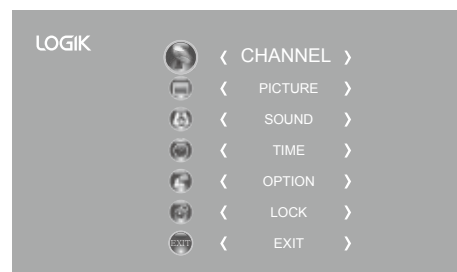



3. The ATV Manual Tuning screen will pop up. Use the ▲▼ buttons to select the following options and the ◀▶ buttons to adjust the setting.

<b>Storage To</b>	Presets the channel number.
<b>System</b>	Selects the system: I / DK / L (for SECAM) / BG.
<b>Current CH</b>	Displays the current channel number.
<b>Search</b>	Press the ◀▶ buttons to start the manual tuning.
<b>Fine-Tune</b>	Press the ◀▶ buttons to make manual fine tuning adjustments.
<b>Frequency</b>	Displays the current tuned frequency.

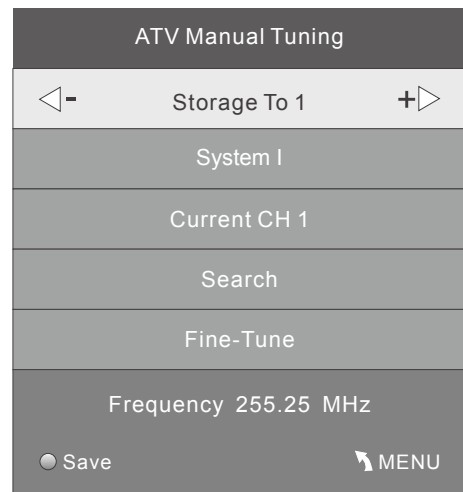

4. After finishing the manual tuning adjustment of a channel, press the **RED** button to save your channel before tuning the next channel.
5. Press the **MENU** button to return to the main menu.
6. Press the **EXIT** button to exit the menu.

## Channel Edit (DTV / ATV Mode)

Allows you to edit TV channel information in the Channel List.

1. Press the **MENU** button and then press the ▲▼ buttons to select the **CHANNEL** menu and then press the **OK** button.



2. Press the ▲▼ buttons to select **Channel Edit** and then press the **OK** button.

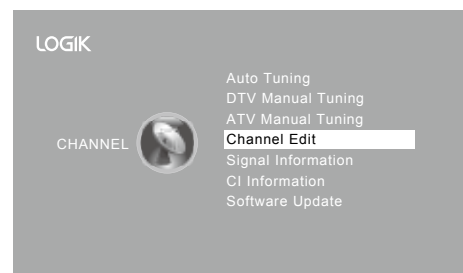

3. A Channel Edit screen will pop up. Press the ▲▼ buttons to select the programme you want to edit.



All channels (DTV and ATV) are listed, please ensure that you edit the correct channel.

**a. Delete**

Press the **RED** button to delete the selected channel.

**b. Rename (ATV channels)**

Press the **GREEN** button to rename the selected channel. Press the ▲▼ buttons to select the characters to represent the station name. Press the ◀▶ buttons to move to the next character and then press the **GREEN** button again to confirm the new name.

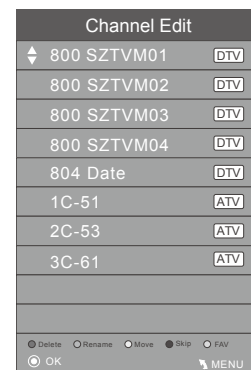

**c. Move**

Press the **YELLOW** button and then press the **▲▼** buttons to move to the selected channel. Press the **YELLOW** button or the **OK** button to confirm.

**d. Skip**

Press the **BLUE** button to skip the selected channel. Press the **BLUE** button again to undo it.

**e. FAV (Favourite)**

Press the **FAV** button to set the selected channel as one of the favourite programmes. Press the **FAV** button again to undo it.

4. Press the **MENU** button to return to the main menu.

5. Press the **EXIT** button to exit the menu.



Care should be taken when editing the position of digital channels as this may affect EPG and reminder settings.

## Signal Information (DTV Mode)

Allows you to view the signal information.

1. Press the **MENU** button and then press the **▲▼** buttons to select the **CHANNEL** menu and then press the **OK** button.

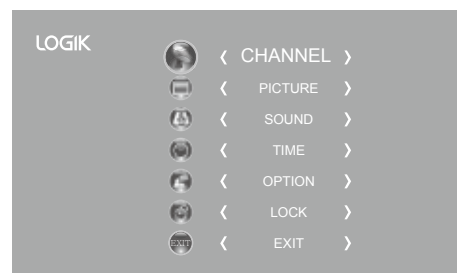

2. Press the **▲▼** buttons to select **Signal Information** and then press the **OK** button to view the signal information.

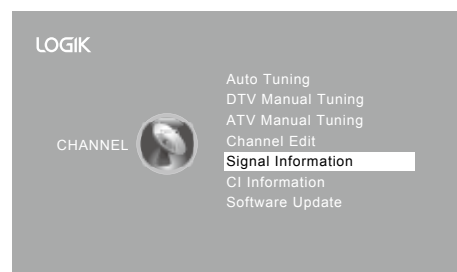

3. Press the **BACK** button to return to the previous menu or press the **MENU** button to return to the main menu.

4. Press the **EXIT** button to exit the menu.

Signal Information	
Channel	52
Network	SZTVM
Modulation	16QAM
Quality	99
Strength	81

## CI (Common Interface) (DTV Mode)

The common interface allows the use of a Common Access Module to enable you to view scrambled (pay to view) services. These services are provided by TopUp TV (UK only) and others. The Common Access Module and viewing card can be obtained from the service provider.



Do not repeatedly insert or remove the Common Access Module as this may damage the interface and cause a malfunction.

This feature is not available in all countries.

### To insert the Common Access Module

1. Before you insert the Common Access Module, ensure that the TV is switched off and the viewing card is inserted **in accordance with the Service Provider's instructions**.
2. Insert the Common Access Module into the slot. Flip the Common Access Module to another side and try again if you feel resistance.
3. Switch the TV on.

### To remove the Common Access Module

1. Before you remove the Common Access Module, ensure that the TV is switched off.
2. Pull the Common Access Module from the slot.
3. Switch the TV on.

### To view the module information

1. Press the **MENU** button and then press the **▲▼** buttons to select the **CHANNEL** menu and then press the **OK** button.
2. Press the **▲▼** buttons to select **CI Information** and then press the **OK** button.
3. A CI Information Main menu will pop up. Press the **▲▼** buttons to display the module information, smart card information, language, software download. Press the **OK** button to confirm.
4. Press the **EXIT** button to return to the previous menu. Press the **EXIT** button again to exit the menu.



This screen is for illustration only.

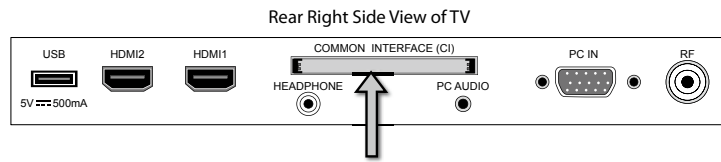

### CI (Common Interface)

Allows the Common Access Module to be inserted and access the content that has been encrypted.

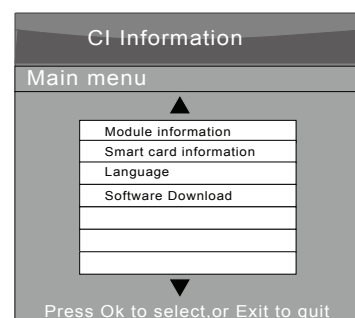
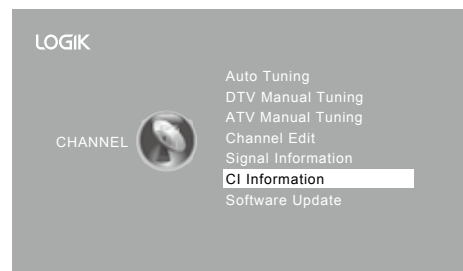
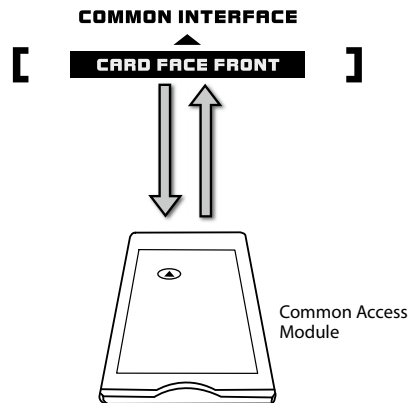

# Software Update

## Software Update (USB)

This function is only for servicing purposes. Any update information for this TV (if any) will be available at the following website:

- For UK, [www.knowhow.com](http://www.knowhow.com) or call our UK Call Centre on **0344 561 1234**.
- For Ireland, [www.knowhow.ie](http://www.knowhow.ie) or call our Ireland Call Center on **1 890 818 575**.

## Software Update (Over Air Download)

The TV auto detects the latest firmware through the DTV signal and allows you to accept or refuse the firmware upgrade service.

1. Press the **MENU** button and then press the **▲▼** buttons to select the **CHANNEL** menu and then press the **OK** button.

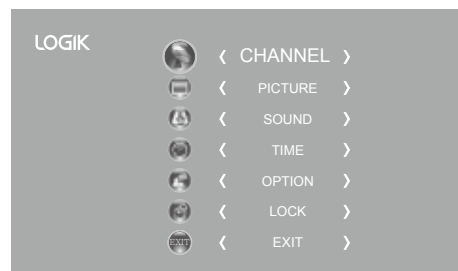

2. Press the **▲▼** buttons to select **Software Update** and then press the **OK** button to confirm.

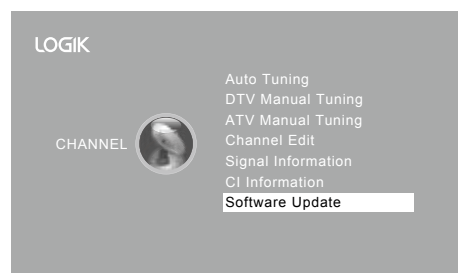

3. Press the **▲▼** buttons to select **Software Update(OAD)** and then press the **OK** button to select **On**.

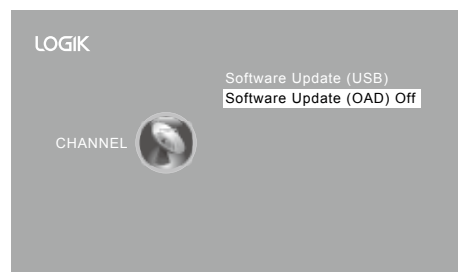

4. Press the **BACK** button to return to the previous menu or press the **MENU** button to return to the main menu.

5. Press the **EXIT** button to exit the menu.

6. During normal DTV viewing, if the TV detects the latest firmware from the DTV signal, the Over Air Download screen will appear. Press the **◀▶** buttons to select **Yes / No** for the upgrade procedure.



7. If you select **Yes**, the over air download will start. Press the **EXIT** button if you want to stop the download and exit the menu.



During download, please do not turn off or unplug your TV.

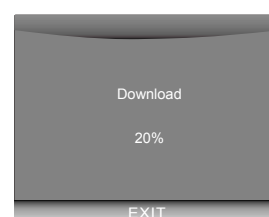

- When the download is complete, the TV will automatically upgrade the software.
- When the update is complete, the TV will return to standby mode.
- Press the **⏻** button on the rear panel of the TV or on the remote control to switch on the TV.

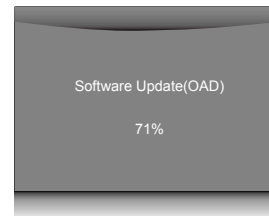

If you experience difficulties after the software update, we recommend that you restore your TV to the factory default settings. To do this, follow the steps below:

- Press the **MENU** button to go to the **MAIN** menu. Press the **▲▼** buttons to select **OPTION** and then press the **OK** button.
- Press the **▲▼** buttons to select **Restore Factory Default** and then press the **OK** button. Press the **◀** button to select **Yes** to reset the setting.
- The TV will restore all settings and go to the First Time Installation. Follow the **First Time Installation** steps (refer to page 20-22 for details).

## Picture Setting

Allows you to set your preferred picture mode.

- Press the **MENU** button and then press the **▲▼** buttons to select the **PICTURE** menu and then press the **OK** button.





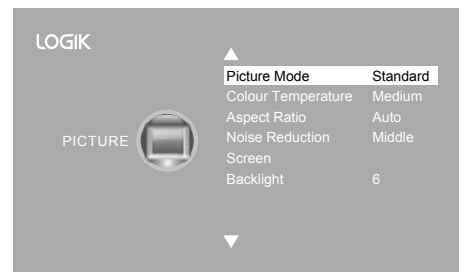





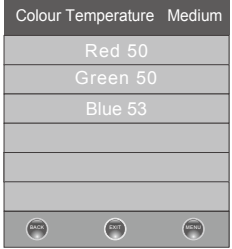

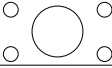

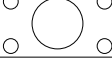

- Press the **▲▼** buttons to select the following picture options and then press the **OK** button.

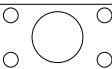
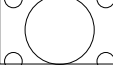
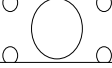

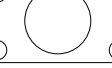
- Press the **▲▼** buttons to select the options. Press the **OK** button and then press the **◀▶** buttons to adjust each option's setting.

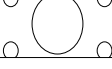
<b>Picture Mode</b>	Select among picture mode: Standard / Mild / User / Dynamic.	
	<b>Alternative</b> _____ You may press the <b>P.MODE</b> button to select the picture mode directly.	
<b>Contrast</b>	Adjusts the difference between light and dark levels in the picture (for User mode).	
<b>Brightness</b>	Increases or decreases the amount of white in the picture (for User mode).	
<b>Colour</b>	Controls the colour intensity (for User mode).	
<b>Sharpness</b>	Adjusts the level of crispness in the edges between light and dark areas of the picture (for User mode).	
<b>Tint</b> (For NTSC format)	Adjusts the balance between red and green levels (Tint is only available for NTSC signal reception).	

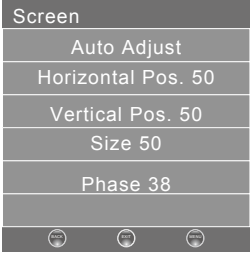
<p><b>Colour Temperature</b></p>	<p>Select among colour temperature: Medium / Warm / User / Cool. Adjusts the colour components independently to achieve a warm or cool colour (for User mode).</p> <ul style="list-style-type: none"> <li>• <b>Red:</b> Increases red tint</li> <li>• <b>Green:</b> Increases green tint</li> <li>• <b>Blue:</b> Increases blue tint</li> </ul>			
<p><b>Aspect Ratio</b></p>	<p>Allows you to watch the screen in various picture formats: Auto / 4:3 / 16:9 / Full / Zoom / Subtitle / Smart Zoom.</p> <p> <b>Alternative</b> _____</p> <p>You may press the <b>ASPECT</b> button to select the aspect ratio directly.</p>			
	<p><b>Input Signal 4:3</b></p>	<p><b>Input Signal 16:9</b></p>		
<p><b>Auto</b></p>	<p>This selection will display the picture according to the aspect ratio of the input source. Black bars will appear on both the left and right of the screen.</p>		<p>This selection will display the picture according to the aspect ratio of the input source.</p>	
<p><b>4:3</b></p>	<p>This selection will allow you to view a picture with an original 4:3 aspect ratio. Black bars will appear on both the left and right of the screen.</p>		<p>This selection will allow you to adjust the picture vertically, in linear proportion. Black bars will appear on both the left and right of the screen.</p>	
<p><b>16:9</b></p>	<p>This selection will allow you to adjust the picture horizontally, in linear proportion, to fill the entire screen.</p>		<p>This selection will allow you to view a picture with an original 16:9 aspect ratio.</p>	
<p><b>Full</b> (DTV mode, HDMI mode and YPbPr mode only)</p>	<p>This selection will detect the resolution of the HDMI signal and display an image with the same number of pixels.</p>		<p>This selection will detect the resolution of the HDMI signal and display an image with the same number of pixels.</p>	
<p><b>Zoom</b></p>	<p>This selection will allow you to zoom in the picture without any alteration, while filling the entire screen. However, the top and bottom of the picture will be cropped.</p>		<p>This selection will allow you to zoom in the picture without any alteration, while the 4 sides of the picture will be cropped.</p>	
<p><b>Subtitle</b></p>	<p>This selection will allow you to zoom in the picture without any alteration, while filling the entire screen with subtitles shown at the bottom of the screen.</p>		<p>This selection will allow you to zoom in the picture without any alteration, while showing subtitles at the bottom of the screen.</p>	
<p><b>Smart Zoom</b></p>	<p>This selection is similar to 16:9 mode, but the picture slightly stretches horizontally and clips off a little from the top and bottom.</p>		<p>This selection is similar to 4:3 mode, but the picture slightly stretches vertically and clips off a little from the top and bottom.</p>	
<p><b>Noise Reduction</b></p>	<p>Select to reduce the noise level of the connected device: <b>Off / Low / Middle / High.</b></p>			

<b>Screen</b>	Allows you to adjust the PC desktop content. (PC mode only)		
	<b>Auto Adjust</b>	Allows you to synchronise a PC signal automatically.	
	<b>Horizontal Pos.</b>	Adjusts the position of the picture left and right in the window.	
	<b>Vertical Pos.</b>	Adjusts the position of the picture up and down in the window.	
	<b>Size</b>	Allows you to adjust the picture horizontally, in linear proportion.	
	<b>Phase</b>	Controls the signal phase, which can improve focus clarity and image stability based on the PC mode.	
<b>Backlight</b>	Allows you to adjust the backlight setting of your TV. This controls the brightness and display performance of the screen. The default setting for <b>Home Mode</b> is 6 and <b>Shop Mode</b> is 10.		
	 <p>Increasing the backlight setting will increase the brightness and display performance of the screen. The higher the setting is, the higher the power consumption. You can select from 1-10 to strike a balance between the picture brightness / display performance / power consumption. Reducing the backlight setting will help you reduce power consumption and thus save money by reducing electricity bills.</p>		

4. Press the **BACK** button to return to the previous menu or press the **MENU** button to return to the main menu.
5. Press the **EXIT** button to exit the menu.

## Sound Setting

Allows you to select an audio-enhancement technique.

1. Press the **MENU** button and then press the **▲▼** buttons to select the **SOUND** menu and then press the **OK** button.

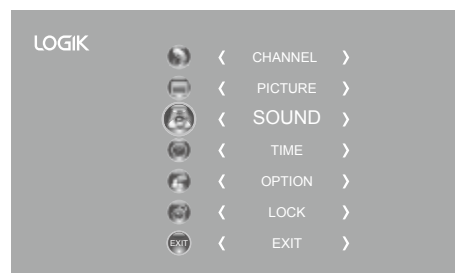

2. Press the **▲▼** buttons to select the following sound options and then press the **OK** button.

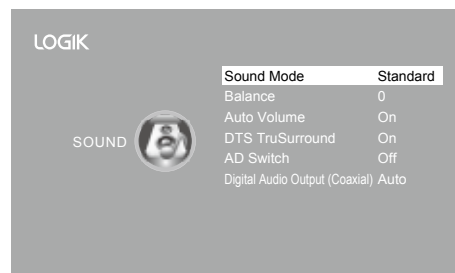

3. Press the ▲▼ buttons to select the options. Press the **OK** button and then press the ◀▶ buttons to adjust each option's setting.

<b>Sound Mode</b>	You can select this function when DTS TruSurround switch off. Allows the selection of an audio-enhancement technique: <b>Standard / Music / Movie / Sports / User</b> .	
	 <b>Alternative</b> You may press the <b>S.MODE</b> button to select the sound mode directly.	
	<b>Treble</b>	Controls the relative intensity of higher pitched sounds (for User mode).
	<b>Bass</b>	Controls the relative intensity of lower-pitched sounds (for User mode).
<b>Balance</b>	Adjusts the relative volume of the speakers in a multiple speaker system.	
<b>Auto Volume</b>	Volume levels are automatically controlled (e.g., advertisements tend to be louder than the programmes).	
<b>DTS TruSurround</b>	DTS TruSurround delivers an immersive virtual surround sound experience over front facing speaker configurations, complete with rich bass, high frequency detail and clear dialogue. Press the <b>OK</b> button to select <b>On / Off</b> .	
<b>AD Switch (for DTV mode)</b>	Audio Description is an auxiliary audio function that provides an additional audio track for visually challenged persons. This function handles the Audio Stream for the AD (Audio Description), when it is sent along with the main audio from the broadcaster. <ul style="list-style-type: none"> <li>• Set to "<b>Off</b>" for normal broadcasting sound coming out from speakers.</li> <li>• Set to "<b>On</b>" to activate the description sound track if available. The availability of Audio Description sound track is indicated by the visually impaired icon "<b>V.I.</b>" in the information banner.</li> </ul>	
<b>Digital Audio Output (Coaxial)</b>	Selects the digital audio output mode. Press the <b>OK</b> button to select <b>PCM / Auto</b> .	

4. Press the **BACK** button to return to the previous menu or press the **MENU** button to return to the main menu.
5. Press the **EXIT** button to exit the menu.

## Stereo / Dual Sound Reception (ATV Mode)

When a programme is selected, press the **AUDIO** button to display the sound information for the selected station.

Broadcast	On Screen Display
Mono	MONO / NICAM MONO
Stereo	MONO / NICAM STEREO
Dual	MONO / NICAM DUAL I, NICAM DUAL II, NICAM DUAL I+II

### Mono sound selection

If the stereo signal is weak, you can switch to mono by pressing the **AUDIO** button. In mono reception, the clarity of sound is improved. To switch back to stereo, press the **AUDIO** button again.

### Language selection for dual language broadcast

If a programme can be received in two languages (dual language), you can switch to **NICAM DUAL I**, **NICAM DUAL II**, **NICAM DUAL I+II** or **MONO** by pressing the **AUDIO** button repeatedly.

NICAM DUAL I	Sends the primary broadcast language to the loudspeakers
NICAM DUAL II	Sends the secondary broadcast language to the loudspeakers
NICAM DUAL I+II	Sends the primary and secondary broadcast languages to the loudspeakers



## Speaker Sound Output Selection (DTV Mode)

While watching a DTV programme, you can press the **AUDIO** button to display the audio language list (only applicable when the TV programme has this feature).

Press the **▲▼** buttons to select an audio language or audio format if available and then press the **◀▶** buttons to select sound track between L/R (Stereo), L/L (Mono Left) and R/R (Mono Right). Press the **OK** button to confirm and exit.

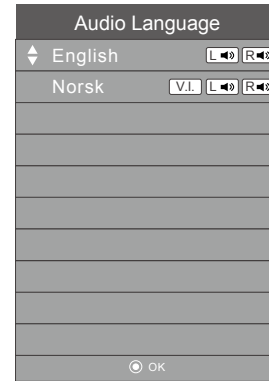

## Time Settings

Allows you to adjust power on / off time, sleep timer, auto standby and time zone.

1. Press the **MENU** button and then press the **▲▼** buttons to select the **TIME** menu and then press the **OK** button.



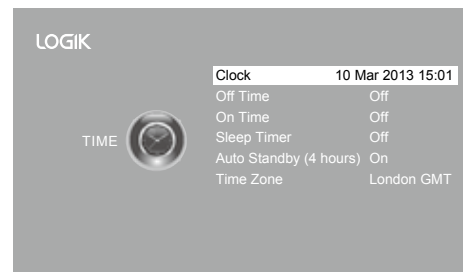

2. Press the **▲▼** buttons to select the following time options and then press the **OK** button.



3. Press the **▲▼** buttons to select the options. Press the **OK** button and then press the **◀▶** buttons to adjust each option's setting.

<b>Clock</b>	The clock is set automatically when receiving a digital signal.
<b>Off Time</b>	Allows you to set the off time that will automatically switch off the TV. Select from the following off time options: Off / Once / Every Day / Mon.~Fri. / Mon.~Sat. / Sat.~Sun. / Sunday.
<b>On Time</b>	Allows you to set the on time that will automatically switch on the TV and tune to the source, channel and volume you select. Select from the following on time options: Off / Once / Every Day / Mon.~Fri. / Mon.~Sat. / Sat.~Sun. / Sunday.

Ensure your SCART device is turned off before entering the **On Time** menu. If your SCART device is turned on, the **On Time** menu will default to the SCART device.

<b>Sleep Timer</b>	<p>The sleep timer automatically switches the TV to standby after the preset time has elapsed. The clock will be set automatically when receiving a digital signal. Time must be set before using Sleep Timer function.</p> <p>Press the ▲▼ buttons to select a period of time after which the TV automatically switches to standby mode: OFF / 10 / 20 / ... / 180 / 240 min. The timer begins to count down from the number of minutes selected.</p> <p> If you turn the TV off after setting the sleep timer, the sleep timer setting will be erased.</p> <p> <b>Alternative</b></p> <ol style="list-style-type: none"> <li>1. You may press the <b>SLEEP</b> button repeatedly to select the number of minutes: OFF / 10 / 20 / ... / 180 / 240 min directly.</li> <li>2. To cancel the sleep time, press the <b>SLEEP</b> button repeatedly until Off appears.</li> </ol>
<b>Auto Standby (4 hours)</b>	<p>The unit will automatically switch to standby mode 4 hours after the last time the remote control was used. A reminder screen will pop up and count down before the unit switches to standby mode. To turn off the auto standby function, press the <b>MENU</b> button to display the main menu. Press the ▲▼ buttons to select the <b>Time</b> option and then press the <b>OK</b> button. Press the ▲▼ buttons to select the <b>Auto Standby</b> option and then press the <b>OK</b> button to select "Off". Press the <b>EXIT</b> button to exit the main menu. To save energy you should always turn the auto standby function back to "ON".</p>
<b>Time Zone</b>	<p>When you select a Time Zone, the TV time is set by the time offset information based on Time Zone and GMT (Greenwich Mean Time) which is received with the broadcast signal and the time is set automatically by a digital signal.</p>

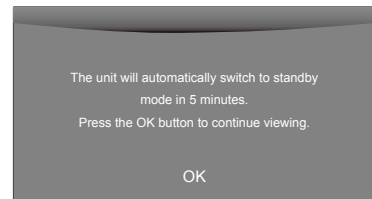

4. Press the **BACK** button to return to the previous menu or press the **MENU** button to return to the main menu.
5. Press the **EXIT** button to exit the menu.

## Option Setting

### OSD Language

Allows you to select your desired on screen menu language.

1. Press the **MENU** button and then press the ▲▼ buttons to select the **OPTION** menu and then press the **OK** button.

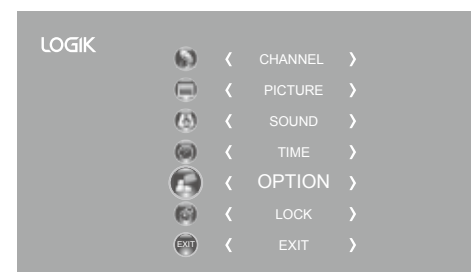

2. Press the ▲▼ buttons to select **OSD Language** and then press the **OK** button. The default on-screen menu language is English.



3. Press the ▲◀▶▼ buttons to navigate the menu and change the settings. Press the **OK** button to confirm.
4. Press the **BACK** button to return to the previous menu or press the **MENU** button to return to the main menu.
5. Press the **EXIT** button to exit the menu.

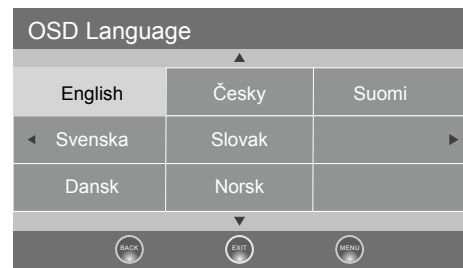

## Audio Language (DTV Mode)

Allows you to select your desired audio language. (Available for digital channels if multiple audio languages are broadcast.)

1. Press the **MENU** button and then press the ▲▼ buttons to select the **OPTION** menu and then press the **OK** button.
2. Press the ▲▼ buttons to select **Audio Language** and then press the **OK** button. The default audio language is English.
3. Press the ◀▶ buttons to select the Primary / Secondary Audio Language. Press the ▼ button and then press the ▲◀▶▼ buttons to select your desired audio language. Press the **OK** button to confirm.
4. Press the **BACK** button to return to the previous menu or press the **MENU** button to return to the main menu.
5. Press the **EXIT** button to exit the menu.

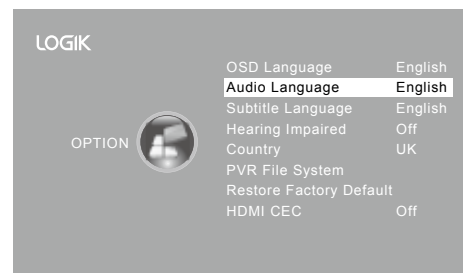

## Subtitle Language (DTV Mode)

Allows you to select your desired subtitle language or turn off the subtitle. (Available for digital channels if multiple subtitle languages are broadcast.)

1. Press the **MENU** button and then press the ▲▼ buttons to select the **OPTION** menu and then press the **OK** button.



- Press the ▲▼ buttons to select **Subtitle Language** and then press the **OK** button. The default subtitle language is English.

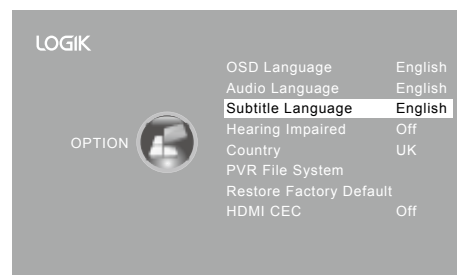

- Press the ◀▶ buttons to select the Primary / Secondary Subtitle Language. Press the ▼ button and then press the ▲◀▶▼ buttons to select your desired subtitle language. Press the **OK** button to confirm.
- Press the **BACK** button to return to the previous menu or press the **MENU** button to return to the main menu.
- Press the **EXIT** button to exit the menu.



While watching a DTV programme, you can press the **S** button on the remote control to display the **Subtitle Language List** and then press the ▲▼ buttons to select the **Subtitle Language OFF**. Press the **OK** button to confirm. (Only applicable when the TV programme has this feature.)

## Hearing Impaired

Shows information for the hearing-impaired in some programmes. (For DTV channels only if available.)

- Press the **MENU** button and then press the ▲▼ buttons to select the **OPTION** menu and then press the **OK** button.

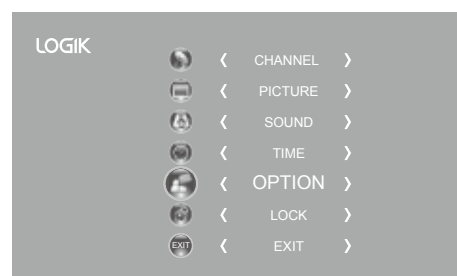

- Press the ▲▼ buttons to select **Hearing Impaired** and then press the **OK** button to select **On / Off**.
- Press the **BACK** button to return to the previous menu or press the **MENU** button to return to the main menu.
- Press the **EXIT** button to exit the menu.

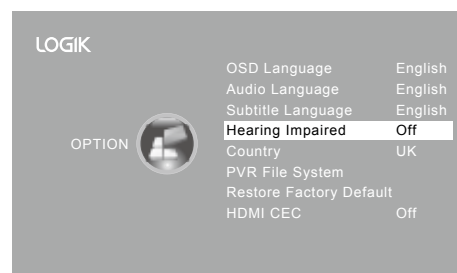

## Country

This shows the country you selected in auto tuning. If you want to change the country, please refer to **Auto Tuning** on page 23.

## PVR File System (DTV Mode)

Allows you to select your preferences in the PVR File System.

1. Press the **MENU** button and then press the **▲▼** buttons to select the **OPTION** menu and then press the **OK** button.



2. Press the **▲▼** buttons to select **PVR File System** and then press the **OK** button.



3. Press the **▲▼** buttons to select the following PVR File System options and then press the **OK** button.

<b>Select Disk</b>	Select the disk where you want to store your recorded content.	
<b>Check PVR File System</b>	Press the <b>OK</b> button, the system will now check your USB device's suitability for PVR. The system will show " <b>Checking</b> ". Upon completion, the system will show either " <b>SUCCESS</b> " or " <b>FAIL</b> ".	
<b>USB Disk</b>	If no USB storage device is connected, it will show " <b>No USB Disk</b> ". If the <b>Check PVR File System</b> has a " <b>SUCCESS</b> " it will show " <b>Pass</b> ".	
<b>Format</b>	Press the <b>OK</b> button, a <b>File System Size</b> menu will pop-up. Press the <b>◀▶</b> buttons to select your preferred file type between <b>FAT32</b> and <b>HiSpeed FS</b> . If you select <b>HiSpeed FS</b> , press the <b>▼</b> button and then press the <b>◀▶</b> buttons to select your preferred file size. Press the <b>OK</b> button to confirm and then press the <b>◀</b> button to start formatting.	
<b>Time Shift Size</b>	After formatting the Time Shift Size menu will appear if you have selected <b>HiSpeed FS</b> in <b>PVR File System Type</b> . Press the <b>◀▶</b> buttons to select your preferred file size. Press the <b>OK</b> button to confirm. This option cannot be chosen if you have selected <b>FAT32</b> in <b>PVR File System Type</b> .	
<b>Speed</b>	This shows the transfer rate of your USB storage device.	
<b>Free Record Limit</b>	Press the <b>◀▶</b> buttons to set the recording time limit from 1-4 hours.	

## Restore Factory Default

Restores all settings to the factory defaults.

1. Press the **MENU** button and then press the **▲▼** buttons to select the **OPTION** menu and then press the **OK** button.



2. Press the **▲▼** buttons to select **Restore Factory Default** and then press the **OK** button.



3. Press the **◀** button to select **"Yes"**. The TV will turn off and restart after a few seconds. Press the **▶** button to select **"No"** to cancel and return to the main menu.



All channel and user settings will be lost and the TV will revert to "First Time Installation".

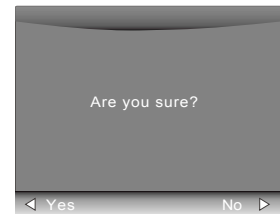

## HDMI CEC (Consumer Electronics Control)

Allows you to command and control two or more CEC-enabled devices, that are connected through HDMI, by using only one of the remote controls (e.g. controlling a TV set, set-top box and DVD player using only the remote control of the TV). CEC also allows individual CEC-enabled devices to command and control each other without user intervention.

Make sure that your CEC-compliant device is connected to your TV using a HDMI cable and the correct HDMI input source is selected prior to using this function. (Some HDMI cables may not support HDMI-CEC functions.)

### HDMI-CEC Connection

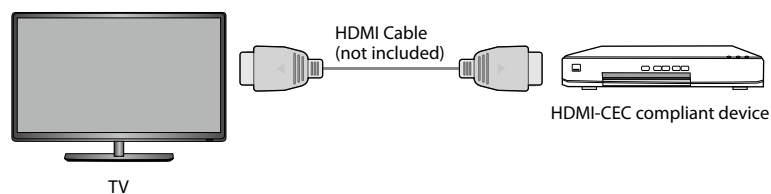

1. Press the **MENU** button and then press the **▲▼** buttons to select the **OPTION** menu and then press the **OK** button.



2. Press the **▲▼** buttons to select **HDMI CEC** and then press the **OK** button to select **On / Off**.
3. Press the **BACK** button to return to the previous menu or press the **MENU** button to return to the main menu.
4. Press the **EXIT** button to exit the menu.



- This unit can only communicate with HDMI-CEC compatible devices.
- To be sure that the HDMI-CEC device has this feature, check to see if there is HDMI-CEC compatible logo on it.
- HDMI-CEC function only works when the AV device supporting CEC is turned on.

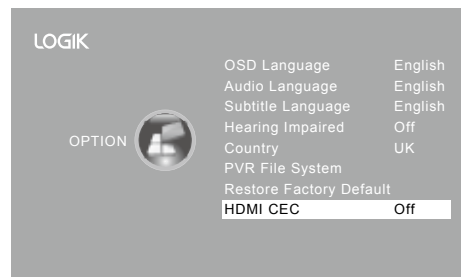

## Lock Setting

To access the **LOCK** menu, you must enter the password. Enter the default password "**6666**" for first time use. To change the password, refer to the section "**Change Password**".

### Lock System

The Lock System is designed to prevent accidental re-tuning of the TV / losing of channels and to prevent children from watching unsuitable programmes.

The Lock System must be set to On for this function to operate. If the Lock System is set to On, a valid password must be entered when you access Auto Tuning / Manual Tuning / Restore Factory Default.

1. Press the **MENU** button and then press the **▲▼** buttons to select the **LOCK** menu and then press the **OK** button.



2. Press the **OK** button to select **Lock System**.

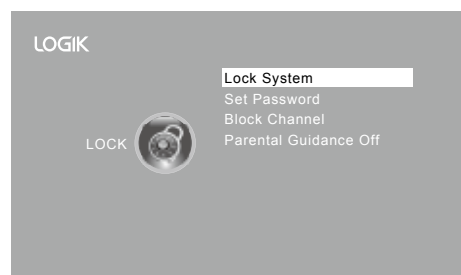

3. Use the **0-9** buttons to input a 4-digit password to enter the **LOCK** menu.



The default password is "**6666**".  
If you change the password, be sure to remember the new password! If you forget the new password, enter the master password "**9527**".



- Press the **▲▼** buttons to select **Lock System** and then the **OK** button to select **On / Off**.  
If the Lock System is set to On, a valid password must be entered when you access Auto Tuning / Manual Tuning / Restore Factory Default.
- Press the **BACK** button to return to the previous menu or press the **MENU** button to return to the main menu.
- Press the **EXIT** button to exit the menu.

## Set Password

- Press the **MENU** button and then press the **▲▼** buttons to select the **LOCK** menu and then press the **OK** button.

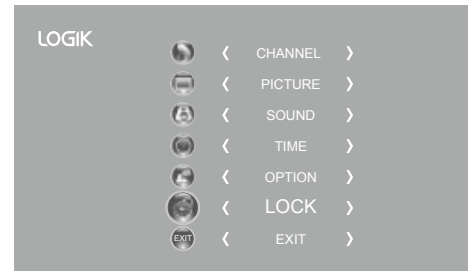

- Press the **OK** button to select **Lock System**.

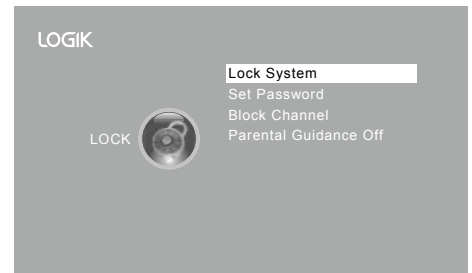

- Use the **0-9** buttons to input a 4-digit password to enter the **LOCK** menu.



The default password is "6666".  
If you change the password, be sure to remember the new password! If you forget the new password, enter the master password "9527".

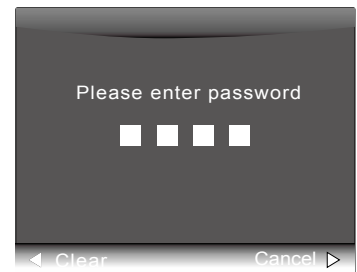

- Press the **▲▼** buttons to select **Set Password** and then press the **OK** button.

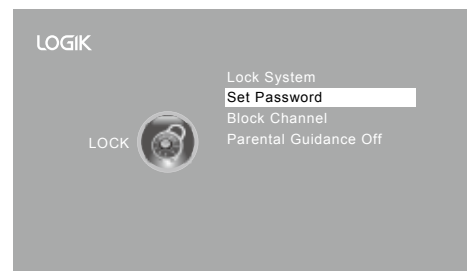

- Use the **0-9** buttons to input the old password and then input the new 4-digit password. Re-enter new password for confirmation.



The default password is "6666".  
If you change the password, be sure to remember the new password! If you forget the new password, enter the master password "9527".

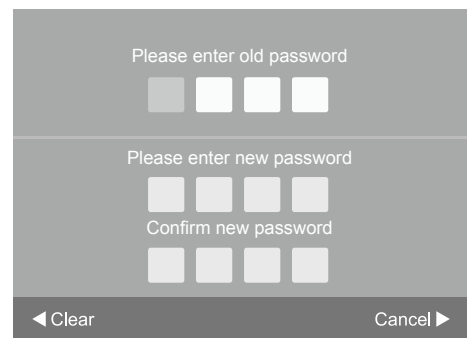

- Press the **▶** button to return to the previous menu. Press the **MENU** button to return to the main menu.
- Press the **EXIT** button to exit the menu.



## Block Channel

Block Channel is designed to prevent children from watching unsuitable programmes.

When a channel is blocked, a valid password must be entered.

1. Press the **MENU** button and then press the **▲▼** buttons to select the **LOCK** menu and then press the **OK** button.



2. Press the **OK** button to select **Lock System**.

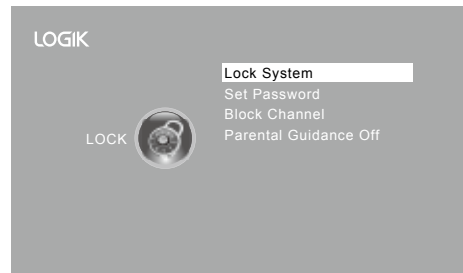

3. Use the **0-9** buttons to input a 4-digit password to enter the **LOCK** menu.



The default password is "6666".  
If you change the password, be sure to remember the new password! If you forget the new password, enter the master password "9527".



4. Press the **▲▼** buttons to select **Block Channel** and then press the **OK** button.

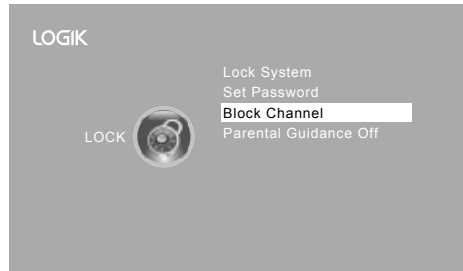

5. A Block Channel screen will pop up. Press the **▲▼** buttons to select a channel. Press the **GREEN** button on the remote control to block or unblock the channel. Press the **GREEN** button again to unblock.

6. Press the **MENU** button once to return to the previous menu. Press the **MENU** button again to return to the main menu.

7. Press the **EXIT** button to exit the menu.

Block Channel	
800 SZTVM01	DTV
800 SZTVM02	DTV
800 SZTVM03	DTV
800 SZTVM04	DTV
804 Date	DTV
1C-51	ATV
2C-53	ATV
3C-61	ATV
Lock / Unblock	
OK	MENU

## Parental Guidance

This function allows you to set up blocking schemes to block specific channels and ratings. It operates according to information from the broadcasting station, therefore if the signal has incorrect information, this function will not operate.

This TV is programmed to remember the last option set even if the TV is switched off.

When a programme is locked or rated, a valid password must be entered.

1. Press the **MENU** button and then press the **▲▼** buttons to select the **LOCK** menu and then press the **OK** button.

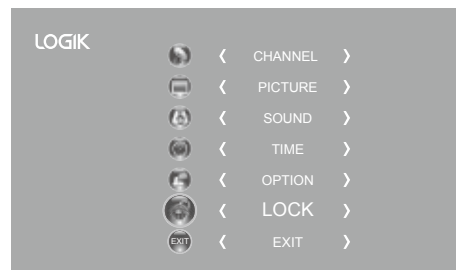

2. Press the **OK** button to select **Lock System**.

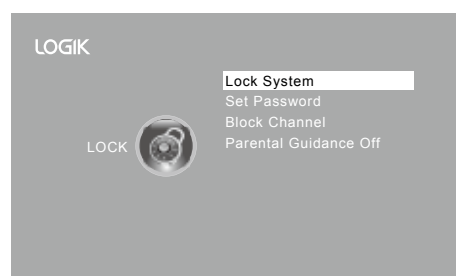

3. Use the **0-9** buttons to input a 4-digit password to enter the **LOCK** menu.



The default password is "6666".  
If you change the password, be sure to remember the new password! If you forget the new password, enter the master password "9527".



4. Press the **▲▼** buttons to select **Parental Guidance** and then press the **OK** button.

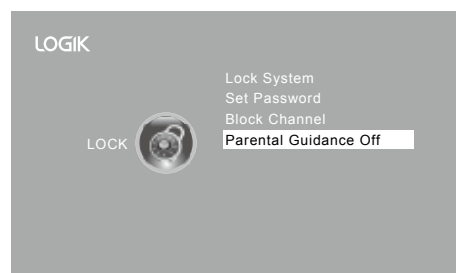

5. Press the **▲▼** buttons to select an age rating: Off, 4-18. Then press the **OK** button to confirm.
6. Press the **BACK** button to return to the previous menu or press the **MENU** button to return to the main menu.
7. Press the **EXIT** button to exit the menu.

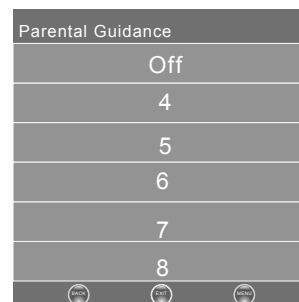

# EPG (Electronic Programme Guide) (DTV Mode)

This system has an Electronic Programme Guide (EPG) to help you navigate through all the possible viewing options.

The EPG supplies information such as programme listings, start and end times for all available services. In addition, detailed information about the programme is often available in the EPG (the availability and amount of programme information will vary, depending on the particular broadcaster).

This function can be used only when the EPG information is broadcast by broadcasting companies.

The EPG displays the programme details for the next 7 days.

## Switch On / Off EPG

1. Press the **GUIDE** button to switch on EPG.
2. Press the **GUIDE** button or the **EXIT** button again to switch off EPG and return to normal TV viewing.

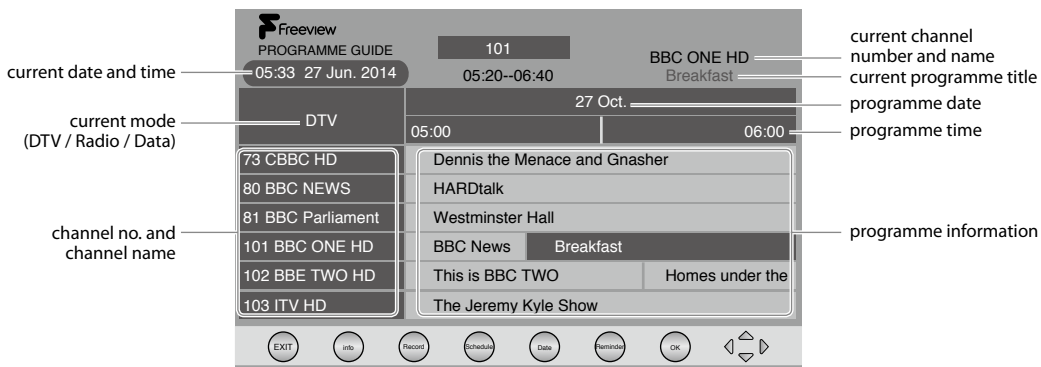

**GB**  
Using the Features

## Select a Programme

Press the **▲▼** buttons to select the desired channel and then press the **◀▶** buttons to select the desired programme. Press the **OK** button to confirm.

## Button Functions in a 7-Day Guide

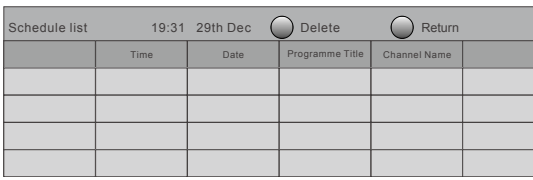
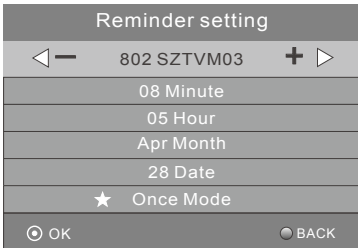
Remote Control Button	Function
<b>RED</b> (Record)	<ul style="list-style-type: none"> <li>• <b>Timer Programming</b> See page 51 for details on <b>Timer Programming</b>.</li> <li>• Press the <b>RED</b> button in the <b>Schedule list</b> to delete the selected preset reminder.</li> </ul>
<b>GREEN</b> (Schedule)	<p>Press the <b>GREEN</b> button to view the preset reminders or scheduled recordings in the <b>Schedule list</b>. Press the <b>GREEN</b> button again to return to the EPG.</p> 
<b>YELLOW</b> (Date)	<p>Press the <b>YELLOW</b> button and then press the <b>◀▶</b> buttons to view the schedule of the previous / next day. Press the <b>YELLOW</b> button again to return to the EPG.</p>
<b>BLUE</b> (Remind)	<p>Press the <b>BLUE</b> button while on the selected programme, the <b>Reminder setting</b> menu will be displayed. Press the <b>▲◀▶▼</b> buttons to adjust the settings and then press the <b>OK</b> button to confirm the settings. After confirmation, the <b>Schedule list</b> will then be displayed with your preset reminders shown. Press the <b>GREEN</b> button to return to the EPG. The TV will automatically tune to the selected programme when it starts.</p> 
<b>i</b>	Press to display detailed information of the selected programme (if available).
<b>▲</b> or <b>▼</b>	Press to select a channel.
<b>◀</b> or <b>▶</b>	Press to select a programme.
<b>OK</b>	Press to confirm and view the selected channel.
<b>GUIDE / EXIT</b>	Press to switch off the EPG.

## Red Button (Interactive Services)

Red button services are available on BBC TV and Radio channels. The services are gradually changing to an internet based service rather than the conventional over air (though your aerial). To make the most out of the Red Button services make sure your TV is connected to the internet.

### Accessing the Information

1. In DTV mode press the **TEXT** button to display the main information page. You may see slightly different looking pages depending if your TV is accessing the page over air or via the internet.
2. Follow the instructions on the interactive services page and move around the page by pressing the **▲◀▶▼**, **OK**, **RED**, **GREEN**, **YELLOW**, **BLUE** or **0-9** buttons etc.

To change digital teletext services, you will need to exit the current text service and change channels. Then enter the text service on the newly selected channel.



Over Air Red Button Services

GB

Using the Features



### Alternative

You may press the **RED** button to display the interactive services information when you see a red "press ●" logo in the top right corner of the screen (e.g. BBC services). This will now display the Red Button menu and available information categories.

To access the pages, use navigation buttons to highlight item required and press the **OK** button to select.

Follow on screen prompts for other functions.

3. Press the **TEXT** button to exit.

## Connecting a USB Storage Device

1. Switch off the TV before connecting any USB storage device.
2. Connect your USB storage device to the USB port of your TV.
3. Plug the connected devices into the mains socket before switching on the TV.
4. Press the **Power** button on the rear bottom panel of the TV or on the remote control to turn on your TV and your USB storage device.
5. Press the **Source** button on the rear panel of the TV or the **INPUT** button on the remote control to display the Source List. Use the **Up/Down** buttons to select **USB** and then press the **OK** button to confirm.

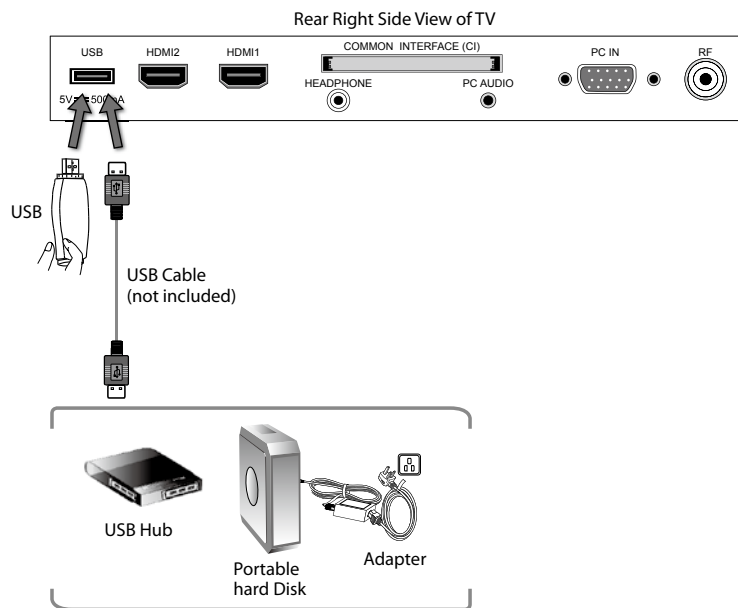

- If a hard disk is used, make sure its mains adapter is connected to the mains supply.
- If a USB hub is used, make sure its mains adapter is connected to the mains supply as the total current consumption may exceed 500mA.
- The maximum supported storage space of the hard disk is 1 TB.
- The file system only supports FAT32 format.
- If you want to store the video streaming of a DTV programme, the transfer rate of the USB storage device must not be less than 5MB/s, otherwise the picture and sound of the programme will be affected and a warning statement will be shown on the screen. If this happens, please upgrade your USB storage device.
- The TV screen will be blank temporarily as it will take time to start up and stabilise the connected hard disk. This is normal and the starting time may vary depending on the brand and the memory size of the connected hard disk.
- Disconnect the USB storage device if it is not in use.
- Supports USB2.0 only.

## Viewing Photos

1. Press the **Source** button on the rear panel of the TV or the **INPUT** button on the remote control then press the **Up/Down** buttons to select the **USB** mode and then press the **OK** button.
2. Press the **Left/Right** buttons to select **PHOTO** and then press the **OK** button.
3. Press the **Left/Right** buttons to select your storage device and then press the **OK** button.

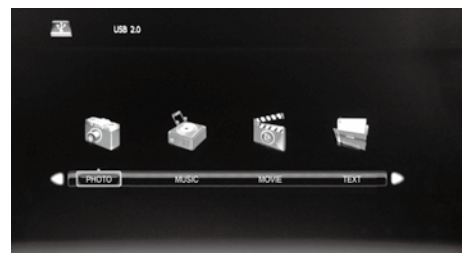

- Press the ▲◀▶▼ buttons to navigate in the picture folder and then press the **OK** button.

If you want to select the specified photos, press the ▲◀▶▼ buttons to select the picture file and then press the **OK** button. A tick box will be displayed. If you want to delete the file, press the **RED** button to enter the **Sub Menu**, press the ◀▶ buttons to select **Delete** and then press the **OK** button to confirm.



Supported file formats: JPG.

- Press the **PLAY** button to view.
- Press the **OK** button or the **i** button to display the function bar. Press the ◀▶ buttons and then press the **OK** button to select the function: Pause / Prev. / Next / Stop / Repeat (Repeat All / Repeat Off / Repeat 1) / Music / Playlist / Info. / Rotate / Zoom In / Zoom Out / Move View.



If this folder also contains music files, you can select a music track to play at the same time you view your photos.

- Press the **EXIT** button to return to the previous menu.

## Listening to Music

- Press the  button on the rear panel of the TV or the **INPUT** button on the remote control then press the ▲▼ buttons to select the **USB** mode and then press the **OK** button.
- Press the ◀▶ buttons to select **MUSIC** and then press the **OK** button.
- Press the ◀▶ buttons to select your storage device and then press the **OK** button.



- Press the ▲◀▶▼ buttons to navigate in the music folder and then press the **OK** button.

If you want to select the specified music, press the ▲◀▶▼ buttons to select the music file and then press the **OK** button. A tick box will be displayed. If you want to delete the file, press the **RED** button to enter the **Sub Menu**, press the ◀▶ buttons to select **Delete** and then press the **OK** button to confirm.



- Some audio file formats will not be supported.
- Supported file formats: mp3.

- The music information (Album / Title / Bit Rate / Artist / Sampling / Year / Size) will be displayed. Press the **PLAY** button to play.

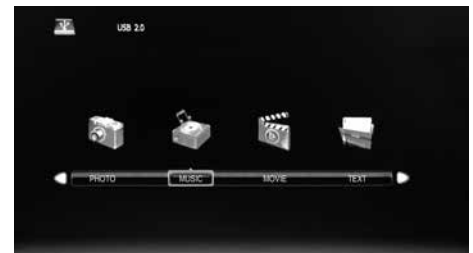

- Press the **OK** button or the **i** button to display the function bar. Press the **◀▶** buttons and then press the **OK** button to select the function: Pause / FB / FF / Prev. / Next / Stop / Repeat (Repeat All / Repeat Off / Repeat 1) / Mute / Playlist / Goto Time.
- Press the **EXIT** button to return to the previous menu.



## Viewing Movies

- Press the **⏪** button on the rear panel of the TV or the **INPUT** button on the remote control then press the **▲▼** buttons to select the **USB** mode and then press the **OK** button.
- Press the **◀▶** buttons to select **MOVIE** and then press the **OK** button.
- Press the **◀▶** buttons to select your storage device and then press the **OK** button.
- Press the **▲◀▶▼** buttons to navigate in the movie folder and then press the **OK** button.

If you want to select the specified movie, press the **▲◀▶▼** buttons to select the movie file and then press the **OK** button. A tick box will be displayed. If you want to delete the file, press the **RED** button to enter the **Sub Menu**, press the **◀▶** buttons to select **Delete** and then press the **OK** button to confirm.



- Some video file formats will not be supported.
- Supported file formats: MPEG1/2.

- Press the **▶** **PLAY** button to view.
- Press the **OK** button or the **i** button to display the function bar. Press the **◀▶** buttons and then press the **OK** button to select the function: Pause / FB / FF / Prev. / Next / Stop / Repeat (Repeat All / Repeat Off / Repeat 1) / Set A / Playlist / Info / Aspect Ratio.
- Press the **EXIT** button to return to the previous menu.

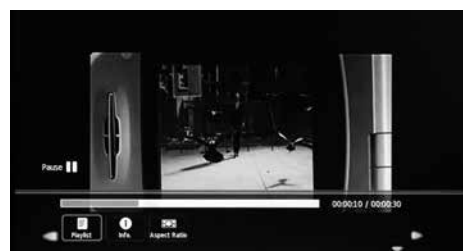
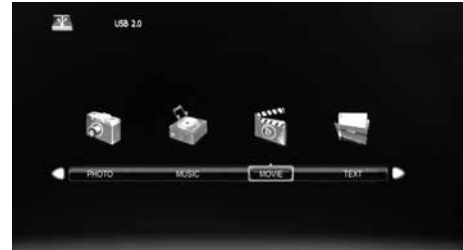

## My Text

1. Press the **INPUT** button on the rear panel of the TV or the **INPUT** button on the remote control then press the **▲▼** buttons to select the **USB** mode and then press the **OK** button.
2. Press the **◀▶** buttons to select **TEXT** and then press the **OK** button.

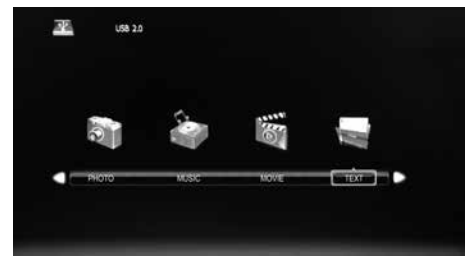

3. Press the **◀▶** buttons to select your storage device and then press the **OK** button.



4. Press the **▲◀▶▼** buttons to navigate in the text folder and then press the **OK** button.

If you want to select the specified text file, press the **▲◀▶▼** buttons to select the text file and then press the **OK** button. A tick box will be displayed. If you want to delete the file, press the **RED** button to enter the **Sub Menu**, press the **◀▶** buttons to select **Delete** and then press the **OK** button to confirm.



5. Press the **▶** **PLAY** button to view.
6. Press the **OK** button or the **i** button to display the function bar. Press the **◀▶** buttons and then press the **OK** button to select the function: Prev. page / Next page / Prev. / Next / Stop / Music / Playlist / Info.
7. Press the **EXIT** button to return to the previous menu.





## Time Shift Function

This function allows you to pause live TV. The picture will pause and the programme will begin recording so you will not miss any of the programme. You need to have a USB storage device attached to the USB socket for Time Shift Recording to work.



- Time Shift Mode and Recording functions may not work if the signal strength is weak.
- Stop the time shift function before switching to another input source.



If the transfer rate of the USB storage device is too slow for recording or time shift function, a warning statement will be shown on the screen. If this happens, please upgrade your USB storage device. The minimum transfer speed is 5MB/s.

During normal TV viewing, you may press the **PAUSE** button to pause the live programme if you want to go out for a while (e.g. going to the bathroom / kitchen). "II" will show on the screen.

When you have returned, press the **PLAY** button to play the missed broadcast programme. "▶" will show on the screen and the PVR Time Shift progress bar will be displayed on the screen.

The video and sound may have a little bit of delay or be out-of-sync for a few seconds when the unit starts to playback the missed broadcast programme. It will soon turn to normal.

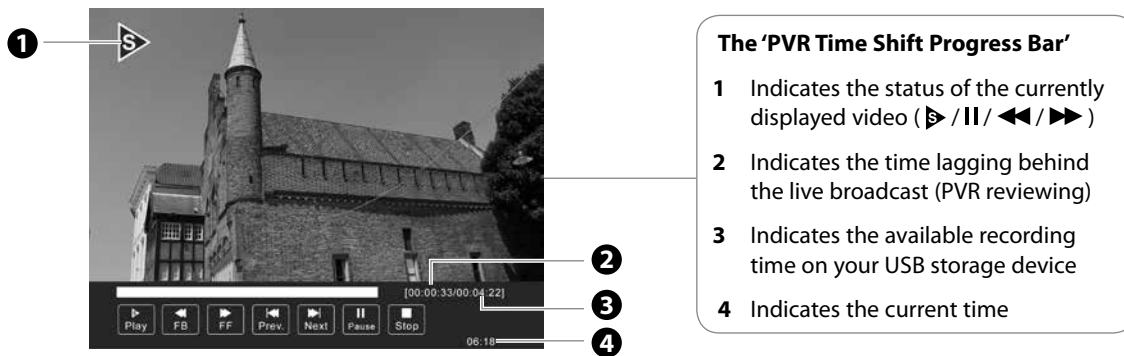

### The 'PVR Time Shift Progress Bar'

- 1 Indicates the status of the currently displayed video (▶ / II / ◀◀ / ▶▶)
- 2 Indicates the time lagging behind the live broadcast (PVR reviewing)
- 3 Indicates the available recording time on your USB storage device
- 4 Indicates the current time

## Using the Remote Control

You can shift playback to any point of the virtually recorded programme. The PVR Time Shift progress bar will be displayed on the screen for 15 seconds. Press the **OK** button to display the PVR Time Shift progress bar again.

◀◀ or ▶▶	<p>When playing,</p> <ul style="list-style-type: none"> <li>• Press the ◀◀ button repeatedly to speed up ◀◀ x 2 / x 4 / x 8 / x 16.</li> <li>• Press the ▶▶ button repeatedly to speed up ▶▶ x 2 / x 4 / x 8 / x 16.</li> <li>• During fast forward / fast backward state, press the <b>PLAY</b> button to return to normal playback.</li> </ul>
◀◀◀ or ▶▶▶	<ul style="list-style-type: none"> <li>• Press the ▶▶▶ button to jump about 10% forward.</li> <li>• Press the ◀◀◀ button to jump about 10% back.</li> </ul>
<b>PLAY</b> or II	<ul style="list-style-type: none"> <li>• During playback, press the II button to display a still screen and then press the <b>PLAY</b> button again to resume playback.</li> <li>• During fast forward / fast backward state, press the <b>PLAY</b> button to return to normal playback.</li> </ul>
<b>OK</b>	<p>During playback, press the <b>OK</b> button to display a still screen and then press the ▶II button again to resume playback.</p>
■	<p>If you want to exit the PVR Time Shift progress bar and return to the current live broadcast, press the ■ button.</p>

## Recording DTV Programme onto a USB Storage Device

Use this function to record the DTV programme you are watching on the main screen and save it for future viewing.

The recording from timer programme or direct recording may have a little bit of delay when it starts to record the broadcast programme.

Please make sure the USB device is inserted. If not, a warning message will pop up.

1. Press the **●** button to record the programme that you are currently watching.
2. Press the **●** button again, the recording progress bar will disappear.
3. Press the **■** button to stop recording.



Recording will stop automatically when the disk is full.



If you want to turn off your TV during recording, press the **⏻** button on the rear panel of the TV or on the remote control. A dialogue will display.

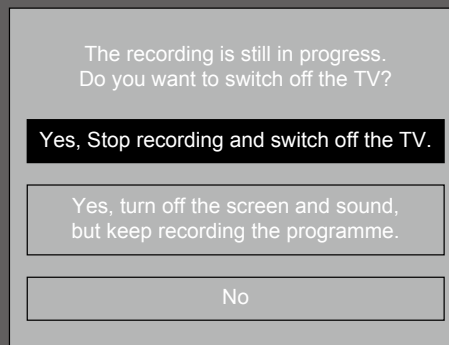

Press the **▲▼** buttons to select your desired option and then press the **OK** button to confirm.

If you select the middle option in the box, the screen will turn off but the recording will still be in progress, the LED indicator will alternatively flash red.

# Timer Programming

This function is used to perform scheduled recording.

The recording from timer programme or direct recording may have a little bit of delay when it starts to record the broadcast programme.

Please make sure the USB device is inserted. If not, a warning message will pop up.

1. Press the **GUIDE** button on the remote control. The **EPG** menu will appear.

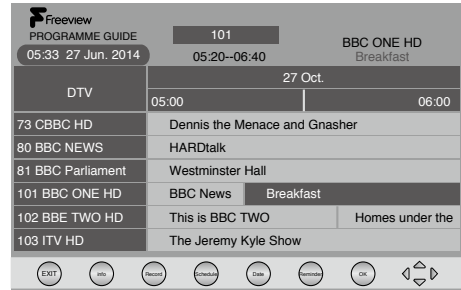

2. Press the **RED** button on the remote control while on the selected programme, the **RECORDER** menu will be displayed. Press the **▲◀▶▼** buttons to select the settings in the **RECORDER** menu for the Channel, Start time, End time and Mode.

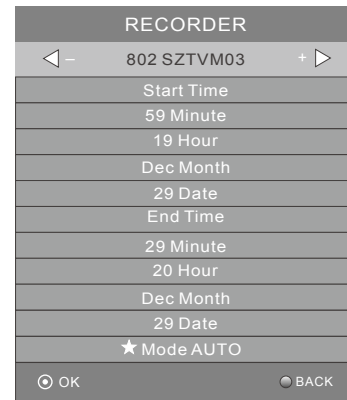

<b>Channel</b>	Press the <b>◀▶</b> buttons to select the channel that you want to record.
<b>Start time</b> (for Mode Once, Every Day, Weekly)	Press the <b>▲▼</b> buttons to select the Minutes / Hour / Month / Date and then press the <b>◀▶</b> buttons to adjust the start time.
<b>End time</b> (for Mode Once, Every Day, Weekly)	Press the <b>▲▼</b> buttons to select the Minutes / Hour / Month / Date and then press the <b>◀▶</b> buttons to adjust the end time.
<b>Mode</b>	Press the <b>◀▶</b> buttons to select the Auto / Once / Every Day / Weekly.

3. After finishing all the recorder adjustments, press the **OK** button to confirm your settings.





- After confirmation, you can press the **GREEN** button to view your scheduled recording in the **Schedule list**.
- If a programme recording starts when the TV is in standby mode, the LED indicator will flash red.

**GB**

PVR (Personal Video Recorder)

## Play Recorded Programme



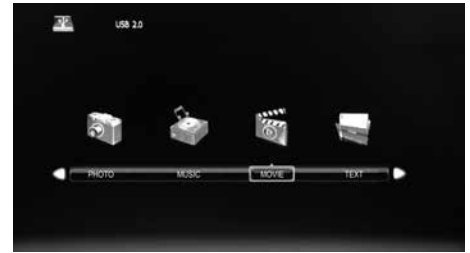

You can play a recorded programme from the recorded programme list or from a USB Storage Device.

1. Press the  button on the rear panel of the TV or the **INPUT** button on the remote control and then press the  buttons to select the **USB** mode and then press the **OK** button.
2. Press the  buttons to select **MOVIE** and then press the **OK** button.



3. Press the  buttons to select your storage device and then press the **OK** button.



4. Press the  buttons to select the "\_MSTPVR" folder and then press the **OK** button.
5. Press the  buttons to select your recorded programme and then press the **OK** button. A tick box will be displayed. If you want to delete the file, press the **RED** button to enter the **Sub Menu** and then press the  button to confirm. Press the  **PLAY** button to view.



6. Press the **OK** button or the **i** button to display the function bar.
7. Press the  buttons and then press the **OK** button to select the function: Pause / FB / FF / Prev. / Next / Stop / Repeat (Repeat All / Repeat Off / Repeat 1) / A-B / Playlist / Info / Aspect Ratio.
8. Press the **EXIT** button to return to the previous menu.

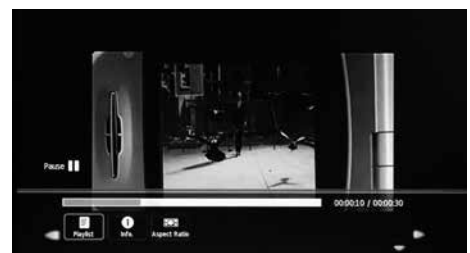

## Maintenance

Careful and regular cleaning can prolong the life of your TV.



Be sure to press the  button on the rear panel of the TV or on the remote control to turn off the TV. Disconnect the mains cable from the mains socket before any cleaning.

1. Use a soft dry cloth to wipe away the dust from the screen and surfaces.
2. If the surfaces are extremely dirty, clean the TV with a cloth which has been dipped in a slightly soapy water. Wring the cloth until it is almost dry, then use it to wipe the TV.
3. Ensure there is no excess water on the screen. Allow any water or dampness to evaporate before switching the TV on.



Never use alcohol, benzine, paint-thinner, cleaning fluid or other chemicals. Do not use compressed air to remove dust.

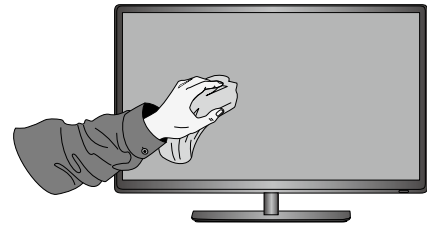

GB

## Hints and Tips

The following table contains various hints and tips to get the best performance from your TV. If you require additional assistance:

- For UK, please call our UK Call Centre on **0344 561 1234**.
- For Ireland, please call our Ireland Call Center on **1 890 818 575**.

The TV does not operate properly.	
<b>The TV does not respond when pressing any buttons</b>	<ul style="list-style-type: none"> <li>• The TV may freeze up during use. Disconnect the mains plug from the mains socket for a few minutes. Reconnect the mains plug and try to operate it again as usual.</li> </ul>
<b>TV cannot be switched on</b>	<ul style="list-style-type: none"> <li>• Check that the TV is connected to the mains supply is switched on.</li> <li>• Make sure all connected AV devices are switched off before switching on your TV.</li> </ul>
<b>The remote control does not work</b>	<ul style="list-style-type: none"> <li>• Check to see if there are any objects between the TV and the remote control causing an obstruction. Ensure that you are pointing the remote control directly at the TV.</li> <li>• Ensure that the batteries are installed with the correct polarity (+ to +, - to -).</li> <li>• Install new batteries.</li> </ul>
<b>Power is suddenly turned off</b>	<ul style="list-style-type: none"> <li>• Check the power of the TV. The mains supply maybe interrupted.</li> <li>• Check if the sleep timer is set.</li> <li>• Check whether the Auto Standby is activated.</li> </ul>
<b>Can't view Saorview channels</b>	<ul style="list-style-type: none"> <li>• Check that you have selected the correct country when tuning in your TV. For ROI select <b>IRELAND</b>.</li> <li>• You will only receive Saorview channels in ROI, retune your TV making sure to select <b>IRELAND</b> as your country.</li> </ul>
The video function does not work.	
<b>No Picture &amp; No Sound</b>	<ul style="list-style-type: none"> <li>• Check whether the TV is switched on.</li> <li>• Try another channel. The problem may be caused by the broadcaster.</li> </ul>
<b>Picture appears slowly after switching on</b>	<ul style="list-style-type: none"> <li>• This is normal, the image is muted during the TV startup process. Please contact your service centre, if the picture has not appeared after five minutes.</li> </ul>
<b>No or poor colour or poor picture</b>	<ul style="list-style-type: none"> <li>• Adjust the settings in the <b>PICTURE</b> menu.</li> <li>• Try another channel. The problem may be caused by the broadcaster.</li> <li>• Check if the video cables are connected properly.</li> </ul>
<b>Horizontal / Vertical bar or picture shaking</b>	<ul style="list-style-type: none"> <li>• Check for local interference such as an electrical appliance or power tool.</li> </ul>
<b>Poor reception on some channels</b>	<ul style="list-style-type: none"> <li>• Station or cable channel may be experiencing problems, tune to another station.</li> <li>• Station signal is weak, reposition the aerial for better reception.</li> <li>• Check for sources of possible interference.</li> </ul>
<b>Lines or streaks in pictures</b>	<ul style="list-style-type: none"> <li>• Check aerial (Change the position of the aerial.)</li> </ul>
<b>No pictures when connecting HDMI</b>	<ul style="list-style-type: none"> <li>• Check if the input source is <b>HDMI1 / HDMI2</b>.</li> </ul>

<b>Picture appears in wrong ratio</b>	<ul style="list-style-type: none"> <li>Adjust the <b>Aspect Ratio</b> settings in the <b>PICTURE</b> menu or press the <b>ASPECT</b> button on the remote control.</li> </ul>
<b>The audio function does not work.</b>	
<b>Picture OK but no sound</b>	<ul style="list-style-type: none"> <li>Press the <b>VOL + / -</b> buttons.</li> <li>Sound muted? Press the <b>MUTE</b> button.</li> <li>Try another channel. The problem may be caused by the broadcaster.</li> </ul>
<b>No output from one of the speakers</b>	<ul style="list-style-type: none"> <li>Adjust the <b>Balance</b> settings in the <b>SOUND</b> menu.</li> </ul>
<b>Unusual sound from inside the TV</b>	<ul style="list-style-type: none"> <li>A change in ambient humidity or temperature may result in an unusual noise when the TV is switched on or off and does not indicate a fault with the TV.</li> </ul>
<b>No sound when connecting HDMI</b>	<ul style="list-style-type: none"> <li>Check if the input source is <b>HDMI1 / HDMI2</b>.</li> </ul>
<b>Audio noise</b>	<ul style="list-style-type: none"> <li>Keep the RF coaxial cable away from other connected cables.</li> </ul>
<b>Distorted sound</b>	<ul style="list-style-type: none"> <li>Adjust the <b>SOUND MODE</b> setting in the <b>SOUND</b> menu, depending on the type of program you are watching.</li> <li>If still have distorted sound, switch off the <b>DTS TruSurround</b> in <b>SOUND</b> menu, then re-adjust the <b>SOUND MODE</b> setting in the <b>SOUND</b> menu.</li> </ul>
<b>Password</b>	
<b>Lost password</b>	<ul style="list-style-type: none"> <li>Select the <b>Set Password</b> setting in the <b>LOCK</b> menu, then enter the following master password "9527". The master password clears your previous password and allows you to enter a new password.</li> </ul>
<b>There is a problem in PC mode.</b>	
<b>The signal is out of range (Invalid format)</b>	<ul style="list-style-type: none"> <li>Adjust the resolution, horizontal frequency, or vertical frequency.</li> </ul>
<b>Vertical bar or stripe on background &amp; horizontal incorrect position</b>	<ul style="list-style-type: none"> <li>Use Auto configure or adjust clock, phase, or H/V position.</li> </ul>
<b>Screen colour is unstable or shows a single colour</b>	<ul style="list-style-type: none"> <li>Check the signal cable.</li> <li>Reinstall the PC video card.</li> </ul>
<b>Channels are not recording.</b>	
<b>Not all channels record</b>	<ul style="list-style-type: none"> <li>You can only record free to air channels.</li> <li>You may have you run out of space on your USB storage device. Delete some files or use another USB storage device.</li> </ul>
<b>FAQs (Frequently Asked Questions)</b>	
<b>Why have I lost some / all of my channels?</b>	<ul style="list-style-type: none"> <li>It happens sometimes if you have a weak signal. Usually it just means you'll need to re-scan your digital box or TV. Don't worry, it is easy to do. And once you've done it, you should get all the Freeview channels available to you. If problems persist you may need to get your aerial checked. Talk to your retailer or contact your local aerial installer.</li> </ul>
<b>Why do I get 'blocking' on my digital picture?</b>	<ul style="list-style-type: none"> <li>In most cases, blocking is caused by a reception problem – either the signal is too weak or there is some kind of interference. Talk to your retailer or contact your local aerial installer.</li> <li>Blocking can also be caused by a digital signal that is too strong. If you are still experiencing blocking and the signal is strong, consult your local aerial installer for advice.</li> </ul>
<b>Can I watch Freeview using a portable set-top aerial?</b>	<ul style="list-style-type: none"> <li>Some, but only a few, homes may be able to use a set top aerial. However, for a much better reception, we strongly recommend that you use a rooftop aerial.</li> <li>If you do not have access to a rooftop aerial – for example, if you rent a flat and the aerial is the responsibility of your landlord, or if you're using a second TV in the bedroom and don't want the hassle and expense of using extension cables, a set top aerial may be your only option.</li> </ul>
<b>What type of aerial do I need?</b>	<ul style="list-style-type: none"> <li>If you are installing a new aerial, we recommend a wideband rooftop aerial rather than a loft aerial. Loft aerials generally receive a weaker digital signal and are more likely to get interference from other electrical devices at home. We suggest you have an aerial survey done before getting an aerial upgrade.</li> <li>Talk to your retailer or contact your local aerial installer.</li> </ul>

## Display Modes

The screen resolution has been optimised during production for the display modes listed below.

### YPbPr Mode

Resolution	Vertical Frequency (Hz)	Aspect Ratio
480I: 720 x 480	60	Auto / 4:3 / 16:9 / Full / Zoom / Subtitle / Smart Zoom
480P: 720 x 480		
576I: 720 x 576	50	
576P: 720 x 576		
720P: 1280 x 720	50	
	60	
1080I: 1920 x 1080	50	
	60	
1080P: 1920 x 1080	50	
	60	

### PC Mode

Please check the display settings of your computer before connecting to the TV. If the display setting of your computer does not match the TV, there may be no video.

Resolution	Vertical Frequency (Hz)	Aspect Ratio
640 x 480	60	4:3 / 16:9
	72	
	75	
800 x 600	60	
	72	
	75	
1024 x 768	60	
	70	
	75	
1360 x 768	60	
1366 x 768	60	
1920 x 1080	60	

### HDMI Mode

Resolution	Vertical Frequency (Hz)	Aspect Ratio
480I: 1440 x 480	60	Auto / 4:3 / 16:9 / Full / Zoom / Subtitle / Smart Zoom
480P: 720 x 480	60	
576I: 1440 x 576	50	
576P: 720 x 576	50	
720P: 1280 x 720	50	
	60	
1080I: 1920 x 1080	50	
	60	
1080P: 1920 x 1080	24	
	50	
	60	

## Product Fiche and Specifications

<b>Brand</b>	<b>LOGIK</b>
<b>Model</b>	<b>L22FE14</b>
<b>Energy Efficiency Class</b>	A
<b>Screen Size (measured diagonally)</b>	Approx. 55 cm (22 inch)
<b>Power Consumption (In HOME mode)</b>	21.5 W
<b>Average Annual Energy Consumption *</b> (Please refer to *1 under this table)	32 kWh
<b>Standby Power Consumption</b>	< 0.50 W
<b>Display Resolution</b>	1920 pixels (horizontal) x 1080 pixels (vertical)
<b>Panel System</b>	22 inch LED Backlit LCD Panel
<b>Television System</b>	PAL I / BG / DK SECAM L / BG / DK
<b>Brightness</b>	180 cd/m <sup>2</sup>
<b>Contrast Ratio</b>	850:1
<b>Peak Luminance (On-Mode/Home Mode)</b>	≥65%
<b>Power Source</b>	100-240V~50/60Hz
<b>Operating Temperature</b>	0°C – 40°C
<b>Operating Humidity</b>	10% – 80%
<b>Mercury Content (mg)</b>	0.0 mg
<b>Presence of Lead *</b> (Please refer to *2 under this table)	√
<b>Reference Period</b>	2010/1062 – 2014
<b>Speaker Power</b>	3 W + 3 W
<b>Dimension( W x D x H) with base</b>	512 x 170 x 360 mm
<b>Weight (Net)</b>	2.9 kg
<b>Inputs / Output</b>	
<b>SCART</b>	1
<b>HDMI</b>	2
<b>PC IN</b>	1
<b>PC AUDIO</b>	1
<b>YPbPr</b>	1
<b>Common Interface</b>	1
<b>AV</b>	1
<b>SPDIF OUTPUT</b>	1
<b>USB</b>	1
<b>AUDIO IN (RCA)</b>	1 (L + R)
<b>Aerial</b>	1
<b>Headphone (3.5mm)</b>	1

Features and specifications are subject to change without prior notice.



\*1 Energy consumption per year based on the power consumption of the television operating 4 hours per day for 365 days. The actual energy consumption will depend on how the television is used.

\*2 This television contains lead in certain parts or components where no technology alternatives exist in accordance with existing exemption clauses under the RoHS Directive.

GB







Others Information





**ENERG**
  
 енергия · ενεργεια

**LOGIK** L22FE14

---

A+   
 A   
 B   
 C   
 D   
 E   
 F 



**A**

ENERGIA · ЕНЕРГИЈА  
 ENERTEIA · ENERGIJA  
 ENERGY · ENERGIE  
 ENERGI

**22**  
Watt

**32**  
kWh/annum

**55**  
cm



**22**  
inch

2010/1062 - 2014

## Remote Control Codes

### Sky Codes

The codes for controlling your TV using a Sky Remote Control are **3456, 3460, 3830, 3859**. For instruction on how to use the code, see your Sky instruction manual.

## Useful Information and Licences



For general information about this appliance and handy hints and tips, please visit [www.knowhow.com/knowledgebank](http://www.knowhow.com/knowledgebank) or call UK: **0344 561 1234** Ireland: **1890 818 575**.



Visit [Partmaster.co.uk](http://Partmaster.co.uk) today for the easiest way to buy electrical spares and accessories. With over 1 million spares and accessories available we can deliver direct to your door the very next day. Visit [www.partmaster.co.uk](http://www.partmaster.co.uk) or call 0344 800 3456 (UK customers only). Calls charged at National Rate.



The symbol on the product or its packaging indicates that this product must not be disposed of with your other household waste. Instead, it is your responsibility to dispose of your waste equipment by handing it over to a designated collection point for the recycling of waste electrical and electronic equipment. The separate collection and recycling of your waste equipment at the time of disposal will help conserve natural resources and ensure that it is recycled in a manner that protects human health and the environment.

For more information about where you can drop off your waste for recycling, please contact your local authority, or where you purchased your product.



#### Notes for Battery Disposal

The batteries used with this product contain chemicals that are harmful to the environment. To preserve our environment, dispose of used batteries according to your local laws or regulations. Do not dispose of batteries with normal household waste.

For more information, please contact the local authority or your retailer where you purchased the product.

### MPEG-2 NOTICE

Any use of this product in any matter other than personal use that complies with the MPEG-2 standard for encoding video information for packaged media is expressly prohibited without a license under applicable patents in the MPEG-2 Patent Portfolio, which license is available from MPEG LA, LLC, 6312 S. Fiddlers Green Circle, Suite 400E, Greenwood Village, Colorado, 80111 U.S.A.

### Dolby Digital

Manufactured under license from Dolby Laboratories. Dolby and the double-D symbol are trademarks of Dolby Laboratories. Confidential unpublished works. ©1992-1997 Dolby Laboratories, Inc. all rights reserved.

The terms HDMI and HDMI High-Definition Multimedia Interface, and the HDMI Logo are trademarks or registered trademarks of HDMI Licensing LLC in the United States and other countries.

The Freeview service and channels are subject to coverage and may be changed from time to time. Aerial upgrade and/or receiver may be required. Visit [freeview.co.uk/availability](http://freeview.co.uk/availability). The FREEVIEW words and logos are trade marks of DTV Services LTD. © DTV Services Ltd

For DTS patents, see <http://patents.dts.com>. Manufactured under license from DTS Licensing Limited. DTS, the Symbol, & DTS and the Symbol together are registered trademarks, and DTS TruSurround is a trademark of DTS, Inc. © DTS, Inc. All Rights Reserved.

All trademarks are the property of their respective owners and all rights are acknowledged.

GB

Others Information



**For Help and Support Call**  
**UK: 0344 561 1234**  
**Ireland: 1890 818 575**