



LG

Life's Good

ENGLISH

OWNER'S MANUAL LED LCD MONITOR TV

Please read this manual carefully before operating your set and retain it for future reference.

LED LCD MONITOR TV MODELS

M2080D M2380DF

M2280D M2780DF

M2380D

M2780D

www.lg.com

CONTENTS

PREPARATION

FRONT PANEL INFORMATION	4
BACK PANEL INFORMATION	5
STAND INSTALLATION	
M2080D/M2280D/M2380D/M2780D	6
M2380DF/M2780DF	7
DETACHING THE STAND	
M2080D/M2280D/M2380D/M2780D	8
M2380DF/M2780DF	9
DETACHING THE STAND BODY (Only M2080D/ M2280D/M2380D/M2780D)	10
WALL MOUNT: HORIZONTAL INSTALLATION	11
SWIVEL STAND(Only M2780D / M2780DF)	12
DESKTOP PEDESTAL INSTALLATION	12
POSITIONING YOUR DISPLAY	13
LOCATION	13
KENSINGTON SECURITY SYSTEM	14

EXTERNAL EQUIPMENT SETUP

ANTENNA CONNECTION	15
HD RECEIVER SETUP	
Connecting with a Component Cable	16
Connecting a Set-top Box with an HDMI Cable	17
Connecting with an HDMI to DVI Cable	18
DVD SETUP	
Connecting with a Component Cable	19
Connecting with an HDMI Cable	20
VCR SETUP	
Connecting with an RF Cable	21
Connecting with an RCA Cable	22
DIGITAL AUDIO OUT SETUP	23
USB SETUP	24
HEADPHONE SETUP	25
OTHER A/V SOURCE SETUP	26
PC SETUP	
Connecting with a D-sub 15-pin Cable	27
Connecting with an HDMI to DVI Cable	28
Connecting with an HDMI to HDMI Cable	29
BACK COVER WIRE ARRANGEMENT	30
SUPPORTED DISPLAY RESOLUTIONS	31

WATCHING TV/CHANNEL CONTROL

REMOTE CONTROL KEY FUNCTIONS	33
TURNING ON THE TV	35
CHANNEL SELECTION	35
VOLUME ADJUSTMENT	35
INITIAL SETTING	36
QUICK MENU	37
ON-SCREEN MENU SELECTION AND ADJUSTMENT	38
AUTO SCAN (AUTO TUNING)	39
ADD/DELETE CHANNEL (MANUAL TUNING)	40
CHANNEL EDITING	41
CHANNEL LIST	42
FAVORITE CHANNEL SETUP	43
FAVORITE CHANNEL LIST	43
BRIEF INFORMATION	44
INPUT LIST	45

PICTURE CONTROL

ASPECT RATIO SELECTION	46
PICTURE WIZARD	48
 ENERGY SAVING	49
PRESET PICTURE SETTINGS(PICTURE MODE)	50
MANUAL PICTURE ADJUSTMENT-USER MODE	51
PICTURE IMPROVEMENT TECHNOLOGY	52
EXPERT PICTURE CONTROL	53
PICTURE RESET	56
SCREEN SETUP FOR PC MODE	
Selecting Resolution	57
Auto Configure (RGB-PC Mode Only)	58
Adjustment for Screen Position, Size, Phase	59
Screen Reset	60

SOUND CONTROL

AUTO VOLUME LEVELER (AUTO VOLUME)	61
CLEAR VOICE II	62
BALANCE	63
PRESET SOUND SETTINGS	
-SOUND MODE	64
PRESET SOUND SETTINGS	
-USER MODE	65

Surround X..... 65
 AUDIO RESET 66
 TV SPEAKERS ON/OFF SETUP..... 67
 STEREO/SAP BROADCAST SETUP 68

TIME SETTING

CLOCK SETUP
 Auto Clock Setup 69
 Manual Clock Setup..... 70
 AUTO ON/OFF TIME SETTING..... 71
 SLEEP TIMER SETTING 72

OPTIONAL SETTINGS

ON-SCREEN MENUS LANGUAGE SELECTION... 73
 AUDIO LANGUAGE 74
 INPUT LABEL 75
 KEY LOCK..... 76
 CAPTION MODE
 Analog Broadcasting System Captions 77
 Digital Broadcasting System Captions..... 78
 Caption Option 79
 POWER INDICATOR..... 80
 DEMO MODE 81

PARENTAL CONTROL/RATINGS

PASSWORD & LOCK SYSTEM SETTINGS
 Setting Up Your Password..... 82
 Lock System..... 83
 Set Password..... 84
 CHANNEL BLOCKING..... 85
 MOVIE & TV RATINGS
 Movie Rating (MPAA) - For USA/MEXICO... 86
 TV Ratings Children - For USA/MEXICO ... 87
 TV Ratings General - For USA/MEXICO... 88
 TV Ratings English - For CANADA 89
 TV Ratings French - For CANADA..... 90
 DOWNLOADABLE RATINGS 91
 EXTERNAL INPUT BLOCKING 92

USING USB DEVICES

ENTRY MODES 93
 PHOTO LIST 95
 MUSIC LIST..... 99
 MOVIE LIST 102
 DIVX REGISTRATION CODE..... 107
 DEACTIVATION 108

APPENDIX

TROUBLESHOOTING 109
 MAINTENANCE..... 112
 PRODUCT SPECIFICATIONS
 <M2080D>..... 113
 <M2280D>..... 114
 <M2380D/M2380DF> 115
 <M2780D/M2780DF> 116
 IR CODES 117
 EXTERNAL CONTROL THROUGH RS-232C
 RS-232C Setup..... 118
 Type of Connector; D-Sub 9-pin Male..... 118
 Communication Parameters 118
 RS-232C Configurations 119
 Set ID 119

PREPARATION

FRONT PANEL INFORMATION

- This is a simplified representation of the front panel. The image shown may be somewhat different from your Monitor set.

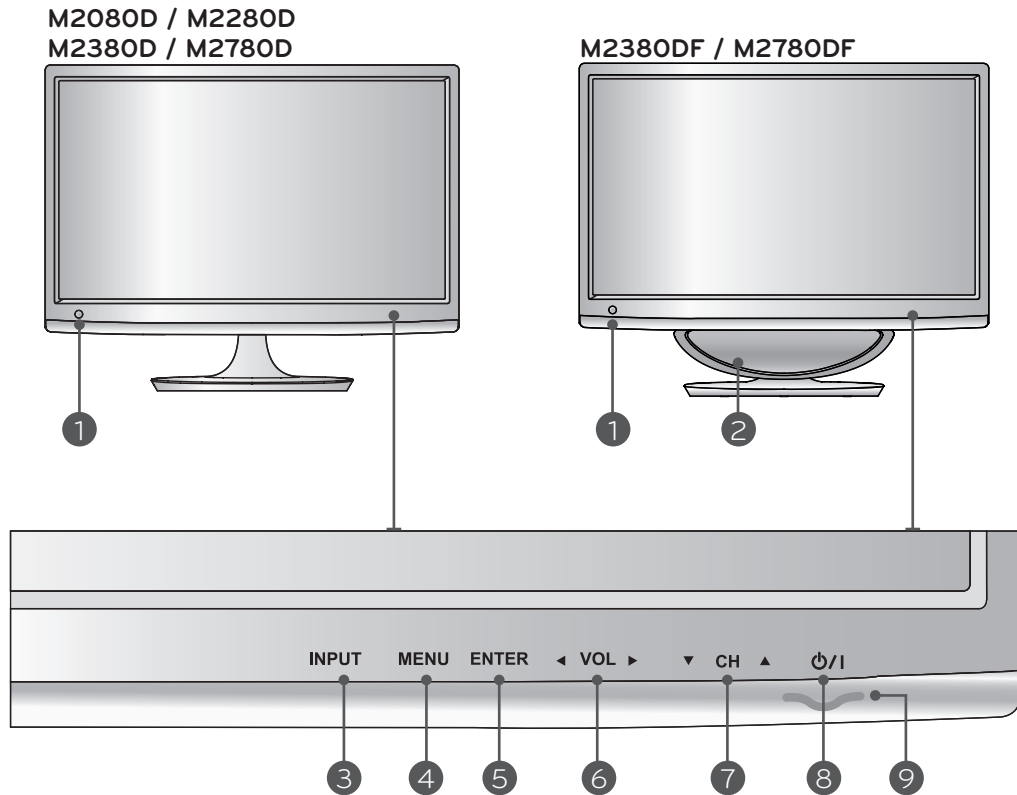

① IR RECEIVER (remote control signal receiver)

② SPEAKER (WOOFER)

③ INPUT BUTTON

④ MENU BUTTON

⑤ ENTER BUTTON

⑥ VOLUME BUTTON

⑦ CHANNEL BUTTON

⑧ POWER BUTTON

⑨ POWER INDICATOR

Illuminates blue when the set is switched on.

Note: You can adjust the power indicator in the OPTION menu.

BACK PANEL INFORMATION

■ This is a simplified representation of the front panel. The image shown may be somewhat different from your Monitor set.

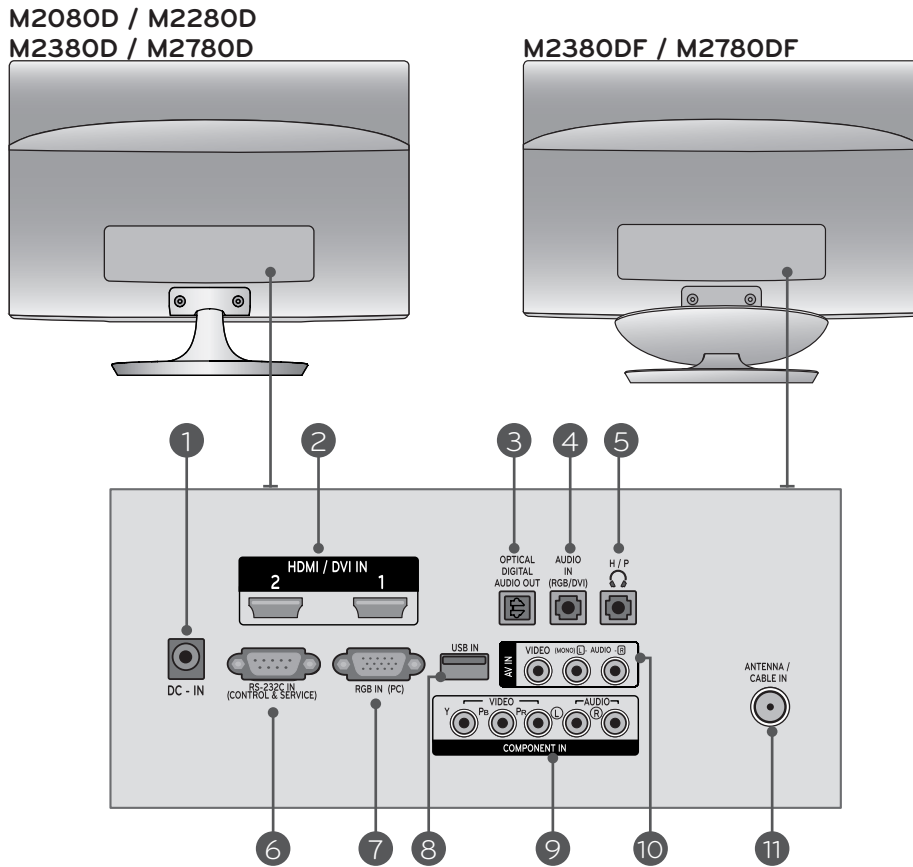

- 1 DC ADAPTER PORT**
Connect to the power jack.
- 2 HDMI INPUT**
Connect an HDMI signal to HDMI IN or a DVI (VIDEO) signal to HDMI IN with a DVI to HDMI cable.
- 3 OPTICAL DIGITAL AUDIO OUT**
Connect digital audio to various types of equipment with an optical audio cable.
- 4 RGB/DVI AUDIO INPUT**
Connect the audio from a PC.
- 5 HEADPHONE SOCKET**
Plug headphones into the headphone socket.
- 6 RS-232C IN (CONTROL & SERVICE) PORT**
Connect to the RS-232C port on a PC.
This port is used for Service or Hotel mode.
- 7 RGB INPUT (PC)**
Connect the output from a PC.
- 8 USB INPUT**
- 9 COMPONENT INPUT**
Connect a component video/audio device to these jacks.
- 10 AV(AUDIO/VIDEO) INPUT**
Connect audio/video output from an external device to these jacks.
- 11 ANTENNA / CABLE INPUT**
Connect over-the-air signals to this jack.

PREPARATION

M2080D/M2280D/M2380D/M2780D

STAND INSTALLATION

■ The image shown may be somewhat different from your Monitor set.

1 Carefully place the product screen side down on a cushioned surface that will protect the Monitor set and its screen from damage.

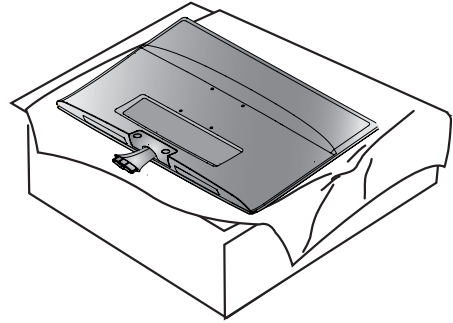

2 Insert the **Stand Base** into the product.

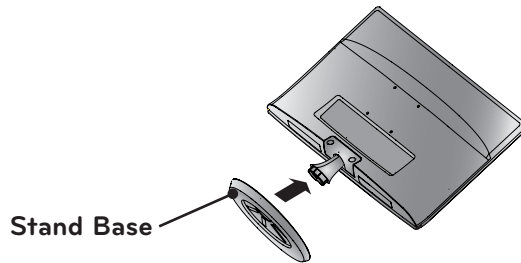

3 Use a **Coin** on the bottom of the stand base and turn the screw clockwise to tighten.

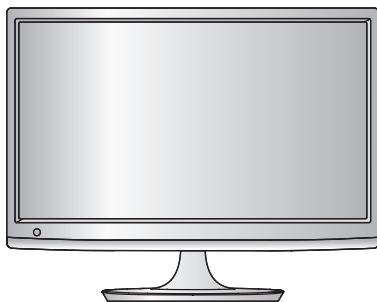
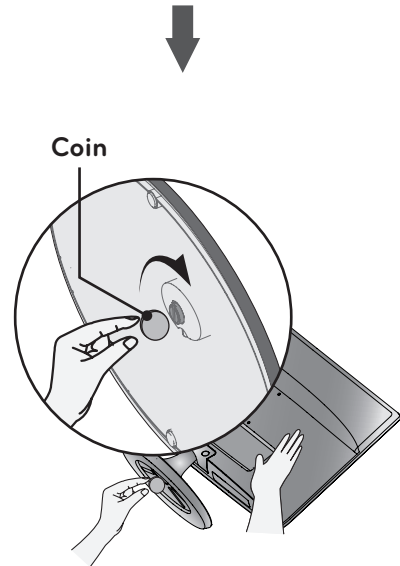

STAND INSTALLATION

■ The image shown may be somewhat different from your Monitor set.

1 Carefully place the product screen side down on a cushioned surface that will protect the Monitor set and its screen from damage.

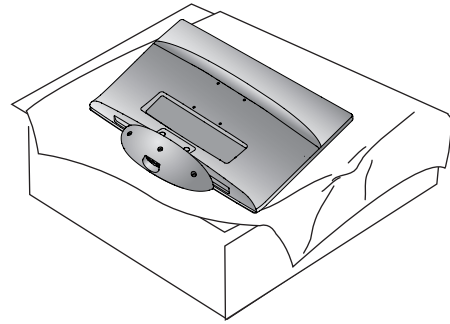

2 Insert the **Stand Base** into the product.

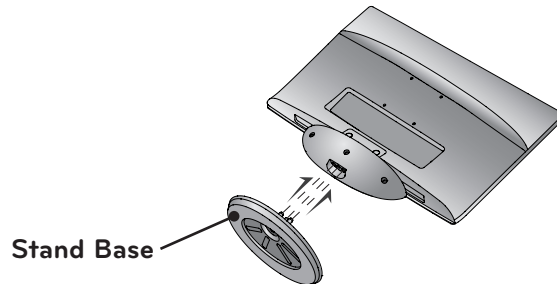

3 Use a **Coin** on the bottom of the stand base and turn the screw clockwise to tighten.

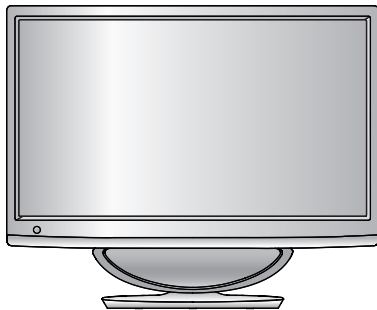
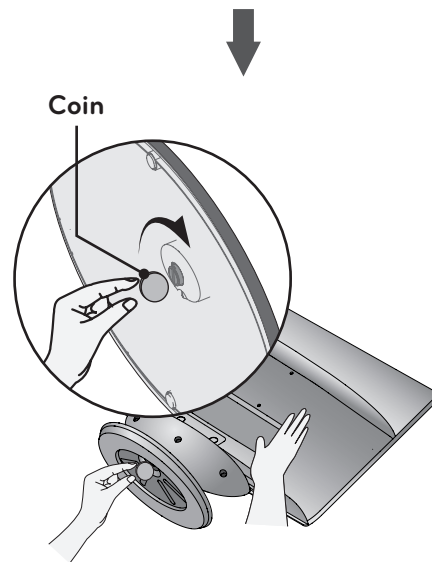

PREPARATION

M2080D/M2280D/M2380D/M2780D

DETACHING THE STAND

■ The image shown may be somewhat different from your Monitor set.

1 Place the Monitor set screen side down on a cushion or soft cloth.

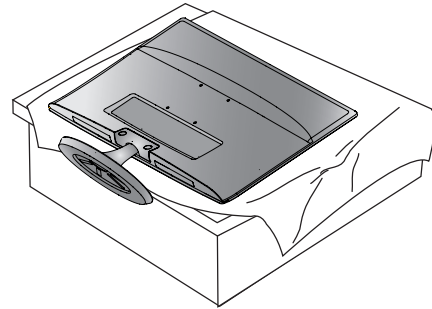

2 Detach the **Stand Base** from the set by turning the screw to the left with a **Coin**.

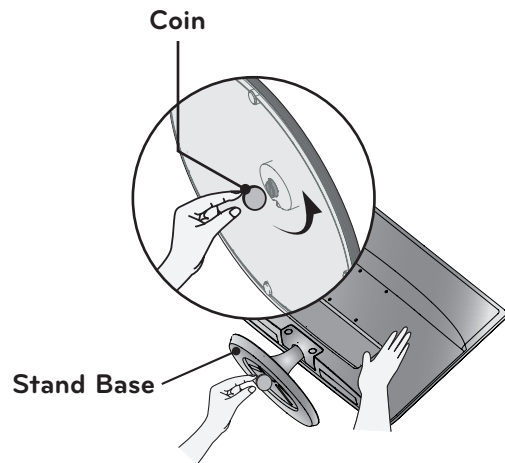

3 Pull the stand base.

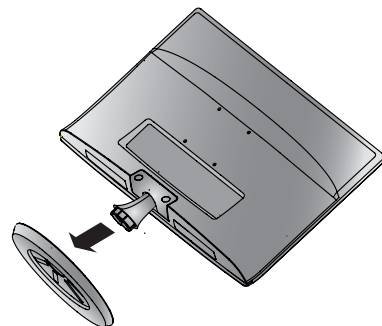

DETACHING THE STAND

■ The image shown may be somewhat different from your Monitor set.

- 1 Place the Monitor set screen side down on a cushion or soft cloth.

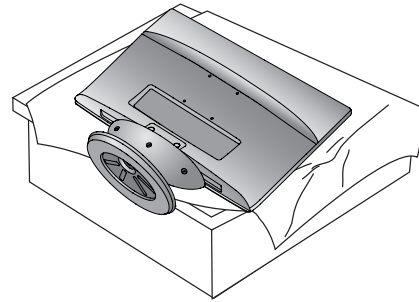

- 2 Detach the **Stand Base** from the set by turning the screw to the left with a **Coin**.

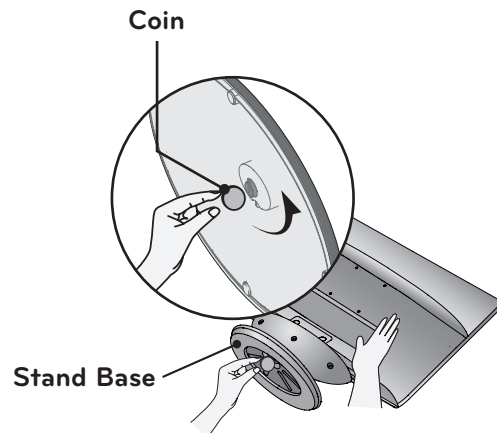

- 3 Pull the stand base.

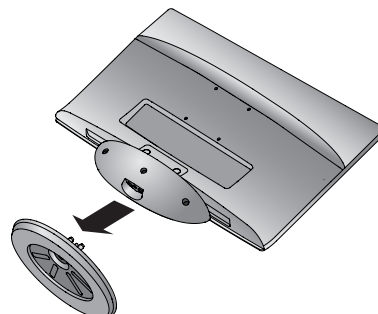

PREPARATION

DETACHING THE STAND BODY (Only M2080D/ M2280D/M2380D/M2780D)

- When using a VESA mount on the monitor set, you may wish to remove the stand body.
- The image shown may be somewhat different from your Monitor set.

1. Remove the screw 2 points.
2. Pull the stand body.



3. Assemble the screw 2 points.

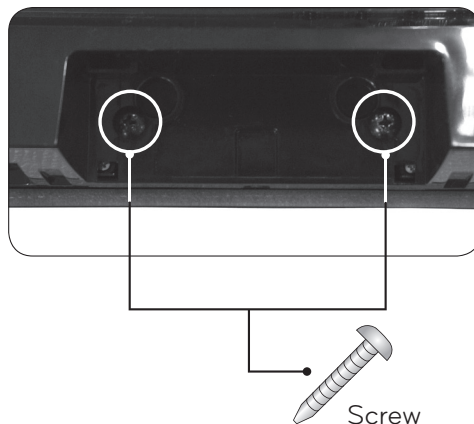

WALL MOUNT: HORIZONTAL INSTALLATION

■ The image shown may be somewhat different from your Monitor set.

For proper ventilation, allow a clearance of 10 cm on each side and from the wall. Detailed installation instructions are available from your dealer. See the optional Tilt Wall Mounting Bracket Installation and Setup Guide.

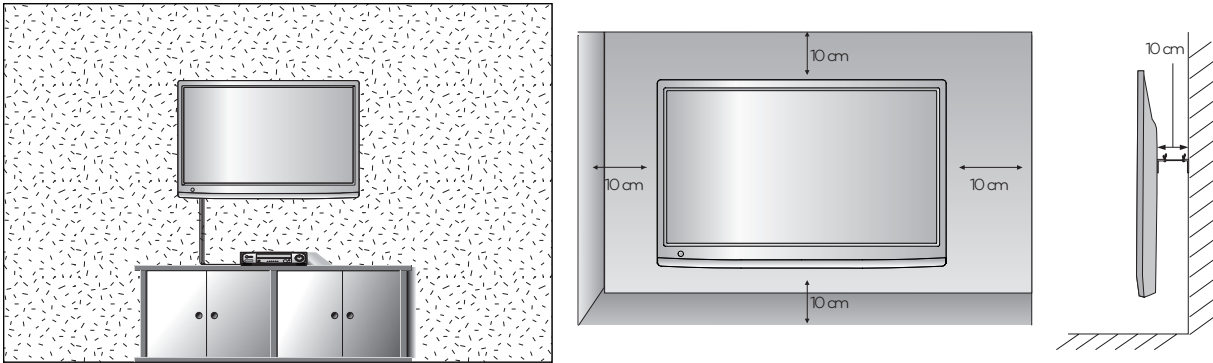

If you intend to mount the Monitor set to a wall, attach the wall mounting interface (optional) to the back of the Monitor set. When you install the Monitor set using the wall mounting interface (optional), attach it carefully so it will not drop.

1. Be sure to use screws and a wall mount that meet VESA standards.
2. Using screws longer than those recommended might damage the Monitor set.
3. Using screws that do not meet VESA standards might either damage the Monitor set or result in it coming away from the wall. LG is not responsible for any damage resulting from failure to follow these instructions.
4. "VESA compatible" refers to the screw mounting interface dimensions and mounting screw specifications.
5. Please use VESA standards as shown below.
 - 5-1) 784.8 mm (30.9 inch) and under
 - * Wall Mount Pad Thickness: 2.6 mm
 - * Screw: Φ 4.0 mm x Pitch 0.7 mm x Length 10 mm
 - 5-2) 787.4 mm (31.0 inch) and above
 - * Please use a VESA standard wall mount pad and screws.

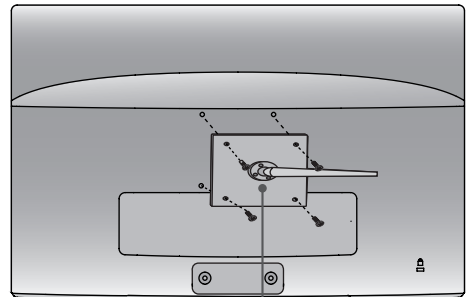

Wall Mount Pad

< Screw Mounting Interface Dimensions >

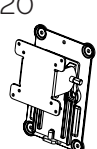
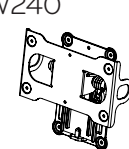
Model	M2080D M2280D M2380D M2380DF	M2780D M2780DF
VESA (A x B)	75 x 75	200 x 100
Wall mount bracket(optional)	RW120 	RW240 

PREPARATION

SWIVEL STAND(Only M2780D / M2780DF)

- The image shown may be somewhat different from your Monitor set.

After installing the set, you can adjust the set manually to the left or right direction by 179 degrees to suit your viewing position.

PREPARATION

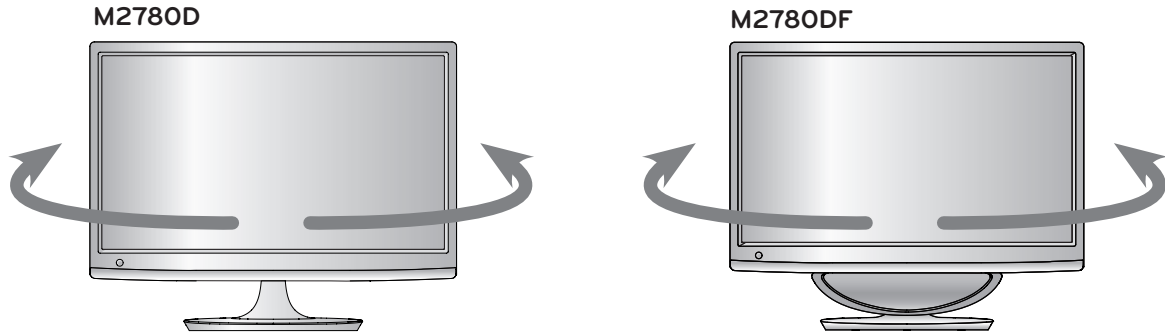

DESKTOP PEDESTAL INSTALLATION

- The image shown may be somewhat different from your Monitor set.

For proper ventilation, allow a clearance of 10 cm on each side and from the wall.

M2080D / M2280D
M2380D / M2780D

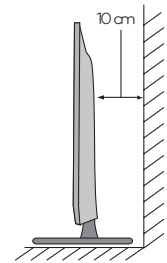
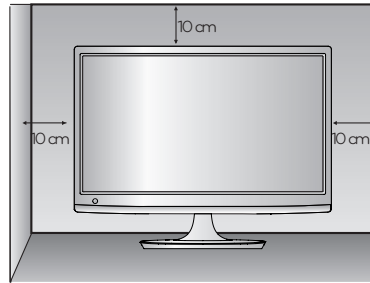
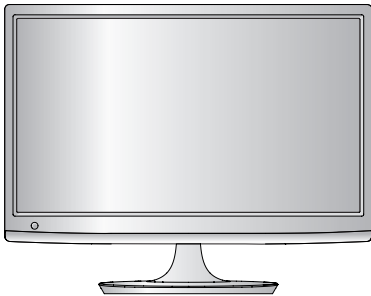

M2380DF / M2780DF

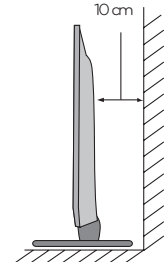
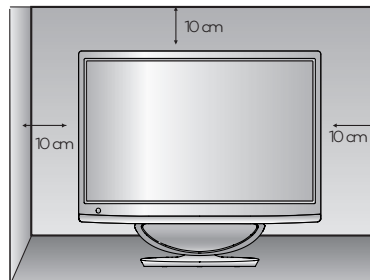
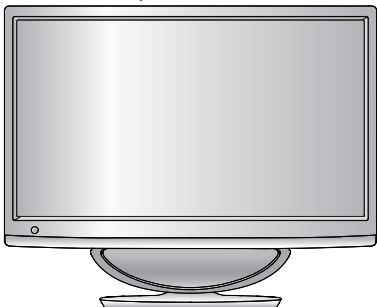

POSITIONING YOUR DISPLAY

- The image shown may be somewhat different from your set.
Adjust the position of the panel in various ways for maximum comfort.

* Tilt Range

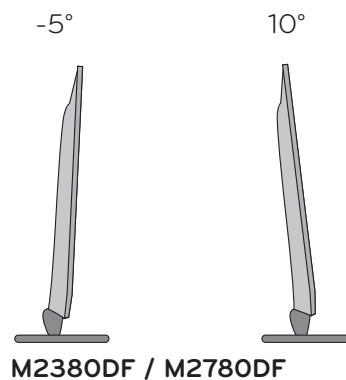
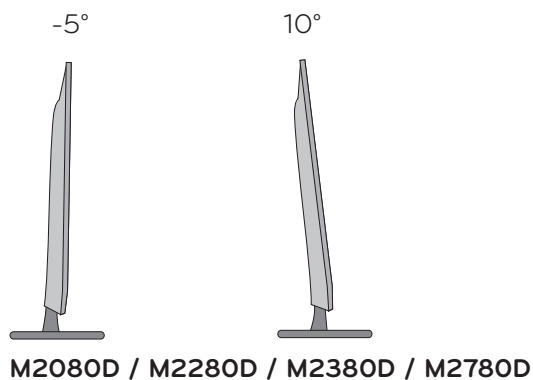

LOCATION

Position your set so that no bright light or sunlight falls directly onto the screen. Care should be taken not to expose the set to any unnecessary vibration, moisture, dust or heat. Also, ensure that the set is placed in a position to allow a free flow of air. Do not cover the ventilation openings on the back cover.

! WARNING

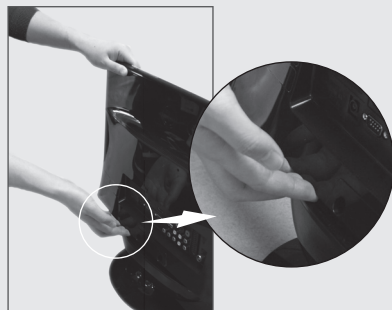
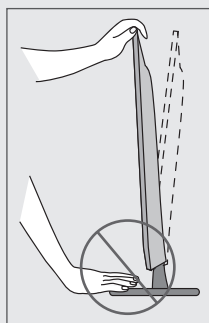

M2380DF / M2780DF

- When adjusting the angle of the screen, do not put your finger(s) in between the head of the monitor and the stand body or woofer. You can hurt your finger(s).

PREPARATION

KENSINGTON SECURITY SYSTEM

- The product is equipped with a Kensington Security System connector on the back panel. Connect the Kensington Security System cable as shown below.
- For detailed installation and use of the Kensington Security System, refer to the user's guide provided with the Kensington Security System.
- For further information, visit <http://www.kensington.com>. Kensington sells security systems for expensive electronic equipment such as notebook PCs and LCD projectors.

NOTE

- The Kensington Security System is an optional accessory.

NOTES

- If the product feels cold to the touch, there may be a small "flicker" when it is turned on. This is normal, there is nothing wrong with product.
- Some minute dot defects may be visible on the screen, appearing as tiny red, green, or blue spots. However, they have no adverse effect on the monitor's performance.
- Avoid touching the LCD screen or holding your finger(s) against it for long periods of time. Doing so may produce temporary distortions on the screen.

M2080D / M2280D
M2380D / M2780D

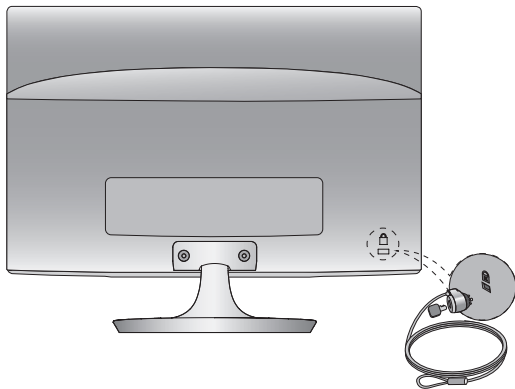

M2380DF / M2780DF

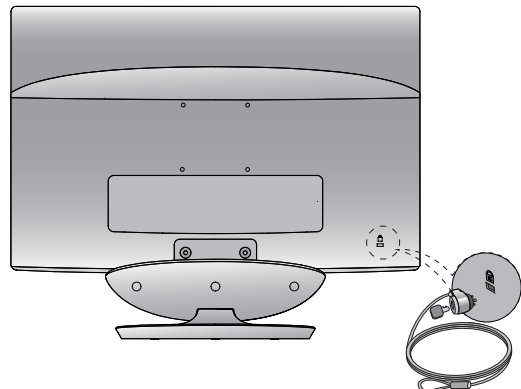

EXTERNAL EQUIPMENT SETUP

- To prevent damage, do not connect the set to the a power outlet until all connections have been made between the devices.

ANTENNA CONNECTION

- For optimum picture quality, adjust the antenna's direction.
- An antenna cable and converter are not included with the Monitor set.

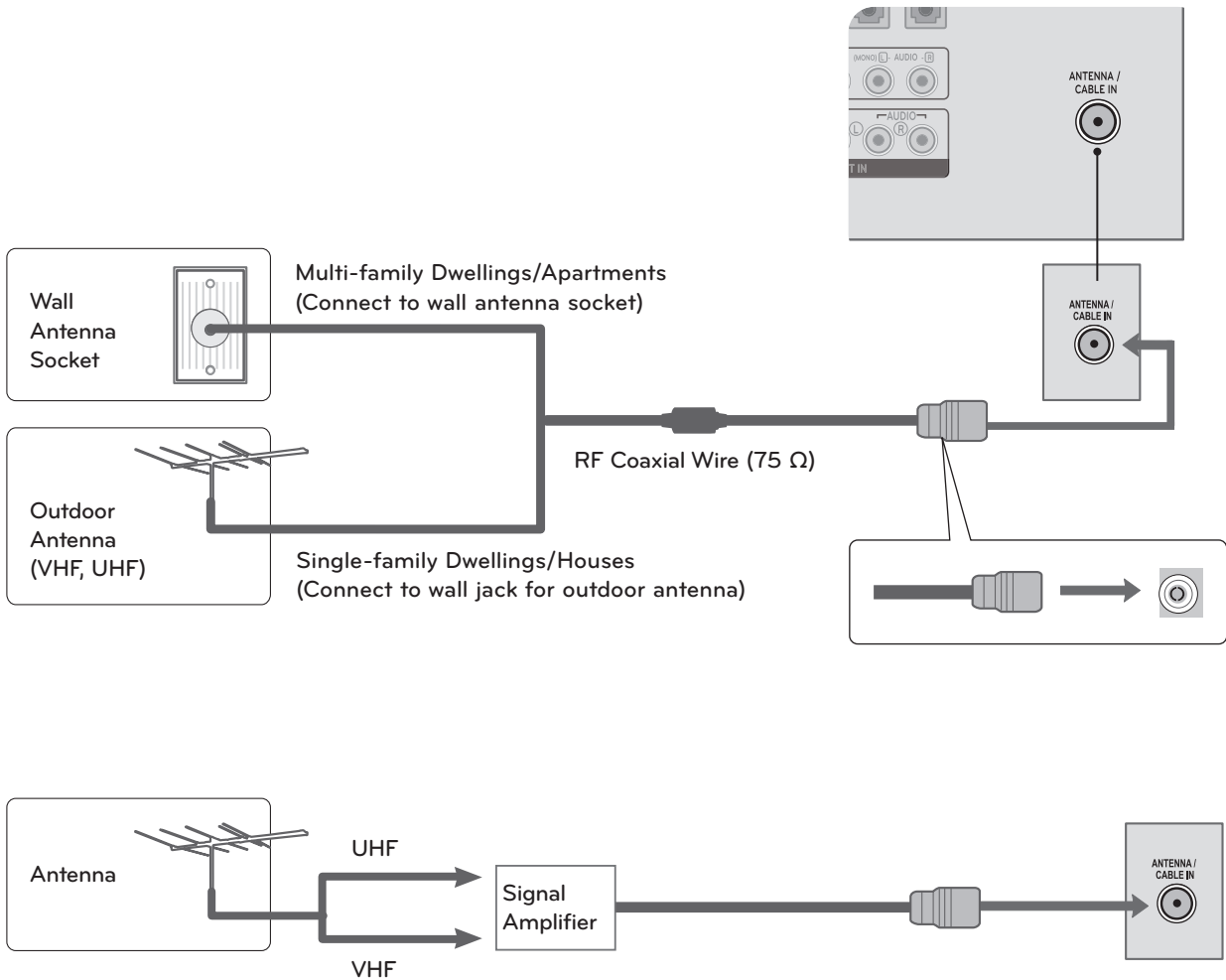

- To get better picture quality in poor signal areas, install a signal amplifier to the antenna as shown above.
- If the signal needs to be split for two devices, use an antenna signal splitter.

EXTERNAL EQUIPMENT SETUP

- To prevent damage, never plug in any power cords until you have finished connecting all equipment.
- The image shown may be somewhat different from your Monitor set.

HD RECEIVER SETUP

Connecting with a Component Cable

- 1 Connect the video outputs (Y, PB, PR) of the digital set-top box to the **COMPONENT IN VIDEO** jacks on the Monitor set.
- 2 Connect the audio output of the digital set-top box to the **COMPONENT IN AUDIO** jacks on the Monitor set.
- 3 Turn on the digital set-top box. (Refer to the owner's manual for the digital set-top box.)
- 4 Select **COMPONENT** input source using the **INPUT** button on the remote control.

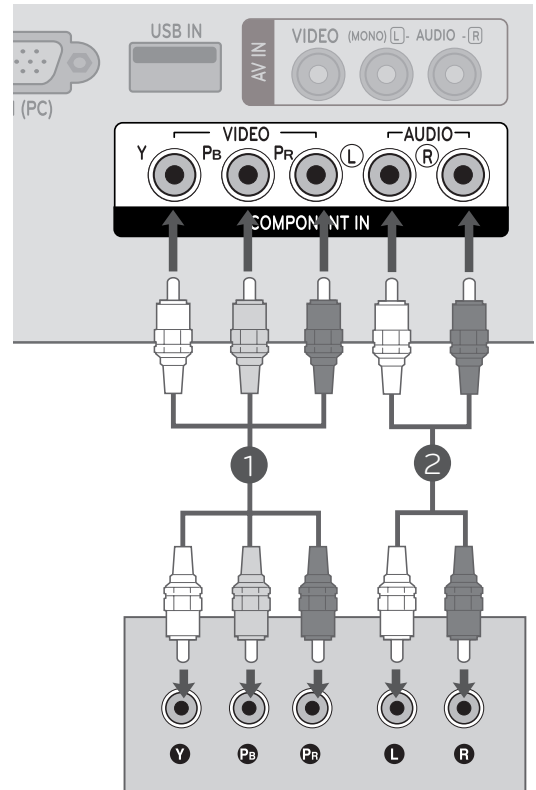

- **HDMI Audio Supported formats: Dolby Digital, PCM**
DTS Audio format is not supported.

Signal	Component	HDMI
480i / 576i	YES	No
480p / 576p	YES	YES
720p / 1080i	YES	YES
1080p	YES (50 Hz / 60Hz only)	YES (24 Hz / 30 Hz / 50Hz / 60Hz)

Connecting a Set-top Box with an HDMI Cable

- 1 Connect the digital set-top box to the **HDMI/DVI IN 1** or **HDMI/DVI IN 2** jack on the Monitor set.
- 2 Turn on the digital set-top box. (Refer to the owner's manual for the digital set-top box.)
- 3 Select **HDMI 1** or **HDMI 2** input source using the **INPUT** button on the remote control.

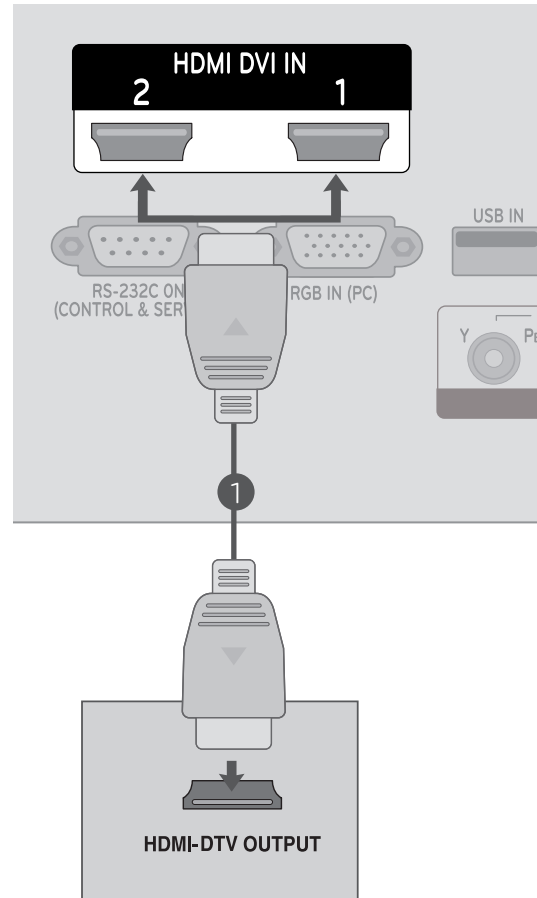

NOTE

- Check that your HDMI cable is a high speed HDMI cable. If the HDMI cables are not high speed, flickering or no screen display can result.

EXTERNAL EQUIPMENT SETUP

Connecting with an HDMI to DVI Cable

- 1 Connect the digital set-top box to the **HDMI/DVI IN 1** or **HDMI/DVI IN 2** jack on the Monitor set.
- 2 Connect the audio output of the digital set-top box to the **AUDIO IN (RGB/DVI)** jack on the Monitor set.
- 3 Turn on the digital set-top box. (Refer to the owner's manual for the digital set-top box.)
- 4 Select **HDMI 1** or **HDMI 2** using the **INPUT** on the remote control.

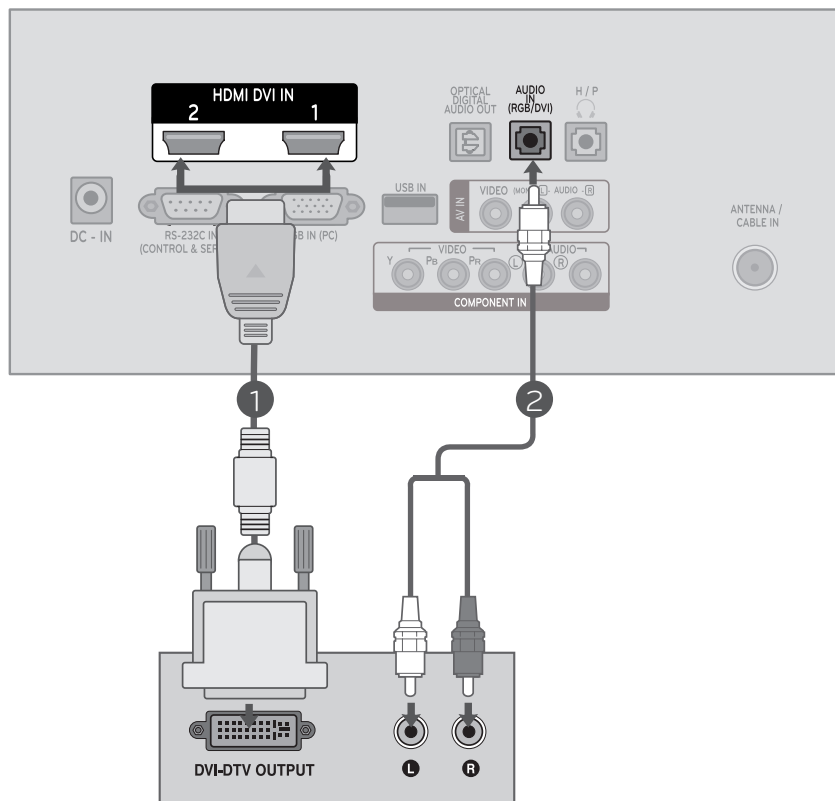

DVD SETUP

Connecting with a Component Cable

- 1 Connect the video outputs (Y, PB, PR) of the DVD to the **COMPONENT IN VIDEO** jacks on the Monitor set.
- 2 Connect the audio outputs of the DVD to the **COMPONENT IN AUDIO** jacks on the Monitor set.
- 3 Turn on the **DVD player**, insert a DVD.
- 4 Select **Component** using the **INPUT** on the remote control.
- 5 Refer to the DVD player's manual for operating instructions.

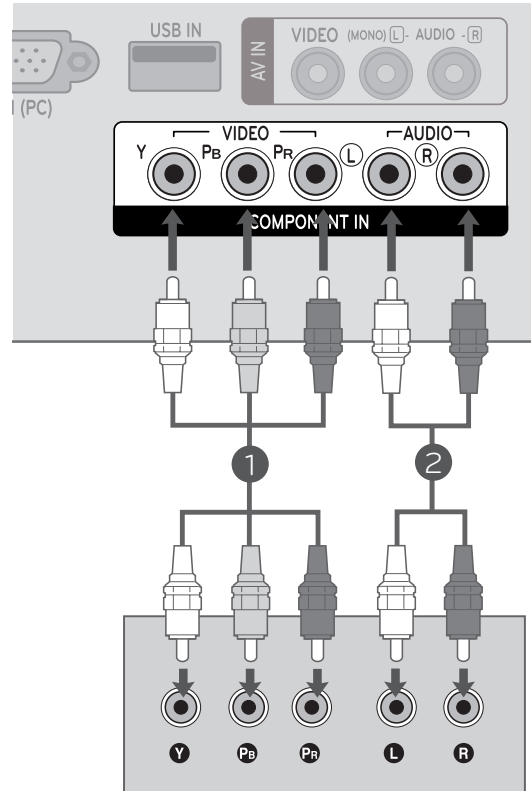

Component Input Ports

For better picture quality, connect a DVD player to the component input ports as shown below.

Component Ports on the set	Y	P _B	P _R
Video output Ports on the DVD player	Y	P _B	P _R
	Y	B-Y	R-Y
	Y	Cb	Cr
	Y	Pb	Pr

EXTERNAL EQUIPMENT SETUP

Connecting with an HDMI Cable

- 1 Connect the HDMI output of the DVD to the **HDMI/DVI IN 1** or **HDMI/DVI IN 2** jack on the Monitor set.
- 2 Select **HDMI 1** or **HDMI 2** using the **INPUT** on the remote control.
- 3 Refer to the DVD player's manual for operating instructions.

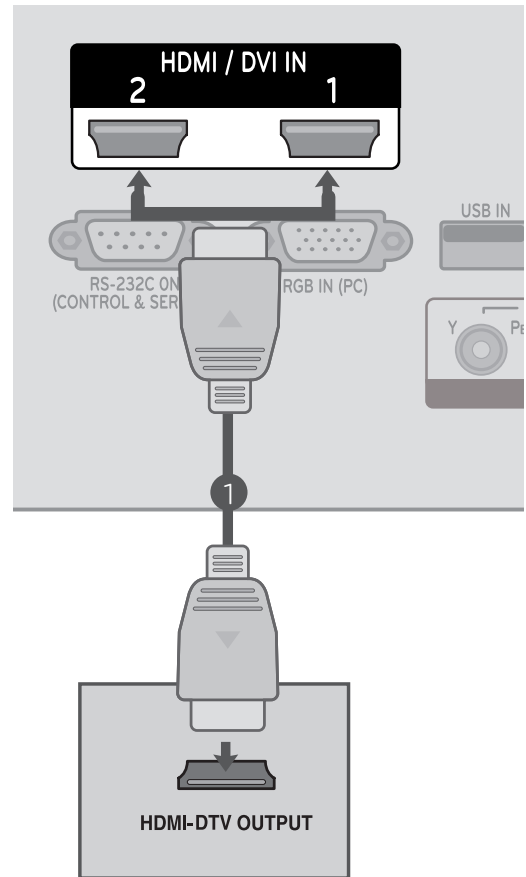

! NOTE

- ▶ Check that your HDMI cable is a high speed HDMI cable. If the HDMI cables are not high speed, flickering or no screen display can result.

VCR SETUP

- To avoid picture noise (interference), allow adequate distance between the VCR and set.

Connecting with an RF Cable

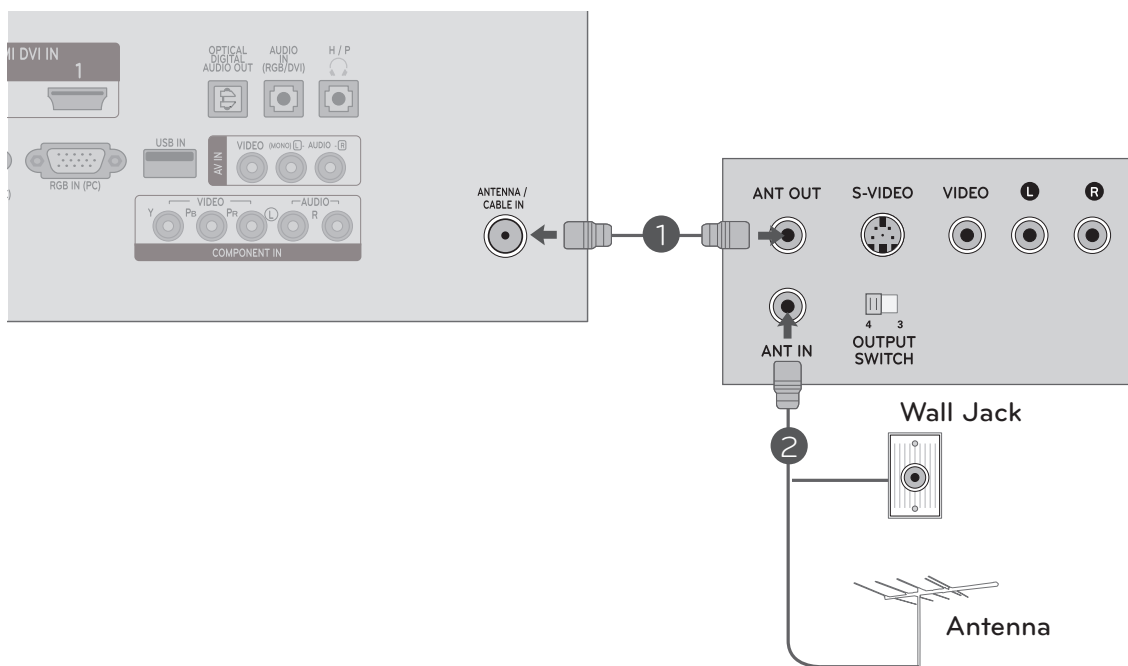

- 1 Connect the **ANT OUT** socket of the VCR to the **ANTENNA/CABLE IN** socket on the Monitor set.
- 2 Connect the antenna cable to the **ANT IN** socket of the VCR.
- 3 Press **PLAY** on the **VCR** and match the appropriate channel between the set and the VCR for viewing.

EXTERNAL EQUIPMENT SETUP

Connecting with an RCA Cable

- 1 Connect the **AUDIO/VIDEO** jacks between set and VCR. Match the jack colors (Video = yellow, Audio Left = white, and Audio Right = red)
- 2 Insert a video tape into the **VCR** and press **PLAY**. (Refer to the VCR owner's manual.)
- 3 Select **AV** input source using **INPUT** on the remote control.

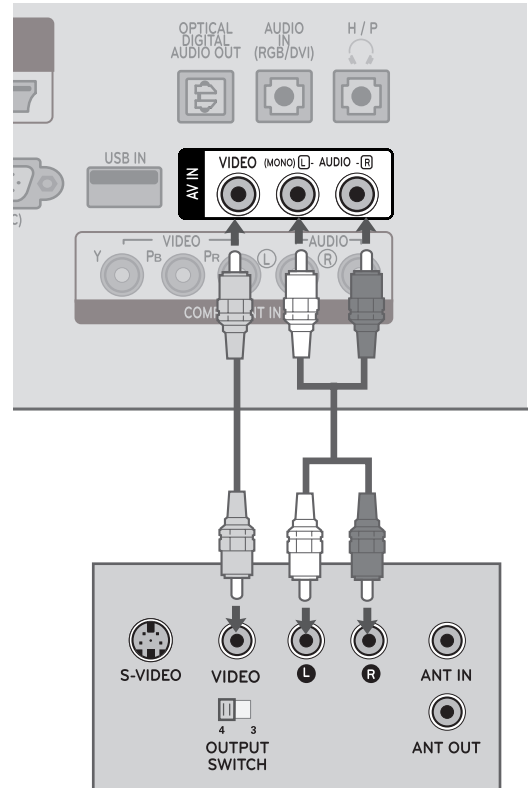

! NOTE

- ▶ If you have a mono VCR, connect the audio cable from the VCR to the **AUDIO L/MONO** jack of the set.

DIGITAL AUDIO OUT SETUP

To send the monitor SET's audio signal to external audio equipment, use the Digital Audio Output (Optical) port. If you want to enjoy digital broadcasting through 5.1-channel speakers, connect the OPTICAL DIGITAL AUDIO OUT terminal on the back of the monitor SET to a home theater (or amp).

- 1 Connect one end of an optical cable to the **OPTICAL DIGITAL AUDIO OUT** port.
- 2 Connect the other end of the optical cable to the digital audio (Optical) input on the audio equipment.
- 3 Set the **"TV Speaker option - Off "** in the AUDIO menu. (▶ P. 67)
Refer to the external audio equipment instruction manual for operation.

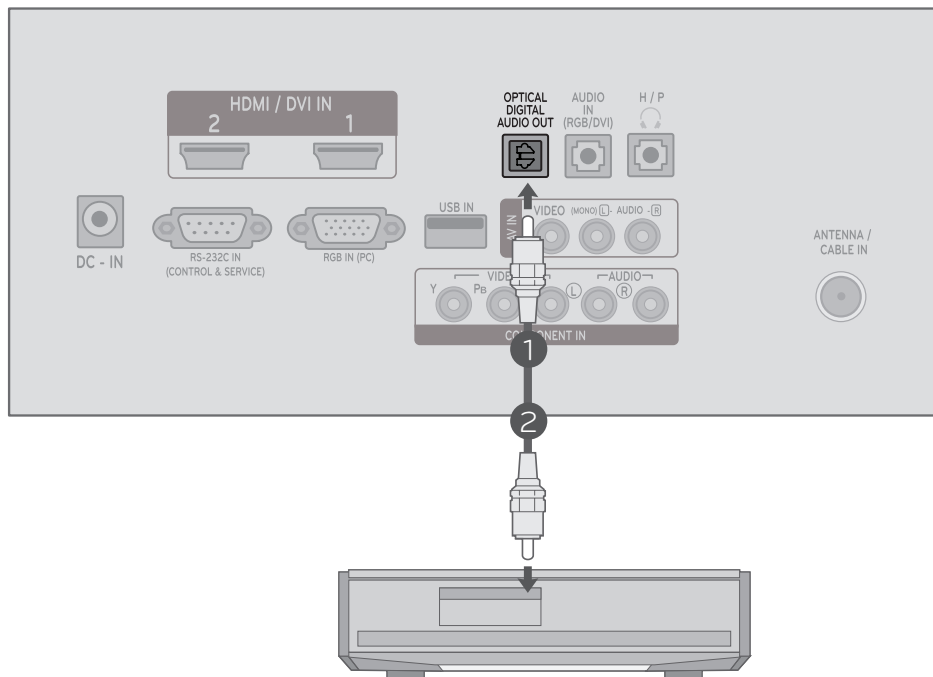

! CAUTION

▶ Do not look into the optical output port. Looking at the laser beam may damage your vision.

EXTERNAL EQUIPMENT SETUP

USB SETUP

- 1 Connect the USB device to the **USB IN** jack on the back of the Monitor set.
- 2 After connecting a USB device to the **USB IN** jack, you can use various USB functions. (► p.93)

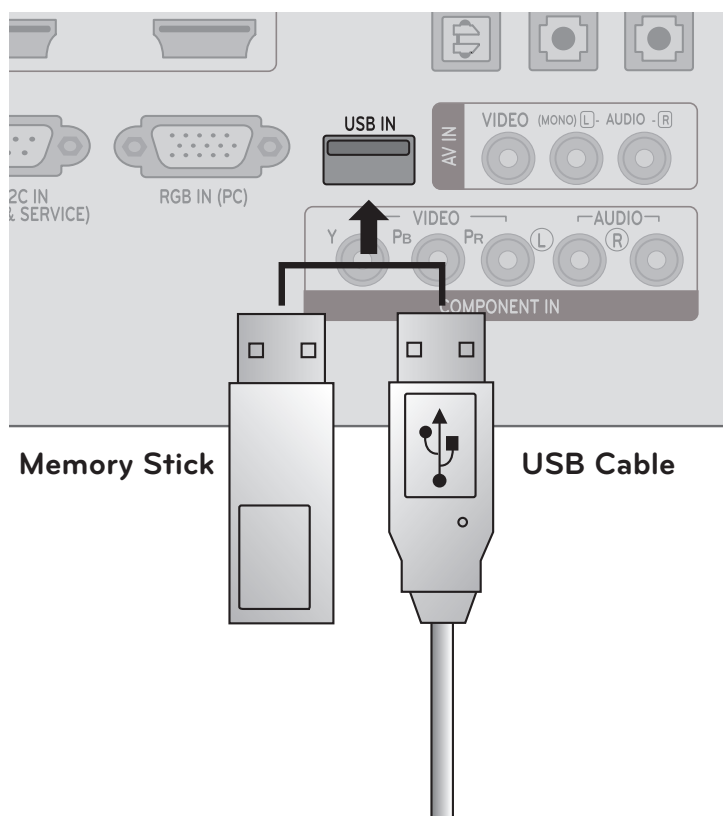

HEADPHONE SETUP

You can listen to sound through headphones plugged into the headphone jack.

- 1 Plug the headphone into the headphone socket (H/P).
- 2 To adjust the headphone volume, press the **VOL +** or **-** button. If you press the **MUTE** button, the sound from the headphone is switched off.

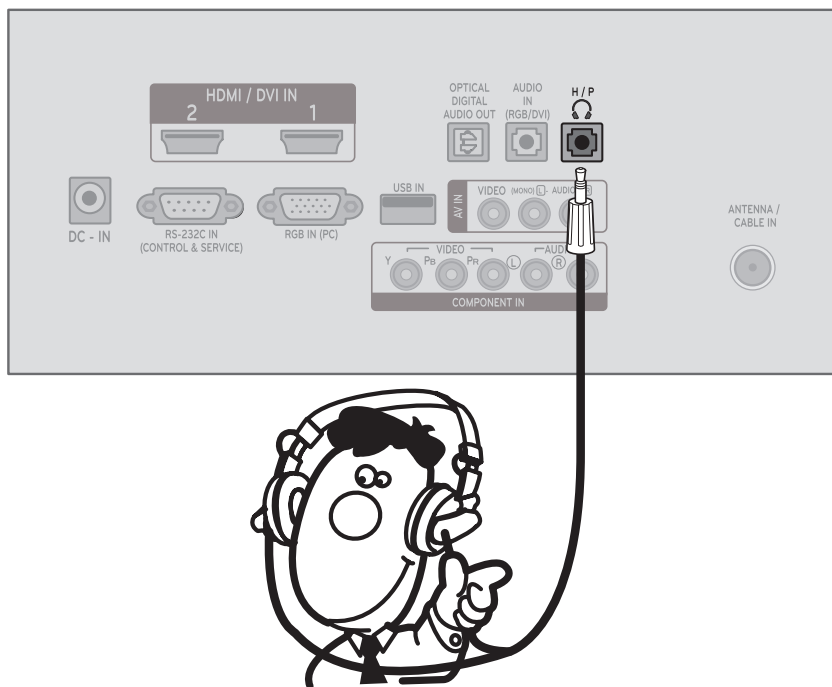

! NOTE

- ▶ AUDIO menu items are disabled when headphones are connected.
- ▶ Optical Digital Audio Out is not available when headphones are connected.

EXTERNAL EQUIPMENT SETUP

OTHER A/V SOURCE SETUP

- 1 Connect the **AUDIO/VIDEO** jacks between set and external equipment. Match the jack colors. (Video = yellow, Audio Left = white, and Audio Right = red)
- 2 Select **AV** input source with using **INPUT** on the remote control.
- 3 Operate the corresponding external equipment. Refer to external equipment operating guide.

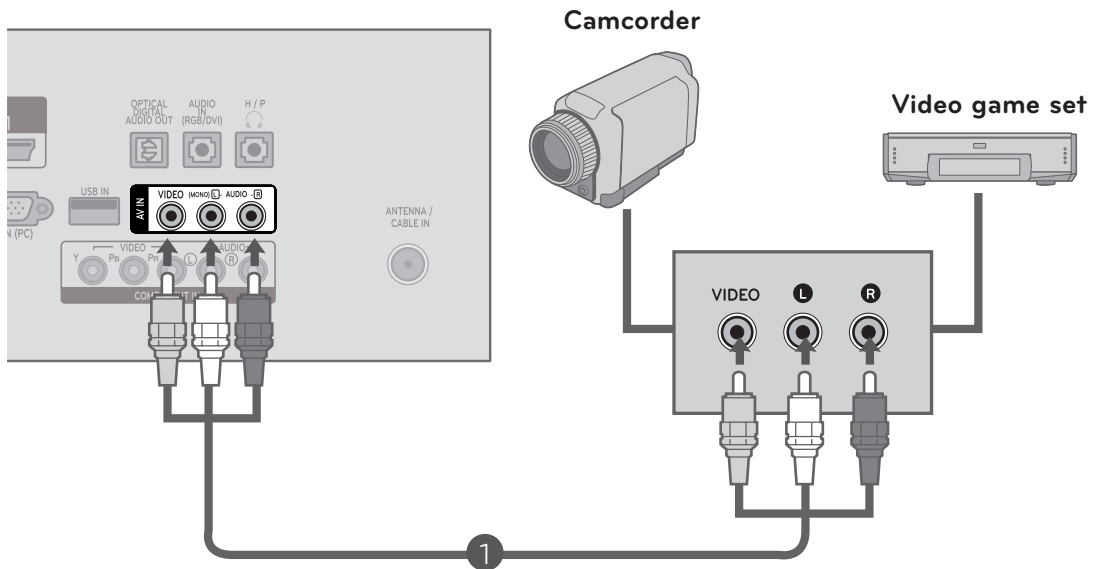

PC SETUP

When using the remote control, aim it at the remote control sensor on the Monitor set.

Connecting with a D-sub 15-pin Cable

- 1 Connect the signal cable from the monitor output socket of the PERSONAL COMPUTER to the PC input socket of the Monitor set.
- 2 Connect the audio cable from the PC to the AUDIO IN(RGB/DVI) socket of the Monitor set.
- 3 Press the **INPUT** to select **RGB-PC**.
- 4 Switch on the **PC**, and the **PC** screen appears on the set. The set can be operated as a PC monitor.

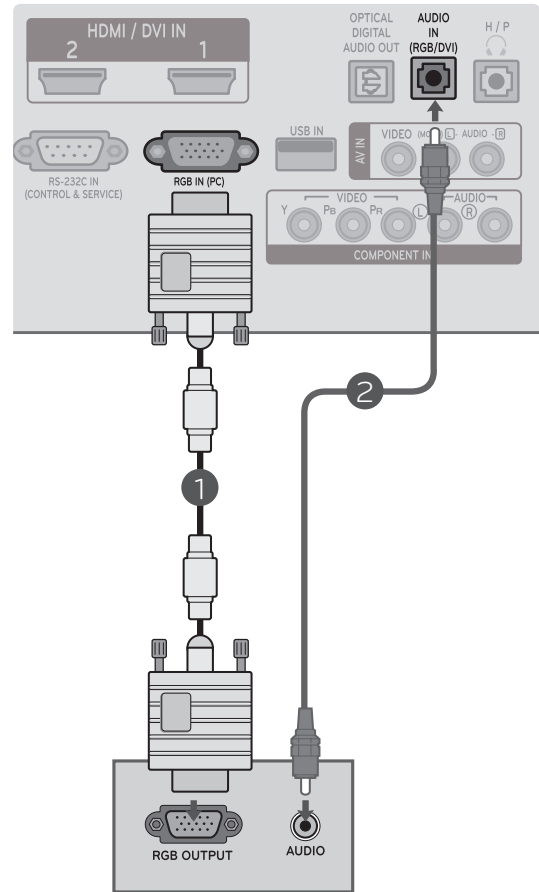

NOTE

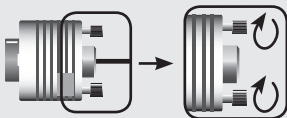

► Connect the signal input cable and tighten it by turning the screws clockwise.

EXTERNAL EQUIPMENT SETUP

Connecting with an HDMI to DVI Cable

- 1 Connect the DVI output of the PC to the **HDMI/DVI IN1** or **HDMI/DVI IN2** jack on the Monitor set.
- 2 Connect the PC audio output to the **AUDIO IN (RGB/DVI)** jack on the Monitor set.
- 3 Turn on the PC and the set.
- 4 Select **HDMI 1** or **HDMI 2** input source using the **INPUT** on the remote control.

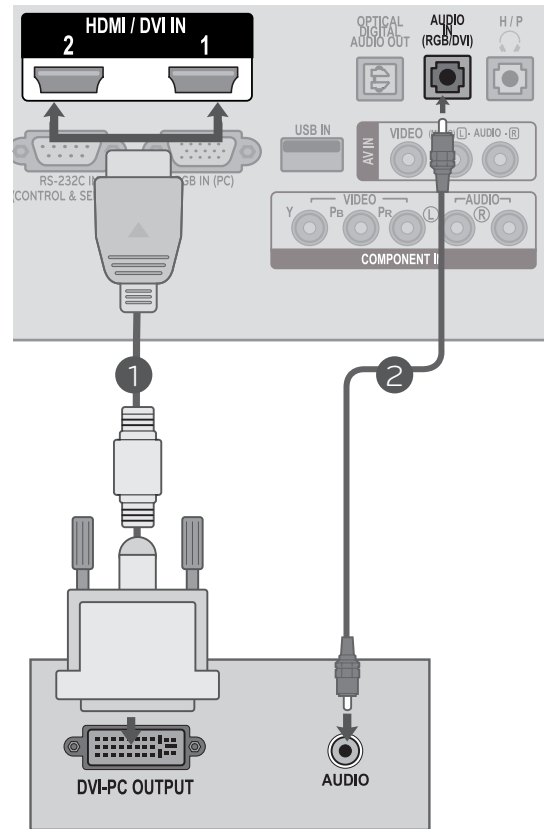

! NOTE

▶ If you want to use HDMI-PC mode, you must set the input label to PC mode.

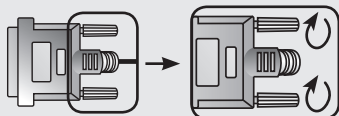

▶ Connect the signal input cable and tighten it by turning the screws clockwise.

Connecting with an HDMI to HDMI Cable

- 1 Connect the HDMI output of the PC to the **HDMI/DVI IN1** or **HDMI/DVI IN2** jack on the Monitor set.
- 2 Turn on the PC and the Monitor set.
- 3 Select **HDMI 1** or **HDMI 2** input source using **INPUT** on the remote control.

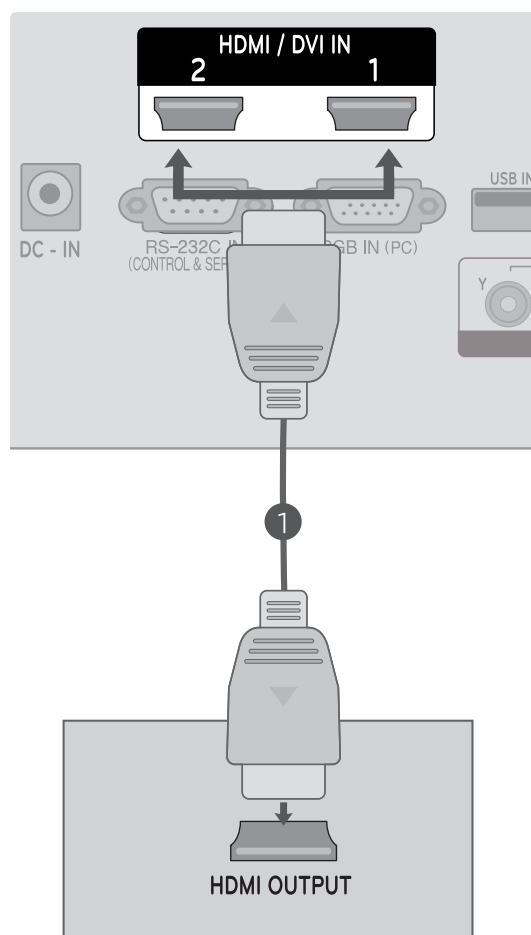

! NOTE

- ▶ Check that your HDMI cable is a high speed HDMI cable. If the HDMI cables are not high speed, flickering or no screen display can result.
- ▶ If you want to use HDMI-PC mode, you must set the input label to the PC mode.

EXTERNAL EQUIPMENT SETUP

BACK COVER WIRE ARRANGEMENT

Tie cables together for better cable management as shown in the illustration below.

M2080D / M2280D / M2380D / M2780D

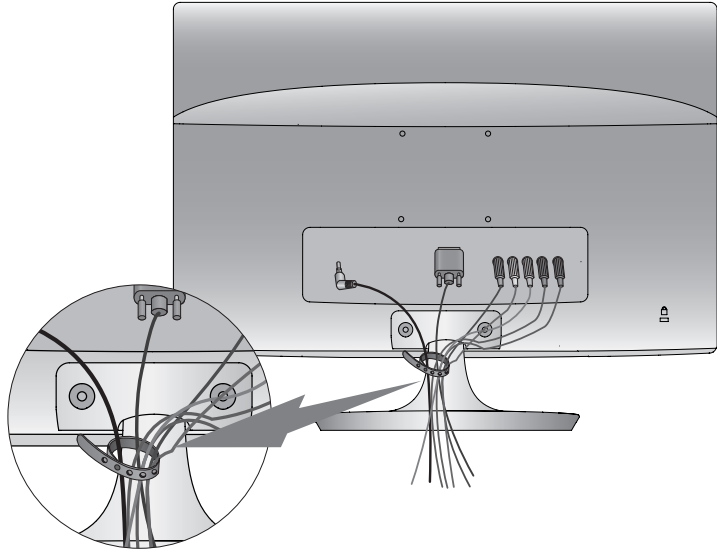

M2380DF / M2780DF

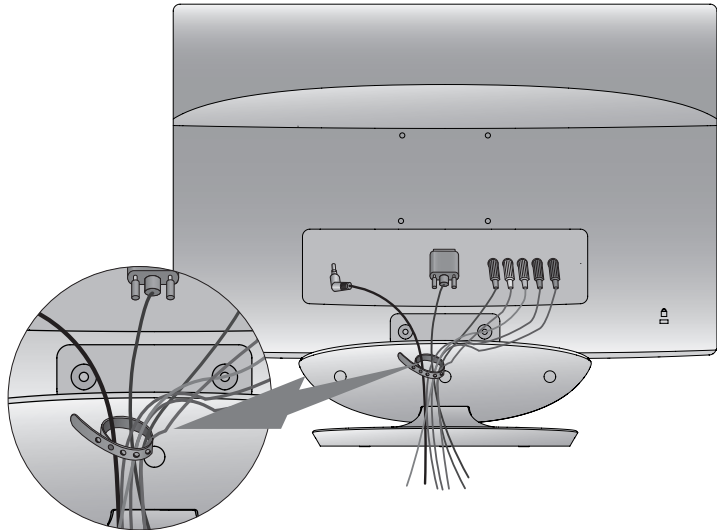

SUPPORTED DISPLAY RESOLUTIONS

RGB[PC] Mode M2080D

Resolution	Horizontal Frequency(kHz)	Vertical Frequency(Hz)
640 x 480	31.469	59.94
640 x 480	37.5	75
800 x 600	37.879	60.317
800 x 600	46.875	75
832 x 624	49.725	64.55
1024 x 768	48.363	60
1024 x 768	60.023	75.029
1280 x 1024	63.981	60.02
1600 x 900	60	60

M2280D / M2380D / M2780D M2380DF / M2780DF

Resolution	Horizontal Frequency(kHz)	Vertical Frequency(Hz)
720 x 400	31.468	70.08
640 x 480	31.469	59.94
640 x 480	37.5	75
800 x 600	37.879	60.317
800 x 600	46.875	75.0
1024 x 768	48.363	60.0
1024 x 768	60.023	75.029
1152 x 864	67.500	75.000
1280 x 1024	63.981	60.02
1280 x 1024	79.976	75.025
1680 x 1050	64.674	59.883
1680 x 1050	65.290	59.954
1600 x 1200	75.0	60.0
1920 x 1080	67.5	60

HDMI/DVI - PC Mode M2080D

Resolution	Horizontal Frequency(kHz)	Vertical Frequency(Hz)
640 x 480	31.469	59.94
640 x 480	37.5	75
800 x 600	37.879	60.317
800 x 600	46.875	75
832 x 624	49.725	64.55
1024 x 768	48.363	60
1024 x 768	60.023	75.029
1280 x 1024	63.981	60.02
1600 x 900	60	60

M2280D / M2380D / M2780D M2380DF / M2780DF

Resolution	Horizontal Frequency(kHz)	Vertical Frequency(Hz)
720 x 400	31.468	70.08
640 x 480	31.469	59.94
640 x 480	37.5	75
800 x 600	37.879	60.317
800 x 600	46.875	75.0
1024 x 768	48.363	60.0
1024 x 768	60.023	75.029
1152 x 864	67.500	75.000
1280 x 1024	63.981	60.02
1280 x 1024	79.976	75.025
1680 x 1050	64.674	59.883
1680 x 1050	65.290	59.954
1600 x 1200	75.0	60.0
1920 x 1080	67.5	60

EXTERNAL EQUIPMENT SETUP

HDMI/DVI - DTV Mode

Resolution	Horizontal Frequency(kHz)	Vertical Frequency(Hz)
720 x 480	31.469	59.94
	31.5	60
720 x 576	31.25	50
1280 x 720	37.500	50
1280 x 720	44.96	59.94
	45	60
1920 x 1080	33.72	59.94
	33.75	60
1920 x 1080	28.125	50.00
1920 x 1080	27	24
1920 x 1080	33.75	30.00
1920 x 1080	56.250	50
1920 x 1080	67.43	59.94
	67.5	60

Component Mode

Resolution	Horizontal Frequency(kHz)	Vertical Frequency(Hz)
720 x 480	15.73	59.94
720 x 480	15.75	60.00
720 x 576	15.625	50.00
720 x 480	31.47	59.94
720 x 480	31.50	60.00
720 x 576	31.25	50.00
1280 x 720	44.96	59.94
1280 x 720	45.00	60.00
1280 x 720	37.50	50.00
1920 x 1080	33.72	59.94
1920 x 1080	33.75	60.00
1920 x 1080	28.125	50.00
1920 x 1080	56.25	50
1920 x 1080	67.432	59.94
1920 x 1080	67.5	60.00

! NOTE

- ▶ Avoid keeping a fixed image on the screen for prolonged periods of time. Fixed images may become permanently imprinted on the screen. Use a screen saver when possible.
- ▶ There may be interference relating to resolution, vertical pattern, contrast or brightness in PC mode. Change the PC mode to another resolution or change the refresh rate or adjust the brightness and contrast on the menu until the picture is clear. If the refresh rate of the PC graphic card cannot be changed, change the PC graphic card or consult the manufacturer of the PC graphic card.
- ▶ The synchronization input waveform for horizontal and vertical frequencies are separate.
- ▶ Connect the signal cable from the monitor output port of the PC to the RGB (PC) port of the set or the signal cable from the HDMI output port of the PC to the HDMI/DVI IN port on the Monitor set.
- ▶ Connect the audio cable from the PC to the audio input on the Monitor set. (Audio cables are not included with the Monitor set.)
- ▶ If the graphic card on the PC does not output analog and digital RGB simultaneously, connect either the RGB or HDMI/DVI IN to display the PC output on the Monitor set.
- ▶ If the graphic card on the PC does output analog and digital RGB simultaneously, set the Monitor set to either RGB or HDMI. (The other mode is Monitor set to plug-and-play automatically by the Monitor set.)
- ▶ DOS mode may not work depending on the video card if you use an HDMI to DVI cable.
- ▶ If you use an RGB-PC cable that is too long, there may be interference on the screen. We recommend using under 5m of cable.

WATCHING TV/CHANNEL CONTROL

REMOTE CONTROL KEY FUNCTIONS

When using the remote control, aim it at the remote control sensor on the set.

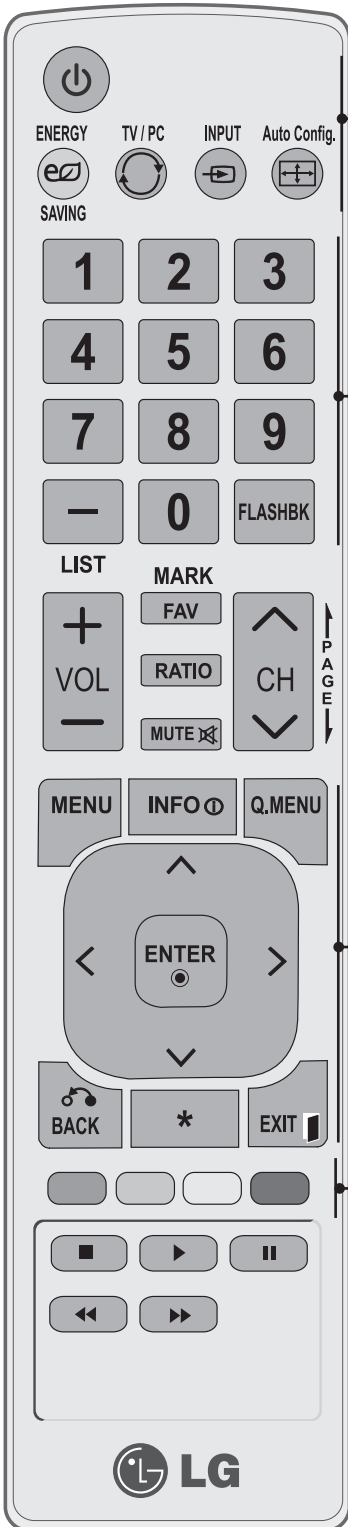

- ⏻ (POWER)** Switches the set on from standby or off to standby.
- ENERGY SAVING** Adjusts the **Energy Saving**. (▶ P. 49)
- TV/PC** Selects TV or PC mode.
- INPUT** Cycles through external input modes.
- Auto Config.** Automatically adjusts picture position and minimizes image instability.
- 0 to 9 number button** Selects a channel.
Selects numbered items in a menu.
- LIST** Displays the channel table. (▶ P. 42)
- FLASHBK** Tunes to the last channel viewed.
- MENU** Selects a menu.
Clears all on-screen displays and returns to TV viewing from any menu. (▶ P. 38)
- INFO ⓘ** Shows the present screen information.
- Q. MENU** Selects the desired quick menu source. (Aspect Ratio, Picture Mode, Sound Mode, Audio, Sleep Timer, Del/Add/Fav, Caption, USB Device). (▶ P.37)
- THUMBSTICK (Up/Down/Left/Right)** Allows you to navigate the on-screen menus and adjust the system settings to your preference.
- ENTER** Accepts your selection or displays the current mode.
- BACK** Allows the user to move return one step in an interactive application or other user interaction function.
- EXIT** Clears all on-screen displays and returns to TV viewing from any menu
- Colored buttons** Accesses special functions in some menus.

WATCHING TV/CHANNEL CONTROL



VOLUME UP/DOWN Adjusts the volume.

FAV Scrolls through programmed favorite channels. (▶ P. 43)

MARK Checks and un-checks programs in the USB menu.

RATIO Selects your desired Aspect Ratio of picture.

MUTE Switches the sound on or off.

CHANNEL UP/DOWN Changes the channel.

PAGE UP/DOWN Moves from one full set of screen information to the next one.

USB Menu Control Buttons Controls USB menu. (Photo List, Music List and Movie List).

Installing Batteries

- Open the battery compartment cover on the back side of the remote and install the batteries matching correct polarity (+with +,-with -)
- Install two 1.5 V AAA batteries. Do not mix old or used batteries with new ones.
- Close cover.
- To remove the batteries, perform the installation actions in reverse.

TURNING ON THE TV

- When your TV is turned on, you will be able to use its features.

- 1 Connect the power cord and switch the **AC power control switch** on the TV to on. The TV switches to standby mode.
 - To turn the TV on from standby mode, press the **⏻ / I**, **INPUT** or **CH▲▼** button on the TV or press **POWER**, **INPUT**, **CH▲▼** or **NUMBER (0 to 9)** on the remote control.
- 2 Select the viewing source by using the **INPUT** button on the remote control.
 - This TV is programmed to remember which power state it was last set to, even if the power cord is out.
- 3 When finished using the TV, press the **POWER** button on the remote control. The TV reverts to standby mode.

! NOTE

- ▶ If you intend to be away on vacation, disconnect the power plug from the wall power outlet.
- ▶ If you do not complete the initial setting, it will appear whenever the TV is switched on until the initial setting procedure is completed.
- ▶ If the TV is unplugged once or turns off with the AC power control switch on the TV, you will need to reset the Clock function.

CHANNEL SELECTION

- 1 Press **CH ▲ ▼** or the **NUMBER** buttons to select a channel.

VOLUME ADJUSTMENT

- 1 Press **VOL(+ or -)** to adjust the volume.
- 2 If you wish to switch the sound off, press **MUTE**.

You can cancel this function by pressing **MUTE** or **VOL(+ or -)**.

WATCHING TV/CHANNEL CONTROL

INITIAL SETTING

This function guides the user to easily set the essential items for viewing the TV for the first time. It can also be activated from the user menus.

- The default selection is **"Home Use"**. We recommend keeping the TV set to the **"Home Use"** mode for the best picture in your home environment.
- **"Store Demo"** mode is only intended for use in retail environments. Customers can adjust the **"Picture menu - Picture mode"** manually while inspecting the TV, but the TV will automatically return to preset instore mode after 5 minutes.
- **"Store Demo"** mode is an optimal setting for displaying at stores. "Store Demo" mode initializes the TV to set the image quality.
- You can also adjust **Initial Setting** in the **OPTION** menu.

Step1. Welcome

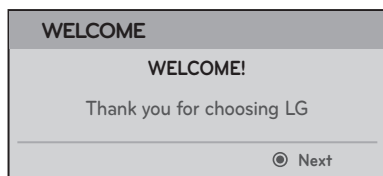

Step2. Selecting a Language

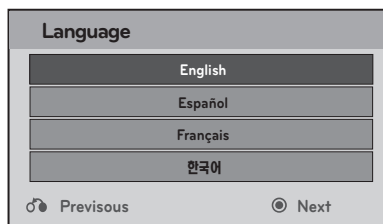

Step3. Setting the Mode

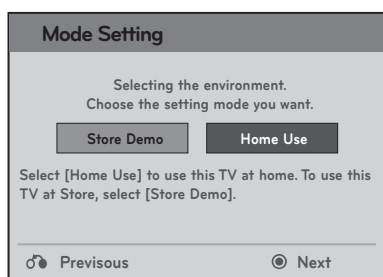

Step4. Setting the Time

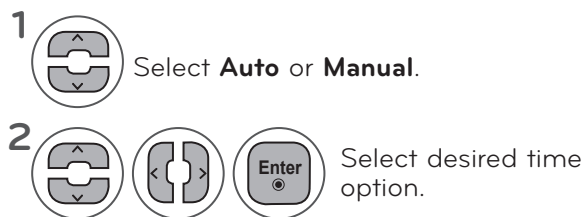
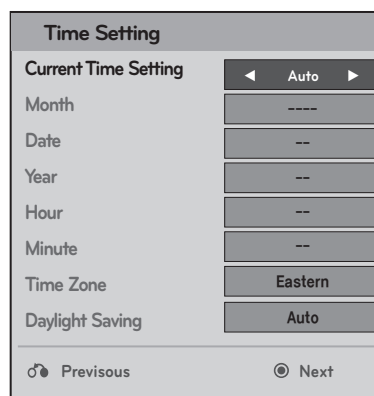

Step5. Auto Tuning

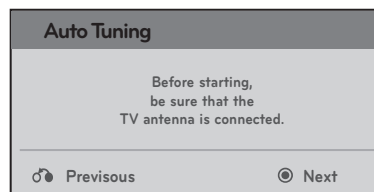







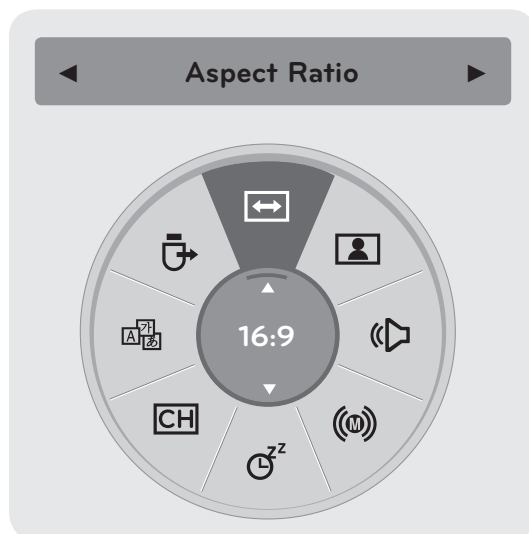





QUICK MENU

Your TV's OSD (On-Screen Display) may differ slightly from what is shown in this manual.

Q.Menu (Quick Menu) is a menu of features users might use frequently.



-  **Aspect Ratio:** Selects your desired picture format.
-  **Picture Mode:** Selects your desired Picture Mode.
-  **Sound Mode:** Selects the desired preset sound setting.
-  **Audio:** Selects the sound output.
-  **Sleep Timer:** Sets the sleep timer.
-  **Del/Add/Fav:** Selects the channel you want to add/delete or add the channel to the Favorite List.
-  **Caption:** Selects on or off.
-  **USB Device:** Selects "Eject" in order to eject a USB device.

- 1   Display each menu.
- 2  Make appropriate adjustments.
- 3  or  Return to TV viewing.

- Press **BACK** to move to the previous menu screen.



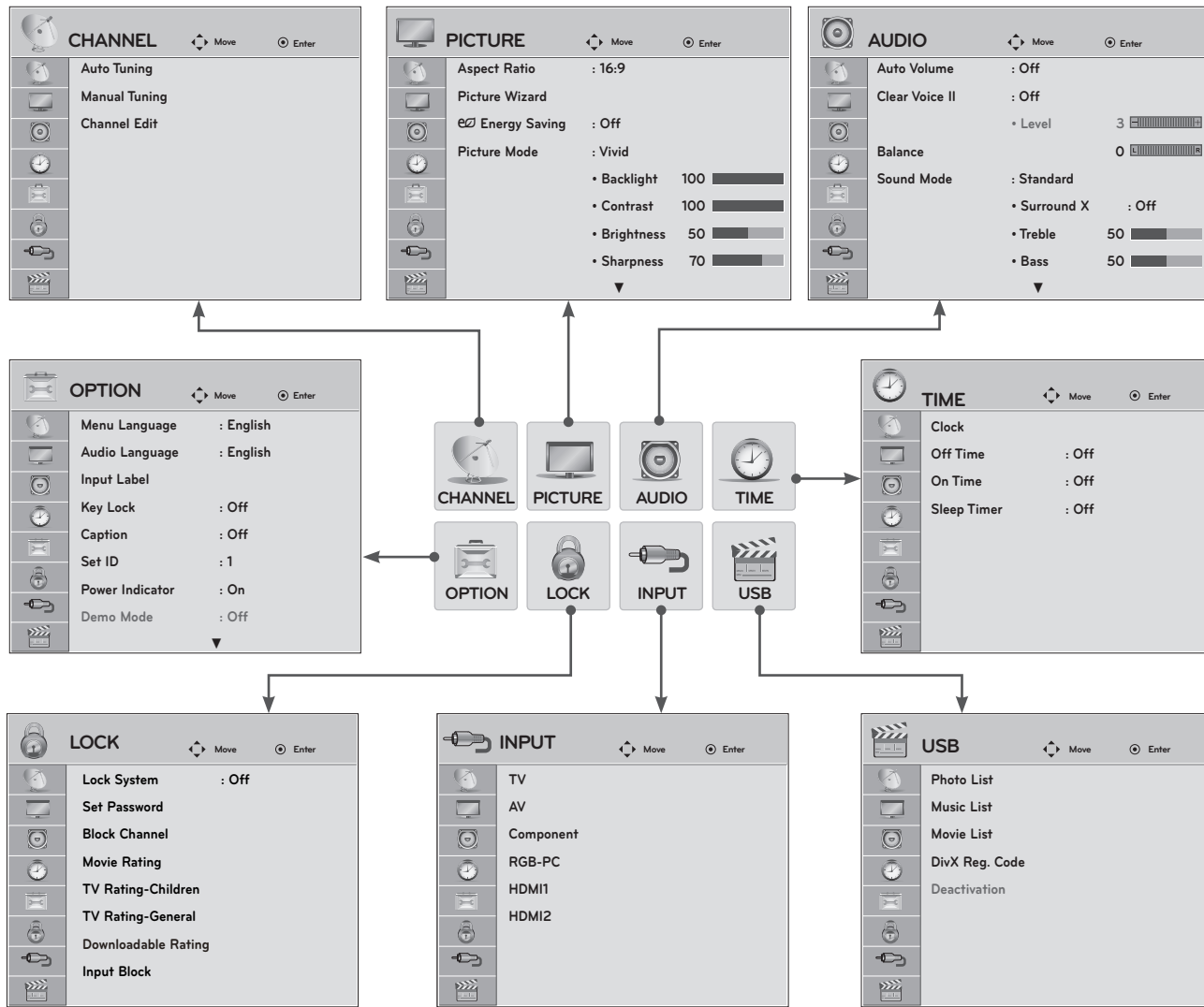

WATCHING TV/CHANNEL CONTROL

ON-SCREEN MENU SELECTION AND ADJUSTMENT

Your set's **OSD (On-Screen Display)** may differ slightly from what is shown in this manual.



WATCHING TV/CHANNEL CONTROL





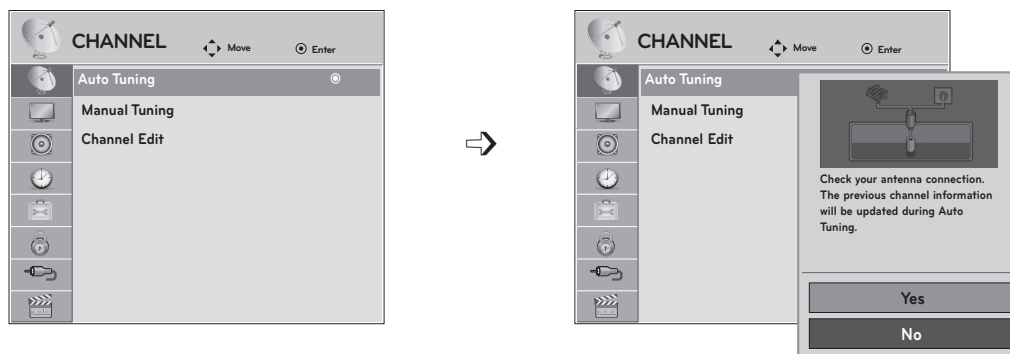

- 1   Display each menu.
- 2   Select a menu item.
- 3  Accept the current selection..

- Press **MENU** or **EXIT** to close the menu window.
- Press **BACK** to move to the previous menu screen.

AUTO SCAN (AUTO TUNING)

Use this to automatically find and store all available channels. Automatically finds all channels available through antenna or cable inputs, and stores them in memory on the channel list.



- 1   Select **CHANNEL**.
- 2   Select **Auto Tuning**.
- 3   Select **Yes**.
- 4  Run **Auto tuning**.

- The TV will ask for a password if parental control has been activated (Lock Menu). Use the password you set up in the Lock Menu to allow a channel search.
- When setting the **Auto Tuning** or **Manual Tuning**, the number of maximum channels you can store is 1,000. This number is subject to change depending on the broadcasting signal environment.



- Press **MENU** or **EXIT** to close the menu window.
- Press **BACK** to move to the previous menu screen.

WATCHING TV/CHANNEL CONTROL

ADD/DELETE CHANNEL (MANUAL TUNING)

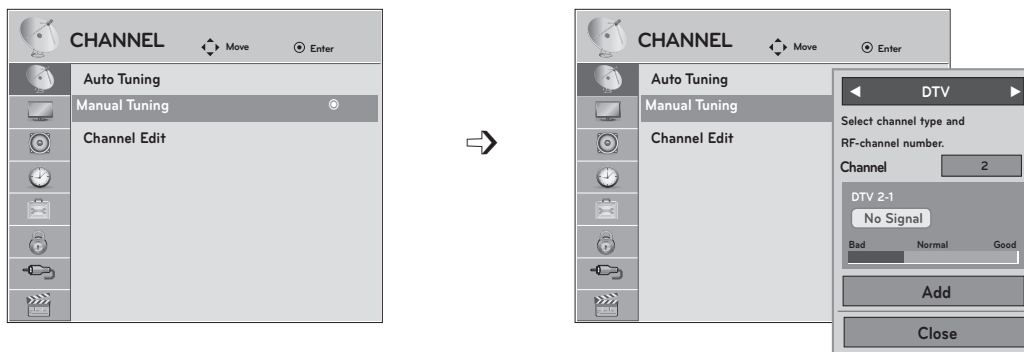
When selecting DTV or CADTV input signal in the **Manual Tuning** menu, you can view the on-screen signal strength monitor to see the quality of the signal being received.



- 1   Select **CHANNEL**.
- 2   Select **Manual Tuning**.
- 3   Select **DTV, TV, CADTV** or **CATV**.
- 4   Select channel you want to add or delete.
- 5   Select **Add** or **Delete**.
- 6 







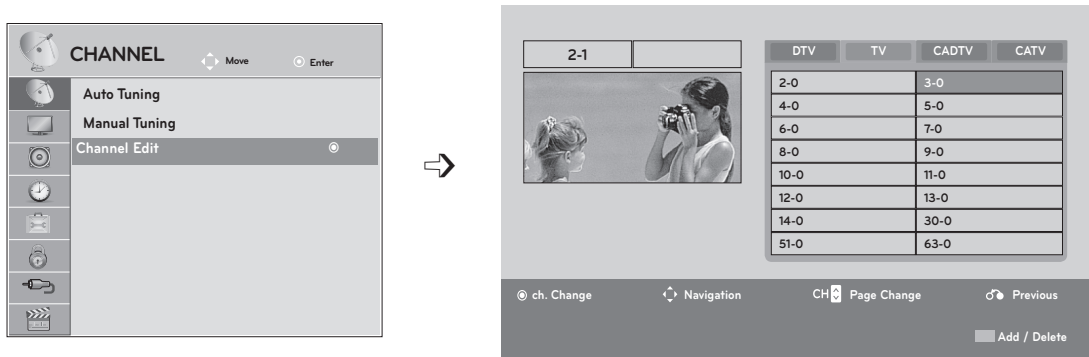

- The TV will ask for a password if parental control has been activated (LOCK Menu). Use the password you set up in the LOCK Menu to allow a channel search.
- When setting the Auto tuning or Manual tuning, the number of maximum channel you can store is 1,000. This number is subject to change depending on the broadcasting signal environment.

- Press **MENU** or **EXIT** to close the menu window.
- Press **BACK** to move to the previous menu screen.

CHANNEL EDITING

The channels in the Channel Edit List are displayed in black and the channels deleted from the Channel Edit List are displayed in blue. When a channel number is deleted, it means that you will be unable to select it using **CH** **^** **v** button during TV viewing. If you wish to select the deleted channel, directly enter the channel number with the **NUMBER** buttons or select it in the **Channel Edit** menu.



- 1   Select **CHANNEL**.
- 2   Select **Channel Edit**.
- 3   Select a channel.
- 4  Add or delete a channel.
- 5 

- Press **MENU** or **EXIT** to close the menu window.
- Press **BACK** to move to the previous menu screen.

WATCHING TV/CHANNEL CONTROL

CHANNEL LIST

You can check which channels are stored in the memory by displaying the channel label.

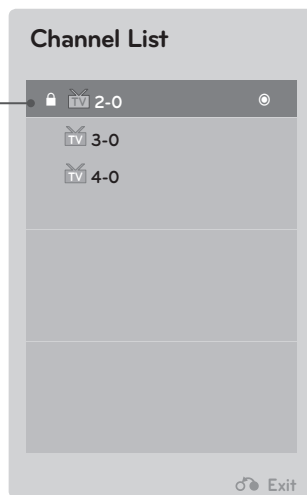

- This padlock is displayed when the channel is locked with parental control.





CHANNEL LIST

- 1  Display the **Channel List**.

SELECTING A CHANNEL IN THE CHANNEL LIST

- 1  Select a channel.
- 2  Switch to the chosen channel number.







PAGING THROUGH A CHANNEL LIST

- 1  Turn the pages.
- 2  Return to TV viewing.

FAVORITE CHANNEL SETUP

Favorite Channels are a convenient feature that let you quickly select channels of your choice without waiting for the TV to select all the channels in between. To tune to a favorite channel, press **FAV** (Favorite) repeatedly.



- 1  or  Select your desired channel.
- 2   Select **Del/Add/Fav**.
- 3  Select **Favourite**.
- 4  Return to TV viewing.

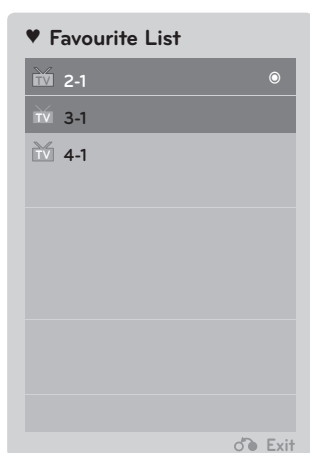

FAVORITE CHANNEL LIST





Displaying the Favorite Channel List

- 1  Display the **Favorite channel list**.

Selecting a Channel in the Favorite Channel List

- 1  Select a channel.
- 2  Switch to the chosen channel number.



Paging through a Favorite Channel List

- 1  Turn the pages.
- 2  Return to TV viewing.

WATCHING TV/CHANNEL CONTROL







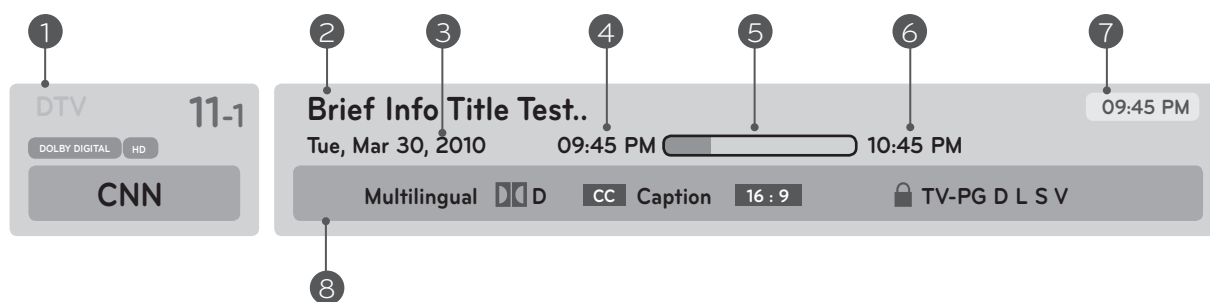

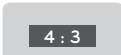

BRIEF INFORMATION

Brief Info shows the present screen information.

- 1  Show the Brief Info on the screen.
- 2  Return to TV viewing

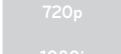

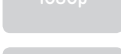



- 1 Banner information
- 2 Program title
- 3 Day, Month, Year
- 4 Program start time
- 5 Program progress bar
- 6 Program finish time
- 7 Present time

- 8  **Multilingual:** The program contains two or more audio services. Use the **Q.MENU** menu to select wanted Audio.
-  **Dolby Digital:** The program contains a Dolby Digital audio signal in TV, HDMI input source and DivX.
-  **Caption:** The program contains one or more caption services. Use the Q.MENU menu to select the desired Closed caption.
-  The original aspect ratio of the video is 4:3
-  The original aspect ratio of the video is 16:9 (wide)
-  The video resolution is 720x480i
-  The video resolution is 720x480p
-  The video resolution is 1280x720p
-  The video resolution is 1920x1080i
-  The video resolution is 1920x1080p
-  **V-Chip:** The program contains V-Chip information. Refer to the LOCK menu: A (Age), D (Dialogue), L (Language), S (Sex), V (Violence), FV (Fantasy Violence).

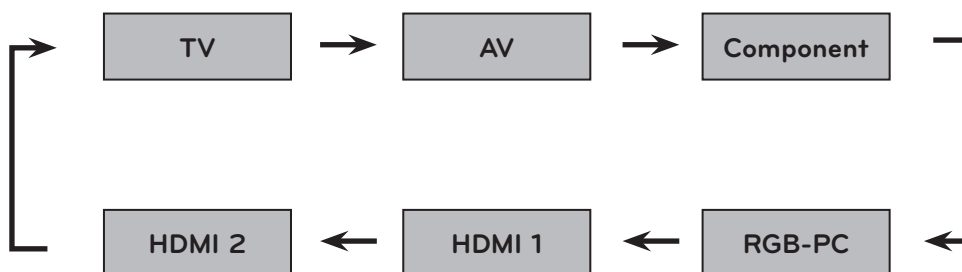
INPUT LIST

TV, HDMI, AV, Component and **RGB-PC** can be recognized by a detect pin and thus enabled only when an external device receives the approved voltage..



- 1    Select the desired input source.
You can also select the desired input source in the **INPUT** menu.

- **TV:** Watch over-the-air, cable and digital cable broadcasts.
- **AV:** Watch a VCR or external equipment.
- **Component:** Watch a DVD player or a digital set-top box.
- **RGB-PC:** View PC input.
- **HDMI 1, HDMI 2:** Watch high definition devices.

PICTURE CONTROL

ASPECT RATIO SELECTION

Image signals can be displayed in various picture formats: **16:9**, **Just Scan**, **Set By Program**, **4:3**, **Zoom** and **Cinema Zoom**. You can adjust the enlarge proportion using **^** **v** button. This function works with the signals listed below.

Note that if a fixed image is displayed on the screen for a long time, that image may become imprinted on the screen and remain visible.

1   Select **Aspect Ratio**.

2  Select the desired picture format.

- You can also adjust **Aspect Ratio** in the **PICTURE** and **Q.MENU** menu.
- Press **RATIO** repeatedly to select the desired picture format.

• 16:9

Adjust the picture horizontally, in a linear proportion to fill the entire screen.



• Just Scan

Normally, the edges of video signals are cropped 1-2%. Just Scan turns off this cropping and shows the complete video.

Note: if there is noise on the edges of the original signal, it will be visible when Just Scan is activated.

Just Scan operates only in DTV/CADTV/Component/HDMI-DTV(720p/1080i/1080p) input source.

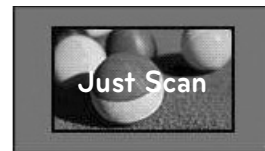

• **Set By Program**

Selects the proper picture proportion to match the source's image.

(4:3 → 4:3)



(16:9 → 16:9)

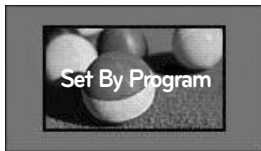

• **4:3**

Choose 4:3 when you want to view a picture with an original 4:3 aspect ratio.



• **Zoom**

Choose Zoom when you want to view the picture without any alteration. However, the top and bottom portions of the picture will be cropped.

- When adjusting in Q.MENU menu,
 - a. < or > : Adjust proportion of Zoom.
 - b. ^ or v: Move the image on the screen.



• **Cinema Zoom 1 to 16**

Choose Cinema Zoom when you want to enlarge the picture in correct proportion.

Note: When enlarging or reducing the picture, the image may become distorted.

- < or > : Adjusts proportion of Cinema Zoom. The adjustment range is 1 to 16.
- ^ or v: Moves the image on the screen.

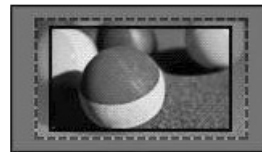

PICTURE CONTROL









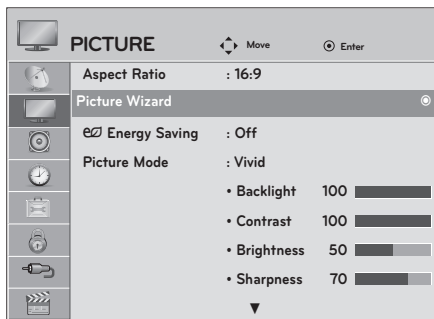

PICTURE WIZARD

This feature lets you adjust the picture quality of the original image.

Use this to calibrate the screen quality by adjusting the Black and White Level, etc. You can calibrate the screen quality by easily following each step.

When you adjust the image to **Low**, **Recommended** or **High**, you can see an example of the changes you've made.



- 1   Select **PICTURE**.
- 2    Select **Picture Wizard**.
- 3   Adjust **Black level, White level, Color, Tint, Horizontal Sharpness, Vertical Sharpness, Color Temperature, Dynamic Contrast, Color Gain, Backlight**.
- 4    Select input source to apply the settings.
- 5 





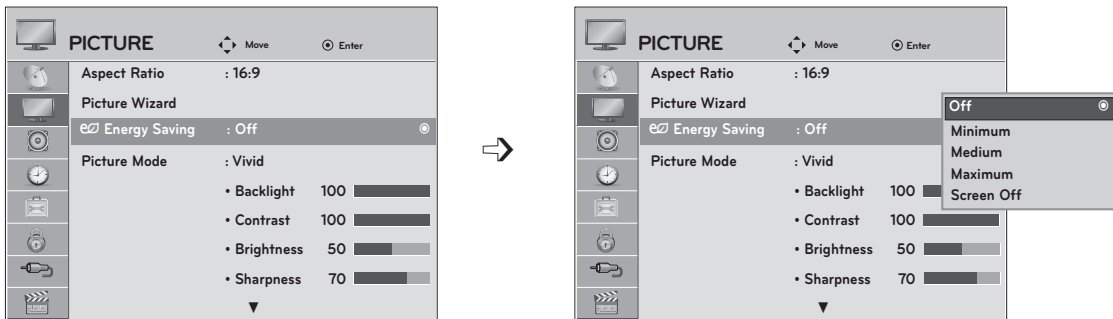

- Press **MENU** or **EXIT** to close the menu window.
- Press **BACK** to move to the previous menu screen.

- If you stop the setting before the final step, the changes will not be saved to the set.
- Once the **Picture Wizard** sets the picture quality, **Energy Saving** is changed to **Off** automatically.

e ENERGY SAVING

Reduces the set's power consumption by lowering the backlight level. You can increase the brightness of your screen by adjusting the **Energy Saving** level or by setting the **Picture Mode**.



- 1   Select **PICTURE**.
- 2   Select **e Energy Saving**.
- 3   Select **Off, Minimum, Medium, Maximum** or **Screen Off**.
- 4 

- Press **MENU** or **EXIT** to close the menu window.
- Press **BACK** to move to the previous menu screen.



- When selecting **Screen off**, the screen will turn off in 3 seconds.
- If you adjust **"Energy Saving-Minimum, Medium, Maximum"**, the Backlight feature will not work.
- Press **ENERGY SAVING** repeatedly to select the appropriate Energy Saving setup.

PICTURE CONTROL

PRESET PICTURE SETTINGS (PICTURE MODE)

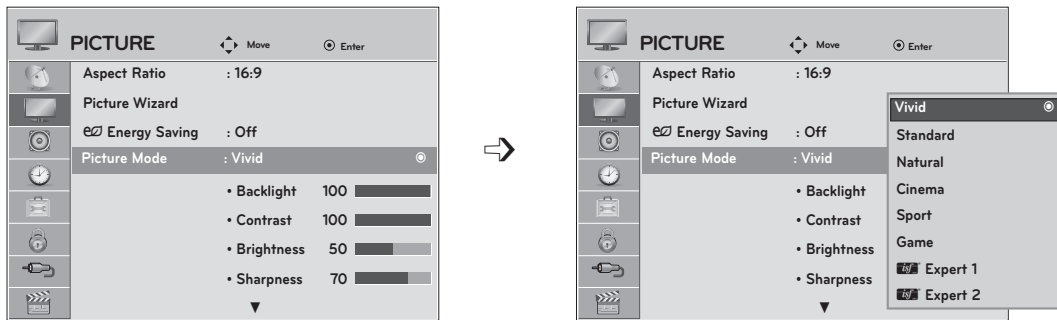
- Vivid** Maximizes the effect of the video in retail stores. Strengthen the contrast, brightness, color and sharpness for vivid picture.
- Standard** This is the optimum viewing condition for general users.
- Natural** This is the mode to display the most natural screen status.
- Cinema** This mode optimizes video for watching movie.
- Sport** This mode emphasizes dynamic video and primary colors (e.g. white, uniforms, grass, sky blue, etc.) by realizing the optimal image settings for sports.
- Game** This is the mode for fast response speeds for video games.
- Expert 1,2** User-defined settings.



- 1   Select **PICTURE**.
- 2   Select **Picture Mode**.
- 3   Select **Vivid, Standard, Natural, Cinema, Sport or Game**
- 4 









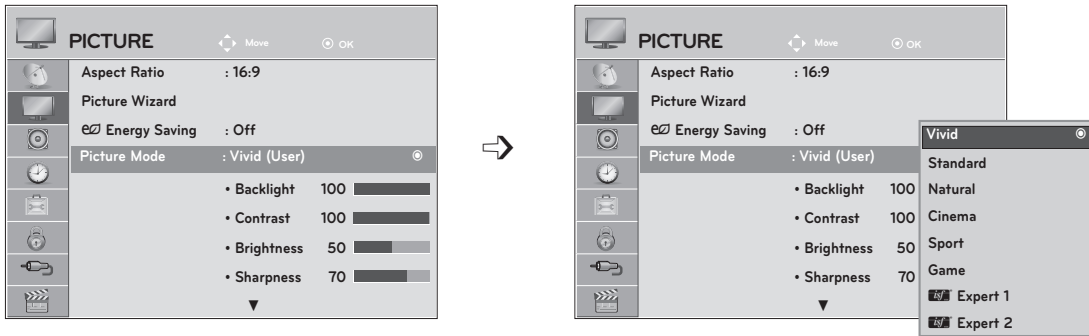

- Press **MENU** or **EXIT** to close the menu window.
- Press **BACK** to move to the previous menu screen.

- **Picture Mode** adjusts the set for the best picture appearance. Select the preset value in the **Picture Mode** menu based on the channel category.
- You can also adjust Picture Mode in the **Q. Menu**.

MANUAL PICTURE ADJUSTMENT-USER MODE

- Backlight** Adjusts the brightness of LCD panel.
- Contrast** Adjusts the difference between light and dark levels.
- Brightness** Adjusts the brightness of the screen.
- Sharpness** Adjusts the clearness of the screen.
- Color** Adjusts the color.
- Tint** Adjusts the tint.



- 1   Select **PICTURE**.
- 2   Select **Picture Mode**.
- 3   Select **Vivid, Standard, Natural, Cinema, Sport** or **Game**
- 4   Select **Backlight, Contrast, Brightness, Sharpness, Color** or **Tint**
- 5   Make appropriate adjustments.
- 6 

- Press **MENU** or **EXIT** to close the menu window.
- Press **BACK** to move to the previous menu screen.

NOTE





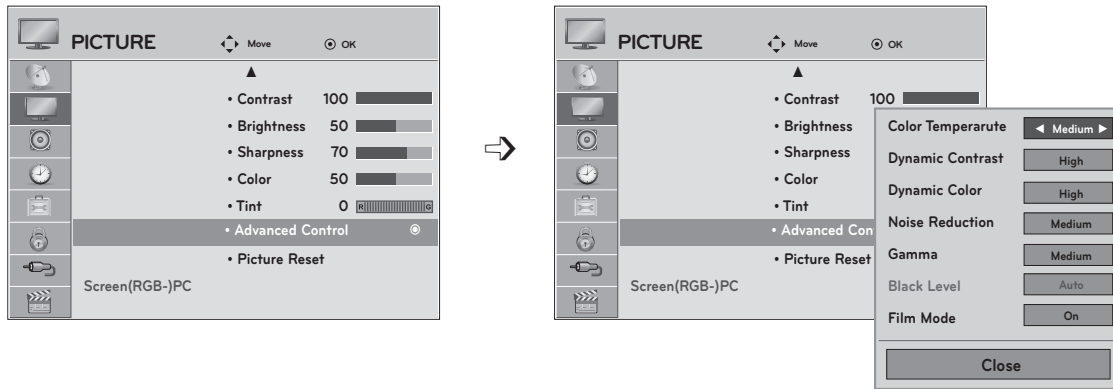

- ▶ You cannot adjust color and tint in the RGB-PC/HDMI-PC mode.
- ▶ When the **Expert 1/2** is selected, you can select **Backlight, Contrast, Brightness, H Sharpness, V Sharpness, Color** or **Tint** .

PICTURE CONTROL

PICTURE IMPROVEMENT TECHNOLOGY

You can calibrate the screen for each Picture Mode or set the video value according to the special video screen. You can set the video value differently for each input. To reset to the factory default screen after making adjustments to each video mode, execute the **"Picture Reset"** function for each **Picture Mode**.









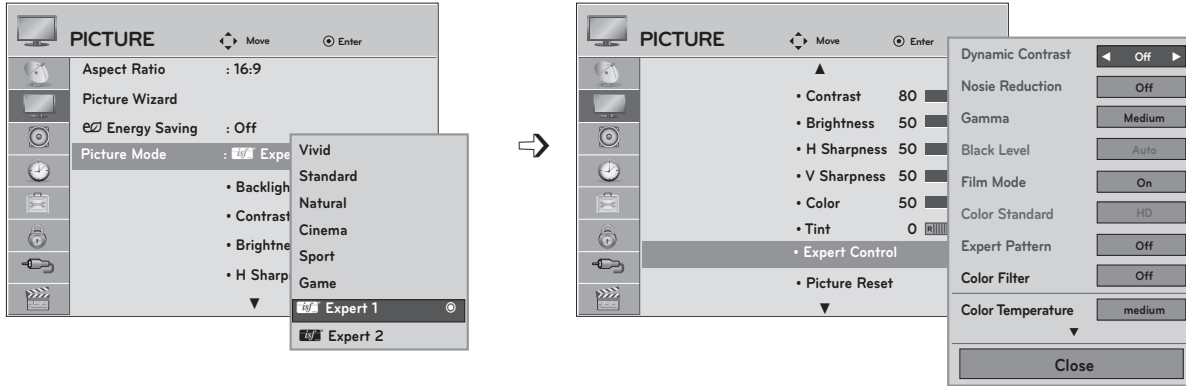

- 1   Select **PICTURE**.
- 2   Select **Advanced Control**.
- 3   Select your desired options.
- 4  Make appropriate adjustments.

- Press **MENU** or **EXIT** to close the menu window.
- Press **BACK** to move to the previous menu screen.

EXPERT PICTURE CONTROL

By segmenting categories, **Expert 1** and **Expert 2** provide more categories which users can set as they see fit, offering optimal picture quality. This may also be used to help a professional optimize the set performance using specific videos.



- 1   Select **PICTURE**.
- 2   Select **Picture Mode**.
- 3   Select  **Expert 1** or  **Expert 2**.
- 4   Select **Expert Control**.
- 5   Select your desired source.
- 6  Make appropriate adjustments.

- Press **MENU** or **EXIT** to close the menu window.
- Press **BACK** to move to the previous menu screen.

PICTURE CONTROL

Color Temperature	<ul style="list-style-type: none"> ■ Set to warm to enhance hotter colors such as red, or set to cool to enhance cooler colors such as blue.
Dynamic Contrast	<ul style="list-style-type: none"> ■ Adjusts the contrast to keep it at the best level according to the brightness of the screen. The picture is improved by making bright parts brighter and dark parts darker.
Dynamic Color	<ul style="list-style-type: none"> ■ Adjusts screen colors so that they look livelier, richer and clearer. This feature enhances hue, saturation and luminance so that red, blue, green and white look more vivid.
Noise Reduction	<ul style="list-style-type: none"> ■ Reduces screen noise without compromising video quality.
Gamma	<ul style="list-style-type: none"> • Low: Makes dark and middle gray level areas of the picture brighter. • Medium: Express original picture levels. • High: Makes dark and middle gray level area of the picture darker. ■ You can adjust the brightness of dark areas and middle gray level areas of the picture.
Black Level	<ul style="list-style-type: none"> • Low: The reflection of the screen gets darker. • High: The reflection of the screen gets brighter. ■ Sets black level of the screen to a proper level. ■ This function enables you to select 'Low' or 'High' in the following mode: AV (NTSC-M), HDMI or Component. Otherwise, 'Black level' is set to 'Auto'.
Film Mode	<ul style="list-style-type: none"> ■ Makes video clips recorded in film look more natural by eliminating jitter effect.
Color Standard	<ul style="list-style-type: none"> ■ Convert the color of a different video to HD color.
Color Filter	<ul style="list-style-type: none"> ■ Filters the specific colors of the video. You can use the RGB filter to set color saturation and hue accurately.
Expert Pattern	<ul style="list-style-type: none"> ■ This is the pattern necessary for expert adjustment. ■ This function is enabled in "Picture Mode - Expert" when you watch DTV.

White Balance

- Adjusts the overall color of the screen.
 - a. Method : 2 Points
 - Pattern: Inner, Outer
 - Red/Green/Blue Contrast, Red/Green/Blue Brightness: The adjustment range is -50 to +50.
 - b. Method : 10 Point IRE
 - Pattern: Inner, Outer
 - IRE (Institute of Radio Engineers) is the unit to display the size of the video signal and can be set among 10, 20, 30 - 100. You can adjust Red, Green or Blue according to each setting.
 - Luminance: This function displays calculated luminance value for 2.2 gamma. You can input luminance value you want at 100 IRE, than the target luminance value for 2.2 gamma is displayed at every 10 steps from 10 IRE to 90 IRE.
 - Red/Green/Blue: The adjustment range is -50 to +50.

Color Management System





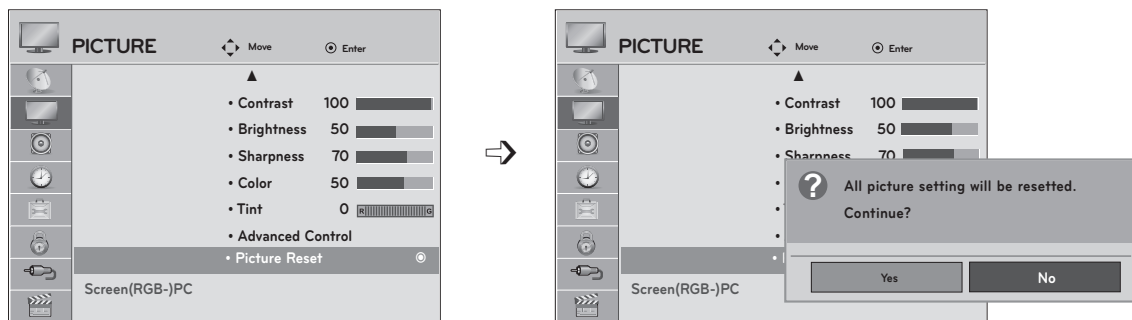

- A tool used by the experts to make adjustments by using the test patterns, this does not affect other colors but can be used to selectively adjust the 6 color areas (Red/Green/Blue/Cyan/Mgt/Yellow). Color difference may not be distinctive even when you make the adjustments for general video. Adjusts Red/Green/Blue/Yellow/Cyan/Magenta.
 - Red/Green/Blue/Yellow/Cyan/Magenta Color: The adjustment range is -30 to +30.
 - Red/Green/Blue/Yellow/Cyan/Magenta Tint: The adjustment range is -30 to +30.
 - This feature is disabled in RGB-PC and HDMI-PC mode.

PICTURE CONTROL

PICTURE RESET

Return the settings of the selected Picture Mode to the default factory settings.



- 1   Select **Picture**.
- 2   Select **Picture Reset**.
- 3   Select **Yes** or **No**.
- 4 







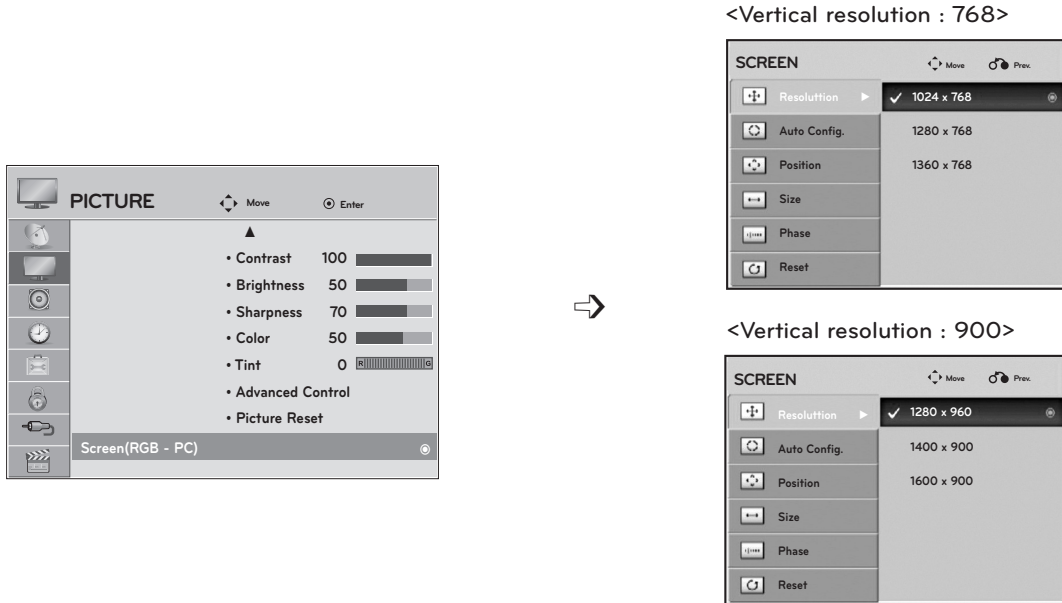

- Press **MENU** or **EXIT** to close the menu window.
- Press **BACK** to move to the previous menu screen.

SCREEN SETUP FOR PC MODE

Selecting Resolution

To view a normal picture, match the resolution of RGB mode and selection of PC mode. This function works in RGB-PC mode



- 1   Select **Picture**.
- 2   Select **Screen (RGB-PC)**.
- 3   Select **Resolution**.
- 4   Select the desired resolution.
- 5 

- Press **MENU** or **EXIT** to close the menu window.
- Press **BACK** to move to the previous menu screen.

PICTURE CONTROL

Auto Configure (RGB-PC Mode Only)

Automatically adjusts picture position and minimizes image instability. After adjustment, if the image is still not correct, your set is functioning properly but needs further adjustment.

Auto Configure

This function is for automatic adjustment of the screen position, clock, and phase. The displayed image will be unstable for a few seconds while the auto configuration is in progress.

1. Using OSD

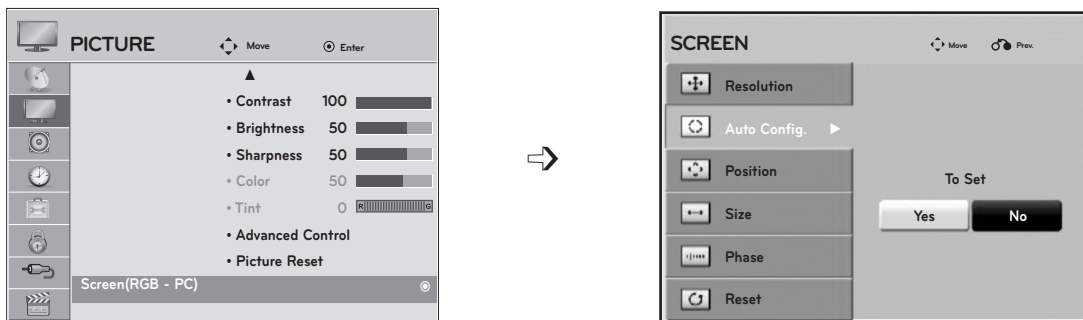

- 1 Select **PICTURE**.
- 2 Select **Screen (RGB-PC)**.
- 3 Select **Auto Config.**
- 4 Select **Yes**.

- If the position of the image is still not correct, try Auto adjustment again.
- If picture needs to be adjusted again after Auto adjustment in RGB-PC, you can adjust the Position, Size or Phase.

- 5 Run **Auto Config.**

- Press **MENU** or **EXIT** to close the menu window.
- Press **BACK** to move to the previous menu screen.

2. Using Auto Config. (Remocon)

This function is available for RGB signals only.

<M2080D>

- 1 Press **Auto Config.**

Auto in progress

! Auto in progress
For optimal display
change resolution 1600 x 900

<1600 x 900 Resolution>

<Others Resolution>

<M2280D/M2380D/M2780D/M2380DF/M2780DF>

- 1 Press **Auto Config.**

Auto in progress

! Auto in progress
For optimal display
change resolution 1920 x 1080

<1920 x 1080 Resolution>











<Others Resolution>

Adjustment for Screen Position, Size, Phase

If the picture is not clear after auto adjustment and especially if characters are still shaking, adjust the picture phase manually.

This function works in RGB-PC mode.



- 1   Select **PICTURE**.
- 2   Select **Screen (RGB-PC)**.
- 3   Select **Position, Size** or **Phase**.
- 4    Make appropriate adjustments.
- 5 









- Press **MENU** or **EXIT** to close the menu window.
- Press **BACK** to move to the previous menu screen.

PICTURE CONTROL

Screen Reset

Returns **Position**, **Size** and **Phase** to the factory default settings.
This function works in RGB-PC mode.



- 1   Select **PICTURE**.
- 2   Select **Screen (RGB-PC)**.
- 3   Select **Reset**.
- 4   Select **Yes**.
- 5  Run **Reset**.





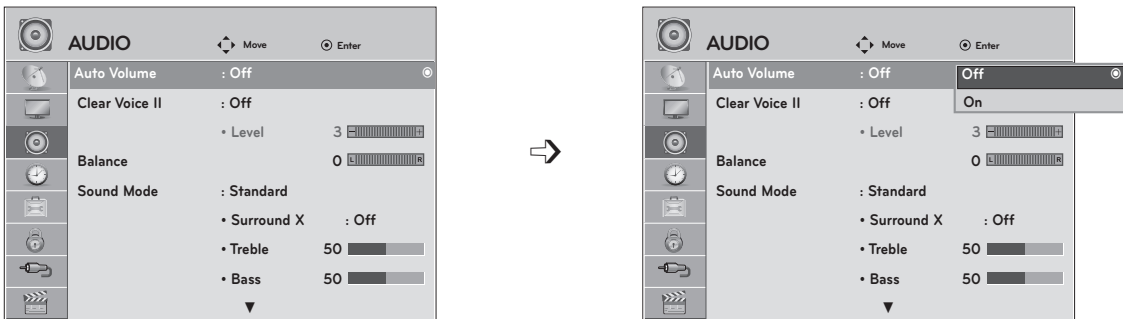

- Press **MENU** or **EXIT** to close the menu window.
- Press **BACK** to move to the previous menu screen.

SOUND CONTROL

AUTO VOLUME LEVELER (AUTO VOLUME)

Auto Volume makes sure that the volume level remains consistent whether you are watching a commercial or a regular TV program. Because each broadcasting station has its own signal conditions, volume adjustment may be needed every time the channel is changed. This feature allows users to enjoy stable volume levels by making automatic adjustments for each program.



- 1   Select **AUDIO**.
- 2   Select **Auto Volume**.
- 3   Select **On** or **Off**.
- 4 



- Press **MENU** or **EXIT** to close the menu window.
- Press **BACK** to move to the previous menu screen.

SOUND CONTROL

CLEAR VOICE II

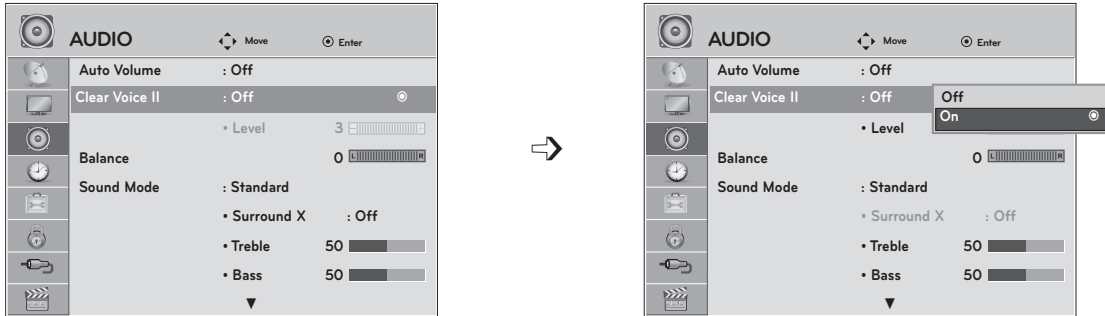
By differentiating the human sound range from others, **Clear Voice II** improves the sound quality of voices.



- 1   Select **AUDIO**.
- 2   Select **Clear Voice II**.
- 3   Select **On** or **Off**.

- If you select **"On"** for **Clear Voice II**, the **Surround X** feature will not work.
- Select levels from '-6' to '+6'.

Adjustment for Clear Voice Level Selecting On





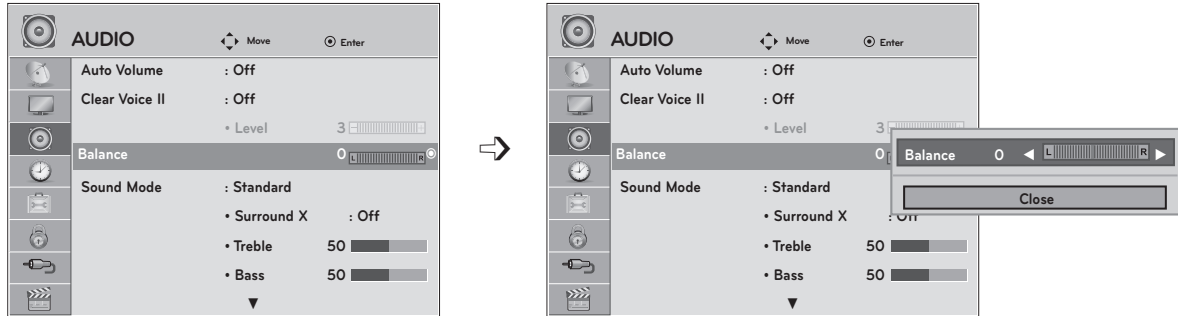

- 4   Select **Level**.
- 5   Make appropriate adjustments.

- Press **MENU** or **EXIT** to close the menu window.
- Press **BACK** to move to the previous menu screen.

BALANCE

Adjust the left/right sound of the speakers to suit your taste and room situations.



- 1   Select **AUDIO**.
- 2   Select **Balance**.
- 3   Make appropriate adjustments.

- Press **MENU** or **EXIT** to close the menu window.
- Press **BACK** to move to the previous menu screen.





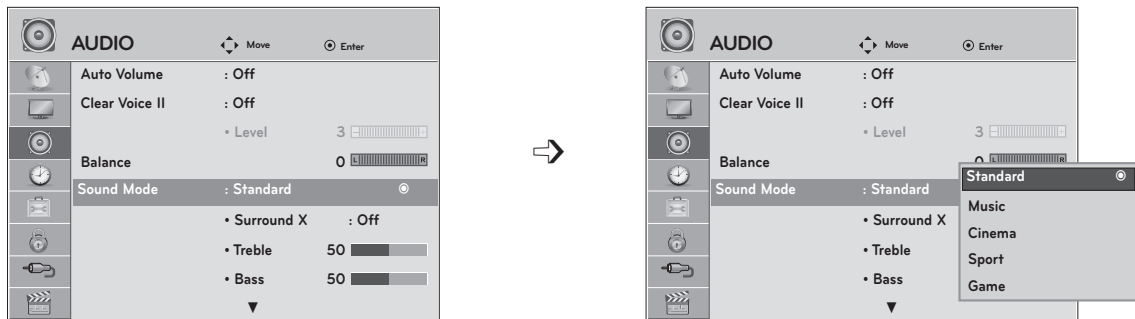

SOUND CONTROL

PRESET SOUND SETTINGS-SOUND MODE

You can select your preferred sound setting; **Standard, Music, Cinema, Sport** or **Game** and you can also adjust the **Treble** or **Bass**. **Sound Mode** lets you enjoy the best sound without any special adjustment as the TV sets the appropriate sound options based on the program content. **Standard, Music, Cinema, Sport** and **Game** are preset for optimum sound quality at the factory.

- Standard** Offers standard-quality sound.
- Music** Optimizes sound for listening to music.
- Cinema** Optimizes sound for watching movies.
- Sport** Optimizes sound for watching sports events.
- Game** Optimizes sound for playing video games.



- 1   Select **AUDIO**.
- 2   Select **Sound Mode**.
- 3   Select **Standard, Music, Cinema, Sport** or **Game**.
- 4 









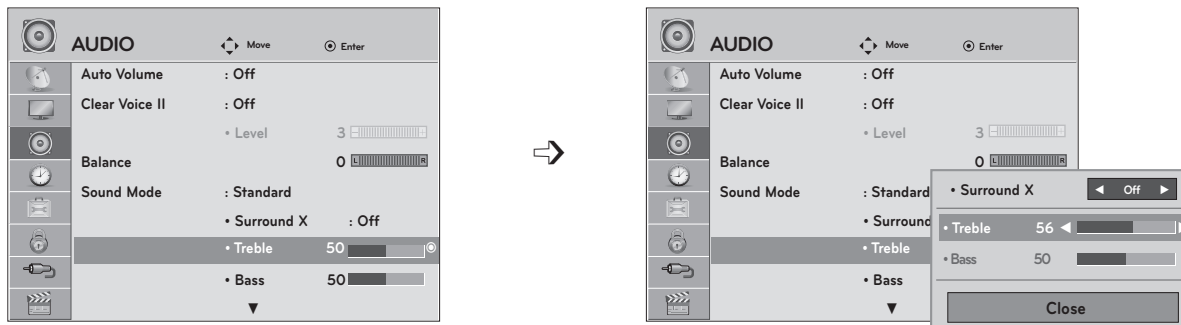

• You can also adjust **Sound Mode** in the **Q Menu**.

- Press **MENU** or **EXIT** to close the menu window.
- Press **BACK** to move to the previous menu screen.

PRESET SOUND SETTINGS-USER MODE







Adjust the sound to suit your taste and room situations.



- 1   Select **AUDIO**.
- 2   Select **Sound Mode**.
- 3   Select **Standard, Music, Cinema, Sport** or **Game**.
- 4   Select **Treble** or **Bass**.
- 5   Make appropriate adjustments.

Surround X

This option enhances sound depth and clarity by maximizing the Surround effect.

- 1   Select **AUDIO**.
- 2   Select **Surround X**.
- 3   Select **On** or **off**
- 4 

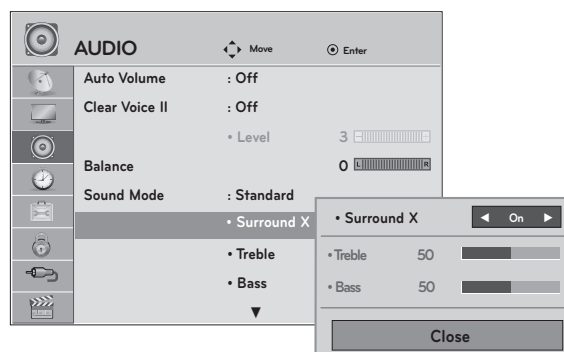





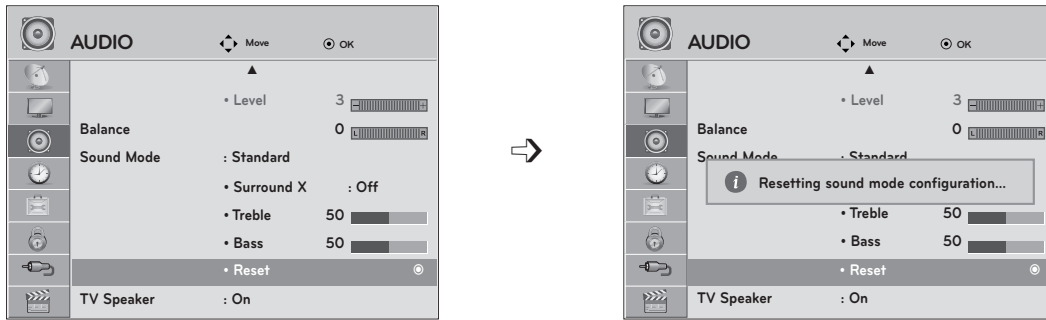

- Press **MENU** or **EXIT** to close the menu window.
- Press **BACK** to move to the previous menu screen.

SOUND CONTROL

AUDIO RESET

Return the settings of the selected Sound Mode to the default factory settings.



- 1   Select **AUDIO**.
- 2   Select **Reset**.
- 3  Initialize the adjusted value.

- Press **MENU** or **EXIT** to close the menu window.
- Press **BACK** to move to the previous menu screen.

TV SPEAKERS ON/OFF SETUP

You can adjust the SET internal speaker status.

In **AV**, **COMPONENT**, **RGB** and **HDMI 1/2** with **HDMI** to **DVI** cable, the TV speaker can be operational even when there is no video signal. If you wish to use an external Hi-Fi system, turn off the SET's internal speakers.

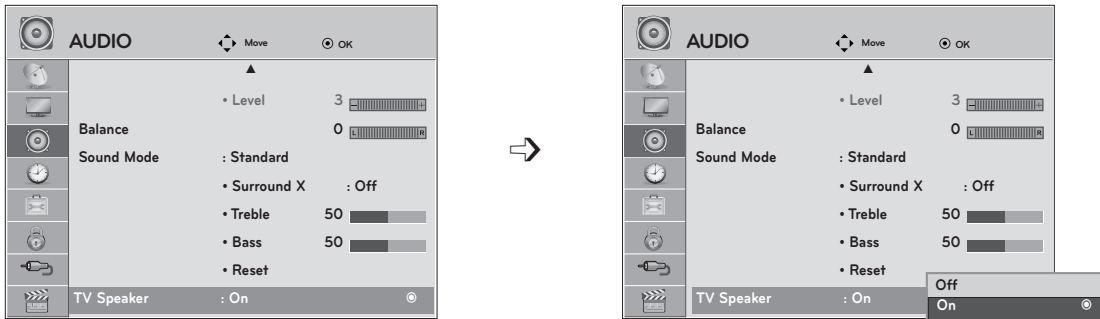

- 1   Select **AUDIO**.
- 2   Select **TV Speaker**.
- 3   Select **On** or **Off**.
- 4 

- Press **MENU** or **EXIT** to close the menu window.
- Press **BACK** to move to the previous menu screen.





SOUND CONTROL

STEREO/SAP BROADCAST SETUP

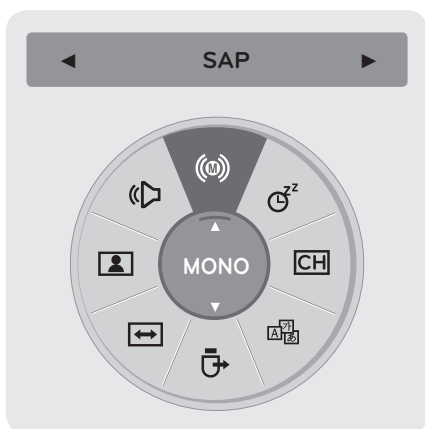
On analog signals, this set can receive MTS stereo programs and any SAP (Secondary Audio Program) that accompanies the stereo program if the station transmits an additional sound signal. Mono sound is automatically used if the broadcast is only in Mono.





Analog TV



- 1   Select **SAP**.
- 2  Select **Mono, Stereo** or **SAP**.
- 3  or  Return to TV viewing.

Digital TV



- 1   Select **Multi Audio**.
- 2  Select a **language**
- 3  or  Return to TV viewing.









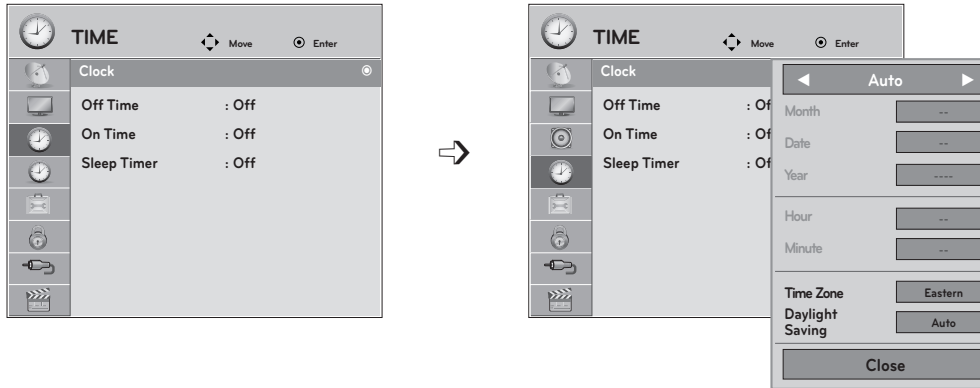

TIME SETTING

CLOCK SETUP

Auto Clock Setup

The time is set automatically from a digital channel signal. The digital channel signal includes information for the current time provided by the broadcasting station. Monitor set the clock manually if the current time is Monitor set incorrectly by the auto clock function.



- 1   Select **TIME**.
- 2   Select **Clock**.
- 3   Select **Auto**.
- 4   Select your viewing area time zone.
 - U.S.A: **Eastern, Central, Mountain, Pacific, Alaska** or **Hawaii**.
 - Canada: **Eastern, Central, Mountain, Pacific, New F. land** or **Atlantic**.
- 5   Select **Auto, Off** or **On** (depending on whether or not your viewing area observes Daylight Saving time).

- Press **MENU** or **EXIT** to close the menu window.
- Press **BACK** to move to the previous menu screen.

• If this set is unplugged once or turn off with the AC power control switch on the set and the **Clock** function.







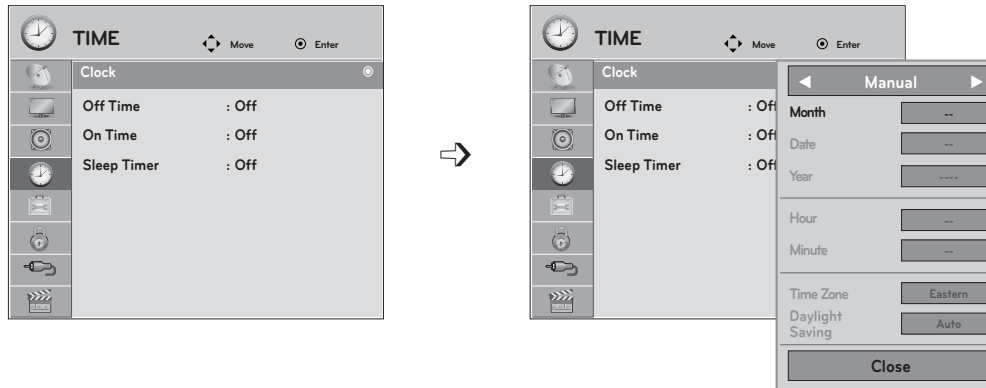

TIME SETTING

Manual Clock Setup

If the current time setting is wrong, reset the clock manually.

If this Monitor set is unplugged or turns off with the AC power control, switch on the Monitor set and reset the **Clock** function.



- 1   Select **Time**.
- 2   Select **Clock**.
- 3   Select **Manual**.
- 4  Select the **Year, Month, Date, Hour, or Minute** option.
- 5  Set the **Year, Month, Date, Hour, or Minute** option.

- Press **MENU** or **EXIT** to close the menu window.
- Press **BACK** to move to the previous menu screen.

AUTO ON/OFF TIME SETTING

This function operates only if the current time has been Monitor set.

The **Off Time** function overrides the **On Time** function if they are both set to the same time.

The Monitor set must be in standby mode for the **On Time** to work.

If you do not press any button within 2 hours after the set turns on with the **On Time** function, the Monitor set will automatically revert to standby mode.

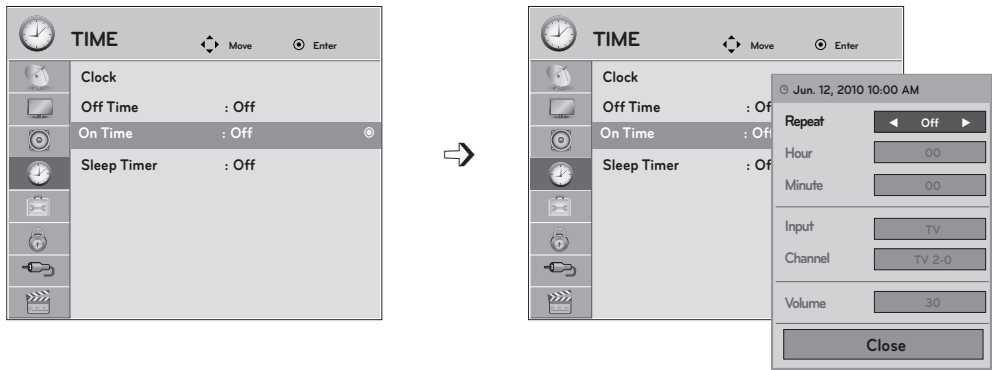

- 1 Select **Time**.
- 2 Select **Off Time** or **On Time**.
- 3 Select **Repeat**.
- 4 Select **Off, Once, Daily, Mon to Fri, Mon to Sat, Sat to Sun** or **Sun**.
- 5 Set the **Hour** or **Minute**.

- To cancel **On/Off Time** function, select **Off**.
 - For **On Time** function only
- 1 Select **Input**.
 - 2 Select the desired input source.
 - 3 When selecting set: set the channel at turn-on.
 - 4 Adjust to sound level at turn-on.



- Press **MENU** or **EXIT** to close the menu window.
- Press **BACK** to move to the previous menu screen.

TIME SETTING

SLEEP TIMER SETTING

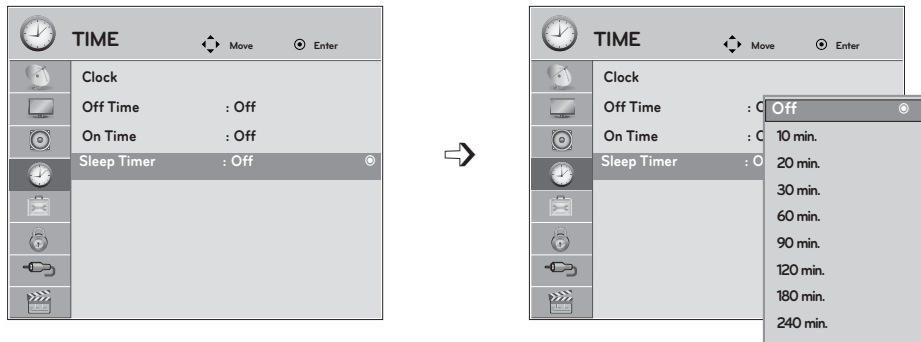
The Sleep Timer turns the Monitor set off at the preset time. Note that this setting is cleared when the Monitor set is turned off.



- 1   Select **TIME**.
- 2   Select **Sleep Timer**.
- 3   Make appropriate adjustments.
- 4 

- Press **MENU** or **EXIT** to close the menu window.
- Press **BACK** to move to the previous menu screen.





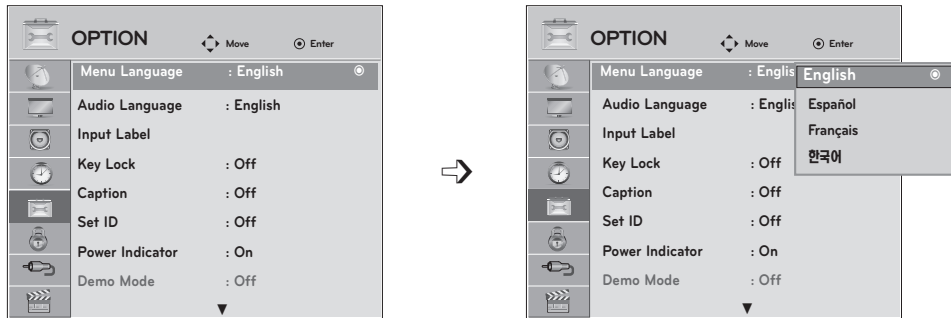

- To cancel the **Sleep Timer**, select **Off**.
- You can also adjust **Sleep Timer** in the **Q.MENU**.

OPTIONAL SETTINGS

ON-SCREEN MENUS LANGUAGE SELECTION

The menus can be shown on the screen in the selected language.



-   Select **OPTION**.
-   Select **Menu Language**.
-   Select your desired language.
From this point on, the on-screen menus will be shown in the selected language.
- 





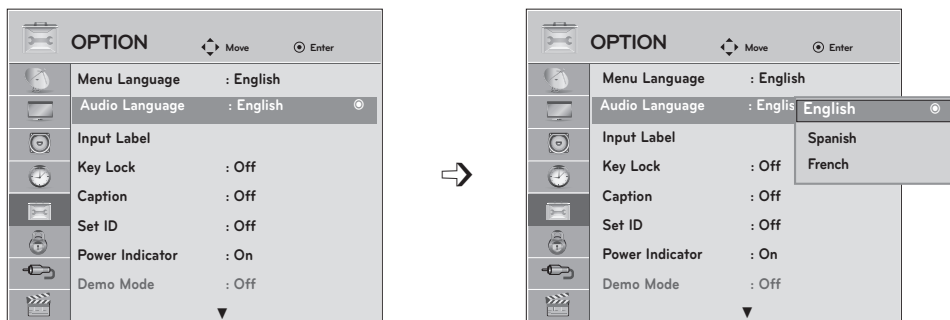

- Press **MENU** or **EXIT** to close the menu window.
- Press **BACK** to move to the previous menu screen.

OPTIONAL SETTINGS

AUDIO LANGUAGE

Other languages may be available if a digital signal is provided by the broadcasting station. This feature operates only in DTV/CADTV mode.



- 1   Select **OPTION**.
- 2   Select **Audio Language**.
- 3   Select your desired language.
- 4 

- Press **MENU** or **EXIT** to close the menu window.
- Press **BACK** to move to the previous menu screen.

INPUT LABEL



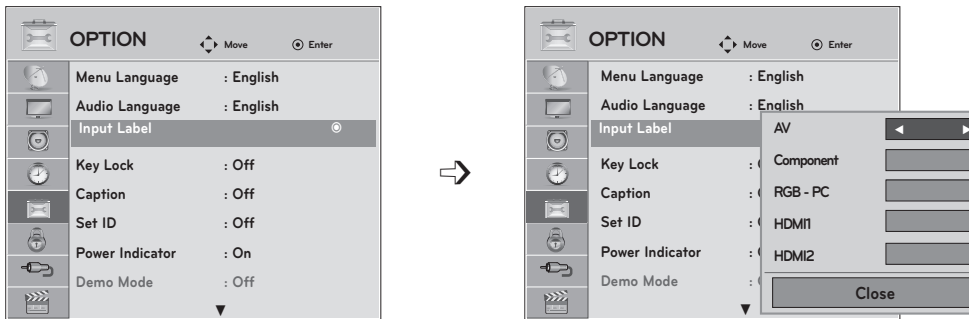



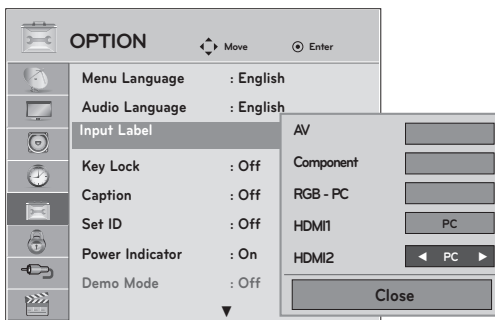

You can set a label for each input source when it's not in use.







If you want to use HDMI-PC mode, you must set the input label to PC mode.
(Refer to the below figure).



Using the OPTION Menu

- 1   Select **OPTION**.
- 2   Select **Input Label**.
- 3   Select the source.
- 4  Select the label.
- 5 

Using INPUT

- 1   Select the source.
- 2   Select the label.
- 3 





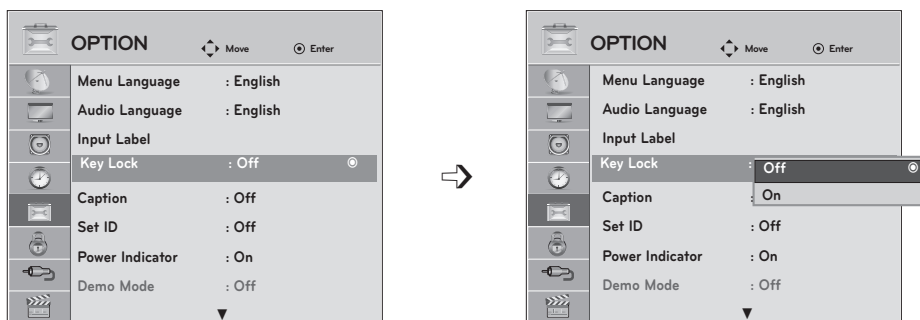

- Press **MENU** or **EXIT** to close the menu window.
- Press **BACK** to move to the previous menu screen.

OPTIONAL SETTINGS

KEY LOCK

This feature can be used to prevent unauthorized viewing by locking out the front panel controls. This TV is programmed to remember which option it was last set to even if you turn the set off.



- 1   Select **OPTION**.
- 2   Select **Key Lock**.
- 3   Select **On** or **Off**.
- 4 

- Press **MENU** or **EXIT** to close the menu window.
- Press **BACK** to move to the previous menu screen.







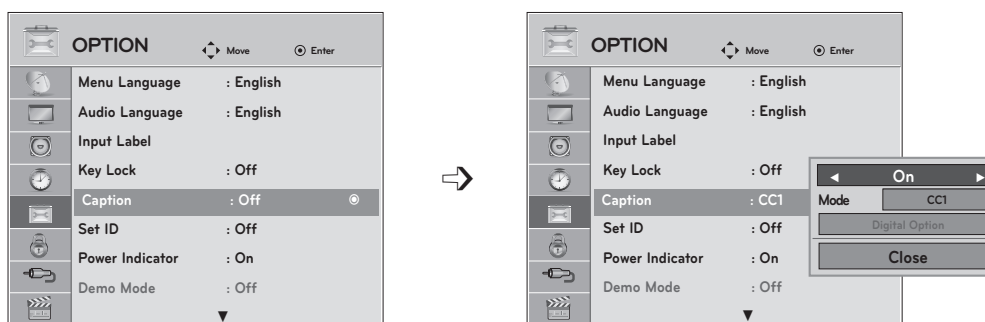

- In **Key Lock 'On'**, if the TV is turned off, press **⏻ / |**, **INPUT, CH** (^ or v) on the TV or **POWER, INPUT, CH** (^ or v) or **NUMBER** buttons on the remote control.
- With the **Key Lock On**, the display '**⚠ Key Lock On**' appears on the screen if any button on the front panel is pressed while viewing the TV.

CAPTION MODE

Analog Broadcasting System Captions

Captions are provided to help the hearing impaired watch TV. Select a caption mode for displaying captioning information if provided with a program. Analog caption displays information at any position on the screen and is usually the program's dialog. Caption/Text, if provided by the broadcaster, would be available for both digital and analog channels on the Antenna/Cable. This TV is programmed to memorize the caption/text mode which was last set when you turned the power off. This function is only available when **Caption Mode** is set **On**.



- 1   Select **OPTION**.
- 2   Select **Caption**.
- 3   Select **On**.
- 4   Select **CC 1-4** or **Text 1-4**.
- 5 

- Press **MENU** or **EXIT** to close the menu window.
- Press **BACK** to move to the previous menu screen.







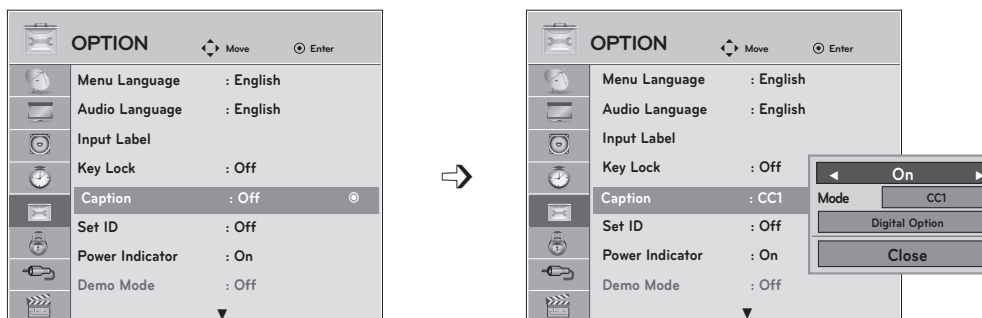

- When selecting **Off**, Sub-menus for Analog, DTV, and Digital Option become disabled.
- **CAPTION**: The term for the words that scroll across the bottom of the TV screen; usually the audio portion of the program provided for the hearing impaired.
- **TEXT**: The term for the words that appear in a large black frame and almost cover the entire screen; usually messages provided the broadcaster.

OPTIONAL SETTINGS

Digital Broadcasting System Captions

Choose the language in which you want the DTV/CADTV captions to appear in. Other languages can be chosen for digital sources only if they are included owith the program. This function in only available when **Caption Mode** is **On**.









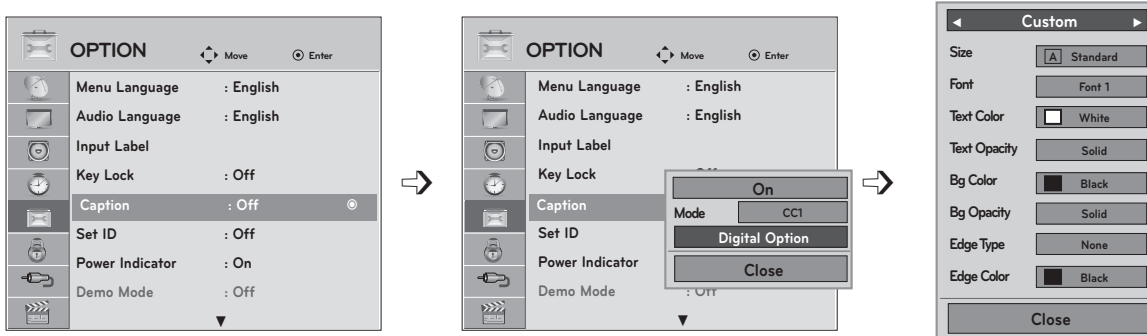

- 1   Select **OPTION**.
- 2   Select **Caption**.
- 3   Select **On**.
- 4   Select **CC1-4, Text1-4, or Service1 - 6**.
- 5 





- Press **MENU** or **EXIT** to close the menu window.
- Press **BACK** to move to the previous menu screen.

Caption Option

Customize the DTV/CADTV captions that appear on your screen.
This function is only available when **Caption Mode** is **On**.



- 1   Select **OPTION**.
- 2   Select **Caption**.
- 3   Select **On**.
- 4   Select **Digital Option**.

- 5   Select **Custom**.
- 6   Customize the Size, Font, etc., to your preference. A preview icon is provided at the bottom of the screen, use it to see the caption language.

- Press **MENU** or **EXIT** to close the menu window.
- Press **BACK** to move to the previous menu screen.

- **Size:** Sets the word size.
- **Font:** Selects a typeface for the text.
- **Text Color:** Chooses a color for the text.
- **Text Opacity:** Specifies the opacity for the text color.
- **Bg (Background) Color:** Selects a background color.
- **Bg (Background) Opacity:** Selects the opacity for the background color.
- **Edge Type:** Selects an edge type.
- **Edge Color:** Selects a color for the edges.

OPTIONAL SETTINGS

POWER INDICATOR

Adjust the power/standby indicator light on the front of the Monitor set.





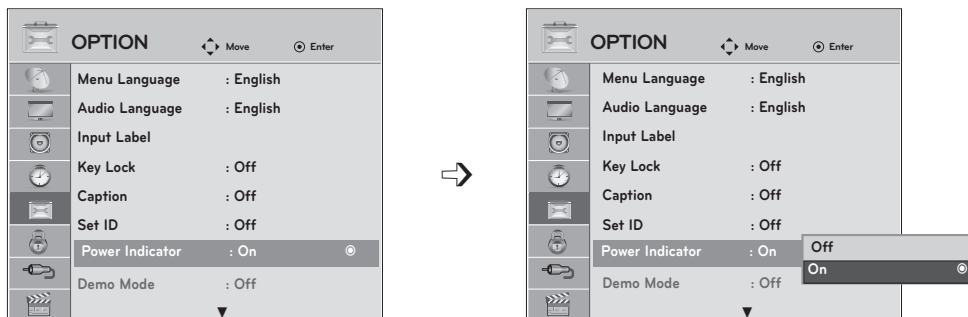

Power Indicator On

- Normal Mode: Blue LED On.
- Off Mode: LED Off

Power Indicator Off

- Normal Mode: Blue LED Off.
- Off Mode: LED Off









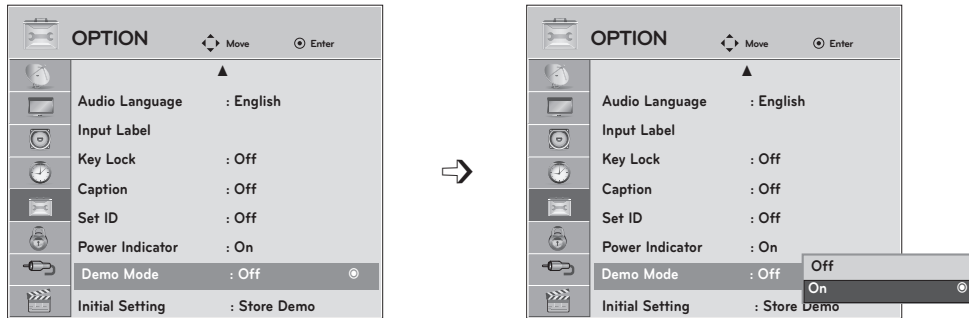

- 1   Select **OPTION**.
- 2   Select **Power Indicator**.
- 3   Select **On** or **Off**.
- 4 

- Press **MENU** or **EXIT** to close the menu window.
- Press **BACK** to move to the previous menu screen.

DEMO MODE

Displays a slide show to explain the various features of this Monitor set.



- 1   Select **OPTION**.
- 2   Select **Demo Mode**.
- 3   Select **On** to show the various feature of the Monitor set.
- 4  Return to TV viewing.
After a while, **Demo Mode** starts. If you want to stop the demo, press any button (Except VOL +, - and MUTE button).

- Press **MENU** or **EXIT** to close the menu window.
- Press **BACK** to move to the previous menu screen.

• This feature is disabled in "Initial Setting - Home Use".

PARENTAL CONTROL/RATINGS

Parental Control can be used to block specific channels, ratings and other viewing sources.

The Parental Control Function (V-Chip) is used to block program viewing based on the ratings sent by the broadcasting station. The default setting is to allow all programs to be viewed. Viewing can be blocked by choosing the type of the program and the categories. It is also possible to block all program viewing for a time period. To use this function, the following must be done:

1. Set ratings and categories to be blocked.
2. Specify a password.
3. Enable the lock.

V-Chip Ratings and Categories

Rating guidelines are provided by broadcasting stations. Most television programs and television movies can be blocked by TV rating and/or individual categories. Movies that have been shown in theaters or direct-to-video movies use the MPAA rating system.

Ratings for Television programs including made-for-TV movies:

- TV-G (General audience)
- TV-PG (Parental guidance suggested)
- TV-14 (Parents strongly cautioned)
- TV-MA (Mature audience only)
- TV-Y (All children)
- TV-Y7 (Children 7 years and older)

PASSWORD & LOCK SYSTEM SETTINGS

Setting Up Your Password





Set up blocking schemes to block specific channels, ratings, and external viewing sources. A password is required to gain access to this menu.

For USA / MEXICO



For CANADA



- 1    Select **LOCK**.
- 2  Input the password.

- Enter the password as requested.
- The set is setup with the initial password "0-0-0-0".

- Press **MENU** or **EXIT** to close the menu window.
- Press **BACK** to move to the previous menu screen.

Lock System

Enables or disables the blocking scheme you set up previously.

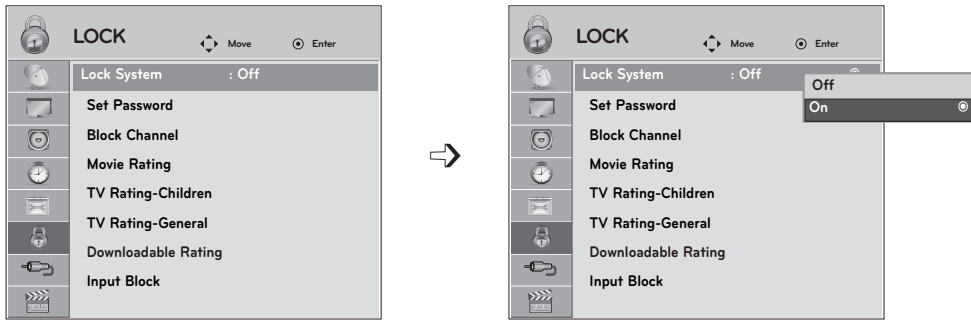

1    Select **LOCK**.

2  Input the password.

3  Select **Lock System**.

4   Select **Lock System**.

5 

- When you select **On**, the Lock System is enable.

- Press **MENU** or **EXIT** to close the menu window.
- Press **BACK** to move to the previous menu screen.

PARENTAL CONTROL/RATINGS

Set Password

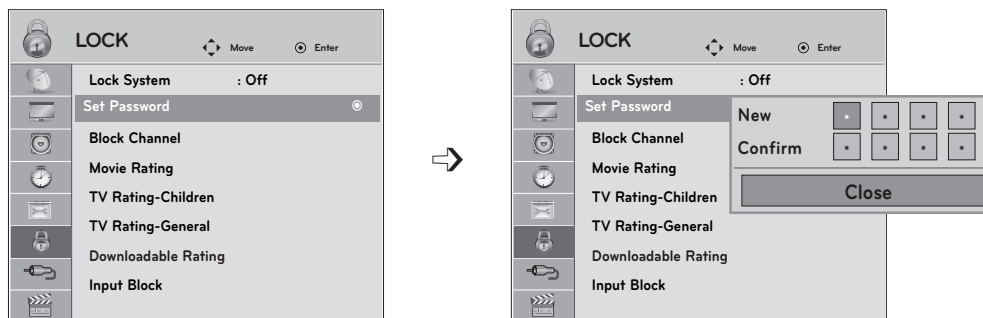

Change the password by inputting a new password twice.



1    Select **LOCK**.

2  Input the password.

3  Select **Set Password**.







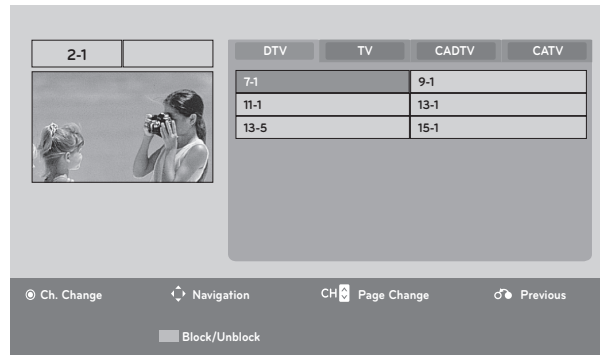

4   Choose any 4 digits for your new password.
As soon as the 4 digits are entered, re-enter the same 4 digits in the password confirmation.

- Press **MENU** or **EXIT** to close the menu window.
- Press **BACK** to move to the previous menu screen.

CHANNEL BLOCKING

This feature blocks any channels that you do not want to watch or that you do not want your children to watch.



- 1    Select **LOCK**.
- 2  Input the password.
- 3  Select **Block Channel**.
- 4   Select a channel to block or unblock.
- 5  Block or unblock a channel.

- If a channel is locked, enter the password to unlock it temporarily.

- Press **MENU** or **EXIT** to close the menu window.
- Press **BACK** to move to the previous menu screen.







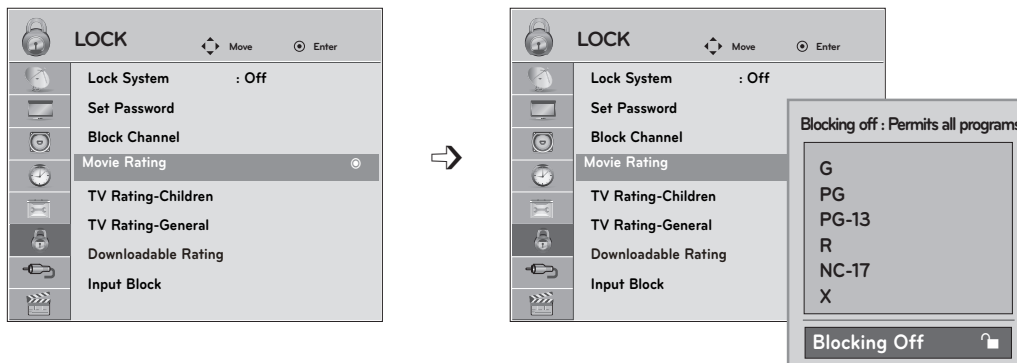

PARENTAL CONTROL/RATINGS

MOVIE & TV RATINGS

Movie Rating (MPAA) - For USA/MEXICO

Movies can be blocked according to the movie ratings limits specified, so children cannot view certain movies. You can set the ratings limit by blocking out all the movies with the ratings above a specified level. Keep in mind that the movie ratings limit only applies to movies shown on TV, not TV programs, such as soap operas.



- 1    Select **LOCK**.
- 2  Input the password.
- 3  Select **Movie Rating**.
- 4   Select **G, PG, PG-13, R, NC-17, X, or Blocking Off**.
- 5 

- Press **MENU** or **EXIT** to close the menu window.
- Press **BACK** to move to the previous menu screen.

- **G** (General audiences)
- **PG** (Parental guidance suggested)
- **PG-13** (Parents strongly cautioned)
- **R** (Restricted)
- **NC-17** (No one 17 and under admitted)
- **X** (Adult only)
- **Blocking Off** (Permits all programs)
- If you set **PG-13**: **G** and **PG** movies will be available, **PG-13, R, NC-17** and **X** will be blocked.
- If a Movie Rating is locked, enter the password to unlock it temporarily.

TV Ratings Children - For USA/MEXICO

Certain children's programs can be blocked according to the ratings limit set. The children rating does not apply to other TV programs. Unless you block certain TV programs intended for mature audiences in the TV Rating - sub menu, your children can still view these programs.

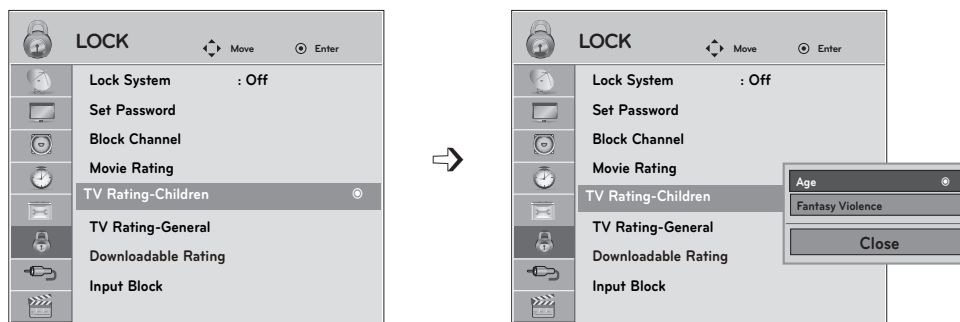

1    Select **LOCK**.

2  Input the password.

3  Select **TV Rating-Children**.

4   Select **Age** or **Fantasy Violence**.

5   Select block options.

6 

- Age (applies to TV-Y, TV-Y7)
- Fantasy violence (applies to TV-Y7)



- Press **MENU** or **EXIT** to close the menu window.
- Press **BACK** to move to the previous menu screen.

PARENTAL CONTROL/RATINGS

TV Ratings General - For USA/MEXICO

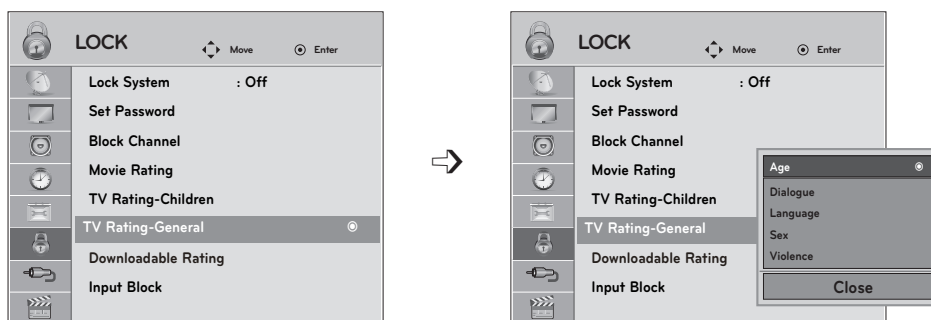
Based on the ratings, blocks certain TV programs that you and your family do not want to view.



1    Select **LOCK**.

2  Input the password.

3  Select **TV Rating-General**.

4   Select **Age, Dialogue, Language, Sex or Violence**.

5   Select block options.

6 

- Press **MENU** or **EXIT** to close the menu window.
- Press **BACK** to move to the previous menu screen.

- Age (applies to TV-G,TV-PG,TV-14,TV-MA)
- Dialogue-sexual dialogue (applies to TV-PG, TV-14)
- Language-adult language (applies to TV-PG, TV-14, TV-MA)
- Sex-sexual situations (applies to TV-PG, TV-14, TV-MA)
- Violence (applies to TV-PG, TV-14, TV-MA)

TV Ratings English - For CANADA

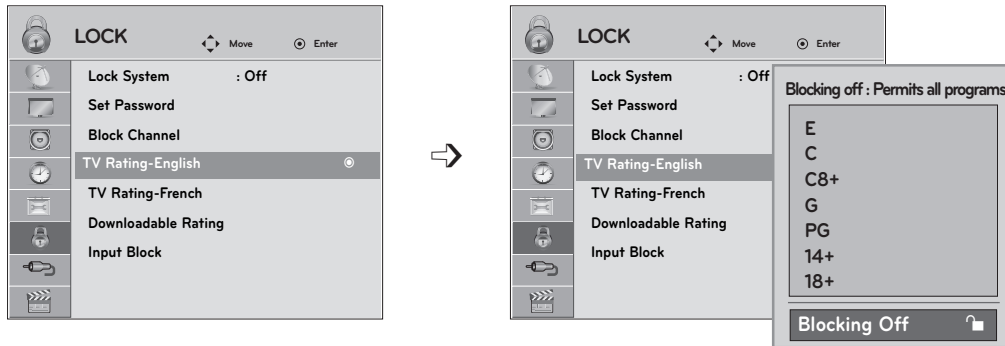

Selecting Canadian English rating system.



1    Select **LOCK**.

2  Input the password.

3  Select **TV Rating-English**.

4   Select **E, C, C8+, G, PG, 14+, 18+,** or **Blocking Off**.

5 

- Press **MENU** or **EXIT** to close the menu window.
- Press **BACK** to move to the previous menu screen.



- If **TV Rating-English** or **TV Rating-French** is locked, enter the password to unlock it temporarily.
- **E** (Exempt)
- **C** (Children)
- **C8+** (Children eight years and older)
- **G** (General programming, suitable for all audiences)
- **PG** (Parental Guidance)
- **14+** (Viewers 14 years and older)
- **18+** (Adult programming)
- **Blocking Off** (Permits all programs)

PARENTAL CONTROL/RATINGS

TV Ratings French - For CANADA

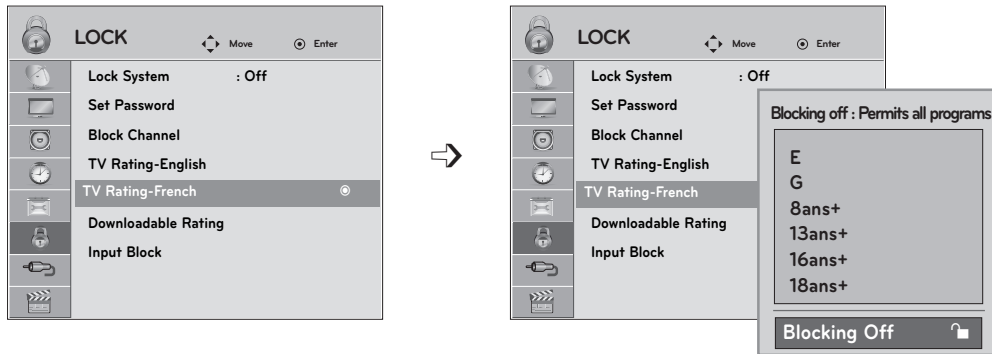

Selecting Canadian French rating system.



1    Select **LOCK**.

2  Input the password.

3  Select **TV Rating-French**.

4   Select **E, G, 8ans+, 13ans+, 16ans+, 18ans+,** or **Blocking off**.

5 

- Press **MENU** or **EXIT** to close the menu window.
- Press **BACK** to move to the previous menu screen.







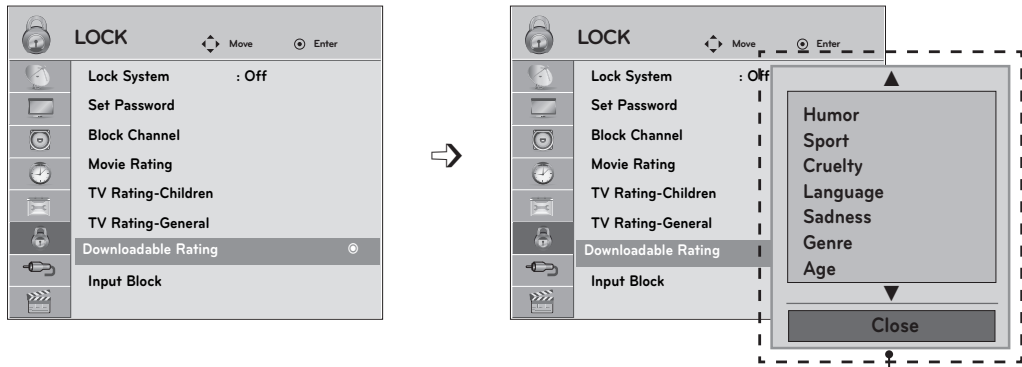



- **E** (Exempt)
- **C** (Children)
- **C8+** (General-not suitable for little children)
- **13ans+** (Not suitable for children of 13 years and younger)
- **16ans+** (Not suitable for children of 16 years and younger)
- **18ans+** (These programs are only for adults)
- **Blocking Off** (Permits all programs)

DOWNLOADABLE RATINGS

Downloadable ratings are only available for digital channels and operate only when TV has received Region 5 rating data



• Based on ratings tables, your TV's OSD (On-Screen Display) may differ slightly from what is shown in this manual.

- 1    Select **LOCK**.
- 2  Input the password.
- 3  Select **Downloadable Rating**.
- 4   Select **Downloadable Rating** option.
- 5   Select desired option and block it.
- 6 

• If a downloadable rating is locked, enter the password to unlock it temporarily.







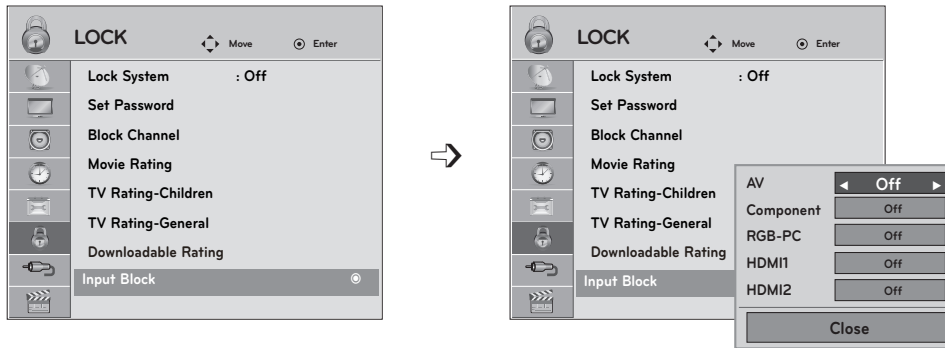

- Press **MENU** or **EXIT** to close the menu window.
- Press **BACK** to move to the previous menu screen.

PARENTAL CONTROL/RATINGS

EXTERNAL INPUT BLOCKING

Enables you to block an input.



- 1    Select **LOCK**.
- 2  Input the password.
- 3  Select **Input Block**.
- 4   Select input source.
- 5  Select **On** or **Off**.
- 6 

- Press **MENU** or **EXIT** to close the menu window.
- Press **BACK** to move to the previous menu screen.

USING USB DEVICES

ENTRY MODES

When you connect a USB device, this pop-up menu is displayed automatically. If the pop-up menu does not appear, you can manually select **Photo List**, **Music List** or **Movie List** in the USB menu. On a USB device, you cannot add new folders or delete an existing folders.

- 1 Connect the USB device to the USB jack on the back of the SET.

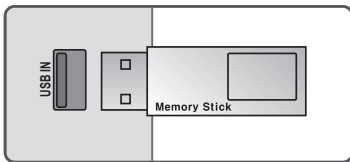

- This set supports JPG, MP3 and HD DivX file types.

- 2  Select **PHOTO LIST**, **MUSIC LIST** or **MOVIE LIST**.

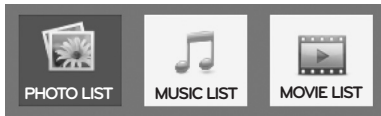

- 3 

Removing USB Devices

Select the USB device menu before removing the USB device.

- 1   Select **USB Device**.

- 2  Select **Eject**.

USING USB DEVICES

USB Device Precautions

- ▶ Only a USB storage device is recognizable.
- ▶ If the USB storage device is connected through a USB hub, the device is not recognizable.
- ▶ A USB storage device using an automatic recognition program may not be recognized.
- ▶ A USB storage device that uses its own driver may not be recognized.
- ▶ The recognition speed of a USB storage device may depend on each device.
- ▶ Please do not turn off the MONITOR or unplug the USB device when the connected USB storage device is working. When such device is suddenly separated or unplugged, the stored files or the USB storage device may be damaged.
- ▶ Do not connect a USB storage device that has been artificially written to on the PC. The device may cause the monitor to malfunction or fail to be played. Never forget to use only a USB storage device that has normal music files or image files.
- ▶ Please use only a USB storage device that was formatted as a FAT16, FAT32, NTFS file system provided with the Windows operating system. If a storage device has been formatted as a different utility program that is not supported by Windows, it may not be recognized. Data on a USB storage device cannot be deleted in the NTFS file system.
- ▶ Please connect power to a USB storage device that requires an external power supply. If not, the device may not be recognized.
- ▶ Please connect a USB storage device with the cable provided by the USB maker. If connected with an aftermarket cable or an excessively long cable, the device may not be recognized.
- ▶ Some USB storage devices may not be supported or operate smoothly.
- ▶ A maximum of 999 files and folders can be recognized.
- ▶ Data on a USB storage device cannot be aligned. Up to 128 English characters can be recognized as a file name.
- ▶ Please back up important files because data on the USB device may be damaged. Data management is solely the consumer's responsibility and the manufacturer does not cover the product bearing data damage.
- ▶ If the USB is connected in Standby Mode, the device will automatically be loaded when the monitor is turned on.
- ▶ The recommended capacity is 1TB or less for an external USB hard disk and 32GB or less for USB memory.
- ▶ Any device with more than the recommended capacity may not work properly.
- ▶ If an external USB hard disk with a "Power Saving" function does not work, turn the hard disk off and on again to make it work properly.
- ▶ USB storage devices below USB 2.0 are supported, but they may not work properly in the movie list.
- ▶ When using a USB HDD via a USB extension cable, connect it to a supported power source.

PHOTO LIST

You can only view .JPG files from USB storage devices. The on-Screen display on your model may be slightly different.

Supported photo file type: *.JPG

- You can view JPG files only.
- Only baseline scan JPGs are supported.
- Available JPG file size: 64 pixel (width) x 64 pixel (height) to 15360 pixel (width) x 8640 pixel (height)

Screen Components

1



Select **USB**.

2



Select **Photo List**.

- 1** Moves to upper level folder
- 2** Preview: Displays the thumbnail/ folder name of the photo in the selected folder
- 3** Current page/total pages
- 4** Total number of marked photos.
- 5** Corresponding buttons on the remote control.

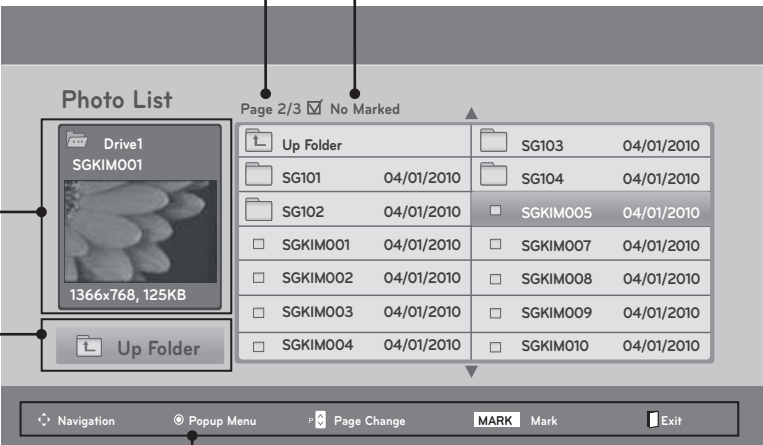

The screenshot shows a 'Photo List' interface. At the top left, a preview window shows a photo thumbnail and the folder name 'Drive1 SGKIM001' with dimensions '1366x768, 125KB'. Below it is an 'Up Folder' button. The main area is a table of files and folders. At the top right of the table, it says 'Page 2/3' and 'No Marked'. At the bottom, there is a navigation bar with buttons for 'Navigation', 'Popup Menu', 'Page Change', 'MARK Mark', and 'Exit'.

Folder/Photo Name	Date	Folder/Photo Name	Date
Up Folder		SGI03	04/01/2010
SGI01	04/01/2010	SGI04	04/01/2010
SGI02	04/01/2010	SGKIM005	04/01/2010
SGKIM001	04/01/2010	SGKIM007	04/01/2010
SGKIM002	04/01/2010	SGKIM008	04/01/2010
SGKIM003	04/01/2010	SGKIM009	04/01/2010
SGKIM004	04/01/2010	SGKIM010	04/01/2010





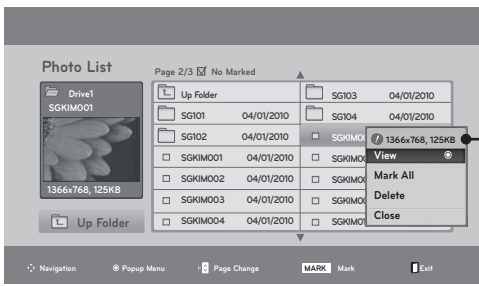
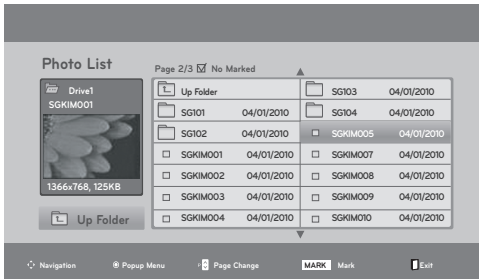

USING USB DEVICES

Photo Selection and Pop-up Menu



When you select a file (not folder), this **Pop-up** menu is displayed.

- ▶ **View**: Display the selected item.
- ▶ **Mark All**: Mark all photos on the screen.
- ▶ **Unmark All**: Deselect all marked photos.
- ▶ **Delete** or **Delete Marked**: Delete the selected photo item.
- ▶ **Close**: Close the **Pop-up** menu.

- 1  Select the target folder or drive.
- 2   Select the desired photos.
- 3  Show the **Pop-up** menu.
- 4   Select the desired **Pop-up** menu.

- Use **CH** ^ v to navigate in the photo page.
- Use **MARK** to mark or unmark a photo. When one or more photos are marked, you can view individual photos or a slide show of the marked photos. If no photos are marked, you can view all photos individually or all photos in the folder in a slide show.





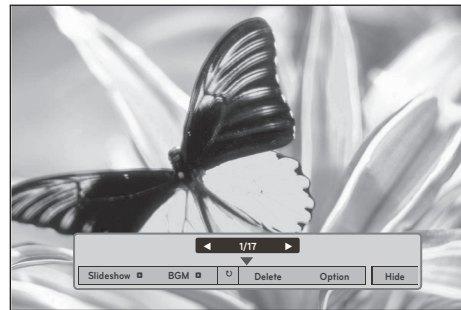
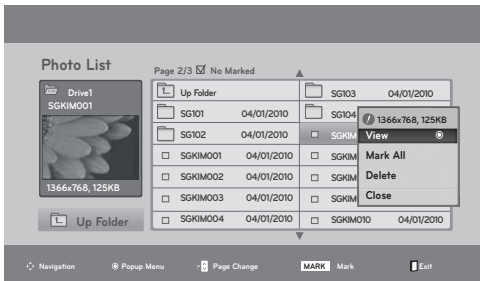
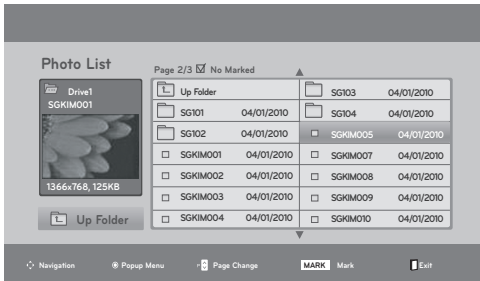

- Press **BACK** to move to the previous menu screen.

Full Screen Menu

You can change the Photo List view so that it fills the screen. More operations are available in full screen mode.



The aspect ratio of a photo may change the size of the photo displayed on the screen in full size. Press **BACK** to move to the previous menu screen.

- 1  Select the target folder or drive.
- 2   Select the desired photos.
- 3  Show the **Pop-up** menu.
- 4  Select **View**.
- 5  The selected photo is displayed in full size.

- Use **CH ^ v** to navigation in the photo page.

- Press **BACK** to move to the previous menu screen.

USING USB DEVICES

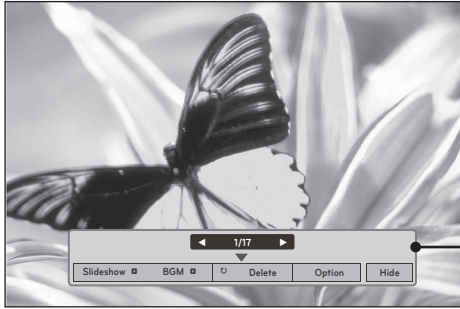

6 Select the **Slideshow** , **BGM** , **Rotate** , **Delete** , **Option** or **Hide**.

- Use < > to select the previous or next photo.
- Use ^ v < > to select and control the menu on the full-sized screen.

▶ **Slideshow** : Selected photos are displayed during the slide show. If no photo is selected, all photos in the current folder are displayed during slide show.

- Set the time interval of the slide show in **Option**.

▶ **BGM**: Listen to music while viewing photos in full-size..

- Set the BGM device and album in **Option**.

▶ **(Rotate)**: Rotate photos.

- Rotates the photo 90°, 180°, 270°, 360° clockwise.

▶ **Delete**: Delete photos.

▶ **Option**: Set values for **Slide Speed** and **Music Album**.

- Use ^ v < > and **ENTER** to set values Then go to **Enter** and press **ENTER** to save the settings.
- You cannot change the **Music Album** while **BGM** is playing.

▶ **Hide**: Hide the menu on the full-sized screen.

- To see the menu again on the full-sized screen, press **ENTER** to display.

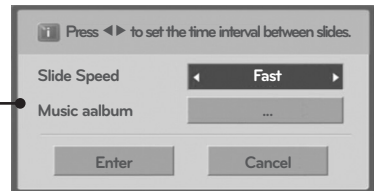

MUSIC LIST

You can use the Music List menu to play MP3 files from a USB storage device. This set cannot play back copy-protected files. The on-screen display on your model may be slightly different.

Supported music file type: *.MP3
 Bit rate range 32 kbps to 320 kbps

- Sampling rate MPEG1 Layer3: 32kHz, 44.1kHz, 48kHz
- Sampling rate MPEG2 Layer3: 16kHz, 22.05kHz, 24kHz
- Sampling rate MPEG2.5 Layer3: 8kHz, 11.025kHz, 12kHz

Screen Components

1



Select **USB**.

2



Select **Music List**.

- 1** Moves to upper level folder
- 2** Preview: If any album jacket for the file exists, this jacket is displayed
- 3** Current page/total pages
- 4** Total number of marked music files
- 5** Corresponding buttons on the remote control

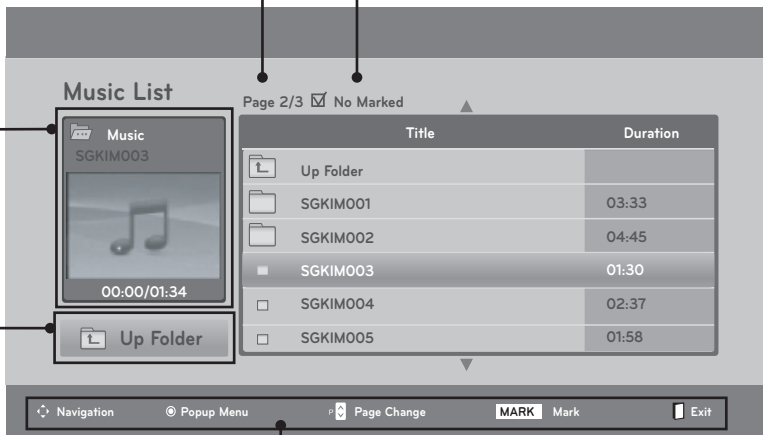





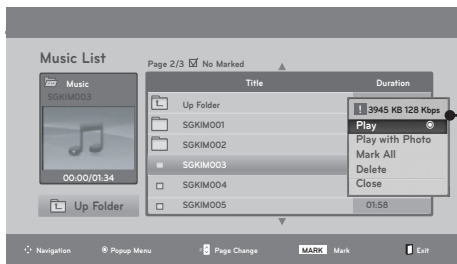
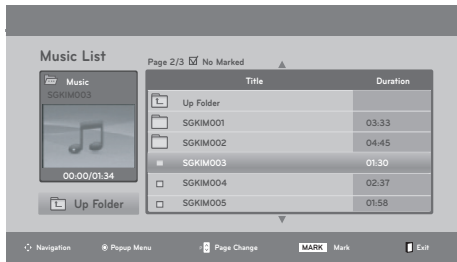

	Title	Duration
Up Folder		
	SGKIM001	03:33
	SGKIM002	04:45
<input checked="" type="checkbox"/>	SGKIM003	01:30
<input type="checkbox"/>	SGKIM004	02:37
<input type="checkbox"/>	SGKIM005	01:58

USING USB DEVICES

Music Selection and Pop-up Menu



- ▶ **Play** (During stop): Plays the selected music titles. Once a song finishes playing, the next selected one will be played. When there are no selected files to play, the next one in the current folder will be played. If you go to a different folder and press **ENTER**, the current song in playback will stop.
- ▶ **Play Marked**: Plays the selected files. Once a file finishes playing, the next selected one will be played automatically.
- ▶ **Stop Play** (During playback): Stop the playing files.
- ▶ **Play with Photo**: Starts playing the selected files and then move to the Photo List..
- ▶ **Mark All**: Marks all files in the folder.
- ▶ **Unmark All**: Deselects all marked files.
- ▶ **Delete** or **Delete Marked**: Deletes the selected files.
- ▶ **Close**: Close the **Pop-up** menu.

- 1  Select the target folder or drive.
- 2   Select the desired music files.
- 3  Show the **Pop-up** menu.
- 4   Select the desired **Pop-up** menu.

- Use **CH ^ v** to navigate up/down in the music page
- Use **MARK** to mark or unmark a music file. If no music is marked, all the music in the folder will be played in sequence. When one or more music files are marked, the marked music files will be played in sequence. If you want to listen to only one song repeatedly, just mark that one file and play.

- Press **BACK** to move to the previous menu screen.

- The play information box (as shown below) will automatically move across the screen when there is no user input to prevent a fixed image remaining on the screen for an extended period of time.

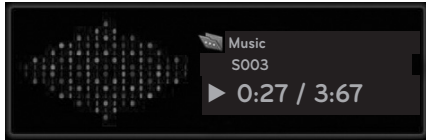

! NOTE

- ▶ When music is playing, 🎵 is displayed in front of the music play time.
- ▶ A damaged or corrupted music file that does not play displays 00:00 as the play time.
- ▶ A music downloaded from a paid service with copyright protection does not start but displays inappropriate information in playtime.
- ▶ If you press **ENTER**, **■** or **BACK**, screen saver stops.

USING USB DEVICES

MOVIE LIST

The movie list is activated once a USB drive is detected and is used when playing movie files on the set. The movie list displays the movies in the USB folder and allows you to select movies for playback. All movies in the folder can be played back, but you cannot add or delete movies.

Movie file types supported: (*.dat/*.mpg/*.mpeg/*.ts/*.trp/*.tp/*.vob/*.mp4/*.mkv/*.avi/*.divx).
Bit rate: within 32 kbps to 320 kbps (MP3).

Video Format	Audio Format	Subtitle format
DivX3.11, DivX4.12, DivX5.x, DivX6, Xvid1.00, Xvid1.01, Xvid1.02, Xvid1.03, Xvid 1.10-beta-1/beta-2, Mpeg-1, Mpeg-2, Mpeg-4, H.264/AVC	Dolby Digital, AAC, Mpeg, MP3, LPCM, HE-AAC	*.smi/*.srt/*.sub(MicroDVD, SubViewer1.0/2.0)/*.ass/*.ssa/*.txt(TMPlayer)/*.psb(PowerDivX)

Extension name	Video Decoder	Audio Codec	Resolution
mpg, mpeg, vob	MPEG1, MPEG2	Dolby Digital, MPEG, MP3, LPCM	1920 x 1080P @ 25 / 30P, 1280 x 720P @ 50 / 60P
dat	MPEG1	Dolby Digital, MPEG, MP3, LPCM	
ts,trp,tp	MPEG2, H.264/AVC	Dolby Digital, AAC, MPEG	
mp4	MPEG4 SP, MPEG4 ASP, Divx 3.11, Dvix 4.12, Dvix 5.x Dvix 6, Xvid 1.00, Xvid 1.01, Xvid 1.02, Xvid 1.03 Xvid 1.10-beta 1, Xvid 1.10-beta 2, H.264/AVC	Dolby Digital, HE-AAC, AAC, MPEG, MP3, LPCM	
avi	MPEG 2, MPEG 4 SP, MPEG4 ASP, DivX 3.11, DivX 4, DivX 5, DivX 6 Xvid 1.00, Xvid 1.01, Xvid 1.02, Xvid 1.03, Xvid 1.10-beta 1 Xvid 1.10-beta 2, H.264/AVC	Dolby Digital, HE-AAC, AAC, MPEG, MP3, LPCM	
mkv	H.264/AVC, MPEG 1, MPEG 2, MPEG 4 SP , MPEG4, ASP	Dolby Digital, HE-AAC, AAC, MPEG, MP3, LPCM	
divx	MPEG 2, MPEG 4 SP, MPEG4 ASP, DivX 3.11, DivX 4, DivX 5, DivX 6 Xvid 1.00, Xvid 1.01, Xvid 1.02, Xvid 1.03, Xvid 1.10-beta 1 Xvid 1.10-beta 2, H.264/AVC	Dolby Digital, HE-AAC, AAC, MPEG, MP3, LPCM	

Movie Playing Precautions

- ▶ Some user-created subtitles may not work properly.
- ▶ Some special characters are not supported in subtitles.
- ▶ HTML tags are not supported in subtitles.
- ▶ Subtitles in languages other than the supported languages are not available.
- ▶ Time information in an external subtitle file should be arranged in ascending order to be played.
- ▶ The screen may suffer temporary interruptions (image stoppage, faster playback, etc.) when the audio language is changed.
- ▶ A damaged video file may not play correctly, or some player functions may not be usable.
- ▶ Video files produced with some encoders may not play correctly.
- ▶ If the video and audio structure of a recorded file is not interleaved, either the video or audio is output.
- ▶ HD videos with a maximum of 1920x1080 @ 25/30P or 1280x720 @ 50/60P are supported, depending on the frame rate.
- ▶ Videos with resolutions higher than 1920x1080 @ 25/30P or 1280x720 @ 50/60P may not work properly depending on the frame rate.
- ▶ Video files other than the specified types and formats may not work properly.
- ▶ Video files encoded with the GMC (Global Motion Compensation) are not supported.
- ▶ Only files saved in ASCII CODE are supported in subtitles.
- ▶ Only 250 Korean characters, 500 letters and 500 numbers are supported for each line of the subtitles.
- ▶ Only 10,000 sync blocks can be supported within the subtitle file.
- ▶ The max bitrate of playable movie files is 20Mbps.
- ▶ We do not guarantee smooth playback of profiles encoded level 4.1 or higher in H.264/AVC.
- ▶ DTS Audio codec is not supported.
- ▶ A video file more than 30GB in file size is not supported for playback.
- ▶ Playing a video via a USB connection that doesn't support high speed may not work properly.
- ▶ USB storage devices below USB 2.0 are supported, but they may not work properly in the movie list.
- ▶ The video file and the subtitle file must be located in the same folder.
- ▶ The name of the video file and the subtitle file must be the same to view the subtitles normally.

Screen Components

1

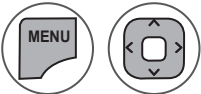

Select **USB**.

2



Select **Movie List**.

- 1 Moves to upper level folder
- 2 Current page/total pages
- 3 Total number of marked movie
- 4 Corresponding buttons on the remote control







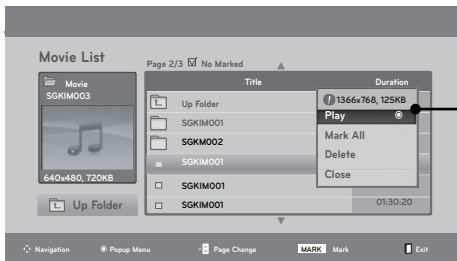
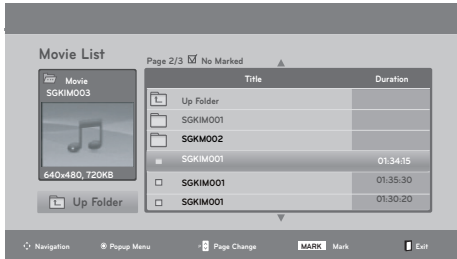

Movie List		Page 2/3 <input checked="" type="checkbox"/> No Marked	
	Title	Duration	
Drive1 SGKIM003	Up Folder		
	SGKIM001		
	SGKIM002		
	SGKIM001		01:34:15
<input type="checkbox"/>	SGKIM001		01:35:30
<input type="checkbox"/>	SGKIM001		01:30:20

USING USB DEVICES

Movie Selection and Pop-up Menu



- ▶ **Play:** Plays the selected file. DivX play is executed while the screen changes.
- ▶ **Play Marked:** Plays the selected files. Once a movie finishes playing, the next selected one will be played automatically.
- ▶ **Mark All:** Marks all files in the folder.
- ▶ **Unmark All:** Deselects all marked files.
- ▶ **Delete or Delete Marked**(FAT32 file system only): Deletes the selected file.
- ▶ **Close:** Close the **Pop-up** menu.

- 1  Select the target folder or drive.
- 2   Select the desired movies.
- 3  Show the **Pop-up** menu.
- 4   Select the desired **Pop-up** menu.

- Use **CH** ^ v to navigate in the movie page.
- Use **MARK** to mark or unmark a movie file. When one or more movie files are marked, the marked movie files will be played in sequence.

- Press **BACK** to move to the previous menu screen.

Option Menu Selection

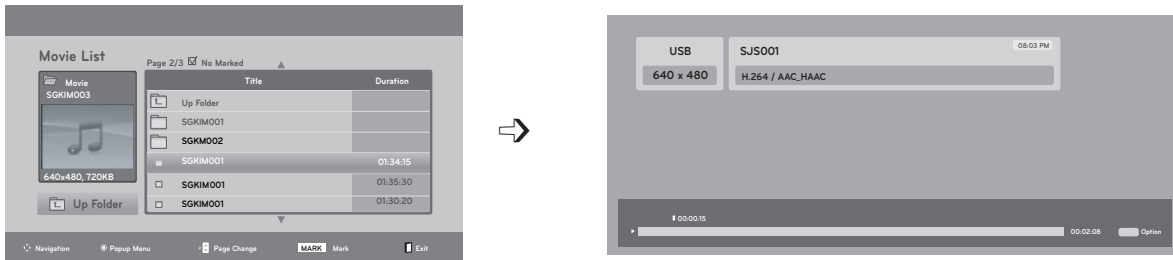

Using the Remote Control

There are various ways to playback, rewind and fast forward through a movie.

◀◀ / ▶▶	<p>When playing, repeatedly, press the REW(◀◀) to speed up ◀◀(x2) → ◀◀◀◀ (x4) → ◀◀◀◀◀◀ (x8) → ◀◀◀◀◀◀◀◀ (x16) → ◀◀◀◀◀◀◀◀◀◀ (x32) .</p> <p>repeatedly, press FF(▶▶) to speed up ▶▶(x2)→ ▶▶▶▶ (x4)→ ▶▶▶▶▶▶ (x8) → ▶▶▶▶▶▶▶▶ (x16) → ▶▶▶▶▶▶▶▶▶▶ (x32).</p> <ul style="list-style-type: none"> ■ Pressing these buttons repeatedly increases the fast forward/rewind speed.
	<ul style="list-style-type: none"> ■ During playback, press Pause() and a still screen will be displayed.
< >	<ul style="list-style-type: none"> ■ When using < or > during playback, a cursor indicating the position will be displayed.
Play(▶)	<p>Press Play(▶) button to return to normal playback.</p>



NOTE

Use (< / >) to move to a specific frame forward or backward while playing a movie. ((< / >) may not work properly for some files while playing a movie.)

USING USB DEVICES

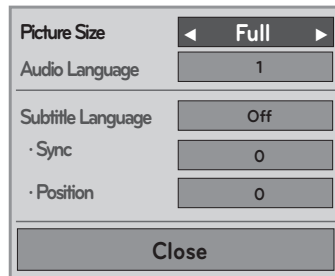
DivX Audio Language & Subtitle Language



- 1  When DivX is playing, the above menu is displayed.
- 2  Select **Picture Size**, **Audio Language**, **Subtitle Language**, **Sync** or **Position**.
- 3  Select the desired option.

- Press **BACK** to move to the previous menu screen.





Subtitle Language Group	Supported Language
Latin1	English, Spanish, French
Korean	English, Korean

- ▶ **Picture Size:** Select the Full screen or Original size.
- ▶ **Audio Language:** Select the language. But, the file with only one audio can not be selected.
- ▶ **Subtitle Language:** Subtitles can be turned on or off. If there are two or more subtitles, you can select one of them.
 - **Sync:** When the video is not synchronized with the captions, it can be adjusted in 0.5 second units.
 - **Position:** Move the location of the subtitle.

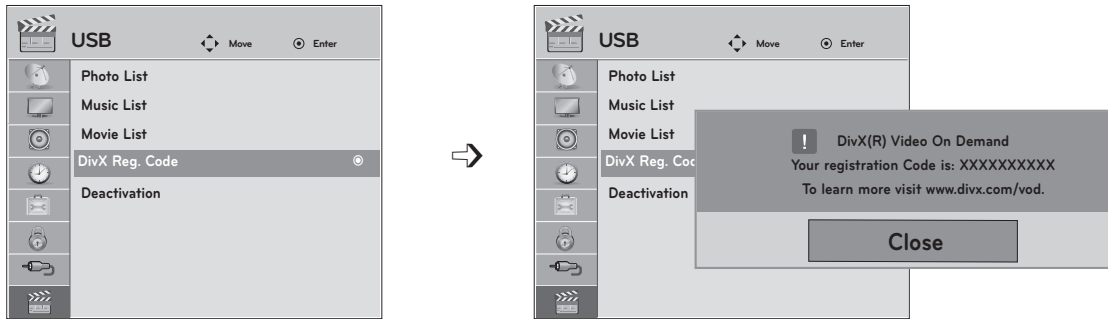
DIVX REGISTRATION CODE

Confirm the DivX registration code number of the set. Using the registration number, movies can be rented or purchased at www.divx.com/vod. With a DivX registration code from another set, playback of rented or purchased DivX files is not allowed. (Only DivX files matched with the registration code of the purchased set are playable.)



- 1   Select **USB**.
- 2   Select **DivX Reg. Code**.
- 3  Display **DivX Reg. Code**.

- Press **MENU** or **EXIT** to close the menu window.
- Press **BACK** to move to the previous menu screen.

DIVX HD

ABOUT DIVX VIDEO: DivX® is a digital video format created by DivX, Inc. This is an official DivX Certified device that plays DivX video. Visit www.divx.com for more information and software tools to convert your files into DivX video.

ABOUT DIVX VIDEO-ON-DEMAND: This DivX Certified® device must be registered in order to play DivX Video-on-Demand (VOD) content. To generate the registration code, locate the DivX VOD section in the device setup menu. Go to vod.divx.com with this code to complete the registration process and learn more about DivX VOD.

"DivX Certified® to play DivX® video up to HD 1080p, including premium content."

"DivX®, DivX Certified® and associated logos are trademarks of DivX, Inc. and are used under license."

"Pat. 7,295,673; 7,460,668; 7,515,710; 7,519,274"

NOTE







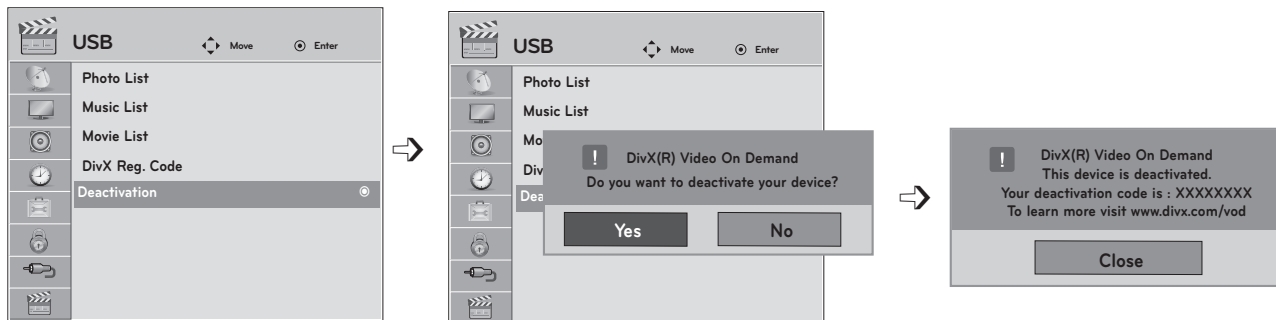

- ▶ When loading, some buttons may not work.
- ▶ If you use the DivX registration code of another device, the rented or purchased DivX file cannot be played. Therefore always use the DivX registration code assigned to this product.
- ▶ The video or audio of a file converted based on a standard other than the DivX codec standard may be corrupted or unable to be played.

USING USB DEVICES

DEACTIVATION

Delete the existing authentication information to receive a new DivX user authentication for set. Once this function is done,, a DivX user authentication is required again to play DivX DRM files.



- 1   Select **USB**.
- 2   Select **Deactivation**.
- 3    Select **Yes**.
- 4  Select **Close**.

- Press **MENU** or **EXIT** to close the menu window.
- Press **BACK** to move to the previous menu screen.

APPENDIX

TROUBLESHOOTING

Abnormal Operation	
The remote control doesn't work.	<ul style="list-style-type: none"> ■ Check to see if there is any object between the product and the remote control causing obstruction. Ensure that you are pointing the remote control directly at the set. ■ Ensure that the batteries are installed with correct polarity (+ to +, - to -). ■ Ensure that the correct remote operating mode is set: TV, VCR etc. ■ Install new batteries.
Power is suddenly turned off	<ul style="list-style-type: none"> ■ Is the sleep timer set? ■ Check the power control settings. Power may have been interrupted. ■ If there is no signal, the set turns off automatically in 15 minutes. ■ When a corrupted file is played in USB mode, the set may turn off. Please check the file in your USB storage device.
Video Problems	
No picture & No sound	<ul style="list-style-type: none"> ■ Check whether the product is turned on. ■ Try another channel. The problem may be with the broadcast. ■ Is the power cord inserted into wall power outlet? ■ Check your antenna direction and/or location. ■ Test the wall power outlet, plug another product's power cord into the outlet where the product's power cord was plugged in.
The picture appears slowly after switching on.	<ul style="list-style-type: none"> ■ This is normal. The image is muted during the product startup process. Please contact your service center if the picture has not appeared after five minutes.
There is no picture, poor color or poor picture.	<ul style="list-style-type: none"> ■ Adjust the color in the menu. ■ Keep a sufficient distance between the product and the VCR. ■ Try another channel. The problem may be with the broadcast. ■ Are the video cables installed properly? ■ Activate any function to restore the brightness of the picture.
There are horizontal/vertical bars or the picture is shaking.	<ul style="list-style-type: none"> ■ Check for local interference such as an electrical appliance or power tool.
The reception is poor on some channels.	<ul style="list-style-type: none"> ■ Station or cable product experiencing problems. Tune to another station. ■ The station signal may be weak. Reorient antenna to receive weaker stations better. ■ Check for sources of possible interference.
There are lines or streaks in the picture.	<ul style="list-style-type: none"> ■ Check antenna (change the direction of the antenna).
There is no picture when connecting via HDMI.	<ul style="list-style-type: none"> ■ If an HDMI cable doesn't support High Speed HDMI, it can cause flickers or no screen display. In this case, use the latest cables that support High Speed HDMI.

APPENDIX

Audio Problems	
There is no output from one of the speakers.	<ul style="list-style-type: none"> ■ Adjust the balance in the menu.
There is an unusual sound from inside the product.	<ul style="list-style-type: none"> ■ A change in ambient humidity or temperature may result in an unusual noise when the product is turned on or off and does not indicate a fault with the product.
There is no sound when connecting via HDMI/USB.	<ul style="list-style-type: none"> ■ Check that you are using a High Speed HDMI cable. ■ Check that your USB cable is version 2.0 or later ■ Use a normal MP3 file

PC Mode Problems	
The signal is out of range.	<ul style="list-style-type: none"> ■ Adjust resolution, horizontal frequency, or vertical frequency on the PC. ■ Check the input source.
There is a vertical bar or stripe in the background & horizontal noise & incorrect position.	<ul style="list-style-type: none"> ■ Activate the Auto configure feature or adjust size, phase, or H/V position. (Option)
The screen color is unstable or in a single color.	<ul style="list-style-type: none"> ■ The signal from the PC (video card) is out of the vertical or horizontal frequency range of the product. Adjust the frequency range by referring to the Specifications in this user's guide.
When connecting with an HDMI cable to the PC, there is no audio.	<ul style="list-style-type: none"> ■ Check the manual for the video card in the PC to see if it supports HDMI audio and how to set it up properly.

Movie List Problems

The file does not appear in the Movie List.	<ul style="list-style-type: none">■ Check whether the file extension is supported.
A message is displayed saying "This file is invalid" or the audio is working normally but the video is not working normally.	<ul style="list-style-type: none">■ Check that the file plays normally on a PC. (Is the file corrupted or damaged?)■ Check that the resolution is supported.■ Check that the video/audio codec is supported.■ Check that the frame rate is supported.
A message is displayed saying "Unsupported Audio" or the video is working normally but the audio is not working normally.	<ul style="list-style-type: none">■ Check that the file plays normally on a PC. (Is the file corrupted or damaged?)■ Check that the audio codec is supported.■ Check that the bit rate is supported.■ Check that the sample rate is supported.
The subtitles are not working.	<ul style="list-style-type: none">■ Check that the file plays normally on a PC. (Is the file corrupted or damaged?)■ Check that the video file and subtitle file name are the same.■ Check that the video file and subtitle file are located in the same folder.■ Check that the subtitle file is supported.■ Check that the language is supported. (When you open the subtitle file on a PC, you can check the language of the subtitle file.)

APPENDIX

MAINTENANCE

Early malfunctions can be prevented. Careful and regular cleaning can extend the life of your new Monitor set.

Caution: Be sure to turn the power off and unplug the power cord before you begin any cleaning.

Cleaning the Screen

- 1 Here's a great way to keep the dust off your screen for a while. Wet a soft cloth in a mixture of luke-warm water and a little fabric softener or dish washing detergent. Wring the cloth until it's almost dry, and then use it to wipe the screen.
- 2 Make sure the excess water is off the screen, and then let it air-dry before you turn on your set.

Cleaning the Cabinet

- To remove dirt or dust, wipe the cabinet with a soft, dry, lint-free cloth.
- Please be sure not to use a wet cloth.

Extended Absence

CAUTION

- ▶ If you expect to leave your set dormant for a long time (such as a vacation), it's a good idea to unplug the power cord to protect against possible damage from lightning or power surges.

PRODUCT SPECIFICATIONS

<M2080D>

LCD Panel	Screen Type	508.5 mm Wide (20.0 inch) TFT (Thin Film Transistor) LCD (Liquid Crystal Display) Panel Visible diagonal size: 508.5 mm	
	Pixel Pitch	0.2766 mm (H)x0.2766 mm (V)	
Video Signal	Max. Resolution	1600x900 @ 60 Hz	
	Recommended Resolution	1600x900 @ 60 Hz	
	Horizontal Frequency	30 kHz to 65 kHz	
	Vertical Frequency	56 Hz to 75 Hz	
	Synchronization Type	Separate Sync, Digital	
Input Connector		TV, D-Sub Analog, PC Audio In, component, HDMI*2, CVBS	
Power	Rated Voltage	19 V  2.0 A	
	Power Consumption	On Mode 27 W (typ.) Off Mode ≤ 1 W	
AC/DC Adapter		Manufacturer: LITE-ON, Model PA-1650-68 INPUT: AC 100-240 V 50/60 Hz 2.0 A OUTPUT: DC 19 V / 3.42 A	
Tilt	Tilt Range	-5° to 10°	
Dimensions (Width x Height x Depth) Weight		M2080D	
		476.4 mm x 376.1 mm x 193.8 mm (18.75 inch x 14.81 inch x 7.62 inch) 3.5 kg (7.12 lb)	
Environmental Conditions	Operating Temperature	10 °C to 35 °C	
	Operating Humidity	20 % to 80 %	
	Storage Temperature	-10 °C to 60 °C	
	Storage Humidity	5 % to 90 %	

■ The specifications shown above may be changed without prior notice for quality improvement.

APPENDIX

<M2280D>

LCD Panel	Screen Type	546.86 mm Wide (21.53 inch) TFT (Thin Film Transistor) LCD (Liquid Crystal Display) Panel Visible diagonal size: 546.86 mm	
	Pixel Pitch	0.248 mm (H)x0.248 mm (V)	
Video Signal	Max. Resolution	1920x1080 @ 60 Hz	
	Recommended Resolution	1920x1080 @ 60 Hz	
	Horizontal Frequency	30 kHz to 83 kHz	
	Vertical Frequency	56 Hz to 75 Hz	
	Synchronization Type	Separate Sync, Digital	
Input Connector		TV, D-Sub Analog, PC Audio In, component, HDMI*2, CVBS	
Power	Rated Voltage	19 V $\overline{\text{---}}$ 2.2 A	
	Power Consumption	On Mode 35 W (typ.) Off Mode \leq 1 W	
AC/DC Adapter		Manufacturer: LITE-ON, Model PA-1650-68 INPUT: AC 100-240 V 50/60 Hz 2.0 A OUTPUT: DC 19 V / 3.42 A	
Tilt	Tilt Range	-5° to 10°	
Dimensions (Width x Height x Depth)		M2280D	
Weight		509.6 mm x 396.2 mm x 193.8 mm (20.06 inch x 15.6 inch x 7.63 inch) 3.7 kg (8.16 lb)	
Environmental Conditions	Operating Temperature	10 °C to 35 °C	
	Operating Humidity	20 % to 80 %	
	Storage Temperature	-10 °C to 60 °C	
	Storage Humidity	5 % to 90 %	

■ The specifications shown above may be changed without prior notice for quality improvement.

<M2380D/M2380DF>

LCD Panel	Screen Type	584.2 mm Wide (23 inch) TFT (Thin Film Transistor) LCD (Liquid Crystal Display) Panel Visible diagonal size: 584.2 mm
	Pixel Pitch	0.265 mm (H)x0.265 mm (V)
Video Signal	Max. Resolution	1920x1080 @ 60 Hz
	Recommended Resolution	1920x1080 @ 60 Hz
	Horizontal Frequency	30 kHz to 83 kHz
	Vertical Frequency	56 Hz to 75 Hz
	Synchronization Type	Separate Sync, Digital
Input Connector		TV, D-Sub Analog, PC Audio In, component, HDMI*2, CVBS
Power	Rated Voltage	19 V  2.4 A
	Power Consumption	On Mode 37 W (typ.) Off Mode ≤ 1 W
AC/DC Adapter		Manufacturer: LITE-ON, Model PA-1650-68 INPUT: AC 100-240 V 50/60 Hz 2.0 A OUTPUT: DC 19 V / 3.42 A
Tilt	Tilt Range	-5° to 10°
Dimensions (Width x Height x Depth) Weight	M2380D	
	547 mm x 415.7 mm x 193.8 mm (21.53 inch x 16.37 inch x 7.62 inch) 4.2 kg (9.26 lb)	
	M2380DF	
	547 mm x 427.9 mm x 193.9 mm (21.53 inch x 16.85 inch x 7.63 inch) 4.4 kg (9.7 lb)	
Environmental Conditions	Operating Temperature	10 °C to 35 °C
	Operating Humidity	20 % to 80 %
	Storage Temperature	-10 °C to 60 °C
	Storage Humidity	5 % to 90 %

■ The specifications shown above may be changed without prior notice for quality improvement.

APPENDIX

<M2780D/M2780DF>

LCD Panel	Screen Type	685.8 mm Wide (27 inch) TFT (Thin Film Transistor) LCD (Liquid Crystal Display) Panel Visible diagonal size: 685.8 mm	
	Pixel Pitch	0.3114 mm (H)x0.3114 mm (V)	
Video Signal	Max. Resolution	1920x1080 @ 60 Hz	
	Recommended Resolution	1920x1080 @ 60 Hz	
	Horizontal Frequency	30 kHz to 83 kHz	
	Vertical Frequency	56 Hz to 75 Hz	
	Synchronization Type	Separate Sync, Digital	
Input Connector		TV, D-Sub Analog, PC Audio In, component, HDMI*2, CVBS	
Power	Rated Voltage	19 V \pm 2.8 A	
	Power Consumption	On Mode 47 W (typ.) Off Mode \leq 1 W	
AC/DC Adapter		Manufacturer: LITE-ON, Model PA-1650-68 INPUT: AC 100-240 V 50/60 Hz 2.0 A OUTPUT: DC 19 V / 3.42 A	
Tilt	Tilt Range	-5° to 10°	
Dimensions (Width x Height x Depth) Weight	M2780D		
	644 mm x 480.6 mm x 222.8 mm (23.53 inch x 18.92 inch x 8.77 inch) 5.8 kg (12.79 lb)		
Environmental Conditions	M2780DF		
	644 mm x 493.6 mm x 221.7 mm (23.53 inch x 19.43 inch x 8.72 inch) 6.1 kg (13.45 lb)		
Environmental Conditions	Operating Temperature	10 °C to 35 °C	
	Operating Humidity	20 % to 80 %	
	Storage Temperature	-10 °C to 60 °C	
	Storage Humidity	5 % to 90 %	

■ The specifications shown above may be changed without prior notice for quality improvement.

IR CODES

• This feature is not available for all models.

Code (Hexa)	Function	Note
95	Energy Saving	R/C BUTTON
08	POWER	R/C BUTTON (POWER ON/OFF)
50	TV / PC	R/C BUTTON
0B	INPUT	R/C BUTTON
79	RATIO	R/C BUTTON
F0	Auto Config	R/C BUTTON
45	Q.MENU	R/C BUTTON
43	MENU	R/C BUTTON
AB	INFO ⓘ	R/C BUTTON
40	Up (^)	R/C BUTTON
41	Down (v)	R/C BUTTON
07	Left (<)	R/C BUTTON
06	Right (>)	R/C BUTTON
44	Enter(Ⓞ)	R/C BUTTON
28	BACK	R/C BUTTON
5B	EXIT	R/C BUTTON
02	Vol (+)	R/C BUTTON
03	Vol (-)	R/C BUTTON
1E	FAV (MARK)	R/C BUTTON
09	MUTE	R/C BUTTON
00	CH (^)	R/C BUTTON
01	CH (v)	R/C BUTTON
10 to 19	Number Key 0 to 9	R/C BUTTON
53	LIST	R/C BUTTON
1A	FLASHBK	R/C BUTTON
72	RED Key	R/C BUTTON
71	GREEN Key	R/C BUTTON
63	YELLOW Key	R/C BUTTON
61	BLUE Key	R/C BUTTON
B1	■	R/C BUTTON
B0	▶	R/C BUTTON
BA		R/C BUTTON
8F	◀◀	R/C BUTTON
8E	▶▶	R/C BUTTON

APPENDIX

EXTERNAL CONTROL THROUGH RS-232C

RS-232C Setup

The RS-232C port allows you to connect the RS-232C input jack to an external control device (such as a computer or an A/V control system) to control the SET's functions externally.

- Note: the RS-232C on this unit is intended to be used with third party RS-232C control hardware and software. The instructions below are provided to help with programming software or to test functionality using telenet software.

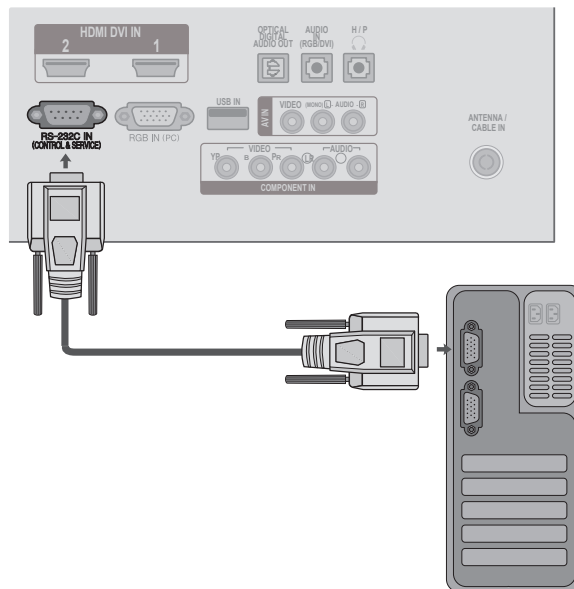

Type of Connector; D-Sub 9-pin Male

No.	Pin Name
1	No connection
2	RXD (Receive data)
3	TXD (Transmit data)
4	DTR (DTE side ready)
5	GND
6	DSR (DCE side ready)
7	RTS (Ready to send)
8	CTS (Clear to send)
9	No Connection

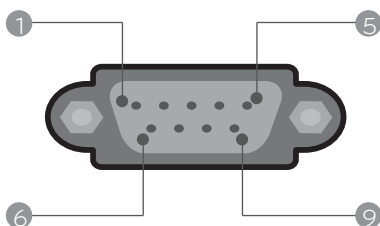

Communication Parameters

- Baud rate: 9600 bps (UART)
- Data length: 8 bits
- Parity: None
- Stop bit: 1 bit
- Communication code: ASCII code
- Use a crossed (reverse) cable.

! NOTE

- ▶ This product has command echo back in the RS-232C Command.

RS-232C Configurations

Either cable below can be used.

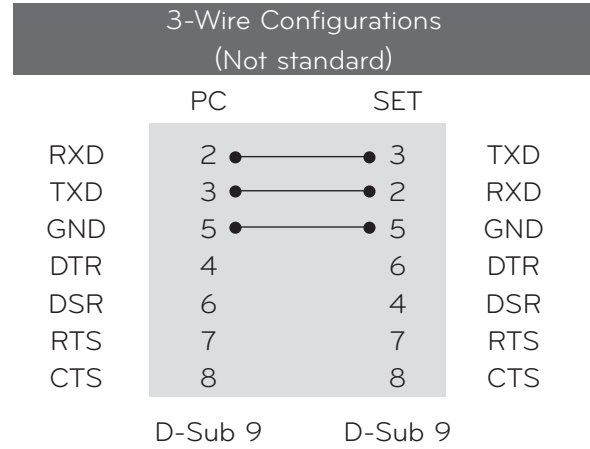
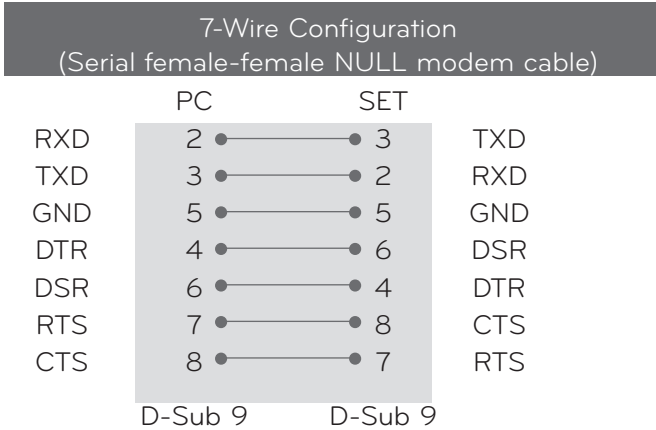

Set ID

Use this function to specify a set ID number.
Refer to 'Real Data Mapping'.

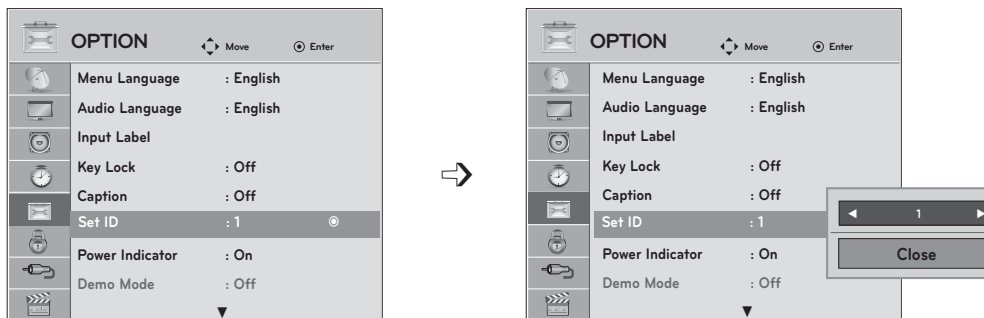

- 1 Select **OPTION**.
- 2 Select **Set ID**.
- 3 Choose the desired TV ID number..
The adjustment range of Set ID is 1 to 99.

* Real data mapping	
1	Step 0
:	
A	Step 10 (Set ID 10)
:	
F	Step 15 (Set ID 15)
10	Step 16 (Set ID 16)
:	
63	Step 99 (Set ID 99)
64	Step 100

- Press **MENU** or **EXIT** to close the menu window.
- Press **BACK** to move to the previous menu screen.

APPENDIX

Command Reference List

	COMMAND 1	COMMAND 2	DATA (Hexadecimal)		COMMAND 1	COMMAND 2	DATA (Hexadecimal)
01. Power	k	a	00 to 01	14. Treble	k	r	00 to 64
02. Input Select	x	b	(▶ p. 121)	15. Bass	k	s	00 to 64
03. Aspect Ratio	k	c	(▶ p. 121)	16. Balance	k	t	00 to 64
04. Screen Mute	k	d	00 to 10	17. Color Temperature	k	u	00 to 02
05. Volume Mute	k	e	00 to 01	18. Energy Saving	j	q	(▶ p. 122)
06. Volume Control	k	f	00 to 64	19. Auto Configuration	j	u	(▶ p. 122)
07. Contrast	k	g	00 to 64	21. Channel Add/Del	m	c	00 to 01
08. Brightness	k	h	00 to 64	22. Key	m	g	(▶ p. 123)
09. Color	k	i	00 to 64	23. Backlight	m	g	00 to 64
10. Tint	k	j	00 to 64				
11. Sharpness	k	k	00 to 64				
12. OSD Select	k	l	00 to 01				
13. Remote Control Lock Mode	k	m	00 to 01				

	COMMAND 1	COMMAND 2	DATA00 (Hexadecimal)	DATA01 (Hexadecimal)	DATA02 (Hexadecimal)	DATA03 (Hexadecimal)	DATA04 (Hexadecimal)	DATA05 (Hexadecimal)
20. Channel Tuning	m	a	physical channel	major high	major low	minor high	minor low	attribute

Transmission/Receiving Protocol

Transmission

[Command1][Command2][][Set ID][][Data][Cr]

[Command 1] : First command to control the set.(j, k, m or x)

[Command 2] : Second command to control the set.

[Set ID] : You can adjust the set ID to choose desired TV ID number in Setup menu. Adjustment range is 1 to 99. When selecting Set ID '0', every connected the TV is controlled. Set ID is indicated as decimal (1 to 99) on menu and as Hexa decimal (0x0 to 0x63) on transmission /receiving protocol.

[DATA] : To transmit the command data.

Transmit the 'FF' data to read status of command.

[Cr] : Carriage Return

ASCII code '0x0D'

[] : ASCII code 'space (0x20)'

* In this model, TV will not send the status during the standby mode.

OK Acknowledgement

[Command2][][Set ID][][OK][Data][x]

The TV transmits ACK (acknowledgement) based on this format when receiving normal data. At this time, if the data is data read mode, it indicates present status data. If the data is data write mode, it returns the data of the PC computer.

* In this model, TV will not send the status during the standby mode.

* Data Format

[Command 2] : Use as command.

[Set ID] : Use the small character, if set ID is 10, it will send the '0', 'a'.

[DATA] : Use the small character, if data is 0 x ab, it will send the 'a', 'b'.

[OK] : Use the large character.

Error Acknowledgement

[Command2][][Set ID][][NG][Data][x]

The TV transmits ACK (acknowledgement) based on this format when receiving abnormal data from non-viable functions or communication errors.

Data1: Illegal Code

Data2: Not supported function

Data3: Wait more time

* In this model, TV will not send the status during the standby mode.

* Data Format

[Command 2] : Use as command.

[Set ID] : Use the small character, if set ID is 10, it will send the '0', 'a'.

[DATA] : Use the small character, if data is 0 x ab, it will send the 'a', 'b'.

[NG] : Use the large character

01. Power (Command: k a)

To control Power On/Off of the TV.

Transmission [k][a][][Set ID][][Data][Cr]

Data 00: Power Off Data 01: Power On

Acknowledgement [a][][Set ID][][OK/NG][Data][x]

* In a like manner, if other functions transmit 'FF' data based on this format, Acknowledgement data feedback presents status about each function.

* Note: In this model, TV will send the Acknowledge after power on processing completion.

There might be a time delay between command and acknowledge.

02. Input Select (Command: x b)

To select input source for TV.

Transmission [x][b][][Set ID][][Data][Cr]

Data 00: DTV (Antenna) Data 01: DTV (Cable)
Data 10: Analog (Antenna) Data 11: Analog (Cable)
Data 20: AV Data 40: Component
Data 60: RGB-PC Data 90: HDMI1
Data 91: HDMI2

Acknowledgement [b][][Set ID][][OK/NG][Data][x]

03. Aspect Ratio (Command: k c)

To adjust the screen format.

Transmission [k][c][][Set ID][][Data][Cr]

Data 01: 4:3 09: Just scan
02: 16:9 10: Cinema Zoom1
04: Zoom ⋮
06: Set by program 1F: Cinema Zoom16

Acknowledgement [c][][Set ID][][OK/NG][Data][x]

04. Screen Mute (Command: k d)

To select screen mute on/off.

Transmission [k][d][][Set ID][][Data][Cr]

Data 00: Screen mute off (Picture on), Video-out Mute off
Data 01: Screen mute on (Picture off)
Data 10: Video-out Mute on

Acknowledgement [d][][Set ID][][OK/NG][Data][x]

* In case of Video-out Mute on only, TV will display On Screen Display (OSD). But, in case of screen mute on, TV will not display On Screen Display (OSD).

05. Volume Mute (Command: k e)

To control volume mute on/off.

You can also adjust mute using the MUTE button on remote control.

Transmission [k][e][][Set ID][][Data][Cr]

Data 00: Volume mute on (Volume off)

Data 01: Volume mute off (Volume on)

Acknowledgement [e][][Set ID][][OK/NG][Data][x]

06. Volume Control (Command: k f)

To adjust volume.

You can also adjust volume with the volume buttons on remote control.

Transmission [k][f][][Set ID][][Data][Cr]

Data Min: 00 to Max: 64 (*transmit by Hexadecimal code)

*Refer to 'Real data mapping'. See page 119.

Acknowledgement [f][][Set ID][][OK/NG][Data][x]

07. Contrast (Command: k g)

To adjust screen contrast.

You can also adjust contrast in the PICTURE menu.

Transmission [k][g][][Set ID][][Data][Cr]

Data Min: 00 to Max: 64 (*transmit by Hexadecimal code)

*Refer to 'Real data mapping'. See page 119.

Acknowledgement [g][][Set ID][][OK/NG][Data][x]

08. Brightness (Command: k h)

To adjust screen brightness.

You can also adjust brightness in the PICTURE menu.

Transmission [k][h][][Set ID][][Data][Cr]

Data Min: 00 to Max: 64 (*transmit by Hexadecimal code)

*Refer to 'Real data mapping'. See page 119.

Acknowledgement [h][][Set ID][][OK/NG][Data][x]

09. Color (Command: k i)

To adjust screen color.

You can also adjust color in the PICTURE menu.

Transmission [k][i][][Set ID][][Data][Cr]

Data Min: 00 to Max: 64 (*transmit by Hexadecimal code)

*Refer to 'Real data mapping'. See page 119.

Acknowledgement [i][][Set ID][][OK/NG][Data][x]

10. Tint (Command: k j)

To adjust screen tint.

You can also adjust tint in the PICTURE menu.

Transmission [k][j][][Set ID][][Data][Cr]

Data Red: 00 to Green: 64 (*transmit by Hexadecimal code)

*Refer to 'Real data mapping'. See page 119.

Acknowledgement [j][][Set ID][][OK/NG][Data][x]

APPENDIX

11. Sharpness (Command: k k)

To adjust screen sharpness.

You can also adjust sharpness in the PICTURE menu.

Transmission [k][k][][Set ID][][Data][Cr]

Data Min: 00 to Max: 64 (*transmit by Hexadecimal code)

*Refer to 'Real data mapping'. See page 119.

Acknowledgement [k][][Set ID][][OK/NG][Data][x]

12. OSD Select (Command: k l)

To select OSD (On Screen Display) on/off.

Transmission [k][l][][Set ID][][Data][Cr]

Data 00: OSD off Data 01: OSD on

Acknowledgement [l][][Set ID][][OK/NG][Data][x]

13. Remote Control Lock Mode (Command: k m)

To lock the remote control and the front panel controls on the Monitor set.

Transmission [k][m][][Set ID][][Data][Cr]

Data 00: Lock off Data 01: Lock on

Acknowledgement [m][][Set ID][][OK/NG][Data][x]

If you're not using the remote control and front panel controls on the TV, use this mode. When main power is on/off, remote control lock is released.

If Key Lock is on in the standby mode, TV will not turn on by POWER button of remote control and on the TV.

14. Treble (Command: k r)

To adjust treble.

You can also adjust treble in the AUDIO menu.

Transmission [k][r][][Set ID][][Data][Cr]

Data Min: 00 to Max: 64 (*transmit by Hexadecimal code)

*Refer to 'Real data mapping'. See page 119.

Acknowledgement [r][][Set ID][][OK/NG][Data][x]

15. Bass (Command: k s)

To adjust bass.

You can also adjust bass in the AUDIO menu.

Transmission [k][s][][Set ID][][Data][Cr]

Data Min: 00 to Max: 64 (*transmit by Hexadecimal code)

*Refer to 'Real data mapping'. See page 119.

Acknowledgement [s][][Set ID][][OK/NG][Data][x]

16. Balance (Command: k t)

To adjust balance.

You can also adjust balance in the AUDIO menu.

Transmission [k][t][][Set ID][][Data][Cr]

Data Min: 00 to Max: 64 (*transmit by Hexadecimal code)

*Refer to 'Real data mapping'. See page 119.

Acknowledgement [t][][Set ID][][OK/NG][Data][x]

17. Color Temperature (Command: k u)

To adjust color temperature.

You can also adjust color temperature in the PICTURE menu.

Transmission [k][u][][Set ID][][Data][Cr]

Data 00: Medium 01: Cool 02: Warm

Acknowledgement [u][][Set ID][][OK/NG][Data][x]

18. Energy Saving (Command: j q)

To control the energy saving function.

Transmission [j][q][][Set ID][][Data][Cr]

Data 00: Energy saving - off

01: Energy saving - Minimum

02: Energy saving - Medium

03: Energy saving - Maximum

05: Energy saving - Screen off

Acknowledgement [q][][Set ID][][OK/NG][Data][x]

19. Auto Configuration (Command: j u)

To adjust picture position and minimize image shaking automatically. Auto configuration only works in RGB-PC mode.

Transmission [j][u][][Set ID][][Data][Cr]

Data 01: To set

Acknowledgement [u][][Set ID][][OK/NG][Data][x]

20. Channel Tuning (Command: m a)

To tune channel to following physical/major/minor number.

Transmission [m][a][][Set ID][][Data00][][Data01]

[][Data02][][Data03][][Data04][][Data05][Cr]

Digital channels have a Physical, Major, and Minor channel number. The Physical number is the actual digital channel number, the Major is the number that the channel should be mapped to, and the Minor is the sub-channel. Since the ATSC tuner automatically maps the channel to the Major number, the Physical number is not required when sending a command.

Data 00: Physical Channel Number

NTSC air: 02 to 45, NTSC cable: 01, 0E to 7D

ATSC air: 01 to 45, ATSC cable: 01 to 87

Data 01 & 02: Major Channel Number

Data 01: High byte

Data 02: Low byte

Two bytes are available for the Major and Minor, normally only the second byte is used.

Data 03 & 04: Minor Channel Number

Not needed for NTSC.

Data05:	7	6	5	4	3	2	1	0	Step
	Main/Sub Picture	Two/One Part Channe	Using Physical Channel	Reserved					
0	Main	0 Two	0 Use	x	0	0	0	0	NTSC Air
1	Sub	1 One	1 No Use	x	0	0	0	1	NTSC Cable
				x	0	0	1	0	ATSC Air
				x	0	0	1	1	ATSC Cable_std
				x	0	1	0	0	ATSC Cable_hrc
				x	0	1	0	1	ATSC Cable_irc
				x	0	1	1	0	ATSC cable_auto
				x	0	1	1	1	Reserved
				x	x	x	x	x	...
				x	1	1	1	1	Reserved

The table above lists the binary code that must be converted to hexadecimal before sending. For example, the binary code to tune the sub source to an NTSC cable channel is "1000 0001", which translates to "81" in hex.

* 7th bit: for which source do you want to change the channel.

* 6th bit: use a two part or one part channel. Most cases just use 0 since it's ignored when using NTSC.

* 5th bit: use 0 with NTSC since it can only use the physical channel number. Normally use 1 for ATSC since most times it doesn't matter what the physical number is

* 4th bit: set to 0.

* 3-0 bits: choose signal type.

* Tune Command Examples:

1. Tune to the analog (NTSC) cable channel 35.

Data 00 = Physical of 35 = 23

Data 01 & 02 = No Major = 00 00

Data 03 & 04 = No Minor = 00 00

Data 05 = 0000 0001 in binary = 01

Total = ma 00 23 00 00 00 00 01

2. Tune to the digital (ATSC) local channel 30-3.

Data 00 = Don't know Physical = 00

Data 01 & 02 = Major is 30 = 00 1E

Data 03 & 04 = Minor is 3 = 00 03

Data 05 = 0010 0010 in binary = 22

Total = ma 00 00 00 1E 00 03 22

```
Acknowledgement[a][ ][Set ID][ ][OK][Data00]
[Data01] [Data02][Data03][Data04][x][a][ ][Set
ID][ ][NG][Data00][x]
```

21. Channel Add/Del (Command: m b)

To add and delete the channels.

```
Transmission [m][b][ ][Set ID][ ][Data][Cr]
```

Data 00: Channel Delete Data 01: Channel Add

```
Acknowledgement [b][ ][Set ID][ ][OK/NG][Data][x]
```

22. Key (Command: m c)

To send IR remote control code.

```
Transmission [m][c][ ][Set ID][ ][Data][Cr]
```

See page 118.

```
Acknowledgement [c][ ][Set ID][ ][OK/NG][Data][x]
```

When TV is in the standby mode, TV will turn on by POWER button of remote control only.

23. Backlight (Command: m g)

To adjust screen backlight.

```
Transmission [m][g][ ][Set ID][ ][Data][Cr]
```

Data Min:00 - Max:64 (*transmit by Hexadecimal code)

*Refer to 'Real data mapping'. See page 119.

```
Acknowledgement [g][ ][Set ID][ ][OK/NG][Data][x]
```

CHILD SAFETY:

It Makes A Difference How and Where
You Use Your Flat Panel Display

Congratulations on your purchase! As you enjoy your new product, please keep these safety tips in mind:



THE ISSUE

- The home theater entertainment experience is a growing trend and larger flat panel displays are popular purchases. However, flat panel displays are not always supported on the proper stands or installed according to the manufacturer's recommendations.
- Flat panel displays that are inappropriately situated on dressers, bookcases, shelves, desks, speakers, chests or carts may fall over and cause injury.

THIS MANUFACTURER CARES!

- The consumer electronics industry is committed to making home entertainment enjoyable and safe.

TUNE INTO SAFETY

- One size does NOT fit all. Follow the manufacturer's recommendations for the safe installation and use of your flat panel display.
- Carefully read and understand all enclosed instructions for proper use of this product.
- Don't allow children to climb on or play with furniture and television sets.
- Don't place flat panel displays on furniture that can easily be used as steps, such as a chest of drawers.
- Remember that children can become excited while watching a program, especially on a "larger than life" flat panel display. Care should be taken to place or install the display where it cannot be pushed, pulled over, or knocked down.
- Care should be taken to route all cords and cables connected to the flat panel display so that they cannot be pulled or grabbed by curious children.

WALL MOUNTING: IF YOU DECIDE TO WALL MOUNT YOUR FLAT PANEL DISPLAY, ALWAYS:

- Use a mount that has been recommended by the display manufacturer and/or listed by an independent laboratory (such as UL, CSA, ETL).
- Follow all instructions supplied by the display and wall mount manufacturers.
- If you have any doubts about your ability to safely install your flat panel display, contact your retailer about professional installation.
- Make sure that the wall where you are mounting the display is appropriate. Some wall mounts are not designed to be mounted to walls with steel studs or old cinder block construction. If you are unsure, contact a professional installer.
- A minimum of two people are required for installation. Flat panel displays can be heavy.



 **CEA**
Consumer Electronics Association
www.CE.org/safety

P/NO : 3840TRL098E (0801-REV00)



Make sure to read the Safety Precautions before using the product.
Keep the Owner's Manual (CD) in an accessible place for future reference.
The model and serial number of the set is located on the back and one side of the set.
Record it below should you ever need service.

MODEL _____

SERIAL _____