

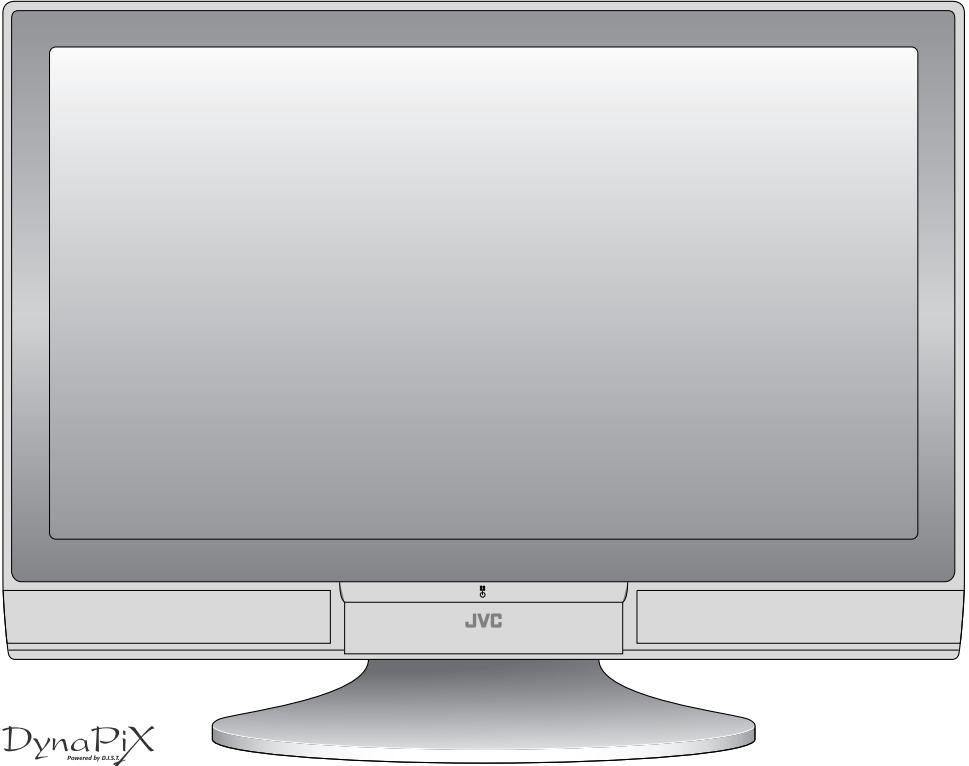

PD-42DX6BJ

PDP COLOUR TELEVISION INSTRUCTIONS



DynaPiX
Powered by D.L.S.S.

InteriArt
HDMITM
HIGH-DEFINITION MULTIMEDIA INTERFACE

T-V LINK

DVB[®]
**Digital Video
Broadcasting**



Trade Mark of the DVB Digital Video Broadcasting
Project (1991 to 1996) Number : 3481

IMPORTANT!

PREPARE

USE

SETTINGS

TROUBLE?

Expanding the world of



beautiful images

Enjoy rich multi-media with JVC

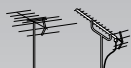

VHF / UHF / DVB-T broadcasting

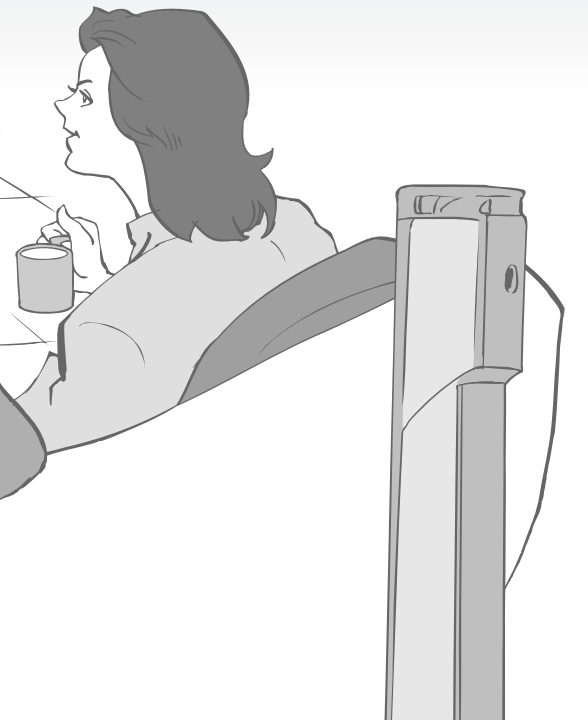
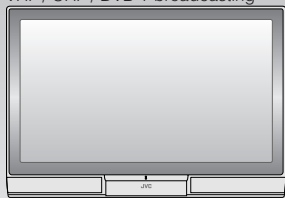

Contents

*In this manual,
ATV : analogue terrestrial broadcasting (VHF / UHF)
DTV : digital terrestrial broadcasting (DVB-T)

First things first!

●Warning	4
----------------	---

Getting started

●Names of all the parts	6
●Basic connections	8
●Connecting external devices	10
●Initial settings	12
●Editing DTV channels	14
●Editing ATV channels	16

Let's try it out

●Enjoying your new TV!	18
· TV / Teletext / EPG / Video / Menu	
●Watching TV	20
●Using EPG	22
●Viewing teletext	24
●Watching videos / DVDs	26

Try the advanced features

●Useful functions	28
· Multi-picture / Favourite channel	
· Sleep timer / Child lock	

Just the way you like it

●Customising your TV	32
●Using DTV	34
●Advanced picture adjustment	40
· Reduce noise / Watch a more natural picture	
· Set the aspect ratio, etc.	

When you have trouble

●Troubleshooting	42
●CH / CC List	45
●Technical information	46
●Specifications	47

Warning

Please follow all the guidelines below

Never cut or damage the power cord!

- If the AC plug is not the right shape, or the power cord is not long enough, use an appropriate plug adapter or extension cable. (Consult your retailer.)

Never place anything on the TV!

- Placing liquids, naked flames, cloths, paper, etc. on the TV may cause a fire.

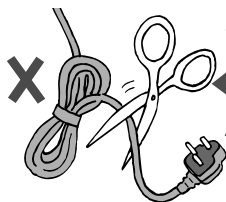

Never try to repair the TV yourself!

➔ If the problem cannot be solved in "Troubleshooting" (P. 42), unplug the power cord and contact your retailer.

- If you have cut or damaged the power cord
➔ "Technical information" (P. 46)
- To change the fuse in UK plugs
➔ "Technical information" (P. 46)

Follow this manual regarding setup!

- Use only the power cord included.
- Connect only to an earthed AC110-240V, 50/60Hz mains outlet.

Unplug the power cord when going out!

- The power buttons on the remote control and the TV unit can not completely turn off the TV. (Make appropriate arrangements for bedridden people.)

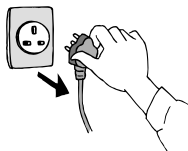

Never insert objects into the cabinet openings!

- It may cause a fatal electric shock. Take care when children are near.



■ For more details on installation, usage and safety ➔ Consult your retailer

Never expose to rain or moisture!

- To prevent fire or electric shock, never allow liquids to enter the unit.



If the TV is damaged or behaving strangely, stop using it at once!

- ➔ Unplug the power cord and contact your retailer.

Never display the same image for a long time!

It causes a part of the image to remain on the screen ("burn-in"). Once burn-in occurs, it will never disappear.

■ To prevent burn-in :

- Never display PC content or teletext for long periods of time.
- Watch TV using the entire screen area.
 - ➔ Set the aspect ratio to PANORAMIC in ZOOM (P. 20)
- Never view in MULTI-PICTURE (P. 28) mode for long periods of time.
- Set PICTURE SHIFT to SLOW (P. 33).
- Set CONTRAST (P. 33) and BRIGHT (P. 33) to a lower level.
- REFRESH (P. 33) may be able to partially remove mild burn-in.

To completely remove a burn-in, the whole plasma panel must be exchanged at the factory.
(This is not covered by the warranty.)

Never remove panels or covers!

- It may cause an electric shock.

Never obstruct the ventilation holes!

- It may cause overheating or a fire.

Handle all glass panels with care!

- Use a soft, dry cloth when cleaning.

Never listen to headphones at high volume!

- It may damage your hearing.

Names of all the parts

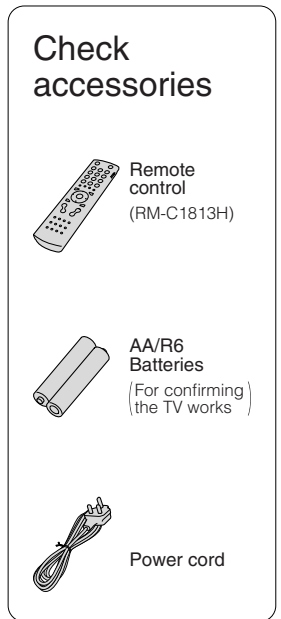
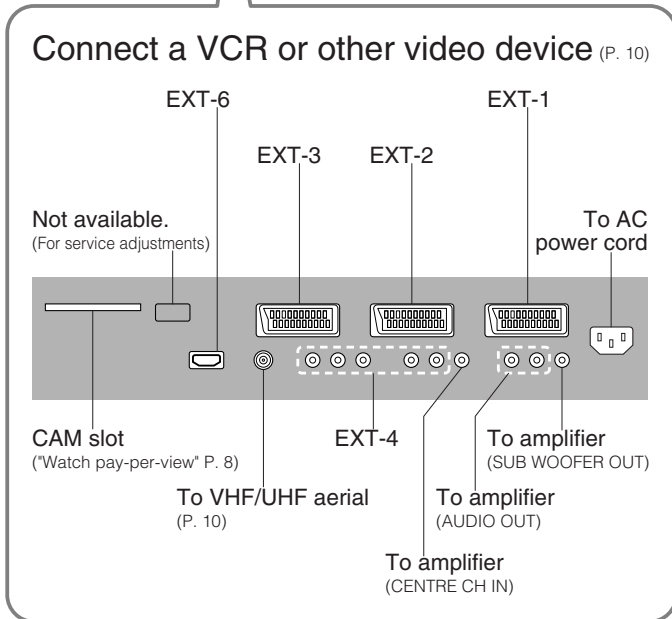
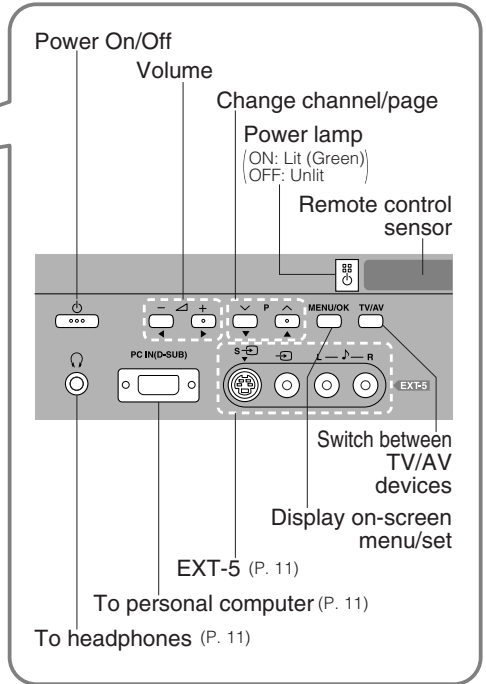
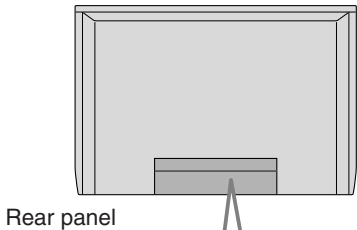
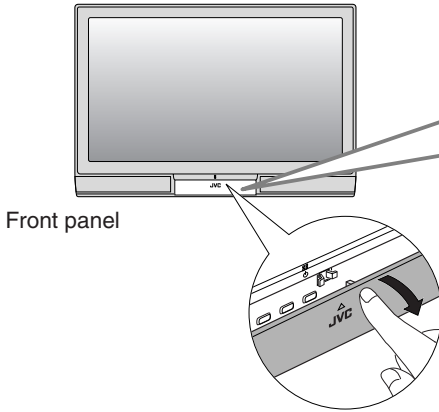

Mute



Power On/Off



Switch between VCR/TV/DVD (P. 26)

Change the channel/page

Channel information (P. 20)



Watch video, etc. (P. 26)

To ATV/DTV



To menu (P. 32)

The coloured buttons can perform different functions according to the situation.

■ When viewing teletext (P. 24)
Follow on-screen instructions.

■ Other uses



Follow instructions in on-screen guides.

■ When watching TV/Video

Change the aspect ratio (P. 20)

Turn on 3D sound (P. 20)

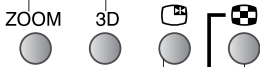

Take a snapshot of the screen (P. 20)

View in multi-picture mode (P. 28)

■ Insert the batteries

Use two AA/R6 dry cell batteries. Insert the batteries from the - end, making sure the ⊕ and ⊖ polarities are correct.

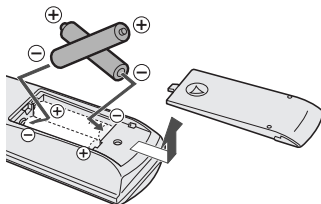

Select and confirm settings in menus

To the previous channel

To teletext (P. 24)

Volume

Change the channel/page

■ When watching DTV

View subtitles (P. 20)

View the electronic programme guide (EPG)(P. 22)

SUB TITLE GUIDE



■ When watching ATV (P. 16)

when viewing teletext (P. 24)

SUB TITLE GUIDE

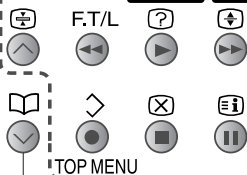

■ When choosing a favourite channel (P. 29)

■ When operating a JVC VCR or DVD (P. 26)

Basic connections

Please read the user manuals of each device carefully before setting up.
It is necessary to connect an aerial to watch TV.

■ **Connect with other devices** → "Connecting external devices" (P. 10)

Connect the aerial

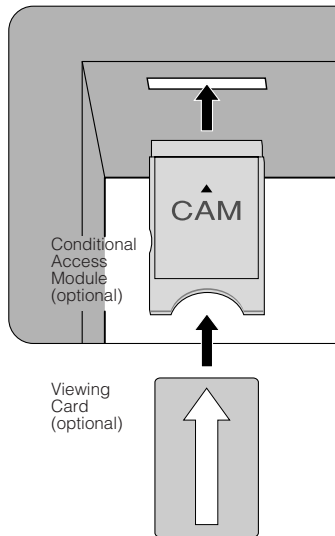
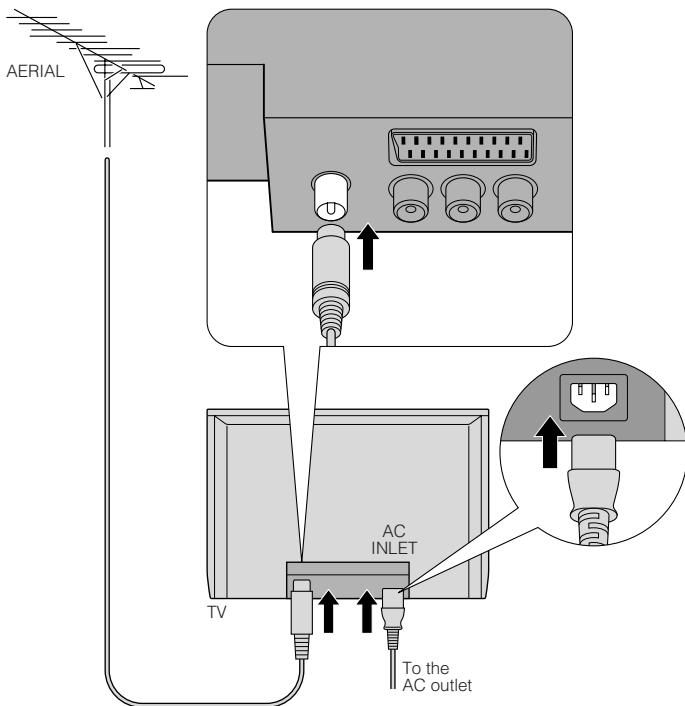

Care when setting

■ Power requirements

- Use the included power cord and connect only to an earthed 110-240V, 50/60Hz AC outlet.

■ When attaching the TV to the wall, use the optional JVC wall mounting unit.

- Consult a qualified technician.
- See the included manual on mounting procedures.
- JVC assumes no responsibility for damage due to improper mounting.

■ Installation requirements

- To avoid overheating, ensure the unit has ample room.

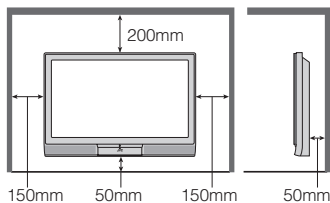

Watch pay-per-view

Contract with a broadcasting company beforehand.

- ① Unplug the power cord
- ② Insert the Viewing Card into the CAM
- ③ Insert the CAM
- ④ Plug the power cord, and turn the power on
 - Set pay-per-view → (P. 38)
- The CAM and Viewing Card will be sent by the broadcasting company after contracting with them.

Connect a VCR/DVD recorder

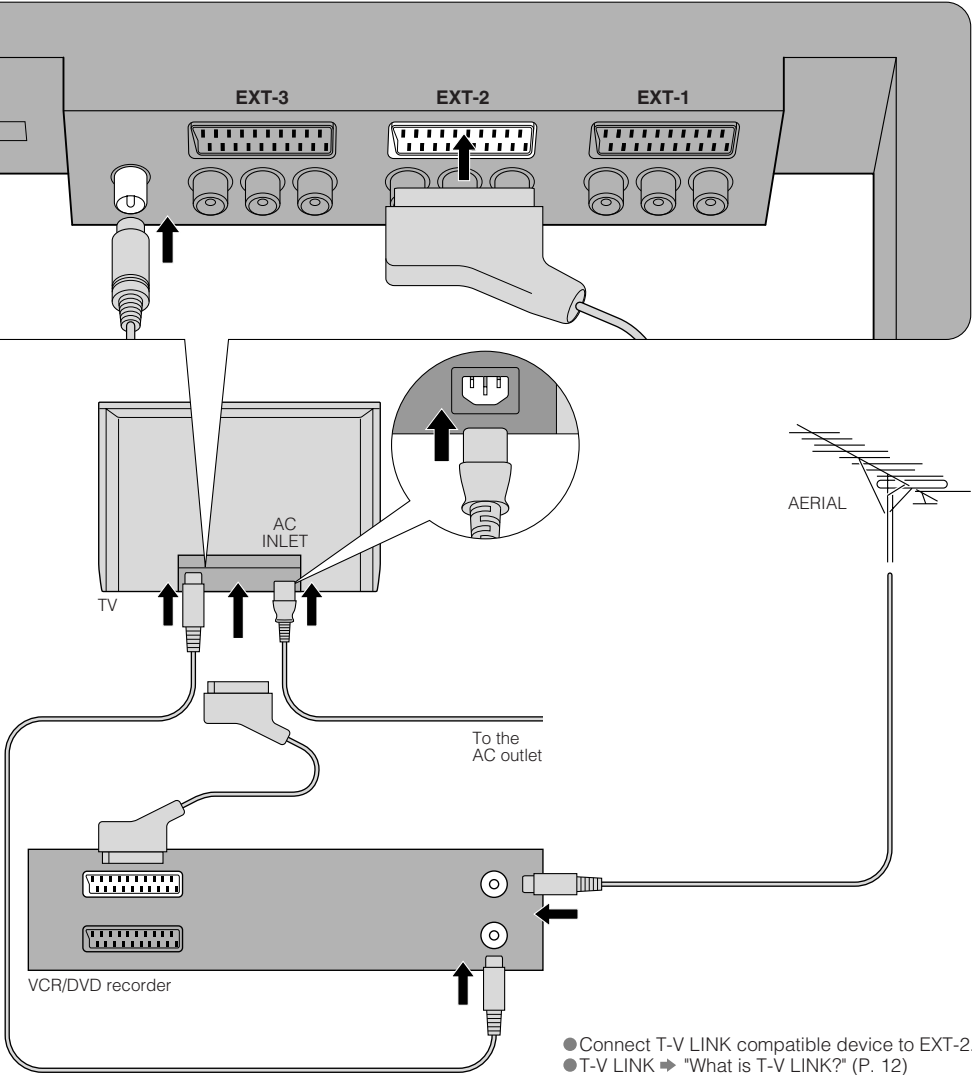

- Connect T-V LINK compatible device to EXT-2.
- T-V LINK ➔ "What is T-V LINK?" (P. 12)

Connecting external devices

You can connect many different devices to the rear panel of the TV. Please read the user manuals of each device before setting up. (Connecting cables are not supplied with this TV.)

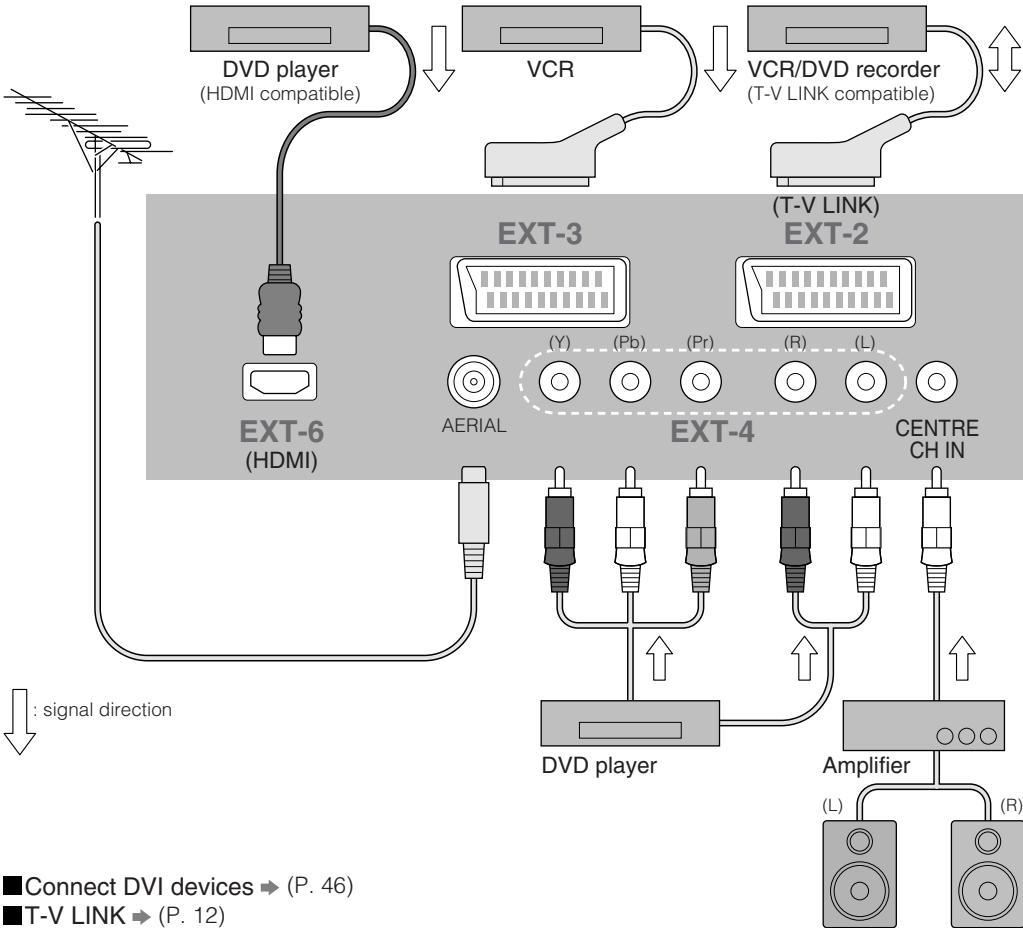

EXT-1 Watching videos

Output ↑	Input ↓
· Composite signal · Sound L/R	· Composite signal/ RGB/S-VIDEO · Sound L/R

● Use S-VIDEO → "S-IN" (P. 27)

EXT-2 Dubbing videos Using T-V LINK

Output ↑	Input ↓
· Composite signal · Sound L/R	· Composite signal/ RGB/S-VIDEO · Sound L/R
· T-V LINK	

- Use S-VIDEO → "S-IN" (P. 27)
- Select dubbing sources → "DUBBING" (P. 27)
- Connect a decoder → "DECODER" (P. 33)

EXT-3 Watching videos

Output ↑	Input ↓
	· Composite signal · Sound L/R

VCR/DVD/other devices

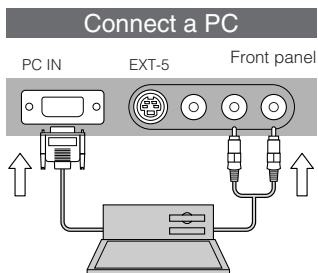
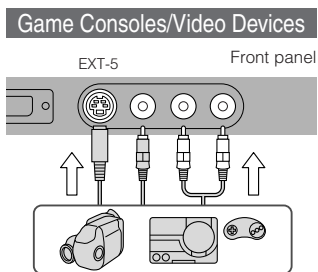
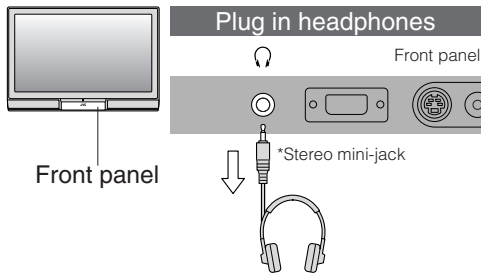
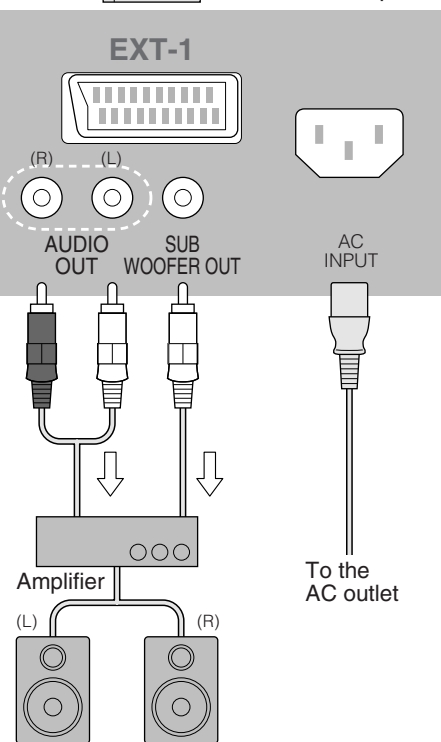
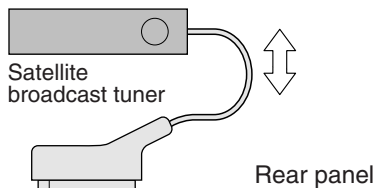

- Check for PC compatibility
- ➔ "Technical information" (P. 46)

EXT-4 Watching DVDs

Output ↓	Input ↑
	<ul style="list-style-type: none"> · Component signal (P. 47) · Sound L/R

- Component auto select ➔ (P. 33)

CENTRE CH IN SUB WOOFER/AUDIO OUT

Using the TV's speakers as centre channel

Input ↑
<ul style="list-style-type: none"> · Centre channel sound

Listening to the TV on external speakers

Output ↓
<ul style="list-style-type: none"> · Sound L/R · Subwoofer sound

EXT-6 Connecting HDMI devices

Output ↑	Input ↓
	<ul style="list-style-type: none"> · HDMI signal (P. 47)

- HDMI setting ➔ (P. 33)

IMPORTANT!

PREPARE

USE

SETTINGS

TROUBLE?

Initial settings

Register DTV/ATV channels on TV. These channels can be edited later.
(In this manual, digital broadcasting is indicated as DTV, and analogue broadcasting as ATV.)

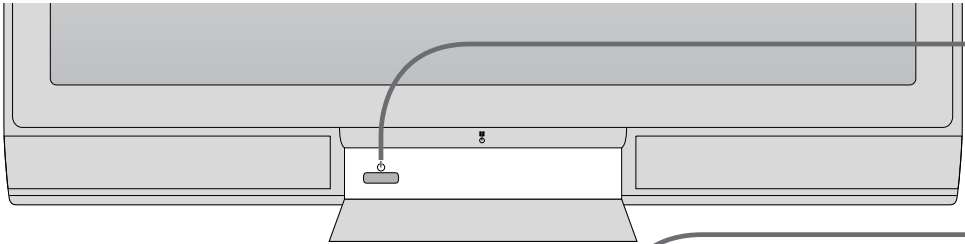

■ To the previous screen →  BACK

■ Exit →  TV/DTV

■ If the "JVC" logo does not appear or if you wish to make changes later
→ DTV : "Automatic Search" (P. 38)
→ ATV : "AUTO PROGRAM" (P. 33)

What is "T-V LINK"?

Connecting the TV to a T-V LINK compatible device allows :

- ATV channels on the TV to be instantly registered on the device.
- The "DIRECT REC" function to be used.
→ "Technical information" (P. 46)

■ T-V LINK variations

"T-V LINK" (JVC) "Q-LINK" (Panasonic)
"Megalogic" (Grundig) "Data Logic" (Metz)
"SMARTLINK" (Sony) "Easy Link" (Philips)

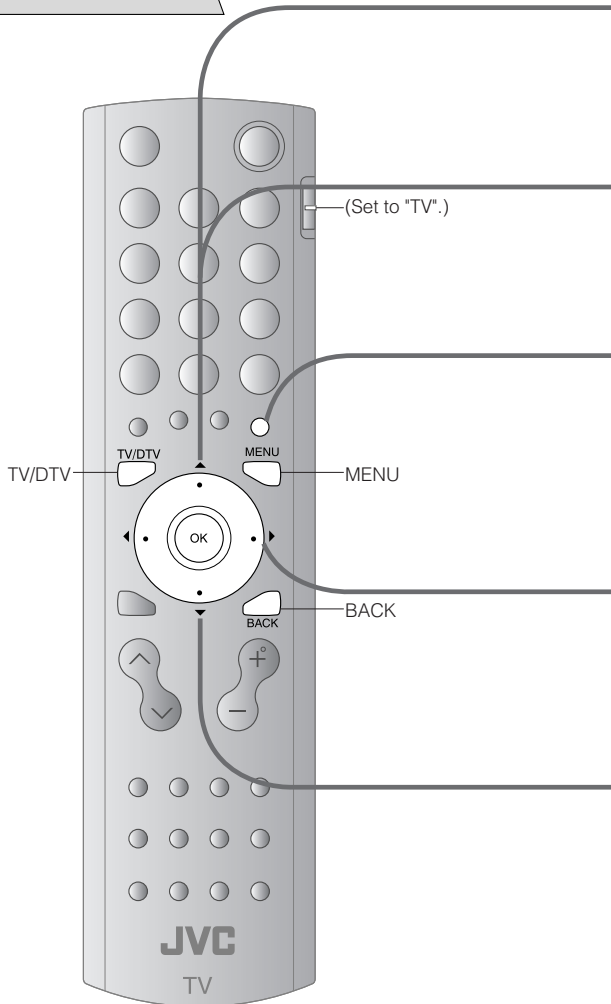

1

Begin



- Shown only when powering on for the first time.
- The power button on the remote control can be used.

2

Automatically register DTV channels

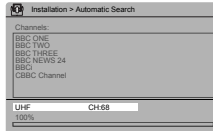

3

Check what was registered



■ Edit DTV channels

➔ 5 in "Editing DTV channels" (P. 14)

■ Confirm MENU



4

Automatically register ATV channels

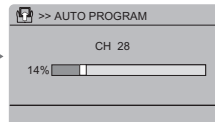
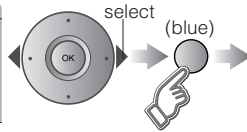

- If "ACI START" appears, select and start settings. (This will set up cable television channels.)
- ➔ "What is ACI (Automatic Channel Installation)?" (P. 46)

5

Check what was registered

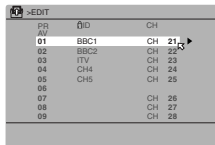

■ Edit ATV channels

➔ 5 in "Editing ATV channels" (P. 16)

■ Confirm



6

Finish

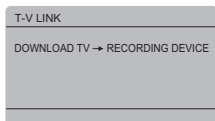

■ When using T-V LINK



- If "FEATURE NOT AVAILABLE" appears :
 - ➔ Is a T-V LINK compatible device connected to EXT-2?
 - ➔ Is the device turned on?

■ When not using T-V LINK



Editing DTV channels

Edit the channels registered with "Automatic search" in "Initial settings" (P. 12).

When coming from "Initial settings" (P. 12), skip to ⑤.

- 1 **Select DTV**
TV/DTV
- 2 **Display the menu bar**
MENU
- 3 **Select "DTV"**
- 4 **Select "Edit PR List"**
- 5 **Select a channel**
- 6 **Edit**
- 7 **Finish**
MENU

■ **To the previous screen**
 → BACK

■ **Exit**
 → MENU

■ **Tips for operation**
 →

Red: Page up
 Green: Page down
 TV/DTV: on to DTV
 Guide: Go to guide
 Back: Go to previous
 i: Exit help

Confirm the channel picture

Select

Delete a channel

Delete

Edit a channel name

Edit Name

Stop Children from watching specific channels

Lock

Register your favourite channel

Favourites

①Select "Select"

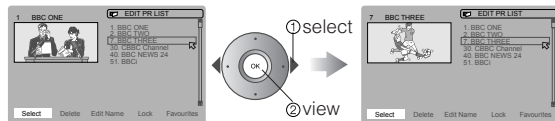

①Select "Delete"

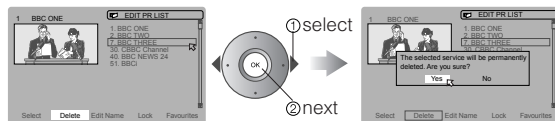

②Select "Yes"

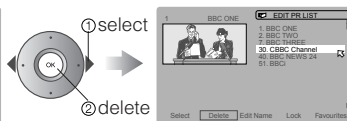

①Select "Edit Name"

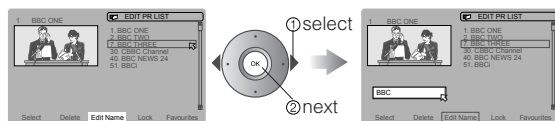

②Change the name

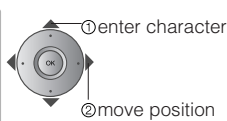

③Decide

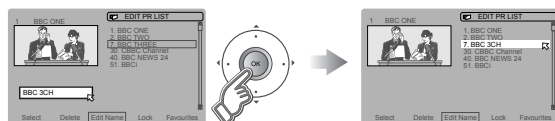

①Select "Lock"

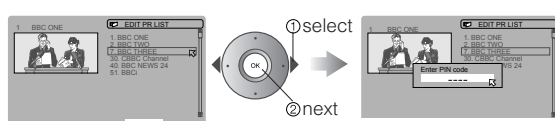

②Enter PIN code



- Default is "0000".
➔ "Change PIN code" (P. 37)

- To release, repeat the same steps.

①Select "Favourites"

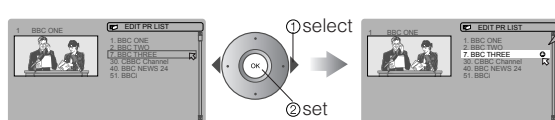

- To release, repeat the same steps.

- Move through only your favourite channels
➔ "Favourite Mode" (P. 37)

Editing ATV channels

Edit the channels registered with "AUTO PROGRAM" in "Initial settings" (P. 12).

When coming from "Initial settings" (P. 12), skip to ⑤.

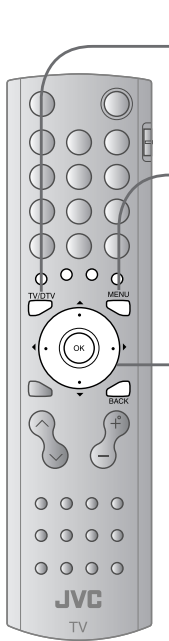

①

Select ATV



②

Display the menu bar



③

Select "SET UP"

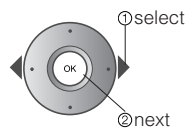

④

Select "EDIT/MANUAL"

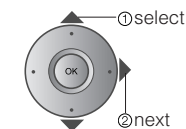
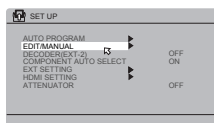

⑤

Select a row

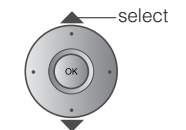
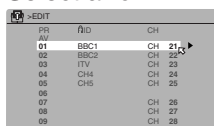

■ To the previous screen



■ Exit



⑥

Edit

⑦

Confirm settings



⑧

Finish

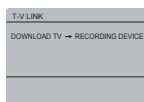

■ When using T-V LINK



■ When not using T-V LINK



- If "FEATURE NOT AVAILABLE" appears :
 - ➔ Is a T-V LINK compatible device connected to EXT-2?
 - ➔ Is the device turned on?
- T-V LINK ➔ (P. 12)

Move a channel's position

MOVE

Edit a channel name

ID

Insert a channel

INSERT

Delete a channel

DELETE

Register a new channel

MANUAL

①Begin

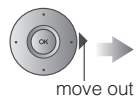

PR	ID	CH
01	BBC1	CH 21
02	BBC2	CH 22
03	ITV	CH 23
04	CH4	CH 24
05	CH5	CH 25
06		CH 26
07		CH 27
08		CH 28
09		CH 28

②Select a destination

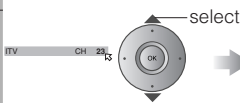

③Finish

PR	ID	CH
01	BBC1	CH 21
02	BBC2	CH 22
03	ITV	CH 24
04	CH4	CH 24
05	ITV	CH 23
06		CH 26
07		CH 27
08		CH 27
09		CH 28



①Begin



②Enter a channel name

PR	ID	CH
01	BBC1	CH 21
02	BBC2	CH 22
03	ITV	CH 23
04	CH4	CH 24
05	CH5	CH 25
07		CH 26
08		CH 27
09		CH 28

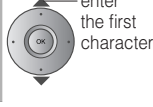

■When selecting a preset name from the ID LIST

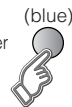

PR	ID	CH	ID LIST
01	BBC1	CH 21	MBC
02	BBC2	CH 22	ITV
03	ITV	CH 23	MBC
04	CH4	CH 24	ITV
05	CH5	CH 25	MBC
06		CH 26	ITV
07		CH 27	MBC
08		CH 27	ITV
09		CH 28	MBC

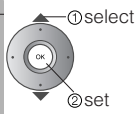

■When manually naming a channel



PR	ID	CH
01	BBC1	CH 21
02	BBC2	CH 22
03	ITV	CH 23
04	CH4	CH 24
05	CH5	CH 25
07	JVC	CH 26
08		CH 27
09		CH 28

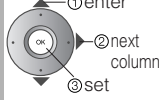

①Begin

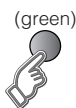

②Enter a CH number

PR	ID	CH
01	BBC1	CH 21
02	BBC2	CH 22
03	ITV	CH 23
04	CH4	CH 24
05	CH5	CH 25
06		CH 26
07		CH 30
08		CH 27
09		CH 28



③Set

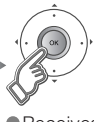

- CH/CC List → (P. 45)
- In Ireland, select CH/CC with ▲ ▼.

①Delete



PR	ID	CH
01	BBC2	CH 22
02	ITV	CH 23
03	CH4	CH 24
04	CH5	CH 25
05		CH 26
06		CH 27
07		CH 28

①Begin



PR	ID	CH
10		CH 29
11		CH 30
12		CH 31
13		CH 32
14		CH 33
15		CH 34
16		CH 35
17		CH 36

②Search for a channel

From high frequencies

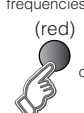

From low frequencies



PR	ID	CH
10		CH 39
11		CH 35
12		CH 36
13		CH 37
14		CH 38
15		CH 39
16		CH 40
17		CH 41

③Set



PR	ID	CH
10		CH 29
11		CH 35
12		CH 36
13		CH 37
14		CH 38
15		CH 39
16		CH 40
17		CH 41

- Auto-search begins, and the nearest frequency is imported.
 - ➔ Repeat the previous steps until the desired channel is displayed

■ Picture fine tuning → (yellow) (blue) ○ / ○

Enjoying your new TV!

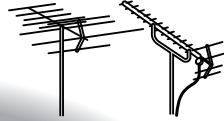

Watching TV

PAGE
20

- View channel information
- Change the aspect ratio
- Enjoy 3D sound
- Take snapshots of the screen

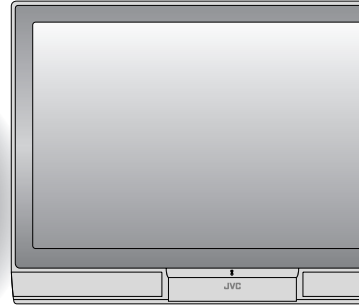
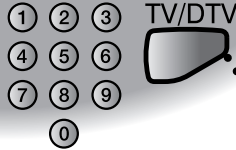

Viewing teletext

PAGE
24

- Enlarge the text
- To the index page
- Hold the current page
- Switch briefly between teletext and TV
- Bookmark your favourite pages

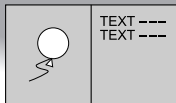

TV and Text mode

GUIDE



Using EPG

PAGE
22

- View the programme list for 8 days
- Search from a genre
- Reserve a programme to watch/record

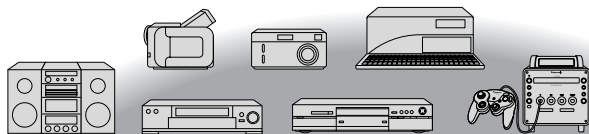

PAGE
26 **Watching videos/DVDs**

- Watch high quality video (S-VIDEO)
- Name connected devices
- Dub videos



MENU



PAGE
32 **Personal preferences**

- Adjust the picture
- Adjust the sound

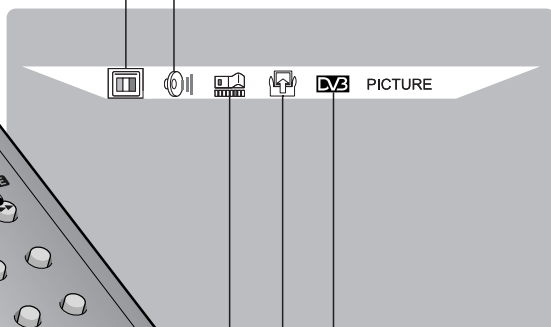

■ Use DTV
(timer-record/configuration/channel settings, etc.)

■ Basic settings
(channel settings/anti-burn, etc.)

■ Advanced settings
(sleep-timer/child lock, etc.)

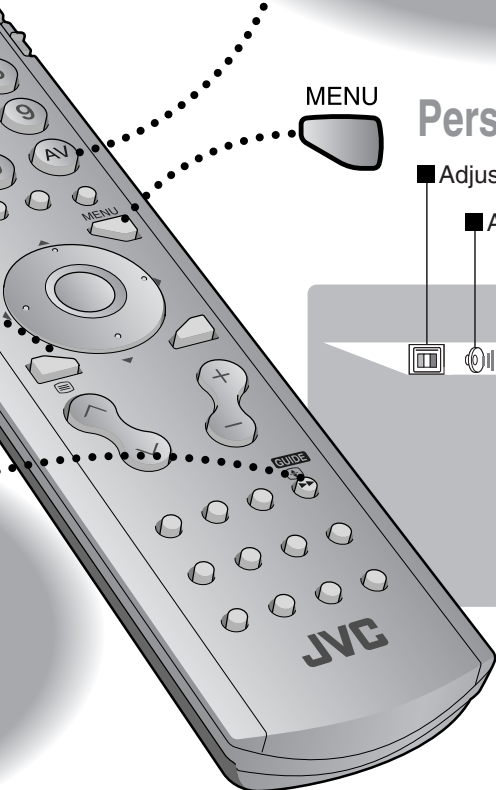

IMPORTANT!

PREPARE

USE

SETTINGS

TROUBLE?

Watching TV



1 Power on

The green power lamp on the TV lights.

- Press again to turn the screen off and put the TV into standby mode.

2 Select ATV/DTV TV/DTV

- DTV : Digital broadcasting
- ATV : Analogue broadcasting

3 Select a channel

1 2 3
4 5 6
7 8 9
0

- Move up or down a channel

up
down

- With DTV, you can select only from your favourite channels → (P. 37)
- To the previous channel

BACK

■ Mute ■ Volume

■ Switch between stereo/mono/bilingual broadcasting
→ "STEREO/ I · II" (P. 33)

Note

- To completely turn off the TV, unplug the AC plug.
- Watch pay-per-view → (P. 38)
- Add a new station → (P. 38)

Basic operations using the front panel

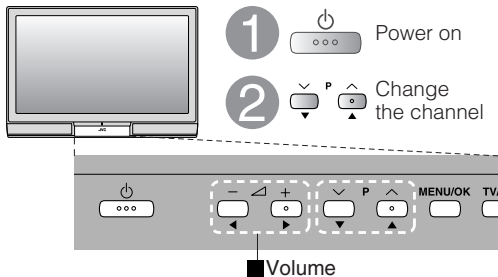

1 Power on

2 Change the channel

Volume

Channel information and clock

INFORMATION

View subtitles

SUBTITLE
(DTV)

Change the aspect ratio

ZOOM

Enjoy ambient sound

3D SOUND

Take snapshots of the screen

FREEZE

■ When DTV is selected

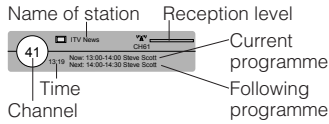

■ When ATV is selected

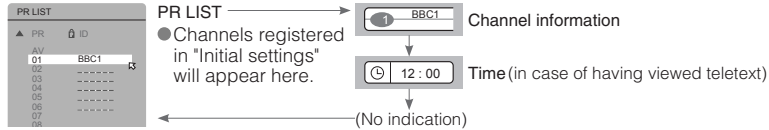

- Select a page →
- Select and view a channel →

SUB TITLE

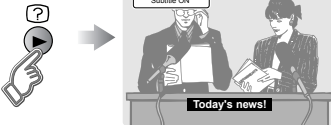

- Shown only when subtitles exist
- To avoid subtitle recording, turn the subtitles off before recording.

■ Turn off subtitles



ZOOM

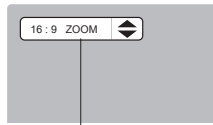
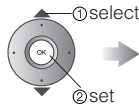

Move the picture with ▲ or ▼ while this bar is displayed

- When set to AUTO, the aspect ratio will turn to the ratio obtained from the information the TV received. Without receiving aspect information, it will be the setting in "4:3 AUTO ASPECT" (P. 40).
- Not available in PC mode or 1080i (1125i)/720p (750p) signals.

3D

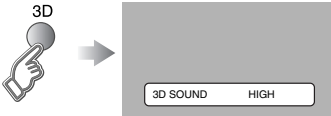

- HIGH : For stereo sound
- LOW : For stereo sound (when the sound distorts in HIGH mode)
- MONO : For mono sound (emulates a stereo-like sound)
- OFF : Turns off 3D SOUND

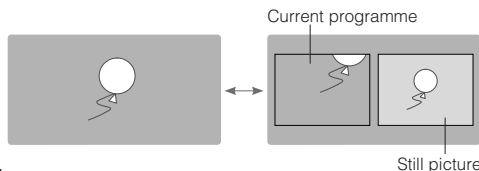

- Not available when the SUB-PICTURE is displayed, or when in PC mode/EXT-6 input.
- You cannot save or export the snapshot.

■ Cancel

→ Press again, or change the channel

Using EPG (Electronic Programme Guide)

You can find a programme from an eight-day programme guide, check its information, and make a reservation.

1 Select DTV
TV/DTV

2 Display EPG
GUIDE

3 Find a programme
select, next, OK

Close EPG →

EPG
Electronic Programme Guide 05:27 20/10/2004
GENRE All
20/10 2. BBC TWO 04:00- History: Britain 1750-1900
21/10 7. BBC THREE 06:00- Big Cook Little Cook
22/10 30. CBBC Channel 06:20- Tots TV
23/10 40. BBC NEWS 24 06:30- Bobinogs
24/10 51. BBCI 06:45- Wide Eye
25/10 89. BBC R Scotland 07:00- Snailsbury Tales
26/10 90. BBC R n Gaidheal 07:15- Arthur
27/10 800. 16:9monoscope 07:30- I Love Mummy
04:00-6:00 History: Britain 1750-1900
Secondary Schools. How industrialisation changed the day-to-day lives of the British people.

Select a date → Select a channel → Select a programme

● You can check programme content.

■ Search from a genre

① While EPG is displayed...
Display the Genre List (green)

② Select a genre

③ Find a programme

Electronic Programme Guide 05:27 20/10/2004
GENRE All
Genre
All
News
Sports
Movies
Drama
Entertainment
Lifestyle
Kids
Education
04:00-6:00 History: Britain 1750-1900
Secondary Schools. How industrialisation changed the day-to-day lives of the British people.

Electronic Programme Guide 05:43 20/10/2004
GENRE Movies
20/10 1. BBC ONE 10:15- Last Embrace
21/10 2. BBC TWO
22/10 7. BBC THREE
23/10 40. CBBC Channel
24/10 40. BBC NEWS 24
25/10 51. BBCI
26/10 89. BBC R Scotland
27/10 90. BBC R n Gaidheal
03:25-6:00 BBC News 24
BBC ONE joins the BBC's rolling news channel for a night of news, with bulletins on the hour and the headlines every 15 minutes.

● Only programmes in the selected genre are displayed.

Reservations

Reserve a programme to watch

Programme-view setting

After ③



No.	Name	Start	End	Date	Mode
2010	2 BBC TWO	06:00	06:00	20/10/2004	Inactive
2010	17 BBC TWO	06:20	06:20	20/10/2004	Inactive
2410	20 CBBC Channel	06:30	06:30	20/10/2004	Inactive
2410	24 CBBC NEWS 24	06:45	06:45	20/10/2004	Inactive
2410	21 BBC1	07:00	07:00	20/10/2004	Inactive
2410	85 BBC R Scotland	07:00	07:00	20/10/2004	Inactive
2410	90 BBC R Goodhall	07:30	07:30	20/10/2004	Inactive
2410	80 BBC 1B Newsnight	07:55	07:55	20/10/2004	Inactive
2410	80 BBC 1B Newsnight	07:55	07:55	20/10/2004	Inactive
2410	80 BBC 1B Newsnight	07:55	07:55	20/10/2004	Inactive

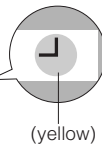

- At the start time, the channel will automatically change.
- If the TV's power is off at the start time, nothing happens.

■ Cancel the reservation → Select the reserved programme and press "OK"

After ③

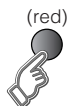

(red)

No.	Name	Start	End	Date	Mode
1	BBC ONE	00:00	00:00	01/01/2004	Inactive
2	BBC ONE	00:00	00:00	01/01/2004	Inactive
3	BBC ONE	00:00	00:00	01/01/2004	Inactive
4	BBC ONE	00:00	00:00	01/01/2004	Inactive
5	BBC ONE	00:00	00:00	01/01/2004	Inactive
6	BBC ONE	Name	BBC TWO		
7	BBC ONE	Start	06:30		
8	BBC ONE	End	06:30		
9	BBC ONE	Date	20/10/2004		
10	BBC ONE	Mode	Choice		

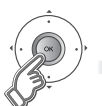

No.	Name	Start	End	Date	Mode
1	BBC TWO	06:30	06:45	20/10/2004	Active
2	BBC ONE	00:00	00:00	01/01/2004	Inactive
3	BBC ONE	00:00	00:00	01/01/2004	Inactive
4	BBC ONE	00:00	00:00	01/01/2004	Inactive
5	BBC ONE	00:00	00:00	01/01/2004	Inactive
6	BBC ONE	00:00	00:00	01/01/2004	Inactive
7	BBC ONE	00:00	00:00	01/01/2004	Inactive
8	BBC ONE	00:00	00:00	01/01/2004	Inactive
9	BBC ONE	00:00	00:00	01/01/2004	Inactive
10	BBC ONE	00:00	00:00	01/01/2004	Inactive

● Prepare for recording

- Set the recording device to external input mode before the start time.
- For T-V LINK incompatible devices, manually set the timer on the device. For details, refer to the manual of the recorder.
- Make sure that recording times on the recording device do not overlap with recording times on the TV.
- When Rec Timer has been set, the power lamp on the TV will :
 - Start blinking 3 minutes before the start time (green or red)
 - Light during recording (green or orange)
- Some T-V LINK compatible DVD recorders may not work correctly.

■ Exit → Press "MENU"

■ Confirm the reservation

GUIDE



No.	Name	Start	End	Date	Mode
2010	2 BBC TWO	06:00	06:00	20/10/2004	Inactive
2110	19 BBC TWO	06:20	06:20	20/10/2004	Inactive
2210	20 CBBC Channel	06:30	06:30	20/10/2004	Inactive
2310	40 BBC NEWS 24	06:45	06:45	20/10/2004	Inactive
2410	21 BBC1	07:00	07:00	20/10/2004	Inactive
2510	85 BBC R Scotland	07:00	07:00	20/10/2004	Inactive
2610	90 BBC R Goodhall	07:30	07:30	20/10/2004	Inactive
2710	80 BBC 1B Newsnight	07:55	07:55	20/10/2004	Inactive
2810	80 BBC 1B Newsnight	07:55	07:55	20/10/2004	Inactive
2910	80 BBC 1B Newsnight	07:55	07:55	20/10/2004	Inactive

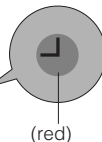

- At the start time, the channel will automatically change and the device connected to EXT-2 will begin recording the programme.

■ Change a reservation

→ "MENU" → "DVB" → "Rec Timer"



① select a reservation

② next

No.	Name	Start	End	Date	Mode
1	BBC ONE	06:30	06:45	20/10/2004	Inactive
2	BBC ONE	00:00	00:00	01/01/2004	Inactive
3	BBC ONE	00:00	00:00	01/01/2004	Inactive
4	BBC ONE	00:00	00:00	01/01/2004	Inactive
5	BBC ONE	00:00	00:00	01/01/2004	Inactive
6	BBC ONE	00:00	00:00	01/01/2004	Inactive
7	BBC ONE	Name	BBC TWO		
8	BBC ONE	Start	06:30		
9	BBC ONE	End	06:45		
10	BBC ONE	Date	20/10/2004		
		Mode	Choice		

Change with ◀▶

Enter using the numerical keypad

Change with ◀▶ (Once/Daily/Weekly)

■ Cancel a reservation

→ "MENU" → "DVB" → "Rec Timer"



① select a reservation

② set the mode to "Inactive"

No.	Name	Start	End	Date	Mode
1	BBC ONE	06:30	06:45	20/10/2004	Inactive
2	BBC ONE	00:00	00:00	01/01/2004	Inactive
3	BBC ONE	00:00	00:00	01/01/2004	Inactive
4	BBC ONE	00:00	00:00	01/01/2004	Inactive
5	BBC ONE	00:00	00:00	01/01/2004	Inactive
6	BBC ONE	00:00	00:00	01/01/2004	Inactive
7	BBC ONE	00:00	00:00	01/01/2004	Inactive
8	BBC ONE	00:00	00:00	01/01/2004	Inactive
9	BBC ONE	00:00	00:00	01/01/2004	Inactive
10	BBC ONE	00:00	00:00	01/01/2004	Inactive

Reserve a programme to record

Programme-record setting

IMPORTANT!

PREPARE

USE

SETTINGS

TROUBLE?

Viewing teletext

This TV can display TV broadcasts and teletext on the same channel in two windows.

1 Select ATV/DTV
TV/DTV

2 Select TV/TEXT

■ When DTV is selected
 ▶ Operate according to the screen indications

■ When ATV is selected
 ▶ Enter a teletext page

① ② ③
 ④ ⑤ ⑥
 ⑦ ⑧ ⑨
 ⑩

● Move up or down a page
 up
 P down

● View sub-pages
 to sub-page

01 02 01 02

■ When ATV is selected
 When watching TV

TV TEXT

TEXT

TEXT ---
 TEXT ---

Bookmark your favourite page

LIST MODE
(ATV)

1 F.T/L Display your favourites list

(RED) (GREEN) (YELLOW) (BLUE)

???

2 Select a coloured button to save your page to

(red) (green) (yellow) (blue)

● ● ● ●

3 Enter the number of the page to save

① ② ③
 ④ ⑤ ⑥
 ⑦ ⑧ ⑨
 ⑩

???

4 Save

■ Recall your favourite page ▶ Press the coloured button as in step 2

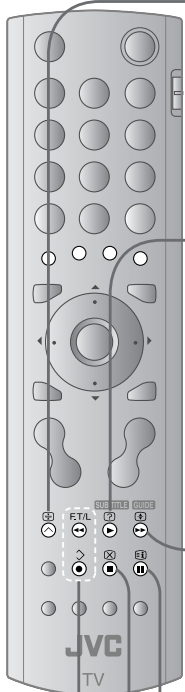

Hold the current page

HOLD
(ATV)

Hold the current page

Release → Press again

Reveal hidden pages

REVEAL
(ATV)

Display hidden information (answers to quizzes, etc)

$$\begin{array}{r} 1 + 2 = \\ 2 \times 3 = \end{array} \longleftrightarrow \begin{array}{r} 1 + 2 = 3 \\ 2 \times 3 = 6 \end{array}$$

Enlarge the text

SIZE
(ATV)

Double the size of the displayed text

To the index page

INDEX
(ATV)

Returns to page "100" or a previously designated page

Switch briefly from teletext to TV

CANCEL
(ATV)

Leave the current page open, while you switch to watch TV

Useful when running a page search.

Watching videos/DVDs

1

Select the video source

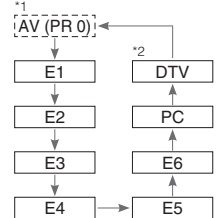

*1 : Only appears when AV has been registered as a channel.
*2 : Switches to DTV.

2

Operate the connected device and play a video

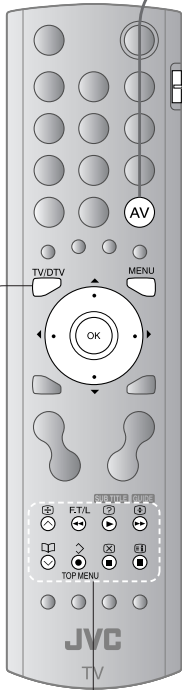

Operate the VCR (DVD)

■ To TV

Operate JVC VCRs and other devices

1



DVD players

VCRs and DVD recorders

2



Turn on the device

3

Select a channel (VCR mode)

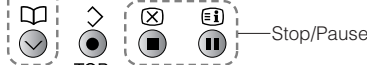
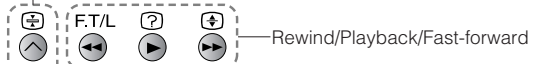

Select a chapter (DVD mode)

● Some models of JVC devices cannot be operated with this remote control.

Advanced functions

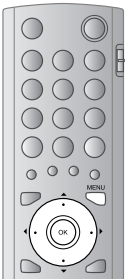

1 MENU Display the menu bar

2 Select "SET UP"

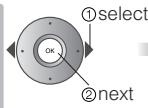
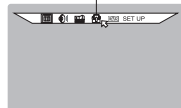

Select "EXT SETTING"

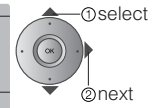
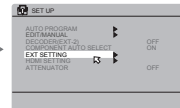

Switch to S-VIDEO input

S-IN

① Select the EXT connected to S-VIDEO

② Set S-VIDEO input

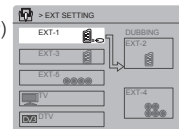
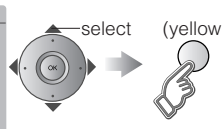
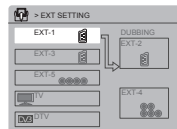

● The device selection display will change from E1 to S1.

■ Cancel this mode → Press in again

Edit names of connected devices

ID LIST

① Select an EXT to assign a name to

② Show the name list

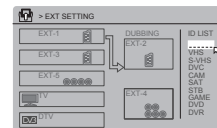
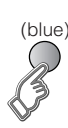
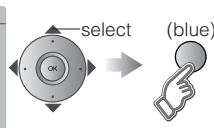
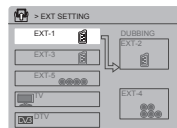

③ Select a name from the list

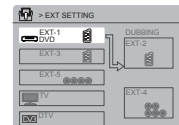
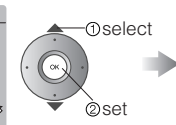
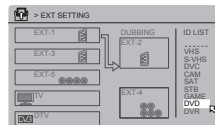

■ Clear the name → Select the blank space in

Set up dubbing on EXT-2

DUBBING

① Select the arrow

② Select the dubbing source

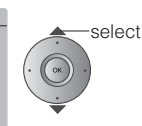
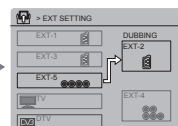
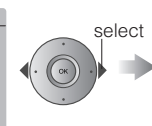
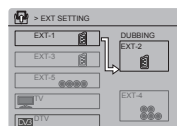

IMPORTANT!

PREPARE

USE

SETTINGS

TROUBLE?

Useful functions

Watch in multi-picture mode

MULTI-PICTURE

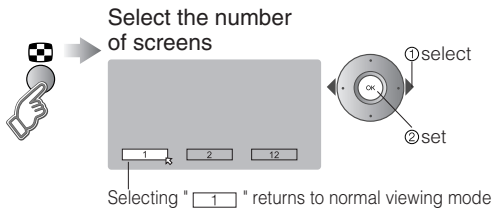

- Not available in PC mode/EXT-6 input.

Watch in dual-picture mode

E.g. You can watch TV and video at the same time.

(For 1080i, 720p signal)



- Switch between the sound sources
→
- Change the channel
→ (Main)
→ (Sub)

Select a channel in 12-screen mode (ATV)

All registered channels are displayed as still images.

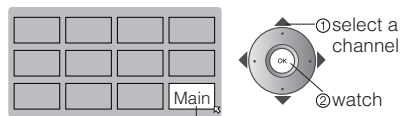

Only the selected frame has a moving picture.

- Move up or down a page →
- Not available when watching DTV channels.

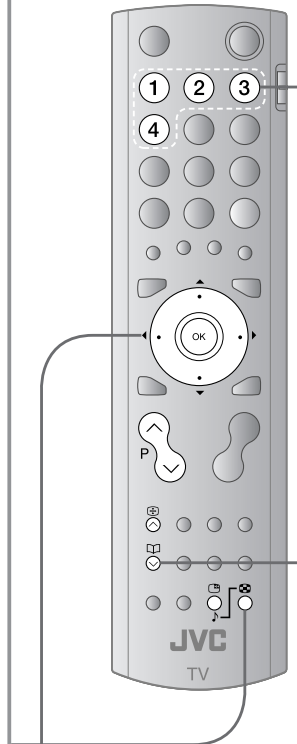

Register a channel to a button

FAVOURITE CHANNEL
(ATV)

While the channel is displayed

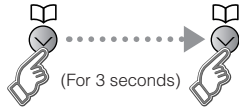

Press the number to register it on

① ② ③ ④



● "NOT AVAILABLE" is displayed:
Already registered

Disappears after a few seconds

■ Recall the favourite channel



Press the number you registered

① ② ③ ④



● Customisations (P. 32) to the picture of a favourite channel get saved as well.
● "NOT MEMORY" is displayed:
Not registered

■ Check your favourite channels → Press and confirm that the channels you have registered have a beside them

■ Delete a favourite channel

⇒ "MENU" ⇒ ⇒ "FEATURES" ⇒ "FAVOURITE SETTING"

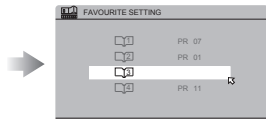
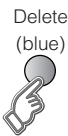
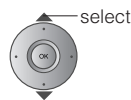
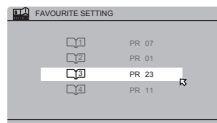

Useful functions

Set a time for the TV to turn itself off

SLEEP TIMER

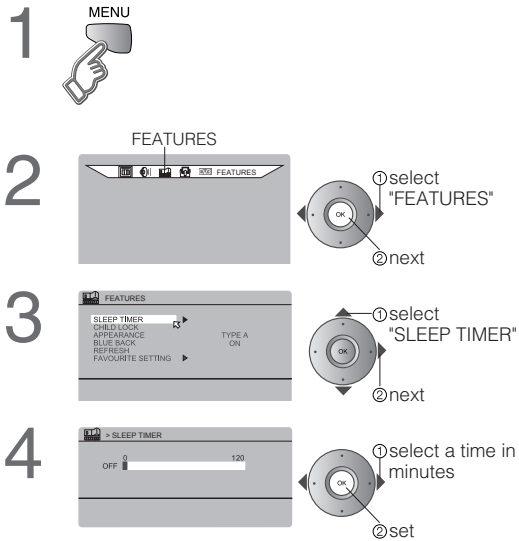

■ Cancel

➔ Set the time to "0" in step 4











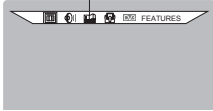

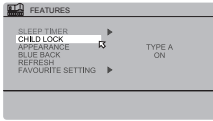

■ Remaining time

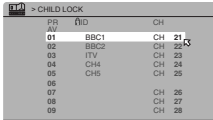

➔ You can confirm the remaining time at step 4, after repeating this process.

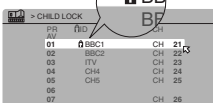

Stop children from watching specific channels

CHILD LOCK (ATV)

- 1  MENU
- 2  FEATURES
 ① select "FEATURES"
 ② next
- 3  FEATURES
 select "CHILD LOCK"

- 4  >> SET ID NO.
 ① enter an "ID NO." (a secret number of your choice)
 ② to the next column
 ③ set
- 5  CHILD LOCK
 select a channel to lock
- 6  (blue)  CHILD LOCK
 Lock more channels
 Repeat steps 5 and 6
- 7 

- Release a channel → Press  again in step 6
- View a locked channel → Display the channel. When  appears, press  and enter your "ID NO."
(If you forget your "ID NO.", check it in step 4.)

Customising your TV



1 Display the menu bar



2 Select a menu

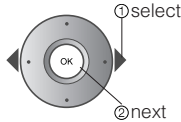

3 Select an item

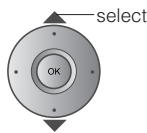

4 Adjust/Configure

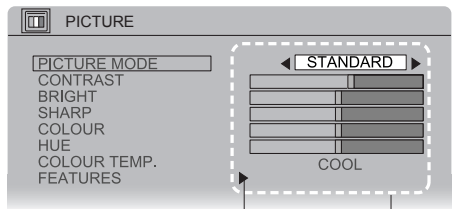
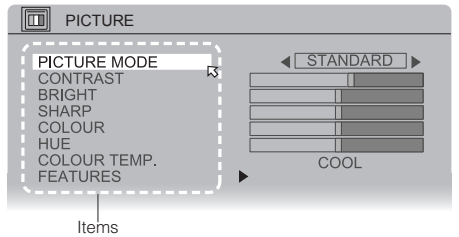
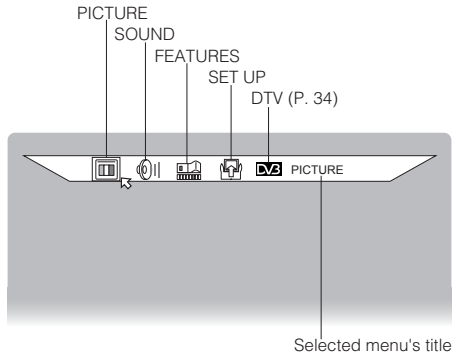
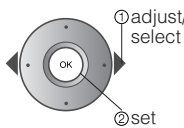

■ To the previous screen



■ Exit



● The menu disappears after one minute of inactivity.



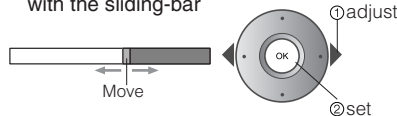

■ When adjusting with the sliding-bar

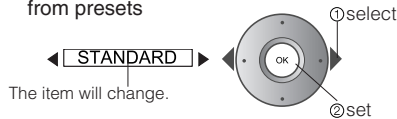

■ When selecting from presets



● Some items have a sub-menu.

Menu	Item	Adjustments/Configurations
 PICTURE	PICTURE MODE	Picture mode (BRIGHT/STANDARD/SOFT)
	CONTRAST	Contrast (LOWER ↔ HIGHER)
	BRIGHT	Brightness (DARKER ↔ BRIGHTER)
	SHARP	Sharpness (SOFTER ↔ SHARPER)
	COLOUR	Colour (LIGHTER ↔ DEEPER)
	HUE	Tint (REDDISH ↔ GREENISH)
	COLOUR TEMP.	Colour temperature (COOL/NORMAL/WARM)
	FEATURES	Finer picture adjustments (P. 40)
 SOUND	STEREO/ I · II	Mode/Language (∞ : STEREO/O : MONO/I : SUB1/II : SUB2)
	BASS	Low tones (WEAKER ↔ STRONGER)
	TREBLE	High tones (WEAKER ↔ STRONGER)
	BALANCE	Speaker balance (LEFT STRONGER ↔ RIGHT STRONGER)
	3D SOUND	Ambience level (HIGH/LOW/MONO/OFF)
	A.H.B.	Emphasizes the bass sound (ON/OFF)
	BBE*	Sound enhancement technology (ON/OFF)
	SPEAKER	Output (TV SOUND/Sound from CENTRE CH input)
 FEATURES	SLEEP TIMER	Timer for turning off the TV (P. 30)
	CHILD LOCK	Stops children from watching specific channels (P. 31)
	APPEARANCE	Format for displaying the channel number (TYPE A/TYP E B/TYP E C/TYP E D)
	BLUE BACK	Displays a blue screen and mutes the sound when the signal is weak or absent (ON/OFF)
	REFRESH	Softens mild burn-in and residual images (takes about 1 hour)
	FAVOURITE SETTING	Clear favourite channel settings (P. 29)
 SET UP	AUTO PROGRAM	Select a country, it automatically registers channels (P. 13, 4)
	EDIT/MANUAL	Change registered channels or add new ones (P. 16)
	DECODER(EXT-2)	For when connected to VCR with T-V LINK (ON/OFF)
	COMPONENT AUTO SELECT	Changes the TV input to EXT-4 when the component signals are input to EXT-4. (ON/OFF) (Not available when viewing DTV or PC)
	EXT SETTING	For use with video players and other devices (P. 27)
	PICTURE SHIFT	Moves the displayed picture at regular intervals to prevent burn-in (OFF/SLOW-20min/FAST-10min)
	HDMI SETTING	SIZE (AUTO/1/2) AUDIO (AUTO/ANALOGUE/DIGITAL)
	ATTENUATOR	For when the picture is not displayed because of too strong radio waves (ON/OFF)

● Other settings · Change the aspect ratio ➔ "ZOOM" (P. 20)
· Turn on 3D SOUND ➔ "3D SOUND" (P. 20)

* BBE licence ➔ (P. 46)

IMPORTANT!

PREPARE

USE

SETTINGS

TROUBLE?







Using DTV

Timer-record setting

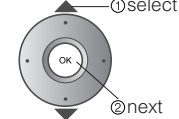
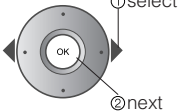
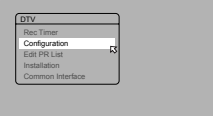
DTV original function and setting, such as a recorder-linked timer-record setting, can be selected from the DTV menu.



- 1** Select DTV
TV/DTV
- 2** Display the menu bar
MENU
- 3** Select "DTV"
- 4** Select an item



■ To the previous screen



■ Exit



- The menu disappears after one minute of inactivity.

- DTV menu cannot be operated with the front panel buttons.

- Rec Timer ➔ "Recording using timer setting" (P. 34)
- Configuration ➔ "Change AV settings" (P. 36)
- Edit PR List ➔ "Editing DTV channels" (P. 14)
- Installation ➔ "Reset channel/Register a new channel/Initialise the DTV settings" (P. 38)
- Common Interface ➔ "Set pay-per-view" (P. 38)

Recording using timer setting

Rec Timer

1 Select an "Inactive" column

REC TIMER						06:02	20/10/2004
No.	Name	Start	End	Date	Mode		
1	BBC ONE	00:00	00:00	01/01/2000	Inactive		
2	BBC ONE	00:00	00:00	01/01/2000	Inactive		
3	BBC ONE	00:00	00:00	01/01/2000	Inactive		
4	BBC ONE	00:00	00:00	01/01/2000	Inactive		
5	BBC ONE	00:00	00:00	01/01/2000	Inactive		

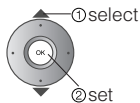

● Settings can be overwritten.

Channels Start to End Dates Timer-record setting state (Active : timer set
Inactive : completed, cancelled)

2 Input timer-record setting details

REC TIMER						06:02	20/10/2004
No.	Name	Start	End	Date	Mode		
1	BBC ONE	00:00	00:00	01/01/2004	Inactive		
2	BBC ONE	00:00	00:00	01/01/2004	Inactive		
3	BBC ONE	00:00	00:00	01/01/2004	Inactive		
4	BBC ONE	00:00	00:00	01/01/2004	Inactive		
5	BBC ONE	00:00	00:00	01/01/2004	Inactive		
6	BBC ONE	00:00	00:00	01/01/2004	Inactive		
7	BBC ONE					BBC TWO	
8	BBC ONE					06:30	
9	BBC ONE					06:45	
10	BBC ONE					20/10/2004	
						Once	

Change with ◀▶

Enter using the numerical keypad

Change with ◀▶
(Once/Daily/Weekly)

3 Set



REC TIMER						06:02	20/10/2004
No.	Name	Start	End	Date	Mode		
1	BBC TWO	06:30	06:45	20/10/2004	Active		
2	BBC ONE	00:00	00:00	01/01/2000	Inactive		
3	BBC ONE	00:00	00:00	01/01/2000	Inactive		
4	BBC ONE	00:00	00:00	01/01/2000	Inactive		
5	BBC ONE	00:00	00:00	01/01/2000	Inactive		
6	BBC ONE	00:00	00:00	01/01/2004	Inactive		
7	BBC ONE	00:00	00:00	01/01/2004	Inactive		
8	BBC ONE	00:00	00:00	01/01/2004	Inactive		
9	BBC ONE	00:00	00:00	01/01/2004	Inactive		
10	BBC ONE	00:00	00:00	01/01/2004	Inactive		

- A message will be displayed if you set past dates.
- The channel will be selected automatically at the set start time, and the recorder connected to EXT-2 will start recording.

- For more details about the timer-record setting, refer to the notice of "Prepare for recording" (P. 23)

■ Cancel a timer-record setting

- ▶ Select the column at step 1 and press ▶. (Mode will be changed to "Inactive")

■ Change a timer-record setting

- ▶ Select the column at step 1 and repeat steps 2 and 3.

Using DTV

AV setting

Available for changing subtitle languages for DTV, favourite channel selection, changing PIN code, and upgrading the tuner software. Also, you can upgrade the tuner software as newer versions become available.

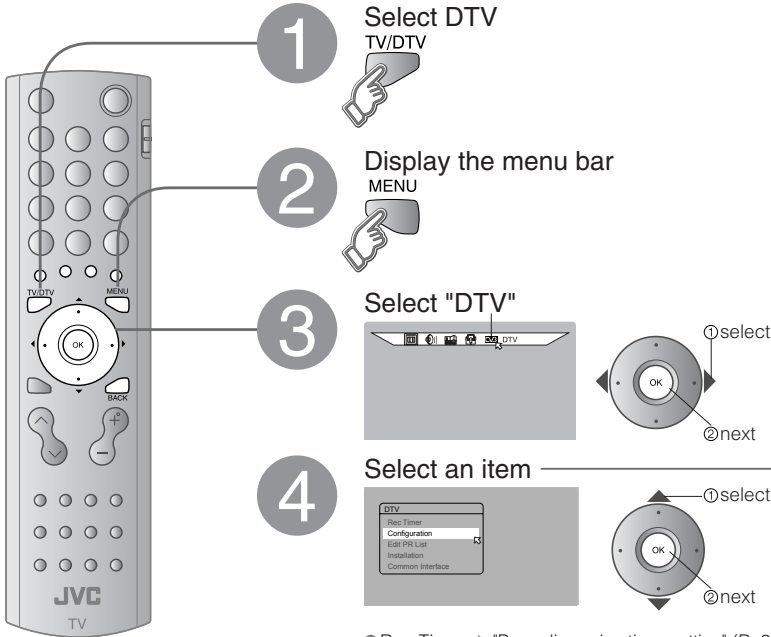

■ To the previous screen



■ Exit



- The menu disappears after one minute of inactivity.

- DTV menu cannot be operated with the front panel buttons.

- Rec Timer ➔ "Recording using timer setting" (P. 34)
- Configuration ➔ "Change AV settings" (P. 36)
- Edit PR List ➔ "Editing DTV channels" (P. 14)
- Installation ➔ "Reset channel/Register a new channel/Initialise the DTV settings" (P. 38)
- Common Interface ➔ "Set pay-per-view" (P. 38)

Change AV settings

Configuration

1 Select a configuration item

CONFIGURATION

- Audio Language **English**
- Subtitle English
- Favourite Mode Off
- Receiver Upgrade V.3.3
- Enter PIN code

select

2 Change settings

- **Audio Language** | **Subtitle** : Change language
- **Favourite Mode** : Channel selection method

Audio Language	Switch languages (English/Welsh/Gaelic)
Subtitle	
Favourite Mode	Select only DTV channels registered by using "Favourites"(P. 14) with ^/∨ (On/Off)

select

- **Receiver Upgrade** : Upgrade tuner

Automatic Download	Automatically and periodically (Enabled/Disabled)
Search for New Version	Download now (Press "OK" button.)

- **Enter PIN code** : Change PIN code

① Input the current code

Subtitle	English	1	2	3	<ul style="list-style-type: none"> ● Default is "0000". ● If you forget the code → Default the code in "Reset channel registration" (P. 38)
Favourite Mode	Off	4	5	6	
Enter PIN code		7	8	9	
-----		0			

② Input a new code twice

Subtitle	English	1	2	3
Favourite Mode	Off	4	5	6
Receiver Upgrade	V.3.3	7	8	9
Enter PIN code		0		
PIN code: -----				
Confirm: -----				

PIN code changed.

Using DTV

Registration and setting

Available for registration of DTV channels, initialisation of all DTV settings, and downloading software to use pay-per-view.

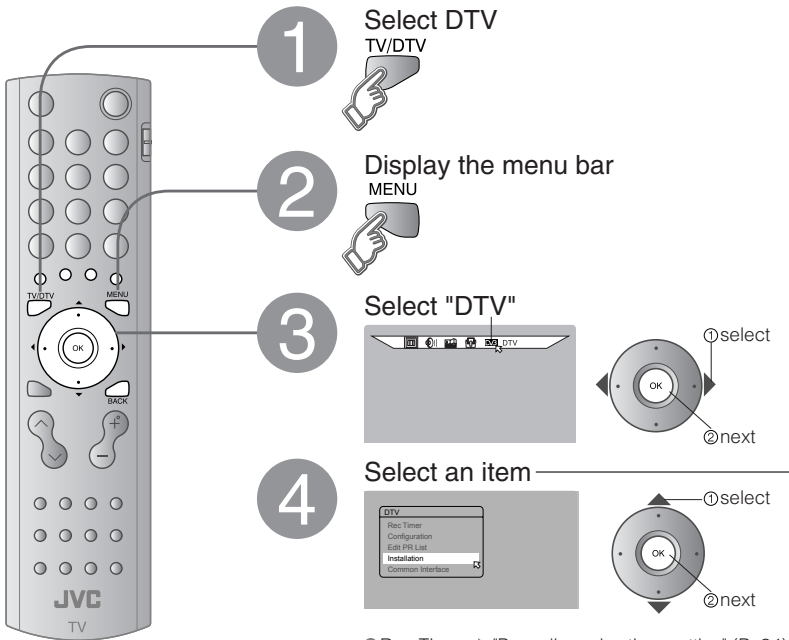

■ To the previous screen



■ Exit



● The menu disappears after one minute of inactivity.

1 Select DTV



2 Display the menu bar



3 Select "DTV"

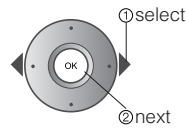

4 Select an item

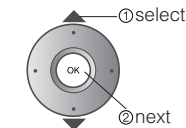
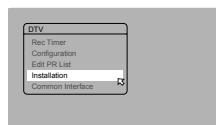

- Rec Timer ➔ "Recording using timer setting" (P. 34)
- Configuration ➔ "Change AV settings" (P. 36)
- Edit PR List ➔ "Editing DTV channels" (P. 14)
- Installation ➔ "Reset channel/Register a new channel/Initialise the DTV settings" (P. 38)
- Common Interface ➔ "Set pay-per-view" (P. 38)

● DTV menu cannot be operated with the front panel buttons.

Reset channel registration

Register a new channel

Initialise the DTV settings

Installation

Set pay-per-view

Common Interface

1 Select an installation item

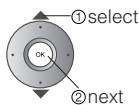
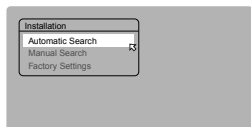

2 Change settings

Automatic Search : Reset channel registration

① Select "Yes"

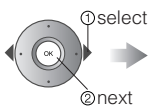
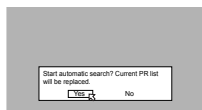

● Displays "Edit PR List" (P. 14) after registering channels.

Manual Search : Register a new channel

① Enter a channel number

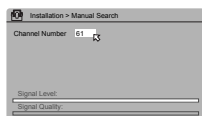

② Receive the channel

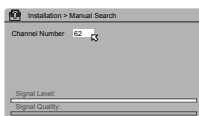

● When receiving is completed, a message will be displayed and the screen will return to ①.

Factory Setting : Initialise the DTV settings

① Select "Yes"

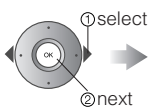
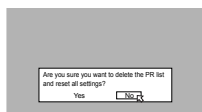

② Start channel registration



→ ③ in "Initial settings" (P. 12)

Preparation : Set the CAM etc. after contracting with the broadcasting company

➔ "Watch pay-per-view" (P. 8)

① Select the broadcasting station

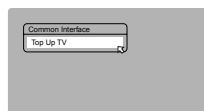

② Select "Software Download"

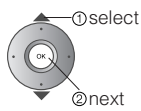
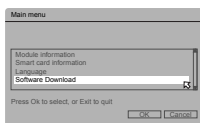

③ Select "Yes"

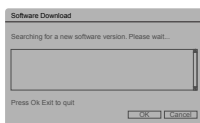
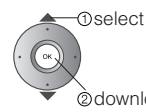
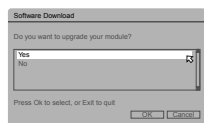

● Use this menu for settings and contract content for pay-per-view.

➔ For details, consult your broadcasting company

Advanced picture adjustment

By default, the TV automatically adjusts itself for the best picture.



1 Display the menu bar

2 Select "PICTURE"

3 Select "FEATURES"

4 Select an item

E.g. DIGITAL VNR

5 Change settings

E.g. DIGITAL VNR

6 Finish

■ To the previous screen



■ Exit



● The menu disappears after one minute of inactivity.

DIGITAL VNR

Super DigiPure

MOVIE THEATRE

COLOUR MANAGEMENT

PICTURE MANAGEMENT

COLOUR SYSTEM

4:3 AUTO ASPECT

To reduce noise

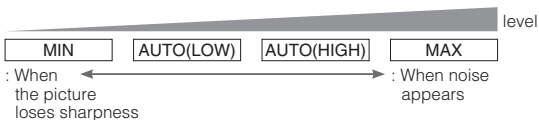
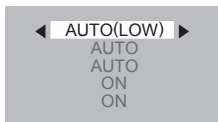

For natural-looking outlines

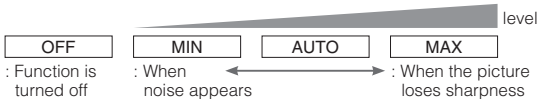
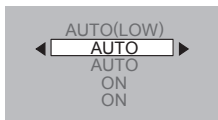

For smooth cinema film

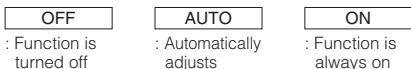
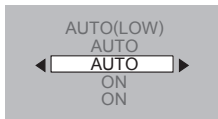

For natural-looking pictures

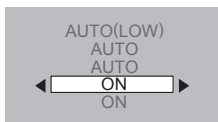

Fix bright/dark pictures

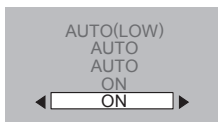

When there is no colour

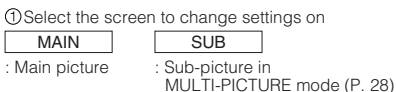
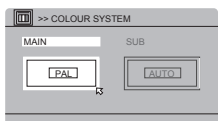

Set a default aspect ratio

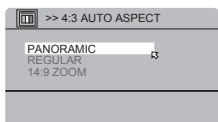

Select a default aspect ratio for "AUTO" in "ZOOM" (P. 20)

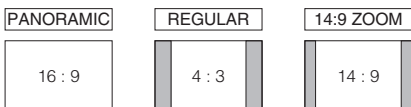

Troubleshooting

Severe noise or snow



- Is the TV connected correctly to the aerial?
- Change the direction of the aerial.
- Is the aerial or its cable damaged?
 - ➔ Consult your retailer

Patterns, stripes or noise



- Is the aerial receiving interference from high-voltage power lines or wireless transmitters?
 - ➔ Consult your retailer
- Are connected devices too close to the TV?
 - ➔ Insert the minimum distance between the aerial and the cause of interference until no interference

Ghosting

(Doubling of images)

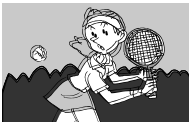

- Are you receiving interference from signals reflected off mountains or buildings?
 - ➔ Adjust the direction of your aerial, or change to a good-quality directional aerial

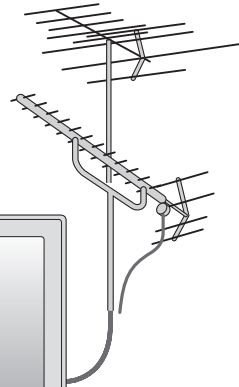
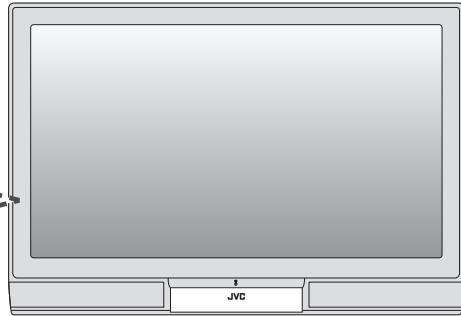

I can't turn it on!

- Is the power cord connected to the AC outlet correctly?

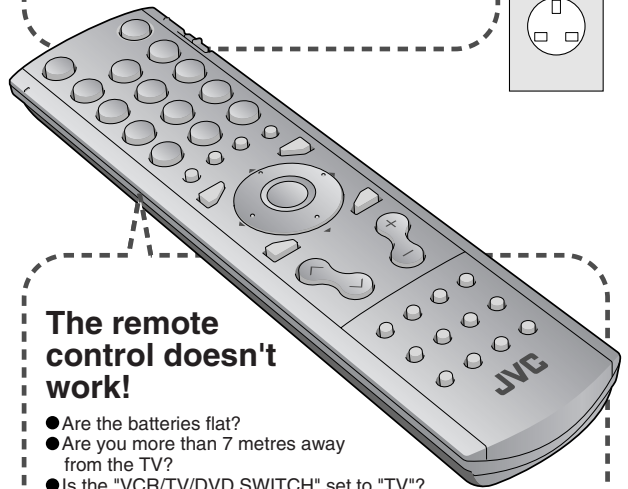
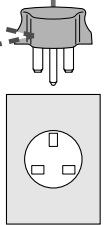

The remote control doesn't work!

- Are the batteries flat?
- Are you more than 7 metres away from the TV?
- Is the "VCR/TV/DVD SWITCH" set to "TV"?
- When viewing teletext, the TV menu bar does not appear.
- Depending on the stability of the signal, there may be a time lag when changing channels.

Problem		Actions	page
Basics	Not displayed (black screen)	<ul style="list-style-type: none"> ● Is the ATV reception poor, too? <ul style="list-style-type: none"> ➔ Following the instructions in "Severe noise or snow" can solve this problem. ● Is there a DTV transmission tower nearby? <ul style="list-style-type: none"> ➔ Turn "ATTENUATOR" to "ON", since the radio waves are too strong. ● There may be problems at the antenna, radio waves, or the area you live in, where reception is bad. Consult your retailer. 	42 33 —
	Remote control stops working	<ul style="list-style-type: none"> ● Unplug TV, several minutes later plug it in again. 	—
	DTV screen is frozen	<ul style="list-style-type: none"> ● Hold down TV/AV and MENU/OK on the TV simultaneously to restart. 	—
	Some functions do not work	<ul style="list-style-type: none"> ● It is not a malfunction. Some functions (dark background) in the menu do not work depending on the situation. 	—
Screen	Aspect ratio changes unintentionally	<ul style="list-style-type: none"> ● Press ZOOM to return to your settings. 	20
Picture	Poor picture quality	<ul style="list-style-type: none"> ● Unnatural colour >>> Adjust COLOUR and BRIGHT. Check your COLOUR SYSTEM. ● Noise >>> Set to the following functions. PICTURE MODE : STANDARD 33 DIGITAL VNR : AUTO (HIGH) 40 Super DigiPure : MIN 40 ● Dull picture >>> Set to the following functions. PICTURE MODE : STANDARD 33 DIGITAL VNR : MIN 40 Super DigiPure : MAX 40 	33 40 33 40 33 40 40
	Strange picture when using an external device	<ul style="list-style-type: none"> ● If you connected S-Video output device, check the "S-IN" setting. ● If the top of the image is distorted, check the video signal quality itself. ● If movement appears unnatural when receiving a signal from a DVD player, etc. with 625p (progressive-scanning), change the output setting of the external device to 625i (interlace-scanning). 	27 — —
Sound	Poor sound	<ul style="list-style-type: none"> ● Adjust the BASS and TREBLE. ● If receiving a poor signal in "STEREO/ I · II", switch to MONO. 	33 33

Troubleshooting (continued)

	Problem	Actions	page
HDMI	Wrong screen size	● Switch SIZE in HDMI SETTING to "1" or "2".	33
	No sound	● Switch AUDIO in HDMI SETTING to ANALOGUE or DIGITAL.	33
	Green and distorted screen	● Wait a little for the signal to stabilize when switching the signal format for an HDMI device.	—
Functions	Some inputs are skipped in the sub-picture	● DTV channels, EXT-4/EXT-6 inputs, and PC mode cannot be selected in the sub-picture.	28
Error message	"FEATURE NOT AVAILABLE"	<ul style="list-style-type: none"> ● Is the T-V LINK compatible device connected to EXT-2? ● Is the SCART CABLE "Fully Wired"? ● Is the T-V LINK compatible device turned on? After confirming all the conditions above, press "OK" button again.	46 46 —
	"ACI ERROR"	<ul style="list-style-type: none"> ● Press ◀ to start ACI again. If you still receive the "ACI ERROR" after numerous tries, press ▶ to cancel ACI.	—
	"NO RECORDING"	● A problem occurs at the recorder.	—
	"NO RECORDING POSSIBLE"	● The displayed video cannot be recorded.	—
	"NO RECORDING MEDIA PROBLEM"	● The recorder is not ready for recording. Check the videotape or DVD disc.	—
	"NO RECORDING DEVICE BUSY"	● The recorder is recording another programme, or is playing.	—
Screen	Black or white dots appear on the screen	<ul style="list-style-type: none"> ● Plasma panels use fine dots ("pixels") to display images. While more than 99.99% of these pixels function properly, a very small number of pixels may not light, or may light all the time. Please understand that this is not a malfunction.	—

	Problem	Actions	page
DTV Other	An error message does not disappear	<ul style="list-style-type: none"> Deleting a DTV channel may cause an error message to appear while other channels displayed. <ul style="list-style-type: none"> Register channels again in "Automatic Search" 	39
	Remote controls for other devices stop working	<ul style="list-style-type: none"> Remote controls are occasionally disrupted by interference from the plasma display panel. Increase the distance between you and the TV and try again. 	—
	Cordless headphones stop working, or noise can be heard	<ul style="list-style-type: none"> Occasionally infra-red type cordless headphones stop working, or noise can be heard due to interference from the plasma display panel. Move the transmitter away from the TV and try again. 	—

CH/CC List

- To use the INSERT function (P. 16), find the CH/CC number corresponding to the TV's channel number from this table. If you want to know a particular TV channel's channel menu, look in TV listings magazines or contact the broadcaster.
- When the COUNTRY setting is UNITED KINGDOM, the CC number channels and channels from CH02 to CH12 cannot be received.

CH	Channel
CH 02	E2, IR A
CH 03	E3, IR B
CH 04	E4, IR C
CH 05	E5, IR D
CH 06	E6, IR E
CH 07	E7, IR F
CH 08	E8, IR G
CH 09	E9
CH 10	E10, IR H
CH 11	E11, IR J
CH 12	E12
CH 21	E21
CH 22	E22
CH 23	E23
CH 24	E24
CH 25	E25
CH 26	E26
CH 27	E27
CH 28	E28
CH 29	E29
CH 30	E30
CH 31	E31
CH 32	E32
CH 33	E33
CH 34	E34
CH 35	E35
CH 36	E36
CH 37	E37
CH 38	E38
CH 39	E39

CH	Channel
CH 40	E40
CH 41	E41
CH 42	E42
CH 43	E43
CH 44	E44
CH 45	E45
CH 46	E46
CH 47	E47
CH 48	E48
CH 49	E49
CH 50	E50
CH 51	E51
CH 52	E52
CH 53	E53
CH 54	E54
CH 55	E55
CH 56	E56
CH 57	E57
CH 58	E58
CH 59	E59
CH 60	E60
CH 61	E61
CH 62	E62
CH 63	E63
CH 64	E64
CH 65	E65
CH 66	E66
CH 67	E67
CH 68	E68
CH 69	E69

CC	Channel
CC 01	S1
CC 02	S2
CC 03	S3
CC 04	S4
CC 05	S5
CC 06	S6
CC 07	S7
CC 08	S8
CC 09	S9
CC 10	S10
CC 11	S11
CC 12	S12
CC 13	S13
CC 14	S14
CC 15	S15
CC 16	S16
CC 17	S17
CC 18	S18
CC 19	S19
CC 20	S20
CC 21	S21
CC 22	S22
CC 23	S23
CC 24	S24
CC 25	S25
CC 26	S26
CC 27	S27
CC 28	S28
CC 29	S29
CC 30	S30

CC	Channel
CC 31	S31
CC 32	S32
CC 33	S33
CC 34	S34
CC 35	S35
CC 36	S36
CC 37	S37
CC 38	S36
CC 39	S39
CC 40	S40
CC 41	S41
CC 75	X
CC 76	Y
CC 77	Z
CC 78	Z+1
CC 79	Z+2

Technical information

What is T-V LINK?

T-V LINK allows the TV to share information easily with a connected T-V LINK compatible device. By using T-V LINK :

- You can send the ATV channel information programmed on the TV to the T-V LINK compatible device, so that both the TV and the external device have the same channel settings. When connecting a new external device, channel information is loaded into it, allowing channel setup to be completed very quickly. For more details, refer to the external device's manual.
- You can easily record the TV programme you are viewing on a T-V LINK compatible device by using the "DIRECT REC" feature. For more details, refer to the external device's manual.
- After timer-record setting, the TV will instruct the recorder to start and stop recording, via DIRECT REC.

What is ACI (Automatic Channel Installation)?

Some cable companies transmit a signal called ACI which contains information that allows TV channels to be registered automatically on your TV.

When an ACI signal is received, "ACI START/ACI CANCEL" appears in the "AUTO PROGRAM" screen.

PC Signals that can be displayed

Macintosh computers are not supported.
(Macintosh is a registered trademark of Apple Computer, Inc.)

- If the signal doesn't appear, check that the vertical frequency on the PC is set to 60Hz.

Resolution	640 x 480 (VGA)	1024 x 768 (XGA)
Vertical frequency (Hz)	60.0	60.0
Horizontal frequency (kHz)	31.5	42.0

Connect DVI devices

Connect a DVI device to EXT-6 (HDMI) using DVI-HDMI conversion cable. Connect analogue sound output of the DVI device to L and R terminals in EXT-4.

- Set AUDIO in HDMI SETTING to ANALOGUE or AUTO → (P. 33)

If you accidentally cut the power cord

Attach a new plug following the steps below. If in doubt, contact your retailer.

Important

- The wires in the mains lead on this product are coloured with the following code:
 - Blue: Neutral wire (connect to the black terminal, or one marked "N")
 - Brown: Live wire (connect to the red terminal, or one marked "L")
 - Green-and-yellow: Safety earth wire (connect to the larger terminal marked with an "E", the safety earth symbol "⏚" or coloured green or green-and-yellow)

Change the fuse in the plug

Open the plug as illustrated on the right.

- When replacing the fuse, always use a correctly rated and approved type and re-fit the fuse cover when finished.

If in doubt, contact your retailer.

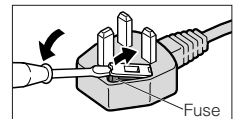

Licence

Manufactured under license from BBE Sound, Inc.

Licensed by BBE Sound, Inc. under USP4638258, 5510752 and 5736897.

BBE and BBE symbol are registered trademarks of BBE Sound, Inc.

Specifications

Main unit

PD-42DX6BJ	
COUNTRY setting	UNITED KINGDOM
Broadcasting systems	CCIR I
Colour systems	PAL ·The EXT terminals also support the NTSC 3.58/4.43 MHz system.
Channels and frequencies	Analogue : E21-E69, Digital : 474 MHz-850 MHz (channel 21-68)
Sound-multiplex systems	NICAM (I) system.
Teletext systems	Analogue : FLOF (Fastext), WST (World Standard System). Digital : MHEG 5 UK profile
Power requirements	AC 110 V - 240 V, 50/60 Hz
Power consumption	339 W (standby : 3.0 W)
Screen size	106 cm (visible area size measured diagonally)
Audio output (Rated power output)	10 W + 10 W
Speakers	6.6 cm round x 4
Dimensions (W x H x D)	1045 mm x 795.7 mm x 313 mm/1045 mm x 728.4 mm x 110 mm (without stand)
Weights	45 kg/38.5 kg (without stand)
Accessories	(See "Check accessories", P. 6)

- This TV has the CAM (Conditional Access Module) slot for watching pay-per-view. Please note that the CAM and viewing card must be purchased separately.

Terminals/Connectors

Terminal name		Terminal type	Signal type (IN)	Signal type (OUT)
Input/Output terminals	EXT-1	Euroconnector x 1 (SCART connector)	Composite video, S-video, Analogue RGB, AUDIO L/R	TV out
	EXT-2	Euroconnector x 1 (SCART connector)	Composite video, S-video, Analogue RGB, AUDIO L/R	Dubbing out
Input terminals	EXT-3	Euroconnector x 1 (SCART connector)	Composite video, AUDIO L/R	
	EXT-4	RCA connector x 5	Analogue component (standard/Progressive : 576p (625p), 480p (525p), 720p/60 Hz (750p/60 Hz)/ HD : 1080i (1125i)), AUDIO L/R	
	EXT-5	RCA connector x 3, S-VIDEO connector x 1	Composite video, S-video, AUDIO L/R	
	EXT-6 (HDMI)	HDMI connector x 1	Digital video, Digital audio (480p (525p), 480i (525i), 720p/60Hz (750p/60Hz), 1080i (1125i), 576p (625p), 576i (625i))	
	PC INPUT	D-SUB (15 pins) x 1	Analogue PC signal (P. 46)	
	CENTRE CH IN	RCA connector x 1	Audio centre channel	
Output terminals	AUDIO OUT	RCA connector x 3		Audio L/R, Subwoofer
	Headphone	Stereo mini-jack x 1 (3.5 mm in diameter)		Headphone output

- We may change the design and specifications without notice.

IMPORTANT!

PREPARE

USE

SETTINGS

TROUBLE?

JVC

For users in the UK :

If you have any problems setting up your new TV, please call the **JVC** Helpline on **0870 330 5000**.

For users in the Republic of Ireland :

If you have any problems setting up your new TV, please call the **JVC** Helpline on **1890-582500**.