

JVC

INSTRUCTIONS

WIDE LCD PANEL TV

LT-42DR9BJ



HD
ready
1080p

HDMI™
HIGH-DEFINITION MULTIMEDIA INTERFACE

MAXX
BASIS

DynaPix **HD**

DVB®

Digital Video
Broadcasting

Trade Mark of the DVB Digital Video Broadcasting
Project (1991 to 1996) Number : 5227

A separate manual “WATCHING DIGITAL CHANNELS” is provided.

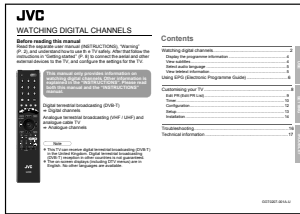

Please refer to the separate manual when watching digital channels.

Before reading the separate manual Read this manual's “Warning” section (P. 2), and understand how to use the TV safely. After that follow the instructions in the “Getting started” section (P. 8 - 17) to connect the aerial and other external devices to the TV, and configure the settings for the TV.

Information for Users on Disposal of Old Equipment

ENGLISH

[European Union]

This symbol indicates that the electrical and electronic equipment should not be disposed as general household waste at its end-of-life. Instead, the product should be handed over to the applicable collection point for the recycling of electrical and electronic equipment for proper treatment, recovery and recycling in accordance with your national legislation.



By disposing of this product correctly, you will help to conserve natural resources and will help prevent potential negative effects on the environment and human health which could otherwise be caused by inappropriate waste handling of this product. For more information about collection point and recycling of this product, please contact your local municipal office, your household waste disposal service or the shop where you purchased the product.

Penalties may be applicable for incorrect disposal of this waste, in accordance with national legislation.

Attention:

This symbol is only valid in the European Union.

(Business users)

If you wish to dispose of this product, please visit our web page www.jvc-europe.com to obtain information about the take-back of the product.

[Other Countries outside the European Union]

If you wish to dispose of this product, please do so in accordance with applicable national legislation or other rules in your country for the treatment of old electrical and electronic equipment.

Dear Customer,

This apparatus is in conformance with the valid European directives and standards regarding electromagnetic compatibility and electrical safety.

European representative of Victor Company of Japan, Limited is:

JVC Technology Centre Europe GmbH

Company name changed in:

JVC Technical Services Europe GmbH

Postfach 10 05 52

61145 Friedberg

Germany

IMPORTANT

PREPARE

USE

SETTING

TROUBLE?

Warning

Please follow all the guidelines below

Follow this manual regarding setup!

- Connect only to a 220 - 240 V, 50 Hz AC outlet.

Make enough room for inserting and removing the power plug! Place the TV as close to the outlet as possible!

- Even if the TV's power lamp is unlit, the main power supply is not cut off unless the power cord is unplugged. The main power supply for this TV is controlled by inserting or removing the power plug.

Never cut or damage the power cord!

- If the power plug is not the right shape, or the power cord is not long enough, use an appropriate plug adapter or extension cable. (Consult your retailer.)
- If you have cut or damaged the power cord.
 - ➔ "Technical information" (P. 34)
- To change the fuse in power plug
 - ➔ "Technical information" (P. 34)

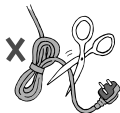

Do not allow the TV to fall!

- Do not rest your elbows on, or allow children to hang from the TV. There is a risk that the TV will fall and cause injuries.

Never try to repair the TV yourself!

- ➔ If the problem cannot be solved in "Troubleshooting" (P. 32), unplug the power cord and contact your retailer.

On disposal of the TV!

- Follow the instruction in "Information for Users on Disposal of Old Equipment" (P. 1).



Never place anything on the TV!

- Placing liquids, naked flames, cloths, paper, etc. on the TV may cause a fire.



Never expose to rain or moisture!

- To prevent fire or electric shock, never allow liquids to enter the unit.



Never insert objects into the cabinet openings!

- It may cause a fatal electric shock. Take care when children are near.



Never obstruct the ventilation holes!

- It may cause overheating or a fire.

Never listen to headphones at high volume!

- It may damage your hearing.

Hold the TV so as not to scratch the screen!

- Do not touch the screen when carrying the TV.

Do not carry the TV on your own!

- In order to prevent accidents, ensure that the TV is carried by two or more people.



Unplug the power cord when going out!

- The power buttons on the remote control and the TV unit cannot completely turn off the TV. (Make appropriate arrangements for bedridden people.)

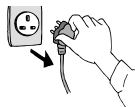

When attaching the TV to the wall, use the optional JVC wall mounting unit!

- Consult a qualified technician.
- See the included manual on mounting procedures.
- JVC assumes no responsibility for mounting due to improper mounting.

Take care when handling the glossy finish!

- For more details, see P. 7.

Handle LCD panel with care!

- Use a soft, dry cloth when cleaning.

Never dismantle the rear panel!

- It may cause an electric shock.

■ For more details on installation, usage and safety ➔ Consult your retailer

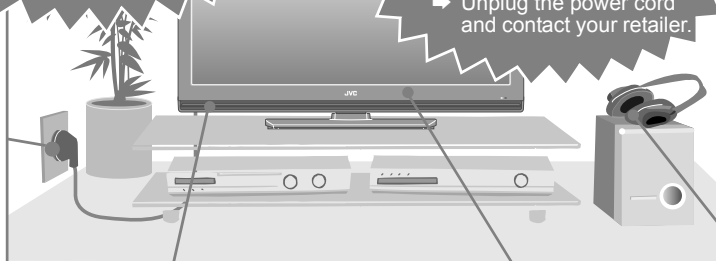

To set up your TV

Please read “Getting started” (P. 8 - 17).
The main descriptions are in the following pages.

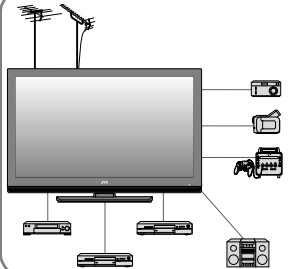

Connecting the external devices and aerial **PAGE 9** **PAGE 12**

Choosing a video connection **PAGE 10**

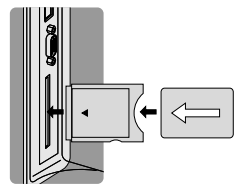

Watch pay-TV digital channels **PAGE 8**



Initial settings **PAGE 13**

Editing analogue channels **PAGE 15**

- If you want to edit the digital channels, refer to “Edit PR (Edit PR List)” (P. 9) on the separate manual “WATCHING DIGITAL CHANNELS”.

Contents

Analogue terrestrial broadcasting (VHF / UHF) and analogue cable TV
 ⇒ Analogue channels
 Digital terrestrial broadcasting (DVB-T) ⇒ Digital channels

First things first!	● Warning..... 2
Getting started	● Remote control..... 4 ● Names and functions of parts 6 ● Getting started 8 ● “CH/CC” list..... 17
Let’s try it out	● Enjoy your new TV!..... 18 ● Watching analogue channels 19 ● Viewing teletext on the analogue channel..... 20 ● Watching videos / DVDs 21 ● Useful functions 22
Try the advanced features	● Watching videos / DVDs 21 ● Useful functions 22
Just the way you like it	● Configuring your remote control..... 24 ● Customising your TV..... 26 Picture 26 Features (sub menu)..... 27 Sound..... 28 Features 29 Set Up 30
When you have trouble	● Troubleshooting 32 ● Technical information 34 ● Specifications 35

WATCHING DIGITAL CHANNELS (Separate manual)	
● Watching digital channels 2	● Troubleshooting..... 16
● Using EPG 6	● Technical Information 17
● Customising your TV..... 8	

IMPORTANT
PREPARE
USE
SETTING
TROUBLE?

Remote control

The functions of the remote control buttons are explained as follows.

This remote control can be configured to operate up to four different devices simply by changing the remote code.

“Configuring your remote control” (P. 24)



Mute.



Turn on / off (standby) the TV.

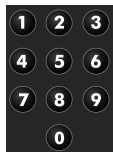

Enter channel number.

Enter teletext page number on the analogue channel.



Channel information. “Watching analogue channels” (P. 19)



Watch video etc. “Watching videos / DVDs” (P. 21)



Colour buttons:

Select a page when viewing teletext on the analogue channel.

Operate functions in menus.



Switch between “TV / STB / DVD / AUDIO”. (P. 24)



Switch between digital / analogue channels.



Display on-screen menu. “Customising your TV” (P. 26)



Select and confirm settings in menus.



Select channel.



Select teletext page on the analogue channel.



Volume control.



View teletext on the analogue channel.

“Viewing teletext on the analogue channel” (P. 20)

View teletext information on the digital channel. (Refer to page 5 on the separate manual “WATCHING DIGITAL CHANNELS”.)



To the previous menu.



Hold the current page when viewing teletext on the analogue channel. (P. 21)



Display your favourite list when viewing teletext on the analogue channel. (P. 20)





Display hidden information when viewing teletext on the analogue channel. (P. 21)

Switch between TV / Radio when watching digital channels.



Enlarge the text when viewing teletext on the analogue channel. (P. 21)

Display the Electronic Programme Guide when watching digital channels.



Choose a favourite channel when viewing analogue channels. (P. 19)

Display sub-pages when viewing teletext on the analogue channel. (P. 20)



Save your favourite page when viewing teletext on the analogue channel. (P. 20)



Switch briefly from teletext to TV when viewing teletext on the analogue channel. (P. 21)



Display the index page when viewing teletext on the analogue channel. (P. 21)

View subtitles when watching digital channels.



Change the aspect ratio. (P. 22)



Turn on "3D Cinema Sound". (P. 22)



Change the sound mode or language. (P. 23)

Change the audio language when viewing digital channels.



Set the sleep timer. (P. 23)

Note

- For buttons that can be used to operate other devices, refer to "Configuring your remote control" (P. 24).
- For more details on using the remote control when viewing digital channels, refer to the separate manual "WATCHING DIGITAL CHANNELS".

Names and functions of parts

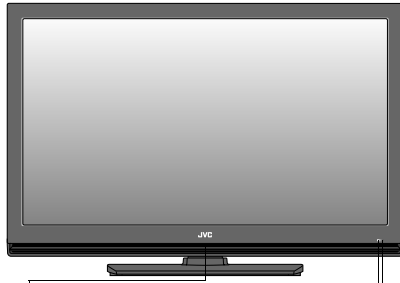

Remote control sensor

Eco Sensor

➔ "What is "Eco Sensor"?"
(P. 34)

Power lamp

ON: Lit

OFF: Unlit

- When "Power Lamp" is set to "Off", the Power lamp will not light up.
➔ "Power Lamp" (P. 29)
- The power lamp will blink before the "Record" timer starts to function.
When the "Record" timer is in progress, the power lamp lights even though the TV is off (standby). For details, refer to "Timer" (P. 11) on the separate manual "WATCHING DIGITAL CHANNELS".

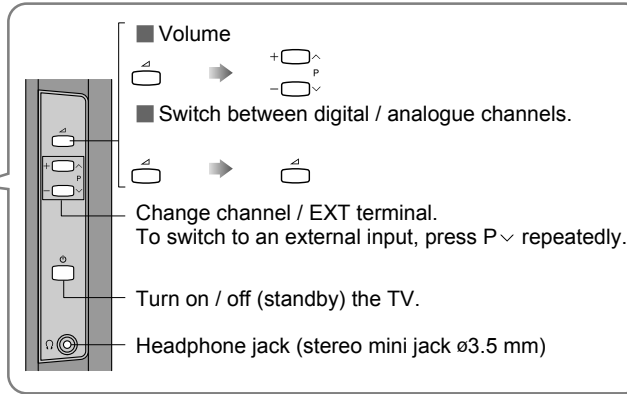

Note

- Peel off the protection films pasted on the glossy finish of the TV after the TV has been placed properly. (P. 7)

Change the direction of TV

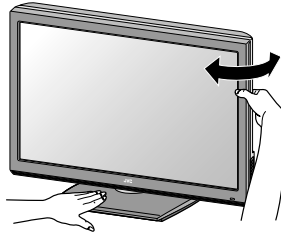

Handling the glossy finish of the TV

Be careful when handling the glossy finish of the TV

The glossy finish of the TV scratches easily.

- Protection films have been pasted onto the glossy finish of the TV to prevent scratches. Peel off the films after the TV has been placed properly.
- If the glossy finish gets dirty, clear the dust off the glossy finish first. Then wipe softly with the cleaning cloth provided. If you do not clear the dust first, or you wipe the glossy finish too hard, or a cleaning cloth other than the one provided is used, the glossy finish may be scratched.

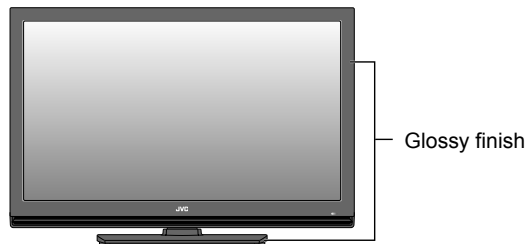

Getting started

Please read P. 9 - 17 of this manual to set up your TV.

Check accessories



User Manual
"INSTRUCTIONS"
(this book)



Cleaning cloth
(For details on using the
cleaning cloth, see P. 7.)



Separate Manual
"WATCHING DIGITAL
CHANNELS"



"AAA/R03" Batteries
(For confirming the TV
works)



Remote control
RM-C1931

Install your TV

- Power requirements
 - Connect the power cord only to a 220 - 240 V, 50 Hz AC outlet.
- When attaching the TV to the wall, use the optional JVC wall mounting unit
 - Consult a qualified technician.
 - See the included manual on mounting procedures.
 - JVC assumes no responsibility for damage due to improper mounting.
 - Mounting holes for wall mounting unit:
M5 x 4, 400 mm x 200 mm
Depth of screw hole is 13 mm from the surface of the TV.
- Installation requirements
 - To avoid overheating, ensure the unit has ample room.

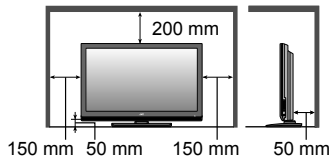

Insert the batteries

Use two "AAA/R03" dry cell batteries. Insert the batteries from the ⊖ end, making sure the ⊕ and ⊖ polarities are correct.

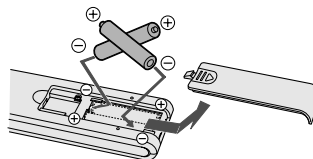

WARNING:

Batteries shall not be exposed to excessive heat such as direct sunshine, fire or the like.

Watch pay-TV digital channels

Subscribe to a broadcasting company beforehand. A Viewing Card (B) will be sent by the broadcasting company after subscribing to it. It may be necessary for you to purchase a CAM (Conditional Access Module) (A) in addition to the Viewing Card. Consult your broadcasting company or retailer.

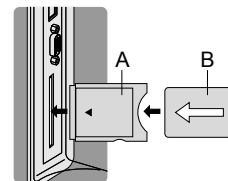

- ① Unplug the power cord
- ② Insert "B" into "A".
- ③ Insert "A".
- ④ Plug the power cord, and turn the power on.
- ⑤ Perform necessary settings using "Common Interface".
 - ➔ **WATCHING DIGITAL CHANNELS**
"Common Interface" (P. 13)
 - Pay-TV analogue channels cannot be watched.

Connecting your external devices

Make sure all the devices and the TV are turned off.

The names of the devices shown in the following illustration are examples. The alphabets A, B, C, D, E, F and G indicate the type of connections. Refer to P. 10 - 11 to find the best connections that are possible with your devices.

Note



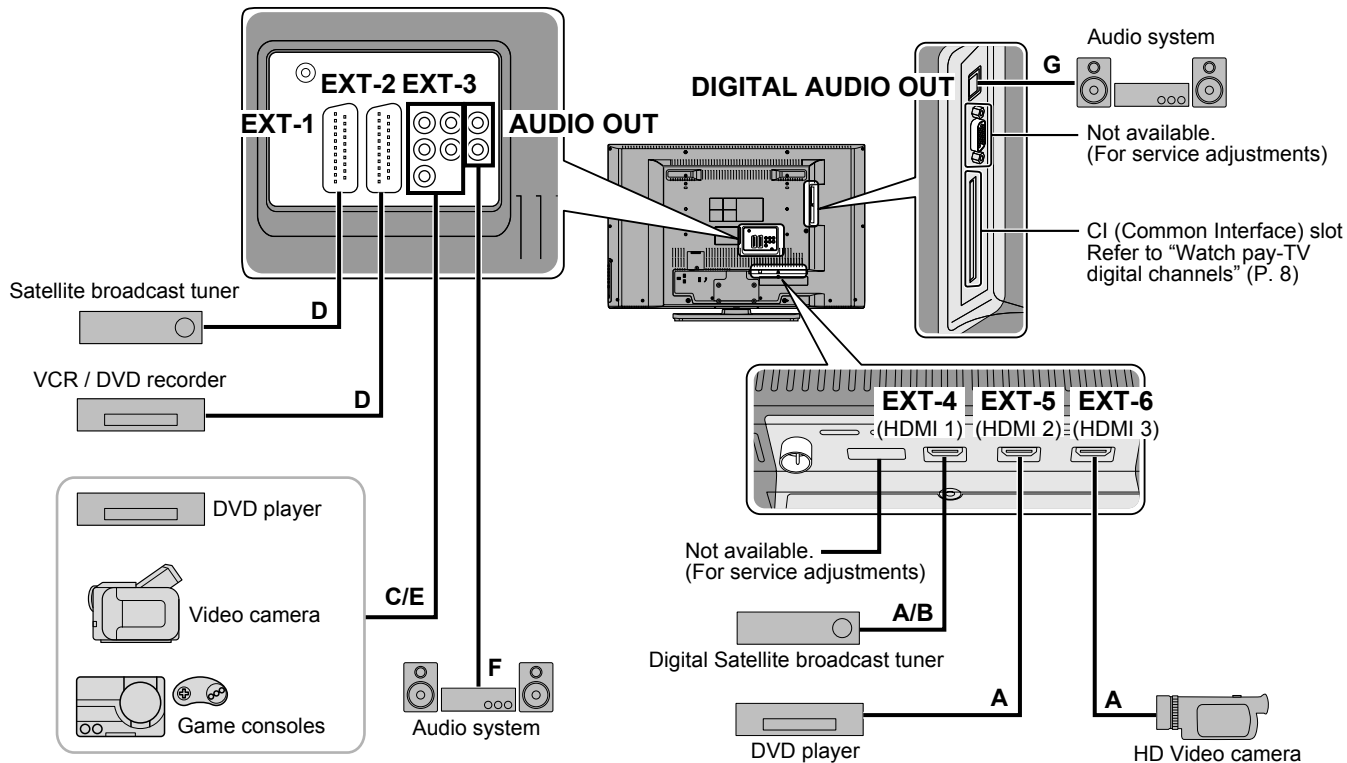









- Please read the user manuals of each device before setting up.
- Connecting cables are not supplied with this TV.



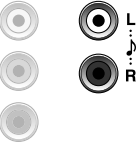

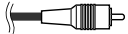

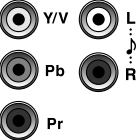

Choose your best connection

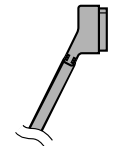

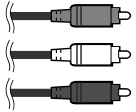
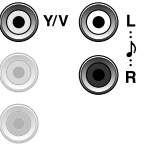

You can connect your TV to other devices in seven different ways. Check your devices and choose the best connection. In addition, please read "Notes" before using.

Please do not change any of the menu settings before completing the "Initial settings" (P. 13). Otherwise, the "Initial settings" will not start automatically.

Picture quality	Other devices	Connecting cables	Connect to your TV	Available signals	Notes
Best ↑	 HDMI	 HDMI cable	 EXT-4 EXT-5 EXT-6	Input <ul style="list-style-type: none"> HDMI (digital) <ul style="list-style-type: none"> SD: 576i (625i), 480i (525i) ED: 576p (625p), 480p (525p) HD: 1080i (1125i), 1080p (1125p) / 24Hz, 1080p (1125p) / 50Hz, 1080p (1125p) / 60Hz, 720p (750p) Audio L / R 	If there is no sound, change the "HDMI-1 Audio Setting" (P. 30).
	 DVI  Audio	 DVI-HDMI cable, Audio cable	 EXT-4  EXT-3: L and R jacks	Input <ul style="list-style-type: none"> DVI (digital) <ul style="list-style-type: none"> SD: 576i (625i), 480i (525i) ED: 576p (625p), 480p (525p) HD: 1080i (1125i), 1080p (1125p) / 24Hz, 1080p (1125p) / 50Hz, 1080p (1125p) / 60Hz, 720p (750p) Audio L / R (analogue) 	If there is no sound, change the "HDMI-1 Audio Setting" (P. 30).
Better ↑	 Component video and Audio	    Component video cable, Audio cable	 EXT-3	Input <ul style="list-style-type: none"> Component (analogue) <ul style="list-style-type: none"> SD: 576i (625i), 480i (525i) ED: 576p (625p), 480p (525p) HD: 1080i (1125i), 1080p (1125p) / 50Hz, 1080p (1125p) / 60Hz, 720p (750p) Audio L / R (analogue) 	Change the EXT-3 setting from "⊙" (composite) to "⊙⊙" (component). (P. 31)

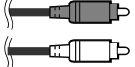
D	 SCART (Euroconnector)	 SCART cable	 EXT-1	Input <ul style="list-style-type: none"> ● Composite video (analogue) ● RGB input (analogue) ● Audio L / R (analogue) Output <ul style="list-style-type: none"> ● Analogue TV out (composite video and audio L/R) (analogue) 	
			 EXT-2	Input <ul style="list-style-type: none"> ● Composite video (analogue) ● S-Video (analogue) ● Audio L / R (analogue) Output <ul style="list-style-type: none"> ● Dubbing out (composite video and audio L/R) (analogue) 	If you want to input the S-Video signal, change the "Ext Setting". (P. 31) Select the dubbing source in "Ext Setting". (P. 31)
E	 Video and audio	 Video and audio cable	 EXT-3: V, L, R jacks	Input <ul style="list-style-type: none"> ● Composite video (analogue) ● Audio L / R (analogue) 	Change the EXT-3 setting from "  (component) to "  (composite). (P. 31)

Good

	Audio system	Connecting cables	Connect to your TV	Available signals	Notes
F	 Audio input	 Audio cable	 AUDIO OUT	Output <ul style="list-style-type: none"> ● Audio L / R (analogue) 	You cannot listen to the sound from a device with connection A and B.
G	 Optical input	 Optical audio cable	 DIGITAL AUDIO OUT	Output <ul style="list-style-type: none"> ● Audio (digital) (16 bit linear PCM or Dolby Digital) 	The sound from the analogue channels and the external devices cannot be output. Please refer to the "“Dolby Digital” output from the DIGITAL AUDIO OUT terminal" (P. 18) on the separate manual "WATCHING DIGITAL CHANNELS".

"Dolby" and the double-D symbol are trademarks of Dolby Laboratories.

IMPORTANT

PREPARE

USE

SETTING

TROUBLE?

Connecting the aerial

Connect the aerial

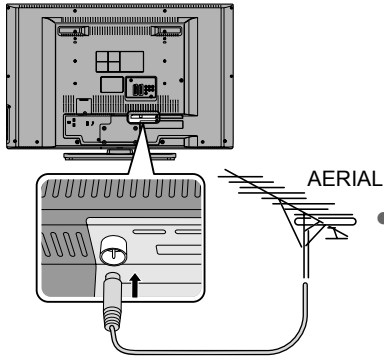

- After all the connections have been made, insert the plug into an AC outlet.

Connect a VCR / DVD recorder

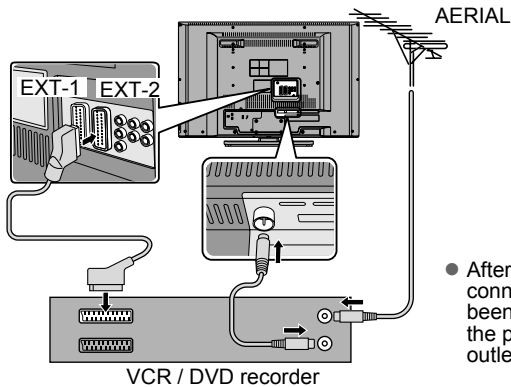

- After all the connections have been made, insert the plug into an AC outlet.

Power supply for the indoor aerial

When using an indoor aerial which requires external power, set "Antenna Power" to "On" in step 3 of "Initial settings" (P. 13). The TV will supply DC 5V, 50mA (max) from the aerial socket through the cable to the aerial.

- Supplying power to outdoor and indoor aerials which does not require external power, may cause damage to the aerial. If you are uncertain whether the aerial needs external power, select "Off".
- Connect the aerial directly to the TV. When a recording device is connected between the aerial and the TV, power cannot be supplied to the aerial.
- Power is supplied to the aerial only when the TV is on.
- You can change the "Antenna Power" setting later. For details, refer to "Antenna Power" (P. 13) on the separate manual "WATCHING DIGITAL CHANNELS".

Initial settings



The initial settings will begin automatically when the TV is turned on for the very first time. Follow the on-screen instructions to perform the settings.

1 Turn on



- If the remote control doesn't work, confirm that the mode is set to "TV".

2 Start initial settings



- If the JVC logo does not appear, refer to "To perform initial settings again" (P. 14).

3 Set digital channels

- 1 Confirm "English" is set for on-screen displays and DTV menus.

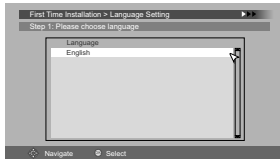

- 2 Confirm "United Kingdom" is set. This TV can only receive British digital channels.



- 3 Confirm that the aerial power supply is set to "Off". Select "On" only when using an aerial which requires external power. (P. 12)

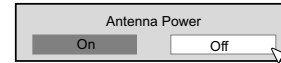

- 4 Register digital channels

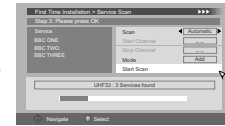
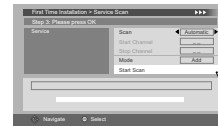

- If "No services found" appears, press the "OK" button to proceed to the next step to complete the other settings. Then, refer to "No digital channels" (P. 14).
- You can edit the digital channels after the initial settings. For details, refer to "Edit PR (Edit PR List)" (P. 9) on the separate manual "WATCHING DIGITAL CHANNELS".
- Some digital channels cannot be watched on this TV. For details, refer to page 17 on the separate manual "WATCHING DIGITAL CHANNELS".

- 4 Confirm the language for menus (excluding the DTV menus)

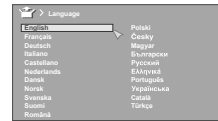

- If you want to change the language, select a language and press the "OK" button.

(Continue on page 14)

5 Set analogue channels

1 Register analogue channels



(blue)

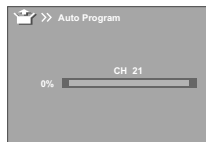

- If you do not want to register the analogue channels (including cable TV channels), press the "MENU" button to complete the settings.
- To change the country setting, select a country and press the blue button.
- If "ACI Start" appears, start ACI. The cable channels will be registered quickly. For details, refer to "What is "ACI" (Automatic Channel Installation)?" (P. 34).

2 Check what was registered

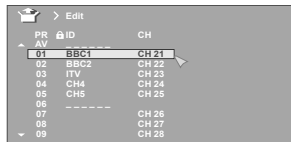

select a channel

- To edit channels

➔ "Editing analogue channels" (P. 15)

6 Finish



- To the previous screen ➔ **BACK**

- Exit ➔ **MENU**

- To perform initial settings again

Take note that performing initial settings again will cause all channel related settings and DTV menu settings to be lost. Press the "MENU" button to display the menu, then press and hold the number button "1" for more than 3 seconds to start initial settings. If initial setting does not start, switch to the analogue channel and try again.

- If you wish to make changes later, refer to "Service Scan" (P. 14) on the separate manual "WATCHING DIGITAL CHANNELS" for digital channel settings, or "Language" (P. 30) and "Auto Program" (P. 30) on this manual for analogue channel settings.

■ No digital channels or "Missing or weak signal" message appears

1

Check the following points

- Is the TV connected correctly to the aerial?
- Change the direction of the indoor aerial.
- Is there a digital channels transmission tower nearby?
 - ➔ Turn "Attenuator" to "On" (P. 30), since the radio waves are too strong.

Note

- "Attenuator" attenuates the radio waves of analogue broadcast as well as those of digital broadcast. If some noise or snow appears when watching an analogue channel, please set "Attenuator" to "Off" temporarily.
- You can check the broadcast signal level of the channel you are watching. For details, refer to "Signal Check" (P. 15) on the separate manual "WATCHING DIGITAL CHANNELS".

2

Set digital channels using "Factory Settings". For details, refer to "Factory Settings" (P. 15) on the separate manual "WATCHING DIGITAL CHANNELS".

If you still cannot watch digital channels after following the steps above, there may be a problem with your aerial or its cable. Or, the signal may be too weak. ➔ Consult your retailer

Editing analogue channels

You can edit the analogue channel list.

1 Switch to analogue channels



2 Display the "Edit" menu

Display the menu bar

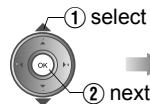

Select "Edit/Manual"

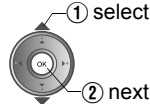

3 Edit channels

PR	ID	CH
01	BBC1	CH 21
02	BBC2	CH 22
03	ITV	CH 23
04	CH4	CH 24
05	CH5	CH 25
06	---	---
07	---	CH 26
08	---	CH 27
09	---	CH 28

■ To the previous menu



■ Exit



Select channel

select a channel



Select edit function



Move

Next

4 Finish



Move Move a channel's position (PR)

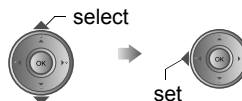

ID Edit a channel name (ID)

■ Naming a channel

① select character

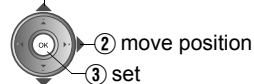

■ When selecting a preset name from the "ID List"



Insert Insert a new channel directly by entering the CH/CC number

Enter a number



Receives the broadcast signal.

■ In United Kingdom, you cannot enter "CC" numbers. In Ireland, you can select "CH" or "CC" before entering a number.

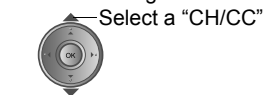

● "CH/CC" list → (P. 17)

Delete Delete a channel

● Pressing the button deletes the channel.

(Continue on page 16)

- To edit digital channels

➔ WATCHING DIGITAL CHANNELS
P. 9

- To register a digital channel manually

➔ WATCHING DIGITAL CHANNELS
“Service Scan” (P. 14)

Manual Register a new channel

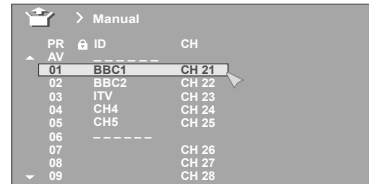

PR	AV	ID	CH
01	BBC1	---	CH 21
02	BBC2	---	CH 22
03	ITV	---	CH 23
04	CH4	---	CH 24
05	CH5	---	CH 25
06	---	---	---
07	---	---	CH 26
08	---	---	CH 27
09	---	---	CH 28

① Search a channel Fine tune

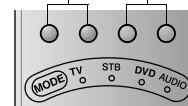

② Set



- Press the red or green button. Auto-search begins, and the nearest frequency is imported.
 - ➔ Repeat the previous steps until the desired channel is displayed.

“CH/CC” list

To use the “Insert” function (P. 15), find the “CH/CC” number corresponding to the TV’s Channel number from this table.

If you want to know a particular TV channel’s menu, look in TV listings magazines or contact the broadcaster.

- When the Country setting is “United Kingdom”, the CC number channels and channels from CH 02 to Ch 12 cannot be received.

CH	Channel	CH	Channel	CC	Channel	CC	Channel
CH 02	E2, IR A	CH 40	E40	CC 01	S1	CC 31	S31
CH 03	E3, IR B	CH 41	E41	CC 02	S2	CC 32	S32
CH 04	E4, IR C	CH 42	E42	CC 03	S3	CC 33	S33
CH 05	E5, IR D	CH 43	E43	CC 04	S4	CC 34	S34
CH 06	E6, IR E	CH 44	E44	CC 05	S5	CC 35	S35
CH 07	E7, IR F	CH 45	E45	CC 06	S6	CC 36	S36
CH 08	E8, IR G	CH 46	E46	CC 07	S7	CC 37	S37
CH 09	E9	CH 47	E47	CC 08	S8	CC 38	S38
CH 10	E10, IR H	CH 48	E48	CC 09	S9	CC 39	S39
CH 11	E11, IR J	CH 49	E49	CC 10	S10	CC 40	S40
CH 12	E12	CH 50	E50	CC 11	S11	CC 41	S41
CH 21	E21	CH 51	E51	CC 12	S12	CC 75	X
CH 22	E22	CH 52	E52	CC 13	S13	CC 76	Y
CH 23	E23	CH 53	E53	CC 14	S14	CC 77	Z
CH 24	E24	CH 54	E54	CC 15	S15	CC 78	Z+1
CH 25	E25	CH 55	E55	CC 16	S16	CC 79	Z+2
CH 26	E26	CH 56	E56	CC 17	S17		
CH 27	E27	CH 57	E57	CC 18	S18		
CH 28	E28	CH 58	E58	CC 19	S19		
CH 29	E29	CH 59	E59	CC 20	S20		
CH 30	E30	CH 60	E60	CC 21	S21		
CH 31	E31	CH 61	E61	CC 22	S22		
CH 32	E32	CH 62	E62	CC 23	S23		
CH 33	E33	CH 63	E63	CC 24	S24		
CH 34	E34	CH 64	E64	CC 25	S25		
CH 35	E35	CH 65	E65	CC 26	S26		
CH 36	E36	CH 66	E66	CC 27	S27		
CH 37	E37	CH 67	E67	CC 28	S28		
CH 38	E38	CH 68	E68	CC 29	S29		
CH 39	E39	CH 69	E69	CC 30	S30		

Enjoy your new TV!

Watching analogue channels

PAGE

19

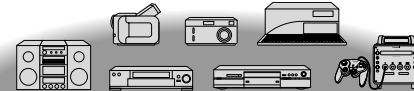
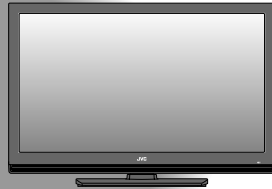

PAGE
21

Watching videos / DVDs



Viewing teletext on the analogue channel

PAGE

20

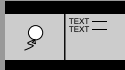

MENU



PAGE

26

Customising your TV

- Picture settings (Picture Mode, Features, etc.)
- Sound settings (Stereo/I-II, 3D Cinema Sound, etc.)
- Features settings (Sleep Timer / Child Lock, etc.)
- Set Up settings (Auto Program, Language, etc.)



Useful functions

PAGE

22

- Change the aspect ratio
- Change the sound mode or language
- 3D Cinema Sound
- Emphasize the bass sound
- Set the sleep timer

Watching digital channels

WATCHING DIGITAL CHANNELS
P. 2 - 5

Customising your TV

- DTV menu settings

WATCHING DIGITAL CHANNELS
P. 8 - 15

Watching analogue channels



1 Turn on

The power lamp on the TV lights.

- If the remote control doesn't work, confirm that the mode is set to "TV".
- Press again to turn the screen off and put the TV into standby mode.
- To completely turn off the TV, unplug the power plug.

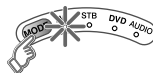

2 Select a channel

■ Using PR list

PR List

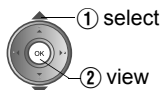
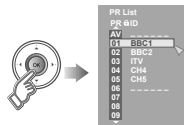

- Close PR List



- Select a page select

■ Press a channel number

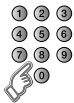

E.g.
1 : 0 → 1
15 : 1 → 5

■ Move up or down a channel



- To the previous channel → **BACK**

Note

- Switch between mono / stereo / bilingual broadcasting → "Stereo/I-II" (P. 23)
- Using the TV buttons → "Names and functions of parts" (P. 6).

■ Switch between digital / analogue channels



Note

- To soften the picture for daily use, change the setting in "Picture Mode" → "Picture Mode" (P. 26)

Channel information and clock

Channel information



Time



- Pressing the button once displays the "PR List".
- Time is displayed only when teletext broadcasting can be received.

Register a channel to a button (Favourite channel)

While the channel is displayed



Press the number to register it on



Note

The following "Picture" and "Sound" menu settings applied to the channel will be stored in the favourite channel as well.

- Picture Mode / Digital VNR / DigiPure (P. 26 - 27)
- Surround / Bass Boost / MaxxBass (P. 28)

■ Recall the favourite channel



■ Check your favourite channels

- Press "i" and confirm that the channels you have registered have a beside them.

- Delete a favourite channel → "Favourite Setting" (P. 29)

Viewing teletext on the analogue channel

This TV can display TV broadcasts and teletext on the same analogue channel in two windows.



1 Switch to analogue channels



3 Enter a teletext page



■ Move up or down a page



Note

- To view teletext information on the digital channel, refer to page 5 on the separate manual "WATCHING DIGITAL CHANNELS".

When watching analogue channel

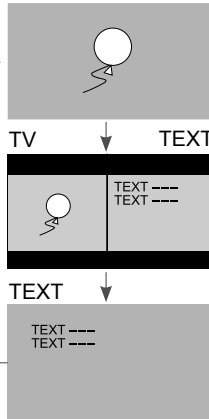

View sub-pages

Display sub-pages

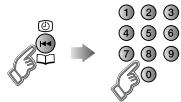

■ Move up or down a page

(red) (green)



down up

■ Release → Press "TV/DTV" again

F.T/L Bookmark your favourite page

1 Display your favourites list

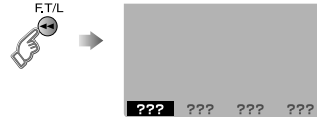

2 Select a coloured button to save your page to

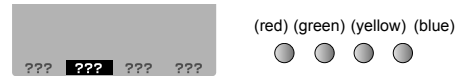

3 Enter the number of the page to save

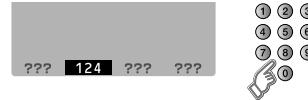

4 Save



■ Exit →



■ Recall your favourite page

1 Display your favourites list



2 Press a coloured button

(red) (green) (yellow) (blue)



Hold the current page

 Hold the current page ■ Release → Press  again

Reveal hidden pages

Display hidden information (answers to quizzes, etc.)

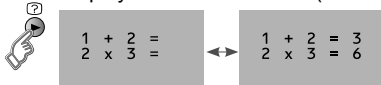

Enlarge the text

Double the size of the displayed text

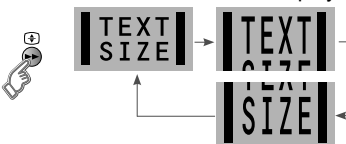

Switch briefly from teletext to TV

Leave the current page open, while you switch to watch TV



- Useful when running a page search.

To the index page

 Returns to page "100" or a previously designated page

Watching videos / DVDs



1 Select the video source

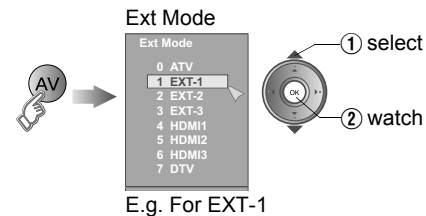

2 Operate the connected device and play a video

■ To return to TV channels

- Press the "TV/DTV" button or select "DTV" from the "Ext Mode" menu for digital channels.
- Select "ATV" from the "Ext Mode" menu for analogue channels.

Useful functions



ZOOM Zoom

Change the aspect ratio



2 Select the aspect ratio

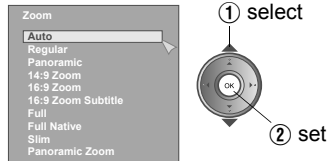

Move the picture with ▲ or ▼ while this bar is displayed

- When “Slim” is selected, a 4:3 image stretched out to 16:9 will revert back to its original aspect ratio with black bands.
- When “Panoramic Zoom” is selected, a 4:3 image with black bands will be stretched out to 16:9.
- “Full Native” ⇒ “What is “Full Native”?” (P. 34)
- Using “Auto” ⇒ “Auto in “Zoom”” (P. 34)

Note

- Depending on the signal formats, some zoom modes will be displayed in black and will not be selectable.
- If an image is displayed in an aspect ratio that differs from its original aspect ratio, the image will be distorted or portions of the image will be cut off.

3D Cinema Sound

Enjoy ambient sound

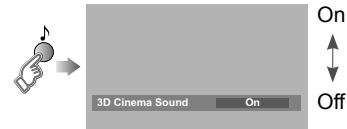

- You can adjust the “3D Cinema Sound” settings in the “3D Cinema Sound” menu. (P. 28)
- “3D Cinema Sound” does not work with headphones.

Other sound functions

MaxxBass (P. 28)

Compensates low frequencies to widen the frequency band.

- “MaxxBass” does not work with headphones.

Hyper Sound (P. 28)

Ambient sound.

- “Hyper Sound” and “3D Cinema Sound” cannot be set to “On” simultaneously.
- “Hyper Sound” does not work with headphones.

Stereo/I-II

Change the sound mode or language (analogue channels)



2 Select the sound mode or language

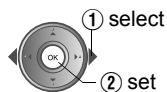
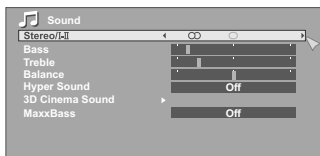

- When viewing a bilingual broadcast programme, you can select either Bilingual I (Sub I) or Bilingual II (Sub II) sound.
- If the stereo broadcast reception is poor, you can change to mono sound for clearer sound.
- This button can also be used when watching digital channels. For details, refer to “Select audio language” (P. 5) on the separate manual “WATCHING DIGITAL CHANNELS”.

Sleep Timer

Set a time for the TV to turn off automatically



2 Set the time

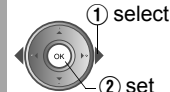
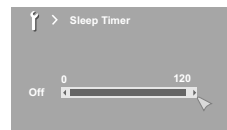

- Cancel ➔ Set the time to “0”.
- Remaining time ➔ Display this menu again.

Other functions

Picture Mode (P. 26)

You can select a preset picture setting according to the brightness of your room or when playing video games.

Eco Sensor (P. 29)

Automatically adjust the picture contrast according to the brightness of the room.

- There are more functions available in the menus, see “Customising your TV” (P. 26 - 31).

Configuring your remote control



You can configure your TV's remote control to operate your other devices.

Configure your remote control.

- 1 Turn on the device manually.
- 2 Switch the remote control mode to a mode that matches your device. Refer to the table on the right to select an appropriate mode.

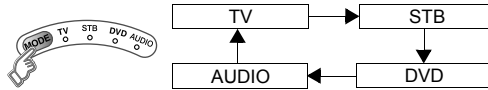

- The indicator lights for 3 seconds each time the remote control is operated.

- 3 Find the remote control code for your device according to its brand from the "Remote control codes" list. (Refer to P. I - X at the back of this manual.)
- 4 Set the remote control code.

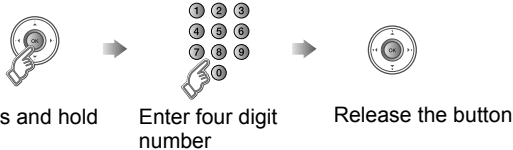

- 5 Point the remote control at your device, press and confirm that your device is turned off. If your device does not respond, try entering another available code.

Note

- If your device does not respond, try all the available codes for the device's brand.
- If none of the code works, or the brand is not listed, refer to "Using the search code function" (P. 25).

MODE	Applicable devices
TV	This TV only
STB	Cable Set Top Box, Cable/PVR Combination, Satellite Set Top Box, SAT/PVR Combination
DVD	DVD, Blu-Ray DVD, HD DVD, DVD-R, Home Theater in Box, TV/DVD Combination
AUDIO	Amplifier, Receiver, Home Theater in Box

Using the search code function

This function searches through the codes one by one, beginning from the first code in the list.

- 1 Turn on the device manually.**
- 2 Switch the remote control mode to a mode that matches your device.**
Press **MODE** to select the mode.
- 3 Activate the search code function.**
Hold down **TV** and **BACK** until the mode indicator blinks.
- 4 Point the remote control at your device and press **TV**. If there is no response, try the next code by pressing **▶** and press **TV** again. Repeat the process until your device turns off.**
- 5 Press **BACK** to register the code.**
The code is now set. Confirm that the mode indicator goes out.

■ If your TV's remote control still does not work even after using the search code function, use your device's own remote control. The TV's remote control is not guaranteed to work with all models, brands or operations.

Button functions



■ Change the remote control mode

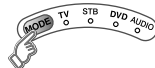

■ Turn on/off the device



■ Navigate the menus

Display top menu

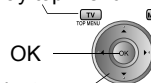

Display menu



OK

Select

Back to previous menu

■ Playback / Record, etc.

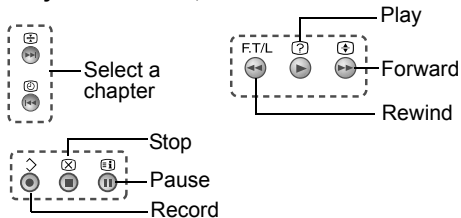

■ Display the Electronic Programme Guide

➔ Press "GUIDE"

■ Display the subtitle ➔ Press "i"

■ Mute ➔ Press "MUTE"

■ Volume ➔ Press "VOL +/-"

■ Select a surround mode ➔ Press "SURROUND"

● Depending on your device, some functions may not be operable with this remote control.

Customising your TV



1 Display the menu bar



2 Display the desired menu

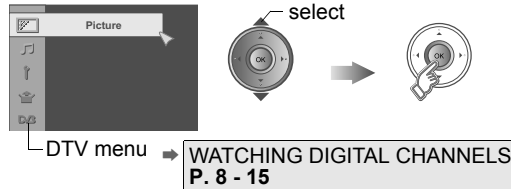

3 Change or adjust the setting

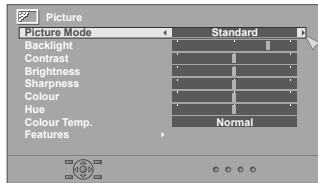

- The menu (excluding DTV menus) disappears after one minute of inactivity.
- To the previous screen
➔ **BACK**

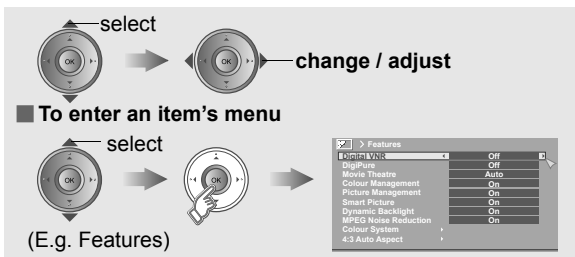

4 Close the menu



Press “**i**” to hide the bottom area of the menu (excluding DTV menus). Press again to display it.

Note

- Depending on the situation (analogue channels, digital channels, video signal formats, external inputs, etc.), some items will be displayed in black colour and will not work. You will not be able to change their setting as well.

Picture

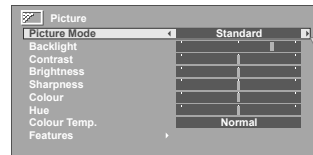

Picture Mode

You can select a preset picture setting according to the brightness of your room or when playing video games.

Bright	: in a fairly bright room
Soft	: in a dark room
Standard	: in a room with standard brightness
Game Mode	: when playing video games
■ You can make further adjustments to the selected preset “Picture Mode” to your liking.	
Backlight	Backlight brightness (Darker ⇔ Brighter)
Contrast	Contrast (Lower ⇔ Higher)
Brightness	Brightness (Darker ⇔ Brighter)
Sharpness	Sharpness (Softer ⇔ Sharper)
Colour	Colour (Lighter ⇔ Deeper)
Hue	Tint (Reddish ⇔ Greenish) (NTSC only)
Colour Temp.	Colour temperature (Warm / Normal / Cool)

- To return to the default adjustments ➔

Features

➔ “Features (sub menu)” (P. 27)

> Features (sub menu)

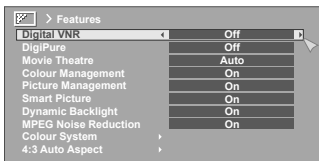

Note

- “Smart Picture” is not available when “Picture Mode” is set to “Bright” (P. 26).

Digital VNR

Reduce noise

On : Maintain constant effect **Off** : Function is turned off level

Auto* : Automatically adjusts the effect level

*“Auto” can be selected only when viewing analogue channels.

DigiPure

For natural-looking outlines

On : When the picture loses sharpness **Off** : Function is turned off sharpness

Movie Theatre

For smooth cinema film

On : Function is always on **Off** : Function is turned off

Auto : Turn on / off the function automatically

Colour Management

Maintain a natural colour balance (On / Off)

Picture Management

Make it easier to view bright / dark pictures (On / Off)

Smart Picture

Make it easier to view white areas (On / Off)

Dynamic Backlight

Reduce the brightness of the backlight when the screen is dark (On / Off)

MPEG Noise Reduction

Reduce MPEG video noise (On / Off)

Colour System

When there is no colour, change the colour system

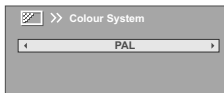

PAL : Western Europe (excluding France)

NTSC3.58* : USA 3.58 MHz

NTSC4.43* : USA 4.43 MHz

Auto* : When watching videos etc.

* Select in video mode only.

4:3 Auto Aspect

Select a default aspect ratio for Auto in “Zoom” (P. 22)

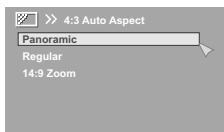

Panoramic

Regular

14:9 Zoom

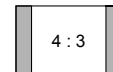

Sound

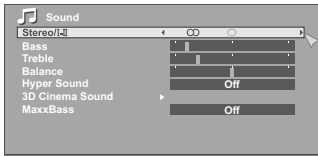

Note

- “Hyper Sound” and “3D Cinema Sound” cannot be set to “On” simultaneously.

Stereo/I-II

Select stereo, monaural or language (analogue channels)
(O: Monaural / ∞: Stereo / I: SUB1 / II: SUB2)

Bass

Low tones (Weaker ⇔ Stronger)

Treble

High tones (Weaker ⇔ Stronger)

Balance

Speaker balance (Left stronger ⇔ Right stronger)

Hyper Sound

Ambient sound (On / Off)

- “Hyper Sound” does not work with headphones.

3D Cinema Sound

Adjust “3D Cinema Sound” setting to your liking

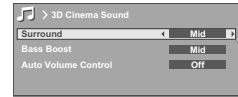

Surround:

Adjust the surround level (Low / Mid / High)

Bass Boost:

Emphasize the bass sound (Low / Mid / High)

Auto Volume Control:

Maintains a uniform sound volume even if the sound becomes loud suddenly during commercial breaks etc. (On / Off)

- To turn on / off the “3D Cinema Sound”, refer to “3D Cinema Sound” (P. 22).
- “3D Cinema Sound” does not work with headphones.

MaxxBass

Compensates low frequencies to widen the frequency band (Low / High / Off)

- “MaxxBass” does not work with headphones.

MaxxBass is a registered trademark of Waves Audio Ltd. in the USA, Japan and other countries.

Features

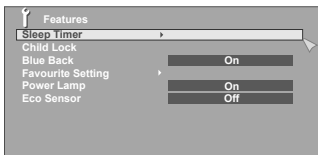

Sleep Timer

Timer for turning off the TV (P. 23)

Child Lock

Stop children from watching specific channels (analogue channels)

Lock a channel

1 Display the menu



- OK button does not work.

Set an "ID No."

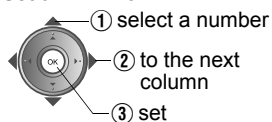

2 Select a channel and lock it. (🔒 : locked)

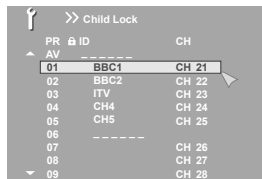

View a locked channel

Use the number buttons to enter the channel number.

When "🔒" appears, press "i" and enter your "ID No." with the number buttons.

- If you forget your "ID No.", perform step 1 again.

Blue Back

Displays a blue screen and mutes the sound when the signal is weak or absent (On / Off) (analogue channels)

Favourite Setting

Remove a channel from the Favourite channel list (analogue channels)

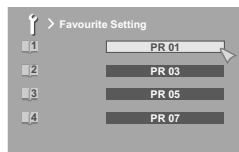

For more details

- ➔ "Register a channel to a button (Favourite channel)" (P. 19)



Power Lamp

Lights the power lamp (P. 6) while the TV is on (On / Off)

Eco Sensor

Automatically adjusts the picture contrast according to the brightness of your room (On / Off / Demo)

For more details

- ➔ "What is "Eco Sensor"?" (P. 34)

Set Up

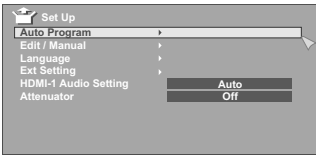

Auto Program

Automatically registers the channels (analogue channels)

To change the country, perform step 1 only.

1 Select the country of installation



select



● For the next page



(yellow)

2 Start "Auto Program"

(blue)

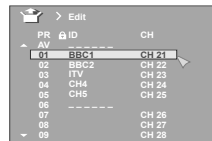
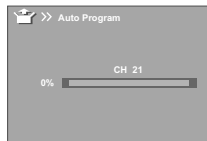

- If "ACI Start" appears, select and start settings. (This will set up cable television channels.)
 ➔ "What is "ACI" (Automatic Channel Installation)?" (P. 34)

- Edit channels
 ➔ "Editing analogue channels" (P. 15)

Edit/Manual

➔ "Editing analogue channels" (P. 15)

Language

Select a language for the menus (excluding DTV menus)

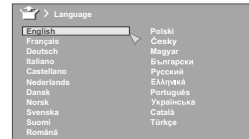

Ext Setting

➔ "Setting external terminals" (P. 31)

HDMI-1 Audio Setting

Set to "Digital" or "Auto" for HDMI devices, or "Analogue" or "Auto" for DVI devices. (Not available for EXT-5 and EXT-6.)

Attenuator

Select "On" when digital channels are not received because of too strong radio waves (On / Off)

Note

- "Attenuator" attenuates the radio waves of analogue broadcast as well as those of digital broadcast. If some noise or snow appears when watching an analogue channel, please set "Attenuator" to "Off" temporarily.

Setting external terminals

1 Display the “Ext Setting” menu

Display the menu bar



Select “Set Up”

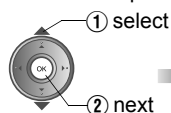

① select



Select “Ext Setting”

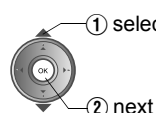

① select

② next

2 Select an “EXT” or arrow, and then proceed with setting

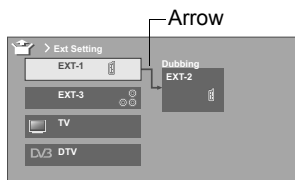

Arrow

Select an “EXT”



select

Select the arrow



select

3 Finish



- HDMI terminal setting ⇒ “HDMI-1 Audio Setting” (P. 30)

S-In

Switch to S-Video input

(yellow)



- “S” mark will appear at the selected “EXT”.
- The device selection display will change from “E2” to “S2”.

■ Cancel this mode ⇒ Press “ ” (yellow) again

ID List

Edit names of connected devices

- ① Show the name list
- ② Select a name from the list

(blue)

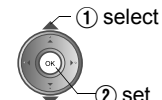

① select

② set

■ Clear the name ⇒ Select the blank space in the list

Dubbing

Set up dubbing on “EXT-2”



select the dubbing source

Switch between component and composite input (Pr/Pb/Y, V)

- ① Select “EXT-3”

- ② Set to component input

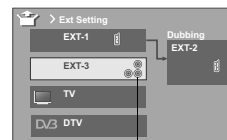

V

select



(yellow)

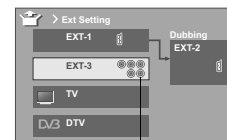

Pr/Pb/Y

■ Return to composite input ⇒ Press “ ” (yellow) in ② again.

Troubleshooting

■ Analogue channels

Severe noise or snow



- Is the TV connected correctly to the aerial?
- Change the direction of the aerial.

- Is the aerial or its cable damaged?
 - ➔ Consult your retailer
- Is the "Attenuator" set to "On"?
 - ➔ "Attenuator" (P. 30)

Patterns, stripes or noise



- Is the aerial receiving interference from high-voltage power lines or wireless transmitters?

- ➔ Consult your retailer
- Are connected devices too close to the TV?
 - ➔ Place a minimum distance between the aerial and the cause of interference until no interference

Ghosting

(Doubling of images)



- Are you receiving interference from signals reflected off mountains or buildings?

- ➔ Adjust the direction of your aerial, or change to a good-quality directional aerial

For problems concerning digital channels

➔ **WATCHING DIGITAL CHANNELS**
P. 16 - 17



I can't turn it on!

- Is the power cord connected to the AC outlet correctly?



The remote control doesn't work!

- Are the batteries flat?
- Are you more than 7 meters away from the TV?
- Is the "MODE (TV, STB, DVD, AUDIO)" set to "TV"?
- When viewing teletext, the TV menu bar does not appear.
- Depending on the stability of the signal, there may be a time lag when changing channels.

	Problem	Actions
Basics	Remote control stops working	<ul style="list-style-type: none"> ● Unplug TV, several minutes later plug it in again.
	Aspect ratio changes unintentionally	<ul style="list-style-type: none"> ● Press "ZOOM" to return to your settings. (P. 22)
Screen	Black or white dots appear on the screen	<ul style="list-style-type: none"> ● LCD panels use fine dots ("pixels") to display images. While more than 99.99% of these pixels function properly, a very small number of pixels may not light, or may light all the time. Please understand that this is not a malfunction.
	Poor picture quality	<ul style="list-style-type: none"> ● Change the "Picture Mode" setting. (P. 26) ● Unnatural colour >>> Adjust "Colour" and "Backlight". (P. 26) Check your "Colour System". (P. 27) ● Noise >>> Set to the following functions. Picture Mode: Standard (P. 26) Digital VNR: On (P. 27) DigiPure: Off (P. 27) ● Dull picture >>> Set to the following functions. Picture Mode: Bright (P. 26) Digital VNR: Off (P. 27) DigiPure: On (P. 27)
Picture	Strange picture when using an external device	<ul style="list-style-type: none"> ● If you connected S-Video output device, check the "S-In" setting. (P. 31) ● If the top of the image is distorted, check the video signal quality itself. ● If movement appears unnatural when receiving a signal from a DVD player etc., with 576p (625p), change the output setting of the external device to 576i (625i).

	Problem	Actions
Sound	Poor sound	<ul style="list-style-type: none"> ● Adjust “Bass” and “Treble”. (P. 28) ● If receiving a poor signal in “Stereo/I-II”, switch to “O” (monaural). (P. 23)
	No sound from the audio component	<ul style="list-style-type: none"> ● Audio signals received from EXT-4, EXT-5 and EXT-6 cannot be sent to the AUDIO OUT terminal.
	Left and right sound coming from one side of the speaker	<ul style="list-style-type: none"> ● If you hear both the left and right sound from one side of the speaker even after adjusting the speaker balance to one side, set “Hyper Sound” and “3D Cinema Sound” to “Off”. (P. 22, 28)
Functions	Some functions do not work	<ul style="list-style-type: none"> ● It is not a malfunction. Depending on the situation, some function items will be displayed in black colour and will not work. (P. 26)
	Wrong screen size	<ul style="list-style-type: none"> ● Read the user manual of the connected device and perform the following: <ul style="list-style-type: none"> ➔ Check if the output setting of the device is correct. ➔ Change the signal format of the device to other format.
HDMI	No picture, no sound	<ul style="list-style-type: none"> ● Use the cable marked with HDMI logo. 
	No sound	<ul style="list-style-type: none"> ● Check if the device is compliant with HDMI. ● Set “HDMI-1 Audio Setting” to “Digital” or “Auto” for HDMI devices, or “Analogue” or “Auto” for DVI devices. (Not available for EXT-5 and EXT-6.) (P. 30)

	Problem	Actions
HDMI	Green and distorted screen	<ul style="list-style-type: none"> ● Wait a little for the signal to stabilize when switching the signal format for an HDMI device.
Error message	“ACI Error” appears	<ul style="list-style-type: none"> ● Press ◀ to start “ACI” again. If you still receive the “ACI Error” after numerous tries, press ▶ to cancel “ACI”.

Technical information

What is "ACI" (Automatic Channel Installation)?

Some cable companies transmit a signal called "ACI" which contains information that allows TV channels to be registered automatically on your TV. When an ACI signal is received, "ACI Start / ACI Skip" appears in the "Auto Program" screen.

If you accidentally cut the power cord

Attach a new plug following the steps below. If in doubt, contact your local retailer.

Important

- Never connect to the larger terminal marked with an "E", the safety earth symbol "⊥" or coloured green or green-and-yellow.
- The wires in the mains lead on this product are coloured with the following code:
 - Blue: Neutral wire (connect to the black terminal, or one marked "N")
 - Brown: Live wire (connect to the red terminal, or one marked "L")

Change the fuse in the plug

Open the plug as illustrated on the right.

- When replacing the fuse, always use a correctly rated and approved type and re-fit the fuse cover when finished.

If in doubt, contact your local retailer.

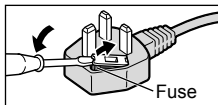

Auto in "Zoom"

When "Auto" is selected in Zoom, the aspect ratio will turn to the ratio obtained from the information the TV received.

- The aspect ratio will turn to the ratio obtained from WSS (Wide Screen Identification Signal), video signal, or control signal of the external devices. Without receiving the aspect information, it will be the setting in "4:3 Auto Aspect". (P. 27)

What is "Eco Sensor"?

You can adjust this TV so that the screen automatically adjusts to the optimum contrast of light and dark according to the brightness of your room. This function reduces eyestrain and the power consumption of this TV.

- Set "Eco Sensor" ➔ "Eco Sensor" (P. 29)

- Make sure not to block the Eco Sensor on front of the TV (P. 6)
- To fully reduce eyestrain and the power consumption of this TV. Set to the following functions.
Eco Sensor: On or Demo (P. 29)
Smart Picture: On (P. 27)
- Using "Demo" in "Eco Sensor", you can display the effect of the "Eco Sensor" on the screen

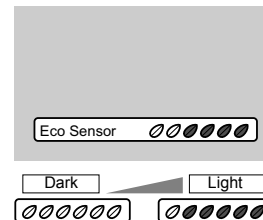

What is "Full Native"?

- With the full HD LCD display and "Full Native", you can enjoy full native HD resolution of 1920 x 1080. It exposes flaws in the video that were hidden when viewing on "Full".

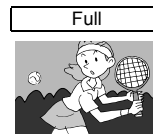

- * The illustrations are emphasised to make clear differences between "Full" and "Full Native".
- Dark bar or noise may appear at the edges of the screen when viewing in "Full Native" for some videos. This is resulted from the signal itself, not due to TV malfunction.

For more information, please read the separate manual (WATCHING DIGITAL CHANNELS).

"Technical Information" (P. 17 - 18)

Specifications

Model	LT-42DR9BJ
Broadcasting systems	CCIR I
Colour systems	TV broadcast: PAL External input: PAL, NTSC 3.58/4.43 MHz
Channels and frequencies	Digital: E21-E68 (Frequency: 470-854 MHz)* Analogue: UNITED KINGDOM: E21-E69 (UHF) IRELAND: IR A-IR J, E2-E12, E21-E69 (VHF/UHF)
Sound-multiplex systems	NICAM (I)
Teletext systems	Digital: MHEG 5 UK profile Analogue: FLOF (Fastext), WST (World Standard System)
Power requirements	AC 220 V - 240 V, 50 Hz
Audio output (Rated power output)	10 W + 10 W
Speakers	(4 cm x 16 cm) oblique x 2
Power consumption [standby]	220W [0.6W]
Screen size (visible area size measured diagonally)	105 cm
Connectors	HDMI x 3, RCA x 7 (component or composite video, audio L/R), Euroconnector (SCART) x 2, Optical connector (digital audio output) x 1 For details ➔ (P. 10, 11)
Headphone jack	Stereo mini jack (3.5 mm in diameter) x 1
Dimensions (W x H x D: mm) [without stand]	1014 x 698 x 296 [1014 x 646 x 109]
Weights [without stand]	26.1 kg [23.1 kg]
Accessories	(See "Check accessories", P. 8)

- A CAM (Conditional Access Module) for watching pay-TV digital channels can be installed. (P. 8)
- DC power can be supplied to the indoor aerial. ➔ (P. 12)

* This TV can receive digital terrestrial broadcasting (DVB-T) in the United Kingdom. Digital terrestrial broadcasting (DVB-T) reception in other countries is not guaranteed.

- We may change the design and specifications without notice.

Remote control codes (P. 24)

Cable Set Top Box

ADB	1230, 1269	Freebox	1482, 1976	Noos	0817	Scientific Atlanta	0477
Auna	1230	General Instrument	0276	NTL	0276, 1060, 1068	StarHub	0276
Austar	0276	HyperVision	0619	Ono	1068	Supercable	0276
Birmingham Cable Communications	0276	Jerrold	0276	Optus	0276	Tele Danmark	0619
Cable & Wireless	1068	Macab	0817	Pace	1060, 1068, 1577	Telewest	1068
Fosgate	0276	Madritel	1230	Philips	0619, 0817	Tudi	0619
France Telecom	0817	Motorola	0276	Sagem	0817	US Electronics	0276
		Nokia	1569	Samsung	1060, 1666	Visiopass	0817

Cable/PVR Combination

Freebox	1482, 1976	Nokia	1569
---------	------------	-------	------

Satellite Set Top Box

@sat	1300	AssCom	0853	BT	1296	Cyrus	0200
@Sky	1334	Aston	1261	Bubu Sat	0713	D-box	0723, 1114, 1127
ABsat	0713	Astra	0607, 0713	Bush	1284, 1645, 1672, 1743	Daewoo	0713, 1111, 1296, 1743
ADB	0642, 1367, 1418, 1473, 1491, 1259	Astratec	1743	Cambridge	0501	DAK	1993
Akai	0200	Astro	0173, 0501, 0607, 0613, 0658, 1099, 1100, 1113	Canal Digital	0853	Deltasat	1075
Akura	1705	Atsat	1300	Canal Satellite	0292, 0853, 1339, 1853	Digatron	1294
Alba	0455, 0613, 0713, 1284, 1659	AtSky	1334	Canal+	0853, 1339	Digenius	0299, 1161
Allsat	0200	Audioline	1672	CGV	1413, 1567	Digiality	0607
Alltech	0713	Audioton	0613	Cherokee	1480	Digifusion	1581, 1645, 1743
Allvision	1232, 1334, 1412	Austar	0642, 1259	Chess	0114, 0713, 1334, 1626	Digihome	1284
Amitronica	0713	Avalon	0396	Chili	1718	DigiLogic	1284
Ampere	0132, 0396	Axil	1457, 1659	CityCom	0299, 0607, 0818, 1075, 1176, 1232	DigiQuest	1300, 1457, 1473
Amstrad	0132, 0396, 0501, 0713, 0847, 1113, 1175, 1693	Axis	1111	Clark	0613	DigiSat	1232
Anglo	0713	B@ytronic	1412	Classic	1672	Digisky	1457
Ankaro	0713	Beko	0455	Clatronic	1413	Dijam	1296
Antron	0613	Best Buy	1993	Clemens Kamphus	0396	DiPro	1367, 1543
Apollo	0455	Big Sat	1457	Cobra	0396	DirecTV	0099
Apro	1672	Black Diamond	1284	Colombia	0132	Discovery	1480
Arcon	1075	Blaupunkt	0173	Comag	0132, 1232, 1366, 1412, 1413, 1579	Distratel	1283, 1704, 1705
Armstrong	0200	Blue Sky	0713	Conдор	0607	DMT	1075
Arnion	1300	Boca	0132, 0713, 1232, 1366	Connexions	0396	DNT	0200, 0396
Asat	0200	Boston	1251	Conrad	0132, 0501, 0607	Dream Multimedia	1237
ASCI	0114, 1334	Brainwave	0658, 1294, 1672	Coship	1457	Durabrand	1284
ASLF	0713	British Sky Broadcasting	0847, 1175, 1662	Crown	1284	Echostar	0167, 0396, 0455, 0610, 0713, 0853, 1200, 1323, 1409, 1418, 1473
		Broco	0713	Cryptovision	0455	Einhell	0132, 0501, 0713
		BskyB	0847, 1175, 1662				

Elap	0713, 1567	HB	1214	Lenco	0607, 0713	Multichoice	0642
Elsat	0713	HDT	1159	Lenson	0501	Mx Onda	1659
Elta	0200, 1659	Heliocom	0607	LG	1075	Myriad	0200
Engel	0713, 1251	Helium	0607	Lifesat	0132, 0299, 0713	Mysat	0713
EP Sat	0455	Hirschmann	0173, 0299, 0396, 0501, 0607, 1111, 1232, 1412	Listo	1626	MySky	1693, 1848, 1850
Eurocrypt	0455	Hitachi	0455, 1284	Lodos	1284	Neom	1993
EuroLine	1251	HNE	0132	Logik	1284	NEOTION	1334
Europa	0501, 0607	Hornet	1300	Logix	1075	Netgem	1322
Europhon	0132, 0299, 0607	Houston	0396	Lorenzen	0132, 0299, 0607, 1161, 1294, 1579	Netsat	0099
Eurosky	0114, 0132, 0299, 0501, 0607	Humax	1176, 1427, 1675, 1743, 1788, 1808, 1915	Luxor	0501	Neuf TV	1322
Eurostar	0607, 0818	Huth	0132, 0607, 1075	M Electronic	0818	Neuhaus	0501, 0607, 0713
Eutelsat	0713	Hyundai	1075, 1159	M vision	1557	Neuling	0132, 1232
Exator	0613	iCan	1367	Manata	0132, 0713	Neusat	0713
Fenner	0713	ID Digital	1176	Manhattan	0455	Neveling	1161
Ferguson	0455, 1291, 1743	ILLUSION sat	1557	Marantz	0200	Nevir	1659
Fidelity	0501	Imperial	1334, 1429, 1672	Maspro	0173, 0713	Newton	0396
Finlandia	0455	Ingelen	0114, 0396	Matsui	0173, 1284, 1591, 1743	Nikko	0200, 0713, 0723
Finlux	0455	International	0132	Max	0607	Noda Electronic	1704
Flair Mate	0713	Interstar	1214	Maxim	1705	Nokia	0455, 0723, 0751, 0853, 1023, 1127, 1223, 1310, 1723
FMD	0114, 1251, 1413, 1457	Intervision	0607	Maximum	1075, 1334	Nordmende	0455
Freecom	0501	ITT Nokia	0455, 0723	Mediabox	0292, 0853	Octagon	0613
FTEmaximal	0713	Jaeger	1334	Mediacom	1206	OctalTV	1294
Fuba	0173, 0299, 0396, 1161, 1214, 1251	K-SAT	0713	MediaSat	0292, 0501, 0853, 1339	Oggle	1705
Galaxis	0853, 1111, 1557	Kamm	0713	Medion	0132, 0299, 0713, 1075, 1232, 1334, 1412, 1626	Opentel	1232, 1412
Gardiner	0818	Kaon	1300	Medison	0713	Optex	0114, 0713, 1283, 1611, 1626
Garnet	1075	KaTelco	1111	Mega	0200	Orbis	1232, 1334, 1412
GbSAT	1214	Kathrein	0114, 0173, 0200, 0480, 0504, 0553, 0613, 0658, 0713, 0818, 1416, 1561, 1567	Metronic	0132, 0613, 0713, 0818, 1283, 1334, 1375, 1704, 1705	Orbitech	0114, 0501, 1099, 1100
Gecco	1273, 1412	Kenwood	0853	Metz	0173	P/Sat	1232
General Satellite	1176	Key West	0132	Micro	0501, 0607, 0613, 0713, 1294	Pace	0200, 0241, 0329, 0455, 0847, 0853, 1175, 1323, 1423, 1693, 1717, 1848, 1850
Globo	1251, 1334, 1412, 1429, 1626	Kiton	0114	Micro Elektronik	0713	Pacific	1284, 1375
GOD Digital	0200	Konig	0607	Micro Technology	0713	Packard Bell	1111
Gold Box	0292, 0853	KR	0613	Micromaxx	0299	Palcom	0299, 1161, 1409
Golden Interstar	1283	Kreiling	0114, 0658, 1480	Microstar	1075	Palladium	0396, 0501
Goodmans	0455, 1284, 1291, 1591, 1705	Kreismeyer	0173	Microtec	0713	Palsat	0501
Granada	0455	Kyostar	0613	Mitsubishi	0455	Panasonic	0455, 0847, 1304
Grandin	1626	L&S Electronic	0132, 1334	Morgan's	0132, 0200, 0713, 1232, 1412	Panda	0173, 0455, 0607
Grundig	0173, 0847, 0853, 1284, 1291, 1330	Labgear	1296	Motorola	1473	Patriot	0132
Haensel & Gretel	0132	LaSAT	0132, 0173, 0299, 0607	MTEC	1214	peekTon	1457
Hanseatic	1099, 1100	Legend	1718	Multibroadcast	0642		
Hauppauge	1294, 1672	Lemon	1334				

Satellite Set Top Box

Philippss	0099, 0133, 0173, 0200, 0292, 0455, 0613, 0818, 0853, 1114, 1339, 1499, 1543, 1672	Schaecke	0613	Sunny	1300	Triasat	0501
Phonotrend	1200	Schaub Lorenz	1214	Sunsat	0713	Triax	0114, 0132, 0200, 0396, 0501, 0713, 0853, 1113, 1251, 1291, 1296, 1611, 1626
Pilotime	1339	Schneider	1206, 1251	Sunstar	0132, 0642	TT-micro	1429
Pino	1334	Schwaiger	0132, 0504, 0607, 1075, 1111, 1334, 1412, 1457	Supratech	1413	Turnsat	0713
Pioneer	0292, 0329, 0853, 1308	SCS	0299	Systec	1334	Twinner	0713, 1611
Planet	0396	Sedea Electronique	0132, 1206, 1283, 1626	Tantec	0455	Unisat	0132, 0200
PMB	0713, 1611	Seeltech	1993	Tatung	0455	United	1251
Polytron	0396	Seemann	0396	Tboston	1659	Universum	0114, 0173, 0299, 0607, 1099, 1251
Portland	1296	SEG	0114, 1075, 1251, 1626, 1993	Tecatel	1200	Van Hunen	1161
Preisner	0132, 0396, 1113, 1366	Septimo	1375	TechniSat	0114, 0396, 0455, 0501, 1099, 1100, 1195, 1197, 1322	Vaova	1993
Premier	0292, 0723, 0853, 1429	Serd	1412	Technomate	1283, 1610	Variosat	0173
Primacom	1111	Serino	0610	Technosonic	1672	Ventana	0200
Proline	1659	Servimat	1611	Technotrend	1429	Vestel	0114, 1251
Promax	0455	ServiSat	0713, 1251	Technowelt	0132, 0607	VH Sat	0299
Quelle	0299, 0607	Siemens	0173, 0396, 1334, 1429	Techwood	0114, 1284, 1626	Visionic	1283
Radiola	0200	Silva	0299	Telasat	0607	VisionNet	1557
Radix	0396, 1113	Skantin	0713	TELE System	0396, 1251, 1409, 1611	Visosat	0114, 0713, 1413, 1457, 1718
Rainbow	0613	SKR	0713	Teleciel	0613	VTech	0818
Rebox	1214	SKY	0099, 0847, 1175, 1662, 1693, 1848, 1850	TeleClub	1367	Wetekom	0501
Regal	1251	SKY Italia	0853, 1693, 1848	Teleka	0396, 0501, 0607, 0613	Wewa	0455
RFT	0200	Sky XL	1251, 1412	Telesat	0607	Wharfedale	1284
Roadstar	0713, 0853	Sky+	1175	Telestar	0114, 0501, 1099, 1100, 1251, 1334, 1610, 1626, 1672	Wisi	0132, 0173, 0299, 0396, 0455, 0501, 0607, 1232
Rollmaster	1413	Skymaster	0713, 1075, 1200, 1334, 1409, 1567, 1611	Teletech	0114	Worldsat	0114, 1214, 1251, 1480, 1543
Rover	0713	Skymax	0200	Televies	0132, 0455, 0501, 1214, 1300, 1334	Xsat	0713, 0847, 1214, 1323
Rownsonic	1567	Skyplus	1232, 1334, 1412	Telewire	1232	Xtreme	1300
S-ZWO	1207	SkySat	0114, 0501, 0607, 0713	Tevion	0713, 1409, 1672	Yakumo	1413
SAB	1251	Skyvision	1334	Thomson	0292, 0455, 0607, 0713, 0820, 0847, 0853, 1046, 1175, 1291, 1339, 1534, 1543, 1662	Yamada	1718, 1993
Saba	0607, 0820	SL	0132, 0299, 1294, 1672	Thorn	0455	Zehnder	0114, 0504, 0818, 1075, 1232, 1251, 1334, 1412, 1413
Sabre	0455	SM Electronic	0713, 1200, 1409	Tiny	1672	Zeta Technology	0200
Sagem	0820, 1114, 1339, 1690	Smart	0132, 0396, 0713, 1113, 1232, 1273, 1404, 1413	Tioko	0132	Zodiac	0396, 0613
Samsung	0853, 1206, 1243, 1458, 1570, 1916	Sony	0282, 0292, 0455, 0847, 0853, 1558	Tividi	1429		
SAT	0501	SR	0132	Tokai	0200		
Sat Control	1300	Starland	0713	Tonna	0455, 0501, 0713, 1611		
Sat Partner	0501, 0613	Starlite	0200	Topfield	1206, 1207, 1208, 1545		
Sat Team	0713	Stream	1848	Toshiba	0455, 1284		
SAT+	1409	Strong	0132, 0613, 0713, 0820, 0853, 1159, 1284, 1409, 1626, 1765	TPS	0820		
Satcom	0607						
Satec	0713						
Satelco	1232						
Satplus	1100						

SAT/PVR Combination

@sat	1300	Echostar	0610	Morgan's	1412	Sedeae Electronique	1206
Allvision	1412	GbSAT	1214	MTEC	1214	SEG	1993
Amstrad	1175	Gecco	1412	MySky	1693, 1848, 1850	Serd	1412
Atsat	1300	Globo	1412	NEOTION	1334	SKY	1175, 1693, 1848, 1850
B@ytronic	1412	HDT	1159	Nokia	1023, 1310	SKY Italia	1848
Best Buy	1993	Hirschmann	1412	Opentel	1412	Sky XL	1412
British Sky Broadcasting	1175	Humax	1176, 1427, 1675, 1788, 1808	Orbis	1412	Skymaster	1075
BskyB	1175, 1662	Huth	1075	Pace	1175, 1423, 1850	Skyplus	1334, 1412
Bush	1645	Hyundai	1075, 1159	Panasonic	1304	Sunny	1300
Canal Satellite	1339	Kathrein	0658, 1561	Philips	0099	TechniSat	1195, 1197
Comag	1412	LG	1075	Pilotime	1339	Thomson	1175, 1534, 1662
DAK	1993	Maximum	1334	Rebox	1214	Topfield	1206, 1545
Digifusion	1645	Mediacom	1206	Samsung	1206, 1570	Vaova	1993
DigiQuest	1300	Medion	1412	Sat Control	1300	Xtreme	1300
DMT	1075	Microstar	1075	Schneider	1206	Yamada	1993
Dream Multimedia	1237			Schwaiger	1075, 1412	Zehnder	1075, 1412

DVD

3D LAB	0539	Apex Digital	0672, 1004	Blue Nova International	1321	cineULTRA	0699
4Kus	1158	Arena	1115	Blue Sky	0651, 0672, 0695, 0713, 0790, 0843, 1423	Classic	0730, 1730
A-Trend	0714	Aria	0893	Boghe	1004, 1221	Clatronic	0672, 0675, 0788, 0818, 1233, 1434
Acoustic Solutions	0713, 0730, 1316	Arianet	0818, 0893	Boman	0783, 0898, 1005	Clayton	0713
AEG	0770, 0788, 0790, 1233, 1434, 1923	Aristona	0539, 0646	Bose	2023	Coby	0730, 0852
AFK	1051, 1152, 1923	ASCOMTEC	1923	Brainwave	0770, 1115	Codex	1233
Airis	0672, 1005, 1224, 1321	Asono	1224	Brandt	0503, 0551, 0651	Commax	1321
Aiwa	0533	Astro	1513	Broksonic	0695	Conia	0852
Akai	0788, 0790, 0898, 1115, 1233, 1557, 1695	Atacom	1224	Bush	0672, 0699, 0713, 0723, 0730, 0733, 0831, 0879, 1051, 1128, 1140, 1367, 1419, 1436, 1483, 1695, 1832	Contel	0788
AKI	1005	Audiola	1660	Cambridge Audio	0751, 1109	Continental Edison	0831, 0872
Akura	0898, 1051, 1140, 1233, 1367	Audiosonic	1923	Campomatic Digital	1051	Crown	0713, 0770, 1115
Alba	0539, 0672, 0695, 0699, 0713, 0730, 0783, 1140, 1530, 1695	Audix	0713	Cat	0699, 0786, 0789, 1421, 1923	Cybercom	0831
Alize	1151	Autovox	0713	CCE	0730	CyberHome	0714, 0816, 1502
All-Tel	1451	Auvio	0843	cello	1730	Cytron	0651, 0774, 1347
Altacom	1224	Axion	0730	Centrum	0713, 0779, 0789, 1005, 1227, 1923, 1994	D-Vison	1115, 1367
Amitech	0770, 0850	Basic Line	0713, 1994	CGV	0733, 0751, 1115	Daenyx	0872
Amoi	0852	Baze	0898	Cine	0841	Daewoo	0490, 0714, 0770, 0870, 0872, 1436, 1483
Amstrad	0713, 0770, 1151, 1367	BBK	1224	Cinetec	0713, 0872	Dalton	0786, 1036
AMW	0872	Beep	1163			Dansai	0770, 0783, 1115, 1695
Ansonic	0774, 0831, 1316	Bellagio	1004			Dantax	0539, 0713, 0723, 0790
		Belson	1923			Daytek	0872, 1005
		Berthen	1643			Dayton	0872
		Binatone	1923			DCE	0831
		Black Diamond	0713				
		Blu:sens	1233, 1321				

DVD

Decca	0770, 1115	Fintec	1530	Humax	0646	Lodos	0713
Denon	0490, 0634, 1634	Firstline	0713, 0843, 0869, 1530	Hyundai	0850, 1660	Loewe	0539, 0741
Denver	0672, 0699, 0788, 0898, 1316, 1321, 1923	Fisher	0670	IISonic	1508	Logik	0713
Denzel	0665	Funai	0675, 0695	Ingelen	0788	Logix	0783
Desay	0843	Gateway	1158	Inno Hit	0713	Loomax	1487
Dgtec	0672	Germatic	1051	Irradio	0869, 1115, 1224, 1233	Luker	1367
Diamond	0651	Giec	1221	IRT	0783	Lumatron	0695, 0713, 0741, 1115, 1321, 1832
Dighome	0713	Global Link	1224	ISP	0695	Lunatron	0741
DigiLogic	0713	Global Solutions	0768	Jamo	1036	Luxman	0573
Digital i	0893	Global Sphere	1152	Jaton	0665	Luxor	0713, 1004, 1695, 1730
Digitech	1832	Go Video	0783, 0869	JDB	0730	Magnat	1923
DiK	0831	GoldStar	0591, 0741	JDV	1367	Magnavox	0503, 0539, 0646, 0675, 0713, 1140
Dinamic	0788	Goodmans	0651, 0713, 0723, 0730, 0783, 0790, 0879, 1004, 1140, 1221, 1316, 1423, 1530, 1730, 1923, 2014	Jeken	0699	Magnex	0723
Disney	0831	GoWell	1643	JMB	0695	Magnum	1436, 2014
DK Digital	0831, 1557, 1660	GPX	0699, 0741	JVC	0503, 0539, 0623, 1164, 1241, 1275, 1550, 1597, 1602, 1701, 1860, 1863, 1940	Manhattan	0713
DMTech	0783, 1271	Graetz	0665	jWin	1051	Marantz	0539
Dragon	0831	Gran Prix	0831, 0898	Kansas Technologies	1233, 1530	Mark	0713
DreamX	1151	Grandin	0713, 1233	Karcher	0783	Marquant	0770
DSE	1730	Grundig	0539, 0551, 0651, 0670, 0695, 0713, 0775, 0790, 1004, 1036, 1128, 1436, 1465, 1643, 1695, 1730, 1832	Kendo	0672, 0699, 0713, 0831	Mastec	1221, 1434
Dual	0651, 0665, 0713, 0730, 0779, 0783, 0790, 0831, 1436, 1530	H & B	0713, 0818, 0841, 0850, 1233, 1421	Kennex	0713, 0770, 0898	Matsui	0651, 0672, 0695, 0713, 1004, 1316, 1695, 1730
Durabrand	0713, 0831, 1502	Hanseatic	0741, 0783, 0790	Kenwood	0490, 0534	Maxim	0713, 0872, 1367
E.max	1233, 1321, 1643	Harman/Kardon	0702	Kiiri	0770	MBO	0730, 1730
eBench	1152	Haus	0786	King Vision	1643	MDS	0713
ECC	0730	HCM	0788	Kingavon	0818	Mecotek	0770
Eclipse	0723, 0751	HE	0730, 1163, 1923	Kiss	0665, 0841, 1523	Medion	0630, 0651, 0774, 0783, 0831, 0879, 1006, 1347, 1423
Elfunk	0713, 0850	Henss	0713	Kotron	0879	MEI	0790
Elin	0770	HiMAX	0843	Kreisen	1421	Memorex	0831
Ellion	0850, 1421	Hitachi	0573, 0664, 0665, 0713, 1664, 1835, 1994	KXD	1321, 1923	Metz	0525, 0571, 0713, 1994
Elta	0672, 0770, 0788, 0850, 1051, 1115, 1151, 1233	Hiteker	0672, 1923	Lawson	0768	MiCO	0723, 0751, 1221, 1223
Eltax	1233, 1321	Hoehner	0651, 0713, 0831, 1004, 1224	Leiker	0872, 1513	Micromaxx	0695, 1695
Emerson	0591	Home Electronics	0730, 0770	Lenco	0651, 0699, 0713, 0770, 0774, 1513	Micromedia	0503, 0539
Energy Sistem	1513	Home Tech Industries	1224	Lenoxx	2014	Micromega	0539, 1005
Enterprise	0591	HotMedia	1152	Lenoxx Sound	2014	Microsoft	0522, 1708
EuroLine	0675, 0788, 1115, 1233			Lexia	0699, 0768	Microstar	0831
Excello	1513			LG	0591, 0741, 0790, 0869, 1906	Minato	0752
Fenner	0651			Lifetec	0651, 0831, 1347	Minax	0713
Ferguson	0651, 0695, 0713, 0898, 1695, 1730			Limit	0768	Minoka	0770, 1115
Finlux	0591, 0672, 0741, 0751, 0770, 0783			LiteOn	1158, 1416	Mirror	0752, 0879
				LM	1643	Mitsubishi	0713

Mizuda	0770, 0818, 1451	Phonotrend	0699	Schaub Lorenz	0770, 0788, 1115, 1151	Strong	0713
Monyka	0665	Pioneer	0142, 0525, 0571, 0631, 1571, 1965	Schneider	0539, 0646, 0651, 0713, 0774, 0779, 0783, 0788, 0790, 0831, 0869, 1367	Sunkai	0770, 0850
MPX	0843	Play It	1643	Schoentech	0713	Sunstech	0831, 1513
Mustek	0730, 1730	Plu2	0850	Schwaiger	0752	Sunwood	0788, 0898
Muvid	1643	Powerpoint	0872, 1005	Scientific Labs	0768	Supervision	0768, 1152
Mx Onda	0651, 0751, 1223	Prinz	0831	Scott	0651, 0672, 1005, 1036, 1233, 1394, 1423, 1923	Supratech	0893, 1513
Mystral	0831	Prism	0831	Seeltech	1224, 1451, 1513, 1643	SVA	0672, 0752
NAD	0741	ProCaster	1004, 1513	SEG	0665, 0713, 0763, 0872, 1483, 1530, 1994	Sylvania	0675
Naiko	0770, 1004, 1367	Proline	0651, 0672, 0710, 1004, 1316, 1483	Shanghai	0672	Synn	0768
Narita	1367	Proscan	0522	Sharp	0630, 0675, 0713, 0752, 1419, 2015, 2024	Tamashi	1394
Neom	1643	Proson	0713	Sherwood	0741	Tandberg	0713, 1695, 1994
Neovia	1271	Prosonic	0699, 0752	Siemssen	1382	Tangent	1321
Neufunk	0665	ProVision	0699, 0730, 1163, 1321, 1484, 1923	Sigmathek	1005, 1224	Targa	1227, 1906
Nevir	0770, 0831, 1484	Pye	0539, 0646	Siltex	1224	Tatung	0770, 1695
Nikkai	1923	QONIX	1051	Silva	0788, 0898	Tchibo	0741
Nintaus	1051	Radionette	0741, 0869, 1906, 2024	Silva Schneider	0831, 0898	TCM	0741, 0790
Norcent	1923	Raite	0665	SilverCrest	0131, 1152	Teac	0741, 0768, 1227
Nordmende	0774, 0831	RCA	0522	Sinudyne	1221, 1316	Tec	0898
Noriko	0752	REC	0490	Sistemas	0672	Technica	1367, 1695
Okano	0752	Redstar	0763, 0770, 0788, 0898, 1394, 1923	Skantic	0539, 0713	Technics	0490, 1905
Olidata	0672	Relisys	1347	Skymaster	0730, 0768	Technika	0770, 0831, 1115, 1316, 1695
Onkyo	0503, 0627, 1769	Reoc	0752, 0768	Skyworth	0898	Technisson	1115
Oopla	1158	Revoy	0699, 0841	Sliding	1115	Technosonic	1051, 1115
Optim	0843	Richmond	1233	SM Electronic	0730, 0768, 1152	Techwood	0713, 1530, 1994
Optimus	0525	Roadstar	0672, 0699, 0713, 0730, 0818, 0879, 0898, 1051, 1227, 1434, 2014	Smart	0713	Tecnimagen	1233
Orava	0818	Ronin	0710, 0872	Sonic Blue	0783	Teletech	0713, 0768
Orbit	0872	Rotel	0623	Sony	0533, 0573, 0864, 1033, 1070, 1516, 1533, 1536, 1633, 1824, 1934, 1981, 2020, 2043, 2132, 1433	Tensai	0651, 0770
Orion	0695, 1128, 1233, 1419, 1434, 1695	Rownsonic	0789	Sound Color	1233	Tesco	1316
Oritron	0651	Saba	0551, 0651	Soundmaster	0768	Tevion	0651, 0898, 1036, 1227, 1382, 1483, 1730, 1923, 2014
Ormond	0713	Saivod	0831, 1367	Soundwave	0783	Theta Digital	0571
P&B	0818, 1451	Salora	0741	Standard	0651, 0768, 0788, 0831, 0898	Thomson	0522, 0551
Pacific	0695, 0713, 0768, 0790, 0831	Sampo	1321	Star Clusters	1152, 1227	Tokai	0665, 0788, 0790, 0898, 1557
Packard Bell	0831, 1321, 1648	Samsung	0199, 0490, 0573, 0744, 1075, 1635, 1932	Starlogic	1005	Tom-Tec	0789
Palladium	0695, 0713, 0779, 1906	Sansui	0695, 0751, 1316	Starmedia	0818, 1005, 1224	Top Suxess	1224
Panasonic	0490, 1010, 1011, 1579, 1641, 1661, 1834, 1905, 1908	Sanyo	0670, 0713	Stevison	1367	Toshiba	0503, 0695, 1045, 1459, 1510, 1769, 2006
Panda	0789	Scan	0850	Strato	1382	TRANS-continent	0831, 0872, 1233, 1321
peeKton	0898, 1224, 1484	ScanMagic	0730, 1730			Tredex	0843
Philco	0733	ScanSonic	1695			TSM	1224
Philips	0503, 0539, 0646, 0675, 1158, 1340, 1354, 1813, 2084					Umax	1151

DVD

United	0675, 0695, 0699, 0713, 0730, 0788, 1115, 1152, 1233, 1367, 1643, 1832	Victor	1241	Wharfedale	0713, 0751, 0752, 0790, 1832, 1835	Xoro	1183, 1221
		Voxson	0730, 0831			Yakumo	1004
		Waitec	1151, 1224, 1233	Wilson	0831, 1233	Yamada	0872, 1004, 1151, 1158, 1416
Universum	0591, 0713, 0741, 0779, 0790, 0869, 1227, 1530, 1913	Waltham	1530	Windsor	0713	Yamaha	0490, 0539, 0646
		Welkin	0831	Windy Sam	0573	Yamakawa	0665, 0710, 0872
Uptek	0763	Wellington	0713	Woxter	1005, 1151, 1224	Yukai	0730, 1730
Venturer	0790	Welltech	1221	X-Waves	1513	Zenith	0503, 0591
Vestel	0713, 1530, 1994	Weitstar	0713	Xbox	0522, 1708		
		Wesder	0699	Xenius	0790		

Blu-Ray DVD

LG	0741	Philips	2084	Samsung	0199	Toshiba	1769
Panasonic	1641	Pioneer	0142	Sony	1516		

HD DVD

JVC	0623	LG	0741	Onkyo	1769	Toshiba	1769
-----	------	----	------	-------	------	---------	------

DVD-R

4Kus	1158	Fintec	1530	Mastec	1221	Sinudyne	1221
Airis	1321	Firstline	1530	Matsui	1730	Sony	1033, 1070, 2132
Alba	1530	Funai	0675	MBO	1730	Star Clusters	1227
Aristona	0646	Gateway	1158	Medion	1347	Sylvania	0675
Boghe	1221	Giec	1221	MiCO	0751, 1221	Tangent	1321
Bush	1436	Goodmans	1221, 1530, 1730	Mustek	1730	Targa	1227
Cat	1421	GPX	0741	Oopla	1158	Teac	1227
cello	1730	Grundig	1436, 1730	Packard Bell	1321	Techwood	1530
Centrum	1227	H & B	1421	Panasonic	0490, 1010, 1011, 1579	Tevion	1227, 1730
Classic	1730	Humax	0646	Philips	0646, 1158	Thomson	0551
Commax	1321	JVC	1164, 1275, 1597	Pioneer	0631	Toshiba	1510
CyberHome	1502	Kansas Technologies	1530	ProVision	1321	Universum	1227, 1530
Cytron	1347	Kreisen	1421	Pye	0646	Vestel	1530
DSE	1730	KXD	1321	Relisys	1347	Waltham	1530
Dual	1530	LG	0741	Roadstar	1227	Welltech	1221
Durabrand	1502	Lifetec	1347	Samsung	1635	Xoro	1221
E: max	1321	LiteOn	1158, 1416	ScanMagic	1730	Yamada	1158, 1416
Ellion	1421	Loewe	0741	Schneider	0646	Yamaha	0646
Eltax	1321	Lumatron	1321	SEG	1530	Yukai	1730
Ferguson	1730	Luxor	1730	Sharp	1419		

Home Theater in Box (DVD)

AEG	0790, 1923	Finlux	0672	Marquant	0770	SEG	1994
AFK	1923	Goodmans	0790, 1923, 2014	MEI	0790	Sharp	2015, 2024
Akai	0790	Grundig	1832	Metz	1994	Sony	1824, 1934, 1981, 2020, 2132
ASCOMTEC	1923	Grunkel	0790	Nikkai	1923	Tandberg	1994
Audiosonic	1923	Hanseatic	0790	Norcent	1923	Targa	1906
Basic Line	1994	HE	1923	Onkyo	0627	Technics	1905
Belson	1923	Hitachi	1835, 1994	Palladium	0779, 1906	Techwood	1994
Binatone	1923	Hiteker	1923	Panasonic	1834, 1905, 1908	Tevion	1923, 2014
Blue Sky	0790	Irradio	1233	Philips	1813	Thomson	0522
Bose	2023	JVC	0623, 1701, 1860, 1863, 1940	Pioneer	1965	Tokai	0790
Bush	1832	KXD	1923	ProVision	1923	Toshiba	2006
Cat	1923	Lenoxx	2014	Radionette	1906, 2024	United	1832
Centrum	1923, 1994	Lenoxx Sound	2014	Redstar	1923	Universum	0779, 0790, 1913
Dantax	0790	LG	0790, 1906	Roadstar	2014	Venturer	0790
Denon	0634, 1634	Lumatron	1832	Samsung	1932	Vestel	1994
Denver	1923	Magnat	1923	Sanyo	0670	Wharfedale	0790, 1832
Digitech	1832	Magnum	2014	Schneider	0779, 0790	Xenius	0790
Dual	0779, 0790			Scott	1923		

TV/DVD Combination

Akura	1367	Elfunk	0713	Matsui	0713	Saivod	1367
Alba	0695	Ferguson	0695, 0713	Maxim	1367	Schneider	1367
Amstrad	1367	Goodmans	0713, 0879	Medion	0879	SEG	0713
Black Diamond	0713	Grandin	0713	Mirror	0879	Sliding	1115
Blue Sky	0713	Grundig	0539, 0695	Naiko	1367	Stevison	1367
Bush	0713, 0879, 1367	Hitachi	0713	Narita	1367	Technica	1367
Centrum	0713	JDV	1367	Neovia	1271	Thomson	0551
Crown	0713	Kotron	0879	Orion	0695	Toshiba	0695
D-Vision	1367	Logik	0713	Pacific	0695	United	0713, 1367
Daewoo	0870	Luker	1367	Philips	0539	Universum	0713
DMTech	1271	Luxor	0713	Roadstar	0879		

Amplifier

Curtis Mathes	0300	Optimus	0300	RCA	0300	Yamaha	0848
Denon	0272	Pioneer	0300	Sony	0689		

Receiver

AEG	1389, 1390	Harman/Kardon	1189, 1304, 1310	Onkyo	0135, 1320	Targa	1293
AFK	1389	Harwood	0744	Optimus	0186, 0744, 1023	TCM	0797
Aiwa	0121, 1189, 1269, 1405	HCM	1390	Orient Power	0744	Teac	0609
Akai	0609, 1390	HE	1389	Palladium	0797, 1220, 1293, 1344, 1390	Technics	1308, 1309, 1518, 1763, 1765
All-Tel	1390	Hitachi	1344, 1554, 1801	Panasonic	1308, 1309, 1316, 1518, 1763, 1765, 1779	Techwood	1554
Amstrad	0744	Hitech	0744	Philips	1089, 1189, 1269, 1289, 1673	Tevion	1389, 1611
Anam	0609	Hiteker	1389	Pioneer	0186, 1023, 1459, 1623	Thomson	1154, 1354
ASCOMTEC	1389	Intersound	0744	Prima Electronic	0797	Thorens	1189
Audiolab	1189	JVC	2000, 2001, 0074, 1374, 1676	Proline	0797, 1390	Thorn	0744
Audiosonic	1389	Kenwood	0186, 1027, 1313	QONIX	1420	Tokai	1390
Audiotronic	1189	Kioto	0797	Radionette	1293, 1634	Toshiba	1572
Bang & Olufsen	0799	Kompernass	0797	RCA	1154	United	1390, 1772
Basic Line	1554	KXD	1389	Recco	0797	Universum	0609, 0744, 0797, 1220, 1390, 1609
Belson	1389	Lenoxx	1611	Redstar	1389	Venturer	0797, 1390
Binatone	1389	Lenoxx Sound	1611	Revox	0186, 1089	Vestel	1554
Blue Sky	1390	LG	1293, 1869	Roadstar	0797, 1611	Victor	0074
Bose	1229, 1355, 1933	Lifetec	0797	Samsung	1295	Waitec	1352
Bush	0797, 1772	Lumatron	1772	Sansui	0609, 1089	Watson	0797
Cat	1389	LXI	0744	Sanyo	0744, 1801	Welltech	0797
CCE	1352	Magnat	1389	Schneider	0744, 1220, 1390	Wharfedale	1390, 1772
Centrum	1220, 1389	Magnavox	1089, 1189	Scott	1389	Xenios	1390
Clatronic	0797	Magnum	1611	SEG	1554	Yamaha	0176, 0186, 0712, 1276, 1331, 1949
Cosmotron	0797	Marantz	1089, 1189, 1269, 1289	Sharp	0186, 0653, 1614, 1634	Yukai	1352
Dantax	1390	Matsui	0744, 0797	Sherwood	0653	Zenith	0744
Denon	1104, 1360	MBO	1352	Siemens	0609		
Denver	1389	Medion	0797, 1420	Silva Schneider	1390		
Digitech	1772	MEI	1390				
DiK	0797	Metz	1554	Sony	1058, 1112, 1158, 1258, 1441, 1454, 1658, 1722, 1758, 1759, 1822, 1858, 1882		
DK Digital	1420	Micromaxx	1420	Soundwave	0609		
Dual	1220, 1390, 1420	Micromega	1189	Stereophonics	1023		
eBench	0744, 0797	Microstar	0797	Sumida	0744		
Elta	0744, 0797, 1390	Musicmagic	1089	Sunfire	1313		
Ferguson	1154	Mustek	1352	Sunstech	1420		
Fine Arts	1189	Mx Onda	0744, 0797	TAG McLaren	1189		
Genexxa	0186	Myryad	1189	Tandberg	1554		
Goodmans	0609, 0744, 0797, 1389, 1390, 1420, 1611	NAD	0320, 0609				
Grundig	0797, 1089, 1189, 1344, 1772	Nikkai	1389				
Grunkel	0744, 1390	Nikkei	0744				
Hanseatic	1390	Norcent	1389				
		NTDE Geniesom	0744				

Home Theater in Box

AEG	1389, 1390	Grundig	1344, 1772	Mustek	1352	Sony	1454, 1658, 1758, 1822, 1858, 1882
AFK	1389	Grunkel	1390	NAD	0609	Sunstech	1420
Akai	1390	Hanseatic	1390	Nikkai	1389	Tandberg	1554
All-Tel	1390	HCM	1390	Norcent	1389	Targa	1293
ASCOMTEC	1389	HE	1389	Onkyo	0135	Technics	1763, 1765
Audiosonic	1389	Hitachi	1344, 1554, 1801	Palladium	1220, 1293, 1344, 1390	Techwood	1554
Basic Line	1554	Hiteker	1389	Panasonic	1316, 1763, 1765, 1779	Tevion	1389, 1611
Belson	1389	JVC	2000, 2001, 0074, 1374, 1676	Philips	1269, 1673	Tokai	1390
Binatone	1389	Kenwood	1313	Pioneer	1459	Toshiba	1572
Blue Sky	1390	KXD	1389	Proline	1390	United	1390, 1772
Bose	1229, 1933	Lenoxx	1611	ProVision	1389	Universum	1220, 1390, 1609
Bush	1772	Lenoxx Sound	1611	QONIX	1420	Venturer	1390
Cat	1389	LG	1293, 1869	Radionette	1293, 1634	Vestel	1554
CCE	1352	Lumatron	1772	Redstar	1389	Waitec	1352
Centrum	1389	Magnat	1389	Roadstar	1611	Wharfedale	1390, 1772
Dantax	1390	Magnum	1611	Samsung	1295	Xenius	1390
Denver	1389	MBO	1352	Sanyo	1801	Yamaha	0712, 1331
Digitech	1772	Medion	1420	Schneider	1220, 1390	Yukai	1352
DK Digital	1420	MEI	1390	Scott	1389		
Dual	1220, 1390, 1420	Metz	1554	SEG	1554		
Elta	1390	Micromaxx	1420	Sharp	1614, 1634		
Goodmans	1389, 1390, 1420, 1611			Silva Schneider	1390		

JVC

For users in the UK :

If you have any problems setting up your new TV, please call the **JVC** Helpline on **0870 330 5000**.

For users in the Republic of Ireland :

If you have any problems setting up your new TV, please call the **JVC** Helpline on **1890-582500**.