

JVC



LT-32DA20J

ENGLISH

WIDE LCD PANEL TV

INSTRUCTIONS

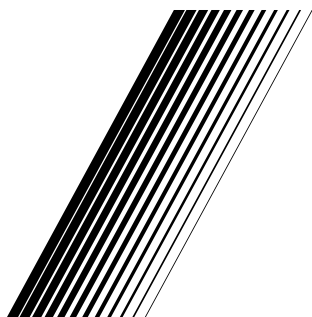
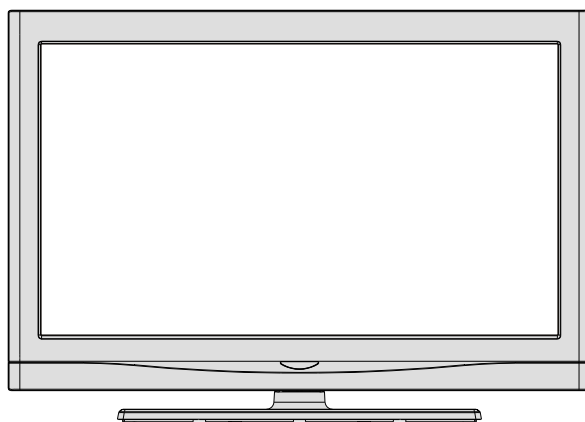

0410TMH-VT-VT

Dear Customer.

This apparatus is in conformance with the valid European directives and standards regarding electromagnetic compatibility and electrical safety.

European representative of Victor Company of Japan, Limited is:

JVC Technical Services Europe GmbH

Postfach 10 05 04

61145 Friedberg

Germany

Information for Users on Disposal of Old Equipment and Batteries [European Union]



These symbols indicate that the electrical and electronic equipment and the battery with this symbol should not be disposed of as general household waste at its end-of-life. Instead, the products should be handed over to the applicable collection points for the recycling of electrical and electronic equipment as well as batteries for proper treatment, recovery and recycling in accordance with your national legislation and the Directive 2002/96/EC and 2006/66/EC.



Products

By disposing of these products correctly, you will help to conserve natural resources and will help to prevent potential negative effects on the environment and human health which could otherwise be caused by inappropriate waste handling of these products.

For more information about collection points and recycling of these products, please contact your local municipal office, your household waste disposal service or the shop where you purchased the product.



Battery

Penalties may be applicable for incorrect disposal of this waste, in accordance with national legislation.

[Business users]

If you wish to dispose of this product, please confirm attached "KESA ELECTRICALS SAFETY INSTRUCTIONS" to obtain information about the take-back of the product.

[Other Countries outside the European Union]

These symbols are only valid in the European Union.

Notice:

The sign Pb below the symbol for batteries indicates that this battery contains lead.

If you wish to dispose of these items, please do so in accordance with applicable national legislation or other rules in your country for the treatment of old electrical and electronic equipment and batteries.

Logo & License



HDMI, the HDMI Logo, and High-Definition Multimedia Interface are trademarks or registered trademarks of HDMI Licensing LLC in the United States and other countries.

DVB is a registered trademark of the DVB Project

TRADEMARK ACKNOWLEDGMENT

"Dolby" and the double-D symbol are trademarks of Dolby Laboratories.

Contents

Logo & License.....	1	IDTV Menu System	13
Accessories	3	Channel List.....	13
Features	3	Timers	15
Introduction.....	3	Conditional Access	15
Preparation.....	3	TV Setup.....	15
Safety Precautions	4	Setup	15
Power Source	4	Analogue TV Menu System.....	19
Power Cord.....	4	Picture Menu.....	19
Moisture and Water	4	Sound Menu	20
Cleaning.....	4	Feature Menu	21
Heat and Flames	4	Install Menu	22
Lightning	4	Source Menu	23
Replacement Parts	4	PC Mode Menu System.....	24
Servicing.....	4	PC Position Menu.....	24
Waste Disposal.....	4	Displaying TV Information	24
Disconnecting the Device	4	Muting Function	24
Headphone Volume	4	Freezing Picture	24
Installation.....	4	Zoom Modes.....	24
LCD Screen	4	Auto	25
Warning	5	16:9.....	25
Inserting Batteries into the Remote Control Handset.....	5	4:3.....	25
Operating Range for the Remote Control.....	5	Panoramic.....	25
Overview of the Remote Control	6	14:9.....	25
LCD TV and Operating Buttons.....	7	Cinema	25
Viewing the Connections- Back Connectors	7	Subtitle.....	25
Viewing the Connections - Side Connectors	8	Zoom	25
Using the Cable Holder	8	Teletext	26
Power Connection	8	Tips.....	26
Aerial Connection	8	Image Persistence	26
Connecting the LCD TV to a PC.....	9	No Power	26
Connecting to a DVD Player.....	9	Poor Picture	26
Using Side AV Connectors	10	No Picture	26
Connecting Other Equipment via SCART	10	Sound	26
Switching the TV On/Off	10	Remote Control.....	26
To Switch the TV On	10	Input Sources.....	26
To Switch the TV Off	10	Appendix A: PC Input Typical Display Modes.....	27
Input Selection.....	10	Appendix B: AV and HDMI Signal Compatibility	
Basic Operations	11	(Input Signal Types).....	28
Operation with the Buttons on the TV	11	Specifications	29
Initial Settings	11	Important Instruction.....	30
General Operation.....	12		
Electronic Programme Guide (EPG)	12		
Displaying Subtitles	12		
Digital Teletext (** for UK only)	12		
Analogue Teletext	13		
Widescreen.....	13		

Accessories



Remote Controller

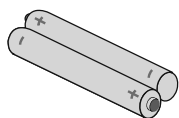

Batteries: 2 X AAA

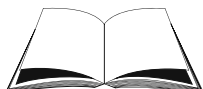

Instruction Book

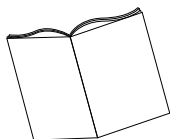

Quick Guide



Cable Holder

Features

- Remote controlled colour LCD TV.
- Fully integrated digital TV (DVB-T).
- HDMI connectors for digital video and audio. This connection is also designed to accept high definition signals.
- 200 programmes from VHF, UHF(analogue).
- 500 programmes for digital mode (IDTV).
- OSD menu system.
- SCART socket for external devices (such as video, video games, audio set, etc.).
- Stereo sound system.
- Teletext, fastext, TOP text.
- Headphone connection.
- Automatic programming system.
- Forward or backward manual tuning.
- Sleep timer.
- Child lock.
- Automatic sound muting when no transmission.
- NTSC playback.
- AVL (Automatic Volume Limiting).
- When no valid signal is detected, after 5 minutes the TV switches automatically to standby mode.
- PLL (Frequency Search).
- PC input.
- Plug&Play for Windows 98,ME,2000,XP, Vista, Windows7.
- Game Mode

Introduction

Thank you for choosing this product. This manual will guide you for the proper operation of your TV. Before operating the TV, please read this manual thoroughly.

Please do keep this manual in a safe place for future references.



Preparation

For ventilation, leave a free space of at least 10 cm all around the set. To prevent any fault and unsafe situations, please do not place any objects on top of the set.

Use this device in moderate climates.

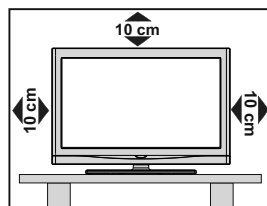

Safety Precautions

Please read the following recommended safety precautions carefully for your safety.

Power Source

The main power supply for this TV is controlled by inserting or removing the power plug.

The TV set should be operated only from a 220-240 V AC, 50 Hz outlet. Ensure that you select the correct voltage setting for your convenience.

Power Cord

Do not place the set, a piece of furniture, etc. on the power cord (mains lead) or pinch the cord. Handle the power cord by the plug. Do not unplug the appliance by pulling from the power cord and never touch the power cord with wet hands as this could cause a short circuit or electric shock. Never make a knot in the cord or tie it with other cords. The power cords should be placed in such a way that they are not likely to be stepped on. A damaged power cord can cause fire or give you an electric shock. When it is damaged and needs to be replaced, it should be done by qualified personnel.

Make enough room for inserting and removing the power plug.

Place the TV as close to the outlet as possible.

Moisture and Water

Do not use this device in a humid and damp place (avoid the bathroom, the sink in the kitchen, and near the washing machine). Do not expose this device to rain or water, as this may be dangerous and do not place objects filled with liquids, such as flower vases, on top. Avoid from dripping or splashing.



If any solid object or liquid falls into the cabinet, unplug the TV and have it checked by qualified personnel before operating it any further.

Cleaning

Before cleaning, unplug the TV set from the wall outlet. Do not use liquid or aerosol cleaners. Use soft and dry cloth.



Ventilation

The slots and openings on the TV set are intended for ventilation and to ensure reliable operation. To prevent overheating, these openings must not be blocked or covered in anyway.

Heat and Flames

The set should not be placed near to open flames and sources of intense heat such as an electric heater. Ensure that no open



flame sources, such as lighted candles, are placed on top of the TV.

Warning

To prevent the spread of fire, keep candles or other open flames away from this product at all times.

Lightning

In case of storm and lightning or when going on holiday, disconnect the power cord from the wall outlet.

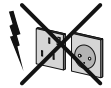

Replacement Parts

When replacement parts are required, make sure that the service technician has used replacement parts, which are specified by the manufacturer or have the same specifications as the original one. Unauthorized substitutions may result in fire, electrical shock or other hazards.

Servicing

Please refer all servicing to qualified personnel. Do not remove the cover yourself as this may result in an electric shock.



Waste Disposal

Instructions for waste disposal:

- Packaging and packaging aids are recyclable and should principally be recycled. Packaging materials, such as foil bag, must be kept away from children.
- Batteries, including those which are heavy metal-free, should not be disposed of with household waste. Please dispose of used battery in an environment friendly manner. Find out about the legal regulations which apply in your area.
- Cold cathode fluorescent lamp in LCD PANEL contains a small amount of mercury; please follow the local laws or regulations for disposal.

Disconnecting the Device

The mains plug is used to disconnect TV set from the mains and therefore it must remain readily operable.

Headphone Volume

Excessive sound pressure from earphones and headphones can cause hearing loss.



Installation

To prevent injury, this device must be securely attached to the wall in accordance with the installation instructions when mounted to the wall (if the option is available).

LCD Screen

The LCD panel is a very high technology product with about a million thin film transistors, giving you fine picture details. Occasionally, a few non-active pixels

may appear on the screen as a fixed blue, green or red point. Please note that this does not affect the performance of your product.

Warning

Do not leave your TV in standby or operating mode when you leave your house.

Inserting Batteries into the Remote Control Handset

- Remove the battery cover located on the back of the handset by gently pulling backwards from the indicated part.
- Insert two **AAA/R3** or equivalent type batteries inside. Place the batteries in the right directions and replace the battery cover.

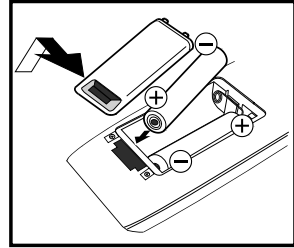

Note: Remove the battery from remote control handset when it is not to be used for a long period. Otherwise it can be damaged due to any leakage of batteries.

Batteries should not be exposed to excessive heat such as sunshine, fire or the like.

Operating Range for the Remote Control

- Point the top of the remote control toward the LCD TV's remote sensor LED while pressing a button.



Remote range is approximately 7m/23ft.

Overview of the Remote Control

1. **TV/DTV:** TV – Digital TV
2. **OK:** OK / Confirm / Freezing Picture(in analogue mode) / Channel list (in DTV mode)
3. **◀:** Cursor left
4. **MENU:** Menu on-off
5. **ZOOM:** Image size
6. **RED:** Sound menu / Page Up (**) (in DTV mode)
7. **GREEN:** Picture Menu / Page Down (**) (in DTV mode)
8. **AV:** Source selection
9. **P / P̂:** Programme up / down
10. **i:** Info
11. **☰:** Index Page (in TXT mode)
12. **⏏:** Expand (in TXT mode)
13. **⏏:** Hold (in TXT mode)
14. **TV/RADIO:** Switches between TV and radio broadcasts.(in DTV mode)
15. **⏻/⏻:** Standby
16. **GUIDE:** Programme guide
17. **▲:** Cursor up
18. **▶:** Cursor right
19. **BACK:** Return
20. **▼:** Cursor down
21. **⏪:** Jump to now (in EPG mode)
22. **BLUE:** Install Menu / Favourite Mode (in DTV mode) (*)
23. **YELLOW:** Feature Menu / Current Language (in DTV mode) (*)
24. **◀ / ▶:** Volume up / down
25. **⏻:** Muting
26. 0,1...8,9 :Numeric buttons.
27. **☰:** Teletext on / PAT (Picture-and-text) / Teletext off
28. **?** Reveal
29. **⌚:** Time (in analogue mode)
30. **⋮:** Subtitle on-off
31. **Ⓛ/Ⓛ:** Mono-stereo / Dual I-II



(*) for EU countries only

(**) Scrolls page up or down in DTV Channel list.

LCD TV and Operating Buttons

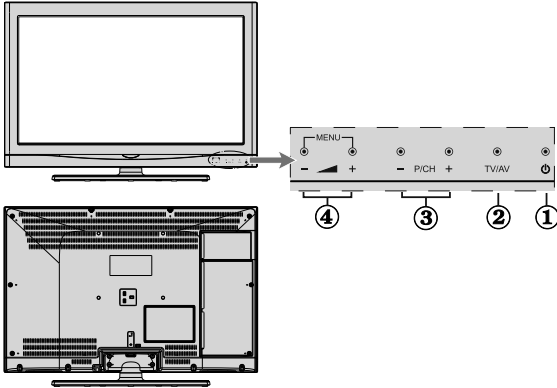
FRONT and REAR VIEW	Control Buttons
	<ol style="list-style-type: none"> 1. Standby button 2. TV/AV button 3. Programme Up/Down buttons 4. Volume Up/Down buttons <p>Note: Press “▲ +” / “- ▼” buttons at the same time to view main menu.</p>

Viewing the Connections- Back Connectors

1. SCART socket inputs or outputs for external devices.
Connect the SCART cable between SCART socket on TV and SCART socket on your external device (such as a decoder, a VCR or a DVD player).
Note: If an external device is connected via the SCART socket, the TV will automatically switch to AV mode.
Note: S-VHS VCR should be connected to EXT-1 and can be watched from EXT-1S source.
2. PC Input is for connecting a personal computer to the TV set. Connect the PC cable between the PC INPUT on the TV and the PC output on your PC. Please do not connect a device to YPbPr socket while using PC input..
3. **SPDIF Coaxial Out** outputs digital audio signals of the currently watched source.
4. RF Input connects to an antenna or a cable.
Note that if you use a decoder or a media recorder, you should connect the aerial cable through the device to the television with an appropriate antenna cable, as shown in the illustration in the following pages.
5. **HDMI 2:** HDMI input
6. **HDMI 1:** HDMI input
HDMI Input is for connecting a device that has an **HDMI™** connector.
Your LCD Television is capable of displaying High Definition pictures from devices such as a High Definition Satellite Receiver or DVD Player. These devices must be connected via the **HDMI™** connector or Component Socket. These sockets can accept either 480i, 480p, 576p, 576i, 720p, 1080i, 1080p signals. No sound connection is needed for an HDMI to HDMI connection.

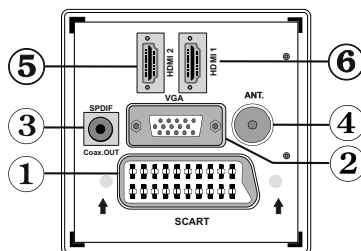

When you use the wall mount kit (optional) with the LCD TV, we would definitely recommend to plug all your cables into the back of the LCD before mounting to the wall.

Viewing the Connections - Side Connectors

1. CI Slot is used for inserting a CI card. A CI card allows you to view all the channels that you subscribe to. For more information, see "Conditional Access" section.

2. **Component Video Inputs (YPbPr)** are used for connecting component video. You can connect the component video and audio sockets with a device that has component output. Connect the component video cables between the **COMPONENT VIDEO INPUTS** on the

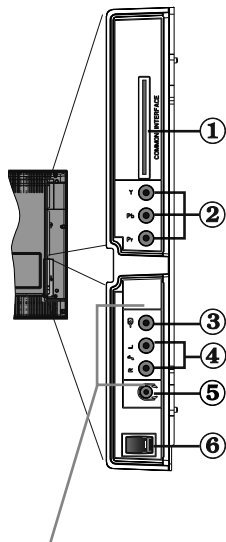

INPUT AV

TV and the component video outputs of your device. While connecting, be sure that the letters on your TV, "Y", "Pb", "Pr" correspond with your device's connectors. **IMPORTANT:** Please do not connect a device to PC socket while using YPbPr input.

3. Video Input (INPUT FAV) is used for connecting video signals of external devices. Connect the video cable between the VIDEO IN socket on the TV and the VIDEO OUT jack on your device.

4. Audio Inputs (INPUT FAV) are used for connecting audio signals of external devices. Connect the audio cable between the AUDIO INPUTS on the TV and the AUDIO OUTPUT jacks on your device. Also to enable **PC/YPbPr** sound connection in such a case, use an appropriate audio cable between the connected device's audio outputs and the TV's audio inputs

Note: If you connect a device to the TV via the VIDEO or PC/YPbPr cable you should also connect your device with an audio cable to the AUDIO INPUTS of the TV to enable audio.

5. Headphone jack is used for connecting an external headphone to the system. Connect to the HEADPHONE jack to listen to the TV from headphones.
6. Standby switch is used for turning the TV on or off.

Using the Cable Holder

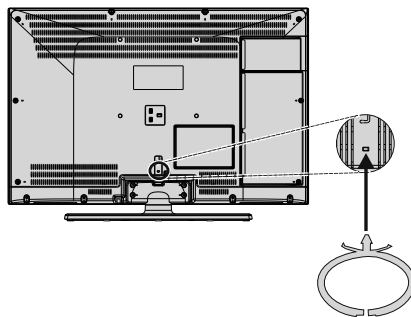

You can use the supplied cable holder as the following:

- Place the cable holder into the cable holder hole located on the rear side of the TV as illustrated above.
- Place cables into the cable holder after all necessary connections are made.

Power Connection

IMPORTANT: The TV set is designed to operate on 220-240V AC, 50 Hz.

- After unpacking, allow the TV set to reach the ambient room temperature before you connect the set to the mains.
- Plug the power cable to the mains socket outlet.

Aerial Connection

- Connect the aerial or cable TV plug to the AERIAL INPUT socket located at the rear of the TV.

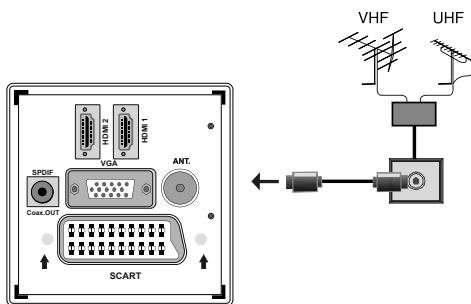

Connecting the LCD TV to a PC

For displaying your computer's screen image on your LCD TV, you can connect your computer to the TV set.

- Power off both computer and display before making any connections.
- Use 15-pin D-sub display cable to connect a PC to the LCD TV. Use an audio cable between audio inputs of the TV (side) and audio output of your PC to enable sound connection.
- When the connection is made, switch to PC source. See "Input selection" section.
- Set the resolution that suits your viewing requirements. Resolution information can be found in the appendix parts.

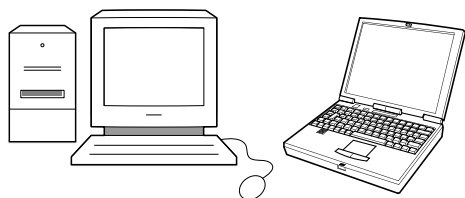
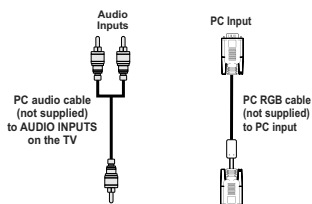
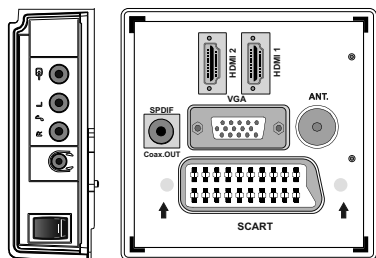

Connecting to a DVD Player

If you want to connect a DVD player to your LCD TV, you can use connectors of the TV set. DVD players may have different connectors. Please refer to your DVD player's instruction book for additional information. Power off both the TV and the device before making any connections.

Note: Cables shown in the illustration are not supplied.

- If your DVD player has an HDMI socket, you can connect via HDMI. When you connect to DVD player as illustrated below, switch to HDMI source. See, "Input Selection" section.
- Most DVD players are connected through COMPONENT SOCKETS. Use a component video cable to connect video input. To enable sound connection, use AUDIO IN located side of the TV (YPbPr cable is not supplied).
- When the connection is made, switch to YPbPr source. See, "Input selection" section.
- You may also connect through the SCART socket. Use a SCART cable as shown below.

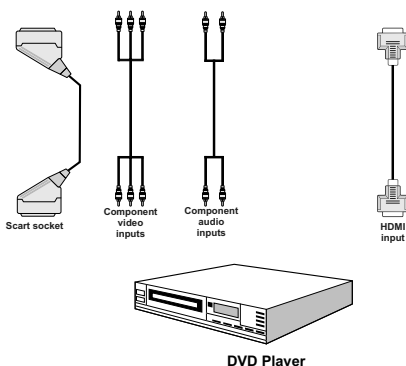

Note: These methods of connection perform the same function but in different levels of quality. It is not necessary to connect by all three methods.

Using Side AV Connectors

You can connect a range of optional equipment to your LCD TV. Possible connections are shown below. Note that cables shown in the illustration are not supplied.

- For connecting a camcorder, connect to the VIDEO IN socket and the AUDIO SOCKETS. For selecting the related source, see the section "Input selection" in the following parts.
- To listen the TV sound from headphones, connect to the HEADPHONE jack of the TV

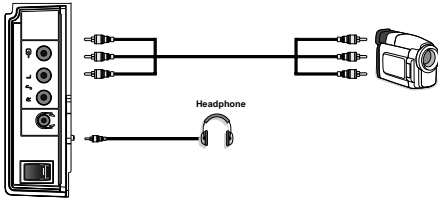

Connecting Other Equipment via SCART

Most devices support SCART connection. You can connect a DVD recorder, a VCR or a decoder to your LCD TV by using the SCART socket. Note that cables shown in the illustration are not supplied. Power off both the TV and the devices before making any connections.

For more information, refer to your device's own instruction book.

Note: S-VHS VCR should be connected to EXT-1 and can be watched from EXT-1S source.

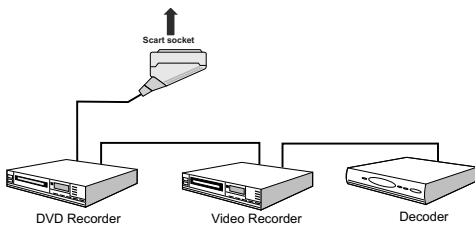

Switching the TV On/Off

To Switch the TV On

- Connect the power cord to the 220-240V AC 50 Hz.
- Switch the "I" button to position "I" so the TV will switch to standby mode.
- To switch on the TV from standby mode either:
 - Press the "I/O" button, \uparrow / \downarrow or a numeric button on the remote control.
 - Press the \downarrow P/CH or P/CH button on the TV.

The TV will then switch on and the standby LED lights up.

Note: If you switch on your TV via PROGRAMME UP/DOWN buttons on the remote control or on the TV set, the programme that you were watching last will be reselected.

By either method the TV will switch on and the standby LED lights up.

To Switch the TV Off

- Switch the "I" button to position 2 as illustrated, $\text{I} \text{ 1}$ so the TV will switch OFF.
- To power down the TV completely, unplug the power cord from the mains socket.

Note: When the TV is switched to standby mode, standby LED can blink to indicate that features such as Standby Search, Over Air Download or Timer is active.

Input Selection

Once you have connected external systems to your TV, you can switch to different input sources.

- Press "AV" button on your remote control for directly changing sources.

or

- Select "Source" option from the main menu by using " \leftarrow " or " \rightarrow " button. Use then " ∇ " or " \blacktriangle " button to highlight an input and press " \rightarrow " button to select.

Note: You can mark desired source options by pressing the OK button. Therefore, when "AV" button is pressed, only the marked source options will be available (except for the TV source).



Basic Operations

You can operate your TV using both the remote control and onset buttons.

Operation with the Buttons on the TV

Volume Setting

- Press “ ” button to decrease volume or “ ” button to increase volume, so a volume level scale (slider) will be displayed on the screen.

Programme Selection

- Press “ ” button to select the next programme or “ ” button to select the previous programme.

Viewing Main Menu

- Press “ ” / “ ” buttons at the same time to view main menu. In the Main menu select sub-menu using “ ” or “ ” buttons and enter the sub-menu using “ ” or “ ” buttons. To learn the usage of the menus, refer to the menu system sections.

AV Mode

- Press the “TV/AV” button in the control panel on the TV to switch between AV modes.

Operation with the Remote Control

- The remote control of your TV is designed to control all the functions of the model you selected. The functions will be described in accordance with the menu system of your TV.
- Functions of the menu system are described in the following sections.

Volume Setting

- Press “ ” button to increase the volume. Press “ ” button to decrease the volume. A volume level scale (slider) will be displayed on the screen.

Programme Selection (Previous or Next Programme)

- Press “ ” button to select the previous programme.
- Press “ ” button to select the next programme.

Programme Selection (Direct Access)

- Press numeric buttons on the remote control to select programmes between 0 and 9. The TV will switch to the selected programme. To select programmes between 10-500 (for IDTV) or 10-199 (for analogue), press the numeric buttons consecutively
- Press directly the programme number to reselect single digit programmes

Initial Settings

When the TV is turned on for the first time, the menu for the language selection appears on the screen. The message “Welcome please select your language!” is displayed in all language options sequentially in the OSD.

By pressing the “ ” or “ ” buttons highlight the language you want to set and press OK button. After then, “First time installation” OSD will appear on the screen. By pressing “ ” or “ ” buttons, select the country you want to set and press OK button (* for EU countries).



Note: Country selection OSD will not be available for UK.

Press OK button on the remote control to continue and the following message will be displayed on the screen:

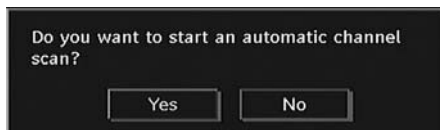

- To select the “Yes” or “No” option, highlight the item by using “ ” or “ ” buttons and press the “OK” button.

The IDTV will automatically tune to the UHF or VHF(*) (* for EU countries) transmission channels, searching for digital terrestrial TV broadcasts and displaying the names of channels found. This process will take about a few minutes.



After Automatic Search is completed, the following message asking for analogue channel search appears on the screen:

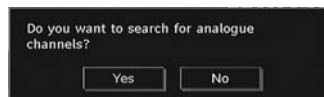

To search for analogue channels, select “Yes”. TV switches to the analogue TV mode. The menu is displayed to search for analogue channels.

Select your Country, Language and Text language by using “◀” or “▶” and “▼” or “▲” buttons. Press **OK** or **RED** button to continue. To cancel, press the **BLUE** button.

For more information on this process, see “Install Menu” section.

Note: For proper functioning of digital teletext in DTV mode, you should set country as UK in analogue AUTO PROGRAM (for UK broadcasts only).

Do not turn off the TV while initializing first time installation.

General Operation

Press the “**TV/DTV**” button on the remote control and select DTV to switch the TV set to digital terrestrial television broadcasting.

Information Banner

- Whenever you change the channel using the **↑** / **↓** button or numeric buttons, the TV displays the broadcast picture along with an information banner at the bottom of the screen. This will remain on the screen for approximately a few seconds.
- The information banner can also be displayed by pressing the **(i)** button at any time while watching the TV. Pressing **(i)** button again removes the banner.



If the selected channel is locked, you must enter the correct four numeric code to view the channel. “Enter PIN” will be displayed on the screen in such a case:

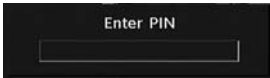

Electronic Programme Guide (EPG)

- Some, but not all, channels send information about the current and next events. Press **GUIDE** button to view the EPG menu. EPG appears on the screen. It is able to get Information of the channel - programs weekly by means of 7-DAY-EPG. All programs of channels are displayed. On the bottom of the screen; info bar, showing all the available commands, will be displayed.



RED button (Shrink): makes the info boxes smaller.

GREEN button (Expand): makes the info boxes larger.

YELLOW button (Prev. Day): displays the programmes of previous day.

BLUE button (Next day): displays the programmes of the next day.

(i) (Details): displays the programmes in detail.

Numeric buttons (Jump): go to preferred channel directly via numeric buttons.

OK : view for current broadcast/reminders for future programs.

(↔) : jumps to the current broadcast.

- Press “**0**” button on the remote control to view Guide Search menu. Using this feature, you can search the programme guide database in accordance with the genre selected or with name match.

Displaying Subtitles

With digital terrestrial broadcasting (DVB-T), some programmes are being broadcasted with subtitles.

Press the “**MENU**” button to display the main menu, highlight the **Setup** and then **Language** menu using “**▼**” or “**▲**” button and press the **OK** button to display the “Language settings” menu.

Highlight the “Subtitle” item in “Language settings” menu and use “**◀**” or “**▶**” button to set Subtitle to the desired language.

If “**Subtitle**” is on and a language option is set, pressing the “**(≡)**” button causes the following warning message display on the screen (** for UK only):

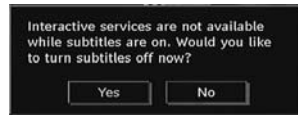

Digital Teletext (** for UK only)

- Press the “**(≡)**” button.
- The digital teletext information appears.
- Operate it with the coloured buttons, cursor buttons and **OK** button.

The operation method may differ depending on the contents of the digital teletext.

Follow the instructions displayed on digital teletext screen.

- When Press “**OK**” button or similar message appears on the screen, press the **OK** button.
- When the “**(≡)**” button is pressed, the TV returns to television broadcasting.
- With digital terrestrial broadcasting (DVB-T), in addition to digital teletext broadcasting together with the normal broadcasting, there are also channels with just digital teletext broadcasting.

- The aspect ratio (picture shape) when watching a channel with just digital teletext broadcasting is the same as the aspect ratio of the picture viewed previously.
- When you press the “” button again, the digital teletext screen will be displayed.

Analogue Teletext

Use of teletext and its functions are identical to the analogue text system. Please do refer to the “**TELETEXT**” explanations.

Widescreen

Depending on the type of the broadcast being transmitted, programmes can be viewed in a number of formats. Press the “**ZOOM**” button repeatedly to change screen format.

When Auto is selected, the format being displayed is determined by the picture being broadcasted.

PLEASE NOTE: Menu size changes depending on the chosen image size.

Notice !

If there is no audio available, the following warning message will be displayed on the screen:.





IDTV Menu System

The IDTV menu can only be viewed when watching digital terrestrial broadcasting. Press the “**TV/DTV**” button to turn IDTV on while the TV is in analogue mode. Press the “**MENU**” button. The menu below appears on the screen:





You can press **MENU** button again to exit main menu.





Channel List

Using the “” or “” button on the remote control, make sure that the first item, Channel List, is highlighted and press the “**OK**” button to display the Channel List.







Navigating the Entire Channel List

Press “” or “” button for selecting the previous or next channel. You can press “**RED**” or “**GREEN**” button to move page up or page down.

To watch a specific channel, highlight it using “” or “” button and then press “**OK**” button, while the “**Select**” item on Channel List menu is highlighted by using “” or “” button.

Then the name and number of the selected channel will be displayed in the top-left and top-right of the channel display at the top-right of the screen, respectively.

Moving the channels in the channel list

- Press “” or “” buttons to select the channel that will be moved.
- Press “” or “” buttons to select the “**Move**” item on Channel List menu.

Following OSD will be displayed next to “**OK**” item to indicate that enter a number by using the numeric

buttons on the remote control and press **“OK”** to confirm.



Note: If you enter the same programme number of the channel that you want to move, "... channel services will be replaced. Do you want to continue?" OSD will be displayed. Press OK to confirm or select "No" to cancel.

Deleting the Channels in the Channel List

- Press **“▼”** or **“▲”** button to select the channel that will be deleted.
- Press **“◀”** or **“▶”** button to select the **“Delete”** item on Channel List menu.
- Press the **“OK”** button to delete the highlighted channel in the channel list. Then the message below appears on the screen:



- Press **“◀”** or **“▶”** button to highlight the desired option. If **“OK”** button is pressed while **“Yes”** is highlighted, the highlighted channel is deleted. Selecting **“No”** cancels the deletion.

Renaming Channels

To rename a specific channel, the channel must be highlighted by pressing **“▼”** or **“▲”** button. Then highlight the **Edit Name** item by pressing **“◀”** or **“▶”** button as illustrated below. Press the **“OK”** button to activate the rename feature.



Now pressing **“◀”** or **“▶”** button moves to the previous/next character. Pressing **“▼”** or **“▲”** button toggles the current character, i.e., 'b' character becomes 'a' by **“▼”** and 'c' by **“▲”**. Pressing the numeric buttons '0...9' replaces the highlighted character with the characters printed above the button one by one as the button is pressed.

Press the **“MENU”** button to cancel the editing or OK button to save the new name.

Adding Locks to Channels

Channel locking provides a password-protected access to channels selected by parents. In order to lock a channel you should know the parental lock password (default value is set to 0000 in the factory and can only be changed from the Configuration menu).

Select the channel to be locked by highlighting it and select the Lock option by pressing **“◀”** or **“▶”** button. When the **“OK”** button is pressed, a dialog OSD asking for the password will be displayed.



Enter the password by using the numeric buttons on the remote control. The lock icon **“🔒”** will now be displayed next to the selected channel. Repeat the same operation to cancel the lock.

Setting Favourites

To set a favourite you should highlight the **“Favourites”** item at the bottom of the Channel List menu. Then press **“OK”** button and Edit Favourite List menu appears on the screen.

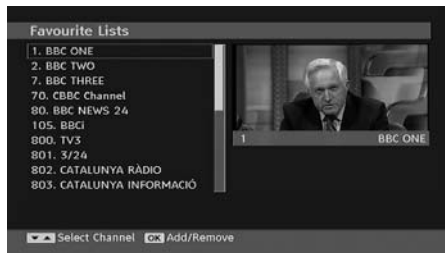

How to Add a Channel to a Favourites List

- By pressing **“▼”** or **“▲”** buttons, highlight the channel that you want to add to the favourite list.

- By pressing “**OK**” button, the highlighted channel is added to the Favourite List.
- F icon indicates that a channel is added to Favourite List.

Removing a Channel from Favourite List

- Highlight the channel that you want to remove from the favourite list and press OK button to remove. You can press “**OK**” button again to re-add a channel.
- To activate Favourites, go to the Configuration menu and select Favourite mode. Use “**◀** / “**▶**” to set Favourite mode as on. To cancel Favourites, set Favourite Mode to Off.

On Screen Help

For all menus, press the **(i)** button to display the help information about the menu functions.

Press the OK button on your remote control to edit your Favourite Lists. The favourite list mode can be selected in the Configuration menu.

Program Guide

This section is same with the instructions given in the General Operations page. Please see Electronic Programme Guide (EPG) section in the General Operations part.

Timers

Timers			Thu 07/06 22:37
Name	Start	Length	
BBC ONE	07/06/07 22:42	1h 0m	

Delete Edit Add

To display timers window, activate the item from the main menu. To add a timer, press the **YELLOW** button on the remote control. Then “Add Timer” window appears.

Channel: “**◀**” or “**▶**” keys will navigate the user through the TV or Radio list.

Date: Starting date is entered via the Left/Right or the numeric buttons.

Start: Starting time is entered via the Left/Right or the numeric buttons.

End: Ending time is entered via the Left/Right or the numeric buttons.

Change/Delete: permits or prohibits any modifications for other users.

Duration: Duration between Start and End time.

Repeat: You can set a timer to be repeated as Once, Daily or Weekly.

You can save the adjustments by pressing the **GREEN** key or cancel the process by pressing the **RED** button. You can edit the list via **GREEN** key and delete with the **RED** button.

Conditional Access

- Press the “**MENU**” button to display the main menu and use the “**▼**” or “**▲**” button to highlight the “Conditional Access” line and press the “**OK**” button:

Conditional Access

Some Digital Terrestrial channels operate on a Pay Per View basis. These require a subscription and a hardware decoder.

Obtain the Conditional Access Module (CAM) and the viewing card by subscribing to a pay channel company, then insert those to the TV using the following procedure.

- Switch off the TV and unplug from the mains.
- The CAM should be correctly inserted, it is impossible to insert fully if reversed. The CAM or the TV terminal may be damaged if the CAM is forcefully inserted.
- Connect the TV to the mains supply, switch on and then wait for few moments until the card is activated.
- Some CAMs may require the following set up. Please set the CAM by entering the IDTV menu, Conditional Access then pressing the “**OK**” button. (CAM set up menu is not displayed when it is not required.)
- To see the viewing contract information: enter IDTV; press the “**MENU**” button, then highlight Conditional Access and press the “**OK**” button.
- When no module is inserted, “No Conditional Access module detected” message appears on the screen.
- Refer to the module instruction manual for details of the settings.

Note: Insert or remove the CI module only when the TV is switched off or in standby mode.

TV Setup

You can use this item to display the TV functions.

The digital TV Setup menu screen is accessed from the main menu. Press the “**MENU**” button to display the main menu and use “**▼**” or “**▲**” button to highlight “TV Setup”, press the “**OK**” button to display TV Setup menu screen.

TV Setup

You can find detailed information for all menu items in “Analogue TV Menu System” section.

Setup

The adjustments in this menu are given as the following:



Configuration

You can configure the settings of your TV. Select Configuration from Setup menu and press "OK" to view this menu. Press the "BACK" button on the remote control to exit.



Dolby D Audio (* for EU countries only)

In the Configuration Menu, highlight the Dolby D item by pressing "▲" or "▼" buttons. Use the "◀" or "▶" buttons to set the Dolby D Digital as On or Off. If the channel that you are watching supports Dolby Digital, you can turn this setting on.

Hard of Hearing (* for EU countries only)

Use "▼" or "▲" button to select Hard of Hearing and then press "◀" or "▶" button to set this setting as On or Off.

If the broadcaster enables any special signal concerning the audio, you can set this setting as On to receive such signals.

Favourite Mode

Use this function to enable or disable favourite mode. Press "◀" / "▶" button to set this function as on or off.

Channel List

Use "▼" or "▲" buttons to go to Channel List option. Use "◀" or "▶" buttons to toggle Channel List Mode. If you select "TV Only", with the "◀" or "▶" buttons, you navigate through only TV channels. If you select "Radio Only", with the "◀" or "▶" buttons, you navigate through only radio channels. If you select "Text Only", with the "◀" or "▶" buttons, you navigate through only text channels.

Scan Encrypted

Scan Encrypted Channel feature will always be ON after performing first time installation. When this setting is on, search process will locate the encrypted channels as well. If it is set as OFF manually, encrypted

channels will not be located while in automatic search or manual search.

Use "▼" or "▲" button to select Scan Encrypted and then press "◀" or "▶" button to set this setting as On or Off.

Software Version

Over Air Download (OAD)

This feature helps to keep your TV updated. It works automatically and searches for new information when available. Note that this setting is inactive to be modified. Please ensure that the TV is set to standby mode. The TV automatically powers up at 3.00 A.M. each day and searches for any new information which may be broadcasted and will download this to your receiver automatically. This operation will normally take approximately 30 minutes.

Note: Your TV may start in First Time Installation mode after OAD update.

Parental Control

Use "▼" or "▲" buttons to go to Parental Lock option. Press OK button to enter the menu. A dialog box asking for the lock key will be displayed. The key is set to "0000" initially. Enter PIN. If it is incorrect, "Wrong Pin" OSD will be displayed. If it is correct, the Parental Control menu will be displayed:



Maturity Lock (*)

(*) If you set Country option as UK in the first time installation, Maturity Lock option will not be visible. This setting is available only for EU countries.

When set, this option gets the maturity information from the broadcast and if this maturity level is disabled, does not show video-audio.

Menu Lock

In menu lock you can set locking for all menus, or the Installation Menu to restrict access to these menus. If the menu lock is disabled, there will be free access to the menu system. Use "▼" or "▲" buttons to go to Menu Lock option. Use "◀" or "▶" buttons to choose Menu Lock Mode.

DISABLED : All menus are unlocked.

ALL MENUS : All Menus are accessible only with the correct lock key. So the user cannot add, delete, rename, channels, cannot set timers.

INSTALLATION MENU: Installation menu is locked. So the user can't add channels. Changes will be updated after exiting 'Configuration Menu'.

Set PIN

Use “▼” or “▲” buttons to go to “Set PIN” option. Press “OK” to display the “Set PIN” window. Use numeric buttons to enter new pin number you will need to input your new pin a second time for verification purposes. The factory default pin number is 0000, if you change the pin number make sure you write it down and keep it safe.

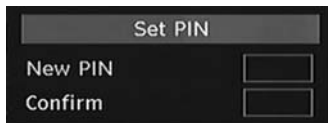

Time Settings (* for EU countries only)

In the configuration menu, highlight the Time Settings item by pressing “▲” or “▼” buttons.

Press “OK” and Time Settings sub menu will be displayed on the screen. Current Time, Time Zone Setting and Time Zone will be available.

Use “▲” or “▼” buttons to highlight the Time Zone Setting. Time Zone Setting is set using “◀” or “▶” buttons. It can be set to AUTO or MANUAL.

When AUTO is selected, Current Time and Time Zone options will not be available to be set. If MANUAL option is selected as the Time Zone Setting, Time Zone can be altered:

- By pressing “▲” or “▼” buttons select Time Zone.
- Use “◀” or “▶” buttons to change the Time Zone between GMT-12 or GMT+12. Current Time on the top of the menu list will then change according to the selected Time Zone.

Audio Description

Audio description refers to an additional narration track for blind and visually impaired viewers of visual media, including television and movies. The description narrator talks through the presentation, describing what is happening on the screen during the natural pauses in the audio (and sometimes during dialogue, if deemed necessary). You can use this feature, only if the broadcaster supports that additional narration track. Use “▼” or “▲” buttons to select an item. Then use “◀” or “▶” buttons to set.

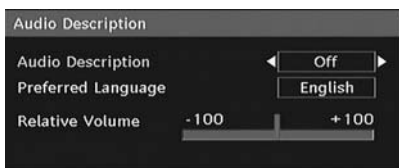

Audio Description

This function enables or disables the audio description feature by pressing the “◀” or “▶” buttons.

Preferred Language

By pressing the “◀” or “▶” buttons the preferred audio description language is being changed.

This setting can be used, only if it is available.

Relative Volume

Using this option, the Audio Description volume level can be increased or decreased relatively, according to the general volume.

Standby Search

Use “▼” or “▲” button to select Standby Search and then press “◀” or “▶” button to set this setting as On or Off. If you change Standby Search to Off, this function will be unavailable.

To use Standby search please make sure that you select Standby Search as On.

Language

In this menu the user can adjust the preferred language. Language is changed by pressing “OK” button.



Menu: shows the language of the system

Preferred

These settings will be used if available. Otherwise the current settings will be used.

- **Audio:** by pressing “◀” or “▶” keys change the audio language.
- **Subtitle:** alter the subtitle language with “◀” or “▶” keys. The chosen language will be seen in subtitles.
- **Guide:** By pressing “◀” or “▶” buttons change the guide language.

Current

- **Audio:** if audio language is supported change the audio language by pressing “◀” or “▶” buttons

- **Subtitle:** if subtitle is backed up, alter the subtitle language with “◀” or “▶” buttons. The chosen language will be seen in subtitles.

Note: If the Country option is set to Denmark, Sweden, Norway or Finland, the Language Settings menu will function as described below:

Language Settings



In the configuration menu, highlight the Language Settings item by pressing “▼” or “▲” buttons. Press “OK” and Language Settings submenu will be displayed on the screen:

Use “▼” or “▲” buttons to highlight the menu item that will be adjusted and then press “◀” or “▶” button to set.

Notes:

- System Language determines the on-screen menu language.
- Audio Language is used for selecting the soundtrack of a channels.
- Primary settings are the first priority when multiple choices are available on a broadcast. Secondary settings are the alternatives when the first options are not available.

Installation

The Installation menu is mainly intended to help you for creating a Channel Table in the most efficient way. Select Installation from the Configuration menu by pressing “▼” or “▲” buttons.

This menu includes the following items:

(*) For Denmark, Sweden, Norway or Finland.

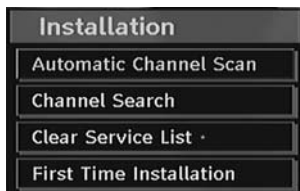

Automatic Channel Scan

Automatic channel scan is started by pressing “OK” button while Automatic channel scan item is highlighted.

The following message appears on the screen:



Highlight Yes or No by using “◀” or “▶” buttons and press “OK” button to confirm.

If Yes is selected, automatic search starts.

Selecting No cancels automatic search.

After search is completed for digital channels, a message asking whether to search for analogue channels appears on the screen:

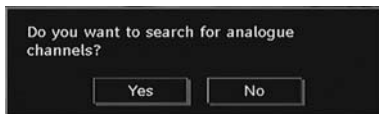

Press the “OK” button to search for analogue channels. The following menu appears on the screen for analogue channel search:

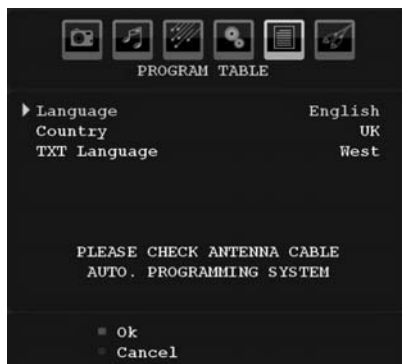

Select your **Country**, **Language** and **Text language** by using “▼” or “▲” and “◀” or “▶” buttons. Press “OK” or **RED** button to continue. To cancel, press **BLUE** button. The following menu will be displayed during the automatic tuning:

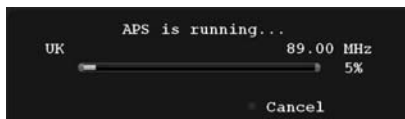

After APS is finalized, the programme table will appear on the screen. In the programme table you will see the programme numbers and names assigned to the programmes.

Manual Channel Scan

In manual channel scan, the number of the multiplex is entered manually and only that multiplex is searched

for the channels. For each valid channel number, signal level and signal quality are shown on the screen.

In both manual and auto search any existing channel in the database is not re-stored to avoid redundant duplicates of that channel.

Clear Service List (*)

(*) This setting is visible only when the Country option is set to Denmark, Sweden, Norway or Finland.

Use this setting to clear channels stored. Press "▼" or "▲" button to select Clear Service List and then press OK. The following OSD message will be displayed on the screen:

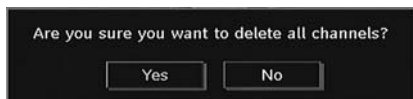

Press OK to cancel. Select Yes by pressing "◀" or "▶" button and press OK to delete all of the channels.

First Time Installation

The user can use this item to load default settings, which were loaded to the receiver at the factory.

To install factory settings, highlight "First Time Installation" menu item and press "OK" button, then you will be asked whether or not to delete the settings. Selecting "Yes" by pressing "OK" button while the "Yes" is highlighted will delete the existing channel table.

Then you will be asked to confirm for deleting all channels and settings:

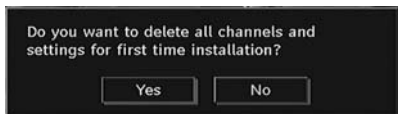

By selecting Yes and pressing the "OK" button, the existing channel table will be deleted. After factory settings are loaded, "First Time Installation" menu will be displayed.

The menu which is displayed for language selection appears on the screen at first. By using "▼" or "▲" buttons, select the desired language option, and press OK button to activate.

After then, "First time installation" OSD will appear on the screen. By pressing "◀" or "▶" buttons, select the **Country** you want to set and press "OK" button (* only for EU countries).

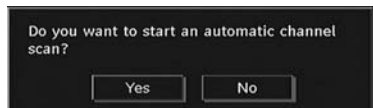

Press the "OK" button to start installation. After search is completed for digital channels, a message asking whether to search for analogue channels appears

on the screen. This process is same as described in **Automatic Search** section..

Analogue TV Menu System

Picture Menu



Mode

For your viewing requirements, you can set the related mode option.

Press "▼" or "▲" button to select **Mode**. Press "◀" or "▶" button to choose from one of these options: **Cinema, Dynamic and Natural**.

Brightness/Contrast/Colour/Sharpness/Hue

Press "▼" or "▲" button to select the desired option. Press "◀" or "▶" button to set the level.

Note: *Hue* option can only be visible when the TV receives an NTSC signal.

Colour Temp

Press "▼" or "▲" button to select **Colour Temp**. Press "◀" or "▶" to choose from one of these options: Cool, Normal and Warm.

Note:

- Setting **Cool** option gives white colours a slight blue stress.
- Setting **Warm** option gives white colours a slight red stress.
- For normal colours, select **Normal** option.

Noise Reduction

If the broadcast signal is weak and the picture is noisy, use **Noise Reduction** setting to reduce the noise amount.

Press "▼" or "▲" button to select **Noise Reduction**. Press "◀" or "▶" to choose from one of these options: **Low, Medium, High** or **Off**.

Game Mode

Select **Game Mode** by pressing “▼” or “▲” button. Use “◀” or “▶” button to set Game Mode as **On** or **Off**. When Game Mode is set to On, specific game mode settings, which are optimized for better video quality, will be loaded.

Also; Picture Mode, Contrast, Brightness, Sharpness, Colour and Colour Temp settings will be invisible and disabled while Game Mode is on.

Note:

Picture mode selection button on the remote control will have no function while Game Mode is on.

Picture Zoom

Select **Picture Zoom** by pressing “▼” or “▲” button.

Use “◀” or “▶” buttons, to change picture zoom to **Auto**, **16:9**, **4:3**, **Panoramic**, **14:9**, **Cinema**, **Subtitle** or **Zoom**.

Reset

Press “▼” or “▲” button to select **Reset**. Press “◀” or “▶” or **OK** button to reset the picture modes to factory default settings.

Sound Menu



Volume

Press “▼” or “▲” button to select **Volume**. Press “◀” or “▶” button to change the level of the Volume.

Equalizer

Press “▼” or “▲” button to select **Equalizer**. Press “▶” button to view equalizer menu.

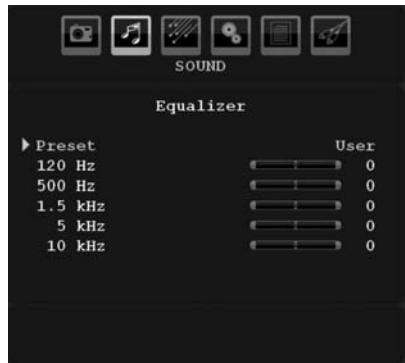

Press “◀” or “▶” button to change the preset. In equalizer menu, the preset can be changed to **Music**, **Movie**, **Speech**, **Flat**, **Classic** and **User**.

Select the desired frequency by pressing “▼” or “▲” button and increase or decrease the frequency gain by pressing “◀” or “▶” button.

Press the “**MENU**” button to return to the previous menu.

*Note: Equalizer menu settings can be changed only when the **Equalizer Mode** is in **User**.*

Balance

This setting is used for emphasizing left or right speaker balance.

Press “▼” or “▲” button to select **Balance**. Press “◀” or “▶” button to change the level of the balance. Balance level can be adjusted between **-32** and **+32**.

Headphone

Press “▼” or “▲” button to select **Headphone**. Press “▶” button to view the headphone menu.

Headphone sub-menu options are described below:

Volume

Press “▼” or “▲” button to select **Volume**. Press “▶” button to increase headphone volume level. Press “◀” button to decrease headphone volume level. Headphone volume level can be adjusted between 0 and 63.

Sound Mode

Press “▼” or “▲” button to select **Sound Mode**. Using “◀” or “▶” button, you can select Mono, Stereo, Dual I or Dual II mode, only if the selected channel supports that mode.

AVL

Automatic Volume Limiting (AVL) function adjusts the sound to obtain fixed output level between programmes (For instance, volume level of advertisements tend to be louder than programmes).

Press “▼” or “▲” button to select **AVL**. Press “◀” or “▶” button to set the AVL as **On** or **Off**.

Feature Menu



Sleep Timer

Press “▼” or “▲” button to select **Sleep Timer**. Use “◀” or “▶” button to set the **Sleep Timer**.

The timer can be programmed between **Off** and **120** minutes in steps of **10** minutes.

If **Sleep Timer** is activated, at the end of the selected time, the TV goes automatically to standby mode.

Child Lock

Press “▼” or “▲” button to select **Child Lock**.

Use “◀” or “▶” button to set the Child Lock **On** or **Off**. When **On** is selected, the TV can only be controlled by the remote control handset. In this case the control panel buttons will not work.

Hence, if one of those buttons is pressed, **Child Lock On** will be displayed on the screen when the menu screen is not visible.

Language

Press “▼” or “▲” button to select **Language**. Use “◀” or “▶” button to select the **Language**.

Default Zoom

While zoom mode is set as **AUTO**, the TV will set the zoom mode in accordance with the signal of the broadcast. If there is no WSS or aspect ratio information, the TV will then use this setting to adopt. Press “▼” or “▲” button to select **Default Zoom**. You can set **Default Zoom** to **Panoramic**, **16:9**, **4:3** or **14:9** by pressing “◀” or “▶” button.

Blue Background

If the signal is weak or absent, the TV will automatically change to a blue screen. To enable this, set **Blue Background** to **On**.

By pressing “▼” or “▲” button, select **Blue Background**. Press “◀” or “▶” button to set **Blue Background** as **On** or **Off**.

Menu Background

Press “▼” or “▲” button to select **Menu Background**. You can set menu background level by pressing “◀” or “▶” button.

Backlight

This setting controls the backlight level. Select **Backlight** by pressing “▼” or “▲” button. Press “◀” or “▶” button to set **Backlight** to **Auto**, **Medium**, **Maximum** or **Minimum**.

Menu Timeout

To set a specific display timeout for menu screens, set a value for this option.

Press “▼” or “▲” button to select **Menu Timeout**. Use “◀” or “▶” button to change menu timeout to **15 sec**, **30 sec** or **60 sec**.

Teletext Language

Press “▼” or “▲” button to select **Teletext Language**. Use “◀” or “▶” button to change **Teletext Language** to **West**, **East**, **Turk/Gre**, **Cyrillic**, **Arabic** or **Persian**.

HDMI PC Full Mode

If you want to view PC screen in HDMI mode by using external connection, **HDMI PC FULL MODE** option should be **On** to adjust the screen ratio correctly. This item might be inactive in some resolutions.

Note: If you connect an HDMI device and switch the TV to HDMI mode, this feature will be visible (for 720P and higher resolutions).

Full Mode (*only for FHD models)

If you connect a device via HDMI or YPbPr connectors and set 1080i/1080P resolutions, Full Mode item will be visible. You can set Full Mode as 1:1 or Normal by using “◀” or “▶”. If you select 1:1, screen ratio will be adjusted correctly. If you set Normal, screen ratio may expand.

Ext Out

Press “▼” or “▲” button to select Ext Out. Use “◀” or “▶” button to set the Ext Out as **On** or **Off**.

Note:

For copying from a DVD or VCR device, you should choose desired source from source menu and turn “On” to EXT Out from feature menu.

Ext Out should be On in order to use Timers function in the DTV mode.

Install Menu



Program

Press “▼” or “▲” button to select Program. Use “◀” or “▶” button to select the program number. You can also enter a number using the numeric buttons on the remote control. There are 200 programme storage between 0 and 199.

Band

Band can be selected either C or S. Press “◀” or “▶” button to set Band.

Channel

Channel can be changed by “◀” or “▶” button or numeric buttons.

Colour System

Press “▼” or “▲” button to select Colour System. Use “◀” or “▶” button to change the colour system to PAL, PAL 60, SECAM or AUTO.

Sound System

Press “▼” or “▲” button to select Sound System. Press “◀” or “▶” button to change the sound system to BG, DK, I, L or L’.

Fine Tune

Press “▼” or “▲” button to select Fine Tune. Press “◀” or “▶” button to adjust the tuning.

Search

Press “▼” or “▲” button to select Search. Use “◀” or “▶” button to start programme searching. You can also enter the desired frequency using the numeric buttons while Search item is highlighted.

Install Menu in AV Modes

The following screen appears in the install menu when the TV is in AV modes. Note that limited options will be available. Switch to TV mode for viewing complete version of the **Install** menu.



Colour System

Press “▼” or “▲” button to select **Colour System**. Use “◀” or “▶” button to change the colour system to **PAL, SECAM, PAL60, AUTO, NTSC 4,43 or NTSC 3,58**.

Program Table

Select **Program Table** by pressing “▼” or “▲” button. Press “▶” to display Program Table:



By moving the cursor in four directions you can reach 20 programmes in the same page. You can scroll the pages up or down by pressing the navigation buttons to see all the programmes in TV mode (except for the AV modes). By cursor action, programme selection is done automatically.

Name

To change the name of a programme, select the programme and press the **RED** button.

The first letter of the selected name will be highlighted. Press “▼” or “▲” button to change that letter and “◀” or “▶” button to select the other letters. By pressing the **RED** button, you can store the name.

Move

Select the programme which you want to move by navigation buttons. Press the **GREEN** button. By navigation buttons move the selected programme to the decided programme space and press the **GREEN** button again.

Delete

To delete a programme, press the **YELLOW** button. Pressing the **YELLOW** button again erases the selected programme from the programme list, and the following programmes shift one line up.

APS (Auto Programming System)

When you press the **BLUE** button for starting automatic tuning, **Auto Programming System** menu will appear on the screen:



Press “▼” or “▲” button to select your country. If you want to exit from A.P.S. function, press the **BLUE** button.

When you press **OK** or **RED** button for starting automatic tuning, all stored programmes will be erased and the TV will search for available channels. During the search, the following OSD will be displayed:

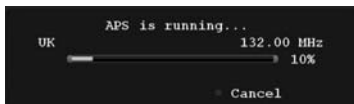

Whenever you press the **BLUE** button, APS function stops and Program Table appears on the screen.

If you wait until the end of APS, Program Table will be displayed with the programmes found and located.

Source Menu

Press “▼” or “▲” button and select the sixth icon. Then press “▶” or “OK” button. Source menu appears on the screen:



In source menu, highlight a source by pressing “▼” or “▲” button and switch to that mode by pressing “▶” button. Source options are; **TV, DTV, EXT-1, EXT-1 S, FAV, HDMI-1, HDMI-2, YPbPr and PC-VGA.**

Note: Once you have connected optional equipment systems to your TV, you should select the required input to view pictures from that source.

PC Mode Menu System

See “**Connecting the LCD TV to a PC**” section for connecting a PC to the TV set.

For switching to **PC** source, press “**AV**” button on your remote control and select PC input. You can also use “**Source**” menu to switch to **PC** mode.

Note that PC mode menu settings are available only while the TV is in PC source.

PC Position Menu

Select the first icon by pressing “◀” or “▶” button. **PC Position** menu appears on the screen:



Autoposition

If you shift the picture horizontally or vertically to an unwanted position, use this item to put the picture into correct place automatically. This setting therefore automatically optimizes the display.

Select **Autoposition** item by using “▼” or “▲” buttons. Press “**OK**” or “◀”, “▶” button.

Warning: Please ensure auto adjustment is performed with a full screen image to ensure best results.

H (Horizontal) Position

This item shifts the image horizontally to right hand side or left hand side of the screen.

Select **H Position** item by using “▼” or “▲” button. Use “◀” or “▶” button to adjust the value.

V (Vertical) Position

This item shifts the image vertically towards the top or bottom of the screen.

Select **V Position** item by using “▼” or “▲” button. Use “◀” or “▶” button to adjust the value.

Phase

Depending on the resolution and scan frequency that you input to the TV set, you may see a hazy or noisy picture on the screen. In such a case you can use this item to get a clear picture by trial and error method.

Select **Phase** item by using “▼” or “▲” buttons. Use “◀” or “▶” button to adjust the value.

Dot Clock

Dot Clock adjustments correct the interference that appear as vertical banding in dot intensive presentations like spreadsheets or paragraphs or text in smaller fonts.

Select **Dot Clock** item by using “▼” or “▲” buttons. Use “◀” or “▶” button to adjust the value.

PC Picture Menu

For adjusting PC picture items, do the following:

Press “◀” or “▶” button to select the second icon. PC Picture menu appears on the screen.

Brightness, Contrast, Colour and Colour Temperature settings in this menu are identical to settings defined in TV picture menu under “Analogue TV Menu System”.

Note: If you set **Colour Temp** as **User**, you can define **R, G, B** settings manually.

Sound, Feature and Source settings are identical to the settings explained in **Analog Tv** menu system.

Displaying TV Information

Programme Number, Programme Name, Sound Indicator and **Zoom Mode** information is displayed on the screen when a new programme is entered or “**i**” button is pressed.

Muting Function

Press “**X**” button to disable sound. Muting indicator will be displayed in the upper side of the screen.

To cancel muting, there are two alternatives; the first one is pressing the “**X**” button and the second one is increasing the volume level.

Freezing Picture

You can freeze the picture on the screen by pressing the “**OK**” button on the remote control. Press the “**OK**” button to freeze picture. Press again to quit freeze mode.

Note: This feature will not be available while in **PC mode** or watched movie from **DVI** source .

Zoom Modes

You can change the aspect ratio (image size) of the TV for viewing the picture in different zoom modes.

Press “**ZOOM**” button to directly change the zoom mode.

Available zoom modes are listed below.

Note:

In **YPbPr** and **HDMI** modes, while in **720p-1080i** resolutions, only **16:9** mode is available.

Zoom mode cannot be changed while in **PC** mode.

Auto

When a **WSS (Wide Screen Signalling)** signal, which shows the aspect ratio of the picture, is included in the broadcast signal or the signal from an external device, the TV automatically changes the **ZOOM** mode according to the **WSS** signal.

- When the **AUTO** mode does not function correctly due to poor **WSS** signal quality or when you want to change the **ZOOM** mode, change to another **ZOOM** mode manually.

16:9

This uniformly stretches the left and right sides of a normal picture (4:3 aspect ratio) to fill the wide TV screen

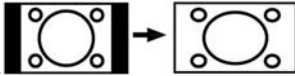

- For 16:9 aspect ratio pictures that have been squeezed into a normal picture (4:3 aspect ratio), use the **16:9** mode to restore the picture to its original shape.

4:3

Use to view a normal picture (4:3 aspect ratio) as this is its original size



Panoramic

This stretches the left and right sides of a normal picture (4:3 aspect ratio) to fill the screen, without making the picture appear unnatural. The top and bottom of the picture are slightly cut off.



14:9

This zooms up the wide picture (14:9 aspect ratio) to the upper and lower limits of the screen.



Cinema

This zooms up the wide picture (16:9 aspect ratio) to the full screen.



Subtitle

This zooms up the wide picture (16:9 aspect ratio) with subtitles to the full screen.



Zoom

This option zooms to the picture. Note: You can shift to screen up or down by pressing “▼” / “▲” buttons while picture zoom is selected as panoramic, 14:9, Cinema or Subtitle.



Teletext

Teletext system transmits information such as news, sports and weather on your TV. Note that is the signal degrades, for example in poor/adverse weather conditions, some text errors may occur or the teletext mode may be aborted.

Teletext function buttons are listed below:

“” Teletext On-Off / PAT Mode

Activates teletext mode when pressed once. Pressing this button again will split the screen into two windows, one displaying the teletext and the other displaying the current channel. Pressing again will quit the teletext mode.

“” Index

Selects the teletext index page.

“” Expand

Press once to enlarge top half of the page, press again to enlarge the bottom half of the page. Press again to revert back to normal size.

“” Reveal

Shows hidden information (e.g. solutions of games).

“” Hold

Holds a text page when convenient. Press again to resume.

“” Subcode Pages / Time

Selects subcode pages if available when the teletext is activated. When the teletext is not activated, displays time info if the programme has teletext transmission.

/ and numbers (0-9)

Press to select a page.



Note: Most TV stations use code 100 for their index pages.

Coloured Buttons

(RED/GREEN/YELLOW/BLUE)

Your TV supports both **FASTTEXT** and **TOP text** systems. When these systems are available, the pages are divided into groups or topics.

When **FASTTEXT** system is available, sections in a teletext page will become colour-coded and can be selected by pressing the coloured buttons. Press a coloured button that corresponds to with your needs.

The coloured writings will appear, showing you which coloured buttons to use when **TOP text** transmission is present. Pressing  or  commands will request the next or previous page respectively.

Tips

Image Persistence

Please note that ghosting may occur while displaying a persistent image. LCD TVs' image persistence may disappear after a short time. Try turning off the TV for a while. To avoid this, do not leave the screen in still picture for extended periods.

No Power

If your TV system has no power, please check the main power cable and connection to the mains socket outlet.

Poor Picture

Have you selected the correct TV system? Is your TV set or house aerial located too close to a non-earthed audio equipment or neon lights, etc.?

Mountains or high buildings can cause double pictures or ghost images. Sometimes you can improve the picture quality by changing the direction of the aerial. Is the picture or teletext unrecognisable? Check if you have entered the correct frequency. Please retune the channels. The picture quality may degrade when two peripherals are connected to the TV at the same time. In such a case, disconnect one of the peripherals.

No Picture

Is the aerial connected properly? Are the plugs connected tightly to the aerial socket? Is the aerial cable damaged? Are suitable plugs used to connect the aerial? If you are in doubt, consult your dealer.

No Picture means that your TV is not receiving a transmission. Have you selected the correct button on the remote control? Try once more. Also make sure the correct input source has been selected.

Sound

You can not hear any sound. Did you perhaps interrupt the sound, pressing the “” button?

Sound is coming from only one of the speakers. Is the balance set to one extreme? See Sound Menu.

Remote Control

Your TV no longer responds to the remote control. Perhaps the batteries are exhausted. If so you can still use the local buttons at the bottom of the TV.

Input Sources

If you cannot select an input source, it is possible that no device is connected.

Check the AV cables and connections if you have tried to connect a device.

Appendix A: PC Input Typical Display Modes

The display has a maximum resolution of 1600 X 1200. The following table is an illustration of some of the typical video display modes.

Your TV may not support different resolutions. Supported resolution modes are listed below.

If you switch your PC to an unsupported mode, a warning OSD will appear on the screen.

Index	Resolution		Frequency		Standard
	Hor	Ver	Ver (Hz)	Hor (KHz)	
1	640	480	60	31.5	VESA
2	640	480	72	37.9	VESA
3	640	480	75	37.5	VESA
4	800	600	56	35.2	VESA
5	800	600	60	37.9	VESA
6	800	600	70	43.8	
7	800	600	72	48.1	VESA
8	800	600	75	46.9	VESA
9	832	624	75	49.7	MAC
10	1024	768	60	48.4	VESA
11	1024	768	70	56.5	VESA
12	1024	768	72	57.7	
13	1024	768	75	60.0	
14	1152	864	70	64.2	VESA
15	1152	864	75	67.5	VESA
16	1152	870	75	68.9	MAC
17	1280	768	60	47.7	VESA
18	1360	768	60	47.7	
19	1280	960	60	60.0	VESA
20	1280	1024	60	64.0	VESA
21	1280	1024	75	80.0	VESA
22	1600	1200	60	75.0	VESA

Appendix B: AV and HDMI Signal Compatibility (Input Signal Types)

Source	Supported Signals		Available
EXT-1 (SCART)	PAL 50/60		O
	NTSC 60		O
	RGB 50		O
	RGB 60		O
EXT-1 S (S-VIDEO)	PAL 50/60		O
FAV	PAL 50/60		O
	NTSC 60		O
YPbPr	480I	60Hz	O
	480P	60Hz	O
	576I	50Hz	O
	576P	50Hz	O
	720P	50Hz	O
	720P	60Hz	O
	1080I	50Hz	O
	1080I	60Hz	O
	1080P	50Hz	O
	1080P	60Hz	O
HDMI1 HDMI2	480I	60Hz	O
	480P	60Hz	O
	576I	50Hz	O
	576P	50Hz	O
	720P	50Hz	O
	720P	60Hz	O
	1080I	50Hz	O
	1080I	60Hz	O
	1080P	24Hz	O
	1080P	50HZ	O
1080P	60HZ	O	

(X: Not Available, O: Available)

Note: In some cases a signal on the LCD TV may not be displayed properly. The problem may be an inconsistency with standards from the source equipment (DVD, Set-top box, etc.). If you do experience such a problem please contact your dealer and also the manufacturer of the source equipment.

Specifications

TV BROADCASTING RECEIVING CHANNELS

PAL/SECAM B/G D/K K' I/I' L/L'
VHF (BAND I/III)
UHF (BAND U)
HYPERBAND

Digital Reception	MHEG-5 ENGINE compliant with ISO/IEC 13522-5 UK engine Profile 1	for UK
	Object carousel support compliant with ISO/IEC 135818-6 and UK DTT profile	
	Frequency range: 474-850 MHz for UK models	
	170-862 MHz for EU models	
	Transmission standard: DVB-T. MPEG-2	
	Demodulation: COFDM with 2K/8K FFT mode	
	FEC: all DVB modes	
	Video: MP@ML, PAL, 4:3/16:9	
	Audio: MPEG Layer I&II 32/44.1/48kHz.	

NUMBER OF PRESET CHANNELS

200 (Analog) / 500 (Digital)

CHANNEL INDICATOR

On Screen Display

RF AERIAL INPUT

75 Ohm (unbalanced)

OPERATING VOLTAGE

220-240V AC, 50 Hz.

AUDIO

German+Nicam Stereo

AUDIO OUTPUT POWER (W_{RMS}) (10% THD)

2 x 6

POWER CONSUMPTION (W)

150 W (max)

< 1 W (Standby)

PANEL

32" wide display

DIMENSIONS (mm)

WxHxD (with stand):

787 mm x 556 mm x 187 mm

Weight :

11.5 Kg (with stand)

WxHxD (without stand):

787 mm x 514 mm x 94 mm (TV only)

Weight :

10.5 Kg (TV only)

Important Instruction

For your own safety read following instruction carefully before attempting to connect this unit to the mains supply.

MAINS (AC) OPERATION

The wires in the mains lead are coloured in accordance with the following code :

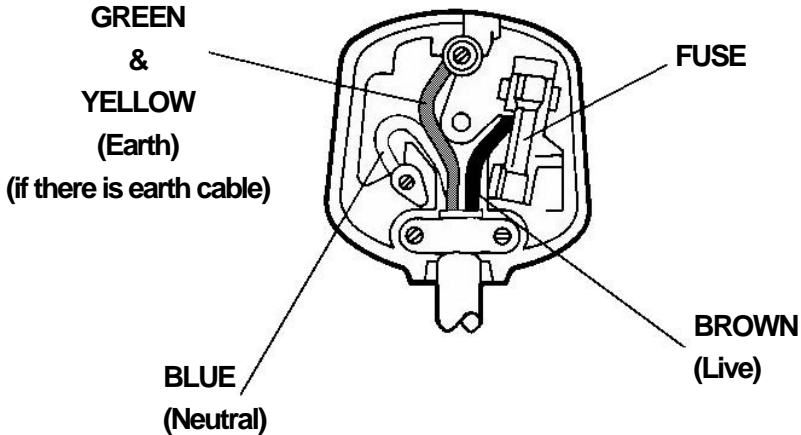

IMPORTANT

As the colours of the wires in the mains lead of this appliance may not correspond with the coloured markings identifying the terminals in your plug, proceed as follows:

The wire which is coloured green and yellow must be connected to the terminal which is marked with the letter E, or by the earth symbol, or coloured green or green and yellow.

The wire which is coloured blue or black must be connected to the terminal which is marked with the letter N or coloured Black.

The wire which is coloured brown or red must be connected to the terminal which is marked with the letter L or coloured Red.

For continued protection against risk of fire, replace only with same type and rating of fuse (ASTA approved 5A 250VAC fuse).

CAUTION

TO PREVENT ELECTRIC SHOCK DISCONNECT FROM THE MAINS BEFORE REMOVING COVER. NO USER SERVICEABLE PARTS INSIDE. REFER SERVICING TO QUALIFIED SERVICE PERSONNEL.

SAFETY PRECAUTION

THIS EQUIPMENT MUST BE DISCONNECTED FROM THE MAINS WHEN NOT IN USE. DO NOT ALLOW THIS UNIT TO BE EXPOSED TO RAIN OR MOISTURE.



JVC

If something doesn't seem to work

If there is something about your appliance which you do not understand and you live in the UK you can

Phone our help line during normal office hours on:

0844 8009595

Calls are charged at standard rates.

We apologise for any inconvenience caused by minor inconsistencies in these instructions, which may occur as a result of product improvement and development.

Kesa U.K HU1 3AU 29 / 04 / 2008

