

JVC



LT-24DG42J

ENGLISH

LCD TV

INSTRUCTIONS

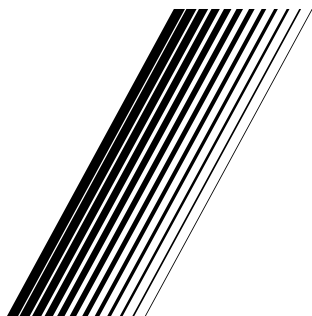
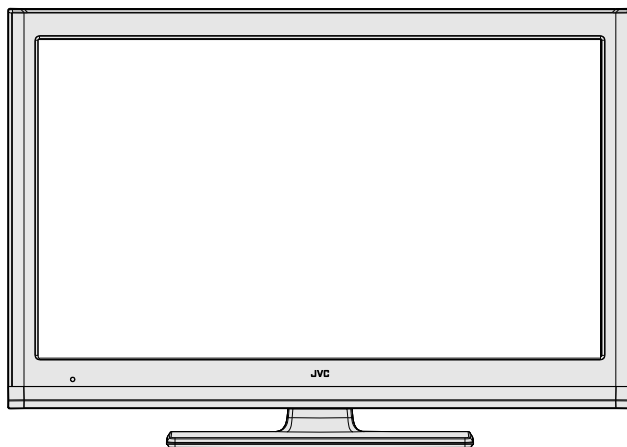

0812MTH-VT-VT

Dear Customer,

This apparatus is in conformance with the valid European directives and standards regarding electromagnetic compatibility and electrical safety.

European representative of the manufacturer is:

Vestel Germany GmbH

Parking 6

85748 Garching b.München

Germany

Information for Users on Disposal of Old Equipment and Batteries

[European Union]

These symbols indicate that the electrical and electronic equipment and the battery with this symbol should not be disposed of as general household waste at its end-of-life. Instead, the products should be handed over to the applicable collection points for the recycling of electrical and electronic equipment as well as batteries for proper treatment, recovery and recycling in accordance with your national legislation and the Directive 2002/96/EC and 2006/66/EC.



By disposing of these products correctly, you will help to conserve natural resources and will help to prevent potential negative effects on the environment and human health which could otherwise be caused by inappropriate waste handling of these products.

For more information about collection points and recycling of these products, please contact your local municipal office, your household waste disposal service or the shop where you purchased the product.

Penalties may be applicable for incorrect disposal of this waste, in accordance with national legislation.

[Business users]

If you wish to dispose of this product, please contact your supplier and check the terms and conditions of the purchase contract.

[Other Countries outside the European Union]

These symbols are only valid in the European Union.

The battery in this product is 2X AAA 1.5V Cell.

This batteries are located in the remote and are readily accessible.

Contact your local authority to learn about disposal and recycling.

The product and packaging should be taken to your local collection point for recycling.

Some collection points accept products free of charge.



Notice:

The sign Pb below the symbol for batteries indicates that this battery contains lead.

Logo & License



HDMI, the HDMI Logo, and High-Definition Multimedia Interface are trademarks or registered trademarks of HDMI Licensing LLC in the United States and other countries.

DVB is a registered trademark of the DVB Project

Safety Information

Mains Supply

This television is designed to operate from a 220-240 Volts 50Hz AC mains supply. Other power sources may damage it. Check that the rating plate (on the back cover of the television) states 220-240V AC before you plug it in for the first time.

The manufacturer accepts NO liability for damage or injury caused by using the product with the wrong mains voltage.

Mains plug

We have fitted this television with a standard mains plug.

- If the mains lead is damaged it must be replaced with a mains lead of the same type and rating to avoid a hazard.
- If for any reason you cut off the mains plug, please destroy the old plug as it would be dangerous if inserted into a live power outlet. Carefully follow the wiring instructions supplied with the new plug.
- If a fuse is fitted to the plug, remove the fuse before throwing the plug away.
- Never use a fused mains plug without the fuse cover.
- The mains plug shall be the main disconnect device and should be accessible at all times.

Mains Plug wiring for the UK

In a re-wirable plug the wires in the mains lead of this television should be connected as follows:

- The wire coloured BROWN must be connected to the terminal that is marked with the letter L.
- The wire coloured BLUE must be connected to the terminal that is marked with the letter N.
- No wire must be connected to the earth terminal which is marked E or 
- You must make sure the mains lead is firmly secured under the cord clamp.

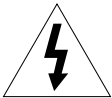
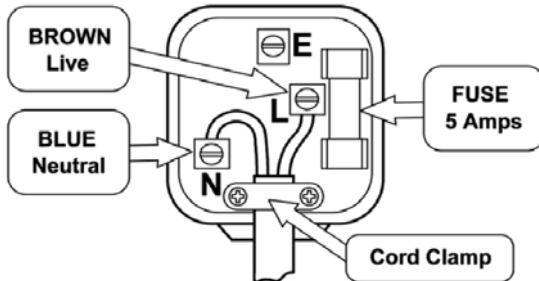

Dangerous voltage constituting a risk of electric shock is present inside this equipment.



This equipment is double insulated and an earth connection is not required.



This mark is applied to show the equipment conforms to European safety and electromagnetic compatibility standards.

Safe use and care of your television

We have designed and made this television to meet European Safety Standards, but as with any electronic equipment you must take care to stay safe and get the best results. Here is some good advice to help you do this.

Read these instructions carefully before you try to use the television.

Protect the mains lead. You must ensure the mains lead cannot be walked on, crushed, chafed, cut or trapped.

Safety Information (cont)

Switch off the mains power or pull out the mains plug when you leave the television unattended, unless the function of the television requires a continuous power supply.

Do not continue to use your television if you have spilled liquids in it, if it is damaged in any way or if it does not work normally. Immediately unplug the television and get expert advice.

Avoid harsh conditions such as wet or damp places, high humidity, strong vibration, extremely high or low temperatures, strong sunlight and places that are very dusty.

Never fit makeshift stands or legs to the television.

Never push objects into holes and ventilation slots.

To prevent electric shock do not remove any cover.

Do not touch the LCD display as it gets warm when in use, this is normal and is not a fault.

If anything goes wrong do not try to fix it yourself, get a qualified service agent to look at it.

Pull out the mains plug and disconnect the aerial lead during thunder storms.

CAUTION: Connect headphones with the volume set low and increase if required. Prolonged listening through headphones at high volume settings can result in hearing damage.

Ventilation

Place the television on a hard flat surface away from direct sunlight or heat sources. If it is in a cabinet allow at least a 10cm gap all around. Do not obstruct the ventilation slots, including those underneath with soft furnishings. Overheating will shorten the life of the television and increase the risk of fire.

Cleaning

Disconnect the mains supply and use only a lightly dampened soft cloth. Do not use chemical solvents or strong detergents as these may damage the cabinet or screen. Never allow water droplets to remain on the screen as moisture can cause permanent discolouration. Greasy marks must only be removed with a commercial cleaner specifically recommended for LCD screens.

Eye Fatigue

When using this product as a computer monitor, health and safety experts recommend short frequent breaks rather than occasional longer breaks. For example a 5-10 minute break after an hour of continuous screen work is considered to be better than a 15 min break every 2 hours.

Do not use the monitor against a bright background or where sunlight or other bright light sources will shine directly onto the screen.

Batteries

Remove batteries when the remote control is not to be used for a long time. Batteries left in equipment may cause damage through deterioration and corrosive leakage, invalidating the guarantee.

To protect the environment use local recycling facilities for battery disposal.

Dispose of used batteries according to the instructions.

CAUTION: Risk of explosion if batteries are replaced by an incorrect type.

WARNINGS:

- This appliance is intended for domestic household use only and should not be used for any other purpose or on any other application, such as for non-domestic use or use in a commercial environment.
- If the supply cord is damaged it must be replaced by the manufacturer, its service agent or similarly qualified persons in order to avoid a hazard.
- This apparatus shall not be exposed to dripping or splashing and that no objects filled with liquids, such as vases shall be placed on the apparatus.
- No naked flame sources, such as lighted candles should be placed on the apparatus.
- The ventilation should not be impeded by covering the ventilation openings, with items such as newspapers, tablecloths, curtains etc.
- To prevent injury, this apparatus must be securely attached to the floor/wall in accordance with the installation instructions.

Contents

Safety Information.....	2	Managing Stations: Channel List.....	17
Features	5	Operating the Channel List.....	17
Introduction.....	5	Moving a Channel.....	17
Preparation.....	5	Deleting a Channel.....	17
Safety Advice.....	5	Renaming a Channel.....	18
Package Contents	7	Locking a Channel.....	18
Environmental Information	7	Managing Stations: Favourites.....	18
Repair Information	7	Button Functions.....	18
Remote Control Buttons	8	Managing Stations: Sorting the Channel List	18
TV and Operating Buttons.....	9	On-Screen Information	18
Viewing the Connections - Back Connectors	9	Media Playback Using Media Browser.....	19
Viewing the Connections - Side Connectors	10	Viewing Videos via USB	19
Power Connection	10	Viewing Photos via USB	19
Aerial Connection	10	Slideshow Options.....	20
Using USB Media.....	11	Playing Music via USB	20
USB Memory Connection	11	Media Browser Settings.....	20
Connecting the TV to a PC.....	11	Changing Image Size: Picture Formats.....	20
Using Side AV Connectors	11	Configuring Picture Settings.....	21
Connecting to a DVD Player via HDMI.....	12	Operating Picture Settings Menu Items.....	21
Connecting to a DVD Player.....	12	Picture Settings Menu Items.....	21
Remote Control Handset.....	12	PC Picture Settings.....	22
Inserting Batteries.....	12	Configuring Sound Settings.....	22
Switching On/Off.....	13	Operating Sound Settings Menu Items.....	23
To Switch the TV On.....	13	Sound Settings Menu Items.....	23
To Switch the TV Off	13	Configuring Your TV's Settings.....	23
Standby Notifications.....	13	Operating Settings Menu Items.....	23
Input Selection.....	13	Settings Menu Items	23
Basic Operations	13	Using a Conditional Access Module (not included).....	24
Operation with the Buttons on the TV.....	13	Viewing Conditional Access Menu (*).....	24
Volume Setting.....	13	Configuring Language Preferences.....	24
Programme Selection	13	Language Settings.....	25
Viewing Main Menu.....	13	Parental Control.....	25
AV Mode	13	Parental Settings Menu Operation	25
Operation with the Remote Control	13	Timers.....	25
Volume Setting.....	14	Setting Sleep Timer	25
Channel Selection (Previous or Next Channel).....	14	Setting Programme Timers.....	25
Programme Selection (Direct Access).....	14	Configuring Date/Time Settings.....	26
Viewing Electronic Programme Guide (EPG).....	14	Configuring Source Settings.....	26
EPG Timeline Schedule.....	14	Configuring Other Settings	27
EPG List Schedule.....	14	Operation.....	27
EPG Now and Next.....	14	Other Features	27
Digital Teletext (** for UK only)	15	Teletext (Analogue).....	28
Analogue Teletext	15	Tips	28
First Time Installation.....	15	Appendix A: PC Input Typical Display Modes.....	29
Installation	16	Appendix B: AV and HDMI Signal Compatibility (Input Signal Types).....	29
Auto Channel Scan (Retune) Menu Operation....	16	Appendix C: Supported DVI Resolutions.....	30
Manual Tuning	16	Appendix D: Software Upgrade.....	30
Digital Manual Search.....	16	Appendix E : Supported File Formats for USB Mode.....	31
Analogue Manual Search	17	Specifications	32
Analogue Fine Tune.....	17		
Clear Service List (*).....	17		

Features

- Remote controlled colour LCD TV.
- Fully integrated Terrestrial digital TV (DVB-T MPEG2).
- HDMI connectors for digital video and audio.
- USB input.
- 1000 programmes (analogue+digital).
- On Screen Display (OSD) menu system.
- Integrated tuner DVB-T, MPEG 2 compatible.
- Scart socket for external devices.
- Stereo sound system. (Nicom)
- Teletext, fastext, TOP text.
- Headphone connection.
- Automatic programming system.
- Forward or backward manual tuning.
- Sleep timer / Child lock.
- Automatic sound mute when no transmission.
- NTSC playback.
- AVL (Automatic Volume Limiting).
- Auto power down.
- PLL (Frequency Search).
- PC input.
- Plug&Play for Windows 98, ME, 2000, XP, Vista, Windows 7.
- Game Mode

Introduction

Thank you for choosing this product. This manual will guide you through the proper operation of your TV. Before operating the TV, please read this manual thoroughly. Please keep this manual in a safe place for future reference.

This device is intended to receive and display TV programmes. The different connection options make an additional expansion of the reception and display sources possible (receiver, DVD player, DVD recorder, VCR, PC etc.).

This device is only suitable for dry indoor use. This appliance is intended solely for private domestic use and may not be used for industrial and commercial purposes. We exclude liability in principle, if the device is not used as intended, or unauthorized modifications have been made. Operating your LCD TV in extreme ambient conditions may damage it.

Preparation

For ventilation, leave a free space of at least 10 cm all around the set. To prevent any fault and unsafe situations, please do not place any objects on top of the set. Use this device in moderate climates.

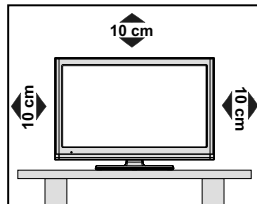

Safety Advice

Read the following recommended safety precautions carefully.

Power Source

The TV set should be operated only from a 220 V - 240 V AC, 50 Hz outlet. Ensure that you select the correct voltage setting for your convenience.

Power Cord

Do not place the set, a piece of furniture, etc. on the power cord or pinch the cord. Handle the power cord by the plug. Do not unplug the appliance by pulling from the power cord and never touch the power cord with wet hands as this could cause a short circuit or electric shock. Never make a knot in the cord or tie it with other cords. The power cord should be placed in such a way that they are not likely to be stepped on. A damaged power cord can cause fire or give you an electric shock. When it is damaged and needs to be replaced, it should be done by qualified personnel.

Moisture and Water

Do not use this device in a humid and damp place (avoid the bathroom, the sink in the kitchen etc). Do not expose this device to rain or water, as this may be dangerous and do not place objects filled with liquids, such as flower vases, on top.



If any solid object or liquid falls into the cabinet, unplug the TV and have it checked by qualified personnel before operating it any further.

Cleaning

Before cleaning, unplug the TV set from the wall outlet. Do not use liquid or aerosol cleaners. Use a soft, dry cloth.



Ventilation

The slots and openings on the TV set are intended for ventilation and to ensure reliable operation. To prevent overheating, these openings must not be blocked or covered in anyway.

Heat and Flames

The set should not be placed near to open flames or sources of intense heat such as an electric heater. Ensure that no open flame sources, such as candles, are placed on top of the TV.



Lightning

In case of storm and lightning or when going on holiday, disconnect the power cord from the wall outlet.

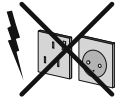

Replacement Parts

When replacement parts are required, make sure that the service technician has used replacement parts, which are specified by the manufacturer or have the same specifications as the original one. Unauthorized substitutions may result in fire, electrical shock or other hazards.

Servicing

Please refer all servicing to qualified personnel. Do not remove the cover yourself as this may result in an electric shock.



Waste Disposal

Instructions for waste disposal:

- Packaging and packaging aids are recyclable and should principally be recycled. Packaging materials, such as a foil bag, must be kept away from children.
- Batteries, including those which are heavy metal-free, should not be disposed of with household waste. Please dispose of used batteries in an environmentally friendly manner. Find out about the legal regulations which apply in your area.
- Do not try to recharge batteries, there is a danger of explosion. Replace batteries only with the same or equivalent type.

Disconnecting the Device

The mains plug is used to disconnect the TV set from the mains and therefore it must remain readily operable.

Headphone Volume

Excessive sound pressure from earphones and headphones can cause hearing loss.



Installation

To prevent injury, this device must be securely attached to the wall in accordance with the installation instructions when mounted to the wall (if the option is available).

LCD Screen

The LCD panel is a very high technology product with about a million thin film transistors, giving you fine picture details. Occasionally, a few non-active pixels may appear on the screen as a fixed blue, green or red point. Please note that this does not affect the performance of your product.

Warning! Do not leave your TV in standby or operating mode when you leave your house.

Connection to a Television Distribution System (Cable TV etc.) from Tuner

Devices connected to the protective earthing of the building installation through the mains connection or through other apparatus with a connection to protective earthing-and to a television distribution system using a coaxial cable, may in some circumstances create a fire hazard.

Connection to a cable distribution system has therefore to be provided through a device providing electrical isolation below a certain frequency range (galvanic isolator, see EN 60728-11).

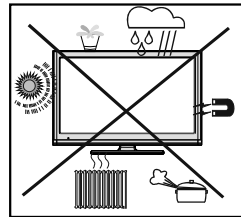

Electrical devices not in the hands of children

Never let children use electrical devices unsupervised. Children cannot always recognize properly any possible danger. Batteries / accumulators can be life threatening when swallowed. Store batteries out of the reach of small children. In case of swallowing a battery, medical aid has to be sought immediately. Also keep the packaging away from children as there is danger of suffocation.

Note:The HDMI connection between PC and TV may cause radio interference in which case it is recommended to use VGA(DSUB-15) connection.

The Standby button does not fully switch off this product. Moreover, the device continues to consume power in standby mode. In order to separate the device completely from mains, the mains plug has to be pulled from the mains socket. Because of that the device should be set up in a way, that an unobstructed access to the mains socket is guaranteed, so that in case of emergency the mains plug can be pulled immediately. During periods of prolonged non-use, the TV should be disconnected from the mains power supply.

WARNING

To prevent fire, never place any type of candle or open flame on the top or near the TV set.



Package Contents

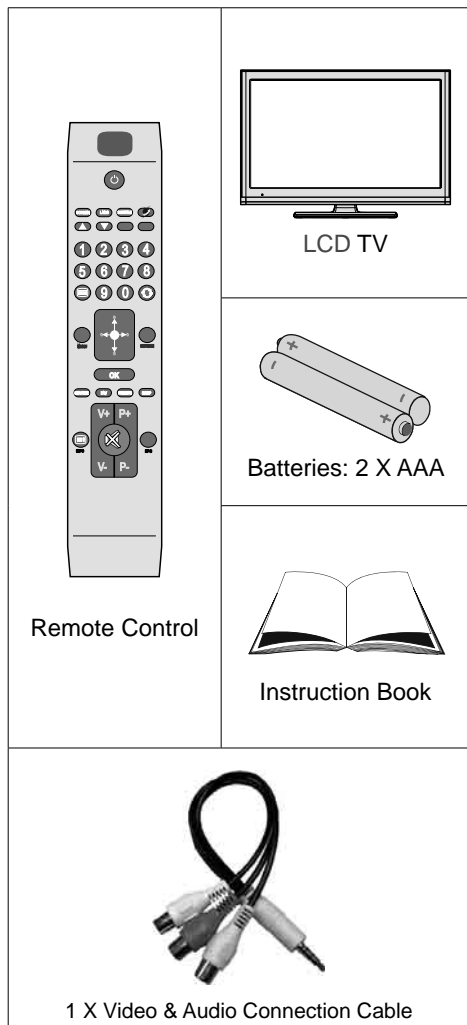

Note: You should check the contents after opening your purchase and make sure that every item is included.

Environmental Information

- This television is designed to consume less energy to save the environment.

You not only help to save the environment but you can also save money by reducing electricity bills thanks to the energy efficiency features of this TV. To reduce energy consumption, you should take the following steps:

- You can use the Power Save Mode setting, located in the **picture settings** menu. If you set the Power Save Mode as On, the TV will switch to energy-saving mode and the luminance level of the TV set will be decreased to optimum level. Note that some picture settings will be unavailable when the TV is in Power Save Mode.



- When the TV is not in use, please switch off or disconnect the TV from the mains socket. This will reduce energy consumption.

NOTE: *It is highly recommended to activate the Power Save Mode setting to reduce your annual power consumption.*

- Please help us to save environment by following these steps.

Repair Information

Please refer all servicing to qualified personnel. Only qualified personnel must repair the TV. Please contact your local dealer, where you purchased this TV for further information.

Remote Control Buttons

- ① Standby
- ② Mono/Stereo - Dual I-II / Current Language (in DVB channels)
- ③ Image size
- ④ Green button
- ⑤ Red button
- ⑥ Numeric buttons
- ⑦ Teletext / Mix(in TXT mode)
- ⑧ Cursor Left
- ⑨ Menu on-off
- ⑩ AV / Source selection
- ⑪ Favourite Mode Selection(in DVB channels)
- ⑫ Volume Up
- ⑬ Info / Reveal (in TXT mode)
- ⑭ Mute
- ⑮ Volume Down
- ⑯ Programme Down / Page down (in DVB channels)
- ⑰ Electronic programme guide(in DVB channels)
- ⑱ Programme Up / Page up (in DVB channels)
- ⑲ Sleep Timer
- ⑳ Picture mode selection
- ㉑ Okay (Confirm) / Hold (in TXT mode)/ Edit Channel List
- ㉒ Cursor Down
- ㉓ Exit / Return / Index page (in TXT mode)
- ㉔ Cursor Right / Subpage (in TXT mode)
- ㉕ Cursor Up
- ㉖ Previous programme
- ㉗ Yellow button
- ㉘ Blue button
- ㉙ No function
- ㉚ Subtitle on-off (in DVB channels)

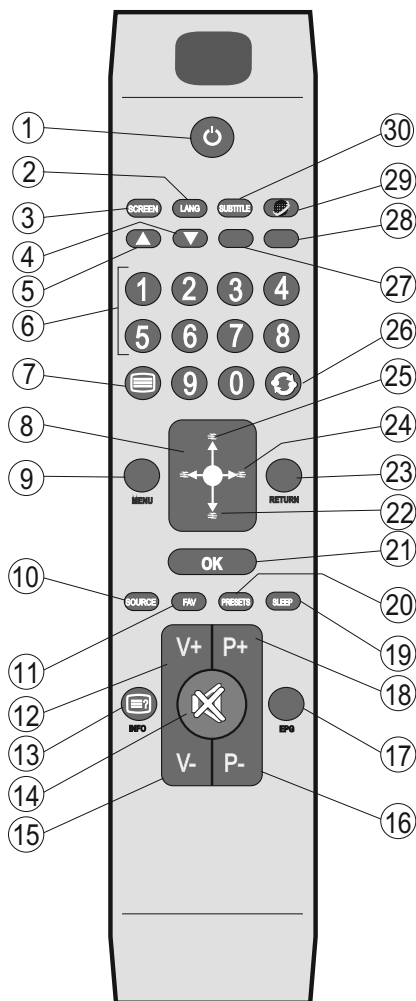

TV and Operating Buttons

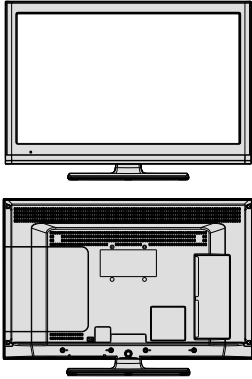
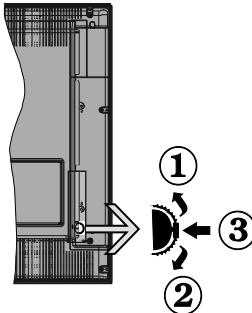
FRONT and REAR VIEW	Control buttons VIEW	Control Buttons
		<p>① Up direction ② Down direction ③ Programme/Volume / AV / Standby-On selection switch</p> <p>Note: You can move the switch, upward or downward to change the volume. If you want to change channels, press the middle of the switch once (Position 3) and then move upward or downward. If you press the middle of the switch once more, source OSD will be displayed. If you press the middle of the switch and hold about a few seconds, the TV will switch to standby mode. Main menu OSD cannot be displayed via control buttons.</p>

Viewing the Connections - Back Connectors

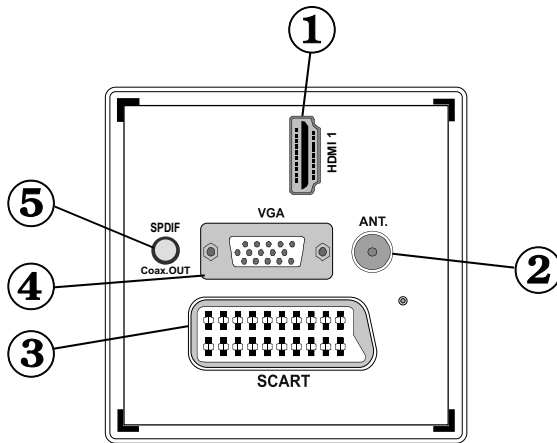

① HDMI 1: HDMI Input

HDMI Inputs are for connecting a device that has a **HDMI** socket. Your TV is capable of displaying High Definition pictures from devices such as a High Definition Satellite Receiver or DVD Player. These devices must be connected via the **HDMI** or **Component** source. These sockets can accept either 720p or 1080i signals. No sound connection is needed for a HDMI to HDMI connection.

② RF Input connects to an aerial antenna system.

Note: If you use a decoder or a media recorder, you should connect the aerial cable through the device to the television with an appropriate antenna cable, as shown in the illustration in the following pages.

③ SCART input or output for external devices. Connect the SCART cable between the SCART socket on the TV and the SCART socket on your external device (such as a decoder, a VCR or a DVD player).

Note: If an external device is connected via the SCART socket, the TV will automatically switch to AV mode.
Note: S-Video signal is supported via the scart socket (optional).

Note: When receiving DTV channels (Mpeg4 H.264) or while in Media Browser mode, output will not be available via the scart socket.

- ④ **VGA Input** is for connecting a personal computer to the TV set.
Connect the PC cable between the **PC INPUT** on the TV and the PC output on your PC.
Note: You can use YPbPr to VGA cable (not supplied) to enable YPbPr signal via PC input.
WARNING: You cannot use PC and YPbPr at the same time.
- ⑤ **SPDIF Out** outputs audio signals of the currently watched source.
Use an **SPDIF cable** to transfer audio signals to a device that has SPDIF input.

Viewing the Connections - Side Connectors

- ① The CI Slot is used for inserting a CI card. A CI card allows you to view all the channels that you subscribe to. For more information, see "Conditional Access" section.
- ② Side USB input.
- ③ Side audio-video connection input is used for connecting video and audio signals of external devices. To make a video connection, you must use the supplied AV connection cable for enabling connection. First, plug singular jack of the cable to the TV's Side AV socket. Afterwards, insert your video cable's (not supplied) connector into the YELLOW input (located on the plural side) of the supplied AV connection cable. Colours of the connected jacks should match.

To enable audio connection, you must use RED and WHITE inputs of the side AV connection cable. Afterwards, insert your device's audio cable's connectors into the RED and WHITE jack of the supplied side AV connection cable. Colours of the connected jacks should match.

Note: You should use audio inputs of side AV connection cable (RED & WHITE) to enable sound connection when connecting a device to your TV by using PC or COMPONENT VIDEO input.

- ④ The headphone jack is used for connecting an external headphone to the system.
Connect to the HEADPHONE jack to listen to the TV from headphones.
- ⑤ Volume/ Programme/ Source and Standby-On switch

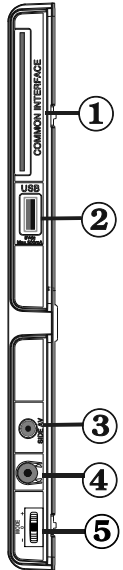

Power Connection

IMPORTANT: The TV set is designed to operate on 220 V - 240 V AC, 50 Hz.

- After unpacking, allow the TV set to reach the ambient room temperature before you connect the set to the mains. Plug the power cable to the mains socket outlet.

Aerial Connection

- Connect the aerial ,cable TV plug to the **AERIAL INPUT (ANT)** socket located at the rear of the TV.

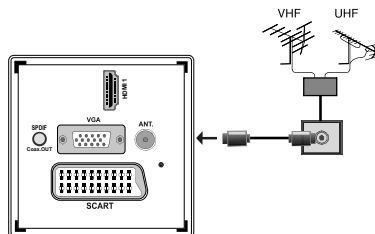

Using USB Media

- You can connect USB devices to your TV by using the USB input of the TV. This feature allows you to display/play JPG, MP3 and video files stored on a USB stick.
- It is possible that certain types of USB devices (e.g. MP3 Players) may not be compatible with this TV.
- You should back up your files before making any connections to the TV set in order to avoid any possible data loss. Note that the manufacturer will not be responsible for any file damage or data loss.
- Do not pull out USB module while playing a file.

CAUTION: Quickly plugging and unplugging USB devices, is a very hazardous operation. Do not repeatedly quickly plug and unplug the drive. This may cause physical damage to the USB player and especially the USB device itself.

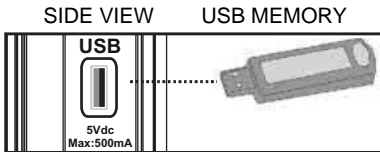

USB Memory Connection

IMPORTANT: The TV should be switched off while plugging or unplugging a USB device. Plug your USB devices to the USB input of the TV. You can connect a USB device to your TV by using the USB input of the TV.

Note: It is possible certain types of hard disk drives are not supported.

Connecting the TV to a PC

For displaying your computer's screen image on your TV, you can connect your computer to the TV set. Power off both computer and display before making any connections. Use a 15-pin D-sub display cable to connect a PC to the TV. When the connection is made, switch to PC source. See the **Input selection** section. Set the resolution that suits your viewing requirements. Resolution information can be found in the appendix.

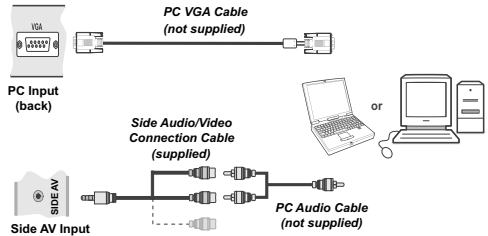

Note: If you connect a PC to the TV using HDMI connection, radio interference may occur. Therefore this type of connection is not recommended. You should use VGA connection instead.

Using Side AV Connectors

You can connect a range of optional equipment to your LCD TV using side connectors of the TV.

- For connecting a camcorder or camera, you should use **SIDE AV** socket (side). To do this, you must use the supplied **video/audio connection cable**. First, plug single jack of the cable to the TV's **AV IN** socket (side). Afterwards, insert your camera cable's (*not supplied*) connectors into the plural part of the **video/audio connection cable**. Colours of the connected jacks should match. See illustration below.
- Afterwards, you should switch to **Side AV** source. See the section **Input selection** in the following sections for more information.

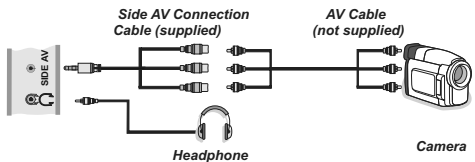

- To listen the TV sound from headphones, you should connect headphones to your TV by using the **HEADPHONE** jack as illustrated above.

Connecting to a DVD Player via HDMI

Please refer to your DVD player's instruction book for additional information. Power off both the TV and the device before making any connections.

Note: Not all cables shown in the illustration are supplied.

- If your DVD player has an **HDMI** socket, you can connect via **HDMI** for better video and audio quality.

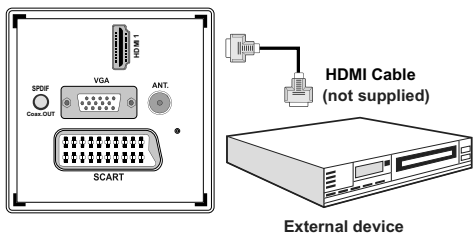

- When you connect to DVD player as illustrated above, switch to the connected **HDMI** source. See, **Input Selection** section for more information on changing sources.

Connecting to a DVD Player

- Some DVD players are connected through **COMPONENT SOCKETS (YPbPr)**. YPbPr can be used only when you connect a device that has a YPbPr output through the PC input with YPbPr to PC cable (YPbPr cable is not supplied).
- When the connection is made, switch to YPbPr source. See, "Input selection" section.
- To enable audio connection, use the **VGA/Component Audio cable**. First, plug single jack of the cable to the TV. Afterwards, insert your DVD player's audio cable's connectors into the plural part of the **VGA/Component audio connection cable** (see illustration below). Colours of the connected jacks should match (**RED & WHITE**).

Audio Connection

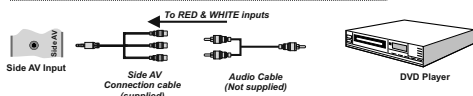

Video Connection

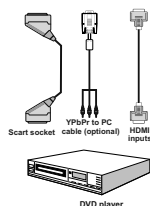

- When the connection is made, switch to **YPbPr** source. See, **Input selection** section.
- You may also connect through the **SCART** input.

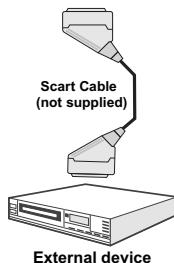
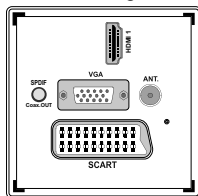

Note: These three methods of connection perform the same function but in different levels of quality. It is not necessary to connect by all three methods.

Remote Control Handset

Inserting Batteries

- Remove the battery cover located on the back of the handset by gently pulling backwards from the indicated part.
- Insert two **AAA/R3** or equivalent type batteries inside. Observe the correct polarity (+/-) when inserting batteries and replace the battery cover.

Batteries should not be exposed to excessive heat such as sunshine, fire or the like.

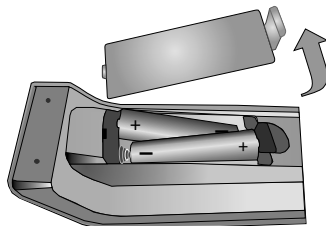

Note: Remove the batteries from the remote control handset when it is not to be used for a long period. Otherwise it can be damaged due to any leakage of batteries. Remote range is approximately 7m/23ft.

Switching On/Off

To Switch the TV On

- Connect the power cord to the 220-240V AC 50 Hz. Then the standby LED lights up (The LED will blink during the standby On/Off).
- To switch the TV on from standby mode either:
- Press the “” button, **P+** or **P-** or a numeric button on the remote control.
- Press the control switch on the left hand side of the TV. The TV will then switch on.

Note: If you switch on your TV via **P+** or **P-** buttons on the remote control or on the TV set, the programme that you were watching last will be reselected.

To Switch the TV Off

- Press the “” button on the remote control or press and hold the control switch on the TV until shut down, so the TV will switch to standby mode.
- To power down the TV completely, unplug the power cord from the mains socket.

Note: When the TV is switched to standby mode, the standby LED will blink to indicate that features such as Standby Search, Over Air Download or Timer is active.

Standby Notifications

If the TV switches off while in No Signal mode, the following on-screen message will be displayed on the next switch-on:



When the Auto Tv Off timeout is reached, the following message will be displayed on the screen. Select YES to shut down the TV. Select NO to cancel. The TV will switch off as well, if you do not make a selection on this screen.

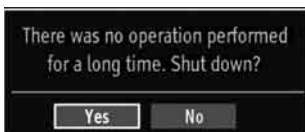

If the TV switches off owing to the auto power down feature, the following on-screen message will be displayed on the next switch-on:

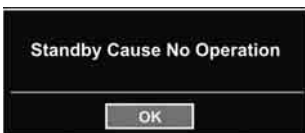

Input Selection

Once you have connected external systems to your TV, you can switch to different input sources. Press “**SOURCE**” button on your remote control consecutively for directly changing sources.



Note: YPbPr mode can be used only when you connect a device that has a YPbPr output through the PC input with YPbPr to PC cable (not supplied).

Basic Operations

You can operate your TV using both the remote control and onset buttons.

Operation with the Buttons on the TV

Volume Setting

- You can move the control switch upward or downward for changing the volume. To increase volume, please move the switch upward. Move the switch downward to decrease the volume. A volume level scale (slider) will be displayed on the screen.

Programme Selection

- First press the control switch once to change channel. You can move the switch upward to select the next programme or move it downward to select the previous programme.

Viewing Main Menu

- Menu screen cannot be displayed by using the control switch.

AV Mode

- Press the control switch consecutively until the source OSD is displayed on the screen.

Operation with the Remote Control

- The remote control of your TV is designed to control all the functions of the model you selected. The functions will be described in accordance with the menu system of your TV.

Volume Setting

- Press **V+** button to increase the volume. Press **V-** button to decrease the volume. A volume level scale (slider) will be displayed on the screen.

Channel Selection (Previous or Next Channel)

- Press **P-** button to select the previous channel.
- Press **P+** button to select the next channel.

Programme Selection (Direct Access)

- Press the numeric buttons on the remote control to select channels between 0 and 9. The TV will switch to the selected channel.

Viewing Electronic Programme Guide (EPG)

You can use the electronic programme guide (EPG) to see information about available programmes. To view the EPG menu please press EPG button on the remote control.

- Press “**▼**”/“**▲**” buttons to navigate through channels.
- Press “**◀**”/“**▶**” buttons to navigate through the programme list.
- Please note that event information is updated automatically. If there is no event information data available for channels, the EPG will be displayed with blanks.

EPG Timeline Schedule



Red button (Prev Day): Displays the programmes of previous day.

Green button (Next day): Displays the programmes of the next day.

Yellow button (Zoom): Expands programme information.

Blue button (Filter): Views filtering options.

Numeric buttons (Jump): Jumps to the preferred channel directly via numeric buttons.

INFO (Details): Displays the programmes in detail.

OK (Options): Displays programme options including “**Select Channel**” option.

☰ (Search): Displays “**Guide Search**” menu.

SUBTITLE: Press **SUBTITLE** button to view Select Genre menu. Using this feature, you can search the programme guide database in accordance with the genre. Info available in the programme guide will be searched and results matching your criteria will be listed.

☺ (Now): Shows the current programme.

EPG List Schedule



Up/Down/Left/Right: Navigate.

Red button (Prev Time Slice): Displays the programmes of previous time slice.

Green button (Next Time Slice): Displays the programmes of the next time slice.

Yellow button (Prev Day): Displays the programmes of previous day.

Blue button (Next day): Displays the programmes of the next day.

☰ (Filter): Views filtering options.

Numeric buttons (Jump): Jumps to the preferred channel directly via numeric buttons.

OK (Options): Displays programme options including “**Select Channel**” option.

INFO (Details): Displays the programmes in detail.

EPG Now and Next



Up/Down/Left/Right: Navigate.

OK (Options): Displays programme options including “**Select Channel**” option.

Blue button (Filter): Views filtering options.

INFO (Event Details): Displays the programmes in detail.

Green button: Programme schedule will be listed



Yellow button: Display EPG data in accordance with timeline schedule.

Digital Teletext (** for UK only)

- Press the  button.
- The digital teletext information appears.
- Operate it with the coloured buttons, cursor buttons and **OK** button.

The operation method may differ depending on the contents of the digital teletext.

Follow the instructions displayed on digital teletext screen.

- When the  button is pressed, the TV returns to television broadcasting.
- With digital broadcasting (DVB-T-C), in addition to digital teletext broadcasting together with the normal broadcasting, there are also channels with just digital teletext broadcasting.
- The aspect ratio (picture shape) when watching a channel with just digital teletext broadcasting is the same as the aspect ratio of the picture viewed previously.
- When you press the  button again, the digital teletext screen will be displayed.

Analogue Teletext



Use of teletext and its functions are identical to the analogue text system. Please do refer to the "TELETEXT" explanations.

First Time Installation

IMPORTANT: Ensure that the aerial is connected and a Common Interface module is not inserted before switching on the TV for the first time installation.









- When the TV is operated for the first time, the installation wizard will guide you through the process. First, the language selection screen will be displayed:





- Use  or  buttons to select your language and press **OK** button to set the selected language and continue.

- After selecting the language, "Welcome!" screen will be displayed, requiring you to set **Country**, **Search Type**, **Teletext Language** and **Scan Encrypted** options.



- By pressing  or  button, select the **country** you want to set and press  button to highlight **Search Type** option. Use  or  to set the desired search type. Available search types are digital only, analog TV only and full.
- When set, press  to select **Teletext Language**. Use  or  to select the desired **Teletext Language**.
- Press  button after setting Teletext Language option. **Scan Encrypted** will be then highlighted. You should set the **Scan Encrypted** as **Yes** if you want to scan coded stations. Afterwards select the desired Teletext Language.
- Press **OK** button on the remote control to continue and the following message will be displayed on the screen:



To select the "Yes" or "No" option, highlight the item by using  or  buttons and press **OK** button.

Afterwards the following OSD will be displayed on the screen and the TV will search for both digital and analogue TV broadcasts.



- *Note: You can press “MENU” button to cancel.*

After searching for digital channels the following message may appear.



Choose the required country, primary secondary and tertiary region by pressing “◀” or “▶” and confirming each choice by pressing ‘OK’.

After confirming them all press OK once more to continue.

- After all the available stations are stored, Channel List will be displayed on the screen. If you like the stored channels as shown, press **OK** button to confirm.



- Press **OK** button to quit channel list and watch TV.

Installation

Press **MENU** button on the remote control and select **Installation** by using “◀” or “▶” button. Press **OK** button and the following menu screen will be displayed.



Select **Automatic Channel Scan (Retune)** by using “▼”/“▲” button and press **OK** button. **Automatic Channel Scan (Retune)** options will be displayed. You can select options by using “▼”/“▲” and **OK** buttons.

Auto Channel Scan (Retune) Menu Operation

Digital: Searches and stores DVB stations.

Analogue: Searches and stores analogue stations.

Full: Searches and stores both analogue and DVB stations.

- Whenever you select an automatic search type and press **OK** button, a confirmation screen will appear on the screen. To start installation process, select **Yes**, to cancel select **No** by using “◀” or “▶” and **OK** button.
- After the auto channel scan type is set and selected and confirmed, the installation process will start and the progress bar will move along. Press “MENU” button to cancel process. Located channels are not stored if the process is cancelled.

Manual Tuning

HINT: This feature can be used for direct broadcast entry.

- Select **Manual Channel Scan** from the Installation menu by using “▼”/“▲” and **OK** buttons. Manual Scan options screen will be displayed.
- Select the desired **Search Type** using “◀” or “▶” button. Manual search options will change accordingly. Use “▼”/“▲” button to highlight an item and then press “◀” or “▶” button to set an option. You can press “MENU” button to cancel.

Digital Manual Search

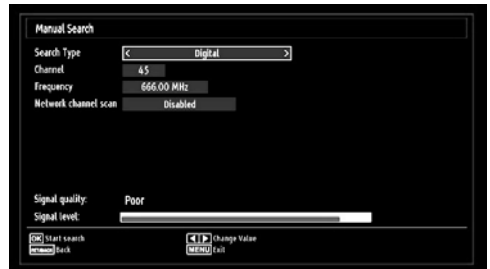

In manual channel scan, the number of the multiplex or frequency are entered manually and only that multiplex or frequency are searched for the channels. After selecting search type as **Digital**, you can enter the multiplex or frequency number using the numeric buttons and press **OK** button to search.

Analogue Manual Search

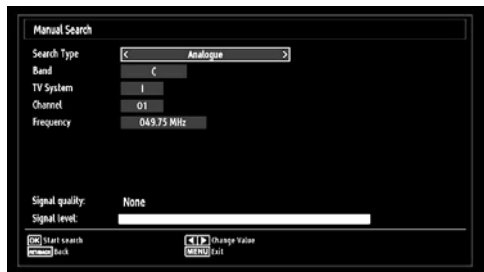

After selecting search type as analogue, you can use “▼”/“▲” button to highlight an item and then press “◀” or “▶” button to set an option.

Enter the channel number or frequency using the numeric buttons. You can then press **OK** button to search. When the channel is located, any new channels that are not on the list will be stored.

Analogue Fine Tune

- Select **Analogue Fine Tune** from the Installation menu by using “▼” or “▲” and **OK** buttons. The analogue fine tune screen will be displayed. The Analogue Fine Tune feature will not be available if there are no analogue channels, digital channels and external sources stored.
- Press **OK** button to proceed. Use “◀” or “▶” button to set Fine Tune. When finished, press **OK** button again.

Clear Service List (*)

(*) This setting is visible only when the Country option is set to Denmark, Sweden, Norway or Finland.

Use this setting to clear channels stored. Press “▼” or “▲” button to select Clear Service List and then press **OK**. The following OSD message will be displayed on the screen:

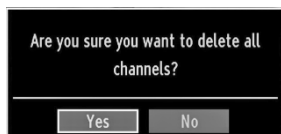

Press **OK** to cancel. Select Yes by pressing “◀” or “▶” button and press **OK** to delete all of the channels.

Managing Stations: Channel List

The TV sorts all stored stations in the Channel List. You can edit this channel list, set favourites or set active stations to be listed by using the Channel List options.

- Press **MENU** button to view main menu. Select the Channel List item by using “◀” or “▶” button. Press **OK** to view menu contents.



Select **Edit Channel List** to manage all stored channels. Use “▼” or “▲” and **OK** buttons to select Edit Channel List.

Operating the Channel List



- Press “▼” or “▲” button to select the channel that will be processed. Press “◀” or “▶” button to select a function on Channel List menu.
- Use **P+** or **P-** buttons to move page up or down.
- Press **BLUE** button to view filtering options.
- Press **MENU** button to exit.

Note: The channels listed are mixed at the channel list. Channel types can be differentiated by the icons next to them: DTV (digital tv), HD (HD TV), AT (Analogue TV), TV (TV), RD (Radio), encrypted, lock, and at the favourite list.

Listed channels can also be sorted by using the active channel list filter.

Moving a Channel

- First select the desired channel. Select Move option in the channel list and press the **OK** button.
- Edit Number screen will be displayed. Enter the desired channel number by using the numeric buttons on the remote control. If there is a previously stored channel on that number, a warning screen will be displayed. Select Yes if you want to move the channel and press **OK**.
- Press the **OK** button to process. Selected channel is now moved.

Deleting a Channel

You can press **GREEN** button to tag/untag all channels; **YELLOW** button to tag/untag channel.

- Select the channel that you want to delete and select **Delete** option. Press the **OK** button to continue.

- A warning screen will appear. Select **YES** to delete, select **No** to cancel. Press the **OK** button to continue.

Renaming a Channel

- Select the channel that you want to rename and select **Edit Name** option. Press **OK** button to continue.
- Pressing “◀” or “▶” button moves to the previous/next character. Pressing “▼” or “▲” button toggles the current character, i.e., ‘b’ character becomes ‘a’ by “▼” and ‘c’ by “▲”. Pressing the numeric buttons ‘0...9’ replaces the highlighted character with the characters printed above the button one by one as the button is pressed.
- When finished, press the **OK** button to save. Press **MENU** to cancel.

Locking a Channel

You can press **GREEN** button to tag/untag all channels; **YELLOW** button to tag/untag a single channel.

- Select the channel that you want to lock and select **Lock** option. Press **OK** button to continue.
- You will be asked to enter parental control PIN. Default PIN is set as **0000**. Enter the PIN number.



- Press **OK** button when the desired channel is highlighted to lock/unlock the channel. The Lock symbol will be displayed next to the selected channel.

- Select a channel by using “▼” or “▲” button. Press **OK** button to add selected channel to favourites list. Press **OK** button again to remove.

Button Functions

- **OK**: Add/remove a station.
- **YELLOW**: Tag/untag a channel.
- **GREEN**: Tag/untag all channels.
- **BLUE**: Displays filtering options.

Managing Stations: Sorting the Channel List

You can select broadcasts to be listed in the channel list. To display specific types of broadcast, you should use the **Active channel list** setting.

Select **Active** channel list from the Channel list menu by using “▼” or “▲” button. Press **OK** button to continue.



You can select a broadcast type option from the list by using “▼” / “▲” and **OK** buttons.

On-Screen Information

You can press **INFO** button to display on-screen information. Details of the station and current programme will be displayed on the information banner.

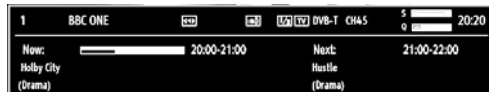

The information banner gives information on the channel selected and the programmes on it. The name of the channel is displayed, along with its channel list number.

Hint: Not all channels broadcast the programme data. If the name and time of the programme are not available, then the information banner will be displayed with blanks.

If the selected channel is locked, you must enter the correct four-digit numeric code to view the channel (default code is **0000**). “**Enter PIN**” will be displayed on the screen.

Managing Stations: Favourites

You can create a list of favourite programmes.

- Press **MENU** button to view the main menu. Select Channel List item by using “◀” or “▶” button. Press **OK** to view menu contents.
- Select **Favourites** to manage favourite list. Use “▼” / “▲” and **OK** buttons to select **Favourites**.
- You can set various channels as favourites so that only the favourite channels are navigated.

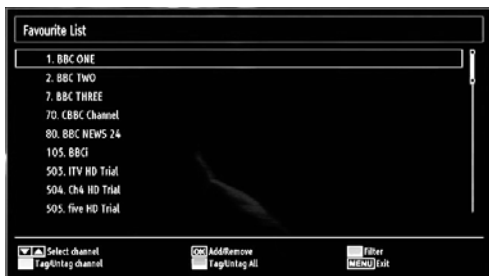

Media Playback Using Media Browser

If the USB stick is not recognized after power off/on or First Time Installation, unplug the USB device, turn the TV off and on again and re-insert the USB device.

To display the Media Browser window, press either "MENU" button on the remote control and then select Media Browser by pressing "◀" or "▶" button. Press OK button to continue. Media Browser menu options will be displayed.

Also, when you insert USB devices, the media browser screen will be displayed automatically:



You can play music, picture and video files from the connected USB memory stick. Use "◀" or "▶" button to select Videos, Photos, Music or Settings.

Viewing Videos via USB



When you select Videos from the main options, the available video files will be filtered and listed on this screen. You can use "▼" or "▲" button to select a video file and press OK button to play a video. If you select a subtitle file and press OK button, you can select or deselect that subtitle file.

Jump (Numeric buttons):The TV will jump to the file starting with the letter you input via the numeric buttons on your remote control.

Play This (OK button) : Plays the selected file.

Play (GREEN button) : Plays all media files starting with the selected one.

Lang (Play Preview): Displays selected file in a small preview screen.

INFO: Changes filter options.

FAV: Sorts files by name.

The following menu will be displayed while playing a video file:

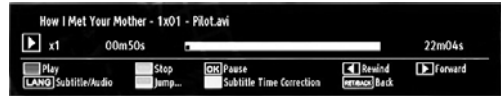

Play (RED button): Starts the video playback.

Stop (BLUE button): Stops the video playback.

Pause (OK button): Pause the video playback.

Rewind (◀ button): Goes backward.

Forward (▶ button): Goes forward.

Subtitle/Audio (LANG. button): Sets subtitle/Audio.

Jump(GREEN button): Opens a menu to select a specific time to jump to in the video. Input the required time and press Green button to jump to the set time.

Yellow: Opens subtitle time correction menu.



Press **YELLOW** button to confirm

Press **⏪** button for clear

Press **⏹** (Cancel) button to switch back to previous menu.

Viewing Photos via USB

When you select Photos from the main options, available image files will be filtered and listed on this screen.



Jump (Numeric buttons):Jump to selected file using the numeric buttons.

OK: Views the selected picture in full screen.

Slideshow (GREEN button): Starts slideshow using all images.

⏪ : Views images in thumbnails.

FAV : Sorts files by date.

Loop/Shuffle (BLUE button): Press once to disable Loop. Press again to disable both Loop and Shuffle. Press once more to enable only Shuffle. Press again to enable all. You can follow the disabled functions with the change of the icons.

Slideshow Options



Zoom (RED button) : Zooms picture.

Note: If a picture is zoomed out/displayed in full screen, you cannot navigate the picture by using Up/Down/Left/Right buttons.

Pause (YELLOW button) : Pauses the slideshow.

Continue (GREEN button) : Continues the slideshow.

Loop/Shuffle (BLUE button): Press once to disable Loop. Press again to disable both Loop and Shuffle. Press once more to enable only Shuffle. Press again to enable all. You can follow the disabled functions with the change of the icons.

Previous/Next (Left/Right buttons): Jumps to previous or next file on slideshow.

Rotate (Up/Down buttons): Rotates the image using up/down buttons.

RETURN (Exit): Back to file list.

INFO: Displays help screen.

Playing Music via USB

When you select Music from the main options, available audio files will be filtered and listed on this screen.



Play (GREEN button): Starts the playback.

Stop (RED button) : Stops playback.

Pause (YELLOW button) : Pauses the selected playback.

FAV : Sorts files by Title, Artist or Album.

Note: If the Viewing Style is set to Folder in Media Browser Settings, Music folder will be displayed as sorted and there is no need to sort files again by pressing the FAV button.

Loop/Shuffle (BLUE button): Press once to disable Loop. Press again to disable both Loop and Shuffle. Press once more to enable only Shuffle. Press again to enable all. You can follow the disabled functions with the change of the icons.

0..9 (Numeric buttons): The TV will jump to the file starting with the letter you input via the numeric buttons on your remote control.

Play This (OK button) : Plays the selected file.

Previous/Next (Left/Right buttons) : Jumps to previous or next file to play.

INFO: Changes filter options.

Media Browser Settings



You can set your Media Browser preferences by using the Settings dialog. Press “▼” or “▲” button to highlight an item and use “◀” or “▶” button to set.

View Style: Sets default browsing mode.

Slide Show Interval: Sets slide show interval time.

Show Subtitle: Sets subtitle enabling preference.

Subtitle Language: Sets supported subtitle language.

Subtitle Position: Sets subtitle position as up or down.

Subtitle Font Size: Sets subtitle font size (max. 54pt).

Changing Image Size: Picture Formats

- You can change the aspect ratio (image size) of the TV for viewing the picture in different zoom modes.
- Press the **SCREEN** button repeatedly to change the image size. Available zoom modes are listed below.

Auto

When AUTO is selected, the aspect ratio of the screen is adjusted by the information provided by the selected source(if available)

Note: Auto mode only will be available in HDMI, YPbPr and DTV sources.

16:9

This uniformly stretches the left and right sides of a normal picture (4:3 aspect ratio) to fill the wide TV screen.



- For 16:9 aspect ratio pictures that have been squeezed into a normal picture (4:3 aspect ratio), use the **16:9** mode to restore the picture to its original shape.

Subtitle

This zooms up the wide picture (16:9 aspect ratio) with subtitles to the full screen.



Note: You can shift to screen up or down by pressing “▼” / “▲” buttons while picture zoom is selected as *panaromic, 14:9 Zoom, Cinema or Subtitle*.

14:9

This zooms up the wide picture (14:9 aspect ratio) to the upper and lower limits of the screen.



14:9 Zoom

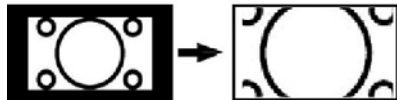

This option zooms to the 14:9 picture.

4:3

Use to view a normal picture (4:3 aspect ratio) as this is its original size.



Panoramic

This stretches the left and right sides of a normal picture (4:3 aspect ratio) to fill the screen, without making the picture appear unnatural.

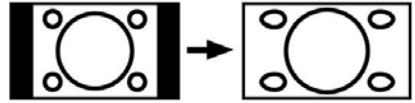

The top and bottom of the picture are slightly cut off.

Cinema

This zooms up the wide picture (16:9 aspect ratio) to the full screen.

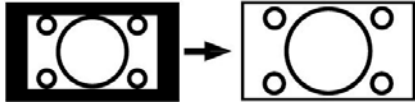

Configuring Picture Settings

You can use different picture settings in detail.

Press **MENU** button and select the Picture icon by using “◀” or “▶” button. Press **OK** button to view Picture Settings menu.

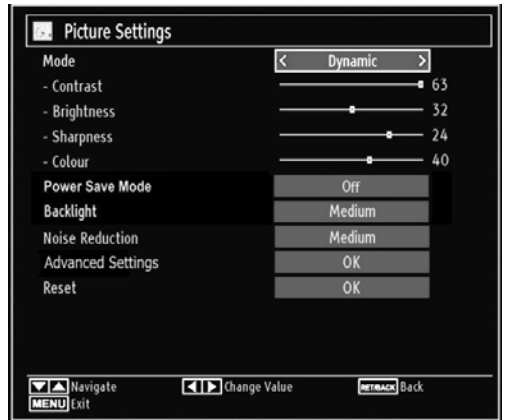

Operating Picture Settings Menu Items

- Press “▼” or “▲” button to highlight a menu item.
- Use “◀” or “▶” button to set an item.
- Press **MENU** button to exit.

Picture Settings Menu Items

Mode: For your viewing requirements, you can set various screen modes. The Picture mode can be set to one of these options: **Cinema, Game, Dynamic** and **Natural**.

Contrast: Sets the lightness and darkness values of the screen.

Brightness: Sets the brightness value for the screen.

Sharpness: Sets the sharpness value for the objects displayed on the screen.

Colour: Sets the colour value, adjusting the colours.

Power Save Mode : Use “▼” or “▲” button to select Power Save Mode. Press “◀” or “▶” button to set Power Save Mode as Eco, Picture Off and Disabled. See the section, “Environmental Information” in this manual for further information on Power Save Mode.

Backlight : This setting controls the backlight level and it can be set to Auto, Minimum, Medium and Maximum.

Noise Reduction: If the broadcast signal is weak and the picture is noisy, use **Noise Reduction** setting to reduce the noise amount. Noise Reduction can be set to one of these options: **Low, Medium, High** or **Off**.

Advanced Settings

• **Colour Temp:** Sets the desired colour tone. *Setting Cool option gives white colours a slight blue stress. For normal colours, select Normal option. Setting Warm option gives white colours a slight red stress.*

• **Picture Zoom:** Sets the picture size to **Auto,16:9, Subtitle,14:9, 14:9 Zoom, 4:3, Panoramic** or **Cinema**.

• **HDMI True Black (optional):** While watching from HDMI source, this feature will be visible in the Picture Settings menu. You can use this feature to enhance blackness in the picture. You can set this feature as “On” for activating HDMI True Black mode.

• **Film Mode (optional):** Films are recorded at a different number of frames per second to normal television programmes. Press “▼” or “▲” buttons to select Film mode. Press “◀” or “▶” buttons to set this feature Auto or Off. Turn this feature to Auto when you are watching films to see the fast motion scenes clearly.

• **Colour Shift:** Adjust the desired colour tone.

Reset: Resets the picture settings to factory default settings.

While in VGA (PC) mode, some items in Picture menu will be unavailable. Instead, VGA mode settings will be added to the Picture Settings while in PC mode.

PC Picture Settings

For adjusting PC picture items, do the following:

Press “◀” or “▶” button to select Picture icon. Picture menu appears on the screen.

Contrast, Brightness, Colour, Colour Temp and Picture Zoom settings in this menu are identical to settings defined in TV picture menu under “Main Menu System”.

Sound, Settings and Source settings are identical to the settings explained in main menu system.

PC Position: Select this to display PC position menu items.

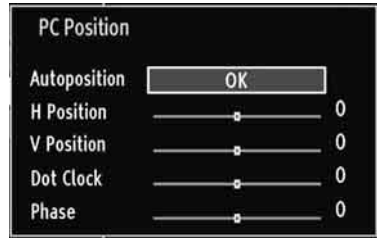

Autoposition: Automatically optimizes the display. Press **OK** to optimize.

H Position: This item shifts the image horizontally to right hand side or left hand side of the screen.

V Position: This item shifts the image vertically towards the top or bottom of the screen.

Dot Clock: Dot Clock adjustments correct the interference that appear as vertical banding in dot intensive presentations like spreadsheets or paragraphs or text in smaller fonts.

Phase: Depending on the resolution and scan frequency that you input to the TV set, you may see a hazy or noisy picture on the screen. In such a case you can use this item to get a clear picture by trial and error.

Configuring Sound Settings

Sound settings can be configured according to your personal preferences.

Press **MENU** button and select the Sound icon by using “◀” or “▶” button. Press **OK** button to view Sound Settings menu.

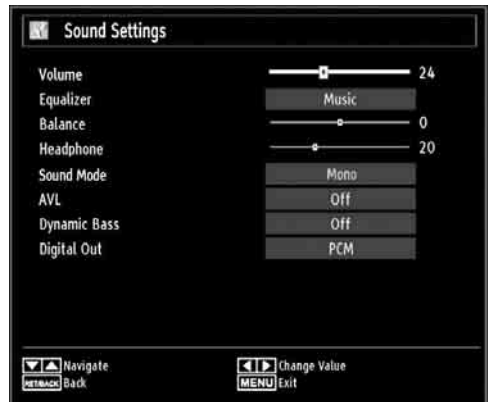

Operating Sound Settings Menu Items

- Press “▼” or “▲” button to highlight a menu item.
- Use “◀” or “▶” button to set an item.

- Press **MENU** button to exit.

Sound Settings Menu Items

Volume: Adjusts volume level.

Equalizer: Press **OK** button to view equalizer sub-menu.

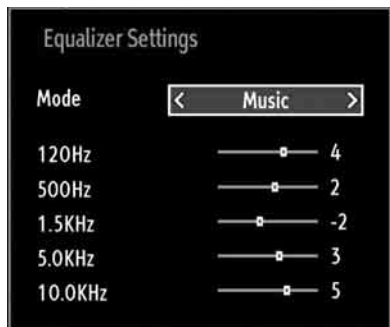

In the equalizer menu, the preset can be changed to **Music**, **Movie**, **Speech**, **Flat**, **Classic** and **User**. Press the **MENU** button to return to the previous menu.

Note: *Equalizer menu settings can be changed manually only when the **Equalizer Mode** is in **User**.*

Balance: This setting is used for emphasizing left or right speaker balance.

Headphone: Sets headphone volume.

Sound Mode: You can select Mono, Stereo, Dual I or Dual II mode, only if the selected channel supports that mode.

AVL: Automatic Volume Limiting (AVL) function sets the sound to obtain fixed output level between programmes (For instance, volume level of advertisements tend to be louder than programmes).

Dynamic Bass: Dynamic Bass is used to increase bass effect of the TV set.

Digital Out: Sets digital out audio type.

Configuring Your TV's Settings

Detailed settings can be configured to suit your personal preferences.

Press **MENU** button and select Settings icon by using “◀” or “▶” button. Press **OK** button to view Settings menu.



Operating Settings Menu Items

- Press “▼” or “▲” button to highlight a menu item.
- Press **OK** button to select an item.
- Press **MENU** button to exit.

Settings Menu Items

Conditional Access: Controls conditional access modules when available.

Language: Configures language settings.

Parental: Configures parental settings.

Timers: Sets timers for selected programmes.

Date/Time: Sets date and time.

Sources: Enables or disables selected source options.

Other Settings: Displays other setting options of the TV set.

Using a Conditional Access Module (not included)

IMPORTANT: Insert or remove the CI module only when the TV is SWITCHED OFF.

- In order to watch certain digital channels, a conditional access module (CAM) may be necessary. This module must be inserted in the CI slot of your TV.
- Obtain the Conditional Access Module (CAM) and the viewing card by subscribing to a pay channel company, then insert those to the TV using the following procedure.
- Insert the CAM and then the viewing card to the slot that is located in the terminal cover at the rear side of the TV.
- The CAM should be correctly inserted, it is impossible to insert fully if reversed. The CAM or the TV terminal may be damaged if the CAM is forcefully inserted.

Connect the TV to the mains supply, switch on and then wait for few moments until the card is activated.

- Refer to the module instruction manual for details of the settings.

Viewing Conditional Access Menu (*)

(*) These menu settings may change depending on the service provider.

Press **MENU** button and select the settings icon by using “◀” or “▶” button. Press **OK** button to view Settings menu. Use “▼” or “▲” button to highlight **Conditional Access** and press **OK** to view menu items.

When no module is inserted, “**No Common Interface module detected**” message appears on the screen.

Configuring Language Preferences

You can operate the TV's language settings using this menu.

Press **MENU** button and select the Settings icon by using “◀” or “▶” button. Press **OK** button to view Settings menu. Use “▼” or “▲” button to highlight **Language** and press **OK** to continue:

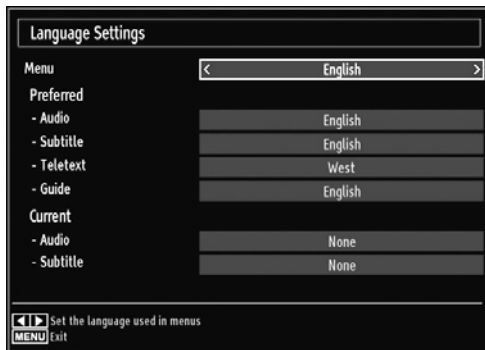

Use “▼” or “▲” button to set an item. Settings are stored automatically.

Menu: displays the system language.

Preferred

These settings will be used if available. Otherwise the current settings will be used.

- **Audio:** Sets the preferred audio language.
- **Subtitle:** Sets the subtitle language. Selected language will be seen in subtitles.
- **Teletext:** Sets teletext language.
- **Guide:** Sets the preferred Guide language.

Current (*)

(*) These settings can be changed if only the broadcaster supports. Otherwise, settings will not be available to be changed.

- **Audio:** Changes the audio language for the current channel.
- **Subtitle:** Sets the subtitle language for the current channel.

Note: If the Country option is set to Denmark, Sweden, Norway or Finland, the Language Settings menu will function as described below:

Language Settings



In the configuration menu, highlight the Language Settings item by pressing “▼” or “▲” buttons. Press OK and Language Settings submenu will be displayed on the screen:

Use “▼” or “▲” buttons to highlight the menu item that will be adjusted and then press “◀” or “▶” button to set.

Notes:

- System Language determines the on-screen menu language.
- Audio Language is used for selecting the soundtrack of a channels.
- Primary settings are the first priority when multiple choices are available on a broadcast. Secondary settings are the alternatives when the first options are not available.

Parental Control

To prohibit viewing of certain programmes, channels and menus can be locked by using the parental control system.

This function enables or disables the menu protection system and allows the PIN code to be changed.

Press **MENU** button and select the Settings icon by using “◀” or “▶” button. Press **OK** button to view Settings menu. Use “▼” or “▲” button to highlight **Parental** and press **OK** to continue:



To display parental lock menu options, the PIN number should be entered. The factory default PIN number is **0000**.

After coding the correct PIN number, parental settings menu will be displayed:



Parental Settings Menu Operation

- Select an item by using “▼” or “▲” button.
- Use “◀” or “▶” button to set an item.
- Press **OK** button to view more options.

Menu Lock: Menu lock setting enables or disables the menu access. You can disable access to the installation menu or the whole menu system.

Maturity Lock (Optional): When set, this option gets the maturity information from the broadcast and if this maturity level is disabled, disables access to the broadcast.

Child Lock: When Child Lock is set, the TV can only be controlled by the remote control. In this case the control panel buttons will not work. Hence, if one of those buttons is pressed, **Child Lock Is On** will be displayed on the screen when the menu screen is not visible.

Set PIN: Defines a new PIN number. Use numeric buttons to enter a new pin number. You will need to enter your new pin a second time for verification purposes.

IMPORTANT: The factory default pin number is **0000**, if you change the pin number make sure you write it down and keep it safe.

Timers

To view Timers menu, press **MENU** button and select Settings icon by using “◀” or “▶” button. Press **OK** button to view Settings menu. Use “▼” or “▲” button to highlight Timers and press **OK** to continue:

Setting Sleep Timer

This setting is used for setting the TV to turn off after a certain time.

- Highlight Sleep Timer by using “▼” or “▲” button.
- Use “◀” or “▶” button to set. The timer can be programmed between **Off** and **2.00** hours (120 minutes) in steps of 30 minutes.

Setting Programme Timers

You can set programme timers for a particular programme using this feature.

Press “▼” button to set timers on an event. Programme timer function buttons will be displayed on the screen.

Adding a Timer

- Press **YELLOW** button on the remote control to add a timer. The following menu appears on the screen:

Channel: Changes network type by using “◀” or “▶”.

Timer Type: This feature is unavailable to be set.

Date: Enter a date using the numeric buttons.

Start: Enter a starting time using the numeric buttons.

End: Enter an ending time using the numeric buttons.

Duration: Displays duration between the starting and ending time.

Repeat: Sets a timer to be repeated as Once, Daily or Weekly. Use “◀” or “▶” buttons to select an option.

- Press **GREEN** button to save the timer. Press **RED** button to cancel.

Change/Delete: Controls parental settings on timers.

Editing a Timer

- Select the timer you want to edit by pressing “▼” or “▲” button.
- Press **GREEN** button. Edit Timer menu screen will be displayed.
- When finished with editing, press **GREEN** button to save. You can press **MENU** button to cancel.

Deleting a Timer

- Select the timer you want to delete by pressing “▼” or “▲” button.
- Press **RED** button.
- Select **YES** by using “◀” or “▶” buttons to delete the timer. Select **NO** to cancel.

Configuring Date/Time Settings

Select **Date/Time** in the Settings menu to configure Date/Time settings. Press **OK** button.

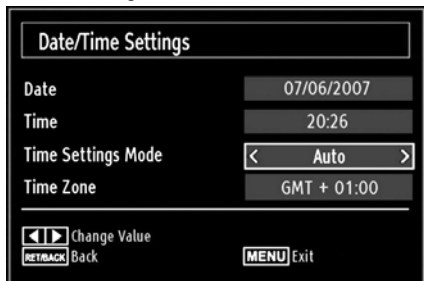

- Use “▼” or “▲” buttons to highlight **Date/Time**.

Date, Time, Time Settings Mode and Time Zone Setting will be available.

Use “▼” or “▲” buttons to highlight the Time Settings Mode. Time Settings Mode is set using “◀” or “▶” buttons. It can be set to AUTO or MANUAL.

When AUTO is selected, Date/Time and Time Zone options will not be available to be set. If MANUAL option is selected as the Time Zone can be altered:

- By pressing “▼” or “▲” buttons select Time Zone.

Use “◀” or “▶” buttons to change the Time Zone between GMT-12 or GMT+12. Date/Time on the top of the menu list will then change according to the selected Time Zone.

- Changes are automatically stored. Press **MENU** to exit.

Configuring Source Settings

You can enable or disable selected source options. The TV will not switch to the disabled source options when **SOURCE** button is pressed.



- Select **Sources** in the Settings menu and press **OK** button.
- Press “▼” or “▲” buttons to select a source.
- Use “◀” or “▶” button to enable or disable the selected source. Changes are automatically stored.

Note : YPbPr mode can be used only when you connect a device that has a YPbPr output through the PC input with YPbPr to PC cable (not supplied).

Configuring Other Settings

To view general configuration preferences, select **Other Settings** in the Settings menu and press **OK** button.

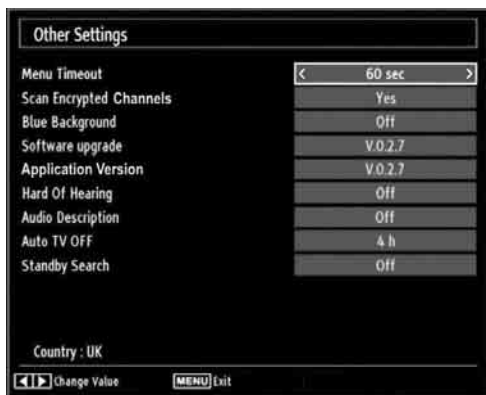

Operation

- Press “▼” or “▲” buttons to select an item.
- Use “◀” or “▶” button to set an option.
- Press **OK** button to view a sub-menu.

Menu Timeout: Changes timeout duration for menu screens.

Scan Encrypted Channels: When this setting is on, search process will locate the encrypted channels as well. If it is set as **Off**, encrypted channels will not be located in automatic search or manual search.

Blue Background (Optional): Activates or deactivates blue background system when the signal is weak or absent.

Software Upgrade: To ensure that your TV always has the up to date information, you can use this setting. In order for the proper operation, please ensure that the TV is set to standby mode.



You can enable or disable automatic upgrade by setting **Automatic Scanning** option.

You can manually search for new software by selecting **Scan for upgrade**.

Application version: Displays the current application version.

Hard of Hearing: If the broadcaster enables any special signal concerning the audio, you can set this setting as On to receive such signals.

Audio Description: Audio description refers to an additional narration track for blind and visually impaired viewers of visual media, including television and movies. The description narrator talks through the presentation, describing what is happening on the screen during the natural pauses in the audio (and sometimes during dialogue, if deemed necessary). You can use this feature, only if the broadcaster supports that additional narration track.

Auto TV Off: You can set the timeout value of auto off feature. After the timeout value is reached and the TV is not operated for selected time, the TV will go off.

Standby Search (optional): Use “▼” or “▲” button to select Standby Search and then press “◀” or “▶” button to set this setting as On or Off. If you change Standby Search to Off, this function will be unavailable. To use Standby search please make sure that you select Standby Search as On.

If the Standby Search is set to On, when the TV is in standby mode, available broadcasts will be searched. If the TV locates any new or missing broadcasts, a menu screen will be displayed, asking you whether or not to execute these changes.

Other Features

Displaying TV Information: Programme Number, Programme Name, Sound Indicator, time, teletext, channel type and resolution information is displayed on the screen when a new programme is entered or “**INFO**” button is pressed.

Mute Function: Press “✕” button to disable sound. Mute indicator will be displayed in the upper corner of the screen. To cancel mute, there are two alternatives; the first one is pressing the “✕” button and the second one is increasing the volume level.

Picture Mode Selection: By pressing **PRESETS** button, you can change **Picture Mode** settings in accordance with your viewing requirements. Available options are Dynamic, Natural, Cinema and Game.

Displaying Subtitles: You can enable subtitles by pressing the **SUBTITLE** button of the remote control. Press **LANG** button to select subtitle language and press **SUBTITLE** button to display available subtitles.

If “**Subtitle**” is **On**, pressing the  button causes the following warning message display on the screen (** for UK only)

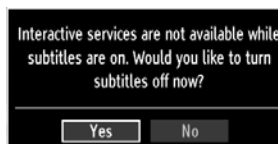

Teletext (Analogue)

The teletext system transmits information such as news, sports and weather on your TV. Note that if the signal degrades, for example in poor/adverse weather conditions, some text errors may occur or the teletext mode may be aborted.

Teletext function buttons are listed below:

 **Teletext / Mix** : Activates teletext mode when pressed once. Press again to place the teletext screen over the programme (mix). Pressing again will quit the teletext mode.

“RETURN” Index: Selects the teletext index page.

“INFO”Reveal: Shows hidden information (e.g. solutions of games).

“OK” Hold: Holds a text page when convenient. Press again to resume.

 **Subcode Pages** : Selects subcode pages if available when the teletext is activated.

P+ or P- and numbers (0-9): Press to select a page.

Note: Most TV stations use code 100 for their index pages.

Coloured Buttons (RED/GREEN/YELLOW/BLUE)

Your TV supports both **FASTTEXT** and **TOP text** systems. When these systems are available, the pages are divided into groups or topics. When **FASTTEXT** system is available, sections in a teletext page will become colour-coded and can be selected by pressing the coloured buttons. Press a coloured button that corresponds to with your needs. The coloured writings will appear, showing you which coloured buttons to use when **TOP text** transmission is present. Pressing “▼” or “▲” commands will request the next or previous page respectively.

Teletext (Digital)

Digital teletext is controlled by reading the instructions displayed on the teletext pages. Most instructions are simple and easy to follow.

Tips

Screen Care: Clean the screen with a slightly damp, soft cloth. Do not use abrasive solvents as they may damage the coating layer of the TV screen. For your safety, unplug the mains plug when cleaning the set. When moving the TV, hold it properly from the bottom of the unit.

Image Persistence: Please note that ghosting may occur while displaying a persistent image. On LCD TVs' image persistence may disappear after a short time. Try turning the TV off for a while.

To avoid this, do not leave the screen in still picture for extended periods.

No Power: If your TV system has no power, please check the main power cable and connection to the mains socket outlet.

Poor Picture: Have you selected the correct TV system? Is your TV set or house aerial located too close to a non-earthed audio equipment or neon lights, etc.? Mountains or high buildings can cause double pictures or ghost images. Sometimes you can improve the picture quality by changing the direction of the aerial. Is the picture or teletext unrecognisable? Check if you have entered the correct frequency. Please retune the channels. The picture quality may degrade when two peripherals are connected to the TV at the same time. In such a case, disconnect one of the peripherals.

No Picture: Is the aerial connected properly? Are the plugs connected tightly to the aerial socket? Is the aerial cable damaged? Are suitable plugs used to connect the aerial? If you are in doubt, consult your dealer. No Picture means that your TV is not receiving a transmission. Have you selected the correct button on the remote control? Try once more. Also make sure the correct input source has been selected.

Sound: If you cannot hear any sound, check to see if the “” button has been pressed. If sound is coming from only one speaker, check if the audio balance has been set to one extreme.

Remote Control: Your TV no longer responds to the remote control. Perhaps the batteries are exhausted. If so you can still use the local buttons on the TV.

Input Sources: If you cannot select an input source, it is possible that no device is connected. Check the AV cables and connections if you have tried to connect a device

Appendix A: PC Input Typical Display Modes

The display has a maximum resolution of 1920 x 1200. The following table is an illustration of some of the typical video display modes. Your TV may not support different resolutions. Supported resolution modes are listed below. If you switch your PC to an unsupported mode, a warning OSD will appear on the screen.

Index	Resolution	Frequency
1	640x350	85 Hz
2	640x400	70 Hz
3	640x480	60Hz-66Hz-72Hz -75Hz-85Hz
4	800x600	56Hz-60Hz-70Hz-72Hz -75Hz-85Hz
5	832x624	75 Hz
6	1024x768	60Hz-66Hz-70Hz-72Hz -75Hz
7	1152x864	60Hz-70Hz-75Hz -85 Hz
8	1280x768	60 Hz
9	1280x768	75Hz-85Hz
10	1280x960	60Hz-75Hz-85Hz
11	1280x1024	60Hz-75Hz-85Hz
12	1360x768	60 Hz
13	1400x1050	60 Hz
14	1400x1050	75Hz-85Hz
15	1400x900	65Hz-75Hz
16	1600x1200	60 Hz
17	1680x1050	60 Hz
18	1920x1080	60 Hz
19	1920x1200	60Hz

Appendix B: AV and HDMI Signal Compatibility (Input Signal Types)

Source	Supported Signals		Available
EXT (SCART)	PAL 50/60		O
	NTSC 60		O
	RGB 50		O
	RGB 60		O
Side AV	PAL 50/60		O
	NTSC 60		O
YPbPr	480I	60Hz	O
	480P	60Hz	O
	576I	50Hz	O
	576P	50Hz	O
	720P	50Hz	O
	720P	60Hz	O
	1080I	50Hz	O
	1080I	60Hz	O
	1080P	50Hz	O
	1080P	60Hz	O
HDMI	480I	60Hz	O
	480P	60Hz	O
	576I	50Hz	O
	576P	50Hz	O
	720P	50Hz	O
	720P	60Hz	O
	1080I	50Hz	O
	1080I	60Hz	O
	1080P	24Hz	O
	1080P	25Hz	O
1080P	30Hz	O	
1080P	50Hz	O	
1080P	60Hz	O	

(X: Not Available, O: Available)

In some cases a signal on the LCD TV may not be displayed properly. The problem may be an inconsistency with standards from the source equipment (DVD, Set-top box, etc.). If you do experience such a problem please contact your dealer and also the manufacturer of the source equipment.

Appendix C: Supported DVI Resolutions

When connecting devices to your TV's connectors by using DVI to HDMI cables (not supplied), you can refer to the following resolution information.

Index	Resolution	Frequency
1	640x400	70Hz
2	640x480	60Hz-66Hz-72Hz-75Hz
3	800x600	56Hz-60Hz-70Hz-72Hz-75Hz
4	832x624	75 Hz
5	1024x768	60Hz-66Hz-70Hz-72Hz-75Hz
6	1152x864	60Hz-70Hz-75Hz
7	1152x870	75Hz
8	1280x768	60 Hz
9	1280x768	75Hz
10	1280x960	60Hz-75Hz
11	1280x1024	60Hz-75Hz
12	1360x768	60 Hz
13	1400x1050	60 Hz
14	1400x1050	75Hz
15	1400x900	65Hz-75Hz
16	1600x1200	60 Hz
17	1680x1050	60 Hz
18	1920x1080	60 Hz
19	1920x1200	60Hz
20	480i-480p	60Hz
21	576i-576p	50Hz

Appendix D: Software Upgrade

- Your TV is capable of finding and updating new software upgrades over broadcast channels.
- For broadcast channels search, the TV looks at the available channels stored in your settings. So before the software upgrade search, it is advised to auto search and update all available channels.

1) Software upgrade search via user interface

- It is possible to manually check if there is a new software upgrade for your TV set.
- Simply navigate on your main menu. Choose **Settings** and select **Other Settings** menu. In **Other Settings** menu navigate on to the **Software Upgrade** item and press **OK** button to open **Upgrade Options** menu.
- In **Upgrade Options** menu select **Scan for upgrade** and press **OK** button.
- If a new upgrade is found, it starts to download the upgrade. A progress bar indicates the remaining download progress. When the download completes successfully a message is displayed for reboot to activate new software. Press **OK** to continue with the reboot operation.

2) 3.AM search and upgrade mode

- If **Automatic scanning** in **Upgrade Options** menu is enabled, the TV wakes up at 03:00 and searches the broadcast channels for new software upgrade. If new software is found and downloaded successfully, with the next power up the TV opens with new software version.

Note on reboot operation: *Reboot is the last step in software upgrade operation if download of new software is finished successfully. During reboot TV makes final initializations. In the reboot sequence panel power is closed and front LED indicates the activity with blinking. Around 5 minutes later TV restarts with new software activated.*

- If your TV fails to restart in 10 minutes, unplug power for 10 minutes and re-plug again. TV should open with new software safely. If you still can not get TV working, please kindly repeat unplug and plug sequence a few times more. If your set still can not operate, please call the service personnel to fix the problem for you.

Caution: *While the LED is blinking during reboot do not unplug your TV's power. Doing this may cause your TV not to re-start again and can only be fixed by service personnel.*

Appendix E : Supported File Formats for USB Mode

Media	File Extension	Format		Remarks
		Video	Audio	(Maximum resolution/Bit rate etc.)
Movie	.mpg, .mpeg	MPEG1, 2	MPEG Layer 1/2/3	MAX 1920x1080 @ 30P 20Mbit/sec
	.dat	MPEG1, 2	MPEG2	
	.vob	MPEG2		
	.avi	MPEG2	PCM/MPEG3	MAX 1920x1080 @ 30P 20Mbit/sec
	Xvid 1.00, Xvid 1.01, Xvid 1.02, Xvid 1.03, Xvid 1.10-beta1/2	PCM		
Music	.mp3	-	MPEG 1 Layer 1 / 2 (MP3)	32Kbps ~ 320Kbps(Bit rate) 32KHz ~ 48KHz(Sampling rate)
Photo	.jpg .jpeg	Baseline JPEG		max WxH = 15360x8640 4147200bytes
		Progressive JPEG		max WxH = 1024x768 6291456bytes
	.bmp	-	-	max WxH = 9600x6400 3840000bytes
Subtitle	.sub	-	-	-
	.srt	-	-	-



Products



Battery

Information for Users on Disposal of old Equipment and Batteries

[European Union only]

These symbols indicate that equipment with these symbols should not be disposed of as general household waste. If you want to dispose of the product or battery, please consider the collection systems or facilities for appropriate recycling.

Notice: The sign Pb below the symbol for batteries indicates that this battery contains lead.

Specifications

TV BROADCASTING

PAL/SECAM B/G D/K K' I/I' L/L'

RECEIVING CHANNELS

VHF (BAND I/III)

UHF (BAND U)

HYPERBAND

NUMBER OF PRESET CHANNELS

1000

CHANNEL INDICATOR

On Screen Display

RF AERIAL INPUT

75 Ohm (unbalanced)

OPERATING VOLTAGE

220 V - 240 V AC, 50 Hz.

AUDIO

German + Nicam Stereo

AUDIO OUTPUT POWER (W_{RMS}) (10% THD)

2 x 2,5

POWER CONSUMPTION (W)

50 W (max)

< 0,5 W (Standby)

PANEL

16:9 display, 24" Screen Size

DIMENSIONS (mm)

WxHxD (With stand): 579 x 408 x 135

Weight (kg): 5,20

WxHxD (Without stand): 579 x 372 x 35

Weight (kg): 4,80

Digital Reception DVB-T	MHEG-5 ENGINE compliant with ISO/IEC 13522-5 UK engine Profile 1	
	Object carousel support compliant with ISO/IEC 135818-6 and UK DTT profile	for UK
	Frequency range: 474 MHz - 850 MHz for UK models	
	170-862 MHz for EU models	
	Transmission standard: DVB-T. MPEG-2	
	Demodulation: COFDM with 2K/8K FFT mode	
	FEC: all DVB modes	
	Video: MP@ML, PAL, 4:3/16:9	
Audio: MPEG Layer I&II 32 kHz / 44.1kHz / 48kHz.		

We apologise for any inconvenience caused by minor inconsistencies in these instructions, which may occur as a result of product improvement and development.