

**X6 X7**



**InFocus**

**Reference Guide**













# Table of Contents

Table of Contents .....	1
Usage Notice.....	2
<i>Precautions</i> .....	2
<i>Important Operating Considerations for Safety</i> .....	4
Introduction.....	5
<i>Product Features</i> .....	5
<i>Package Overview</i> .....	6
<i>Product Overview</i> .....	7
<i>Main Unit</i> .....	7
<i>Connection Ports</i> .....	8
<i>Wireless Remote Control</i> .....	9
Operation.....	11
<i>Connecting the Projector</i> .....	11
<i>Powering On/Off the Projector</i> .....	12
<i>Powering On the Projector</i> .....	12
<i>Powering Off the projector</i> .....	13
<i>Warning Indicator</i> .....	14
<i>Adjusting the Projected Image</i> .....	15
<i>Adjusting the Height of Projector Image</i> .....	15
<i>Adjusting the Projector Zoom / Focus</i> .....	16
<i>Adjusting Projected Image Size</i> .....	16
User Controls .....	17
<i>On Screen Display Menus</i> .....	17
<i>How to operate</i> .....	17
<i>Image (PC Mode)</i> .....	18
<i>Image (Video Mode)</i> .....	20
<i>Display Setting</i> .....	22
<i>Default Setting</i> .....	24
<i>Language</i> .....	26
<i>Information</i> .....	27
Appendices.....	28
<i>Troubleshooting</i> .....	28
<i>Replacing the lamp</i> .....	33
<i>Compatibility Modes</i> .....	35

## Precautions

*Follow all warnings, precautions and maintenance as recommended in this user's guide to maximize the life of your unit.*

-  Warning- Do not look into the projector's lens when the lamp is on. The bright light may hurt your eyes.
-  Warning- To reduce the risk of fire or electric shock, do not expose this product to rain or moisture.
-  Warning- Please do not open or disassemble the product as this may cause electric shock.
-  Warning- When changing the lamp, please allow unit to cool down, and follow all changing instructions.
-  Warning- Hg – Lamp contains mercury. Manage in accordance with local disposal laws. See **[www.lamprecycle.org](http://www.lamprecycle.org)**.
-  Warning- This product will detect the life of the lamp itself. Please be sure to change the lamp when it shows warning messages.
-  Warning- Reset the “Lamp Reset” function from the On Screen Display “Default Setting” menu after replacing a new lamp module (refer to page 25).
-  Warning- When the lamp reaches the end of its life, it will burn out and may make a loud popping sound. If this happens, the projector will not turn back on until the lamp module has been replaced. To replace the lamp, follow the procedures listed under “Replacing the Lamp”.
-  Caution- When switching the projector off, please ensure the projector completes its cooling cycle before disconnecting power.
-  Caution- Turn on the projector first and then the signal sources.
-  Caution- Do not use lens cap when projector is in operation.

# Usage Notice

## *Do:*

- ❖ Turn off the product before cleaning.
- ❖ Use a soft cloth moistened with mild detergent to clean the display housing.
- ❖ Disconnect the power plug from AC outlet if the product is not being used for a long period of time.

## *Don't:*

- ❖ Block the slots and openings on the unit provided for ventilation.
- ❖ Use abrasive cleaners, waxes or solvents to clean the unit.
- ❖ Use under the following conditions:
  - In extremely hot, cold or humid environments.
  - In areas susceptible to excessive dust and dirt.
  - Near any appliance that generates a strong magnetic field.

## Important Operating Considerations for Safety

- ◆ Place the projector in a horizontal position no greater than 15 degrees off axis.
- ◆ Locate the projector in a well-ventilated area without any obstructions to intake or exhaust vents. Do not place the projector on a tablecloth or other soft covering that may block the vents.
- ◆ Locate the projector at least 4' (1.2 m) away from any heating or cooling vents.
- ◆ Use only the power cord provided. A surge-protected power strip is recommended.
- ◆ Refer to this guide for proper startup and shutdown procedures.
- ◆ In the unlikely event of a lamp rupture, particles may exit through the projector side vents. When the projector is turned on, keep people, food, and drinks out of the "keep out" area under and around the projector, as indicated by the "X" areas below.

Follow these instructions to help ensure image quality and lamp life over the life of the projector. Failure to follow these instructions may affect the warranty. For complete details of the warranty, see the Warranty booklet.

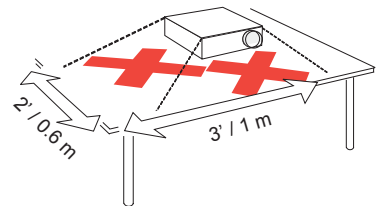
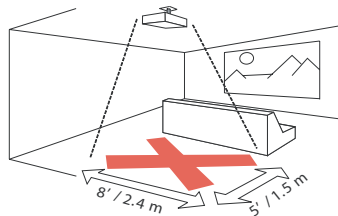

## Product Features

*This product is a SVGA/XGA single chip 0.55" DLP® projector. Outstanding features include:*

- ◆ True SVGA, 800 x 600 addressable pixels  
True XGA, 1024 x 768 addressable pixels
- ◆ Single chip Dark Chip2™ DLP® technology
- ◆ NTSC/NTSC4.43/PAL/PAL-M/PAL-N/SECAM and SDTV(480i/576i), EDTV(480p/576p), HDTV(720p/1080i) compatible
- ◆ Multi-Auto functions: Auto detection, Auto image and Auto saving the adjustments
- ◆ Full function remote control
- ◆ User friendly multilingual on screen display menu
- ◆ Advanced digital keystone correction and high quality full screen image re-scaling
- ◆ Built-in one 2-Watt speaker.
- ◆ SXGA+, SXGA compression and VGA, SVGA re-sizing (XGA)  
SXGA, XGA compression and VGA re-sizing (SVGA)
- ◆ Mac compatible

# Introduction

## Package Overview

*This projector comes with all the items shown below. Check to make sure your unit is complete. Contact your dealer immediately if anything is missing.*



❖ Due to the difference in applications for each country, some regions may have different accessories.

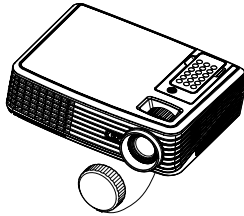

Projector with lens cap



Wireless Remote Controller

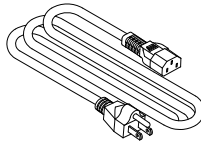

Power Cord

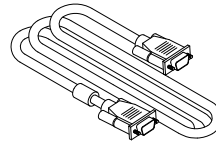

VGA Cable

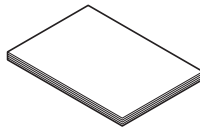

Document Pack

## Product Overview

### Main Unit

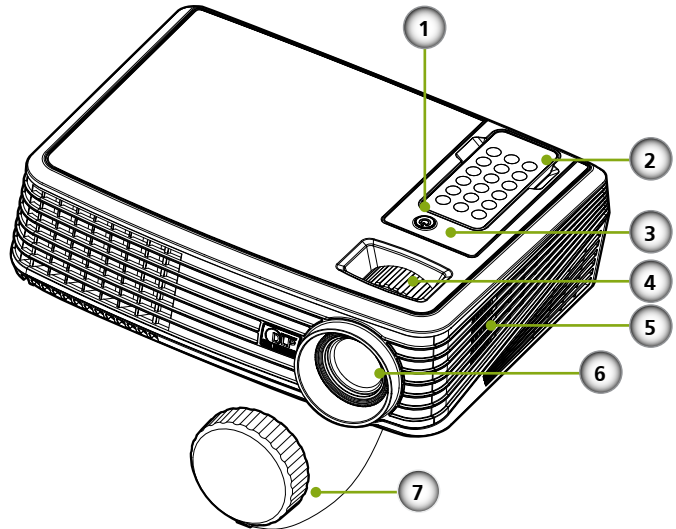

1. Power
2. Remote Controller
3. IR Receiver
4. Zoom and Focus Lever
5. Speaker
6. Lens
7. Lens Cap



## Connection Ports

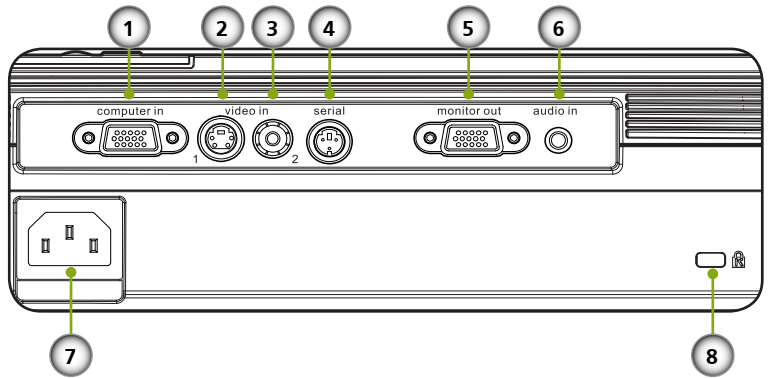

1. Computer Input Connector
2. Video 1: S-Video Input Connector
3. Video 2: Composite Video Input Connector
4. Serial Control Connector
5. Monitor Output Connector
6. Audio Input Connector
7. Power Socket
8. Kensington™ Lock Port

## Wireless Remote Control



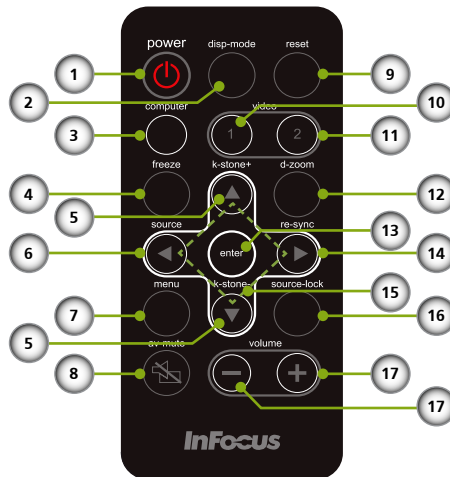
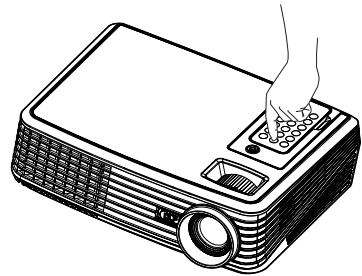

❖ Please DO NOT remove the remote controller by other means than the method stated. Any improper action to remove the remote controller may cause damage to the slot.

- ❖ To remove remote controller from the projector, you may simply press down the top-center of the remote controller, then the remote controller will bounce up to be removed.



#	Icon	Function	Description
1		Power	Refer to the "Power On/Off the Projector" section on pages 12-13.
2		Display Mode	Select the display mode from PC, Movie, sRGB, Game and User.
3		Computer Source	Press "computer" to choose computer in connector.
4		Freeze	To pause the screen image.

# Introduction

5	Keystone Correction	Adjust the image to compensate for distortion caused by tilting the projector (vertical $\pm 15$ degrees).
6	Source	Press "source" to choose RGB, Component, S-Video, Composite and HDTV sources.
7	Menu	Press "menu" to launch the On-screen display (OSD) menu, back to the top level of OSD menu for the OSD main menu operation
8	 AV-Mute	Momentarily turn off/on the audio and video.
9	Reset	Change the adjustments and settings to the factory default value.
10	Video 1 Source (S-Video)	Press "video 1" to choose video 1 connector.
11	Video 2 Source (Composite)	Press "video 2" to choose video 2 connector.
12	Digital Zoom	Zoom the projector display in or out.
13	Enter	Confirm your section of items in sub menu operation.
14	Re-Sync	Automatically synchronize the projector to the input source.
15	 Four Directional Select Keys	Use up, down, left, right s to select items or make adjustments to your selection.
16	Source Lock	Press "source-lock" to lock specified connection port; press this again to unlock.
17	Volume -/+	Increase/decrease speaker volume.

## Connecting the Projector

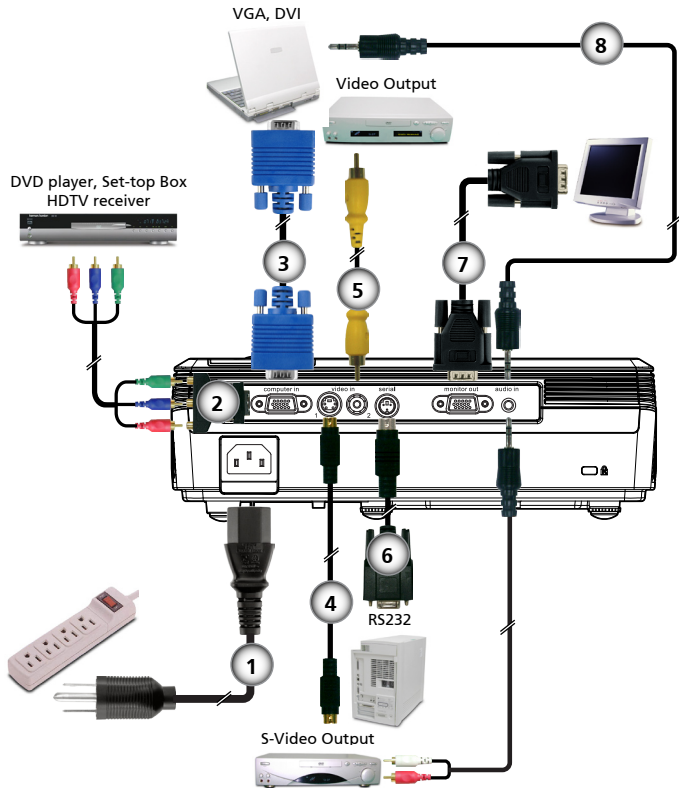

❖ Due to the difference in applications for each country, some regions may have different accessories.

- |        |                               |
|--------|-------------------------------|
| 1..... | Power cord                    |
| 2..... | D-15 to RCA adapter for YPbPr |
| 3..... | VGA in cable                  |
| 4..... | S-Video cable                 |
| 5..... | Composite video cable         |
| 6..... | RS232 cable                   |
| 7..... | VGA out cable                 |
| 8..... | Audio cable jack to jack      |

❖ To ensure the projector works well with your computer, please make sure the timing of the display mode is compatible with your projector.

## Powering On/Off the Projector

### Powering On the Projector

1. Remove the lens cap. ❶
  2. Ensure that the power cord and signal cable are securely connected. The Power LED will turn flash blue.
  3. Turn on the lamp by pressing “Power/Standby” on the control panel. ❷ The startup screen will display for about 25 seconds and the Power LED will turn blue.
  4. Turn on your source (computer, notebook, video player, etc.) The projector will detect your source automatically.
- ❖ If you connect multiple sources at the same time, use the “source” on the remote control or use the “computer”, “video 1”, “video 2” on the remote control to switch.



❖ Turn on the projector first and then the signal sources.

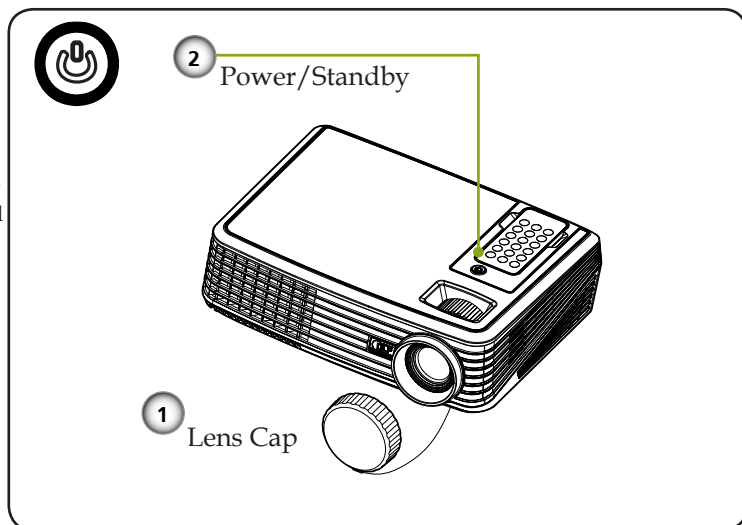

## Powering Off the Projector

1. Press the “Power/Standby” to turn off the projector lamp, you will see a message as below on the on-screen display.

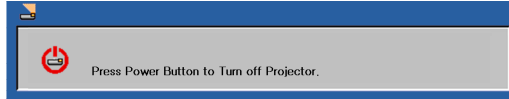

2. Press the “Power/Standby” again to confirm.
3. The cooling fan continues to operate for about 120 seconds for cooling cycle and the Power LED will flash blue. When the light starts flashing, the projector has entered standby mode.

If you wish to turn the projector back on, you must wait until the projector has completed the cooling cycle and has entered standby mode. Once in standby mode, simply press “Power/Standby” to restart the projector.

4. Disconnect the power cord from the electrical outlet and the projector.
5. Do not turn on the projector immediately following a power off procedure.

## Warning Indicator

- ❖ When the “Power” LED indicator turns red, it indicates the projector has overheated. The projector will automatically shut itself down.

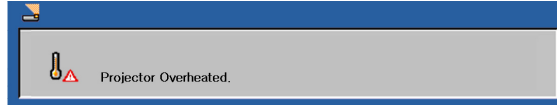

- ❖ When the “Power” LED indicator flashes red and the message below displays onscreen, it indicates the projector will detect the lamp life itself. When you see this message, change the lamp as soon as possible or contact your local dealer or our service center.

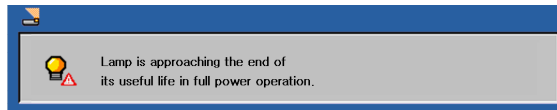

- ❖ When the “Power” LED indicator flashes red and the message below displays onscreen, it indicates the fan failed. Stop using the projector and disconnect the power cord from the electrical outlet, then contact your local dealer or our service center.



## Adjusting the Projected Image

### Adjusting the Height of Projector Image

*The projector is equipped with elevator feet for adjusting the height of image.*

To raise/lower the image:

1. Use **1** to fine-tune the display angle.

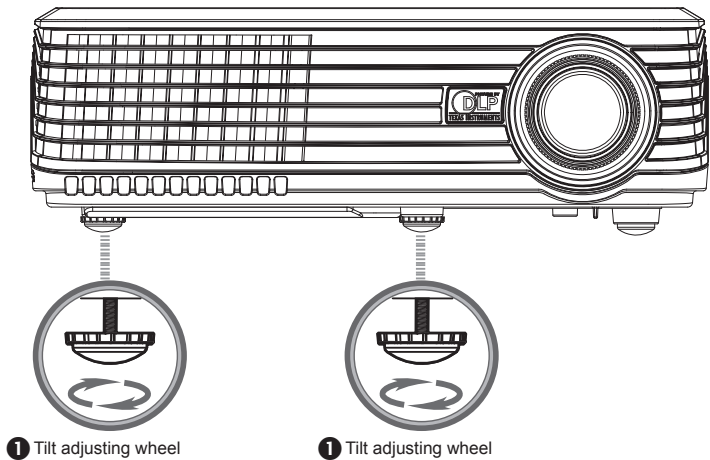



## Adjusting the Projector Zoom / Focus

You may turn the zoom lever to zoom in or out. To focus the image, rotate the focus ring until the image is clear. The projector will focus at distances from 3.9 to 39.4 feet (1.2 to 12.0 meters) with mechanical travel.

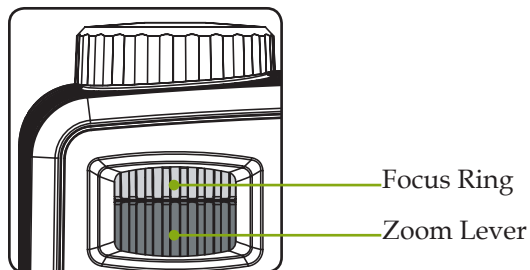

## Adjusting Projection Image Size

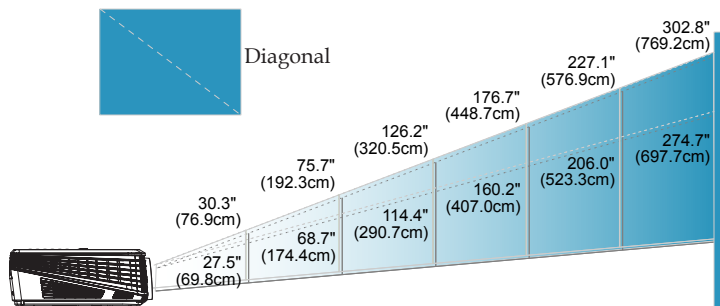

		3.9'(1.2m)	9.8'(3.0m)	16.4'(5.0m)	23.0'(7.0m)	29.5'(9.0m)	39.4'(12.0m)
Screen (Diagonal)	Max.	27.5"(69.8cm)	75.7"(192.3cm)	126.2"(320.5cm)	176.7"(448.7cm)	227.1"(576.9cm)	302.8"(769.2cm)
	Min.	30.3"(76.9cm)	68.7"(174.4cm)	114.4"(290.7cm)	160.2"(407.0cm)	206.0"(523.3cm)	274.7"(697.7cm)
Screen Size	Max.(WxH)	24.2" x 18.2" (61.5 x 46.2cm)	60.8" x 46.4" (154.4 x 118.3cm)	101.0" x 75.7" (256.9 x 192.3cm)	141.3" x 106.0" (358.9 x 269.2cm)	181.7" x 138.3" (461.5 x 348.2cm)	242.5" x 181.7" (615.4 x 461.5cm)
	Min.(WxH)	22.0" x 16.5" (56.9 x 41.9cm)	54.9" x 41.2" (139.4 x 104.6cm)	81.6" x 68.7" (207.7 x 174.5cm)	128.2" x 96.1" (325.6 x 244.1cm)	164.8" x 123.6" (418.6 x 313.9cm)	219.7" x 164.8" (558.0 x 418.6cm)
Distance		3.9'(1.2m)	9.8'(3.0m)	16.4'(5.0m)	23.0'(7.0m)	29.5'(9.0m)	39.4'(12.0m)

❖ This graph is for user's reference only.

## On Screen Display Menus

The Projector has multilingual On Screen Display menus that allow you to make image adjustments and change a variety of settings. The projector will automatically detect the source.

### How to operate

1. To open the OSD menu, press “Menu” on the Remote Control.
2. When OSD is displayed, use ◀▶ keys to select any item in the main menu. While making a selection on a particular page, press ▼ key to enter sub menu.
3. Use ▲▼ keys to select the desired item in the sub menu and adjust the settings by ◀▶ key.
4. If the setting has ↵ icon, you could press “Enter” to enter another sub menu. Press “Menu” to close the sub menu after adjustment.
5. After adjusting the settings, press “Menu” back to the main menu.
6. To exit, press “Menu” again. The OSD menu will be closed and the projector will automatically save the new settings.

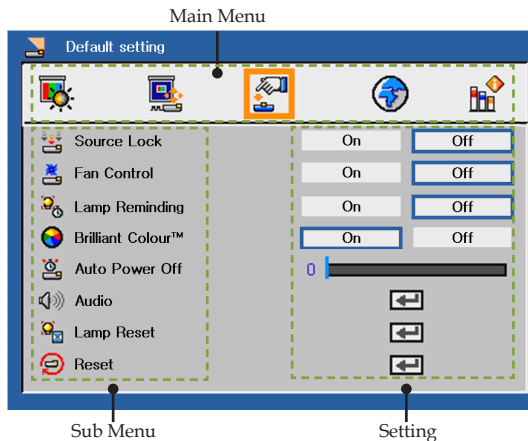

# User Controls

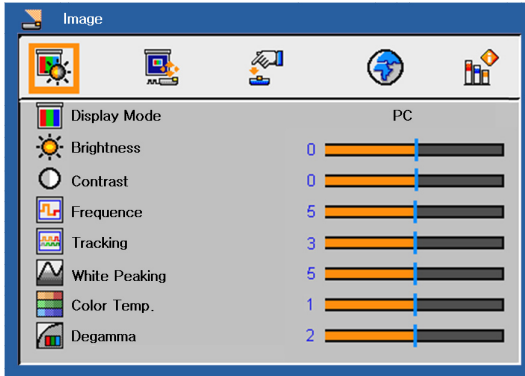

## *Image (PC Mode)*

### Display Mode

There are many factory presets optimized for various types of images.

- ▶ PC: For computer or notebook.
- ▶ Movie: For home theater.
- ▶ sRGB: For standard color.
- ▶ Game: For game.
- ▶ User: Memorize user's settings.

### Brightness

Adjust the brightness of the image.

- ▶ Press the ◀ to darken image.
- ▶ Press the ▶ to lighten the image.

### Contrast

The contrast controls the degree of difference between the lightest and darkest parts of the picture. Adjusting the contrast changes the amount of black and white in the image.

- ▶ Press the ◀ to decrease the contrast.
- ▶ Press the ▶ to increase the contrast.

## Frequency

“Frequency” changes the display data frequency to match the frequency of your computer’s graphic card. If you experience a vertical flickering bar, use this function to make an adjustment.

## Tracking

Synchronize the signal timing of the projector with the graphics card. If you experience an unstable or flickering image, use this function to correct it.

## White Peaking

Use the white peaking control to set the white peaking level of DMD chip. 0 stands for minimal peaking, and 10 stands for maximum peaking. If you prefer a stronger image, adjust towards the maximum setting. For a smooth and more natural image, adjust towards the minimum setting.

## Color Temp.

Adjust the color temperature. At higher temperature, the screen looks colder; at lower temperature, the screen looks warmer.

## Degamma

This allows you to choose a degamma table that has been fine-tuned to bring out the best image quality for the input.

# User Controls

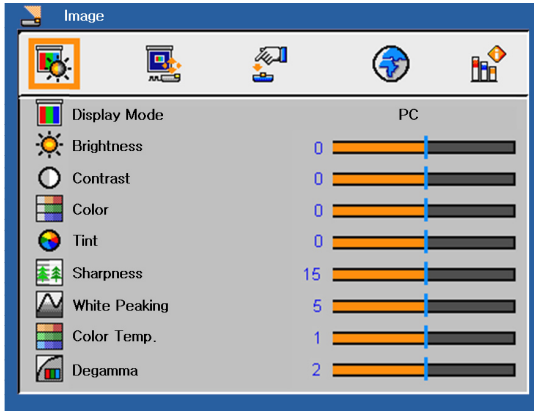

## *Image* *(Video Mode)*

### Display Mode

There are many factory presets optimized for various types of images.

- ▶ PC: For computer or notebook.
- ▶ Movie: For home theater.
- ▶ sRGB: For standard color.
- ▶ Game: For game.
- ▶ User: Memorize user's settings.

### Brightness

Adjust the brightness of the image.

- ▶ Press the ◀ to darken image.
- ▶ Press the ▶ to lighten the image.

### Contrast

The contrast controls the degree of difference between the lightest and darkest parts of the picture. Adjusting the contrast changes the amount of black and white in the image.

- ▶ Press the ◀ to decrease the contrast.
- ▶ Press the ▶ to increase the contrast.

## Color

Adjust a video image from black and white to fully saturated color.

- ▶ Press the ◀ to decrease the amount of color in the image.
- ▶ Press the ▶ to increase the amount of color in the image.

## Tint

Adjust the color balance of red and green.

- ▶ Press the ◀ to increase the amount of green in the image.
- ▶ Press the ▶ to increase the amount of red in the image.

## Sharpness

Adjust the sharpness of the image.

- ▶ Press the ◀ to decrease the sharpness.
- ▶ Press the ▶ to increase the sharpness.

## White Peaking

Use the white peaking control to set the white peaking level of DMD chip. 0 stands for minimal peaking, and 10 stands for maximum peaking. If you prefer a stronger image, adjust towards the maximum setting. For a smooth and more natural image, adjust towards the minimum setting.

## Color Temp.

Adjust the color temperature. At higher temperature, the screen looks colder; at lower temperature, the screen looks warmer.

## Degamma

This allows you to choose a degamma table that has been fine-tuned to bring out the best image quality for the input.



## Display Setting

### Keystone

Adjust image distortion caused by tilting projector. ( $\pm 15$  degrees).

### H-Position (Horizontal Position)

- ▶ Press the ◀ to move the image left.
- ▶ Press the ▶ to move the image right.

### V-Position (Vertical Position)

- ▶ Press the ◀ to move the image down.
- ▶ Press the ▶ to move the image up.

### Aspect Ratio

Use this function to choose your desired aspect ratio.

- ▶  4:3

This format is for 4x3 input sources not enhanced for Wide-screen TV.

- ▶  16:9

This format is for 16:9 input sources, like HDTV and DVD enhanced for Widescreen TV.

- ▶  Native

This format displays the original image without any scaling.

## Projection

- ▶  Front-Desktop

The factory default setting.

- ▶  Rear-Desktop

When you select this function, the projector reverses the image so you can project behind a translucent screen.

- ▶  Front-Ceiling

When you select this function, the projector turns the image upside down for ceiling-mounted projection.

- ▶  Rear-Ceiling

When you select this function, the projector reverses and turns the image upside down at same time. You can project from behind a translucent screen with ceiling mounted projection.



# User Controls

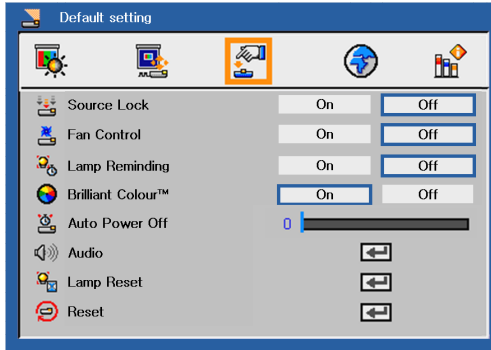

## *Default Setting*

### Source Lock

When this function is turned “Off”, the projector will search for other signals if the current input signal is lost. When this function is turned “On”, it will search specified connection port.

### Fan Control

Choose “On” to turn on Fan Control mode. Operate the fan at full speed continuously to allow for proper high altitude cooling of the projector.

### Lamp Reminding

Choose this function to show or to hide the warning message when the changing lamp message is displayed. The message will show up 30 hours before end of life.

### Brilliant Colour™

Choose “On” to provide true, more vibrant colors in picture.

### Auto Power Off

Set the interval of power-off of the system, if there is no signal input. (In minutes)

## Audio

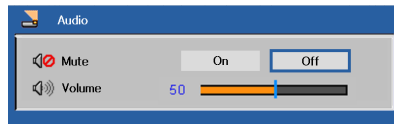

Mute:

- ▶ Choose "On" to mute the volume.
- ▶ Choose "Off" to restore the volume.

Volume:

- ▶ Press the ◀ to decrease the volume.
- ▶ Press the ▶ to increase the volume.

## Lamp Reset

Reset the lamp life hour after replacing a new lamp.

## Reset

Return the adjustments and settings to the factory default values.

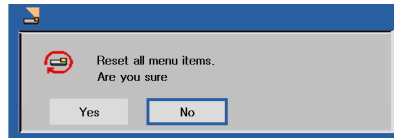

# User Controls



## *Language*

### Language

Choose the multilingual OSD menu. Press ▼ into the sub menu and then use the ▲ or ▼ or ◀ or ▶ key to select your preferred language. Press “Enter” to finalize the selection.

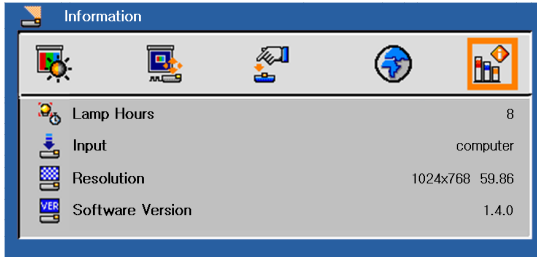

## *Information*

### Information

To display the projector information on the screen.

## Troubleshooting

*If you experience trouble with the projector, refer to the following information. If the problem persists, please contact your local dealer or service center.*

### **Problem: No image appears on screen**

- ▶ Ensure all the cables and power connections are correctly and securely connected as described in the “Operation” section.
- ▶ Ensure the pins of connectors are not crooked or broken.
- ▶ Check if the projection lamp has been securely installed. Please refer to the “Replacing the lamp” section.
- ▶ Make sure you have removed the lens cap and the projector is switched on.

### **Problem: Partial, scrolling or incorrectly displayed image**

- ▶ Press “Re-Sync” on the remote control.
- ▶ If you are using a PC:

#### For Windows 3.x:

1. In the Windows Program Manager, double click the “Windows Setup” icon in the Main group.
2. Verify that your display resolution setting is less than or equal to 1280 x 1024.

#### For Windows 95, 98, 2000, XP:

1. From the “My Computer” icon, open the “Control Panel” folder, and double click the “Display” icon.
2. Select the “Settings” tab
3. Click on the “Advanced Properties” .

**If the projector is still not projecting the whole image, you will also need to change the monitor display you are using. Refer to the following steps.**

4. Verify the resolution setting is less than or equal to 1280 x 1024 resolution.
  5. Select the "Change" under the "Monitor" tab .
  6. Click on "Show all devices". Next, select "Standard monitor types" under the SP box; choose the resolution mode you need under the "Models" box.
- ▶ If you are using a Notebook:
1. First, follow the steps above to adjust resolution of the computer.
  2. Press the toggle output settings. example: [Fn]+[F4]

Compaq=>	[Fn]+[F4]	Hewlett	
Dell =>	[Fn]+[F8]	Packard =>	[Fn]+[F4]
Gateway=>	[Fn]+[F4]	NEC=>	[Fn]+[F3]
IBM=>	[Fn]+[F7]	Toshiba =>	[Fn]+[F5]

---

Mac Apple:  
System Preference-->Display-->Arrangement-->Mirror display

- ▶ If you experience difficulty changing resolutions or your monitor freezes, restart all equipment including the projector.

## **Problem: The screen of the Notebook or PowerBook computer is not displaying a presentation**

- ▶ If you are using a Notebook PC:

Some Notebook PCs may deactivate their own screens when a second display device is in use. Each has a different way to be reactivated. Refer to your computer's documentation for detailed information.

## **Problem: Image is unstable or flickering**

- ▶ Adjust the "Tracking" to correct it. Refer to the "Image" section for more information.
- ▶ Change the monitor color setting from your computer.

**Problem: Image has vertical flickering bar**

- ▶ Use “Frequency” to make an adjustment.
- ▶ Check and reconfigure the display mode of your graphic card to make it compatible with the product.

**Problem: Image is out of focus**

- ▶ Adjust the Focus Ring on the projector lens.
- ▶ Make sure the projection screen is between the required distance 3.9 to 39.4 feet (1.2 to 12.0 meters) from the projector (refer to page 16).

**Problem: The image is stretched when displaying 16:9 DVD**

The projector automatically detects 16:9 DVD and adjusts the aspect ratio by digitizing to full screen with 4:3 default setting.

If the image is still stretched, you will also need to adjust the aspect ratio by referring to the following:

- ▶ Please select 4:3 aspect ratio type on your DVD player if you are playing a 16:9 DVD.
- ▶ If you can't select 4:3 aspect ratio type on your DVD player, please select 4:3 aspect ratio in the on screen menu.

**Problem: Image is reversed**

- ▶ Select “Display Setting-->Projection” from the OSD and adjust the projection direction.

**Problem: Lamp burns out or makes a popping sound**

- ▶ When the lamp reaches its end of life, it will burn out and may make a loud popping sound. If this happens, the projector will not turn on until the lamp module has been replaced. To replace the lamp, follow the procedures in the “Replacing the Lamp”.

## Problem: LED lighting message

Message	Power-LED		
	(Blue)	(Red)	(Purple)
Standby (Input power cord)	Flashing (0.5 sec.)	○	○
Power on (Warming up)	☀	○	○
Lamp lighting (Displaying)	☀	○	○
Power off (Cooling-I)	☀	○	○
Power off (Cooling-II)	Flashing (0.5 sec.)	○	○
Error (Lamp failed)	○	Flashing (1 sec.)	○
Error (Fan lock)	○	Flashing (0.5 sec.)	○
Error (Over temp.)	○	☀	○
Standby mode (Lamp failed)	○	○	Flashing (1 sec.)
Standby mode (Fan lock)	○	○	Flashing (0.5 sec.)
Standby mode (Over temp.)	○	○	☀



Steady light => ☀  
No light => ○



## Problem: Message Reminders

- ▶ Over temperature - the projector has exceeded its recommended operating temperature and must be allowed to cool down before it may be used.

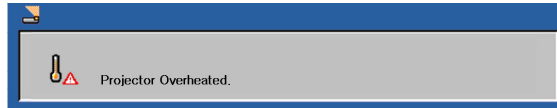

- ▶ Replacing the lamp - the lamp is about to reach its maximum life-time. Prepare to replace it soon.

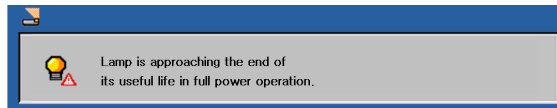

- ▶ Fan failed - the system fan is not working.



## Replacing the lamp



Warning

- ▶ The projector will detect the lamp life itself. It will show you a warning message
- ▶ Only InFocus lamps are tested with this projector. Use of other lamps may cause electrical shock and fire.
- ▶ Be extremely careful when removing the lamp housing. In the unlikely event that the bulb ruptures, small glass fragments may be generated. The lamp housing is designed to contain these fragments, but use caution when removing the lamp housing. Before replacing the lamp, clean the lamp compartment and dispose of cleaning materials. Wash hands after lamp replacement.
- ▶ Hg - Lamp contains mercury. Manage in accordance with local disposal laws. See [www.lamprecycle.org](http://www.lamprecycle.org).

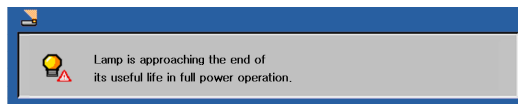

- ▶ When you see this message, change the lamp as soon as possible. Make sure the projector has been cooled down for at least 60 minutes before changing the lamp.



Warning: To avoid burns, allow the projector to cool for at least 60 minutes before you replace the lamp!



Warning: To reduce the risk of personal injury, do not drop the lamp module or touch the lamp bulb. The bulb may shatter and cause injury if it is dropped.

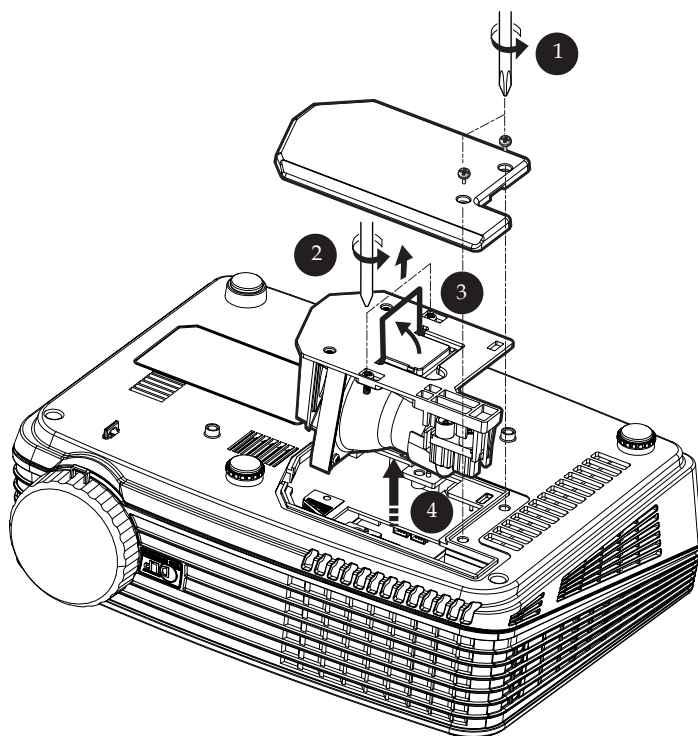

## Lamp Replacing Procedure:

1. Switch off the power to the projector by pressing the Power/Standby .
2. Allow the projector to cool down at least 60 minutes.
3. Disconnect the power cord.
4. Use a screwdriver to remove the screw from the cover. ❶
5. Push up and remove the cover.
6. Remove the 2 screws from the lamp module ❷ and pull up the lamp bar. ❸
7. Pull out the lamp module by force. ❹

**To replace the lamp module, reverse the previous steps.**

## Compatibility Modes

VGA Analog - PC Signal			
Modes	Resolution	V.Frequency (Hz)	H.Frequency (kHz)
VGA	640 x 480	60	31.50
	640 x 480	72	37.90
	640 x 480	75	37.50
	640 x 480	85	43.30
	720 x 400	70	31.50
SVGA	720 x 400	85	37.90
	800 x 600	56	35.20
	800 x 600	60	37.90
	800 x 600	72	48.10
	800 x 600	75	46.90
	800 x 600	85	53.70
	832 x 624	75	49.725
XGA	1024 x 768	60	48.40
	1024 x 768	70	56.50
	1024 x 768	75	60.00
	1024 x 768	85	68.70
SXGA	1152 x 864	70	63.80
	1152 x 864	75	67.50
	*1152 x 864	85	77.10
	1280 x 1024	60	63.98
	*1280 x 1024	72	76.97
	*1280 x 1024	75	79.98
	*1400 x 1050	60	63.98
Power Mac G4	640 x 480	66.6 (67)	34.93
	800 x 600	60	37.90
	1024 x 768	60	48.40
	1152 x 870	75	68.68
	*1280 x 960	75	75.00
PowerBook G4	640 x 480	60	31.35

# Appendices

Modes	Resolution	V.Frequency (Hz)	H.Frequency (kHz)
	640 x 480	66.6 (67)	34.93
	800 x 600	60	37.90
	1024 x 768	60	48.40
	1152 x 870	75	68.68
	*1280 x 960	75	75.00
i Mac DV (G3)	1024 x 768	75	60.00

Note: "\*" for XGA model only