



## Notice

**Read this manual carefully and make sure you understand the instructions provided. For your safety, check what the result of each action will be.**



**To reduce the risk of electric shock**, do not remove cover (or back). No user serviceable parts inside. Refer servicing to qualified service personnel. Indicates a situation which, if not avoided, could damage the equipment or other apparatus.\*



**This symbol** indicates dangerous voltage inside the TV that presents a risk of electric shock or personal injury. Indicates a hazardous situation which, if not avoided, could result in serious injury.



**This symbol** indicates important instructions accompanying the TV.



### Instruction about the 'WEEE' Symbol

This product should not be disposed with other household wastes at the end of its working life. Please separate this from other types of wastes and recycle it responsibly to promote the sustainable reuse of material resources. This will prevent possible harm to the environment or human health from uncontrolled waste disposal.

Domestic users: Please contact either the retailer where you purchased this product or their local government office for details of where and how they can take this item for environmentally safe recycling.

Business users: Contact your supplier and check the terms and conditions of the purchase contract. This product should not be mixed with other commercial wastes for disposal.

## Copyright (Copyright © 2007 HUMAX Corporation)

Not to be copied, used or translated in part or whole without HUMAX's prior consent in writing except approval of ownership of copyright and copyright law.

## Warranty

The information in this document is subject to change without notice. HUMAX does not have any responsibility for direct, indirect, accidental and other damage caused by the use of the information contained in this manual.

### Trademarks

**VIACCESS™** is a trademark of France Telecom.

**CryptoWorks™** is a trademark of Philips Electronics N.V.

**Irdeto** is a trademark of Mindport BV.

**Nagravision** is a registered trademark of KUDELSKI S.A.

**Conax** is a trademark of Telenor Conax AS.



is a trademark of SRS Labs, Inc.

TruSurround XT technology is incorporated under license from SRS Labs, Inc.

*Thank you for purchasing a HUMAX TV. Please read this user manual carefully in order to safely install, use and maintain the TV at maximum performance. Keep this user manual next to your TV to ensure the best performance possible.*

*This user manual covers the LGB-19DRT and LGB-22DRT models.*

*The illustrations and on-screen displays in this user manual are for explanation purpose and may vary slightly from the actual operations.*

# General Safety Precautions

## Power

- Plug the power cord into the correct power outlet. An unstable connection may cause fire.
- Do not use damaged power cords or plugs, or use a loose wall outlet. This may cause electrical shock or fire.
- Do never touch the power cord with wet hands. This may cause electrical shock.
- Do not use multiple devices with one outlet. Overheating the outlet may cause fire.
- Do not bend or pull out the power cord using force, nor place heavy objects over it. This may cause electrical shock or fire.
- Make sure you pull out the power cord holding the plug itself. An internal disconnection may cause fire.
- When removing the product, turn off the power and pull out the plug from the power outlet. Also make sure other devices including the antenna or the connectors are removed from the outlets before relocating the product. Otherwise you may suffer electrical shock or fire due to a damaged power cord.
- The mains plug shall remain readily operable.
- Plug as disconnection device shall remain to be readily approached by user.

## Installation

- Keep the product away from any heating devices. Placing it close to a heating device may cause fire.
- Keep the power cord away from any heating devices. A melted coating may cause fire or electrical shock.
- Place the antenna as far away as possible from any high-voltage cables. Touching the high voltage wiring may cause fire or electrical shock.
- Do not install the product in oily, smoky or humid (or exposed to rain/water) places or automobiles. This may cause fire.
- The connection between the external antenna and the internal wiring should be turned inside to avoid any inflow of rain. Exposing the LCD to water (rain) will cause electrical shock or fire.
- Do not use the product in humid places. Humidity will shorten the life of the product and may cause an electrical shortage or fire.
- Do not use the product in places with low temperatures (below 5°C).
- Avoid installing the product in poorly ventilated places. Internal overheating may cause an electrical shortage and fire.
- Be sure not to cover the ventilator (with a table-cloth or curtain, etc.). Internal overheating may cause an electrical shortage and fire.
- Do not install the product in an unstable place or on a small stand. The product may cause serious injury, if it falls on somebody (especially children). Install it on an even, stable place as it is front-heavy.
- Do not install the product on the floor. Someone (especially children) may trip over it.

## General Safety Precautions

### Usage

- Unplug the product from the wall outlet and do not touch the antenna during a thunderstorm. This will prevent damage to the unit due to lightning and power-surges.
- Keep dust or water away from the pins or touching points of the power plug. This will prevent electrical shock or fire.
- Keep children from climbing over the product. The device may cause serious injury or death if it falls on them.
- Do not place anything over the product that children may try to reach. The device may cause serious injury or death if it falls on them.
- When removing the battery from the product, keep it out of children's reach. If a child swallows a battery, consult a doctor immediately.
- Use only specified batteries and do not use an old battery along with a new one. Align the batteries according to the correct polarity (+ or -). Aligning them incorrectly may cause an internal explosion or a leakage of the internal liquid, leading to electrical shock, physical damage or pollution of the surroundings.
- Do not insert any metal or a flammable object or an alien substance into the ventilator, the AV input terminal or the slots for the modules or Smartcards. This may cause damage to the product and reduce its life span.
- Do not disassemble, repair or reconstruct the product at your discretion. This may cause electrical shock or fire. Contact your local customer support.
- Keep the product away from inflammable sprayers or ignitable objects. Exposure to these may cause explosion or fire.
- Do not place water-pots, flower vases, beverage cans, small metals or heavy objects over the product. Contact of these contents with the product may cause electrical shock or fire, while any falling of the product may cause injury.
- If the product breaks down, turn off the power and unplug it from the outlet before contacting Customer Support. This will protect you from electrical shock or fire.
- When you notice something strange like an odd noise, smell something burning or see smoke, unplug the power cord and contact your local Customer Support. Do this to avoid electrical shock or fire.
- Do not use sharp tools such as a pin or a pencil near the TV, as they may scratch the LCD surface.
- Do not use a solvent, such as benzene, to clean the TV, as it will damage the LCD surface.

### Cleaning

- Unplug the power cord before cleaning the product. This may cause electrical shock or fire.
- Do not sprinkle water on the product. This may cause electrical shock or fire.
- Use only a soft dry cloth as the surface is weak on scratch. Do not use chemicals like wax, benzene, alcohol, thinners, aroma, lubricator or cleanser.

## Table of Contents

<b>Chapter 1 &gt;&gt; Getting Started .....</b>	<b>8</b>
Package Contents .....	8
Front & Top Panel.....	9
Rear & Side Panel .....	10
Remote Control Buttons .....	12
<b>Chapter 2 &gt;&gt; Connecting Your TV.....</b>	<b>14</b>
Connecting to an Aerial or a Cable TV .....	14
Connecting to the VCR.....	15
Connecting to the DVD Player .....	16
Connecting to the Set-Top Box.....	18
Connecting to the PC .....	19
Connecting a HDD (Hard Disk Drive).....	20
Connecting Headphones.....	20
Conditional Access System.....	21
<b>Chapter 3 &gt;&gt; Initial Setup Wizard.....</b>	<b>22</b>
Running Initial Setup Wizard .....	22
<b>Chapter 4 &gt;&gt; Basic Operation .....</b>	<b>23</b>
Turning on Your TV.....	23
Selecting the Menu Language.....	23
Selecting the Main Input Source .....	24
Viewing Channel List.....	24
Displaying Information .....	25
Digital Programme Features .....	27
<b>Chapter 5 &gt;&gt; Using the Electronic Programme Guide (EPG) .....</b>	<b>28</b>
Viewing the Electronic Programme Guide(EPG).....	28
Viewing Reserved Programme.....	30
Finding a Programme .....	30
<b>Chapter 6 &gt;&gt; Setting Channels .....</b>	<b>31</b>
Scanning Analog Channels Automatically .....	31
Scanning Analog Channels Manually .....	31
Editing Analog Channels .....	33
Scanning Digital Channels Automatically .....	34
Scanning Digital Channels Manually.....	35
Editing Digital Channels .....	36
Editing Favourite Digital Channels .....	38
<b>Chapter 7 &gt;&gt; Setting the Picture .....</b>	<b>40</b>
Selecting a Picture Mode .....	40
Customizing the Picture Settings .....	40
Fleshtone.....	41
Colour Temperature.....	41
Adjusting Backlight Brightness .....	42

## Table of Contents

<b>Chapter 8 &gt;&gt; Setting the Sound</b> .....	<b>43</b>
Setting the Sound Effect .....	43
Adjusting the Sound Balance .....	43
Adjusting the Volume Automatically .....	44
Setting the TruSurround XT .....	44
<b>Chapter 9 &gt;&gt; Setting the System</b> .....	<b>45</b>
Setting the Time Information .....	45
Changing the Password .....	46
Common Interface .....	46
Panel Off .....	46
VFD Clock .....	47
Default Settings .....	47
<b>Chapter 10 &gt;&gt; DTV Setup</b> .....	<b>48</b>
Parental Control .....	48
Language Setting .....	49
Miscellaneous Settings .....	50
Software Update .....	51
Status .....	54
Signal Detection .....	54
<b>Chapter 11 &gt;&gt; Recording and Playback</b> .....	<b>55</b>
Time Shifted Recording (TSR) .....	55
Instant Recording .....	58
Recording Schedule .....	59
Programme Playback in the Play List .....	61
Chase Play .....	62
Editing Recorded Programmes .....	62
MP3 .....	65
HDD Control .....	66
<b>Chapter 12 &gt;&gt; Setting the Aspect Ratio</b> .....	<b>67</b>
<b>Chapter 13 &gt;&gt; Using the Teletext</b> .....	<b>68</b>
<b>Chapter 14 &gt;&gt; Setting the PC</b> .....	<b>69</b>
Auto Configure .....	69
Position .....	69
Clock .....	70
Phase .....	70
<b>Menu Map</b> .....	<b>71</b>
<b>Troubleshooting</b> .....	<b>72</b>
<b>Specification</b> .....	<b>74</b>
<b>Service and Support</b> .....	<b>75</b>

## Package Contents

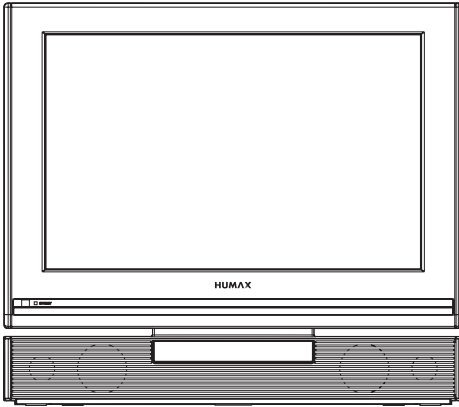

LCD TV



User's manual

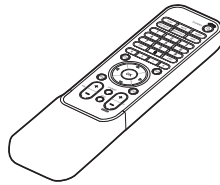

Remote control

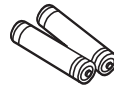

AAA batteries (X2)



Portable HDD (80GB)

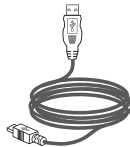

USB cable

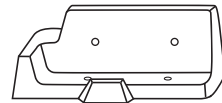

HDD stand

**Warning:**

1. It is recommended to use the supplied hard disk drive. This TV provides best performance with the supplied hard disk drive.
2. The company shall not be liable for problems caused by the misuse or improper installation of the hard disk drive.



## Front & Top Panel

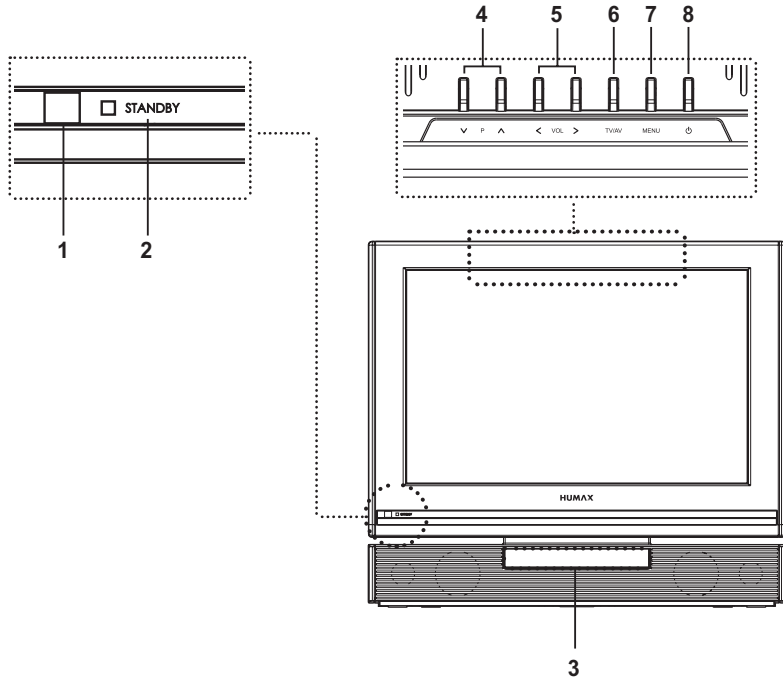

- 1 Remote control sensor**  
Receives commands directly from your remote control and passes them on.
- 2 Standby indicator**  
Turns on blue during the Standby mode.
- 3 VFD (Vacuum Fluorescent Display)**  
Used for the radio channels.
- 4 V P ^ buttons**  
Selects channels.
- 5 < VOL > buttons**  
Adjusts the volume.
- 6 TV/AV button**  
Displays input source.
- 7 MENU button**  
Displays the on-screen menu.
- 8 Standby button**  
Switches between operation and standby modes.

## Rear & Side Panel

### Side Panel

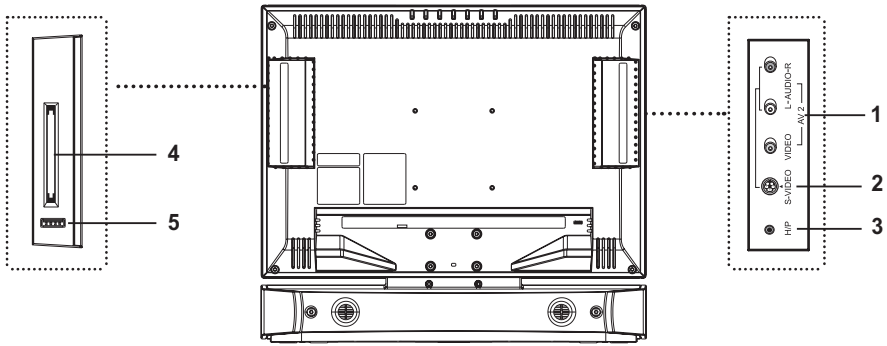

**1 AV2 (CVBS) INPUT**

Connects to the audio and video output jacks of a camcorder, videogame and similar devices.

**2 S-VIDEO INPUT**

Connects to the S-Video jack of a camcorder, video game console, and similar devices.

**3 H/P (Headphones)**

Connects to headphones.

**4 CI (Common Interface) SLOT**

A slot for a CI Module.

**5 USB**

Connects to the supplied hard disk drive. (for PVR function)

### Rear Panel

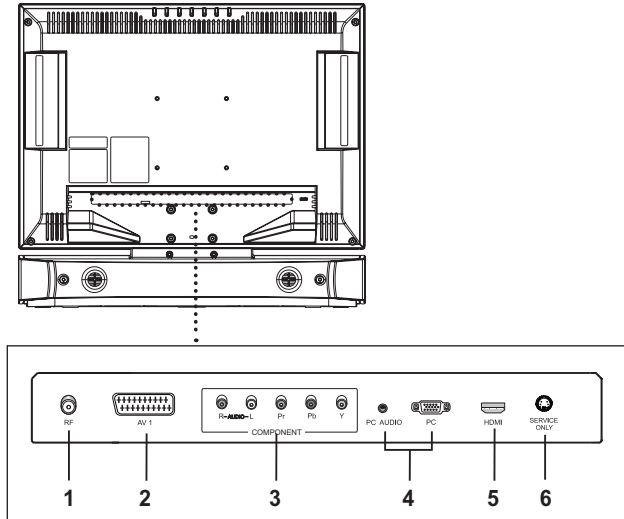

#### 1 RF INPUT

Connects to an antenna or a cable system.

#### 2 AV1 (SCART) INPUT

Inputs or Outputs for external devices, such as VCR, DVD, video game console or video disc players.

#### 3 COMPONENT INPUT

Connects to Video (Y/Pb/Pr) and audio (L/R) components.

#### 4 PC INPUT/PC AUDIO INPUT

Connect to the video and audio output jacks on your PC.

#### 5 HDMI INPUT

Receives uncompressed digital audio and video signals from the device that supports High Definition Multi-media Interface (HDMI).

#### 6 SERVICE ONLY (RS232C)

Connects to the PC to update the software of the TV.

## Remote Control Buttons

### TV/AV

Displays all available input sources. Press the ▲/▼ button to select a required input source.

### MUTE

Mutes the sound. To cancel, press the MUTE, VOL+, or VOL- button.

### SLEEP

Selects a preset time interval for switching the TV to standby mode automatically.

### PIC MODE

Selects the picture mode (Standard, Dynamic, Movie, Mild, or User).

### SND EFFECT

Selects the sound effect (Flat, Speech, Movie, Music, or User).

### WIDE

Select the aspect ratio (Auto, 4:3, 14:9, Full or Zoom).

### EPG

Displays the Electronic Programme Guide (EPG) in Digital TV input.

### BACK

Returns to the previous display.

### MENU

Displays the On Screen Display (OSD) menu.

### EXIT

Exits from the currently displayed menu.

### Arrow (▲/▼/◀/▶) buttons

Controls the selection in the On Screen Display (OSD) menu.

### OK

Confirms (save or enter) your choice in the On Screen Display (OSD) menu.

### VOL+/-

Adjusts the volume.

### P+/- (Page)

Switches channels or pages.

### TV/RADIO

Switches between digital TV and radio modes.

### INFO

Displays information on the current channel or input.

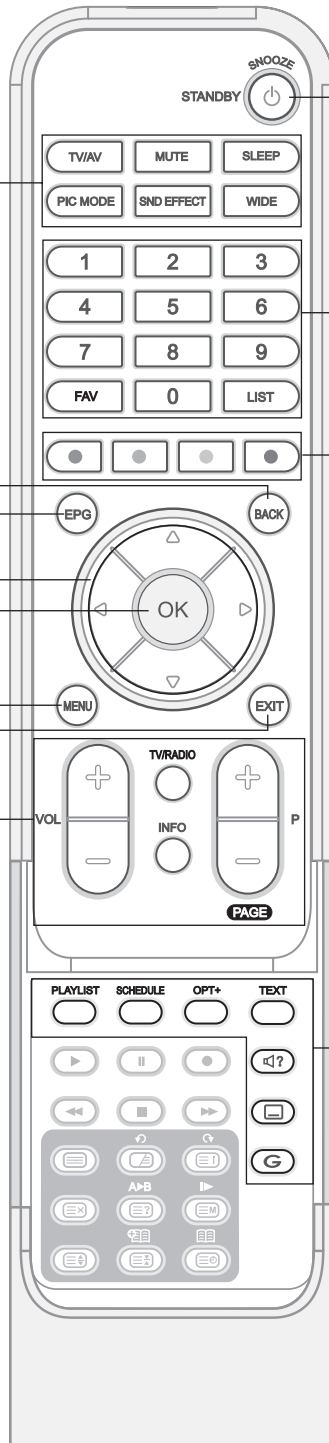

### STANDBY

Switches between operation and standby modes.

### SNOOZE

Switch into the standby mode momentarily.

### Number (0~9) buttons

Enters the channel number for direct display. Used to enter digit numbers.

### FAV

In Analog TV input mode, switches to a favourite channel. Circulates through favourite channels in sequent order while watching TV. In Digital TV input mode, display the favourite channel list.

### LIST

Displays the channel list.

### Coloured Buttons

Used for interactive applications in the EPG, Edit Channels and Teletext mode.

### PLAYLIST

Displays the recorded programme list in Digital TV input.

### SCHEDULE

Displays the reserved programme list in Digital TV input.

### OPT+ (RED)

Displays the channel options while watching a programme in Digital TV input.

### TEXT

Shows MHEG (digital teletext information)

### ◀? (SOUNDTRACK)

Selects the sound mode (Stereo, Mono, etc.) in Analog TV input or the soundtrack list in Digital TV input.

### ☑ (Subtitle)

Displays the subtitle language list in Digital TV input.

### G (GAME)

Displays the game in Digital TV input.

### TELETEXT Function Buttons

#### (Teletext On/Off)

Activates or deactivates the teletext service.

#### (Mix)

Overlaps the teletext with the broadcasting screen.

Adjusts the opacity to the background in Teletext mode.

#### (Index)

Displays the teletext index page.

#### (Cancel)

Displays the TV programme when searching for the new teletext page.

#### (Reveal)

Shows the hidden information.

#### (Mode)

Selects the teletext mode (LIST/FLOF)

#### (Size)

Displays the double-size letters.

#### (Hold)

Holds the current teletext page not updating it.

#### (Time)

Display the current time at the top right hand corner of the screen..

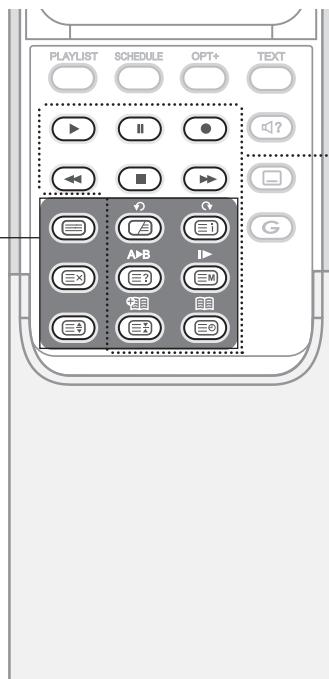

### PLAYBACK Control Buttons (only in Digital TV input)

#### (PLAY)

Plays at normal speed or resumes.

#### (PAUSE)

Pauses the live programme or recording.

#### (RECORD)

Records programme.

#### (FAST REWIND)

Rewinds at high speed. Each time you press this button the rewind speed is increased.

#### (FAST FORWARD)

Fasts forward at high speed. Each time you press this button the fast forward speed is increased.

#### (STOP)

Stops a recording or goes to the live programme.

#### (INSTANT REPLAY)

Goes back 7 seconds in Digital TV input.

#### (INSTANT SKIP)

Skips the programme ahead 30 seconds in Digital TV input

#### (A-B)

Plays back a specified block repeatedly.

#### (SLOW MOTION)

Plays the programme in slow motion. Each time you press this button, speed is slowed progressively more.

#### (ADD BOOKMARK)

Saves the current viewing position as a bookmark.

#### (BOOKMARK LIST)

Displays the list of saved viewing positions.

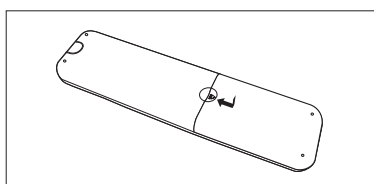
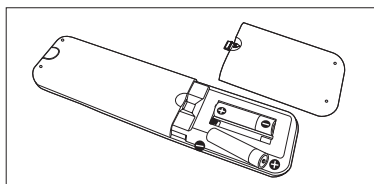
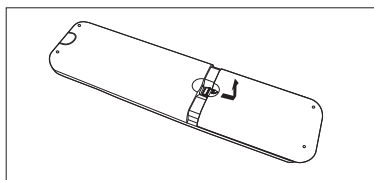

## Inserting Batteries into the Remote Control

You must insert or replace the batteries in the remote control when:

- + You just purchased TV
- + Remote control does not work

- 1 Remove the cover on the rear of the remote control by pressing the symbol (▼) downwards and then pulling firmly to remove it.
- 2 Insert two AAA size 1.5V batteries ensuring that the plus(+) and minus(-) signs of the batteries are correctly aligned.
- 3 Close the cover.

**Note:** Do not mix different battery types such as alkaline with manganese.

## Connecting to an Aerial or a Cable TV

To view the television channels correctly, a signal must be received by the broadcasting provider.

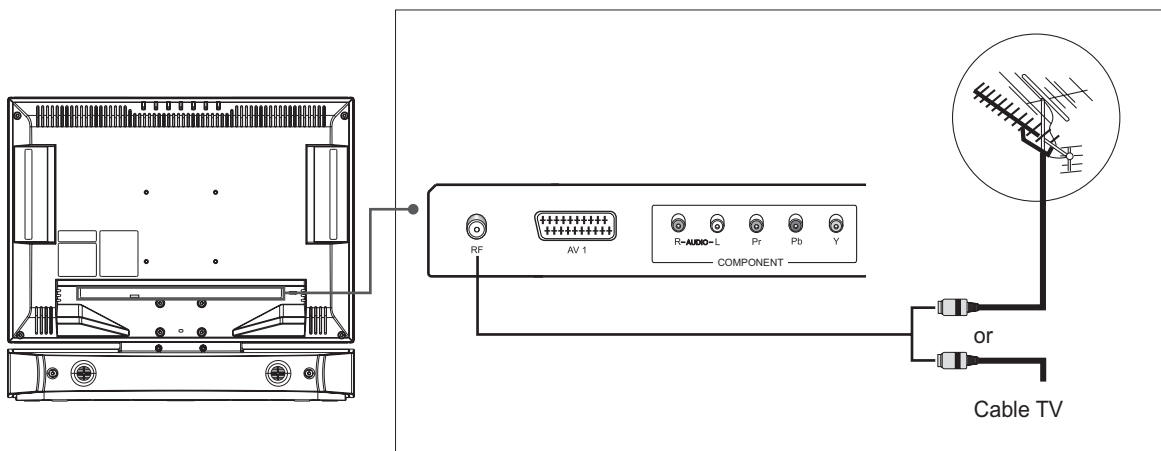

- 1 Connect the RF coaxial cable from an aerial or a cable TV to the **RF** jack on the rear of the TV.
- 2 Turn on the TV, and then press the **TV/AV** button to select **Digital TV** or **Analog TV**.

**Notes:**

1. To receive an optimal signal, it is recommended that you use a 75 ohm IEC-type coaxial cable.
2. For proper reception of signals, an external antenna is required. For best reception, an outdoor antenna is recommended.
3. To improve the picture quality in a poor signal area, please purchase a signal amplifier and install properly.

## Connecting to the VCR

### Using the SCART Cable

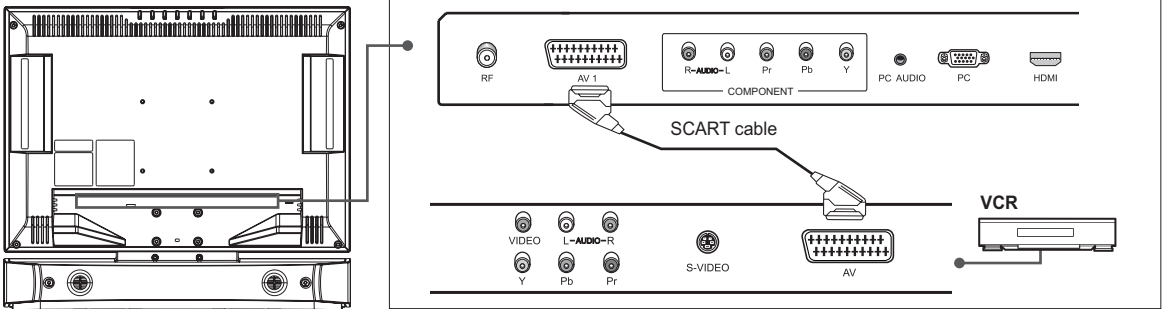

- 1 Connect the SCART cable between the **AV1** jack on TV and the SCART jack on your VCR.
- 2 Turn on the TV, and then press the **TV/AV** button to select **AV1**.
- 3 Turn on your VCR, then insert a video cassette into the VCR and press the **PLAY** button on your VCR. (Refer to the VCR owner's manual)

### Using the Audio/Video (Composite) Cable

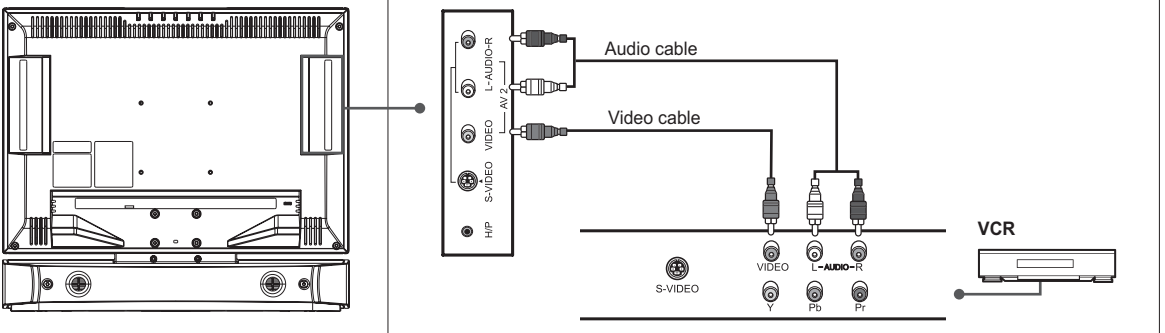

- 1 Connect the video cable between the **VIDEO (AV2)** input jack on TV and the video output jack on your VCR.
- 2 Connect the audio cable between the **AUDIO-L/R (AV2)** input jacks on TV and the audio output jacks on your VCR.
- 3 Turn on the TV, and then press the **TV/AV** button to select **AV2**.
- 4 Turn on your VCR, then insert a video cassette into the VCR and press the **PLAY** button on the VCR. (Refer to the VCR owner's manual)

### Using the Audio/S-Video Cable

S-Video carries the video data as two separate signals (brightness and colour), unlike composite video which carries the entire set of signals in one package. S-Video does not carry audio. Hence, a separate audio connection is required.

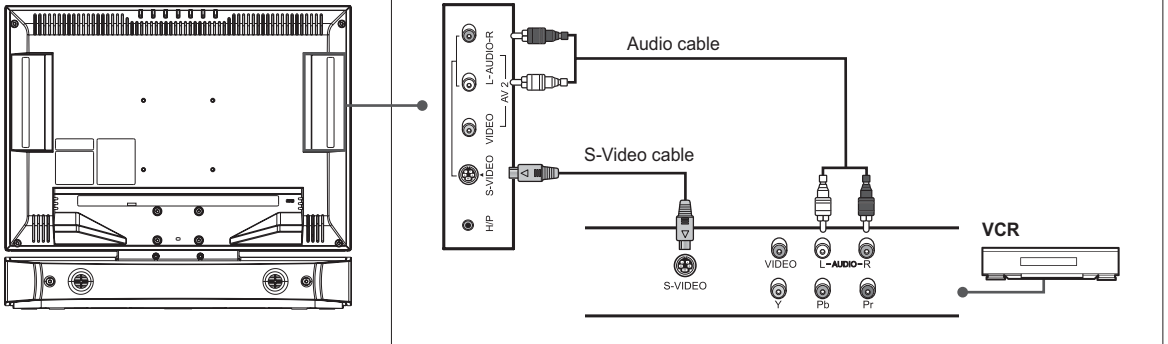

- 1 Connect the S-Video cable between the **S-VIDEO** input jack on TV and the S-Video output jack on your VCR.
- 2 Connect the audio cable between the **AUDIO-L/R (AV2)** input jacks on TV and the audio output jacks on your VCR.
- 3 Turn on the TV, and then press the **TV/AV** button to select **S-Video**.
- 4 Turn on your VCR, then insert a video cassette into the VCR and press the **PLAY** button on your VCR. (Refer to the VCR owner's manual)

## Connecting to the DVD Player

### Using the SCART Cable

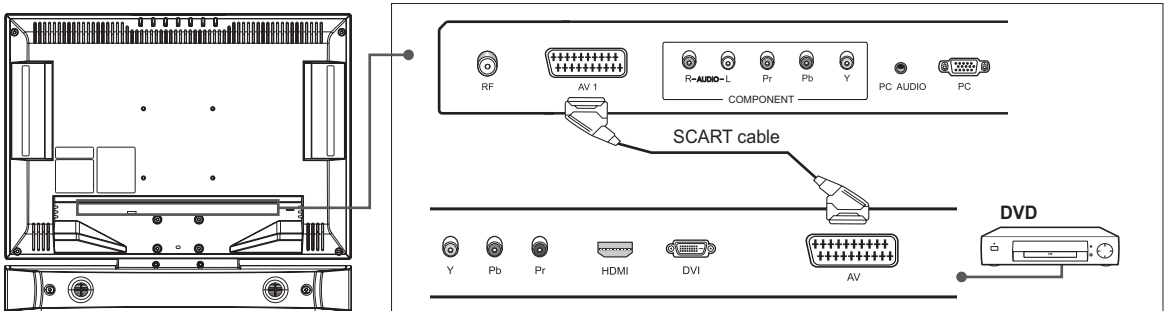

- 1 Connect the SCART cable between the **AV1** jack on TV and the SCART jack on your DVD player.
- 2 Turn on the TV, and then press the **TV/AV** button to select **AV1**.
- 3 Turn on your DVD player, and then insert a DVD into the DVD player and press the **PLAY** button on your DVD player. (Refer to the DVD player owner's manual)



## Using the Audio/Component Video Cable

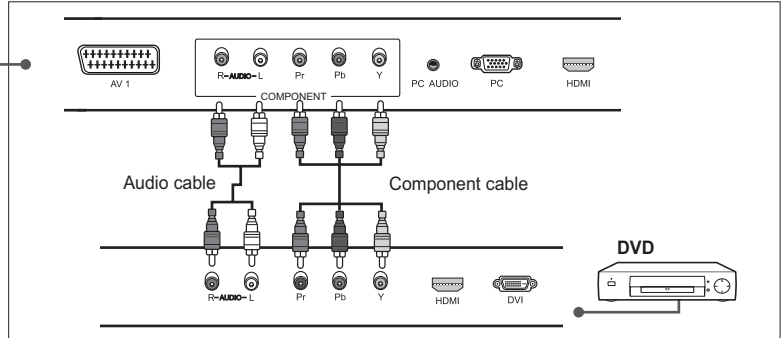
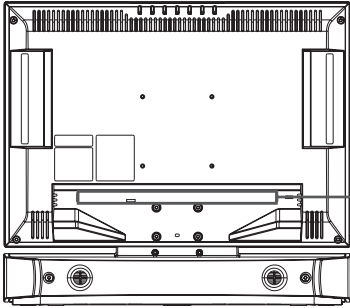

- 1 Connect the component video cables between the **COMPONENT VIDEO - Y/Pb/Pr** input jacks on TV and the component video output jacks on your DVD player.
- 2 Connect the audio cable between the **AUDIO-L/R** (for COMPONENT) input jacks on TV and the audio output jacks on your DVD player.
- 3 Turn on the TV, and then press the **TV/AV** button to select **Component**.
- 4 Turn on your DVD player, then insert a DVD into the DVD player and press the **PLAY** button on your DVD player. (Refer to the DVD player owner's manual)

**Note:** Depending on the manufacturer, the Y/Pb/Pr jacks may be identified as Y/Pb/Pr, Y/B-Y/R-Y or Y/Cb/CR.

## Using the HDMI Cable

High-Definition Multimedia Interface (HDMI) is the leading new standard for Digital video and audio interconnection.

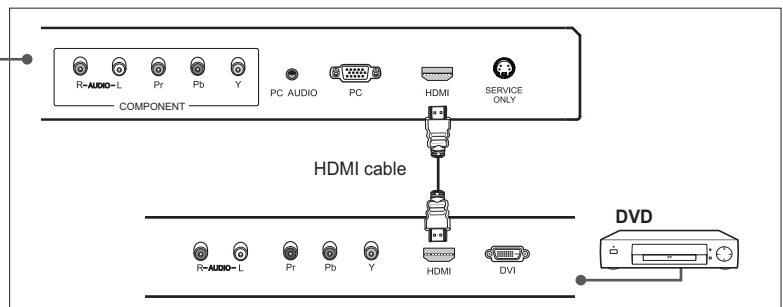
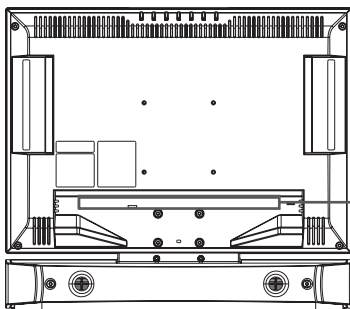

- 1 Connect the HDMI cable between the **HDMI** input jack on TV and the HDMI output jack on your DVD player.
- 2 Turn on the TV, and then press the **TV/AV** button to select **HDMI**.
- 3 Turn on your DVD player, then insert a DVD into the DVD player and press the **PLAY** button on your DVD player. (Refer to the DVD player owner's manual)

## Connecting to the Set-Top Box

### Using the SCART cable

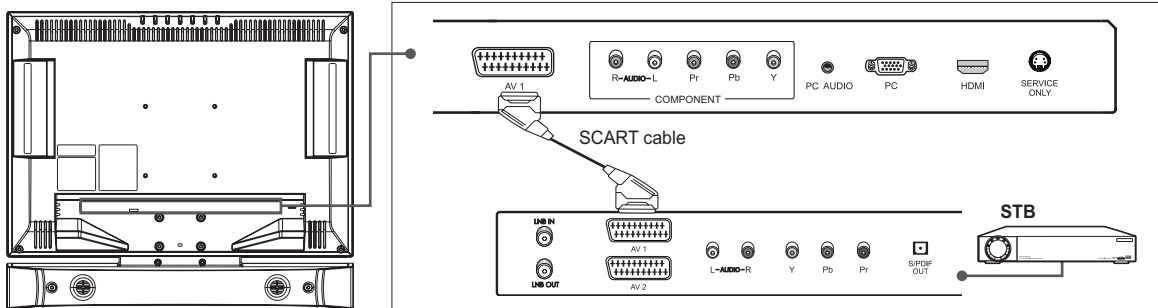

- 1 Connect the SCART cable between the **AV1** jack on TV and the SCART jack on your STB.
- 2 Turn on the TV, and then press the **TV/AV** button to select **AV1**.
- 3 Turn on your STB. (Refer to the STB owner's manual)

### Using the Audio/Component Video Cable

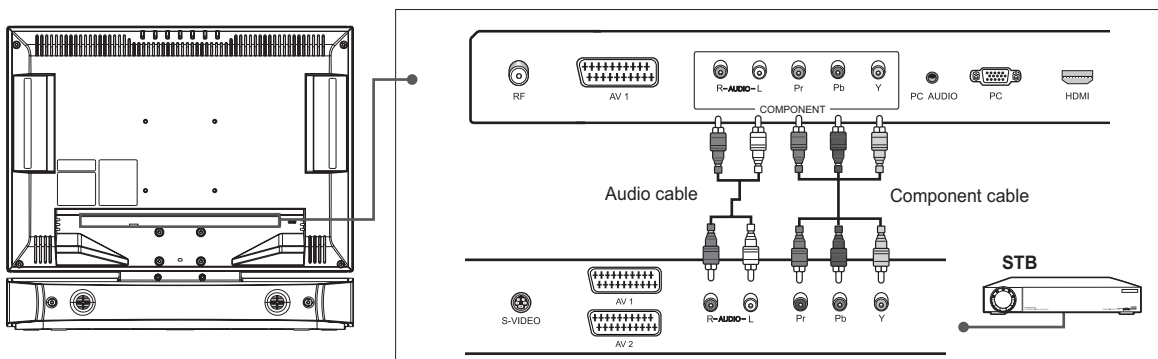

- 1 Connect the component video cables between the **COMPONENT VIDEO - Y/Pb/Pr** input jacks on TV and the component video output jacks on your STB.
- 2 Connect the audio cable between the **AUDIO-L/R** (for COMPONENT) input jacks on TV and the audio output jacks on your STB.
- 3 Turn on the TV, and then press the **TV/AV** button to select **Component**.
- 4 Turn on your STB. (Refer to the STB owner's manual)

**Note:** Depending on the manufacturer, the Y/Pb/Pr jacks may be identified as Y/P<sub>B</sub>/P<sub>R</sub>, Y/B-Y/R-Y or Y/C<sub>B</sub>/C<sub>R</sub>.

## Using the HDMI Cable

High-Definition Multimedia Interface (HDMI) is the leading new standard for Digital video and audio interconnection.

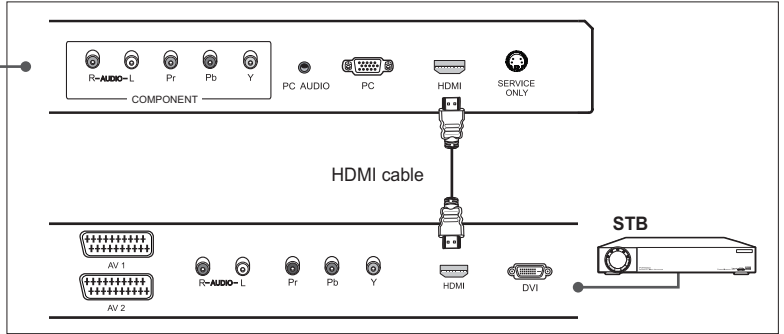
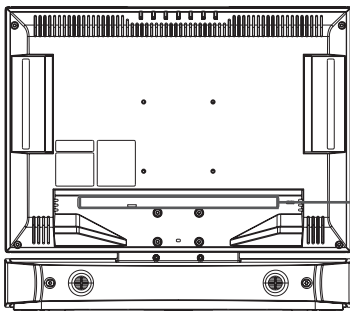

- 1 Connect the HDMI cable between the **HDMI** input jack on TV and the HDMI output jack on your STB.
- 2 Turn on the TV, and then press the **TV/AV** button to select **HDMI**.
- 3 Turn on your STB. (Refer to the STB owner's manual)

## Connecting to the PC

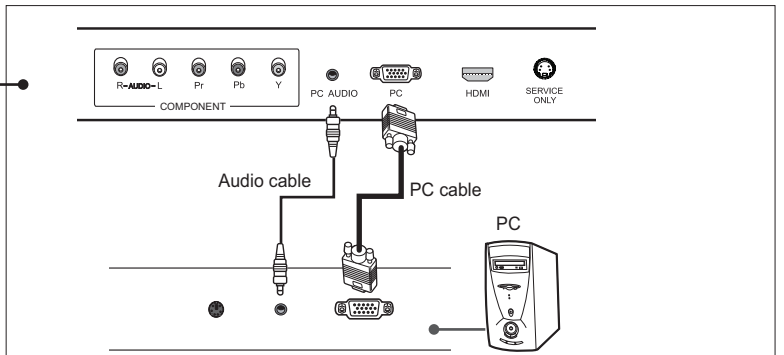
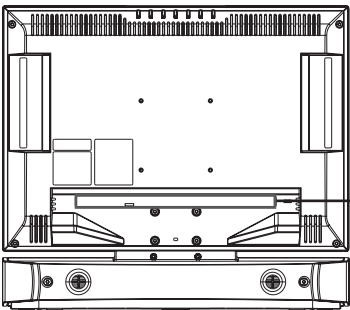

- 1 Connect the PC cable between the **PC** jack on TV and the PC output jack on your PC.
- 2 Connect the audio cable between the **PC AUDIO** jack on TV and the audio output jack on your PC.
- 3 Turn on the TV, and then press the **TV/AV** button to select **PC**.

### Supported Display Resolution (PC)

Mode	Resolution	Horizontal Frequency (kHz)	Vertical Frequency (Hz)
VESA	640 x 480	31.5	60
	800 x 600	37.9	60
	1024 x 768	48.4	60
	1280 x 768	47.8	60
	1360 x 768	47.7	60

## Connecting a HDD (Hard Disk Drive)

To use the PVR (Personal Video Recorder) function, you should connect the supplied portable hard disk drive.

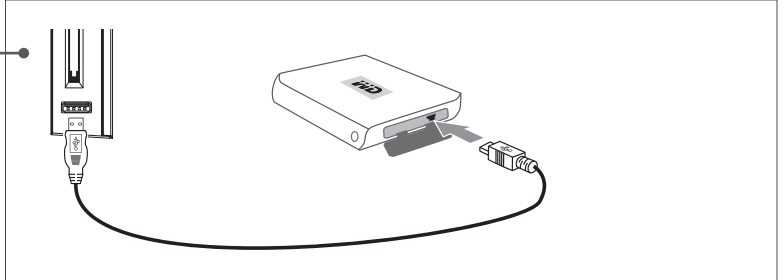
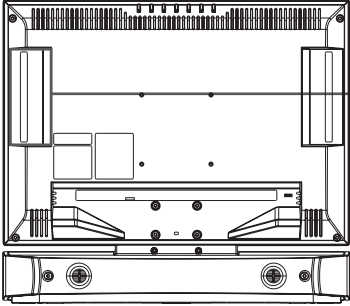

- 1 First, turn off the TV.
- 2 Connect the USB cable (supplied) between the **USB** jack on TV and the USB jack on the portable hard disk drive (supplied).
- 3 Turn on the TV, and then select **Digital TV** using the **TV/AV** button to use the PVR function.

**Warning:**

1. It is recommended to use the supplied hard disk drive. This TV provides best performance with the supplied hard disk drive. If you connect the other hard disk drive to your TV, the TV will format it.
2. Do not connect the storage device that the capacity is too little (such as USB memory stick).
3. Do not connect to the USB jack on your TV the other device besides the storage device such as a hard disk drive.
4. Please turn the power off before connecting or disconnecting the hard disk drive. If you connect the hard disk drive while watching TV, the TV will be rebooted.

## Connecting Headphones

Connect a set of headphones to **H/P** jack on TV if you want to watch a television programme without disturbing other people close to you.

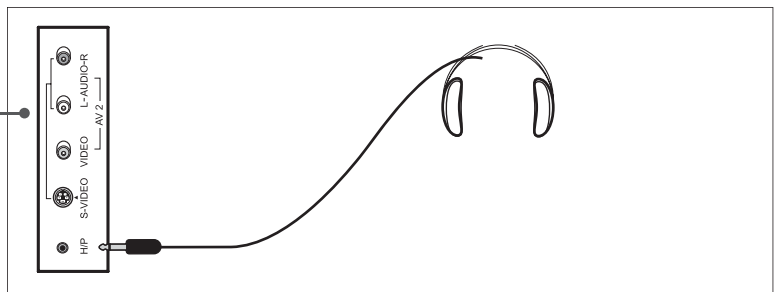
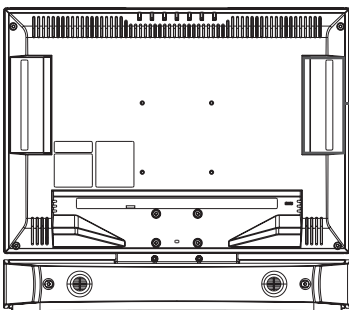

**Note:** Prolonged use of headphones at a high volume may cause health damage on your ears.

## Conditional Access System (for the digital channels only)

Conditional Access System (CAS) is a technology used to control access to digital television (DTV) services to authorised users by encrypting the transmitted programming.

### Inserting a CI Module (with Smartcard)

CI Module looks like a PC Card (called PCMCIA) for laptops. There are different kinds of CI Modules, suitable for different coding systems.

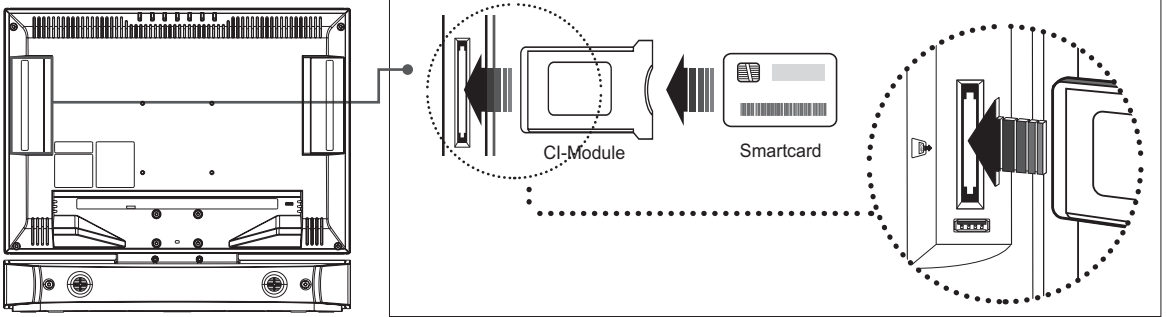

- 1 Follow the instructions of the module and insert the Smartcard into the Common Interface (CI) module.
- 2 Keep the CI module(with the Smartcard) vertically.
- 3 Insert the CI module completely into the slot.

**Note:** Ensure the Smartcard or CI module is inserted in the right direction. Inserting in the wrong direction may cause damage to the Smartcard or CI module.

# Running Initial Setup Wizard

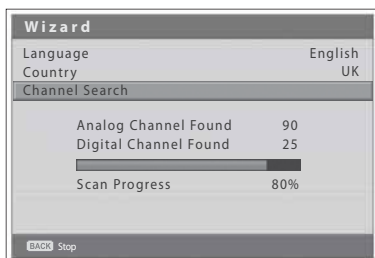
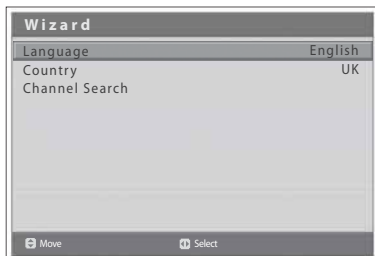

When you turn on your TV for the first time after purchase or perform the default setting, the initial setup wizard will appear automatically. You can easily setup the available analog and digital channels using the wizard.

- 1 Select the language of your choice using the ◀/▶ button. The On Screen Display (OSD) menu will be shown in the selected language.
- 2 Select **Country** using the ▲/▼ button.
- 3 Select the country where you are now located using the ◀/▶ button.
- 4 Select **Channel Search** using the ▲/▼ button and press the **OK** button. It starts to scan channels. First scans analog and then digital channels. The scanned channels are automatically saved in order. To stop scanning channels, press the **BACK** button.
- 5 After the channel scanning completes, press the **BACK** button to exit search. The first scanned digital channel, if only, will be automatically displayed.

---

**Note:** If you do not want to setup the channels at this time, you can setup it later using the **Channel** menu.

---

## Turning on Your TV

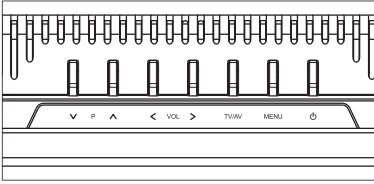

- 1 Connect the power cord on TV to the wall outlet. The standby indicator lights up.
- 2 Press the **STANDBY** button on your remote control (or on the top of your TV) to turn on the TV.

**Note:** To set your TV in standby mode, press the **STANDBY** button again on the remote control or (⏻) on the top of your TV. It saves the electric usage when you want to stop watching TV temporarily (during a meal, for example).

- 3 To turn off the TV, disconnect the power cord.

**Note:** Do not leave your TV in standby mode for too long (on holiday, for example). Turn off the TV by disconnecting the power cord.

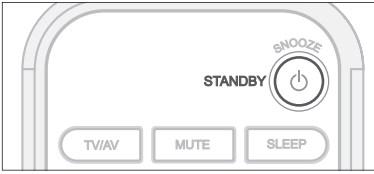

## Selecting the Menu Language

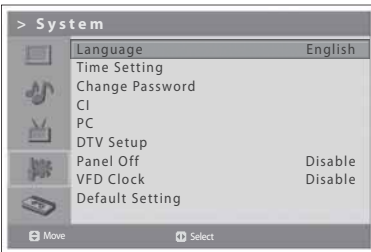

You can select the language for displaying menus and indications.

- 1 Press the **MENU** button.
- 2 Select **System** using the ▲/▼ button and press the **OK** or ► button.
- 3 Select the language of your choice using the ◀/▶ button. The On Screen Display (OSD) menu will be shown in the selected language.
- 4 Press **EXIT** button to return to Live TV or press the **BACK** button to return to the previous menu.

## Selecting the Main Input Source



Once you have connected your various audio and video systems, you can view different sources by selecting input sources.

- 1 Press the **TV/AV** button.
- 2 Select the main input among the sources below using the **▲** or **▼** button.  
**Digital TV > Analog TV > AV1 > AV2 > S-Video > Component > PC > HDMI**
- 3 Press the **OK** button.
- 4 In addition, press the **TV/RADIO** button to switch to digital TV from different sources.

## Viewing Channel List

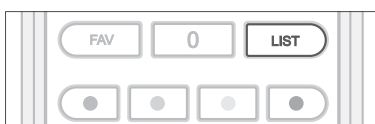

You can view the list of all analog and digital channels using the **LIST** button and switch to other channels on the channel list. You can also display the digital channel list by pressing the **OK** button.

*Analog channel list appears only in **Analog TV** input mode and digital channel list appears only in **Digital TV** input mode.*

### ▼ Analog channel list

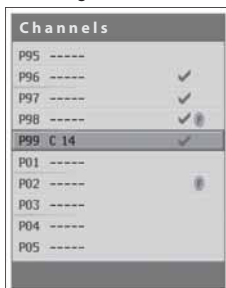

- 1 Press the **LIST** button while watching the analog or digital channels.
- 2 To change the channel in analog or digital channel list, select your desired channel using the **▲/▼** button and press the **OK** button. The selected channel is displayed.

### Notes:

1. Within the digital channel list, press the **P+/- (Page)** button to move to the next or previous page.
2. Within the digital channel list, you can move to your desired channel directly by entering the channel number using **NUMBER (0~9)** button.
3. Whenever you press the **TV/RADIO** button while the digital channel list is displayed, the digital channel list will switch between TV and radio channel lists.
4. To display scramble icon (□) in the digital channel list, select **On** in **MENU-DTV Setup-Miscellaneous-Option in CH List**.

### ▼ Digital channel list



## Changing Digital Channel List Group

You can select digital channel list by group.

- 1 Press the **▶** button in digital channel list to view the group list.
- 2 Select your desired channel group using the **▲/▼** button to display its sub-groups and press the **OK** or **▶** button.
- 3 Select your desired sub-group using the **▲/▼** button and press the **OK** button.
- 4 The channel list for the selected sub-group is displayed.

**Note:** The sub-group of favourite channel list may exist or not depending on your configuration.



## Displaying Information

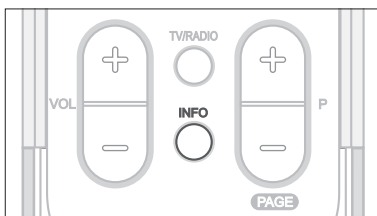

### ▼ General Information



### ▼ Detailed Information

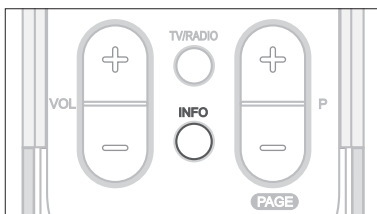
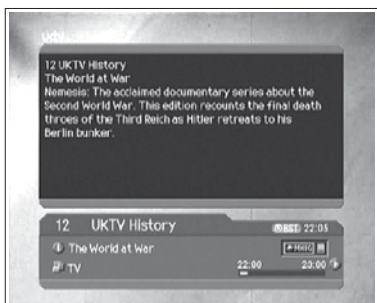

### ■ Programme Information (for digital channels only)

Programme information is always displayed for a specific period of time whenever you switch digital channels. You can view the information by pressing the **INFO** button while watching a digital programme.

*Programme information is available only for digital channels.*

The Programme Information is displayed at the bottom of the screen as followings.



- 1 Channel number and channel name
- 2 Programme name
- 3 Detail programme information: displayed if detailed programme information is provided. Press the **INFO** button again to display the detailed information.
- 4 Channel list name
- 5 Current time
- 6 Icons

	Displayed only if the programme is recording.
	Displayed only if the programme is reserved.
	Represents parental control level. Indicates the minimum level of ages for viewing the programme. <b>-if supplied by the broadcaster.</b>
	Displayed only when the channel is a locked channel.
	Displayed only when the channel is a scrambled channel (Pay TV channel).
	Displayed only when subtitle information is available.
	Displayed only when there is any teletext information.
	Displayed only when the programme is broadcast in the compressed bitstream audio signal.
	Displayed when the channel supports teletext (MHEG).
	Displayed when the channel supports data channel.

- 7 Next programme Information: displayed if next programme information is provided. Press the **▶** button to display the next programme information.
- 8 Programme broadcasting time and progress bar

#### Notes:

1. If there is no available programme information, programme information is not displayed.
2. Press the **INFO** button again to hide the information box.
3. If the detailed programme information is more than one page, use **▲/▼** button to move to the previous or next page.

### Simple Information

You can view the information such as the channel number (or input source), current time and sound mode (or source resolution) by pressing the **INFO** button while watching an analog TV channel or external input source.

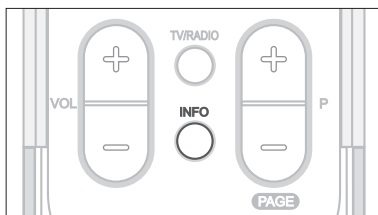

P 11 ----  
10:25  
Stereo

▲ Analog TV Input

AV1  
10:25

▲ External Input  
(AV1/2, S-Video)

Component  
10:25  
720x480p

▲ External Input  
(Component, PC, HDMI)

**Note:** Whenever you switch channels, this information is displayed for 2 seconds.

## Digital Programme Features (for digital channels only)

*These functions are available only for digital channels.*

### ■ Displaying Digital Teletext (MHEG)

If your chosen channel has teletext (MHEG) features, you can access them. Teletext services often load automatically shortly after the Digital Teletext window is displayed. In which case, simply follow the given instructions (press color buttons).

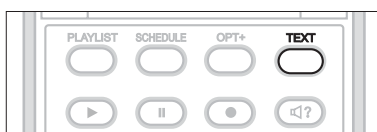

- 1 Press the **TEXT** button to access teletext(MHEG) features.
- 2 Press the **TEXT** button again to return to normal viewing.
- 3 Press the **P+/-** button to exit this service.

---

**Note:** You should select **Off** from the subtitle language to display teletext(MHEG).

---

### ■ Changing Subtitle Language

If the current programme provides Subtitle information, you can select the language for the Subtitle.

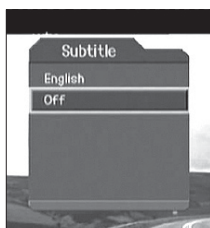
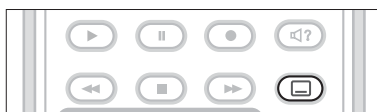

- 1 Press the **SUBTITLE** button to display the subtitle language list.
- 2 Select your desired subtitle language using the **▲/▼** button, and press the **OK** button. Then the subtitle will be displayed in the selected language at the bottom of the screen.
- 3 Select **Off** from the subtitle language list if you do not wish to display subtitles in the screen.

### ■ Changing Audio Options

If the current programme is available in multiple audio languages, you can select the language that you wish to listen in.

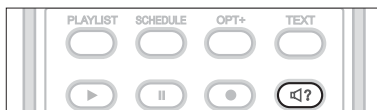

- 1 Press the **SOUNDTRACK** button to display soundtrack list.
- 2 Select your desired audio language using the **▲/▼** and **OK** button to change the audio soundtrack.
- 3 Select Audio preference(left, right, stereo) using the **◀/▶** buttons, and press the **OK** button.
- 4 Press the **EXIT** or **SOUNDTRACK** button to exit the soundtrack list.

## Chapter 5 >> Using the Electronic Programme Guide (EPG)

The Electronic Programme Guide (EPG) displays programme information about each digital channel, based on the date and time. You can also schedule your watching or recording using the information given.

*Electronic Programme Guide (EPG) is available only for digital channels.*

**Note:** Press the **EPG** or **EXIT** button to exit the EPG screen.

### Viewing the Electronic Programme Guide(EPG)

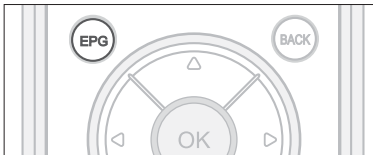

You can view programme information for all digital channels.

- 1 Press the **EPG** button.
- 2 Move to previous or next programme within the same channel using the ◀/▶ button.
- 3 Move to another channel using the ▲/▼ button. If there are multiple channels, use the **P+/- (Page)** button to move to channels by page. Also, you can enter the channel number using the **NUMBER(0-9)** buttons on the remote control to move to the channel directly.
- 4 Select a programme and press the **OK** button. Then you can watch the programme if it is on air.
- 5 Press the **INFO** button in the selected programme to view the detailed information (if available) of the selected programme.



### Viewing by Channel List Groups

You can view programme information of the selected channel list by groups.

- 1 Press the **EPG** button.
- 2 Press the **RED** button to display the channel list group.
- 3 Select a channel list group using the ▲/▼ button.
- 4 Move the cursor to the sub-group using the ▶ button, select a sub-group using the ▲/▼ button and press the **OK** button. The programme guide for the selected channel list is displayed.



### Viewing Using Time Bar

You can quickly search the time zone using the time bar.

- 1 Press the **EPG** button.
- 2 Press the **GREEN** button to display time bar.
- 3 Select the each button using the ◀/▶ button and press the **OK** button to move the time bar. If you press the button repeatedly, the same operation is repeated.
- 4 Each button functions as follows.
  - Now Moves to the current programme where the cursor is located.
  - ◀ Moves back to the previous programme or 30 minutes before.
  - ▶ Moves forwards to the next programme or 30 minutes ahead.
  - ◀◀ Moves back to 2 hours before.
  - ▶▶ Moves forwards to 2 hours ahead.
  - ◀Day Moves back to one day before.
  - Day▶ Moves forwards to one day ahead.
- 5 Select  button and press the **OK** button to exit the time bar.



### Reserving a Programme

You can reserve a watching or recording of the future programmes in the Electronic Programme Guide (EPG).

- 1 Press the **EPG** button.
- 2 Select the desired programme and press the **OK** button to reserve the programme. When a reservation has been completed, the icon (  ) is displayed on the reserved programme. Press the **OK** button again to cancel reservation.
- 3 Press the **YELLOW** button to move to the Schedule screen. The schedule screen displays the reserved programme list and lets you review, edit or delete the reservations.
- 4 By the reserved time, the programme will be recorded (if the hard disk drive is connected) or displayed.

#### Notes:

1. If the channel is locked, restricted by watching time, you will be prompted to enter your password to complete the reservation. The default password is 0000. If you have forgotten your password, please contact your local TV distributor.
2. The recording is available only when the hard disk drive has been connected to the TV.

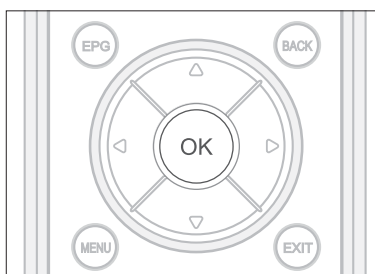

## Viewing Reserved Programme



You can add or edit the reservation using the Schedule screen.

- 1 Press the **EPG** button.
- 2 Press the **YELLOW** button.



**Note:** For more information about how to add or edit a reservation, refer to **Chapter 11. Recording and Playback > Recording Schedule**.

## Finding a Programme

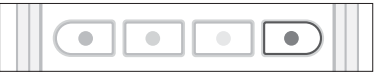

You can sufficiently find the programme you want by programme name or genre.

- 1 Press the **EPG** button.
- 2 Press the **BLUE** button.
- 3 Enter the programme name directly using the keyboard displayed on the screen.
- 4 When entering programme name is complete, select **Find** and press the **OK** button.



**Notes:**

1. Select the letter using the **▲/▼/◀/▶** button and press the **OK** button to enter the programme name on the keyboard screen.
2. If you select **Previous** or **Next** on the keyboard displayed on the screen and press the **OK** button, the keyboard layout is switched.



- 5 Select **By Genre** and press the **OK** button to search programme by genre.
- 6 Select the genre using the **▲/▼/◀/▶** button and press the **OK** button.
- 7 If you select a programme from **Found Programme List** screen and press the **OK** button, you can watch the programme if it is on air. If you want to find another programmes, press the **BACK** button to return to the previous menu.

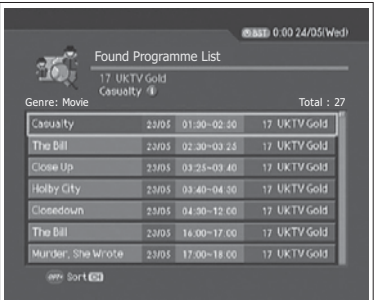

**Notes:**

1. **Found Programme List** may differ depending on the provided programme information.
2. Each time you press the **OPT+** button, the sorting order of the found programmes change in the following sequence: by channel, by descending or ascending time.

## Scanning Analog Channels Automatically

You can automatically scan channels for the frequency ranges available (availability depends on your region).

Analog channels can be scanned only in **Analog TV** input mode. Please make sure the main Input is set to **Analog TV** using the **TV/AV** button.

- 1 Press the **MENU** button.
- 2 Select **Channel** using the **▲/▼** button and press the **OK** or **▶** button.
- 3 Select **Country** using the **▲/▼** button.
- 4 Select the country where you are now located using the **◀/▶** button.
- 5 Select **Auto Search** using the **▲/▼** button and press the **OK** or **▶** button. **Search** is highlighted.
- 6 Press the **OK** button to start to scan channels. It starts to scan channels. The scanned channels are automatically saved in order. To stop scanning channels, press the **BACK** button.
- 7 After the channel scanning completes, press the **BACK** button to exit search. The first scanned channel, if only, will be automatically displayed.



## Scanning Analog Channels Manually

You can save each channel as you identify.

Analog channels can be scanned only in **Analog TV** input mode. Please make sure the main Input is set to **Analog TV** using **TV/AV** button.

- 1 Press the **MENU** button.
- 2 Select **Channel** using the **▲/▼** button and press the **OK** or **▶** button.
- 3 Select **Manual Search** using the **▲/▼** button and press the **OK** or **▶** button. **Colour System** is highlighted.
- 4 Select the required broadcasting standard (**Auto**, **PAL**, or **SECAM**) using the **◀/▶** button.
- 5 Select **Audio System** using the **▲/▼** button.
- 6 Select the required audio system (**BG**, **I**, **DK** or **L**) using the **◀/▶** button.
- 7 Select **Band** using the **▲/▼** button.
- 8 Select the required signal source (**VHF/UHF** or **Cable**) using the **◀/▶** button.
- 9 Select **Channel** using the **▲/▼** button and choose the channel number pressing the **◀/▶** or **NUMBER (0-9)** button.

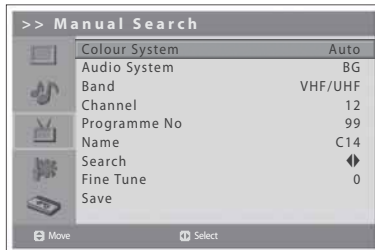

- 10 Select **Programme No** using the ▲/▼ button and select the programme number you would like to assign by pressing the ◀/▶ or **NUMBER (0~9)** button. To change channel names, select **Name** using the ▲/▼ button.
- 11 Enter the new channel name using the ▲/▼/◀/▶ buttons and press the **OK** button.
- 12 Select **Search** using the ▲/▼ button and press the ◀/▶ button to start searching channels.
- 13 Select **Fine Tune** using the ▲/▼ button and press the ◀/▶ button to obtain a good quality of the picture and sound until you reach the optimal setting.
- 14 Select **Save** and press the **OK** button to save.

### **Channel mode display**

- **C (Air channel mode)**: You can select channels by entering the assigned number for broadcasting stations on air in this mode.
- **S (Cable channel mode)**: You can select a channel by entering the assigned number for cable channels in this mode.



## Editing Analog Channels

After channel scanning completes, you can delete, skip, move or add into favorite channel group the saved analog channels.

Analog channels are editable only in **Analog TV** input mode. Please make sure the main input is set to **Analog TV** using **TV/AV** button.

- 1 Press the **MENU** button.
- 2 Select **Channel** using the **▲/▼** button and press the **OK** or **▶** button.
- 3 Select **Edit Channels** using the **▲/▼** button and press the **OK** or **▶** button. The **Edit Channels** menu will appear.



### Deleting Channels

You can delete channels from the list.

- 1 Select a channel you want to delete using the **▲/▼** button and press the **RED** button. The selected channel is deleted.

### Skipping Channels

Once channels are selected to skip, you can select the skipped channels using number buttons only. The **P+/-** buttons will not function for the skipped channels.

- 1 Select a channel to skip using the **▲/▼** button and press the **GREEN** button. (✓) mark appears next to the channel name. To clear the skipped channels, select the channel you don't want to skip and press the **GREEN** button.

### Adding Favourite Channels

You can add favourite channels into the favourite channel group.

- 1 Select a channel to add into the favourite channel group using the **▲/▼** button and press the **YELLOW** button. (F) mark appears next to the channel name. To delete the favourite channels from the group, select a favourite channel you want to delete and press the **YELLOW** button.

If you press the **FAV** button, each favourite channel can be selected in sequent order.

### Moving Channels

You can change the location of channels.

- 1 Select a channel to move the location using the **▲/▼** button and press the **BLUE** button. (M) mark appears next to the channel name.
- 2 Move the selection to a new location using the **▲/▼** button and press the **BLUE** button. The selected channel is moved to its new location and all other channels are shifted accordingly.



# Scanning Digital Channels Automatically



You can automatically scan digital channels for the frequency ranges available (availability depends on your region).

*Digital channels can be scanned only in **Digital TV** input mode. Please make sure the **Main Input** is set to **Digital TV** using the **TV/AV** button.*

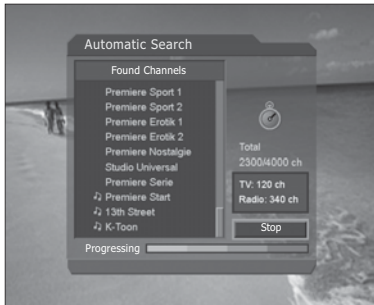

- 1 Press the **MENU** button
- 2 Select **Channel** using the **▲/▼** button and press the **OK** or **▶** button.
- 3 Enter your password by pressing the **NUMBER(0~9)** buttons.
- 4 Select **Country** using the **▲/▼** button.
- 5 Select the country where you are now located using the **◀/▶** button.
- 6 Select **Auto Search** using the **▲/▼** button and press the **OK** or **▶** button. **Search** is highlighted.
- 7 Press the **OK** button to start searching channels. It starts to scan channels. To stop scanning channels, press the **OK** button.
- 8 After the channel scanning completes, select **Save** using the **▲/▼** button and press the **OK** button to save the founded channels.

---

**Note:** The default password is 0000. If you have forgotten your password, please contact your local TV distributor.

---

# Scanning Digital Channels Manually

You can manually select to scan digital channels. The channel numbers are determined by the broadcasting stations.

*Digital channels can be scanned only in **Digital TV** input mode. Please make sure the **Main Input** is set to **Digital TV** using the **TV/AV** button.*

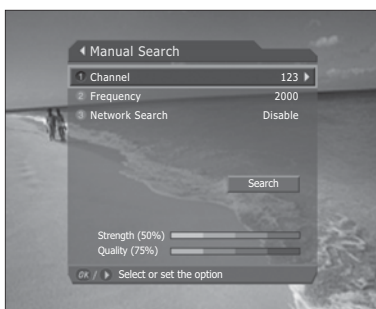

- 1 Press the **MENU** button.
- 2 Select **Channel** using the **▲/▼** button and press the **OK** or **▶** button.
- 3 Enter your password by pressing the **NUMBER(0~9)** buttons.
- 4 Select **Manual Search** using the **▲/▼** button and press the **OK** or **▶** button.
- 5 Select **Channel** using the **▲/▼** button and press the **OK** or **▶** button.
- 6 Select one of channel using the **▲/▼** button and press the **OK** button. When entering the channel number, the appropriate frequency value is automatically displayed in **Frequency**.
- 7 Select **Frequency** using the **▲/▼** button and press the **OK** or **▶** button.
- 8 Enter your desired frequency to search directly using the **NUMBER (0~9)** button and press the **OK** button.  
When entering the frequency, the appropriate channel for the entered frequency is automatically displayed in **Channel**.
- 9 Select **Network Search** using the **▲/▼** button and press the **OK** or **▶** button.
- 10 Select one option between **Enable** and **Disable** using the **OK** or **▶** button. If specified frequency channel information and other channel information are provided together, the channel, which belongs to other frequency channel, is also searched.
- 11 When completed, select **Search** using the **▲/▼** button and press the **OK** button to start searching channels. It starts to scan channels. To stop scanning channels, press the **OK** button.
- 12 After the channel scanning completes, select **Save** using the **▲/▼** button and press the **OK** button to save the founded channels.

---

**Note:** The default password is 0000. If you have forgotten your password, please contact your local TV distributor.

---

### Editing Digital Channels



After channel scanning completes, you can delete, lock, and rename saved digital channels. If there is no LCN channel, the function of move is activated.

*Digital channels can be scanned only in **Digital TV** input mode. Please make sure the **Main Input** is set to **Digital TV** using the **TV/AV** button.*

- 1 Press the **MENU** button.
- 2 Select **Channel** using the **▲/▼** button and press the **OK** or **▶** button.
- 3 Enter your password by pressing the **NUMBER(0~9)** buttons.
- 4 Select **Edit Channels** using the **▲/▼** button and press the **OK** or **▶** button.
- 5 Select **Edit Channels** using the **▲/▼** button and press the **OK** or **▶** button.

**Note:** The default password is 0000. If you have forgotten your password, please contact your local TV distributor.



#### Selecting Channel Group

You can select the channel list group to edit TV or Radio.

- 1 Press the **OK** or **▶** button in **Group** to display channel list group.
- 2 Select your desired channel list group using the **▲/▼** button, and press the **OK** button.

#### Deleting Channels

You can delete one or more channels.

- 1 Select a channel you want to delete using the **▲/▼** button and press the **OK** button. You can select multiple channels.
- 2 Select **Delete** in the right using the **▲/▼/◀/▶** buttons, and press the **OK** button.

### ■ Locking/Unlocking Channels

You can lock or unlock one or more channels.

- 1 Select a channel you want to lock using the ▲/▼ button and press the **OK** button. You can select multiple channels.
- 2 Select **Lock** in the right using the ▲/▼/◀/▶ button, and press the **OK** button. (🔒) mark appears next to the channel name.

To unlock the locked channels, select the channel you want to unlock and select **Unlock** in the right, and press the **OK** button.

---

**Note:** To watch the locked channels, you must enter the password using the **NUMBER (0-9)** buttons.

---

### ■ Selecting/Unselecting All Channels

You can select/unselect all channels at a time.

- 1 Select **Select All** in the right and press the **OK** button to select all channels.
- 2 Select **Unselect All** in the right and press the **OK** button to unselect all the selected channels.

## Editing Favourite Digital Channels



You can add favourite channels or remove favourite channels from the favourite list.

*Digital channels are editable only in **Digital TV** input mode. Please make sure the **Main Input** is set to **Digital TV** using **TV/AV** button.*

- 1 Press the **MENU** button.
- 2 Select **Channel** using the **▲/▼** button and press the **OK** or **▶** button.
- 3 Enter your password by pressing the **NUMBER(0-9)** buttons.
- 4 Select **Edit Channels** using the **▲/▼** button and press the **OK** or **▶** button.
- 5 Select **Edit Fav Chanls** using the **▲/▼** button and press the **OK** or **▶** button.

**Note:** The default password is 0000. If you have forgotten your password, please contact your local TV distributor.



The buttons for editing the Favourite channel list are described in the following table.

	<b>Add</b>	Adds the favourite channel
	<b>Remove</b>	Removes the channel from the favourite channel list
	<b>TV/Radio</b>	Switches between TV and Radio channel list
	<b>Fav.Group</b>	Changes the favourite channel group
	<b>Move</b>	Moves the order of channel list within the favourite channel list
	<b>Rename</b>	Renames the favourite channel group
	<b>Sort</b>	Sorts channels by number or name in all TV/Radio channel list
	<b>Unselect All</b>	Unselect all the selected channels



### Adding/Removing favourite channels

You can add favourite channel(s) to the favourite channel list or remove the added favourite channel(s) from the list.

- 1 Select a favourite group using .
- 2 Select your desired channel(s) in all TV/Radio channel list, and press to add in the favourite channel list.
- 3 Select your desired channel(s) in favourite channel list, and press to remove in the favourite channel list.



### Moving favourite channels

You can move favourite channel(s) to your desired location within the favourite channel list.

- 1 Select a favourite group using .
- 2 Select your desired channel to move within the favourite channel list and press the **OK** button.
- 3 Select , and press the **OK** button.
- 4 Move the cursor to your desired location using the **▲/▼** button, and press the **OK** button.
- 5 The selected channel(s) is moved into the desired location you selected.

### Renaming favourite groups

You can rename the favourite groups.

- 1 Select a favourite group to rename using .
- 2 Select , and press the **OK** button.
- 3 Enter the new group name using **▲/▼◀/▶** button in the keyboard displayed on the screen.
- 4 When finishing entering the name, select **OK** and press the **OK** button.

### Additional Features

Additional Features provides many useful functions which are necessary to add favourite channel.



#### Change between TV and Radio channel list

You can add not only TV channel(s) but also Radio channel(s) to the favourite channel list. Press  to switch all channels into TV or Radio channels.

#### Select a favourite channel group

You can select your desired favourite channel list to edit. Press  to display the favourite group list. Then select your desired group using the **▲/▼** button, and press the **OK** button.

#### Sort a channel list

You can sort all TV or Radio channel lists by channel number or name for easy channel search. If channel lists are sorted by channel number,  is displayed. When you press this button, all the channel lists are sorted by name. Or, if channel lists are sorted by channel name,  is switched into . Press this button to order channels by number.

#### Unselect all the selected channels

Press  button to unselect all the selected channels.

## Selecting a Picture Mode

You can select the picture mode which best fits your viewing requirements.

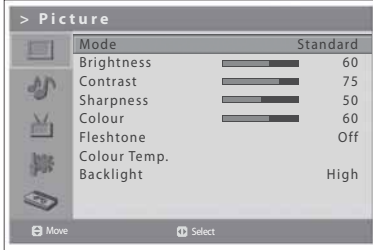

- 1 Press the **MENU** button.
- 2 Select **Picture** using the **▲/▼** button and press the **OK** or **▶** button.
- 3 Select the required picture mode using the **◀/▶** button. The following options are available:

- **Standard**  
Shows the optimal sharpness of the picture if viewed in a well-lighted room.
- **Dynamic**  
Increases the clarity and sharpness of the picture.
- **Movie**  
Select **Movie** to lessen eye strain when watching a movie in a dark place.
- **Mild**  
Softens display with moderate sharpness of the picture.
- **User**  
Select **User** to set detailed options such as Brightness, Contrast, and Colour so on.

**Note:** You can select a picture mode by simply pressing the **PIC MODE** button on the remote control. Press again to switch.



- 4 Press the **EXIT** button to return to Live TV or press the **BACK** button to return to the previous menu.

## Customizing the Picture Settings

You can adjust the picture appearance to suit your preference and viewing situations.

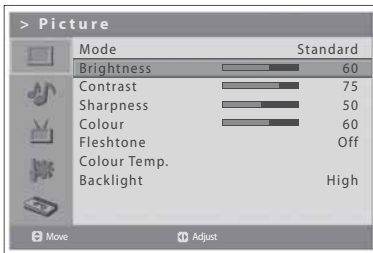

- 1 Press the **MENU** button.
- 2 Select **Picture** using the **▲/▼** button and press the **OK** or **▶** button.
- 3 Select the required option using the **▲/▼** button and press the **◀/▶** button. The following options are available:  
**Brightness > Contrast > Sharpness > Colour**

- 4 Press the **◀/▶** button until you reach the optimal setting. To select other options, repeat the steps from 3 to 4.
- 5 Press **EXIT** button to return to Live TV or press the **BACK** button to return to the previous menu.

**Note:** If you make any changes to the options, the picture mode is automatically switched to **User**. The **Sharpness** and **Colour** are not available in the PC input mode.





## Fleshtone

Use Fleshtone function to improve the picture quality by adjusting colour balance.

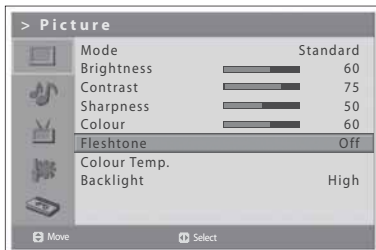

- 1 Press the **MENU** button.
- 2 Select **Picture** using the ▲/▼ button and press the **OK** or ► button.
- 3 Select **Fleshtone** using the ▲/▼ button.
- 4 Select the required fleshtone using the ◀/▶ button. The following options are available.  
**Off > Low > Medium > High**
- 5 Press the **EXIT** button to return to Live TV or press the **BACK** button to return to the previous menu.

## Colour Temperature

You can change the colour of the entire screen to fit your needs. Set to **Warm** for intensifying hot colours such as red, or set to **Cool** for displaying less intense colours with more blue.

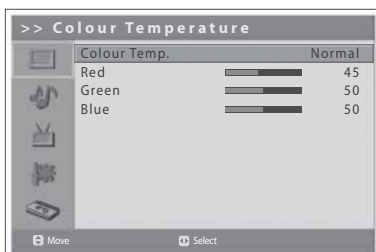

- 1 Press the **MENU** button.
- 2 Select **Picture** using the ▲/▼ button and press the **OK** or ► button.
- 3 Select **Colour Temp.** using the ▲/▼ button and press the **OK** or ► button.
- 4 Select the required colour temperature using the ◀/▶ button. The following options are available:  
**Normal > Cool > User > Warm**

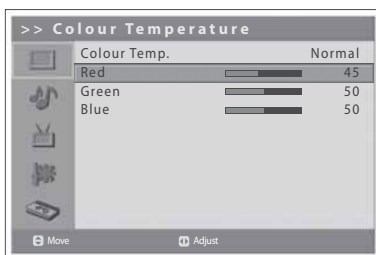

- 5 To customise the colour temperature, select the required option using the ▲/▼ button. The following options are available to make changes:  
**Red > Green > Blue**
- 6 Press the ◀/▶ button until you reach the optimal setting. To select other options, press the ▲/▼ button.

**Note:** If you make any changes to the options, the colour temperature mode is automatically switched to **User**.

- 7 Press the **EXIT** button to return to Live TV or press the **BACK** button to return to the previous menu.

## Adjusting Backlight Brightness

You can adjust the brightness of Liquid Crystal Display (LCD).

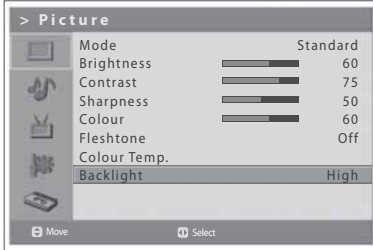

- 1 Press the **MENU** button.
- 2 Select **Picture** using the ▲/▼ button and press the **OK** or ► button.
- 3 Select **Backlight** using the ▲/▼ button.
- 4 Select the required option using the ◀/▶ button.  
The following options are available:  
**High > Low > Medium**
- 5 Press the **EXIT** button to return to Live TV or press the **BACK** button to return to the previous menu.

## Setting the Sound Effect

You can select the type of special sound effect when watching a broadcast.

*Sound Effect lets you enjoy the best sound without any special adjustment because the TV sets the appropriate sound options based on the programme content.*

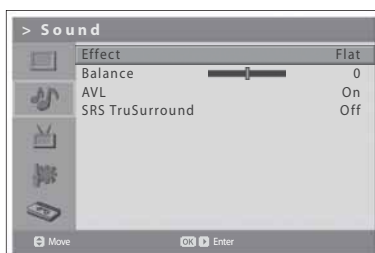

- 1 Press the **MENU** button.
- 2 Select **Sound** using the ▲/▼ button and press the **OK** or ► button.
- 3 Select **Effect** using the ▲/▼ button and press the **OK** button.
- 4 Select the required sound effect using the ▲/▼ button.  
The following options are available:

- **User**  
Customise your own sound effect.
- **Flat**  
Flat and pure sound.
- **Speech**  
Emphasises clear dialogue.
- **Movie**  
Emphasises bass tones.
- **Music**  
Enhances music quality.

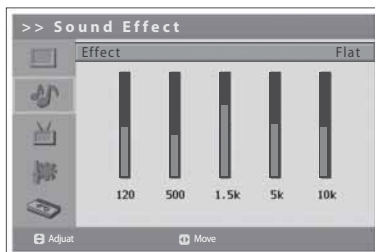

- 5 Press the **EXIT** button to return to Live TV or press the **BACK** button to return to the previous menu.



**Note:** You can select sound effect by simply pressing the **SND EFFECT** button on the remote control. Press again to switch.

## Adjusting the Sound Balance

You can adjust the output of the right and left speakers to obtain the best stereo reproduction for your listening position.

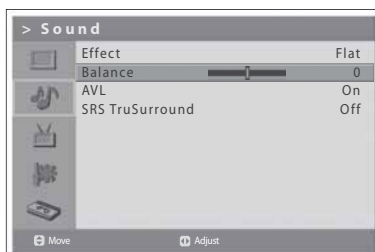

- 1 Press the **MENU** button.
- 2 Select **Sound** using the ▲/▼ button and press the **OK** or ► button.
- 3 Select **Balance** using the ▲/▼ button.
- 4 Press the ◀/▶ button to make changes.
- 5 Press the **EXIT** button to return to Live TV or press the **BACK** button to return to the previous menu.

### Adjusting the Volume Automatically

Each broadcasting station has its own signal conditions, volume may not be adjusted each time you switch channels. This feature lets you automatically adjust the volume of the selected channel by adjusting the sound output depending on the signal modulation.

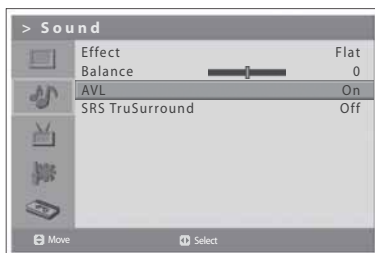

- 1 Press the **MENU** button.
- 2 Select **Sound** using the ▲/▼ button and press the **OK** or ► button.
- 3 Select **AVL(Auto Volume Level)** using the ▲/▼ button.
- 4 Select **On/Off** using the ◀/▶ button.
- 5 Press the **EXIT** button to return to Live TV or press the **BACK** button to return to the previous menu.

### Setting the TruSurround XT

TruSurround XT is a patented SRS technology that solves the problem of playing 5.1 multi-channel content over two speakers. TruSurround delivers a compelling, virtual surround sound effect through two-speaker playback system, including built-in television speakers. It is fully compatible with all multi-channel audio formats.

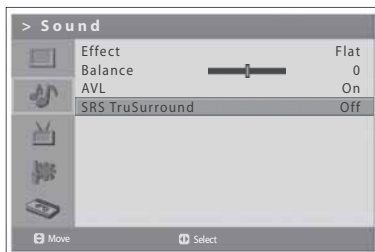

- 1 Press the **MENU** button.
- 2 Select **Sound** using the ▲/▼ button and press the **OK** or ► button.
- 3 Select **SRS TruSurround** using the ▲/▼ button.
- 4 Select **On/Off** using the ◀/▶ button.
- 5 Press the **EXIT** button to return to Live TV or press the **BACK** button to return to the previous menu.

---

**Note:** (SRS TruSurround XT) is a trademark of SRS Labs, Inc. TruSurround XT technology is incorporated under license from SRS Labs, Inc.

---

## Setting the Time Information

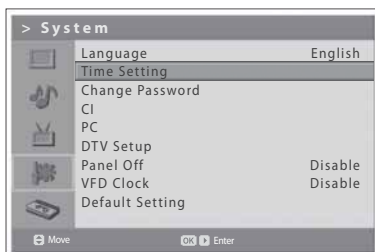

You can set the current time. If you want to set time for automatically turning on/off the power, you must set the local time first.

### Setting the Current Time

- 1 Press the **MENU** button.
- 2 Select **System** using the ▲/▼ button and press the **OK** or ► button.
- 3 Select **Time Setting** using the ▲/▼ button and press the **OK** or ► button.
- 4 Select **Date** using the ▲/▼ button and enter day/month/year using the **NUMBER(0~9)** buttons.
- 5 Select **Local Time** using the ▲/▼ button and enter hour/minute using the **NUMBER(0~9)** buttons.

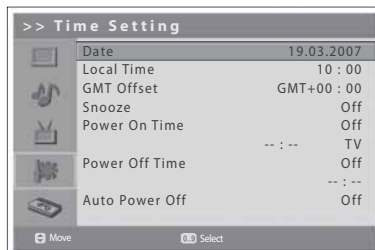

**Note:** Your TV automatically sets and updates the time over the air when you successfully search digital terrestrial channels. Then **Date** and **Local Time** menu will be disabled. You must set the GMT Off set value in **System > Time Setting > GMT Offset** menu.

### Using the TV Timer Function

You can schedule time for automatically turning on/off the power so that your TV will automatically be turned on and off at specific time you have scheduled.

- 6 To set time for turning on the power, select **Power On Time** using the ▲/▼ button and press the ◀/▶ button to select **On**.
- 7 **Power On Time** is enabled, enter hour/minute using the **NUMBER(0~9)** buttons. And select your desired service between **TV** or **Radio** using the ◀/▶ button. At the preset time, the TV will automatically be turned on and display the preset service.
- 8 To switch into the standby mode momentarily when the TV is turned on automatically at the preset time, select **Snooze** using the ▲/▼ button and press the ◀/▶ button to select **On**. Then, within 10 minutes after the TV is turned on automatically at the preset time, if you press the **STANDBY** button, the TV is switched to the standby mode and will be worked again after 5 minutes.
- 9 To set time for turning off the power, select **Power Off Time** using the ▲/▼ button and press the ◀/▶ button to select **On**.
- 10 **Power Off Time** is enabled, enter hour/minute using the **NUMBER(0~9)** buttons.



### Setting the Auto Power Off

In case there is no signal, it is possible have your TV automatically turned off to reduce power consumption.

- 11 Select **Auto Power Off** using the ▲/▼ button and press the ◀/▶ button to select **On**. The TV will automatically be turned off if there is no signal.

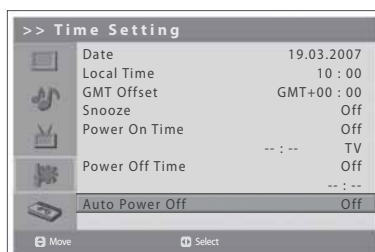

# Changing the Password

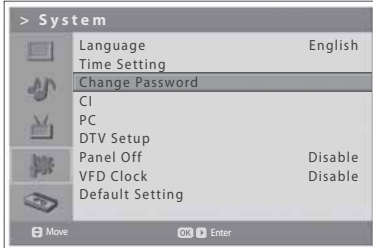

You can change the current password to a new one.

- 1 Press the **MENU** button.
- 2 Select **System** using the **▲/▼** button and press the **OK** or **▶** button.
- 3 Select **Change Password** using the **▲/▼** button and press the **OK** or **▶** button.
- 4 Enter your old password and enter your new password using the **NUMBER (0~9)** buttons.
- 5 Enter the new password again to confirm. Then your new password has been memorized.

**Note:** The default password is 0000. If you have forgotten your password, please contact your local TV distributor.

# Common Interface (for digital channels only)

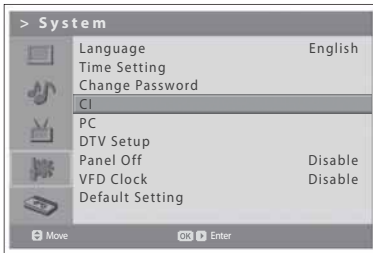

You can view the current status of the CI module. The **CI** sub menu displays when inserting the CI module to the TV.

- 1 Press the **MENU** button.
- 2 Select **System** using the **▲/▼** button and press the **OK** or **▶** button.
- 3 Select **CI**(Common Interface) using the **▲/▼** button and press the **OK** or **▶** button.
- 4 If Common Interface is available, you can view information about each Slot.

**Note:** The displayed information about each Common Interface may differ depending on the type of Common Interface.

# Panel Off

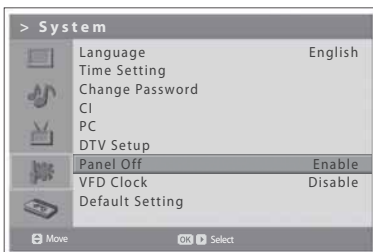

You can set the LCD panel to go out automatically for reduction of power consumption when watching a radio channel.

- 1 Press the **MENU** button.
- 2 Select **System** using the **▲/▼** button and press the **OK** or **▶** button.
- 3 Select **Panel Off** using the **▲/▼** button.
- 4 Select **Enable** using the **◀/▶** button.

The LCD panel will automatically go out if there is no signal for 1 minute when watching a radio channel.

**Note:** When you are watching a radio channel or playing the radio programme/MP3 file, if the **Panel Off** function is **Enable**, the LCD panel goes out and the VFD displays the information such as channel number, channel name, sound effect and volume. You can adjust those displayed on VFD.

# VFD Clock

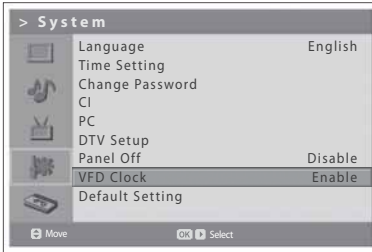

You can set to display the current time on VFD in standby mode.

- 1 Press the **MENU** button.
- 2 Select **System** using the ▲/▼ button and press the **OK** or ► button.
- 3 Select **VFD Clock** using the ▲/▼ button.
- 4 Select **Enable** using the ◀/▶ button.  
In standby mode, the VFD will display the current time.

**Note:** If the Power On Time function is enabled, the clock icon on VFD will be enabled.

# Default Settings

You can set your TV settings to the default setting values.

**Warning:** Please note that once you perform the Default Setting, all data such as aerial setting information, channel list, and user configured data are deleted.

## To perform Default Setting, do as follows:

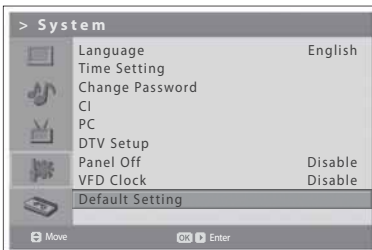

- 1 Press the **MENU** button.
- 2 Select **System** using the ▲/▼ button and press the **OK** or ► button.
- 3 Select **Default Setting** using the ▲/▼ button and press the **OK** or ► button.  
The Enter Your Password dialog box is displayed.
- 4 Enter your password using the **NUMBER(0~9)** buttons to change all settings value to the factory default.
- 5 Default setting is completed.

## Notes :

1. The default password is 0000. If you have forgotten your password, please contact your local TV distributor.
2. After completing the default setting, the initial setup wizard will appear automatically in a few seconds.

In this chapter, you can set the various options for digital channels such as the subtitle language, i-plate display time and software update.

*You can access to the **DTV Setup** menu only in **Digital TV** input mode.*

# Parental Control



- 1 Press the **MENU** button.
- 2 Select **System** using the ▲/▼ button and press the **OK** or ► button.
- 3 Select **DTV Setup** using the ▲/▼ button and press the ► button.
- 4 Select **Parental Ctrl.** using the ▲/▼ button, and press the **OK** or ► button.
- 5 Enter your password by pressing the **NUMBER(0~9)** buttons.

**Note:** The default password is 0000. If you have forgotten your password, please contact your local TV distributor.

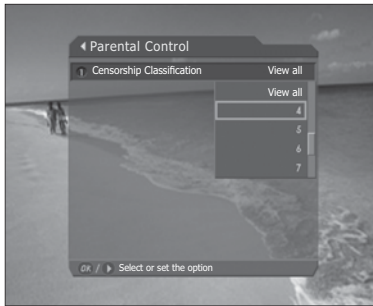

## Censorship Classification

Censorship Classification allows you to block programmes according to the age level you have set.

- 1 Select **Censorship Classification** using the ▲/▼ button and press the **OK** or ► button.
- 2 Select the required age level using the ▲/▼ button and press the **OK** button.

### Notes:

1. You have to enter the password to watch the programme which is blocked by the age level.
2. The default password is 0000. If you have forgotten the password, please contact your local product distributor.



## Language Setting

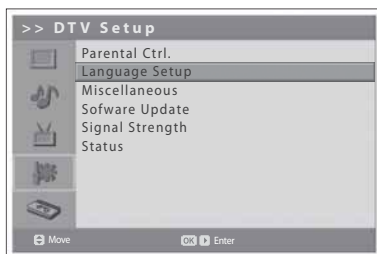

- 1 Press the **MENU** button.
- 2 Select **System** using the ▲/▼ button and press the **OK** or ► button.
- 3 Select **DTV Setup** using the ▲/▼ button and press the ► button.
- 4 Select **Language Setup** using the ▲/▼ button, and press the **OK** or ► button.

### Audio/Subtitle Language

You can set the language for Audio and Subtitle.



- 1 Select one among **Audio Language** or **Subtitle Language** using the ▲/▼ button.
- 2 Press the **OK** or ► button to display the available language list.
- 3 Select your desired language using the ▲/▼ button, and press the **OK** button.

### Subtitle Display

You can select whether or not to display the Subtitle automatically if provided.

- 1 Select **Subtitle Display** using the ▲/▼ button.
- 2 Select your desired option using the **OK** or ► button.
  - Auto** Subtitles are displayed automatically in the predefined subtitle language.
  - Manual** Subtitles are displayed in the language when you select the subtitle language by pressing the **SUBTITLE** button at remote controller.

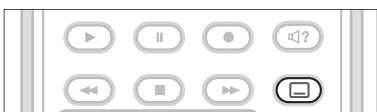

### Subtitle Font

You can select the Subtitle font.

- 1 Select **Subtitle Font** using the ▲/▼ button.
- 2 Select your desired option using the **OK** or ► button.
  - Variable** Uses the horizontally variable Subtitle Font.
  - Fixed** Uses the fixed Subtitle Font.

# Miscellaneous Settings

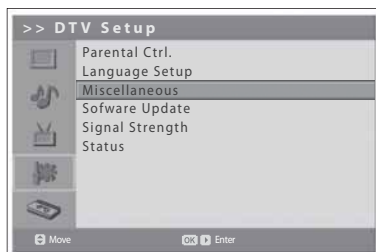

- 1 Press the **MENU** button.
- 2 Select **System** using the **▲/▼** button and press the **OK** or **▶** button.
- 3 Select **DTV Setup** using the **▲/▼** button and press the **▶** button.
- 4 Select **Miscellaneous** using the **▲/▼** button, and press the **OK** or **▶** button.

## i-Plate Display Time

You can set the duration during which the Information box is to be automatically displayed when you switch the channel.

- 1 Select **i-Plate Display Time** using the **▲/▼** button, and press the **OK** or **▶** button.
- 2 Select a value between 1 ~ 20 seconds using the **▲/▼** button, and press the **OK** button.

**Note:** When it is set to **Disable**, the i-Plate will not be displayed when you switch the channel.



## OSD Transparency

You can set the transparency of On Screen Display.

- 1 Select **OSD Transparency** using the **▲/▼** button and press the **OK** or **▶** button.
- 2 Select an option among **Disable**, **25**, **50** and **75** using the **▲/▼** button and press the **OK** button.
  - Disable** Fully opaque screen
  - 25, 50, 75** The bigger the number, the more transparent the screen.

## Option in Channel List

You can set whether or not to display the scrambled icon in channel list.

- 1 Select the **Option in CH List** using the **▲/▼** button.
- 2 Select one option from **On/Off** using the **OK** or **▶** button.
  - On** Scramble icon display in the channel list.
  - Off** Scramble icon disappear in the channel list.

## Instant Replay Time

You can make the current programme go back 7, 15 or 30 seconds.

- 1 Select **Instant replay time** using the **▲/▼** button and press the **OK** or **▶** button.
- 2 Select an option among **7**, **15** and **30** using the **▲/▼** button and press the **OK** button.

### Commercial Skip Time

You can skip 15, 30 or 60 seconds of the unwanted scenes.

- 1 Select **Commercial skip time** using the ▲/▼ button and press the **OK** or ► button.
- 2 Select an option among **15**, **30** and **60** using the ▲/▼ button and press the **OK** button.

## Software Update

In order to maintain proper performance of the TV, it is essential to have the most up-to-date software. The latest news and release of software versions may be found at the **HUMAX website** – <http://www.humaxdigital.com>. It is recommended that you periodically check for the availability of software update.

### OTA (Over the Air)

OTA, an abbreviation of **Over-the-Air**, means that the software can be downloaded through your aerial. The manufacturer reserves the right to decide when and where to release software by this process. The software update via your aerial will only occur under the following circumstances.

- 1 The equipment should have appropriate loader software.  
*Caution: Please note that if you don't have normal loader software, the equipment may not be updated or work after software update.*
- 2 The manufacturer decides to release software downloading via a designated aerial system.
- 3 The equipment must be **tuned** properly according to the guidelines within this manual.
- 4 Update software when the quality of receiving signal strength is high. If the weather is not so good that the quality of receiving signal strength is not recommendable, perform the software update later.

**Caution:**

- Please be careful to keep the power on and the power cord plugged in during software update. If the power is disconnected during software update, it may cause fatal damage to the TV.
- Please be careful not to pull out the signal line (co-axial Cable) during software update. Update may be interrupted and the TV may not work.

---

**Notes:**

1. The other functions of TV cannot work at all during software update.
  2. It may take 5 ~10 minutes to update software.
  3. Scheduling operation cannot work during software update.
-

### If new software is found when powering on

- 1 A message will be displayed to notify that new software is found.
- 2 Select **Yes** and press the **OK** button to update the software.
- 3 Starts downloading new software. Please wait until the updated is completed.
- 4 When completing the software update, the equipment is automatically powered off and on again.

### If updating software from Menu

- 1 Press the **MENU** button.
- 2 Select **System** using the **▲/▼** button and press the **OK** or **▶** button.
- 3 Select **DTV Setup** using the **▲/▼** button and press the **▶** button.
- 4 Select **Software Update** using the **▲/▼** button, and press the **OK** or **▶** button.

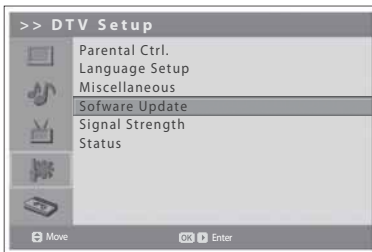

### Automatic Update

You can set the TV to find HUMAX software update site and update software automatically.

- 1 Select **Automatic Update** using the **▲/▼** button, and press the **OK** or **▶** button. Automatically search for new software.
- 2 When detecting update software, the following result is displayed. If new software is not found by **Automatic Update**, use **Manual Update**.
- 3 Select **Yes** and press the **OK** button to start updating. Select **No** and press the **OK** button to return to the previous menu without updating.
- 4 Performs Software Update. Please wait until it is completed.
- 5 When completing the software update, the TV is automatically powered off and on again.

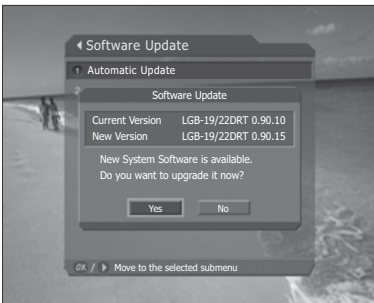

### Manual Update

You can perform Manual Update only if you know MUX information of software update correctly.

- 1 Select **Manual Update** using the ▲/▼ button, and press the **OK** or ► button.
- 2 Select **Channel** using the ▲/▼ button, and press the **OK** or ► button.
- 3 Select the channel number using the ▲/▼ button, and press the **OK** or ► button.
- 4 Select **Frequency** using the ▲/▼ button, and press the **OK** or ► button.
- 5 Enter the frequency using the **NUMBER (0~9)** buttons.
- 6 Select **Search** and press the **OK** button to search software.
- 7 It is displayed whether or not New Software exist. If new software does not exist, press the **OK** button to return to the **Manual Update** menu.
- 8 Select **Yes** and press the **OK** button to start updating. Select **No** and press the **OK** button to return to the previous menu.
- 9 Performs Software Update. Please wait until it is completed.
- 10 When completing the software update, the TV is automatically powered off and on again.

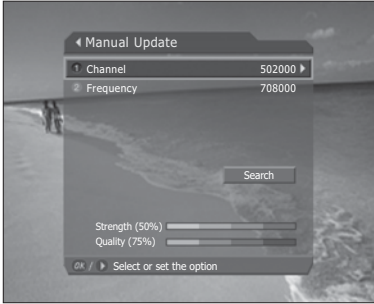

### S/W Update from PC

You can connect your TV to the PC directly and update your software by transferring the new software from the PC. Follow these steps to download new software from PC to this TV.

- 1 Download new software file (HDF files) equivalent for this TV model from our website into your computer (<http://www.humaxdigital.com>).
- 2 Download and install download tool file from our website into your computer.
- 3 Connect your PC to this TV with **RS-232C** serial cable(not supplied).
- 4 Execute installed download tool, and then follow the instructions contained the download tool.
- 5 Reconnect the power cable of the TV and press the **STANDBY** button to make this TV operating.

# Signal Detection

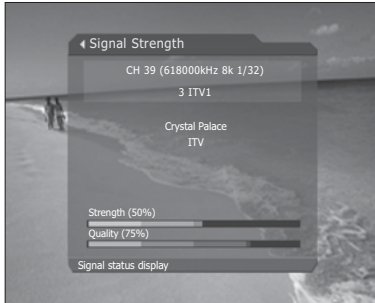

You can view the signal strength and signal quality reception for the channel that is currently being viewed.

- 1 Press the **MENU** button.
- 2 Select **System** using the ▲/▼ button and press the **OK** or ► button.
- 3 Select **DTV Setup** using the ▲/▼ button and press the ► button.
- 4 Select **Signal Strength** using the ▲/▼ button, and press the **OK** or ► button.
- 5 Display information about the aerial and multiplex, which current channel belongs to and the graphs and percentage of Signal Strength and Quality of the channel.

# Status

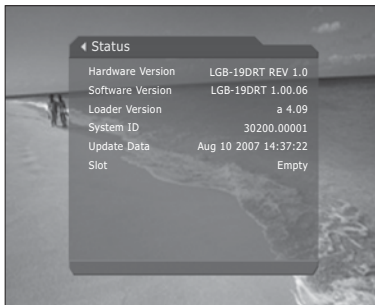

You can view System information.

- 1 Press the **MENU** button.
- 2 Select **System** using the ▲/▼ button and press the **OK** or ► button.
- 3 Select **DTV Setup** using the ▲/▼ button and press the ► button.
- 4 Select **Status** using the ▲/▼ button, and press the **OK** or ► button.
- 5 Confirm the information about **Hardware version**, **Software version**, **Loader version**, **System ID** and **Update Date**.



This chapter describes the PVR (Personal Video Recorder) function that allows you to record a programme in the connected hard disk drive.

**You can access to the Recording menu only in Digital TV input mode (if the hard disk drive is connected to the TV correctly).**

**Note:** You can record the digital TV or radio programmes only. The analog channels and external AV inputs can't be recorded.

## Time Shifted Recording (TSR)

You can perform TSR (Time Shifted Recording) and other functions similar to VCR functions using the playback control buttons while playing a programme.

The TV automatically saves the programme in the connected hard disk drive temporarily, so that users can pause, play, fast rewind, fast forward, replay, etc. even while watching the currently broadcasting TV programme.

### Time Bar



If you press the **PLAY** button while watching TV, the time bar information will be displayed. Time bar displays the current operation status, the time gap between the broadcasting point and watching point and the amount of temporarily saved programme.

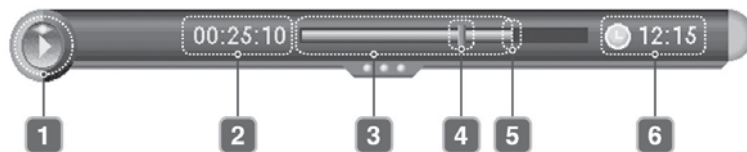

- 1 Operation status
- 2 Watching point time (hh:mm:ss)
- 3 The amount of saved programme
- 4 Watching point
- 5 Broadcasting (Live) point
- 6 Current time (hh:mm)

### Pause



If you press the **PAUSE** button on the remote control, the current programme is paused. If you press the **PAUSE** button once again, the programme is resumed from that point.



**Note:** Pause makes the time gap or delay between the broadcasting (live) point and watching point. The time gap is equivalent to the period the programme was paused. Operations like slow motion and fast rewind also make the time gap. Press the **STOP** button to go to the live programme.

### Fast Rewind to Previous Scene



Press the **FAST REWIND** button on the remote control to watch the scene passed by. Each time you press the **FAST REWIND** button, the rewind speed increases. ( x 2, x 4, x 16, x 32, x 64)



If you press the **PLAY** button, the fast rewind operation stops and the programme is played at normal speed.

**Note:** You can fast rewind back to the start point. If you reach the start point while rewinding, the programme is automatically played at normal speed from that point.

### Fast Forward to the Next Scene



Press the **FAST FORWARD** button on the remote control to fast forward the programme. Each time you press the **FAST FORWARD** button, the speed increases. ( x 2, x 4, x 16, x 32, x 64)



If you press the **PLAY** button, the fast forward operation stops and the programme is played at normal speed.

**Note:** You can use the fast forward operation only when there is a time gap between the current watching point and the broadcasting (live) point caused by some previous operations such as pause, slow motion or fast rewind. You can fast forward to the current broadcasting point. If the watching point reaches the broadcasting (live) point, the programme is automatically played at normal speed.

### Recording



Press the **RECORD** button on the remote control to record the current programme immediately. While the time shift operation records the programme temporarily, this record operation records the programme permanently so you can playback the recorded programme at any time. For more information about recording, refer to **Chapter 11. Recording and Playback > Instant Recording**.

### Adjusting the Recording End Time

Press the **RECORD** button while recording to adjust the recording end time. You can adjust the recording end time by -/+10 minutes using the **◀/▶** button, and then press the **OK** button to change the recording end time and hide the message screen.



### Additional Time Shift Operations

You can perform additional time shift operations using the following buttons on the remote control.

#### Direct Jump

Press the **PLAY** button while watching TV. If you press the **◀/▶** button, a moving arrow will appear in the progress bar. Move this arrow to a time point using the **◀/▶** button to play the programme from the specified time point.

You can also move to the specified time point directly by entering the time you want using the **NUMBER(0-9)** buttons while playing back a recorded programme.

#### Instant Replay

Press the **INSTANT REPLAY** button to go back 7 seconds. When the replay has been completed the programme will play from the current point.

Refer to **Chapter 10. DTV Setup > Miscellaneous Settings**.

#### Instant Skipping 30 seconds

Press the **INSTANT SKIP** button to skip 30 seconds ahead from the current watching point. You can use the skip operation only when there is a time gap between the current watching point and the broadcasting point while using the fast forward operation. If the time gap is less than 30 seconds, the programme is played from the current broadcasting point. Refer to **Chapter 10. DTV Setup > Miscellaneous Settings**.

#### Slow Motion

Press the **SLOW MOTION** button to play the current programme in slow motion. Each time you press the **SLOW MOTION** button, the speed decreases (x 1/2, x 1/4, x 1/8). Press the **PLAY** button to stop playing in slow motion and return to normal speed.

#### Repeat Mode

You can select a specific block within a recorded programme and play it back repeatedly. Press the **A-B** button to set the first repeating position. Select the second position using the **◀/▶** button. Then the programme plays back the selected block repeatedly. To stop the repeat mode, press the **A-B** button while repeating the selected block.

Press the **STOP** button to stop playing the saved programme and watch the current programme on air.



### Bookmark

You can jump to a position directly using the bookmark in recorded programme playback. Use bookmark to search positions quickly and easily.



#### • Adding a bookmark

Press the **ADD BOOKMARK** button at a certain position to set a bookmark while playing back a recorded programme.

**Note:** The bookmark function is only available for recorded programmes.

#### • Deleting a bookmark

Press the **BOOKMARK LIST** button after adding a bookmark and select the bookmarked position using the **▲/▼** button. Press the **ADD BOOKMARK** button to delete a bookmark.

**Note:** Press the **BOOKMARK LIST** or **EXIT** button to exit the bookmark list screen.

#### • Going to a bookmark

Press the **BOOKMARK LIST** button. Select the bookmarked position using the **▲/▼** button and press the **OK** button. Then the programme plays from the bookmarked position.

## Instant Recording



Using the connected hard disk drive, you can record a programme without an external media device such as a VCR.

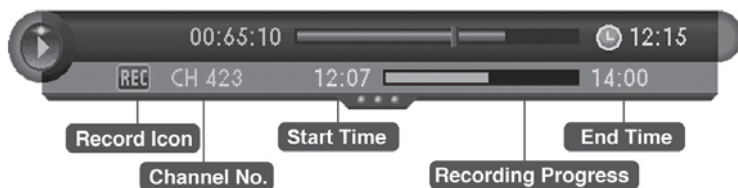

Press the **RECORD** button on the remote control to record the current programme instantly. You can select the point you want to record using the **◀/▶** button. Press the **RECORD** button to start instant recording from that point.

You can change the recording end time while recording. Press the **RECORD** button and change the time using the **◀/▶** button.

If a reserved recording is about to start while recording already, you will be prompted to stop the currently recording channel.

**Notes:**

1. Make sure that the hard disk drive is connected correctly before recording.
2. During recording, the standby indicator on the front of your TV turns on **RED**.
3. Ensure that there is enough free space before recording. If the free space on the connected hard disk drive is insufficient, recording will stop. Recording one hour of programme may require up to 2 or 3GB of hard disk space. The space for recording a 1 hour programme may differ depending on the programme.
4. You can record radio programmes also.

## Recording Schedule



You can set a programme to record automatically.

- 1 Press the **MENU** button.
- 2 Select **Recording** using the **▲/▼** button and press the **OK** or **▶** button.
- 3 Select **Schedule** using the **▲/▼** button and press the **OK** or **▶** button to display the reserved recording list on the screen.

**Note:** You can schedule recording easily using the programme guide. Refer to **Chapter 5. Using the Electronic Programme Guide (EPG) > Reserving a Programme.**



### Selecting/Unselecting Reserved Programmes

- 1 Select a programme and press the **GREEN** button. You can select multiple programmes.
- 2 To unselect the selected programmes, press the **GREEN** button again.

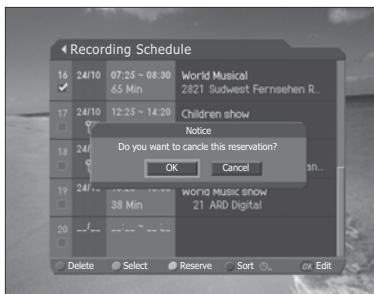

### Deleting Reserved Programmes

- 1 After selecting reserved programmes using the **GREEN** button, press the **RED** button.
- 2 Select **Yes** and press the **OK** button to delete the reserved programmes.



### Adding a Reservation

- 1 Press the **YELLOW** button to add a new reservation.
- 2 Select **Channel** and **Date**. Press the **▶** button to display channel and date lists and select an item using the **▲/▼** button and **OK** button. You can also select a channel using the **NUMBER(0-9)** buttons.
- 3 Select **Start/End Time** using the **▲/▼** button and press the **◀/▶** button to move back 1 minute or move 1 minute ahead. To change the time using the **NUMBER(0-9)** buttons, press the **OK** button.
- 4 Select **Repeat** mode among **ONCE**, **DAILY**, **WEEKLY**, **WEEKDAY (Mon-Fri)** and **WEEKEND** using the **◀/▶** button.
- 5 Select **Lock** mode using the **◀/▶** button.
- 6 Select **Save** and press the **OK** button to save the changes.
- 7 Select **Cancel** and press the **OK** button to cancel the reservation.
- 8 If the channel is locked, you will be prompted to enter the password to complete the reservation.

#### Notes:

1. The recording schedule can't be overlapped with two or more other programmes.
2. The Power On/Off time can overlap the recording schedule.
3. The default password is 0000. If you have forgotten the password, please contact your local product distributor.



### Sorting by Time/Name

Each time you press the **BLUE** button, the sorting order of the reserved programmes change in the following sequence: by descending time, by ascending time, by name.

### Editing a Reserved Programme

- 1 Select a programme you want to edit and press the **OK** button.
- 2 For more information about how to edit the information, refer to **Chapter 11. Recording and Playback > Recording Schedule > Adding a Reservation**.

## Programme Playback in the Play List

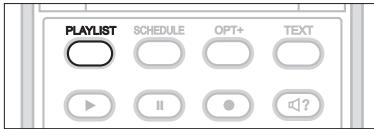

You can playback the recorded programme by pressing the **PLAYLIST** button. You can switch among **VIDEO (TV)**, **AUDIO (radio)** and **Selected Files** list using the ◀/▶ button.



### VIDEO/AUDIO List

- 1 Select **VIDEO/AUDIO** list using the ◀/▶ button.
- 2 If you select programmes using the **GREEN** button, the programmes you select will add to **Selected Files** list automatically.

#### Notes:

1. For more information about **Delete**, **Select**, **Sort** and **Play**, refer to **Chapter 11. Recording and Playback > Programme Playback in the Play List > Selected Files List**.
2. **Move** is inactivated in **VIDEO/AUDIO** list.

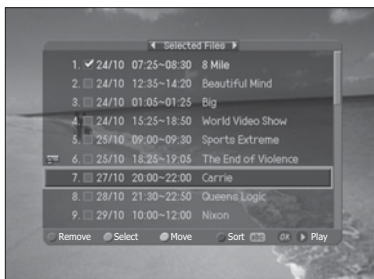

### Selected Files List

- 1 Select **Selected Files** list using the ◀/▶ button.
- 2 Select the programmes and press the **GREEN** button to select the recorded programmes. To unselect the selected programmes, press the **GREEN** button again.
- 3 Select the programmes you want to remove using the **GREEN** button and press the **RED** button to remove the recorded programmes from **Selected Files** list.
- 4 Select the programmes you want to move using the **GREEN** button and press the **YELLOW** button. Move the cursor to the destination using the ▲/▼ button and press the **OK** button.  
A pop-up will appear. Select **Yes** and press the **OK** button.
- 5 Each time you press the **BLUE** button, the sorting order of the recorded programmes change in the following sequence: by descending time, by ascending time, by name.
- 6 Select programmes you want to playback using the **GREEN** button and press the **OK** or **PLAY** button to play the recorded programmes. The programmes will be played in the selected order.

#### Notes:

1. You also can playback the recorded programme in **MENU-Recording-Playlist**.
2. You can playback the programme currently being recorded.
3. The playback icon will be displayed when the programme is being played.
4. The recording icon will be displayed when the programme is being recorded.
5. Certain parts of the programme may blink when playing back a recorded programme in case the recording mode is switched from scramble to descramble or vice versa.

## Chase Play

You can watch the programme from the beginning as the rest of the programme is simultaneously being recorded.

While recording, you can perform TSR (Time Shifted Recording) using the playback control buttons.

**Note:** You can playback the programme being recorded after it has been recorded for at least 30 seconds.

## Editing Recorded Programmes



- 1 Press the **MENU** button.
- 2 Select **Recording** using the ▲/▼ button and press the **OK** or ► button.
- 3 Select **Playlist** using the ▲/▼ button and press the **OK** or ► button. The recorded programme list appears.

### Notes

1. The programme being recorded will be added to the recorded programme list after it has been recorded for at least 30 seconds.
2. Press the **INFO** button to see the detailed information about the programme you have selected if provided.



### Selecting/Unselecting Recorded Programmes

- 1 Select a programme and press the **GREEN** button. You can select multiple programmes.
- 2 To unselect the selected programmes, press the **GREEN** button again.

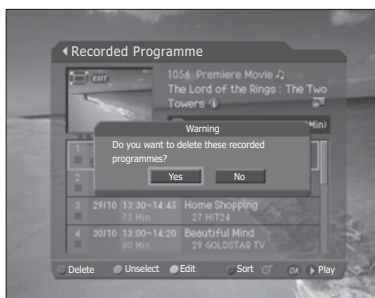

### Deleting Recorded Programmes

- 1 After selecting reserved programmes using the **GREEN** button, press the **RED** button.
- 2 Select **Yes** and press the **OK** button to delete the recorded programmes.

### Notes:

1. If the protect option of the programme is set to **Enable**, you cannot delete the programme. Please refer to **Chapter 11. Recording and Playback > Editing Recorded Programmes > Changing the Attribute**.
2. You can delete multi programmes except for the protected programmes.
3. When not using the **GREEN** button, the file the cursor is located at will be deleted.



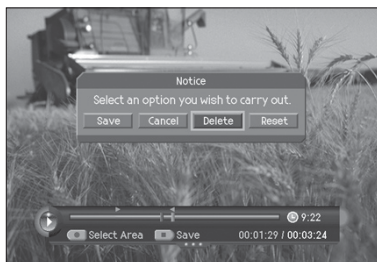
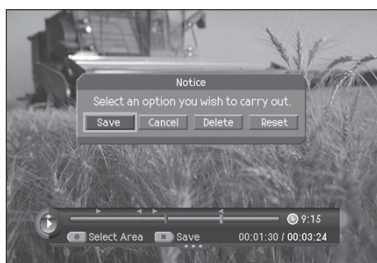
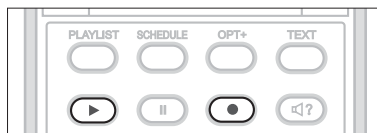
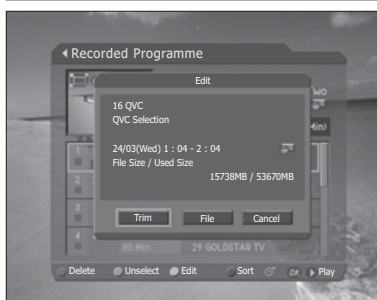

### Trimming the Recorded Programme

- 1 Select a programme and press the **YELLOW** button to trim the recorded programme.
- 2 A pop-up will appear. Select **Trim** and press the **OK** button.
- 3 You can trim the recorded programme using the following functions.

#### Note:

- When selecting multiple programmes, **Trim** is inactivated.
- You can trim recorded TV (Video) channels only.

### Save

You can save the selected recording part as a different file.

Select the starting point using the ◀/▶ button and press the **RECORD** button. Select the ending point using the ◀/▶ button and press the **RECORD** button.

Press the **STOP** button. A pop-up will appear. Select **Save** and press the **OK** button to save the selected part.

Select **Reset** and press the **OK** button to reset the edit.

**Warning:** This function will overwrite the original recording.

### Delete

You can delete the selected recording part.

Select the starting point using the ◀/▶ button and press the **RECORD** button. Select the ending point using the ◀/▶ button and press the **RECORD** button.

Press the **STOP** button. A pop-up will appear. Select **Delete** and press the **OK** button to delete the selected part.

Select **Reset** and press the **OK** button to reset the edit.

#### Notes:

1. You can select several parts simultaneously.
2. After selecting the point you want using the ◀/▶ button, you can view the scene of the point you select by pressing the **OK** button.

### Split

You can split the recorded programme into separate recordings.

Select the point you want to split using the ◀/▶ button and press the **RECORD** button.

Press the **STOP** button. A pop-up will appear.

Select **OK** and press the **OK** button to split the selected point.





## Changing the Attribute

- 1 Select a programme and press the **YELLOW** button to change the attribute of the recorded programme.
- 2 A pop-up will appear. Select **File** and press the **OK** button.
- 3 Select **Programme** in the **File** using the **▲/▼** button and press the **OK** or **▶** button to display a keyboard on the screen. Enter the programme name on the keyboard. Select **OK** and press the **OK** button to complete.
- 4 Select **Protect** in the **File** using the **▲/▼** button and press the **OK** or **▶** button to change **Enable/Disable**. You have to enter a password to change the status from **Enable** to **Disable**.
- 5 Select **Lock** in the **File** using the **▲/▼** button and press the **OK** or **▶** button to change **Enable/Disable**. You have to enter a password to change the status from **Enable** to **Disable**.
- 6 After editing, you have to select **Save** and press the **OK** button to save your changes.

	Displayed when the recording is stopped because of an unexpected error.
	Displayed when the channel is protected from deleting and editing.
	Displayed when the channel is a locked channel.

### Notes:

1. If the protect option of the programme is set to **Enable**, you cannot delete the programme.
2. The default password is 0000. If you have forgotten the password, please contact your local product distributor.
3. If the lock option of a programme is configured to **Enable**, you have to enter a password to playback the programme.



## Sorting by Time/Name

Each time you press the **BLUE** button, the sorting order of the recorded programmes change in the following sequence: by descending time, by ascending time, by name.



## Playing Recorded Programmes

- 1 Select programmes you want to playback and press the **OK** or **PLAY** button.
- 2 The recorded programme will start to play in the video preview window.
- 3 Press the **EXIT** button to playback in the full screen.



# MP3



You can enjoy the music or edit the MP3 list.

- 1 Press the **MENU** button.
- 2 Select **Recording** using the ▲/▼ button and press the **OK** or ► button.
- 3 Select **MP3** using the ▲/▼ button and press the **OK** or ► button. The MP3 list appears.

## Playing MP3

Select the file you wish to playback using the ▲/▼ button and then press the **PLAY** or **OK** button. Press the **STOP** button to stop playing the current file. And press the **PAUSE** button to pause the current file.

**Note:** Please do not put too many MP3 files into a subdirectory. This may let you wait quite a long time until the MP3 file list appears. It is recommended to put no more than 50 files into a subdirectory.

## Downloading MP3 Files

You can enjoy the music on your TV by downloading the MP3 files stored in your computer to the supplied hard disk drive.

### Notes:

1. You can use only up to 5 GB in the hard disk drive for the MP3 files.
2. Do not delete or rename the **MP3** folder in the hard disk drive.
3. Please stop the hard disk drive using the **Safely Remove Hardware** function on windows before disconnecting it from your computer. If not, the files may not be downloaded completely.

# HDD Control



You can check the free space of the connected hard disk drive and format (erase) the disk drive if necessary.

- 1 Press the **MENU** button.
- 2 Select **Recording** using the **▲/▼** button and press the **OK** or **▶** button.
- 3 Select **HDD Control** using the **▲/▼** button and press the **OK** or **▶** button.
- 4 You can check the free, used, reserved and total space of the HDD.
- 5 Select **Format** and press the **OK** button to remove all the recorded programmes saved on the HDD and initialise the HDD.
- 6 Select **Yes** when the format confirmation message appears and enter a password to start formatting the HDD.

---

### Notes:

1. The format deletes all the recorded programmes saved on the HDD including TV, radio and MP3s. Formatting does not delete the system files of the TV.
  2. The default password is 0000. If you have forgotten the password, please contact your local product distributor.
  3. A certain amount of space is reserved for TSR.
- 



## Setting the Aspect Ratio



You can select the modes by simply pressing the **WIDE** button on the remote control.

**Auto > 4:3 > 14:9 > Full > Zoom**

### Notes

1. When the Component or HDMI input mode, you can select only the 4:3, 14:9 or Full.
2. It is not available in the PC input mode.

### Auto

Displays the picture as the original aspect ratio of the signal you received.

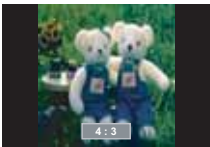

### 4:3

Displays the picture in the 4:3 ratio. The black bar appears on each side.



### 14:9

Displays the picture in the 14:9 ratio. The thin black bar appears on each side.



### Full

Displays the picture in the 15:9 ratio to fill the entire screen.

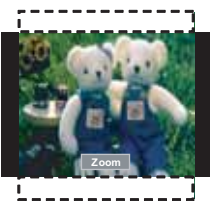

### Zoom

Displays the picture zoomed to fill the 14:9 ratio with black sidebars. The top and bottom of the picture are slightly cropped.

# Displaying Teletext information

You can display teletext information at any time on your TV. Most TV broadcasting stations provide text information services via teletext. The index page of the teletext service gives you information on how to use the service. You can also select various options to fit your needs using the remote control buttons.

---

**Note:** To properly display teletext information, channel reception must be stable. Otherwise, information may be missing or some pages may not be displayed.

---

**TELETEXT** function buttons are as follows:

 **(Teletext On/Off)**

Activates or deactivates the teletext service.

 **(Mix)**

Overlaps the teletext with the broadcasting screen. Adjusts the opacity to the background in Teletext mode.

 **(Index)**

Displays the teletext index page.

 **(Cancel)**

Displays TV programme when waiting for the new teletext page.

 **(Reveal)**

Shows the hidden information. (answers to quiz games, for example) Press it again to return to normal display.

 **(Mode)**

Selects the teletext mode (LIST/FLOF)

 **(Size)**

Displays the double-size letters for lower half of the screen, press it again to return to normal display.

 **(Hold)**

Holds the display on a given page if the selected page is linked with several secondary pages that automatically follow. To resume, press it again.

 **(Time)**

When watching TV programmes, press this button to display the current time at the top right hand corner of the screen.

**Numeric (0~9)**

Press to enter the three-digit page number given in the content.

**Coloured buttons (Red/Green/Yellow/Blue)**

If the FASTEXT system is used by a broadcasting company, the different topics covered on a teletext page are colour-coded and can be selected by pressing the coloured buttons. Press one of them corresponding to your needs. The page is displayed with other coloured information that can be selected in the same way. To display the previous or next page, press the corresponding coloured button.





The **PC** menu is available only when there is a PC input signal.

- 1 Press the **TV/AV** button to switch to **PC** mode.
- 2 Select **PC** using the **▲/▼** button and press the **OK** button.



## Auto Configure

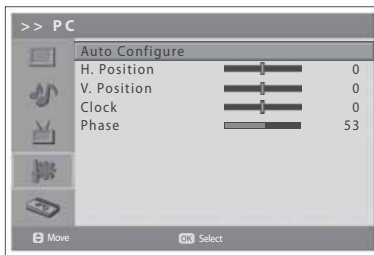

Automatically optimizes the display. This is recommended for the first time connecting to a PC.

- 3 Press the **MENU** button.
- 4 Select **System** using the **▲/▼** button and press the **OK** or **▶** button.
- 5 Select **PC** using the **▲/▼** button and press the **OK** or **▶** button.
- 6 Select **Auto Configure** using the **▲/▼** button and press the **OK** button.

## Position

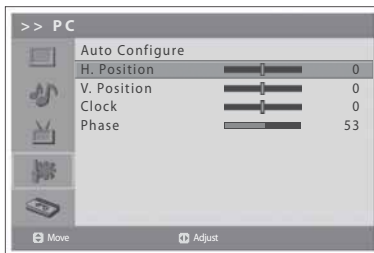

Adjusts the display position to PC if it does not fit the TV screen.

- 6 Select **H. Position/V. Position** using the **▲/▼** button.
- 7 Adjust the optimal position using the **◀/▶** button.

### Clock

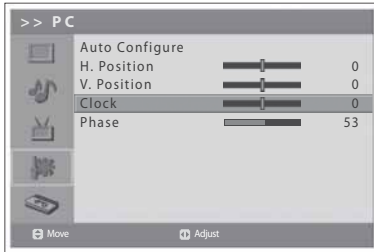

Adjusts the horizontal feature of screen by increasing or decreasing the number of pixels.

- 6 Select **Clock** using the ▲/▼ button.
- 7 Adjust the optimal horizontal feature using the ◀/▶ button.

### Phase

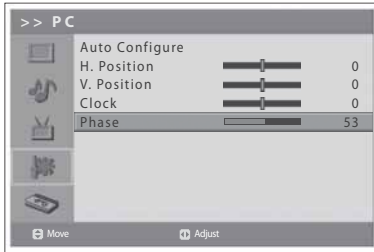

Sets the focus of screen.





- 6 Select **Phase** using the ▲/▼ button.
- 7 Adjust the optimal focus using the ◀/▶ button.

---

**Note:** If noise is present, change the PC mode to another resolution, change the refresh rate to another rate until the picture is clear. If the refresh rate of the PC graphic card can not be changed, change the PC graphic card or consult the manufacturer of the PC graphic card.

---

## Menu Map

	Picture	<ul style="list-style-type: none"> <li>- Mode</li> <li>- Brightness</li> <li>- Contrast</li> <li>- Sharpness</li> <li>- Colour</li> <li>- Fleshtone</li> <li>- Colour Temp.</li> <li>- Backlight</li> </ul>	
	Sound	<ul style="list-style-type: none"> <li>- Effect</li> <li>- Balance</li> <li>- AVL</li> <li>- SRS TruSurround</li> </ul>	
	Channel	<ul style="list-style-type: none"> <li>- Country</li> <li>- Auto Search</li> <li>- Manual Search</li> <li>- Edit Channels</li> </ul>	
	System	<ul style="list-style-type: none"> <li>- Language</li> <li>- Time Setting</li> <li>- Change Password</li> <li>- CI ----- (Digital TV Input only)</li> <li>- PC ----- (PC Input only)</li> <li>- DTV Setup ----- (Digital TV Input only)</li> <li>- Panel Off ----- (Digital TV Input only)</li> <li>- VFD Clock ----- (LGB-19DZT only)</li> <li>- Default Setting</li> </ul>	
	Recording	<ul style="list-style-type: none"> <li>- Schedule</li> <li>- Playlist</li> <li>- MP3</li> <li>- HDD Control</li> </ul>	<p>(Digital TV input only) (HDD connected only)</p>

# Troubleshooting

Before contacting your local service dealer, please make sure you refer to the following guide. If the TV does not work normally after completing the following trouble shooting, please contact your local TV distributor or service centre.

- (1) No message is displayed on the front panel or the TV has no power.
  - Check the main power cable and make sure it is plugged into a suitable power outlet.
  - Check that the mains supply is switched on.
  - Check that the power switch is on at the TV (where applicable)
  - Connect the power cable to a different power outlet.
- (2) No picture
  - Make sure that the TV is power on and in operation mode (press STANDBY button).
  - Make sure that the AV cable is firmly connected to the TV. You may need to remove the cable from both ends and reconnect.
  - Make sure that the antenna line is properly connected to the TV.
  - Check the brightness level of the TV.
  - Check if the channel is currently on air. Contact the broadcaster to ensure that the channel is running.
- (3) Poor picture & sound quality
  - Install the antenna in an obstacle-free place.
  - Make sure there is no mobile phone or microwave oven near the TV.
  - Use 75 coaxial cable when connecting TV and antenna.
  - When the 1080i video input signal is displayed on the TV screen through the Component or HDMI jack, the screen flicker may occur. (LGB-19DRT only)
- (4) No or poor sound
  - Check that your AV cable is connected correctly.
  - Check the volume levels of your TV.
  - Check if the TV is on mute.
  - Check audio type or soundtrack option.
- (5) Remote Control does not operate.
  - To control the TV, the top end of the remote control should point directly towards the receiving part of the TV.
  - Remove and reinsert the batteries in the remote control.
  - Replace the batteries in the remote control for a new set.
- (6) Cannot watch scrambled channel.
  - Check that you have the appropriate Smartcard or CAM. Reinsert the Smartcard or CAM and make sure it initializes correctly.
  - Check in the menu that the TV is detecting the Smartcard or CAM.
  - Check in the menu that you have a valid and working subscription to the channels you wish to view.
  - Ensure that the Smartcard or CAM is not damaged.
- (7) Cannot make reservations.
  - Check that no previous reservations are conflicting with the new reservation.
  - Check that the TV is switched on at the time of the reservation.
- (8) No password information is given.
  - The default password is always 0000.
- (9) Channel search does not work.
  - Check that your antenna is connected correctly.
- (10) Cannot update new software.
  - You can get an update. If the TV does not show a message requesting update, that means no software is available.
- (11) Cannot watch pay channels.
  - Check in the menu that you have a valid and working subscription to the channels you wish to view.
  - Contact your network operator for more information.



- (12) Cannot record programmes.
- Make sure that the HDD is connected correctly.
  - The hard disk is full. Delete unnecessary programmes and make space for new recording.
  - Check if recording is overlapped with another channel. Stop the current recording or wait until the recording is finished.
- (13) Cannot operate the TSR (Time Shifted Recording)
- Make sure that the HDD is connected correctly.
  - The TSR may not be available during the recording. Wait until the recording is finished.
  - Delete unnecessary programmes and make space for new recording.
- (14) Cannot playback.
- Make sure that the HDD is connected correctly.
  - The signal during the recording may be weak or the hard disk too full.
- (15) Cannot change channel while recording.
- Certain channels may not be changed due to restriction of the tuner type.

## Error Message

Error message	Possible causes	What to do
No signal	<ul style="list-style-type: none"> <li>- The aerial is not pointing properly.</li> <li>- The AV device is not connected properly.</li> </ul>	<ul style="list-style-type: none"> <li>- Adjust aerial.</li> <li>- Check the cable from the aerial. If you cannot resolve the problem you may need to have your aerial and installation tested by a professional.</li> <li>- Set the AV device correctly.</li> <li>- Check the cable from the AV device.</li> </ul>
Will not accept	<ul style="list-style-type: none"> <li>- The key(button) is not supported for this product.</li> </ul>	
Invalid Mode	<ul style="list-style-type: none"> <li>- The resolution of connected PC is not set properly.</li> </ul>	<ul style="list-style-type: none"> <li>- Check the optimal resolution settings. You may need to download a new video driver.</li> </ul>
No Subtitle Data	<ul style="list-style-type: none"> <li>- The channel has not the subtitle data.</li> </ul>	<ul style="list-style-type: none"> <li>- Confirm if the channel is provided the subtitle data.</li> </ul>
The channel is scrambled or not available.	<ul style="list-style-type: none"> <li>- The channel has signal, but no audio or video.</li> <li>- The channel is deleted by the broadcasting company.</li> <li>- The channel is for data broadcasting. (Cannot watch the channel in usual way.)</li> </ul>	<ul style="list-style-type: none"> <li>- Confirm if the channel is currently on air.</li> </ul>
The channel is scrambled.	<ul style="list-style-type: none"> <li>- This digital terrestrial receiver does not support the service that enables to descramble the scrambled channels.</li> </ul>	
The audio is not available.	<ul style="list-style-type: none"> <li>- The channel has a video signal, but no audio is provided.</li> </ul>	<ul style="list-style-type: none"> <li>- Press the audio buttons on your remote control to confirm that the channel has audio options.</li> </ul>
CI-Module is not installed. / Invalid CI-Module	<ul style="list-style-type: none"> <li>- CI-Module is not installed.</li> <li>- CI-Module is not properly inserted.</li> <li>- CI-Module is broken.</li> </ul>	<ul style="list-style-type: none"> <li>- Install proper CI-Module.</li> <li>- Pull out the CI-Module and plug it in.</li> <li>- Replace CI-Module.</li> </ul>

## Specification

Item		Specification	
LCD Panel	Type	Colour active matrix TFT-LCD	
	Display Area	19.0"/22.0"	
	Max. Resolution	LGB-19DRT : 1440 x 900 pixels LGB-22DRT : 1680 x 1050 pixels	
	Viewing Angle	R/L : 160, U/D : 160 (CR ≥10)	
PC Monitor	Sync	Separate	
	Horizontal Frequency	31.469~48.363kHz	
	Vertical Frequency	60Hz	
	MAX. Resolution	1360 x 768 pixels@60Hz	
Input/Output	Video Input	Analog + Digital Tuner(1), SCART, RCA, S-Video, Component, HDMI, PC	
	Audio Input	RCA(R/L), Component (R/L), HDMI, PC Audio	
	Audio Output	Speaker, Headphone	
	Data Interface	RS-232C(for SW update), USB (for PVR)	
TV Signal		<b>Analog</b>	<b>Digital</b>
	Area	EU	EU(MHEG)
	Antenna Input	IEC 169-2 Female	IEC 169-2 Female
	Tuning System	FS	OFDM DVB-T
	Colour System	PAL, B/G, D/K, I SECAM, B/G, D/K	B/G, I, D/K
	Sound System	AM / FM / Nicam	MPEG 1 Layer 1/2
	VHF Low	48.25 ~ 144.00 MHz	48.25 ~ 144.00 MHz
	VHF High	145.00 ~ 424.00 MHz	145.00 ~ 424.00 MHz
	UHF	425.00 ~ 863.25 MHz	425.00 ~ 863.25 MHz
Teletext	Yes	Yes	
Regulation	Safety	CE	
	EMI	CE	
Others	Power	LGB-19DRT : 65W (Max.) LGB-22DRT : 68W (Max.)	
	Speaker Output	8W x 2EA	
	Plug & Play Level	DDC 1/2 B	
	Weight	LGB-19DRT : NET 7.0 kg / Gross 9.6 kg LGB-22DRT : NET 8.1 kg / Gross 10.6 kg	
	Power Supply	AC 100V ~240V, 50/60 Hz	
	HDD	80GB	
	Operating Temperature	5°C ~ 35°C	
	Operating Humidity	30 ~ 80% RH	

# Service and Support

You can get information such as a troubleshooting guide, software upgrades and product support guide from the following web sites and call center (Hotline). Please try to contact to your local dealers first when facing a problem.

### Web site and e-mail

#### Homepage

<http://www.humaxdigital.com>

English

<http://www.humaxdigital.com/Deutsch/>

Deutsch

<http://www.humaxarabia.com>

Arabic

#### HCSA (Humax Customer Service Area)

[Software Download, Information and Technical Q&A](#)

<http://www.humaxdigital.com/hcsa/>

English

<http://www.humaxdigital.com/Deutsch/hcsa/>

Deutsch

#### E-mail (Technical Q&A)

[tech-info@humax-digital.co.uk](mailto:tech-info@humax-digital.co.uk)

Europe & North Africa

[techinfo@humax-digital.de](mailto:techinfo@humax-digital.de)

Germany

[callcenterME@humaxdigital.com](mailto:callcenterME@humaxdigital.com)

Middle East

[Webmaster@humaxdigital.com](mailto:Webmaster@humaxdigital.com)

Asia & Other area

### Call Center

#### Humax Customer Helpline (UK)

**Tel:** 0870 247 8800

**E-mail:** [uksupport@humax-digital.co.uk](mailto:uksupport@humax-digital.co.uk)

**Open:** Local Time in UK (GMT+0), 09:00 – 18:00 (Monday -Friday)

**Support Language:** English

#### Humax Middle East Call Center (Dubai, UAE)

**Tel:** +971 (0)4 359 2323 (Open: 09:00 - 20:00 / close on Friday)

**E-mail:** [callcenterME@humaxdigital.com](mailto:callcenterME@humaxdigital.com)

**Open:** Local Time in Dubai (GMT+4), 09:00 - 20:00 (Saturday - Thursday, close on Friday)

**Support Language:** English/Arabic

#### Humax Hotline (Germany)

**Germany:** 01805 778 900 ( € 0,12/Min)

**Other Countries:** + 49 1805 778 870 ( € 0,12/Min+ International Call Charge)

**E-mail:** [support@humax-digital.de](mailto:support@humax-digital.de)

**Open:** Local Time in Germany (GMT+1), 08:00 - 23:00 (Monday - Sunday)

**Support Language:** Deutsch/English

#### HUMAX Hotline (Italy)

**Tel :** 899 100080

**E-mail :** [info@mediasat.com](mailto:info@mediasat.com)

**Open :** Local Time in Italy (GMT+1), 08:00~18:00 (Monday - Friday)

**Support Language :** Italian

#### HUMAX Hotline (Austria)

**Tel :** 0820 400675 ( € 0,12/min.)

#### HUMAX Hotline (Sweden)

**Tel :** +46 (0)550 85527

**Open :** 08:00 ~ 16:30 (Monday - Friday)

**Support Language :** Swedish/English

#### HUMAX Hotline (Finland)

**Tel :** 09 5618 6366

**Open :** 08:00 ~ 16:00 (Monday - Friday)

**Support Language :** Finnish/English

*For hardware repair, please refer to website. (Homepage or HCSA)*